

**AUDIOVOX**<sup>®</sup>  
DRIVEN BY DICE ELECTRONICS



**MEDIA BRIDGE**  
MULTIMEDIA INTEGRATION KIT

for select BMW and Mini Cooper vehicles

**Installation Guide/User manual**

Made for



iPod



iPhone

### Copyrights and Trademarks

Copyright 2012 Audiovox Electronics Corporation

The Audiovox and Audiovox Driven by DICE Electronics logos are trademarks of Audiovox Electronics Corporation

iPod and iPhone are trademarks of Apple, Inc.

All Trademarks and Logos are the property of their respective owners.

All rights reserved.

Printed in the U.S.A.

## Table of Contents

Warning and safety .....	4	Controlling the MediaBridge iPod source .....	23
Product registration .....	5	Controlling the MediaBridge USB memory source .....	24
MediaBridge kit content .....	6	Controlling the MediaBridge SIRIUS source .....	25
DIP switch overview .....	7	Bluetooth & MAT configuration .....	26
DIP switch settings for BMW/Mini .....	8	Pairing MediaBridge with cell phone via BT .....	26
Supported iPod models .....	9	Answering / Making a phone call .....	26
Note to Installer .....	10	Playing music through MediaBridge via BT .....	27
Connection diagram .....	11	Accessing the auxiliary input .....	28
Connection diagram for DSP option .....	12	Internet Radio application support .....	29
Factory CD changer cable locations .....	13	Data connection requirements .....	29
Installation .....	14	Controlling Internet Radio Apps .....	30
iPod content browsing .....	17	Text display from the Internet Radio App .....	31
Charging .....	17	Terminating the Internet Radio App .....	32
iPod locked/unlocked settings and features .....	18	Firmware update .....	33
Basic operation .....	19	Troubleshooting .....	34
Operating the MediaBridge unit from select radios .....	20	Warranty .....	37

## Warning and safety!

Please read these instructions carefully before proceeding. Failure to follow instructions may result in improper operation or injury. Neither Audiovox Electronics Corporation nor Apple Inc., its regional offices, distributors or resellers take any responsibility for any damage or injury as a result of using the integration kit.

- Do not open, disassemble or alter the interface in any way.
- Do not insert anything into the casing.
- Do not cut or try to alter cables in any way and always use the correct connections.
- Only operate unit when stationary or ask passengers to operate it for you.
- Do not allow the Apple iPod/iPhone to distract you from driving.
- Exercise good judgement and keep your eyes on the road at all times.
- Do not expose unit to extreme temperatures, humidity or shock.
- Keep the unit and iPod/iPhone away from fluids.
- Keep away from children! - Interface components may contain small parts, can be broken or disassembled and components may become loose from vibration and heat. Small components and packaging materials may be a choking hazard when handled by children.



## **Congratulations on your purchase!**

Thank you for purchasing this integration kit. Please review this booklet before operating the unit. This interface was designed and manufactured to seamlessly integrate with your vehicle's factory audio system.

## **Product registration**

We recommend registering your Audiovox product so you can receive news about important firmware updates and have unlimited access to our online support system.

### **To register your Audiovox product, please complete the following steps:**

1. Visit <http://www.audiovoxproducts.com>
2. Look up and save the serial number of the product.
3. Complete the product registration form.
4. Submit the form.
5. Save the registration sheet in a safe place for future reference.

If you are unable to complete the registration via internet, please call Audiovox at 1-800-645-4994.



Prior to installation make sure the module's firmware is up to date to ensure compatibility with the latest features and enhancements. Please refer to page 33 to update firmware.

## MediaBridge kit content



MediaBridge module



User manual



MediaBridge connector

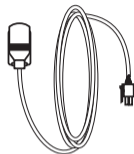

Microphone



USB extension

### Optional accessories (sold separately):

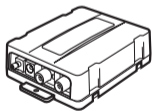

DSP kit  
(A-ACC-BMW-DSP)



BMW SAT cable

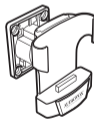

Cradle  
(A-DCR-150-USB)

For more accessories, visit [www.audiovoxproducts.com](http://www.audiovoxproducts.com)

## DIP switches overview



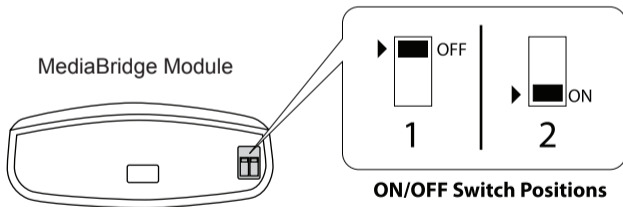

The configuration switches located on the MediaBridge module are used to set various operation modes of the interface. Incorrect DIP switch settings may cause the interface to not work properly or to not operate at all.

**Disconnect the vehicle harness from the module and set the ignition to the off position for 60 seconds after changing the switches then reconnect the module!**



## DIP switch settings for BMW/Mini

The following DIP switch settings are used to configure the MediaBridge module to interface with the various vehicle radios. Before installation, set the DIP switches to the position shown for the corresponding radios.

Car configuration switches			
<b>BMW Business CD Radio</b>	<b>BMW &amp; MINI 16:9 Navigation Radio</b>	<b>BMW 4:3 Navigation Radio</b>	<b>BMW MID Radio</b>
			
For single line (Non- Navigation) radios in Mini, 3-Series, Z3, Z4, and X3 models.	For 16:9 (wide screen) Navigation radio system in BMW and Mini.	For 4:3 (small screen) Navigation radio system in BMW.	For single line (Non- Navigation) radios in 5-Series, 7-Series, and X5 models.

Radio specific text field configuration should be performed during installation. Please refer to interface setting (DISC 5) section on page 19.



## Supported iPod models and firmware version requirements

Model	Firmware / OS Version
1G nano	1.3.1
iPod 5G	1.3
2G nano	1.1.3
iPod classic	1.1.2
3G nano	1.1.3
iPod touch	iOS 3.1.3
iPhone	iOS 3.1.3
iPhone 3G	iOS 4.2.1
4G nano	1.0.4
120 GB classic	2.0.1
2G touch	iOS 4.2.1
iPhone 3GS	iOS 5

Model	Firmware / OS Version
160 GB classic	2.0.4
5G nano	1.0.2
3G touch	iOS 5
iPhone 4	iOS 5
iPhone 4S	iOS 5
4G touch	iOS 5
6G nano	1.2

## **Attention Installer! Please read the following!**

**Audiovox Electronics strongly recommends that the unit be installed in an easily accessible place!**  
**DO NOT PLACE IT BEHIND THE RADIO AND DO NOT HIDE UNDER CARPET!**

Whether the unit is professionally or self installed, put the module where you, the end user can get to it easily in the future. (Have the installer show you where the interface module is installed.)

Installing the module behind the radio will make it difficult to:

- Add possible future upgrades, changing software, adding new features, improving operation;
- Access the AUX input on the module to attach any audio device;
- Access the DIP switches located on the module;
- Remove the unit in case of failure.

**MAKE SURE THAT THE MODULE IS IN AN ACCESSIBLE PLACE!**

## Connection diagram

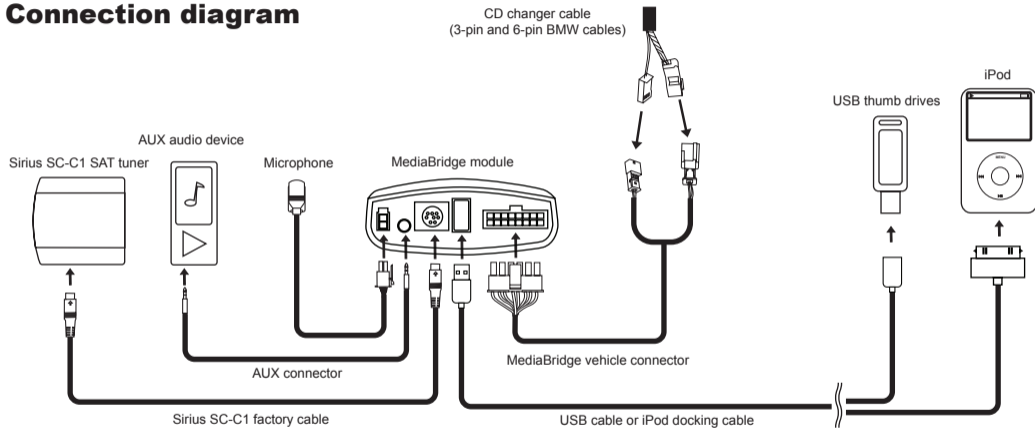

Do not connect an iPod dock cable under any circumstance to the SIRIUS module connector! Improper connection can cause permanent damage to iPod/SIRIUS module.

## Connection diagram for DSP option

BMW vehicles with Digital Signal Processing (DSP) amplifiers must use the DSP Kit (PN: A-ACC-BMW-DSP). To confirm if the vehicle has DSP, check for a bare metal coax cable and a 3-pin connector (for connector locations see page 13). This DSP was only an option on **some BMW 5-Series, 7-Series, X5, Z4 and X3 vehicles.**

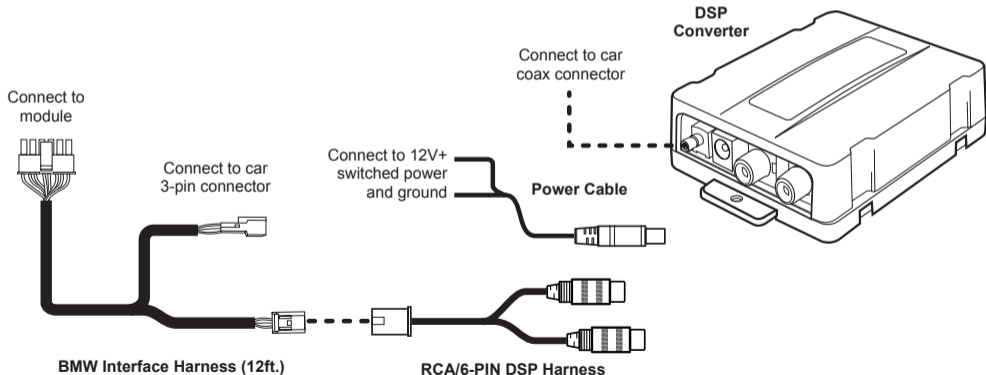

## Factory pre-wired CD changer cable locations

○ DSP Amp

✕ 3-pin/6-pin (or coax) connector location

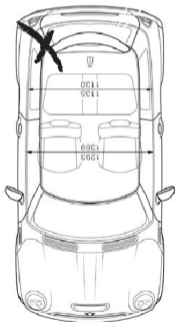

Mini

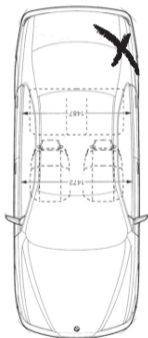

3-Series and Z3

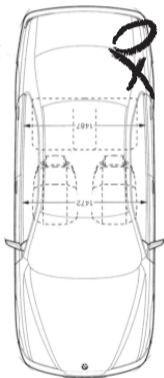

5-Series, 7-Series and X5



Z4

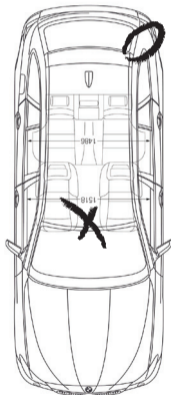

X3

## Installation

**Note:** Installation should only be performed by a qualified professional. Beware of sharp edges to avoid injury and exercise caution when removing trim pieces as they may break. The module should be placed in an accessible location, such as the glove box, consoles, under the front seats or in some cases in the trunk to allow iPod/SIRIUS/AUX cables to be connected. The module firmware may need to be updated periodically and must be removed from the vehicle and connected to a computer to apply the update.

1. Disconnect both battery terminals. These cables must be disconnected during installation to ensure proper initialization of the module when it is connected. **This step is REQUIRED for proper operation of the module!**
2. Access the CD changer cable. The location of this cable varies by BMW model (for connector locations see page 13).
3. **If the vehicle you are performing the installation on has DSP, refer to page 12 and then proceed to step 5.** Locate both the 3-pin & 6-pin connectors. If the vehicle has a factory CD changer installed, the 3-pin & 6-pin cables will be connected to it and will need to be disconnected. If there is not a CD changer installed the cables will be bundled and may be tucked away behind carpeting.



Some vehicles will have the CD changer wiring in a protective sheath which may make it more difficult to locate. **Non-US models** may not be pre-wired for a CD changer, and require an additional harness from BMW to be connected.

4. Connect both 3-pin and 6-pin cables to the BMW Interface Harness.



**ATTENTION!** There are two 3-pin connectors presented in the vehicle. During installation, make sure that the 3-pin connector from the vehicle **DOES NOT** have a brown wire in the middle! The 3-pin connector of the phone pre-wiring looks identical to the 3-pin connector of the CD changer pre-wiring. Locate and use the correct 3-pin cable with the brown wire on the outside! Incorrect connection will result in permanent damage to the unit and will not be covered by warranty!

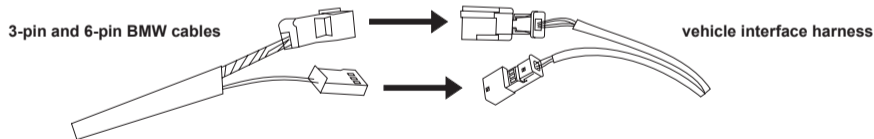

Note that in the X3 there may be two 6-pin audio connectors present. Connect the harness to the one **without** the “CD” label.

5. Route the interface cable to the front of the vehicle. Fold down rear seats (if applicable) and route the extension cable through the rear seat bottom cushion. Route the remainder of the interface cable (*ie.* under the door sill or under the driver's seat) to a location where the module can be easily accessed in the future.
6. Make sure you have set the DIP switches on the MediaBridge as specified on page 8.
7. Connect the BMW interface cable, iPod Dock Cable and SIRIUS Connections (if applicable) to the MediaBridge module and double-check all connections. See page 11 (and page 12 if the vehicle has DSP) for the connection diagram.
8. Test the installation.
9. Replace any trim, carpeting or panels that were removed during installation.



## iPod content browsing

By default, the interface creates a Playlist having a name that is the same as the name of the iPod. This Playlist is the very first on the list of Playlists shown while browsing in Playlist mode. This Playlist contains all the songs on the iPod. Once a Playlist is selected an Artist may be selected within that Playlist using the Artist Mode. Albums by the selected Artist within the selected Playlist may be selected in Album Mode. "ALL ARTIST" and "ALL ALBUM" designate all available content in those categories.



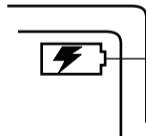

## Charging

The interface automatically charges the battery of the iPod when connected and your vehicle ignition key is in the ACC/ON position.

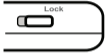

Charging may be shown by an icon that appears on the upper right corner of the iPod screen. May vary by model.

## iPod locked/unlocked Settings and Features

	iPod hold ON	iPod hold OFF
		
Radio control	✓	Limited
iPod control	✗	✓
	Before connecting the iPod to the MediaBridge module, turn the hold switch <b>ON</b> to fully control and browse the songs from the radio. The iPod is locked in this state.	Before connecting the iPod to the MediaBridge module, turn the hold switch <b>OFF</b> to fully control and browse the songs from iPod. Browsing capabilities are limited from the radio.

**Note:** Setting the iPod's hold switch must be done prior to connecting it to the dock cable.  
 iPod nano 6th generation will always be in locked mode since it does not have a lock switch.



For iPod touch and iPhone, when the screen is not active (as shown on the left), the iPod/iPhone is locked (Press the power button to lock the iPhone/iPod Touch).

## Basic Operation

### Accessing MediaBridge as the audio source:

Much like the radio's AM/FM tuner, satellite radio or CD audio sources, the MediaBridge is integrated to be part of the vehicle's audio system. To access the MediaBridge source, press the MODE or CD button on the radio. Pressing this button repeatedly will cycle through sources present in the vehicle (CD > MediaBridge).

### MediaBridge source selection:

The MediaBridge adds additional audio sources including iPod, SIRIUS Satellite Radio\* and auxiliary audio input. To cycle between these sources, use the next/previous TRACK buttons within the first 5 seconds of accessing the MediaBridge as the audio source while in DISC 1.

*\*This source require additional parts/accessories/service from Audiovox and/or third parties.*

### MediaBridge Interface settings (within first 5 seconds of accessing the MediaBridge as the audio source):

**Select DISC 1** to apply settings and resume audio playback.

**Select DISC 3** to change default volume level; use track up/down to adjust between Min and Max.

**Select DISC 4** to enable/disable scrolling text.

**Select DISC 5** to choose between single line display and multiline display modes (multiline display mode only available on 16:9 Navigation radio).

**Select DISC 6** to view MediaBridge serial number and firmware version.

DISC 2 has no settings available.

## Operating the MediaBridge from select BMW and Mini radios

NOTE: 99-01 3-Series and Z3 will require double clicking buttons when text is displayed.

Illustration showing BMW Business CD Radio

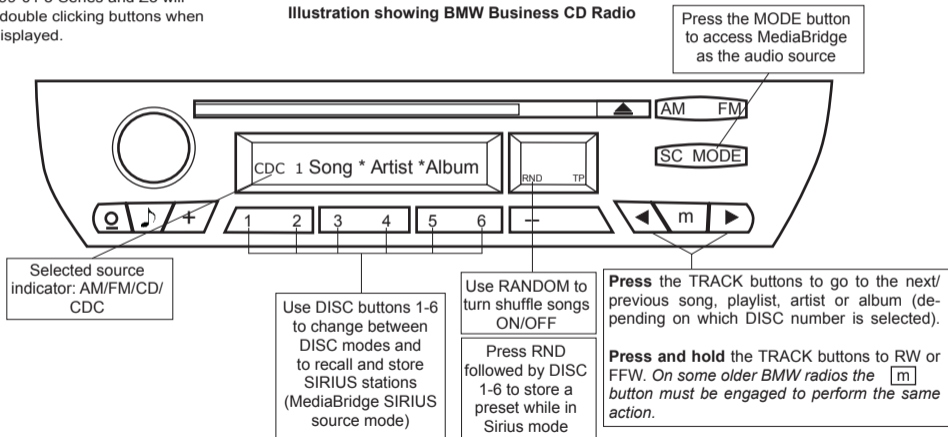

## Illustration showing BMW 16:9 Navigation radio

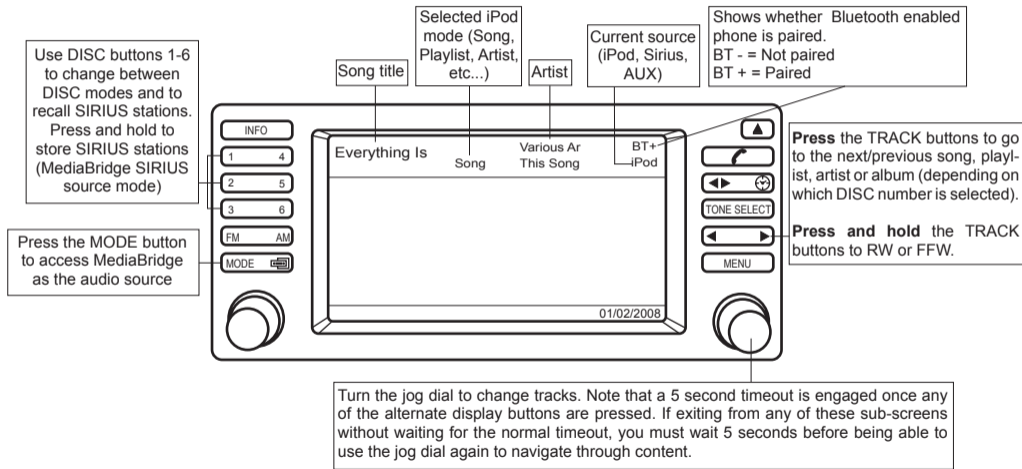

## Illustration showing Mini Navigation radio



You must have the correct display mode selected for proper operation (see page 19, DISC 5).

Song/Artist/Playlist displayed here

Press the MODE button to access MediaBridge as the audio source

**Press** the TRACK buttons to go to the next/previous song, playlist, artist or album (depending on which DISC number is selected).

**Press and hold** the TRACK buttons to RW or FFW. On some older BMW radios the **m** button must be engaged to perform the same action.

Selected source indicator: AM/FM/CD/CDC

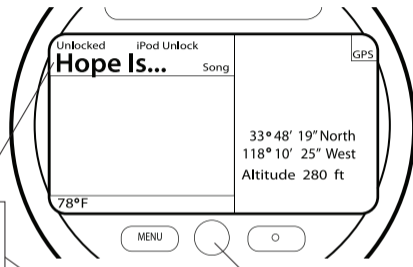

Turn DIAL for next/previous track.

**Press** DIAL to store SIRIUS station presets (MediaBridge SIRIUS source mode; see page 24).

On Mini Navigation radios, the RND button is used to toggle between **Menu** and **Text** modes.

**Text Mode (RND enabled):** Displays text from the MediaBridge such as Song/Artist/Playlist titles.

**Menu Mode (RND disabled):** Displays the default Navigation and vehicle menu screens.

Use DISC buttons 1-6 to change between DISC modes and to recall and store SIRIUS stations (MediaBridge SIRIUS source mode).

Used to store stations to Presets 1-5.

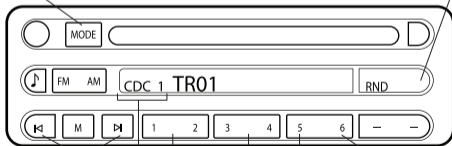

## Icon legends



## Controlling the MediaBridge iPod Source

Use DISC 1-6 to enter browsing modes (SONG, PLAYLIST, ARTIST, ALBUM, PODCAST and AUDIO BOOK).

- Within each mode, use the TRACK button to browse the items available.

Note: if the iPod is unlocked, radio control will be limited to Songs, Playlists, and Albums. Text display will also be limited to show only current song information.

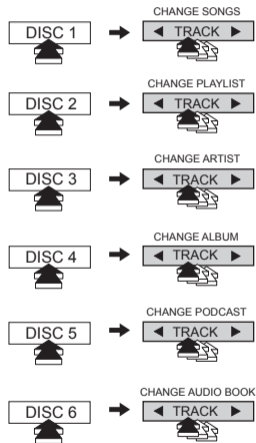

## Controlling the MediaBridge USB memory source

- Select DISC 1, then use the track buttons to change from song to song.
- Select DISC 2-6 to browse Folders and use the track buttons to navigate through the folders on your USB flash drive.
- The MediaBridge unit will recognize the first 8 levels of folders, with up to 200 accessible folders within each folder. Only the first 1000 files will be read in each folder, the rest will be ignored.
- Songs play in the order they were added to the flash drive.
- Use the Random feature on radio to shuffle all songs on the flash drive. This may take a long time to complete if the flash drive is more than 4GB.

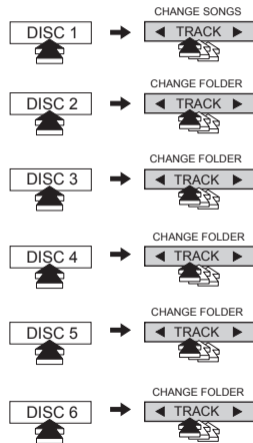



## Controlling the MediaBridge SIRIUS source

The MediaBridge integration kit features SIRIUS connectivity (requires additional tuner). Use the TRACK buttons or jog DIAL to browse between subscribed channels.

### To store a subscribed channel to memory:

- **Single line radio:** Tune to desired station. Press RANDOM button and select which DISC button (preset 1-6) to save to. Press RANDOM button once more to store the station.
- **Navigation radios:** Tune to desired station. Press and hold the desired DISC button (preset 1-6) to save as preset.
- **Mini Navigation radio:** Tune to desired station. Press jog DIAL, press desired DISC button (1-6), press DIAL to save.

**To recall a memorized channel:** Simply press the desired DISC (preset 1-6).

**Sirius mode:**  to recall PRESET 1-6 stations - **To store stations to buttons 1-6**

### Common control:

 or  to change channel

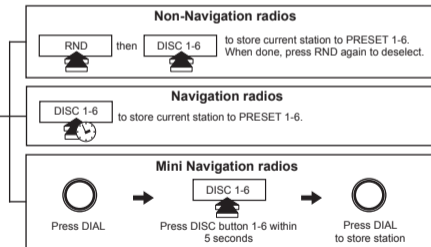

**Note:** If a SIRIUS CONNECT compatible tuner is not detected, then a "No Tuner" message is displayed. Go to Channel 000 to view the SIRIUS Tuner ID for activation. The 12 digit SID display format is shown in two parts as SID "123456-" followed by "-789ABC".

## Bluetooth & MAT (Music Announcer Technology) configuration

To alter voice announcement and Bluetooth pairing settings select Bluetooth as your audio source, press the DISC button that corresponds to the feature you want to configure, and then use Track to browse through configuration options:

- **DISC 1, 2 or 3** should be selected if you want to control Bluetooth audio streaming playback.
- **DISC 4** controls the Autoconnect feature. Available options are Enable and Disable. This controls whether or not the MediaBridge will reconnect automatically when phone becomes disconnected. Only the most recently paired device will be reconnected automatically.
- **DISC 5** controls the paired devices memory. There is only one option. Change tracks to clear the listing of paired devices with the MediaBridge and put module into discoverable mode.
- **DISC 6** controls MAT setting. Available options are Default, Extended, Phone only, and Off (refer to the chart below).

Options	Function
Default	Reset MAT back to factory default configuration
Extended	Turn on ALL MAT feature
Phone only	Turn on the phone relative MAT only
Off	Turn off MAT completely

## Pairing MediaBridge with your cell phone via Bluetooth

1. Turn on the Bluetooth feature on your cell phone.
2. Select MediaBridge as your audio source from your radio, then select Bluetooth mode.
3. Search device from your cell phone.
4. Select MediaBridge from device list and enter password "0000" to connect.

Note: MediaBridge is only discoverable for Bluetooth pairing for the first 60 seconds after selecting Bluetooth mode within the MediaBridge. This is indicated with a "DISCOVERABL" message on the radio display. Please perform pairing while the vehicle is parked. Bluetooth devices remain paired 30 seconds after exiting MediaBridge mode, within this time active audio streams and phone calls aren't audible on the phone but can be resumed by re-entering MediaBridge mode.

## Answering / Making a phone call

- To answer an incoming call, press the button that tunes to the next track or channel.
- To reject an incoming call or terminate an active call, press the button that tunes to the previous track or channel.
- To make an outgoing call, dial on the phone like you would normally.



Phone calls interrupt any music/ audio that is currently playing on the radio while MediaBridge is the selected audio source.

## Playing music from a cell phone through MediaBridge via Bluetooth

1. Enter Bluetooth mode on MediaBridge.
2. Make sure your cell phone is paired with MediaBridge.
3. Select and play a song from your cell phone's music player.

Note: Some cell phones require you to manually select the option to play music via (A2DP) Bluetooth Streaming. Song information is shown on the radio display if your phone supports AVRCP1.3.

4. Use Track UP/DOWN to skip tracks / FF / RW songs on the AVRCP compatible phone.

## Accessing the auxiliary input

- An auxiliary audio device can be connected to the MediaBridge unit through it's 1/8" headphone jack.
- In AUX mode, music is controlled only through the auxiliary audio device.
- Audio equalizer setting can be adjusted while in auxiliary mode by selecting DISC 1-4 and using the TRACK button to increase or decrease levels. DISC numbers and corresponding setting are shown on the right chart.

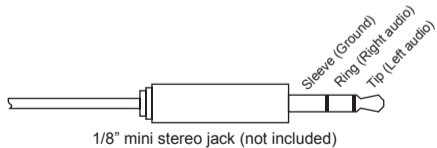
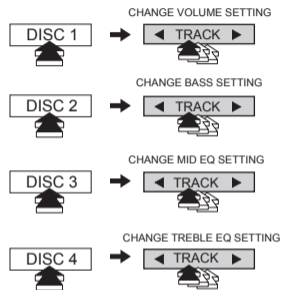

## Internet Radio Application support (iPhone/iPod touch)

This kit includes support for internet radio streaming apps available on the iTunes® Store. Thousands of stations can be streamed through data connections. Supported apps include Livio Car Internet Radio, Pandora, iHeart Radio and more. Supported features such as text display on screen, and next/previous track functions will vary by app.

To learn more about each app specifically, please visit the website for the app you need information about.



## Data connection requirements (3G/4G/WiFi)

Users must have an active wireless data connection in order to stream music from an app while in the car. Data connections including "3G" or "4G" through wireless carriers, or a third party wireless Internet access point connected to your mobile device through WiFi will work. Because this app requires a data connection, it will only work on connected devices such as the iPhone and iPod touch.

## Controlling Internet Radio Apps

NOTE: The following features may not be supported by all apps. For demonstration purposes the following examples will show the features for the Livio Car Internet Radio app.

The app must be active on the screen of the device. To do so, simply tap the app's icon and it will load.

**Next/previous TRACK buttons** execute application specific features such as skipping stream or cycling between station presets. **DISC (1-6) buttons** are associated with station presets when used with the Livio Car Internet Radio application.

iPhone operating system iOS5 enabled application developers to share the “now playing” screen information. For example, when using the Pandora App, you will see artist, album and song information on the radio's screen. When using an application that doesn't implement this feature, or running iOS4, only the name of the application will be shown.

Please note that although iOS 4 (4.2.1) is supported on iPhone 3G and iPod Touch 2nd generation, applications do not run in the background. As such, loading the app takes longer than on devices where the app is present in the background.



If your listening experience is interrupted by a call, under most conditions, the app will resume playback at the end of the call.

Music playback apps running on your iPhone are sent to background automatically when the home button of the phone is pressed, but the music playback itself is not stopped.

To resume playback of your iPod music library, stop Livio playback by tapping on the screen below the Livio Radio logo. An icon representing “stop” will show on the main Livio screen. Press the home button to send the application to the background. (Other apps may need to be terminated manually. Please see next page.)

A few seconds after this, the iPod music playback application will reinitialize itself and become active again if the iPod was locked when it was connected to the kit. (This is indicated by an Accessory Connected message being shown when the iPod icon is tapped.)

If the iPod was in unlocked state when it was connected to the kit, press the play button on the iPod application.

## **Text Display from the Internet Radio App**

Text that scrolls across the radio’s screen is associated with the stream shown on the radio and displays current song or station information. Stream must be playing before information on the display is updated.

## **Terminate (kill) the App**

If you need to terminate (kill) the app please follow the steps below:

1. Double-tap on the home button of the iPhone to bring up the list of running apps. If you don't see the app's icon right away, swipe the screen left or right to locate it. Note: If you do not see such task bar but rather a music control popup then you have an iOS device that does not support background run of apps, therefore this section is not applicable to you.
2. Press and hold the icon of the app until a red minus icon shows.
3. Tap the red minus icon shown on top of the app.
4. This will close the app.
5. In a few seconds, the iPod music playback app should reinitialize itself and become active again. This can be verified by going back to the list of running apps and swiping the screen until the music control section is shown. The iPod app icon next to the music control sections shows that iPod is your audio source.

## **Internet Radio App Settings**

Many radio stations offer lower bitrates. Selecting streams with a lower bitrate will reduce data usage and may reduce stream interruptions during the drive. For example with the Livio Car Internet Radio app, to adjust bitrates manually, users can:

Go to the Setting menu of the device, select the Livio Radio settings the change the Maximum Bitrate Filter and set it to 64K. Other settings such as Buffer time and Reliability filter may also help in getting a more stable connection.



## Updating Firmware (Mac OS illustrated)

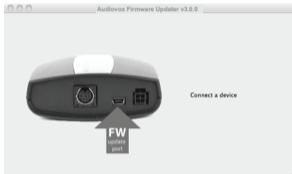

Connect module via mini USB



Device specifications and update selection

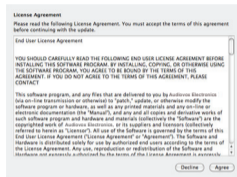

License Agreement (click Agree to proceed)

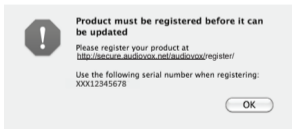

Product registration notification

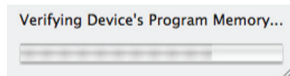

Firmware update progress

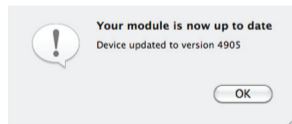

Module updated successfully!

The above screen shots are for illustration purposes only.

## Troubleshooting

<b>Problem</b>	<b>Solution</b>
<b>Radio/NAV display only shows DISC and track number and there is no iPod control.</b>	Make sure DIP switch settings are correctly set for text display (refer to page 8 for DIP switch settings).
<b>No text display on radio.</b>	Make sure DIP switch settings are correctly set for text display (refer to page 8 for DIP switch settings). Please also select proper display mode (refer to page 19, DISC 5).
<b>Correct DIP switch settings but still no text display.</b>	Make sure the module is reconnected with the vehicle off when changing any dip switches. Verify that the vehicle's radio is capable of displaying CD-text. Some early model year radios don't support text display.
<b>iPod does NOT charge.</b>	Check all connections. See if iPod charges while connected to computer or wall charger. You may need to reset the iPod.
<b>Music is distorted or sound level is too low with iPod connected.</b>	Make sure all EQ and BASS boost options are turned off on your iPod. Adjustments to the gain setting may be required (refer to page 19).
<b>No audio from iPod source.</b>	Reset the iPod. Verify proper connection to iPod/interface. Check for compatibility. Older iPod models don't support USB audio and may only operate in Locked mode.

<b>Problem</b>	<b>Solution</b>
<b>Sirius tuner can't be selected.</b>	Ensure the cable connecting the SIRIUS tuner is securely connected to the correct receptacle on the MediaBridge module. Refer to page 19 for cycling through MediaBridge audio sources.
<b>Why does the radio display show "EMPTY/STOP" and no music plays?</b>	The iPod has reached the end of a selection. Go ahead and browse for another selection.
<b>Cannot select the interface.</b>	Verify that the correct button is being pressed to access the interface (CD or Mode). Disconnect the MediaBridge module's power connection for one minute to reset it.
<b>Radio/ steering wheel controls do not operate iPod.</b>	Reset iPod and make sure the most recent iPod firmware is installed. Check vehicle user manual on how steering wheel controls work, long presses may toggle alternate function. Engine may need to be running on some models.
<b>Why does category read "PRESELCTD"?</b>	Playback of content selected on the iPod before it is connected to the interface continues until new content is selected.

<b>Problem</b>	<b>Solution</b>
<b>Why does the message “iPod UNLOCKED” display on screen?</b>	When the MediaBridge is playing iPod music in UNLOCKED mode, browsing mode information isn't available so the “iPod UNLOCKED” notification is shown. To view information associated with browsing modes, ensure the hold button of the iPod is set before connecting it to the MediaBridge.
<b>Why is the interface not controlling the iPod/USB drive?</b>	Please make sure that the USB connection is not loose. Make sure that an iPod case is not preventing the dock connector from being fully seated. Disconnect and reconnect the device. If iPod is not responding please try resetting it. USB device must also be FAT16/32 format and contain supported MP3, WMA or AAC content.
<b>What size of USB flash drive should I use?</b>	Large capacities are supported, however up to 4GB is recommended for optimal user experience.
<b>Text is not scrolling.</b>	Scrolling is not supported in multiline display mode, however you can configure for single line operation to see scrolling text. Please refer to page 19, DISC 5 setting.

**AUDIOVOX®**

DRIVEN BY DICE ELECTRONICS

**AUDIOVOX®****12 MONTH LIMITED WARRANTY**

AUDIOVOX ELECTRONICS CORP. (the Company) warrants to the original retail purchaser of this product that should this product or any part thereof, under normal use and conditions, be proven defective in material or workmanship within 12 months from the date of original purchase, such defect(s) will be repaired or replaced with reconditioned product (at the Company's option) without charge for parts and repair labor. A game controller, if supplied, is similarly warranted for ninety (90) days.

To obtain repair or replacement within the terms of this Warranty, the product is to be delivered with proof of warranty coverage (e.g. dated bill of sale), specification of defect(s), transportation prepaid, to the Company at the address shown below.

This Warranty does not extend to the elimination of externally generated static or noise, to correction of antenna problems, to costs incurred for installation, removal or reinstallation of the product, or to damage to digital memory/media devices, gaming devices, discs, speakers, accessories, or vehicle electrical systems.

This Warranty does not apply to any product or part thereof which, in the opinion of the Company, has suffered or been damaged through alteration, improper installation, mishandling, misuse, neglect, accident, or by removal or defacement of the factory serial number/bar code label(s). THE EXTENT OF THE COMPANY'S LIABILITY UNDER THIS WARRANTY IS LIMITED TO THE REPAIR OR REPLACEMENT PROVIDED ABOVE AND, IN NO EVENT, SHALL THE COMPANY'S LIABILITY EXCEED THE PURCHASE PRICE PAID BY PURCHASER FOR THE PRODUCT.

This Warranty is in lieu of all other express warranties or liabilities. ANY IMPLIED WARRANTIES, INCLUDING ANY IMPLIED WARRANTY OF MERCHANTABILITY, SHALL BE LIMITED TO THE DURATION OF THIS WRITTEN WARRANTY. ANY ACTION FOR BREACH OF ANY WARRANTY HEREUNDER INCLUDING ANY IMPLIED WARRANTY OF MERCHANTABILITY MUST BE BROUGHT WITHIN A PERIOD OF 24 MONTHS FROM DATE OF ORIGINAL PURCHASE. IN NO CASE SHALL THE COMPANY BE LIABLE FOR ANY CONSEQUENTIAL OR INCIDENTAL DAMAGES FOR BREACH OF THIS OR ANY OTHER WARRANTY. No person or representative is authorized to assume for the Company any liability other than expressed herein in connection with the sale of this product.

Some states do not allow limitations on how long an implied warranty lasts or the exclusion or limitation of incidental or consequential damage so the above limitations or exclusions may not apply to you. This Warranty gives you specific legal rights and you may also have other rights which vary from state to state.

Audiovox Electronics Corporation, 150 Marcus Blvd., Hauppauge, New York 11788 • 1-800-645-4994

128-9032

**Installation notes:**

Installed by:

Installed date:

Other notes:

Illustration:

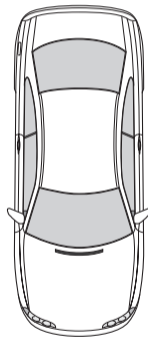



BMW/Mini Cooper compatible integration  
for iPod, iPhone, Bluetooth, USB, AUX and SIRIUS.  
[www.audiovoxproducts.com](http://www.audiovoxproducts.com)

OMA-MBR-1500-BMW-012012



For Customer Service  
Visit Our Website At  
[www.audiovoxproducts.com](http://www.audiovoxproducts.com)  
Product Information, Photos,  
FAQ's, Owner's Manuals



**AUDIOVOX**  
ELECTRONICS CORP.

150 Marcus Blvd., Hauppauge, New York 11788  
©2012 Made in China • Fabriqué en Chine • Hecho en China



SAVE ENVIRONMENT  
PLEASE RECYCLE

ECONOMISER L'ENVIRONNEMENT  
RECYCLEZ S'IL VOUS PLAÎT

EXCEPTO EL AMBIENTE  
RECICLE POR FAVOR