

AUDIOVOX[®]
DRIVEN BY DICE ELECTRONICS



iPhone | Internet Radio | Satellite

for selected Audi/VW vehicles

Installation Guide/User manual

Made for



iPod



iPhone

Copyrights and Trademarks

Copyright 2012 Audiovox Electronics Corporation

The Audiovox and Audiovox Driven by DICE Electronics logos are trademarks of Audiovox Electronics Corporation

iPod and iPhone are trademarks of Apple, Inc.

All Trademarks and Logos are the property of their respective owners.

All rights reserved.

Printed in the U.S.A.

Table of Contents

Warning and safety	4
Product registration	5
Silverline DUO kit contents	6
Identifying your DUO kit	7
Dip switch configuration	8
Supported iPod models.....	9
Installation	10
Connection Diagram	11
A-DUO-100-AUD Connector	12
A-DUO-101-AVW R1 Connector.....	13
A-DUO-101-AVW R2 Connector	14
A-DUO-101-AVW R2 Modification	15
A-DUO-102-AVW Connector.....	16
A-DUO-103-AVW Connector.....	17
Attention to installers	18
iPod content browsing	19
Charging	19
iPod locked/unlocked settings	20
SAT Emulation (A-DUO-103-AVW)	
Basic Operation and Settings	21
Browsing modes	22
Overview of Audi Symphony radio	23
Overview of VW radio	24
Overview of Audi Concert radio	25
Overview of Audio Navigation Plus radio	26
Overview of VW Navigation radio	27
Sirius Connect Operation	28
CDC Emulation (A-DUO-100-AUD, A-DUO-101-AVW, A-DUO-102-AVW)	
Basic Operation and Settings	29
Browsing modes	30
Selecting the DUO as an Audio Source	31
Internet Radio Applications	32
Auxiliary audio source	36
Optional Remote Kit: iPod	37
Optional Remote Kit: SIRIUS	38
Troubleshooting	39
Firmware Update	42
Warranty	43

Warning and safety!

Please read these instructions carefully before proceeding. Failure to follow instructions may result in improper operation or injury. Neither Audiovox Electronics Corporation nor Apple Inc., its regional offices, distributors or resellers take any responsibility for any damage or injury as a result of using the integration kit.

- Do not open, disassemble or alter the interface in any way.
- Do not insert anything into the casing.
- Do not cut or try to alter cables in any way and always use the correct connections.
- Only operate unit when stationary or ask passengers to operate it for you.
- Do not allow the Apple iPod/iPhone to distract you from driving.
- Exercise good judgement and keep your eyes on the road at all times.
- Do not expose unit to extreme temperatures, humidity or shock.
- Keep the unit and iPod/iPhone away from fluids.
- Keep away from children! - Interface components may contain small parts, can be broken or disassembled and components may become loose from vibration and heat. Small components and packaging materials may be a choking hazard when handled by children.



Congratulations on your purchase!

Thank you for purchasing this integration kit. Please review this booklet before operating the unit. This interface was designed and manufactured to seamlessly integrate with your vehicle's factory audio system.

Product registration

We recommend registering your Audiovox product so you can receive news about important firmware updates and have unlimited access to our online support system.

To register your Audiovox product, please complete the following steps:

1. Visit <http://www.audiovoxproducts.com>
2. Look up and save the serial number of the product.
3. Complete the product registration form.
4. Submit the form.
5. Save the registration sheet in a safe place for future reference.

If you are unable to complete the registration via internet, please call Audiovox at 1-800-645-4994.



Prior to installation make sure the module's firmware is up to date to ensure compatibility with the latest features and enhancements. Please refer to page 42 to update firmware.

Silverline DUO kit contents



Silverline DUO module



user manual

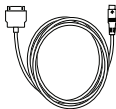

dock cable



AUX connector
(optional)

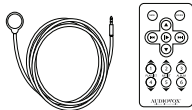

IR Receiver &
Remote (optional)

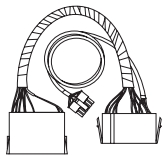

A-DUO-100-AUD
connector



A-DUO-101-AVW
R1 connector



A-DUO-101-AVW
R2 connector

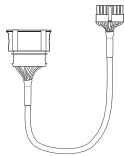

A-DUO-102-AVW
connector

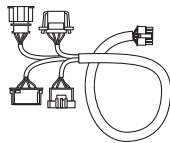

A-DUO-103-AVW
connector

Only one of these cables is included with each kit!

Identifying your DUO kit

A-DUO-100-AUD, A-DUO-101-AVW, A-DUO-102-AVW - These kits work in CDC Emulation mode. Please refer to the CDC Emulation sections of this manual.

A-DUO-103-AVW - This kit works in SAT Emulation mode. Please refer to the SAT Emulation sections of this manual. **DIP switch settings also need to be configured for this kit (see next page).**



DIP switch configuration (A-DUO-103-AVW only)



This setting must be performed for proper functionality of the DUO kit. See pages 23-27 to determine the correct DIP switch setting for your vehicle's specific radio (A-DUO-103-AVW only).

The configuration switches located on the Silverline DUO module are used to set functionality for various radio models. Refer to pages 23-27 for correct DIP switch settings. Incorrect dip switch settings may cause the interface to not work properly or to not operate at all. **Disconnect the vehicle harness from the module and cycle ignition off for 60 seconds after changing the switches then reconnect the module!**

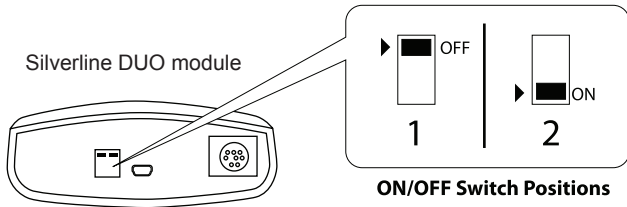

Supported iPod models and firmware version requirements

Model	Firmware / OS Version
1G nano	1.3.1
iPod 5G	1.3
2G nano	1.1.3
iPod classic	1.1.2
3G nano	1.1.3
iPod touch	iOS 3.1.3
iPhone	iOS 3.1.3
iPhone 3G	iOS 4.2.1
4G nano	1.0.4
120 GB classic	2.0.1
2G touch	iOS 4.2.1
iPhone 3GS	iOS 5

Model	Firmware / OS Version
160 GB classic	2.0.4
5G nano	1.0.2
3G touch	iOS 5
iPhone 4	iOS 5
iPhone 4S	iOS 5
4G touch	iOS 5
6G nano	1.2

Attention installer! Please read the following!

Audiovox strongly recommends that the unit be installed in an easily accessible place!

DO NOT PLACE IT BEHIND THE RADIO AND DO NOT HIDE UNDER CARPET!

Whether the unit is professionally or self installed, put the module where you, the end user can get to it easily in the future. (Have the installer show you where the interface module is installed.)

Installing the module behind the radio will make it difficult to:

- Add possible future upgrades, changing software, adding new features, improving operation;
- Access the AUX input on the module to attach any audio device;
- Access the DIP switches located on the module;
- Remove the unit in case of failure.

MAKE SURE THAT THE MODULE IS IN AN ACCESSIBLE PLACE!

Connection Diagram

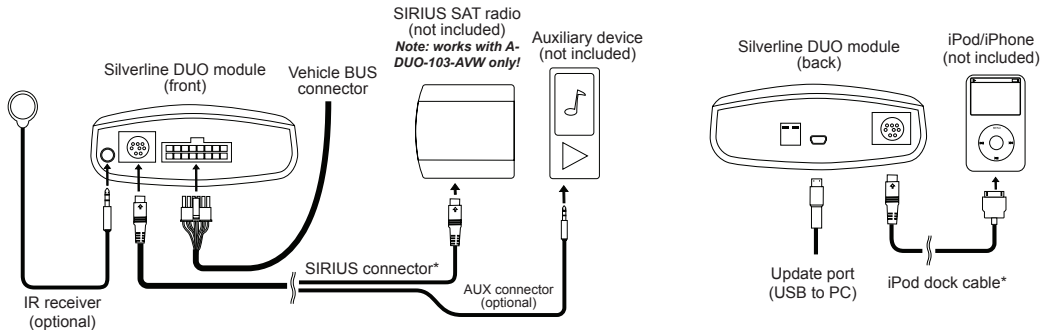

*Do not connect the iPod dock cable under any circumstance to the SIRIUS module connector! Improper connection can cause permanent damage to iPod/SIRIUS module.

Installation

1. Verify compatibility

2. Disconnect battery

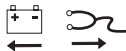

3. Remove radio from car

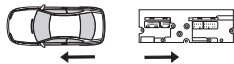

4. Install Silverline DUO cable



5. Route kit to glove box or other accessible location

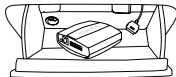

6. Connect battery & test



7. Complete install by re-installing radio

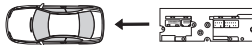

Some radios will enter an anti-theft security mode and will lock requiring the radio's security code to be entered to unlock it. This code can be requested from the vehicle's dealership.

Vehicle BUS Connector - A-DUO-100-AUD Connector

You can access the CD changer connector located on the back of the radio. Unplug the factory connection if present and plug the A-DUO-100-AUD connector into the receptacle. The connector should securely lock. Ground wire **MUST** be connected to a stable grounding point.

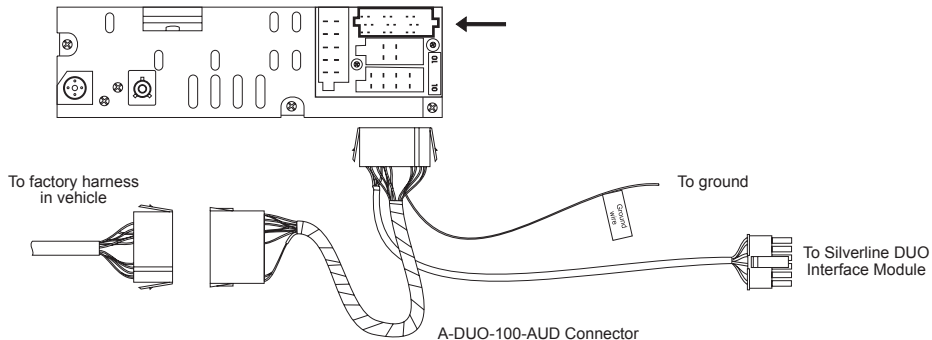

Vehicle **BUS** Connector - **A-DUO-101-AVW R1 Connector**

You can access the CD changer connector located on the back of the radio. Unplug the factory connection if present and plug the A-DUO-101-AVW R1 connector into the receptacle. The connector should securely lock. Ground wire **MUST** be connected to a stable grounding point.

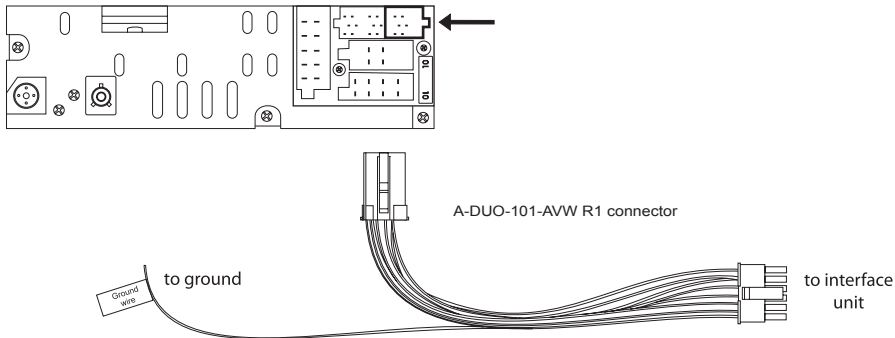

Vehicle BUS Connector - A-DUO-101-AVW R2 Connector

You can access the CD changer connector located on the back of the radio. Unplug the factory connection if present and plug the A-DUO-101-AVW R2 connector into the receptacle. The connector should securely lock. Ground wire **MUST** be connected to a stable grounding point.

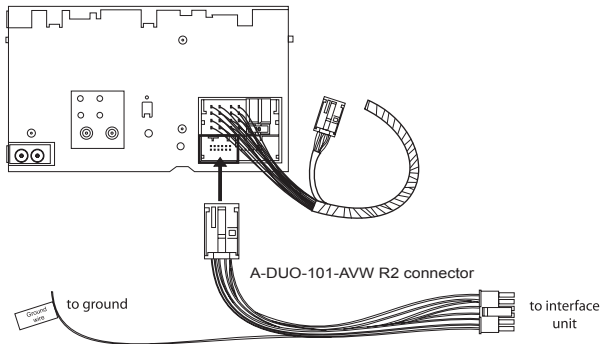

A-DUO-101-AVW R2 Modification

If vehicle is equipped with factory satellite radio and it is to be retained, the harness modification illustrated below is required. **NOTE:** This modification will only work for VW vehicles.

- 1 Disconnect main radio harness and locate SAT connector. Remove it from main harness by pressing on the release tab of the SAT connector.

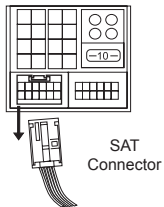

- 2 Slide out the inner part of the SAT connector from plastic housing.

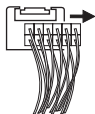

- 3 Disassemble the A-DUO-101-AVW R2 connector the same way as the factory SAT connector.



- 4 Remove the SAT wires from the factory connector by releasing the pins with a small screw driver or ball point pen.

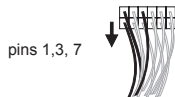

- 5 Relocate wires to A-DUO-101-AVW R2 connector keeping the same order and location.

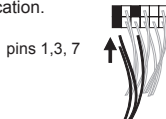

- 6 Put plastic connector covers back on. Insert A-DUO-101-AVW R2 connector to factory VW main harness.

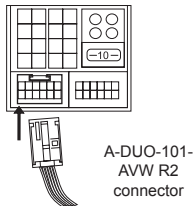

- 7 Connect ground wire to chassis of radio.

Vehicle BUS Connector - A-DUO-102-AVW Connector

The connection for this is made at the external CD-changer connection in certain Audi/VW vehicles. On VW models, the connection is usually in the trunk (does not apply to vehicles that came with a CD-changer built in to the radio). For Audi vehicles, the connection is inside the glove box, standard with navigation radios and/or single-CD radios (also does not apply for vehicles that came with a CD-changer built in to the radio). The external CD-changer cannot be retained.

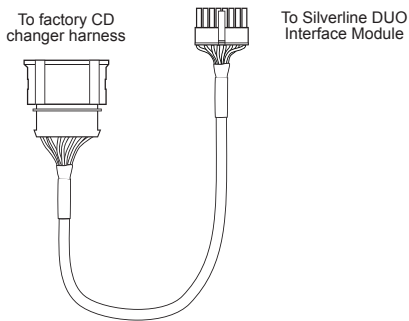

Vehicle BUS Connector - A-DUO-103-AVW Connector

The factory Satellite tuner connections must be accessed, for which the location varies depending on vehicle (inside trunk panels, under passenger seat, etc). The harness provided with the kit is long enough to reach from these locations. If there is a factory satellite tuner, unplug it's two connections and these can connect into the interface harness. If satellite radio is intended to be retained, connect the other two plugs into the satellite tuner.

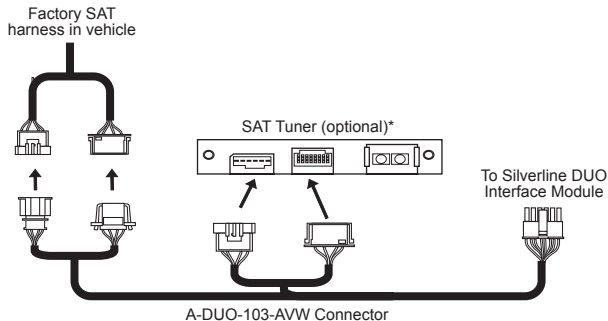

*Connect SAT Tuner only if the SAT subscription is activated or will be activated in the near future. If vehicle did not come with a factory satellite tuner, two connections inside the front passenger-side kick panel may have to be mated together for the Silverline Duo to recognize as an audio source.

iPod content browsing

By default, the interface creates a Playlist having a name that is the same as the name of the iPod. This Playlist is the very first on the list of Playlists shown while browsing in Playlist mode. This Playlist contains all the songs on the iPod. Once a Playlist is selected an Artist may be selected within that Playlist using the Artist Mode. Albums by the selected Artist within the selected Playlist may be selected in Album Mode. “ALL ARTIST” and “ALL ALBUM” designate all available content in those categories.



Charging

The interface automatically charges the battery of the iPod when connected and your vehicle ignition key is in the ACC/ON position.

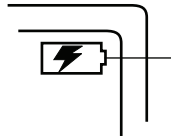

Charging may be indicated by an icon that appears on the upper right corner of the iPod screen. May vary by model.

How the iPod's Hold Button Works with Silverline DUO

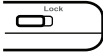
	iPod hold ON	iPod hold OFF
		
Radio control	✓	Limited
iPod control	✗	✓
	Before connecting the iPod to the module, turn the hold switch ON to fully control and browse the songs from the wireless remote. The iPod is locked in this state.	Before connecting the iPod to the module, turn the hold switch OFF to fully control and browse the songs from iPod. Browsing capabilities are limited from the wireless remote.

Note: Setting the iPod's hold switch must be done prior to connecting it to the dock cable.
iPod nano 6th generation will always be in locked mode since it does not have a lock switch.



For iPod touch and iPhone, when the screen is not active (as shown on the left), the iPod/iPhone is locked (Press the power button to lock the iPhone/iPod Touch).

SAT Emulation: Basic Operation and Settings (A-DUO-103-AVW)

- Set your radio to the SAT (satellite radio) source by pressing the radio source selector to select the Silverline DUO.
- Select the DUO audio source: Within the first 10 seconds of selecting the DUO press SEEK/TRACK UP or DOWN to cycle through:
 - “**AUX**” or “**SIRIUS**” - Listen to an auxiliary audio device or listen to and control SIRIUS tuner connected to DUO module. AUX requires optional cable.
 - “**iPod**” - Listen to and control iPod
 - “**SAT**” - Listen to and control factory satellite radio tuner (if available)

NOTE: To select a different DUO audio source during playback, the head unit must be turned off and back on again!

Silverline DUO Interface Settings (available within first 5 seconds of selecting Silverline DUO):

Select PRESET 1 to apply settings and resume audio playback.

Select PRESET 3 to change default volume level; use track up/down to adjust between Min and Max

Select PRESET 4 to enable/disable scrolling text.

Select PRESET 6 to view Silverline DUO serial number and firmware version.

PRESET 2 and 5 have no settings available.

Note: if the iPod is unlocked for direct control, radio control will be limited to songs, playlist and albums. Text display will also be limited to show only current song information. It will not show the name of Playlist / Artist / Album.

SAT Emulation: Browsing modes

In SAT Emulation, you can browse the content on your iPod by various modes: song, playlist, artist, album, podcast and audiobook. Each PRESET button has a mode assigned to it as illustrated below.

- Press PRESET button to select mode, then use next/previous track buttons to browse contents within the selected mode.



SAT emulation: Operating Silverline DUO as an audio source on various radio systems - *Audi symphony*

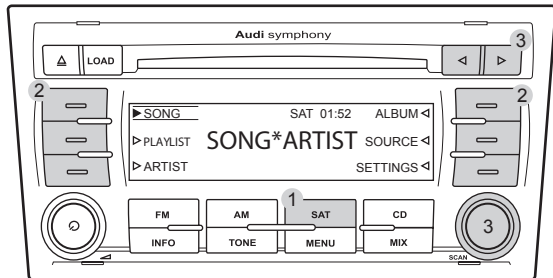

- 1 Radio source selector (SAT / Silverline DUO)
- 2 Preset buttons - press to enter: Song / Playlist / Artist / Album / podcast / audiobook modes
- 3 Track Up / Down

Set DIP switch:

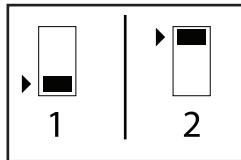

SAT emulation: Operating Silverline DUO as an audio source on various radio systems - VW with SAT button

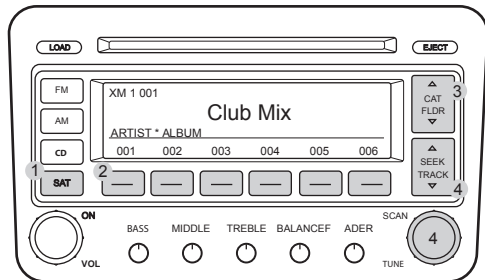

- 1 Radio source selector (SAT / Silverline DUO)
- 2 Preset buttons - press to enter: song / playlist / artist / album / podcast / audiobook modes
- 3 Disc Up / Down
- 4 Track Up / Down

Set DIP switch:

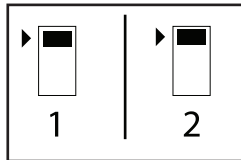

Note: Some versions of this radio unit require preset buttons to be programmed. Use 3 to select one of the modes, then press and hold each preset button for 5 seconds.

SAT emulation: Operating Silverline DUO as an audio source on various radio systems - *Audi concert*

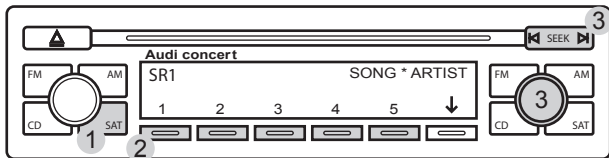

- 1 Radio source selector (SAT / Silverline DUO)
- 2 Preset buttons - press to enter: song / playlist / artist / album / podcast / audiobook modes
- 3 Track Up / Down

Set DIP switch:

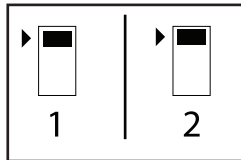

SAT emulation: Operating Silverline DUO as an audio source on various radio systems - Audi Navigation Plus

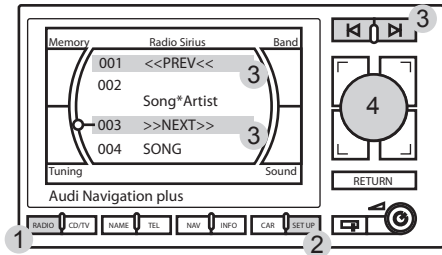

- 1 Radio source selector (SAT / Silverline DUO)
- 2 Preset and set the following setting:
Sort stations by: channel number
Station Info: On
- 3 Track Up / Down

- 4 Rotate the knob to select SONG / PLAYLIST / ARTIST / ALBUM / PODCAST / AUDIO-BOOK on the screen. Press the knob to confirm the selected mode.

Set DIP switch:

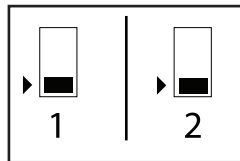

SAT emulation: Operating Silverline DUO as an audio source on various radio systems - VW NAV w/ SAT

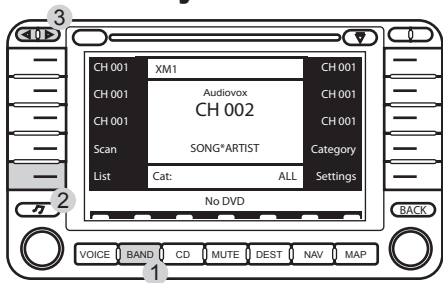

- 1 Radio source selector (XM1 / Silverline DUO)
- 2 Press to enter Mode selection, then rotate the jog dial (4) to select: SONG / PLAYLIST / ARTIST / ALBUM / PODCAST / AUDIOBOOK
- 3 Track Up / Down

- 4 Jog dial used to select SONG / PLAYLIST / ARTIST / ALBUM / SOURCE / SETTING on the screen. Press the knob to confirm the selected mode.

Set DIP switch:

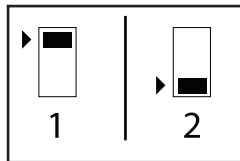

SAT emulation: Sirius Connect™ operation

- Stations can be saved to PRESET 1-6 by holding a preset button (1-6).
- TEXT or DISP button will toggle between the text fields.

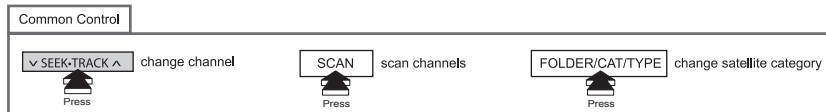
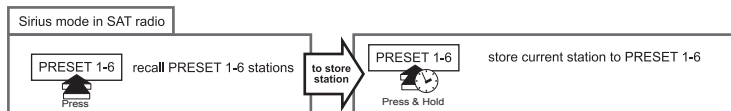

- If a Sirius Connect compatible tuner is not detected, then an “AUX” message will be displayed. Please refer to the factory manual of your radio system about operating the Satellite mode.
- Go to Channel 000 to view the Sirius Tuner ID for activation. The 12 digit SID display format is in two halves as SID “123456-” followed by “-789ABC”.

Note: You may use the remote control to change browsing modes.

CDC emulation: Basic operation and settings

Accessing the DUO as the audio source:

Much like the radio's AM/FM tuner, satellite radio or CD audio sources, the Silverline DUO is integrated to be part of the vehicle's audio system. To access the DUO source, press the CD button. Pressing this button repeatedly will cycle through sources present in the vehicle (CD > DUO).

DUO source selection:

The DUO adds additional audio sources including iPod and auxiliary audio input*. To cycle between these sources, use the TRACK buttons within the first 5 seconds of accessing the DUO as the audio source.

**This source requires additional parts/accessories/service from Audiovox and/or third parties and can only be selected if devices are connected.*

DUO Interface Settings

Select DISC 1 to apply settings and resume audio playback. Use TRACK up/down to select DUO audio source:

TRACK 1 = iPod **TRACK 2** = Auxiliary audio source

Select DISC 3 to change default volume level; use track up/down to adjust between Min and Max. Use TRACK up/down to cycle settings:

TRACK 1 = min. volume **TRACK 5** = mid volume (default) **TRACK 9** = max volume

DISC 2, 4, 5 and 6 have no settings available.

CDC emulation: Browsing modes

In CDC Emulation, you can browse the content on your iPod by various modes: song, playlist, artist, album, podcast and audiobook. Each DISC button has a mode assigned to it as illustrated below.

- Press DISC button to select mode, then use next/previous track buttons to browse contents within the selected mode.



Note: if the iPod is unlocked for direct control, radio control will be limited to songs, playlist and albums. Text display will also be limited to show only current song information. It will not show the name of Playlist / Artist / Album.

CDC emulation: Operating Silverline DUO as an audio source

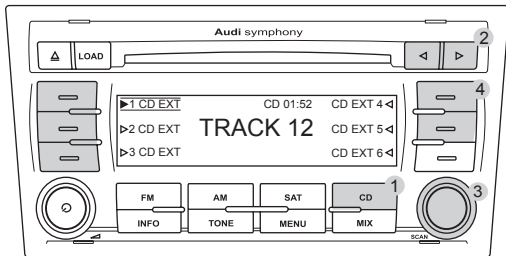

- 1 Radio source selector (CDC / Silverline DUO)
- 2 Press for Next / Previous track, hold to rewind or fast forward.
- 3 Turn to change track
- 4 Press to change DISC

Internet Radio Application support (iPhone/iPod touch)

This kit includes support for internet radio streaming apps available on the iTunes® Store. Thousands of stations can be streamed through data connections. Supported apps include Livio Car Internet Radio, Pandora, iHeart Radio and more. Supported features such as text display on screen, and next/previous track functions will vary by app.

To learn more about each app specifically, please visit the website for the app you need information about.



Data connection requirements (3G/4G/WiFi)

Users must have an active wireless data connection in order to stream music from an app while in the car. Data connections including "3G" or "4G" through wireless carriers, or a third party wireless Internet access point connected to your mobile device through WiFi will work. Because this app requires a data connection, it will only work on connected devices such as the iPhone and iPod touch.

Controlling Internet Radio Apps

NOTE: The following features may not be supported by all apps. For demonstration purposes the following examples will show the features for the Livio Car Internet Radio app.

The app must be active on the screen of the device. To do so, simply tap the app's icon and it will load.

Next/previous TRACK buttons execute application specific features such as skipping stream or cycling between station presets. **DISC/PRESET (1-6) buttons** are associated with station presets when used with the Livio Car Internet Radio application.

iPhone operating system iOS5 enabled application developers to share the “now playing” screen information. For example, when using the Pandora App, you will see artist, album and song information on the radio's screen. When using an application that doesn't implement this feature, or running iOS4, only the name of the application will be shown.

Please note that although iOS 4 (4.2.1) is supported on iPhone 3G and iPod Touch 2nd generation, applications do not run in the background. As such, loading the app takes longer than on devices where the app is present in the background.



If your listening experience is interrupted by a call, under most conditions, the app will resume playback at the end of the call.

Music playback apps running on your iPhone are sent to background automatically when the home button of the phone is pressed, but the music playback itself is not stopped.

To resume playback of your iPod music library, stop Livio playback by tapping on the screen below the Livio Radio logo. An icon representing “stop” will show on the main Livio screen. Press the home button to send the application to the background. (Other apps may need to be terminated manually. Please see next page.)

A few seconds after this, the iPod music playback application will reinitialize itself and become active again if the iPod was locked when it was connected to the kit. (This is indicated by an Accessory Connected message being shown when the iPod icon is tapped.)

If the iPod was in unlocked state when it was connected to the kit, press the play button on the iPod application.

Text display from the Internet Radio App

Text that scrolls across the radio's screen is associated with the stream shown on the radio and displays current song or station information. Stream must be playing before information on the display is updated.

Terminate (kill) the App

If you need to terminate (kill) the app please follow the steps below:

1. Double-tap on the home button of the iPhone to bring up the list of running apps. If you don't see the app's icon right away, swipe the screen left or right to locate it. Note: If you do not see such task bar but rather a music control popup then you have an iOS device that does not support background run of apps, therefore this section is not applicable to you.
2. Press and hold the icon of the app until a red minus icon shows.
3. Tap the red minus icon shown on top of the app.
4. This will close the app.
5. In a few seconds, the iPod music playback app should reinitialize itself and become active again. This can be verified by going back to the list of running apps and swiping the screen until the music control section is shown. The iPod app icon next to the music control sections shows that iPod is your audio source.

Internet Radio App settings

Many radio stations offer lower bitrates. Selecting streams with a lower bitrate will reduce data usage and may reduce stream interruptions during the drive. For example with the Livio Car Internet Radio app, to adjust bitrates manually, users can: Go to the Setting menu of the device, select the Livio Radio settings the change the Maximum Bitrate Filter and set it to 64K. Other settings such as Buffer time and Reliability filter may also help in getting a more stable connection.

Auxiliary audio source (only with optional AUX connector)

The DUO AUX cable (A-ACC-106-AUX) can be used to connect an auxiliary device, such as an MP3 player, DVD player or other audio source.

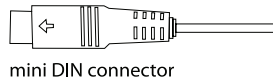
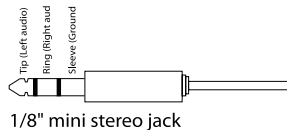
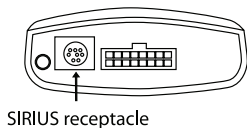

The auxiliary audio source can be accessed in both CDC and SAT emulation modes.

To access AUX audio source:

- Plug the mini DIN connector of the AUX adapter cable into the SIRIUS receptacle and connect the 1/8" mini stereo jack to the sound output of your audio device.
- Enter AUX mode (see pg. 21 or pg.29).
- All music playback is controlled through your audio device.

Optional Remote Kit: Functions for iPod/App

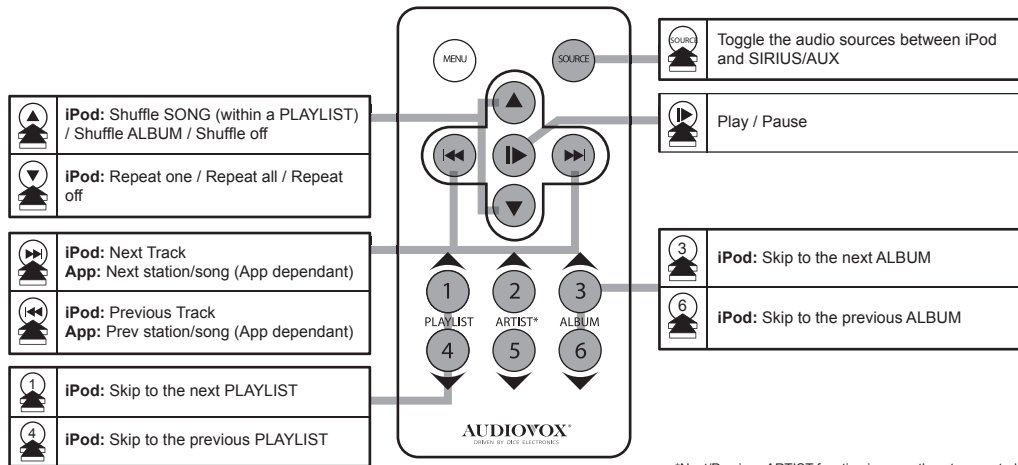

*Next/Previous ARTIST function is currently not supported.

Optional Remote Kit: Wireless Remote Function for SIRIUS

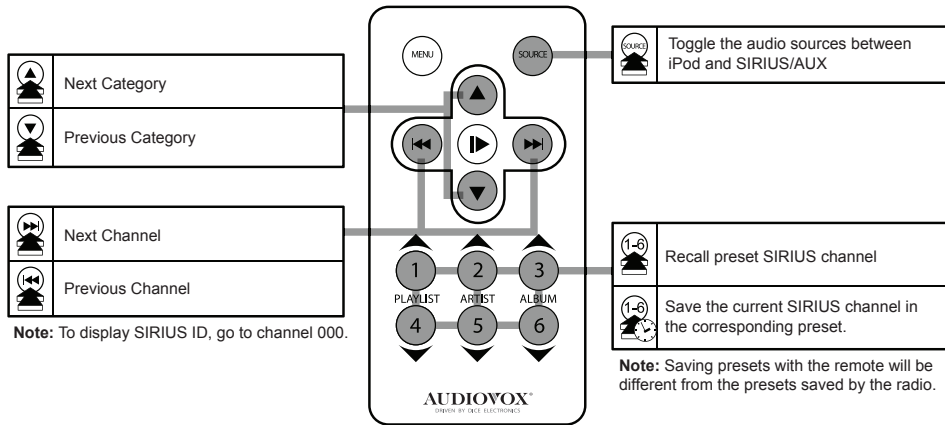

Troubleshooting

Problem	Solution
<p>Cannot select the Silverline DUO interface as an audio source.</p>	<p>Disconnect the vehicle BUS connector from the DUO module for 30 seconds and reconnect. Ensure the vehicle BUS connector is properly connected to the radio and the DUO module. Follow the steps described in the SAT or CDC emulation sections of this manual to access the DUO interface. Make sure ground wire is securely attached to a ground point on the vehicle.</p>
<p>Radio/ steering wheel controls do not operate iPod.</p>	<p>Reset iPod and make sure the most recent iPod firmware is installed. Check vehicle user manual on how steering wheel controls work, long presses may toggle alternate function.</p>
<p>Music is distorted or sound level is too low with iPod connected.</p>	<p>Make sure all EQ and BASS boost options are turned off on your iPod. See pg. 21 (SAT emulation) or pg. 29 (CDC emulation) for additional volume adjustments.</p>
<p>Text is not displaying in SAT emulation.</p>	<p>Make sure DIP switch settings are correctly set for text display. CDC emulation will not display text because the radio does not support text.</p>

Problem	Solution
iPod does not charge.	Check all connections. See if iPod charges while connected to computer or wall charger. You may need to reset the iPod.
Sirius tuner can't be selected.	Ensure the cable connecting SIRIUS tuner is securely connected to the correct receptacle. Only the A-DUO-103-AVW kit is compatible with SIRIUS tuners.
The radio displays track/channel 99 ("TR 99" or "CH99"). Track up/down controls don't work.	Track 99 indicates that the Silverline DUO is in auxiliary audio (AUX) mode. See pg. 21 (SAT emulation mode) or pg. 29 (CDC emulation mode) for how to enter/exit this mode.
Why does category read "PRESELCTD"?	Playback of content selected on the iPod before connected to the interface continues until new content is selected.

Problem	Solution
Why does the message “iPod UNLOCKED” display on screen?	When the Silverline DUO is playing iPod music in UNLOCKED mode, browsing mode information isn't available so the “iPod UNLOCKED” notification is shown. To view information associated with browsing modes, ensure the iPod's hold button is set before connecting it to Silverline DUO.
Why does the radio display show “EMPTY/STOP” and no music plays?	The iPod has reached the end of a playlist. Please select a new Playlist.
Cannot control the iPod or other Duo audio source	If you entered settings mode in CDC emulation and you see anything other than CD1-01, you will need to exit from settings mode by pressing the CD1 button.

Updating Firmware (Mac OS illustrated)



Connect module via mini USB



Device specifications and update selection

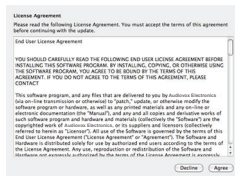

License Agreement (click Agree to proceed)

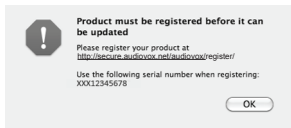

Product registration notification

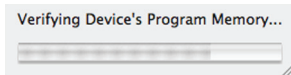

Firmware update progress

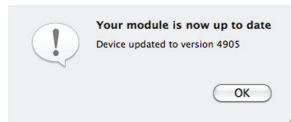

Module updated successfully!

The above screen shots are for illustration purposes only.

AUDIOVOX®

DRIVEN BY DICE ELECTRONICS

**AUDIOVOX®****12 MONTH LIMITED WARRANTY**

AUDIOVOX ELECTRONICS CORP. (the Company) warrants to the original retail purchaser of this product that should this product or any part thereof, under normal use and conditions, be proven defective in material or workmanship within 12 months from the date of original purchase, such defect(s) will be repaired or replaced with reconditioned product (at the Company's option) without charge for parts and repair labor. A game controller, if supplied, is similarly warranted for ninety (90) days.

To obtain repair or replacement within the terms of this Warranty, the product is to be delivered with proof of warranty coverage (e.g. dated bill of sale), specification of defect(s), transportation prepaid, to the Company at the address shown below.

This Warranty does not extend to the elimination of externally generated static or noise, to correction of antenna problems, to costs incurred for installation, removal or reinstallation of the product, or to damage to digital memory/media devices, gaming devices, discs, speakers, accessories, or vehicle electrical systems.

This Warranty does not apply to any product or part thereof which, in the opinion of the Company, has suffered or been damaged through alteration, improper installation, mishandling, misuse, neglect, accident, or by removal or defacement of the factory serial number/bar code label(s). THE EXTENT OF THE COMPANY'S LIABILITY UNDER THIS WARRANTY IS LIMITED TO THE REPAIR OR REPLACEMENT PROVIDED ABOVE AND, IN NO EVENT, SHALL THE COMPANY'S LIABILITY EXCEED THE PURCHASE PRICE PAID BY PURCHASER FOR THE PRODUCT.

This Warranty is in lieu of all other express warranties or liabilities. ANY IMPLIED WARRANTIES, INCLUDING ANY IMPLIED WARRANTY OF MERCHANTABILITY, SHALL BE LIMITED TO THE DURATION OF THIS WRITTEN WARRANTY. ANY ACTION FOR BREACH OF ANY WARRANTY HEREUNDER INCLUDING ANY IMPLIED WARRANTY OF MERCHANTABILITY MUST BE BROUGHT WITHIN A PERIOD OF 24 MONTHS FROM DATE OF ORIGINAL PURCHASE. IN NO CASE SHALL THE COMPANY BE LIABLE FOR ANY CONSEQUENTIAL OR INCIDENTAL DAMAGES FOR BREACH OF THIS OR ANY OTHER WARRANTY. No person or representative is authorized to assume for the Company any liability other than expressed herein in connection with the sale of this product.

Some states do not allow limitations on how long an implied warranty lasts or the exclusion or limitation of incidental or consequential damage so the above limitations or exclusions may not apply to you. This Warranty gives you specific legal rights and you may also have other rights which vary from state to state.

Audiovox Electronics Corporation, 150 Marcus Blvd., Hauppauge, New York 11788 • 1-800-645-4994

128-9032

Installation notes:

Installed by:

Installed date:

Other notes:

Illustration:

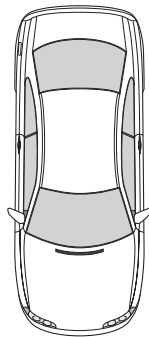

Audi/VW compatible integration
for iPod/iPhone, Internet Radio, SIRIUS and AUX.
www.audiovoxproducts.com

OMA-DUO-100-AVW-012012



For Customer Service
Visit Our Website At
www.audiovoxproducts.com
Product Information, Photos,
FAQ's, Owner's Manuals



AUDIOVOX
ELECTRONICS CORP.

150 Marcus Blvd., Hauppauge, New York 11788
©2012 Made in China • Fabriqué en Chine • Hecho en China



SAVE ENVIRONMENT
PLEASE RECYCLE
•
ÉCONOMISER L'ENVIRONNEMENT
RECYCLEZ S'IL VOUS PLAÎT
•
EXCEPTO EL AMBIENTE
RECICLE POR FAVOR