

FOREWORD

This wiring diagram manual has been prepared to provide information on the electrical system of the 1999 CAMRY.

Applicable models: MCV20 Series
SXV20 Series

For service specifications and repair procedures of the above models other than those listed in this manual, refer to the following manuals;

Manual Name	Pub. No.
◦ 1999 CAMRY Repair Manual Volume 1 Volume 2	RM654U1 RM654U2
◦ 1999 TOYOTA New Car Features	NCF160U

All information in this manual is based on the latest product information at the time of publication. However, specifications and procedures are subject to change without notice.

TOYOTA MOTOR CORPORATION

NOTICE

When handling supplemental restraint system components (removal, installation or inspection, etc.), always follow the direction given in the repair manuals listed above to prevent accidents and supplemental restraint system malfunction.

A INTRODUCTION

This manual consists of the following 12 sections:

No.	Section	Description
A	INDEX	Index of the contents of this manual.
	INTRODUCTION	Brief explanation of each section.
B	HOW TO USE THIS MANUAL	Instructions on how to use this manual.
C	TROUBLE-SHOOTING	Describes the basic inspection procedures for electrical circuits.
D	ABBREVIATIONS	Defines the abbreviations used in this manual.
E	GLOSSARY OF TERMS AND SYMBOLS	Defines the symbols and functions of major parts.
F	RELAY LOCATIONS	Shows position of the Electronic Control Unit, Relays, Relay Block, etc. This section is closely related to the system circuit.
G	ELECTRICAL WIRING ROUTING	Describes position of Parts Connectors, Splice points, Ground points, etc. This section is closely related to the system circuit.
H	INDEX	Index of the system circuits.
	SYSTEM CIRCUITS	Electrical circuits of each system are shown from the power supply through ground points. Wiring connections and their positions are shown and classified by code according to the connection method. (Refer to the section, "How to use this manual"). The "System Outline" and "Service Hints" useful for troubleshooting are also contained in this section.
I	GROUND POINTS	Shows ground positions of all parts described in this manual.
J	OVERALL ELECTRICAL WIRING DIAGRAM	Provides circuit diagrams showing the circuit connections.
K	POWER SOURCE (Current Flow Chart)	Describes power distribution from the power supply to various electrical loads.
L	PART NUMBER OF CONNECTORS	Indicates the part number of the connectors used in this manual.

HOW TO USE THIS MANUAL B

This manual provides information on the electrical circuits installed on vehicles by dividing them into a circuit for each system.

The actual wiring of each system circuit is shown from the point where the power source is received from the battery as far as each ground point. (All circuit diagrams are shown with the switches in the OFF position.)

When troubleshooting any problem, first understand the operation of the circuit where the problem was detected (see System Circuit section), the power source supplying power to that circuit (see Power Source section), and the ground points (see Ground Points section). See the System Outline to understand the circuit operation.

When the circuit operation is understood, begin troubleshooting of the problem circuit to isolate the cause. Use Relay Location and Electrical Wiring Routing sections to find each part, junction block and wiring harness connectors, wiring harness and wiring harness connectors, splice points, and ground points of each system circuit. Internal wiring for each junction block is also provided for better understanding of connection within a junction block.

Wiring related to each system is indicated in each system circuit by arrows (from__, to__). When overall connections are required, see the Overall Electrical Wiring Diagram at the end of this manual.

B HOW TO USE THIS MANUAL

* The system shown here is an EXAMPLE ONLY. It is different to the actual circuit shown in the SYSTEM CIRCUITS SECTION.

[A] STOP LIGHT

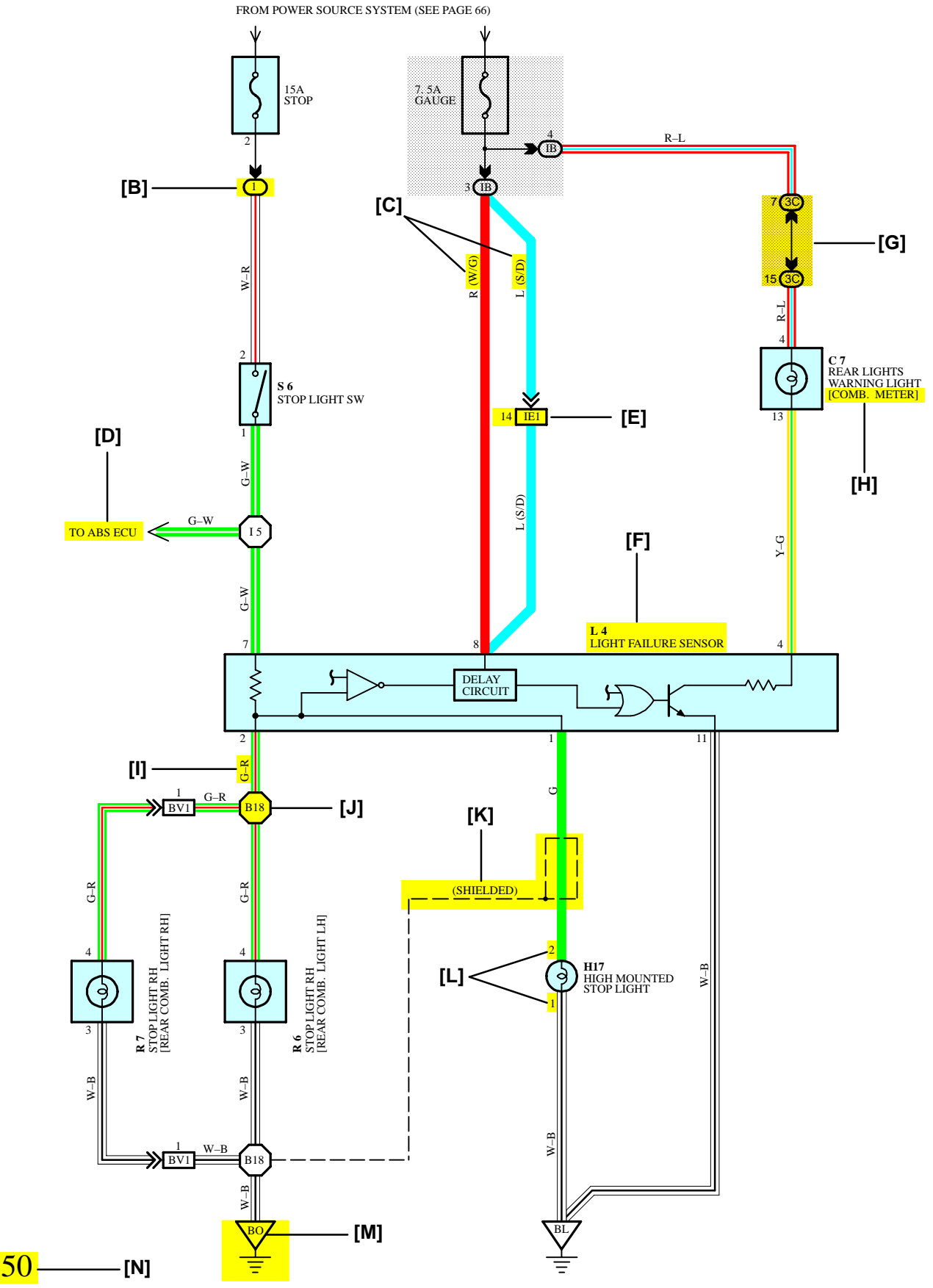

[A] : System Title

[B] : Indicates a Relay Block. No shading is used and only the Relay Block No. is shown to distinguish it from the J/B

Example : ① Indicates Relay Block No.1

[C] : () is used to indicate different wiring and connector, etc. when the vehicle model, engine type, or specification is different.

[D] : Indicates related system.

[E] : Indicates the wiring harness and wiring harness connector. The wiring harness with male terminal is shown with arrows (⇨). Outside numerals are pin numbers.

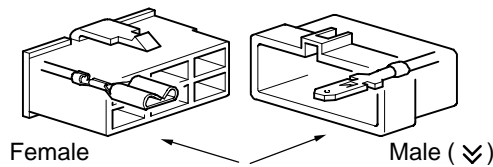

The first letter of the code for each wiring harness and wiring harness connector(s) indicates the component's location, e.g, "E" for the Engine Compartment, "I" for the Instrument Panel and Surrounding area, and "B" for the Body and Surrounding area.

When more than one code has the first and second letters in common, followed by numbers (e.g, IH1, IH2), this indicates the same type of wiring harness and wiring harness connector.

[F] : Represents a part (all parts are shown in sky blue). The code is the same as the code used in parts position.

[G] : Junction Block (The number in the circle is the J/B No. and the connector code is shown beside it). Junction Blocks are shaded to clearly separate them from other parts.

Example:

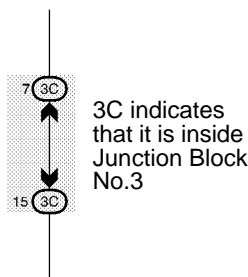

[H] : When 2 parts both use one connector in common, the parts connector name used in the wire routing section is shown in square brackets [] .

[I] : Indicates the wiring color.

Wire colors are indicated by an alphabetical code.

- B = Black W = White BR = Brown
- L = Blue V = Violet SB = Sky Blue
- R = Red O = Orange LG = Light Green
- P = Pink Y = Yellow GR = Gray
- G = Green

The first letter indicates the basic wire color and the second letter indicates the color of the stripe.

Example: L - Y

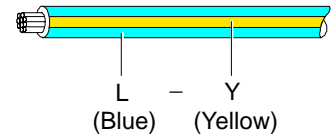

[J] : Indicates a wiring Splice Point (Codes are "E" for the Engine Room, "I" for the Instrument Panel, and "B" for the Body).

Example:

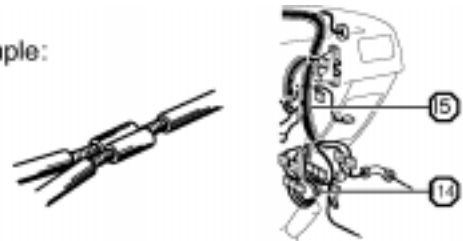

The Location of splice Point I 5 is indicated by the shaded section.

[K] : Indicates a shielded cable.



[L] : Indicates the pin number of the connector. The numbering system is different for female and male connectors.

Example : Numbered in order from upper left to lower right

Numbered in order from upper right to lower left

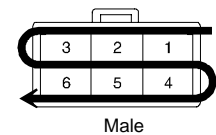
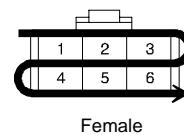

[M] : Indicates a ground point.

The first letter of the code for each ground point(s) indicates the component's location, e.g, "E" for the Engine Compartment, "I" for the Instrument Panel and Surrounding area, and "B" for the Body and Surrounding area.

[N] : Page No.

B HOW TO USE THIS MANUAL

[O] SYSTEM OUTLINE

Current is applied at all times through the STOP fuse to TERMINAL 2 of the stop light SW.
 When the ignition SW is turned on, current flows from the GAUGE fuse to TERMINAL 8 of the light failure sensor, and also flows through the rear lights warning light to TERMINAL 4 of the light failure sensor.

STOP LIGHT DISCONNECTION WARNING

When the ignition SW is turned on and the brake pedal is pressed (Stop light SW on), if the stop light circuit is open, the current flowing from TERMINAL 7 of the light failure sensor to TERMINALS 1, 2 changes, so the light failure sensor detects the disconnection and the warning circuit of the light failure sensor is activated.

As a result, the current flows from TERMINAL 4 of the light failure sensor to TERMINAL 11 to GROUND and turns the rear lights warning light on. By pressing the brake pedal, the current flowing to TERMINAL 8 of the light failure sensor keeps the warning circuit on and holds the warning light on until the ignition SW is turned off.

[P] SERVICE HINTS

S6 STOP LIGHT SW

2-1 : Closed with the brake pedal depressed

L4 LIGHT FAILURE SENSOR

1, 2, 7-GROUND : Approx. 12 volts with the stop light SW on

4, 8-GROUND : Approx. 12 volts with the ignition SW at ON position

11-GROUND : Always continuity

[Q] PARTS LOCATION

Code	See Page	Code	See Page	Code	See Page
C7	34	L4	36	R7	37
H17	36	R6	37	S6	35

[R] RELAY BLOCKS

Code	See Page	Relay Blocks (Relay Block Location)
1	18	R/B No.1 (Instrument Panel Left)

[S] JUNCTION BLOCK AND WIRE HARNESS CONNECTOR

Code	See Page	Junction Block and Wire Harness (Connector Location)
IB	20	Instrument Panel Wire and Instrument Panel J/B (Lower Finish Panel)
3C	22	Instrument Panel Wire and J/B No.3 (Instrument Panel Left Side)

[T] CONNECTOR JOINING WIRE HARNESS AND WIRE HARNESS

Code	See Page	Joining Wire Harness and Wire Harness (Connector Location)
IE1	42	Floor Wire and Instrument Panel Wire (Left Kick Panel)
BV1	50	Luggage Room Wire and Floor Wire (Luggage Compartment Left)

[U] GROUND POINTS

Code	See Page	Ground Points Location
BL	50	Under the Left Quarter Pillar
BO	50	Back Panel Center

[V] SPLICE POINTS

Code	See Page	Wire Harness with Splice Points	Code	See Page	Wire Harness with Splice Points
I5	44	Cowl Wire	B18	50	Luggage Room Wire

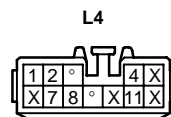
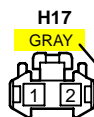
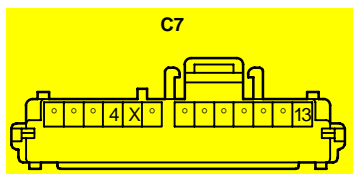

[X]

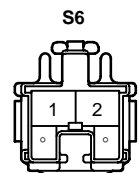

[O] : Explains the system outline.

[P] : Indicates values or explains the function for reference during troubleshooting.

[Q] : Indicates the reference page showing the position on the vehicle of the parts in the system circuit.

Example : Part "L4" (Light Failure Sensor) is on page 36 of the manual.

* The letter in the code is from the first letter of the part, and the number indicates its order in parts starting with that letter.

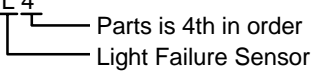
Example : L 4

[R] : Indicates the reference page showing the position on the vehicle of Relay Block Connectors in the system circuit.

Example : Connector "1" is described on page 18 of this manual and is installed on the left side of the instrument panel.

[S] : Indicates the reference page showing the position on the vehicle of J/B and Wire Harness in the system circuit.

Example : Connector "3C" connects the Instrument Panel Wire and J/B No.3. It is described on page 22 of this manual, and is installed on the instrument panel left side.

[T] : Indicates the reference page describing the wiring harness and wiring harness connector (the female wiring harness is shown first, followed by the male wiring harness).

Example : Connector "IE1" connects the floor wire (female) and Instrument panel wire (male). It is described on page 42 of this manual, and is installed on the left side kick panel.

[U] : Indicates the reference page showing the position of the ground points on the vehicle.

Example : Ground point "BO" is described on page 50 of this manual and is installed on the back panel center.

[V] : Indicates the reference page showing the position of the splice points on the vehicle.

Example : Splice point "I5" is on the Cowl Wire Harness and is described on page 44 of this manual.

[W]: Indicates connector to be connected to a part (the numeral indicates the pin No.) Explanation of pin use.

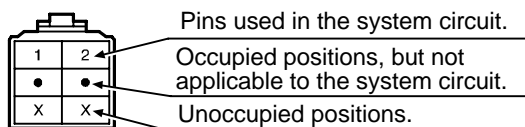

[X] : The pins shown are only for the highest grade, or only include those in the specification.
 Connector Color
 Connectors not indicated are milky white in color.

HINT :

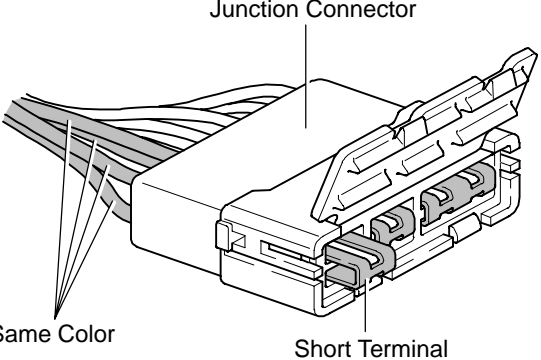

Junction Connector

Short Terminal

Same Color

Junction connector (code: J1 to J40) in this manual include a short terminal which is connected to a number of wire harnesses. Always perform inspection with the short terminal installed. (When installing the wire harnesses, the harnesses can be connected to any position within the short terminal grouping. Accordingly, in other vehicles, the same position in the short terminal may be connected to a wire harness from a different part.)
 Wire harness sharing the same short terminal grouping have the same color.

B HOW TO USE THIS MANUAL

The ground points circuit diagram shows the connections from all major parts to the respective ground points. When troubleshooting a faulty ground point, checking the system circuits which use a common ground may help you identify the problem ground quickly. The relationship between ground points (∇_{EA} , ∇_{IB} and ∇_{IC} shown below) can also be checked this way.

I GROUND POINT

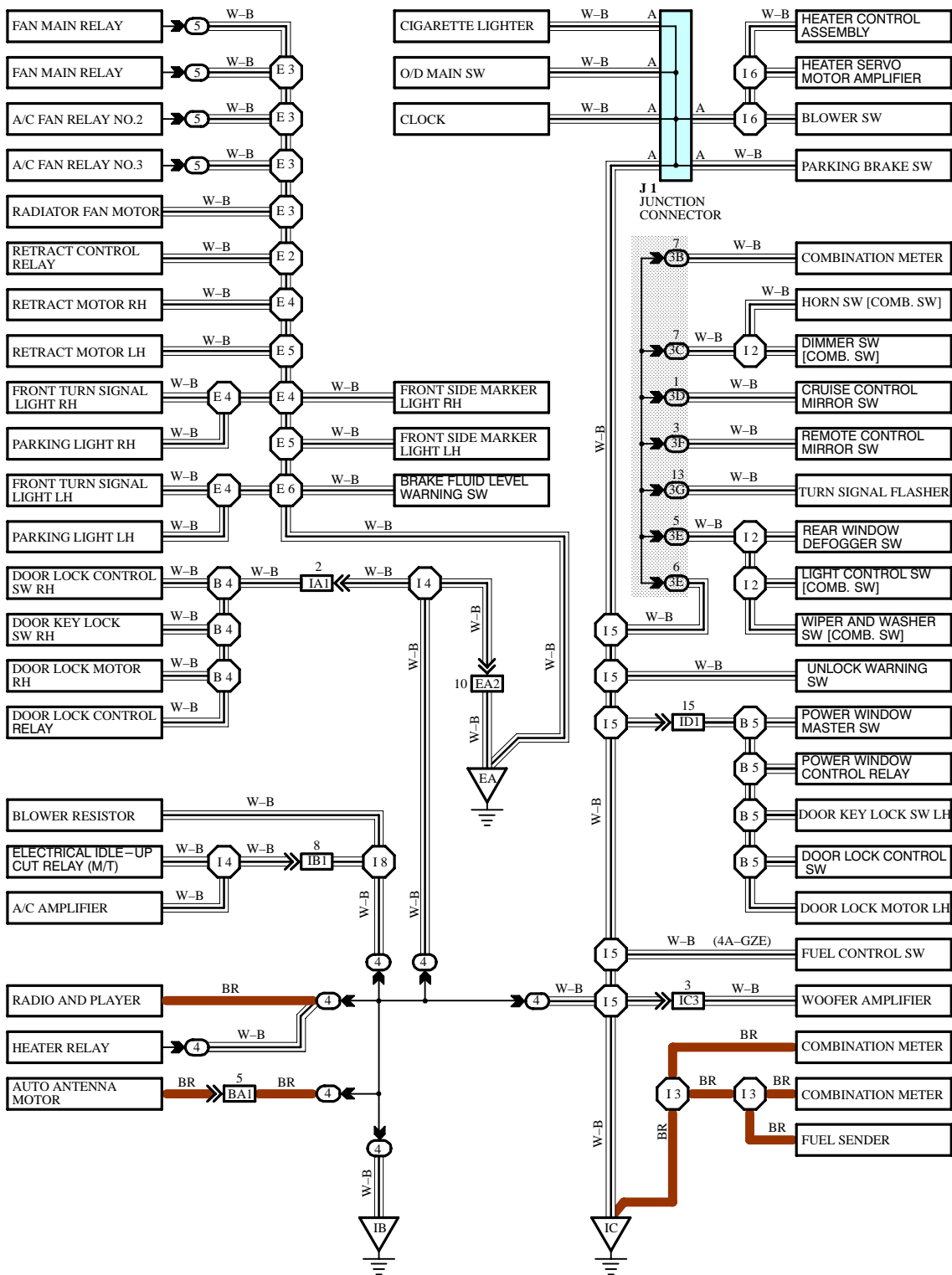

* The system shown here is an EXAMPLE ONLY. It is different to the actual circuit shown in the SYSTEM CIRCUITS SECTION.

The "Current Flow Chart" section, describes which parts each power source (fuses, fusible links, and circuit breakers) transmits current to. In the Power Source circuit diagram, the conditions when battery power is supplied to each system are explained. Since all System Circuit diagrams start from the power source, the power source system must be fully understood.

K POWER SOURCE (Current Flow Chart)

The chart below shows the route by which current flows from the battery to each electrical source (Fusible Link, Circuit Breaker, Fuse, etc.) and other parts.

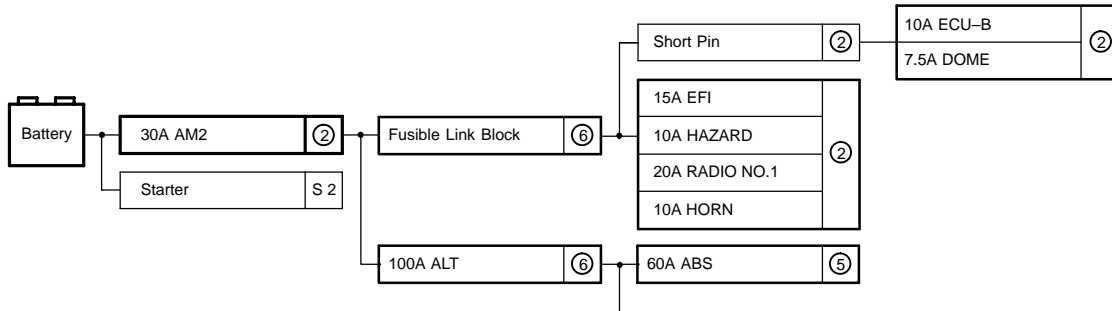

Engine Room R/B (See Page 20)

Fuse	System	Page	
20A	STOP	ABS	194
		ABS and Traction Control	187
		Cruise Control	180
		Electronically Controlled Transmission and A/T Indicator	166
		Multiplex Communication System	210
10A	DOME	Cigarette Lighter and Clock	214
		Combination Meter	230
		Headlight	112
		Interior Light	122
		Key Reminder and Seat Belt Warning	
		Light Auto Turn Off	

POWER SOURCE

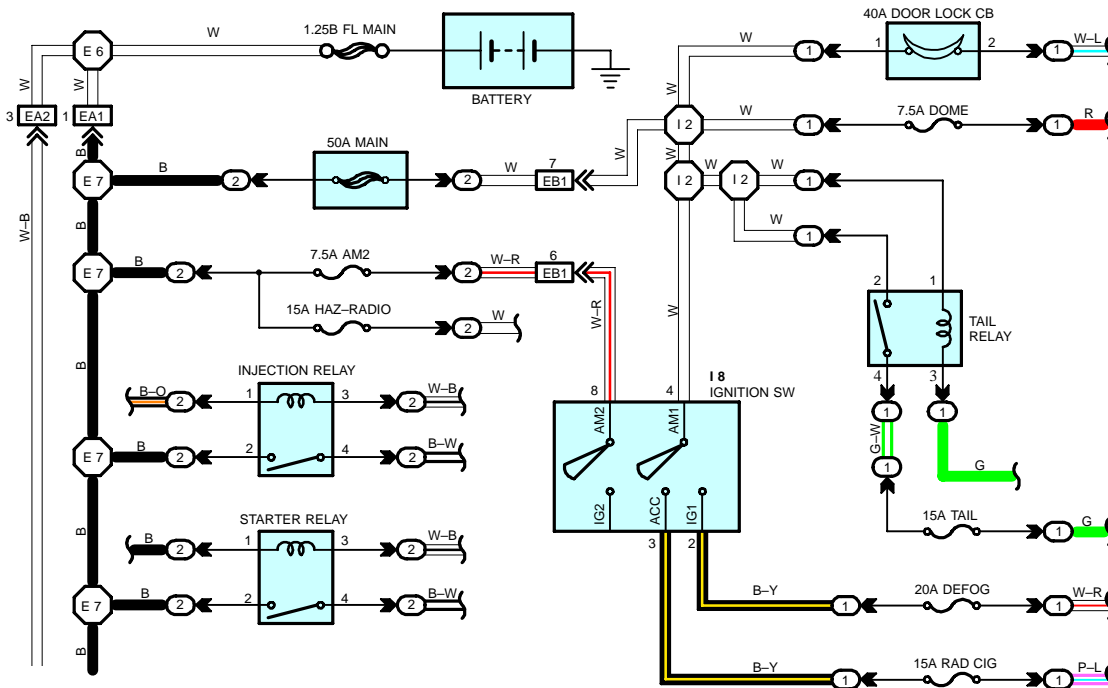

* The system shown here is an EXAMPLE ONLY. It is different to the actual circuit shown in the SYSTEM CIRCUITS SECTION.

C TROUBLESHOOTING

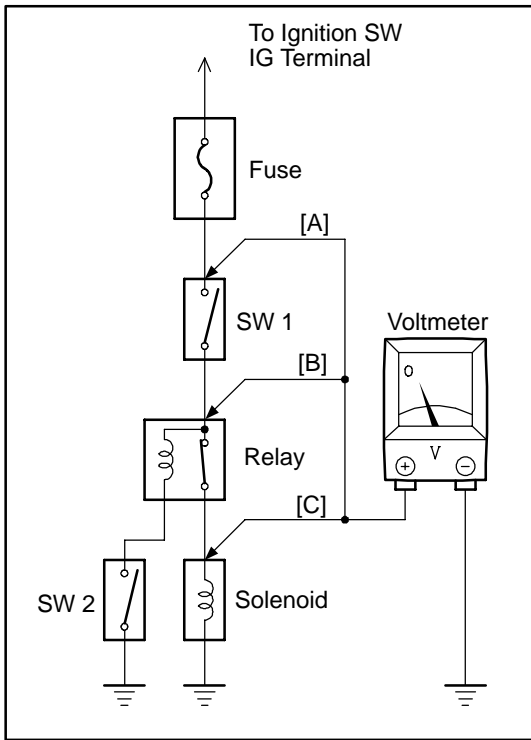

VOLTAGE CHECK

- (a) Establish conditions in which voltage is present at the check point.

Example:

- [A] – Ignition SW on
- [B] – Ignition SW and SW 1 on
- [C] – Ignition SW, SW 1 and Relay on (SW 2 off)

- (b) Using a voltmeter, connect the negative lead to a good ground point or negative battery terminal, and the positive lead to the connector or component terminal.

This check can be done with a test light instead of a voltmeter.

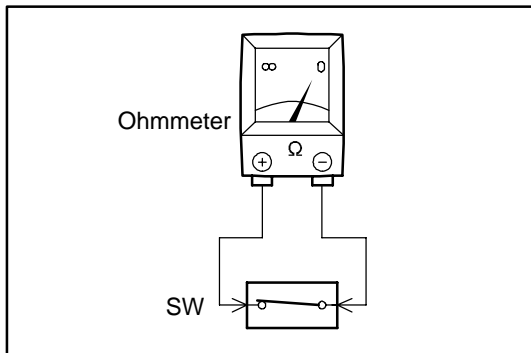

CONTINUITY AND RESISTANCE CHECK

- (a) Disconnect the battery terminal or wire so there is no voltage between the check points.
- (b) Contact the two leads of an ohmmeter to each of the check points.

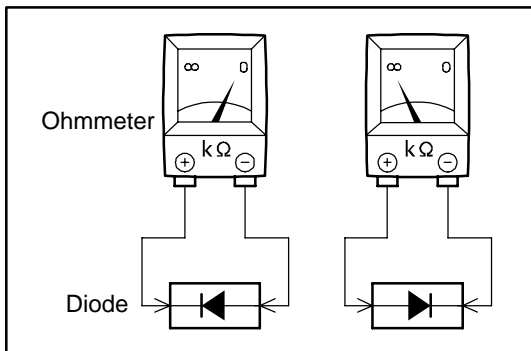

If the circuit has diodes, reverse the two leads and check again.

When contacting the negative lead to the diode positive side and the positive lead to the negative side, there should be continuity.

When contacting the two leads in reverse, there should be no continuity.

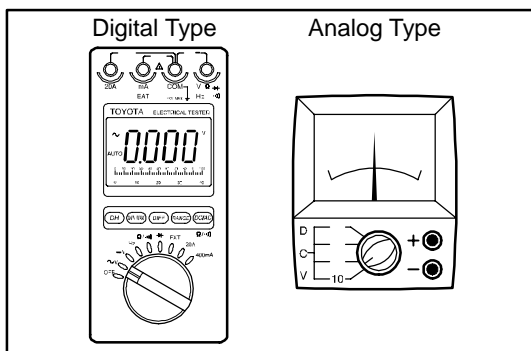

- (c) Use a volt/ohmmeter with high impedance (10 k Ω /V minimum) for troubleshooting of the electrical circuit.

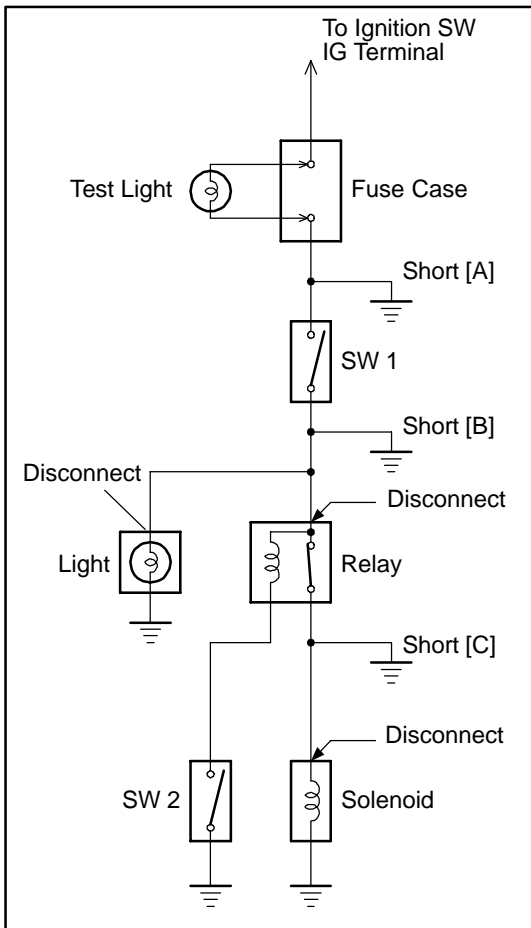

FINDING A SHORT CIRCUIT

- Remove the blown fuse and disconnect all loads of the fuse.
- Connect a test light in place of the fuse.
- Establish conditions in which the test light comes on.

Example:

- [A] – Ignition SW on
- [B] – Ignition SW and SW 1 on
- [C] – Ignition SW, SW 1 and Relay on (Connect the Relay) and SW 2 off (or Disconnect SW 2)

- Disconnect and reconnect the connectors while watching the test light. The short lies between the connector where the test light stays lit and the connector where the light goes out.
- Find the exact location of the short by lightly shaking the problem wire along the body.

CAUTION:

- Do not open the cover or the case of the ECU unless absolutely necessary. (If the IC terminals are touched, the IC may be destroyed by static electricity.)
- When replacing the internal mechanism (ECU part) of the digital meter, be careful that no part of your body or clothing comes in contact with the terminals of leads from the IC, etc. of the replacement part (spare part).

DISCONNECTION OF MALE AND FEMALE CONNECTORS

To pull apart the connectors, pull on the connector itself, not the wire harness.

HINT: Check to see what kind of connector you are disconnecting before pulling apart.

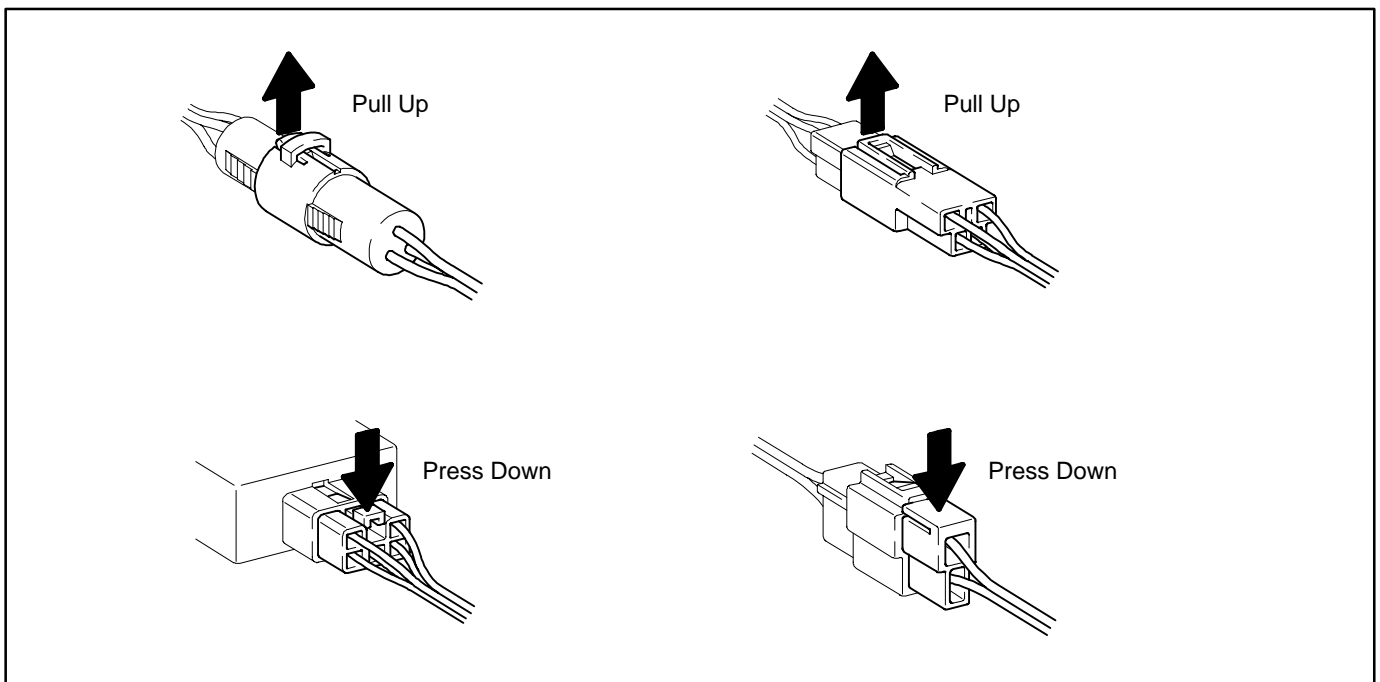

C TROUBLESHOOTING

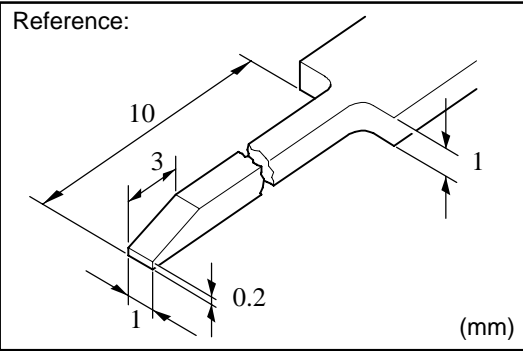

HOW TO REPLACE TERMINAL (with terminal retainer or secondary locking device)

1. PREPARE THE SPECIAL TOOL

HINT : To remove the terminal from the connector, please construct and use the special tool or like object shown on the left.

2. DISCONNECT CONNECTOR

3. DISENGAGE THE SECONDARY LOCKING DEVICE OR TERMINAL RETAINER.

(a) Locking device must be disengaged before the terminal locking clip can be released and the terminal removed from the connector.

(b) Use a special tool or the terminal pick to unlock the secondary locking device or terminal retainer.

NOTICE:

Do not remove the terminal retainer from connector body.

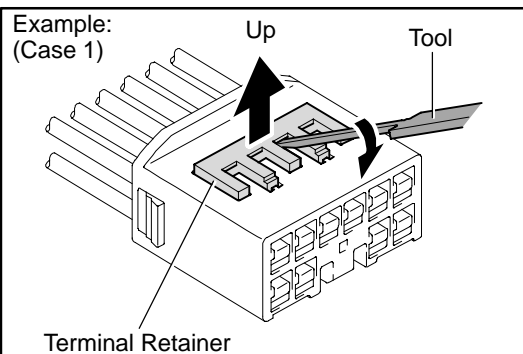

[A] For Non-Waterproof Type Connector

HINT : The needle insertion position varies according to the connector's shape (number of terminals etc.), so check the position before inserting it.

"Case 1"

Raise the terminal retainer up to the temporary lock position.

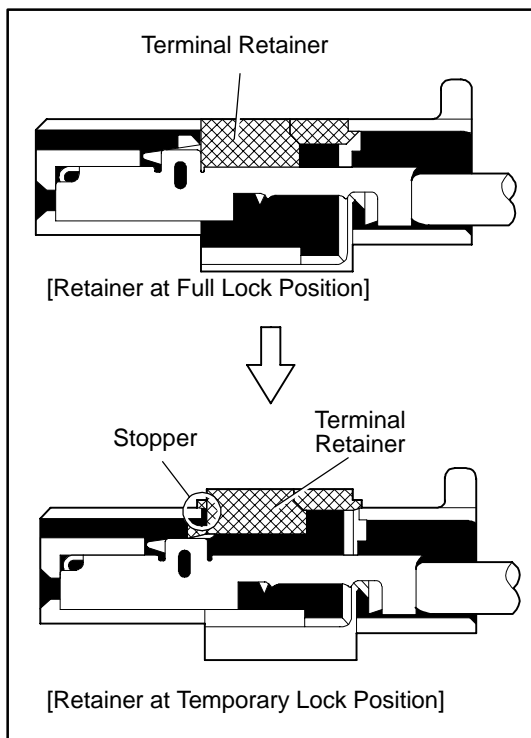

"Case 2"

Open the secondary locking device.

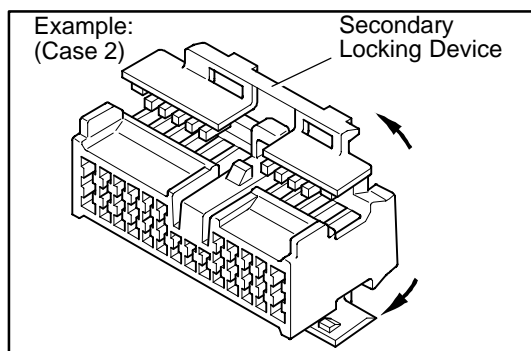

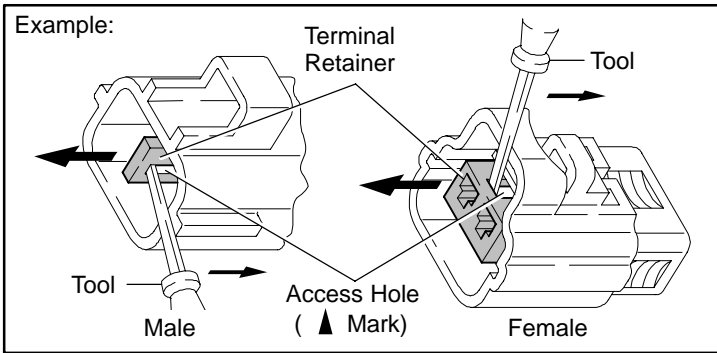
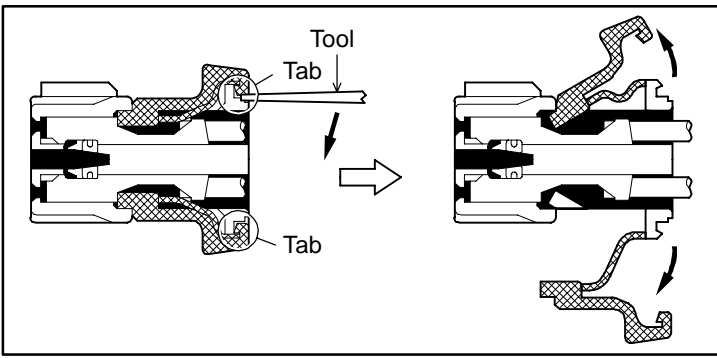

[B] For Waterproof Type Connector

HINT : Terminal retainer color is different according to connector body.

Example:

Terminal Retainer : Connector Body

Black or White : Gray

Black or White : Dark Gray

Gray or White : Black

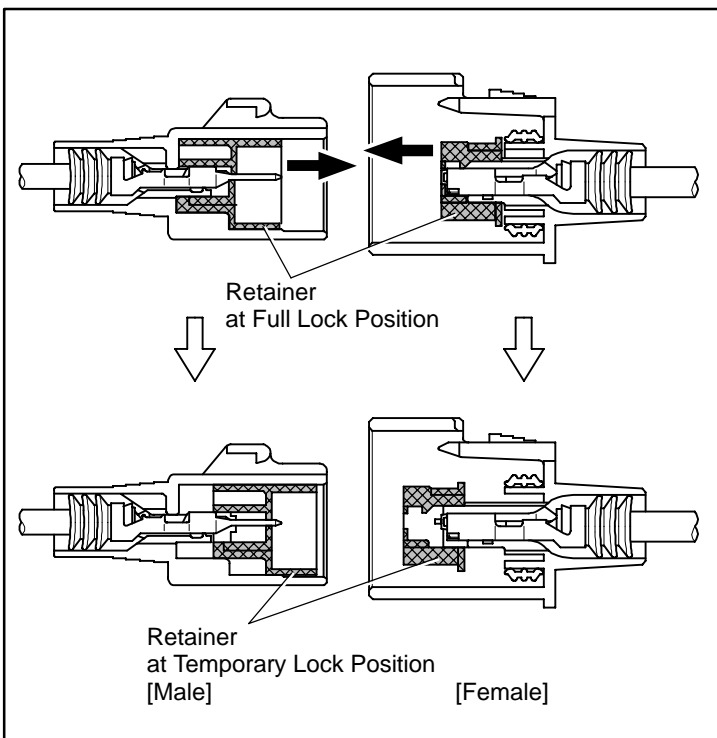

"Case 1"

Type where terminal retainer is pulled up to the temporary lock position (Pull Type).

Insert the special tool into the terminal retainer access hole (° Mark) and pull the terminal retainer up to the temporary lock position.

HINT : The needle insertion position varies according to the connector's shape (Number of terminals etc.), so check the position before inserting it.

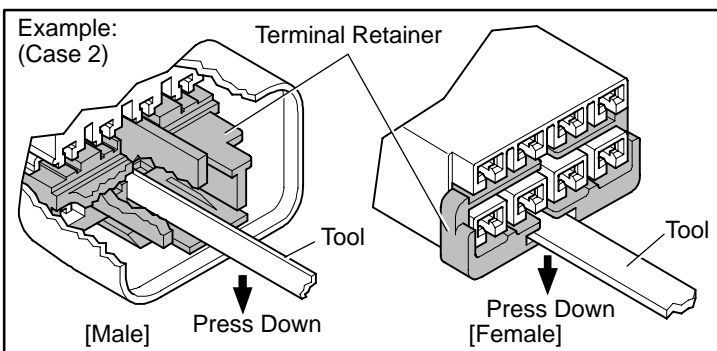

"Case 2"

Type which cannot be pulled as far as Power Lock insert the tool straight into the access hole of terminal retainer as shown.

C TROUBLESHOOTING

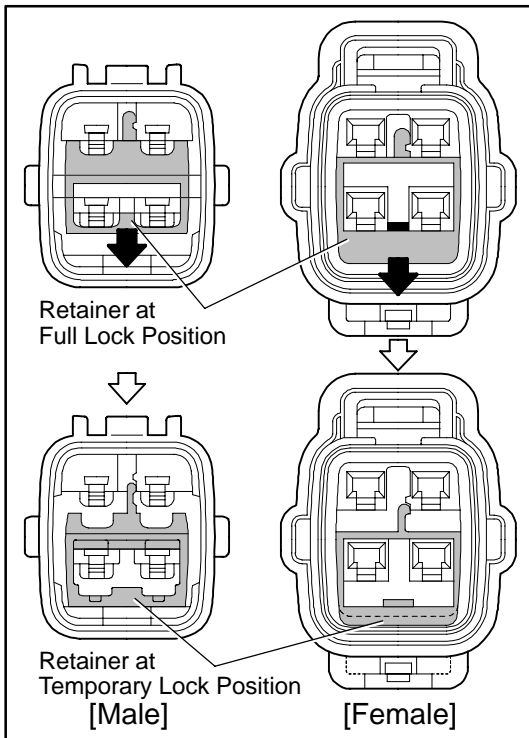

Push the terminal retainer down to the temporary lock position.

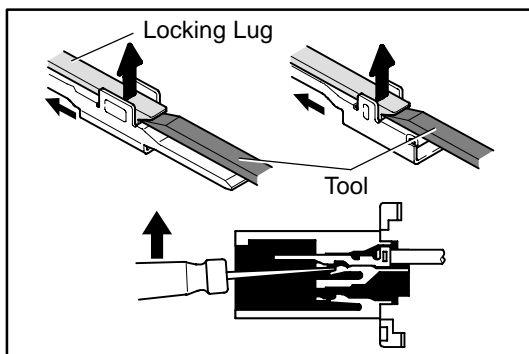

(c) Release the locking lug from terminal and pull the terminal out from rear.

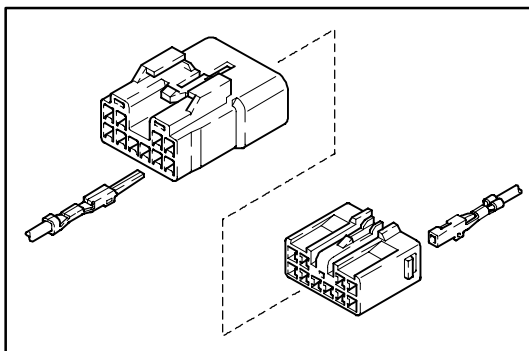

4. INSTALL TERMINAL TO CONNECTOR

(a) Insert the terminal.

HINT:

1. Make sure the terminal is positioned correctly.
2. Insert the terminal until the locking lug locks firmly.
3. Insert the terminal with terminal retainer in the temporary lock position.

(b) Push the secondary locking device or terminal retainer in to the full lock position.

5. CONNECT CONNECTOR

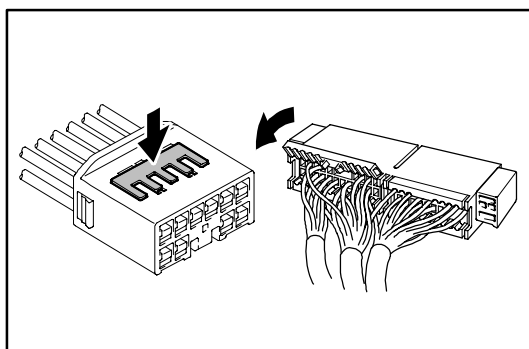











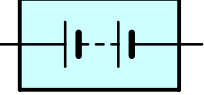

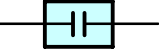
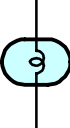



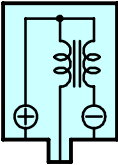

ABBREVIATIONS



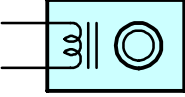

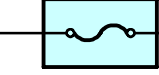
The following abbreviations are used in this manual.

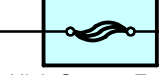
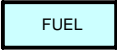
ABS	=	Anti-Lock Brake System
A/C	=	Air Conditioning
ACIS	=	Acoustic Control Induction System
A/T	=	Automatic Transaxle
COMB.	=	Combination
ECU	=	Electronic Control Unit
EGR	=	Exhaust Gas Recirculation
ESA	=	Electronic Spark Advance
EVAP	=	Evaporative Emission
FL	=	Fusible Link
J/B	=	Junction Block
LH	=	Left-Hand
M/T	=	Manual Transaxle
O/D	=	Overdrive
R/B	=	Relay Block
RH	=	Right-Hand
SFI	=	Sequential Multiport Fuel Injection
SRS	=	Supplemental Restraint System
SW	=	Switch
TEMP.	=	Temperature
VSV	=	Vacuum Switching Valve
w/	=	With
w/o	=	Without

* The titles given inside the components are the names of the terminals (terminal codes) and are not treated as being abbreviations.

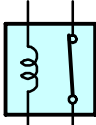
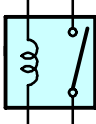
E GLOSSARY OF TERMS AND SYMBOLS

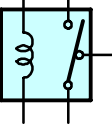
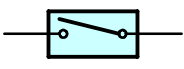
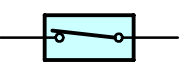
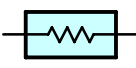
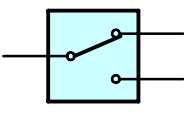
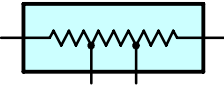
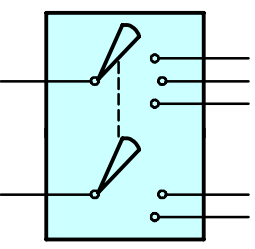
 <p>BATTERY Stores chemical energy and converts it into electrical energy. Provides DC current for the auto's various electrical circuits.</p>	 <p>GROUND The point at which wiring attaches to the Body, thereby providing a return path for an electrical circuit; without a ground, current cannot flow.</p>
 <p>CAPACITOR (Condenser) A small holding unit for temporary storage of electrical voltage.</p>	<p>HEADLIGHTS Current flow causes a headlight filament to heat up and emit light. A headlight may have either a single (1) filament or a double (2) filament</p> <p>1. SINGLE FILAMENT</p>  <p>2. DOUBLE FILAMENT</p> 
 <p>CIGARETTE LIGHTER An electric resistance heating element.</p>	
 <p>CIRCUIT BREAKER Basically a reusable fuse, a circuit breaker will heat and open if too much current flows through it. Some units automatically reset when cool, others must be manually reset.</p>	 <p>HORN An electric device which sounds a loud audible signal.</p>
 <p>DIODE A semiconductor which allows current flow in only one direction.</p>	 <p>IGNITION COIL Converts low-voltage DC current into high-voltage ignition current for firing the spark plugs.</p>
 <p>DIODE, ZENER A diode which allows current flow in one direction but blocks reverse flow only up to a specific voltage. Above that potential, it passes the excess voltage. This acts as a simple voltage regulator.</p>	 <p>LIGHT Current flow through a filament causes the filament to heat up and emit light.</p>
 <p>PHOTODIODE The photodiode is a semiconductor which controls the current flow according to the amount of light.</p>	 <p>LED (LIGHT EMITTING DIODE) Upon current flow, these diodes emit light without producing the heat of a comparable light.</p>
 <p>DISTRIBUTOR, IIA Channels high-voltage current from the ignition coil to the individual spark plugs.</p>	 <p>METER, ANALOG Current flow activates a magnetic coil which causes a needle to move, thereby providing a relative display against a background calibration.</p>
 <p>FUSE A thin metal strip which burns through when too much current flows through it, thereby stopping current flow and protecting a circuit from damage.</p>  <p>FUSIBLE LINK A heavy-gauge wire placed in high amperage circuits which burns through on overloads, thereby protecting the circuit. The numbers indicate the cross-section surface area of the wires.</p> <p>(for Medium Current Fuse)</p>  <p>(for High Current Fuse or Fusible Link)</p>	 <p>METER, DIGITAL Current flow activates one or many LED's, LCD's, or fluorescent displays, which provide a relative or digital display.</p>
	 <p>MOTOR A power unit which converts electrical energy into mechanical energy, especially rotary motion.</p>

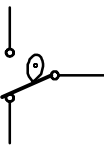
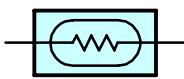
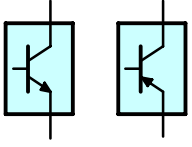
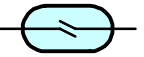
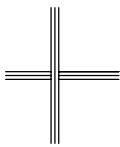
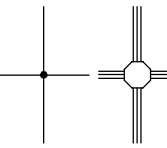
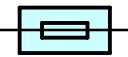
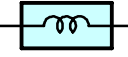
 <p>RELAY Basically, an electrically operated switch which may be normally closed (1) or open (2). Current flow through a small coil creates a magnetic field which either opens or closes an attached switch.</p> <p>1. NORMALLY CLOSED</p>  <p>2. NORMALLY OPEN</p>	 <p>SPEAKER An electromechanical device which creates sound waves from current flow.</p>
 <p>RELAY, DOUBLE THROW A relay which passes current through one set of contacts or the other.</p>	<p>SWITCH, MANUAL Opens and closes circuits, thereby stopping (1) or allowing (2) current flow.</p>  <p>1. NORMALLY OPEN</p>  <p>2. NORMALLY CLOSED</p>
 <p>RESISTOR An electrical component with a fixed resistance, placed in a circuit to reduce voltage to a specific value.</p>	<p>SWITCH, DOUBLE THROW A switch which continuously passes current through one set of contacts or the other.</p> 
 <p>RESISTOR, TAPPED A resistor which supplies two or more different non adjustable resistance values.</p>	<p>SWITCH, IGNITION A key operated switch with several positions which allows various circuits, particularly the primary ignition circuit, to become operational.</p> 
 <p>RESISTOR, VARIABLE or RHEOSTAT A controllable resistor with a variable rate of resistance. Also called a potentiometer or rheostat.</p>	<p>SWITCH, WIPER PARK Automatically returns wipers to the stop position when the wiper switch is turned off.</p> 
 <p>SENSOR (Thermistor) A resistor which varies its resistance with temperature.</p>	<p>TRANSISTOR A solidstate device typically used as an electronic relay; stops or passes current depending on the voltage applied at "base".</p> 
 <p>SENSOR, SPEED Uses magnetic impulses to open and close a switch to create a signal for activation of other components. (Reed Switch Type)</p>	<p>WIRES</p>  <p>(1) NOT CONNECTED</p>  <p>(2) SPLICED</p> <p>Wires are always drawn as straight lines on wiring diagrams. Crossed wires (1) without a black dot at the junction are not joined; crossed wires (2) with a black dot or octagonal mark at the junction are spliced (joined) connections.</p>
 <p>SHORT PIN Used to provide an unbroken connection within a junction block.</p>	
 <p>SOLENOID An electromagnetic coil which forms a magnetic field when current flows, to move a plunger, etc.</p>	

F RELAY LOCATIONS

[Engine Compartment]

- *1 : TMC Made w/ ABS, w/ ABS and Traction Control or TMMK Made w/ ABS and Traction Control
- *2 : TMMK Made w/ ABS w/o Traction Control

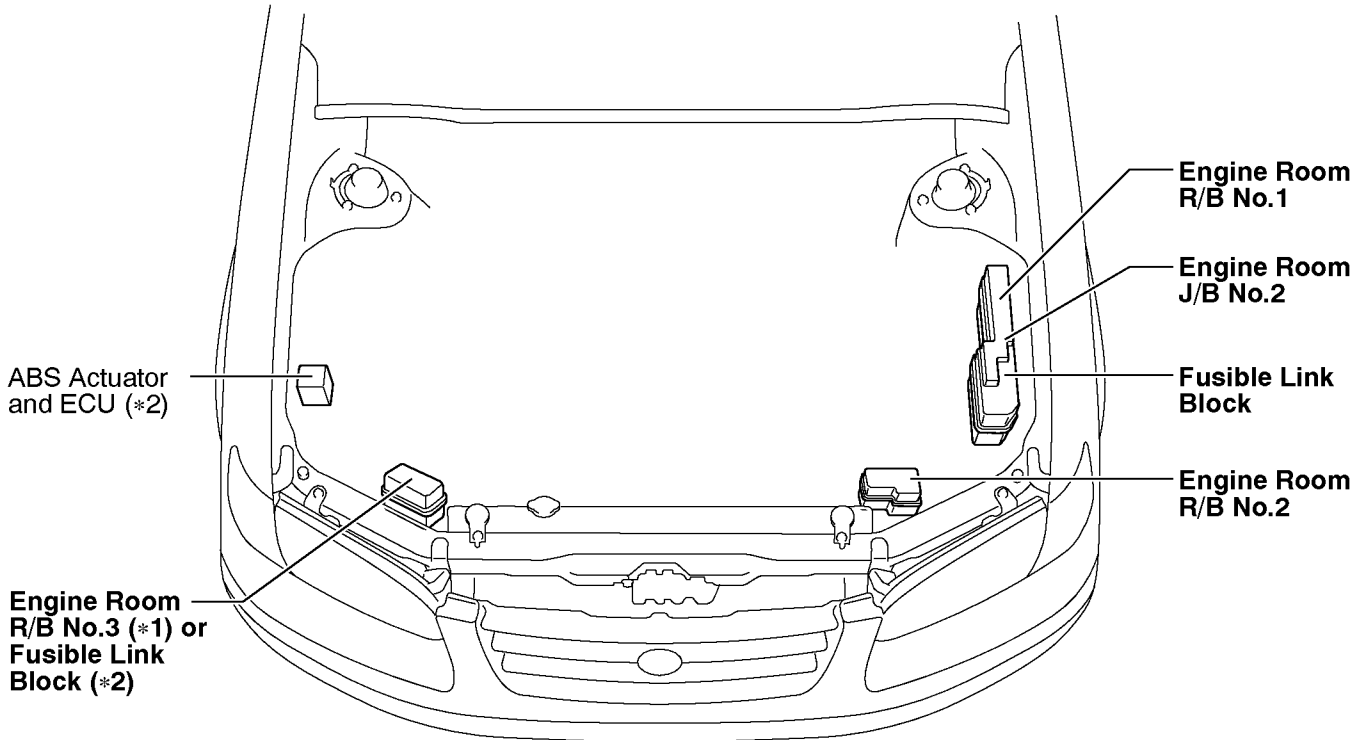

[Body]

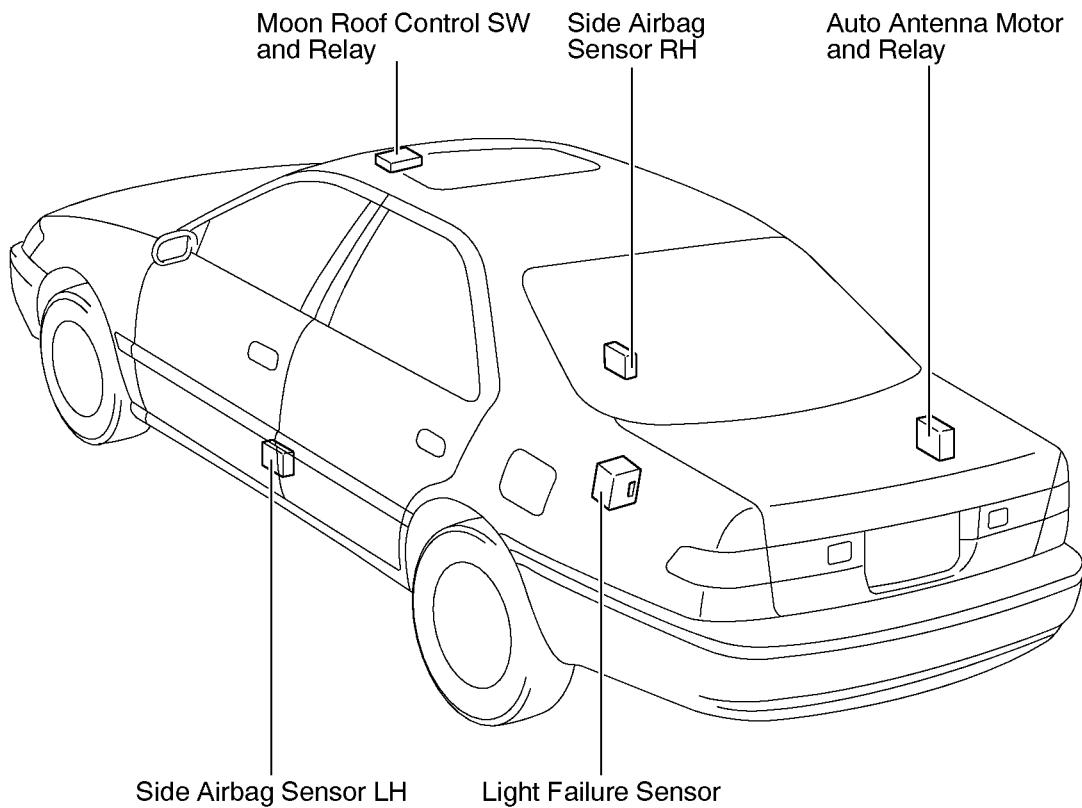

[Instrument Panel]

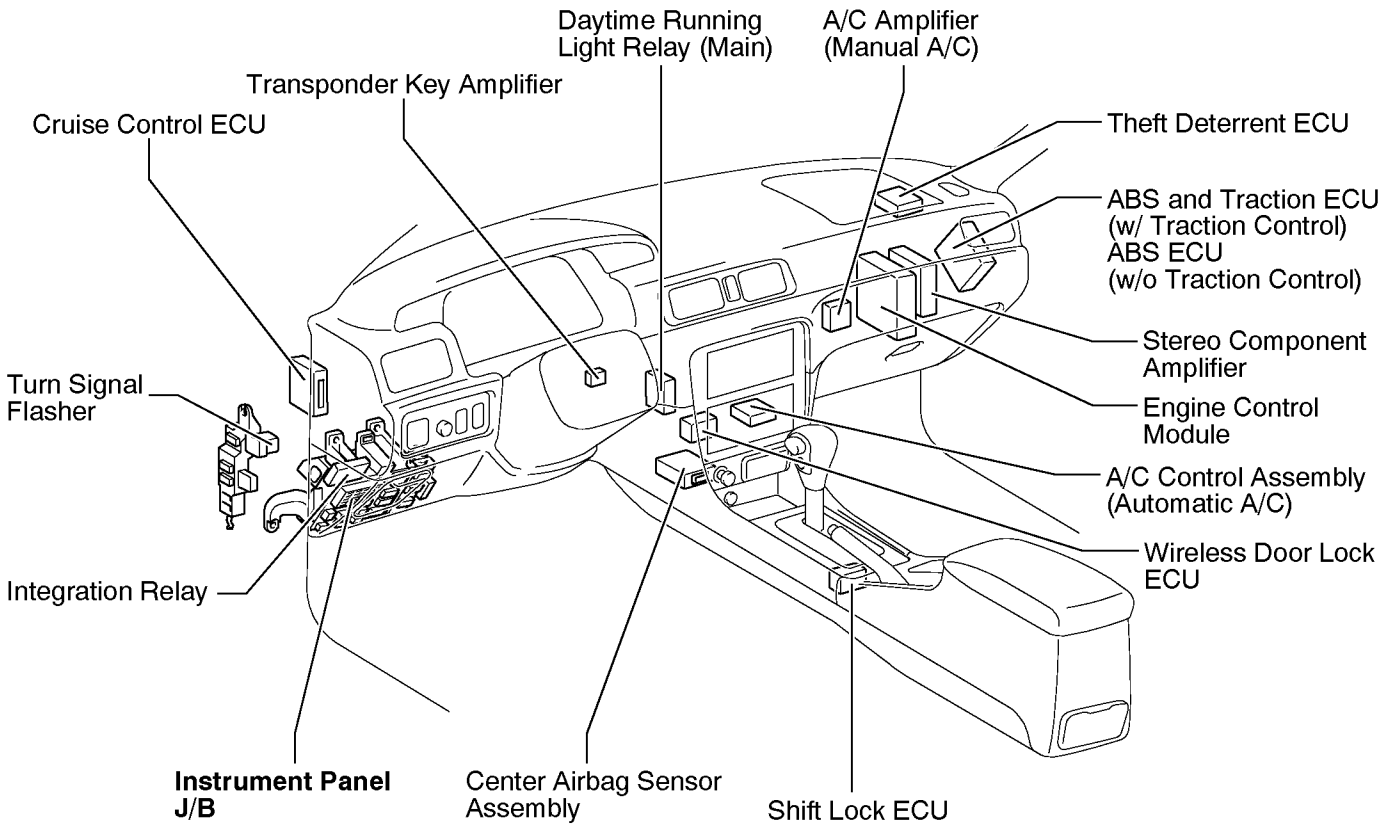

Fusible Link Block	Engine Compartment Left (See Page 18) (Inside Engine Room J/B No.2)
---------------------------	--

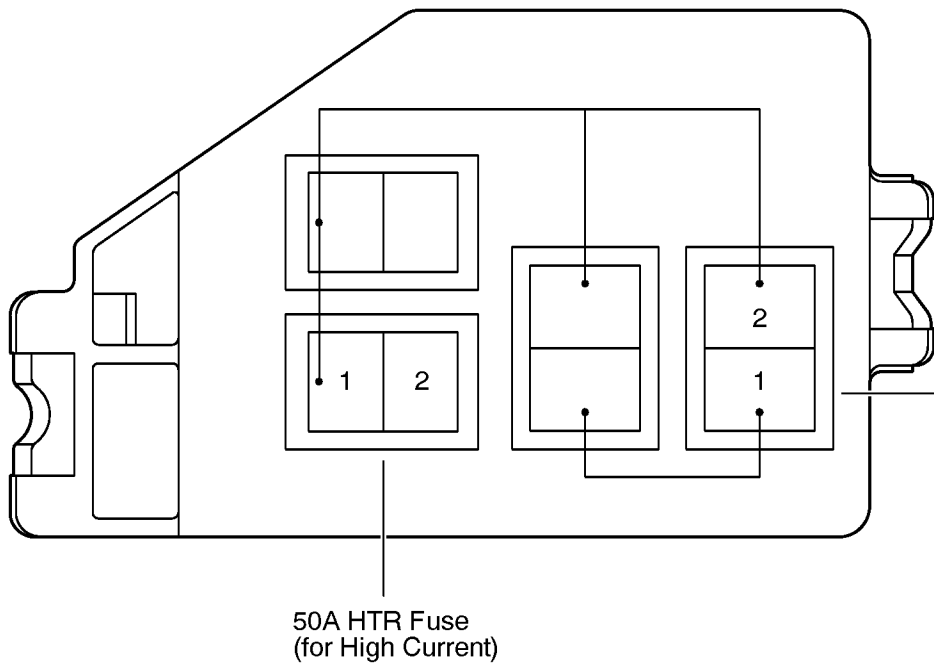

F RELAY LOCATIONS

○ : Instrument Panel J/B Lower Finish Panel (See Page 19)

*1 : POWER-OUTLET
*2 : MIRROR-HEATER

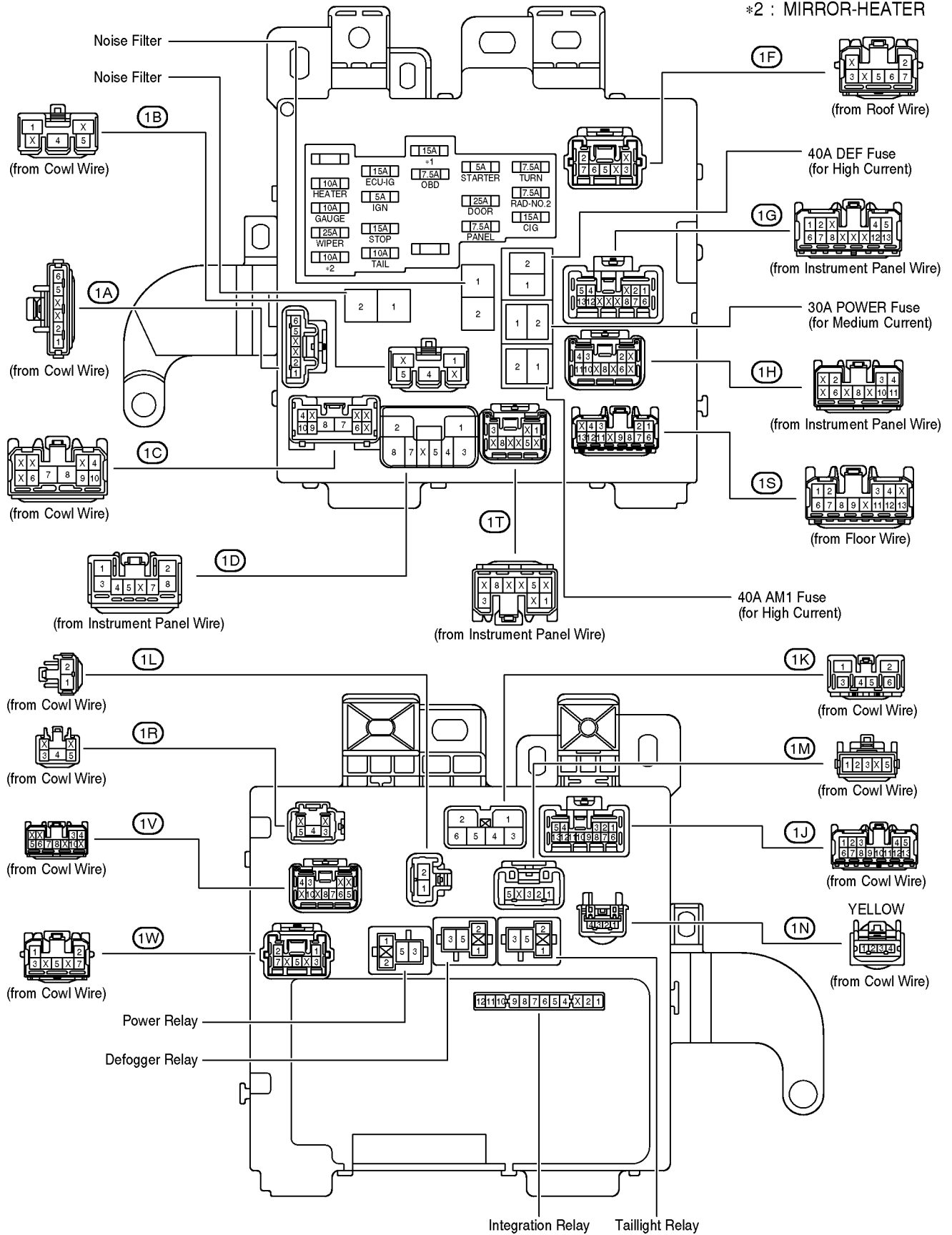

[Instrument Panel J/B Inner Circuit]

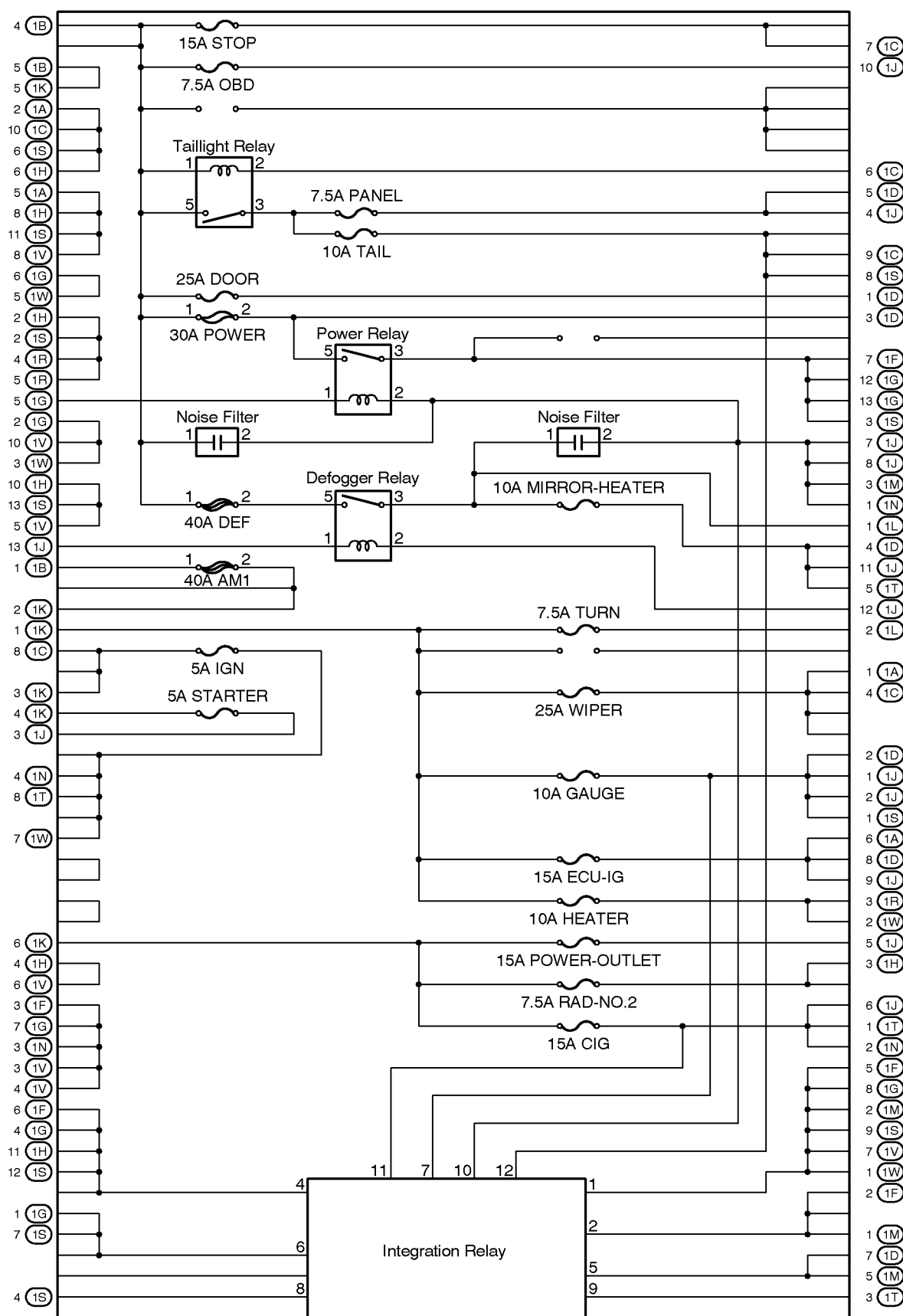

F RELAY LOCATIONS

○ : Engine Room J/B No.2 Engine Compartment Left (See Page 18)

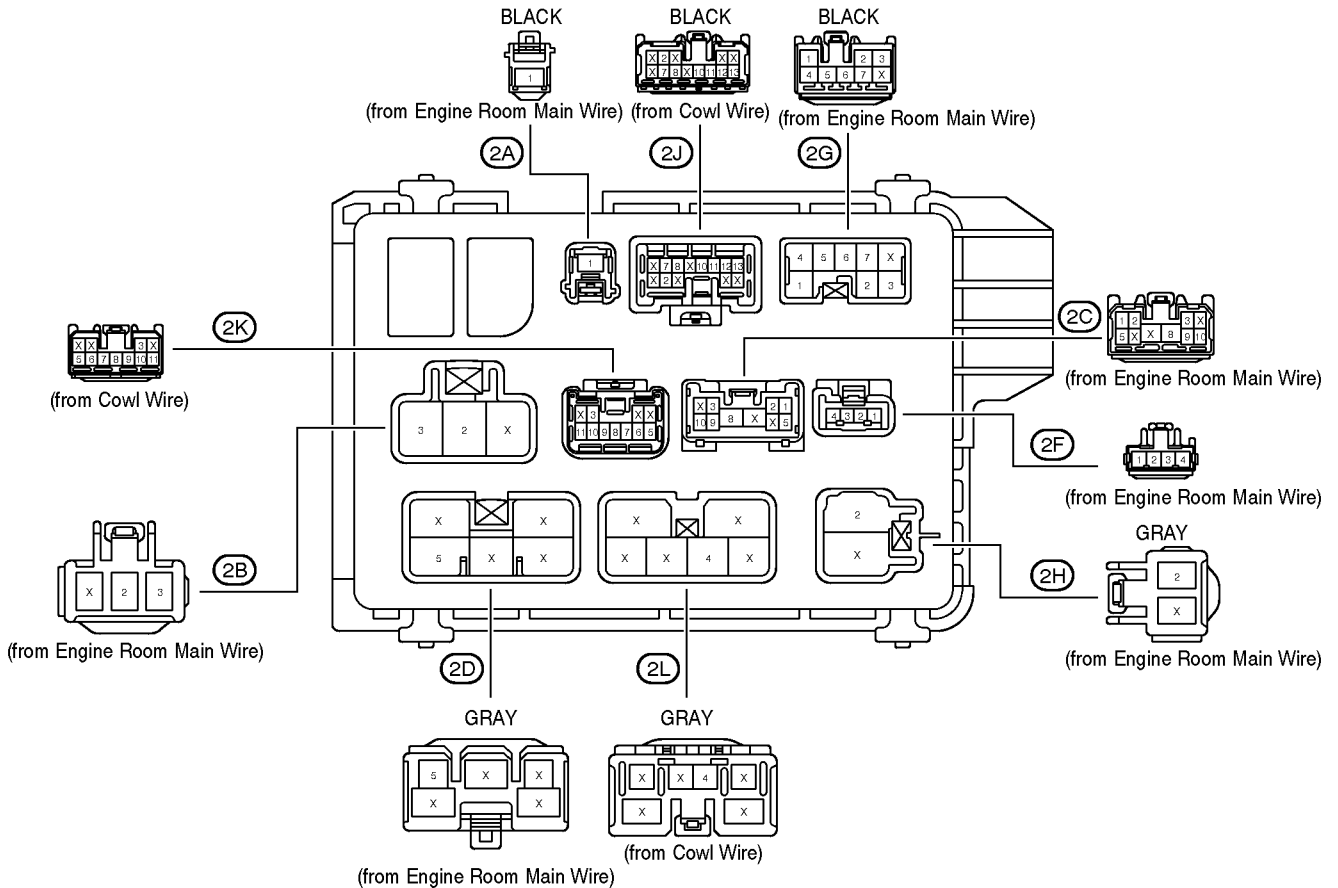
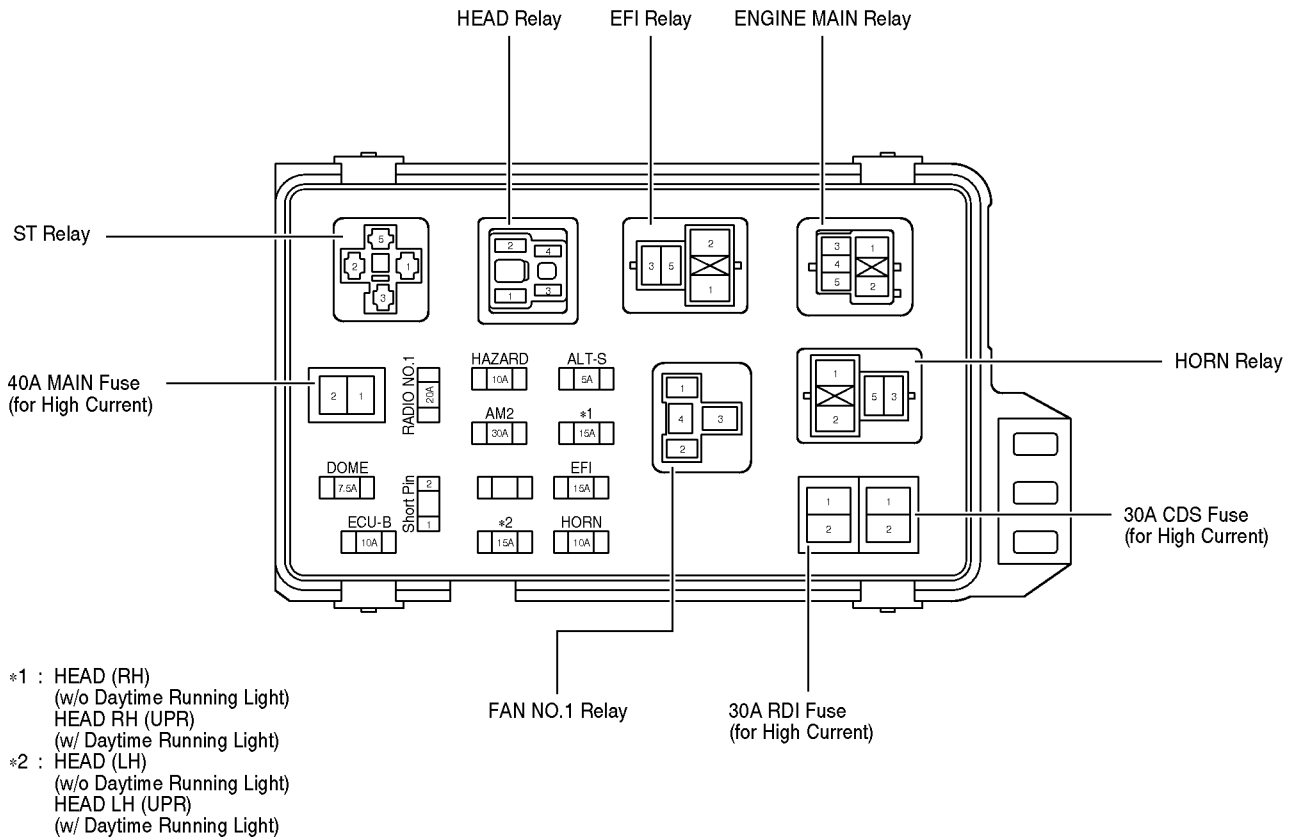

[Engine Room J/B No.2 Inner Circuit]

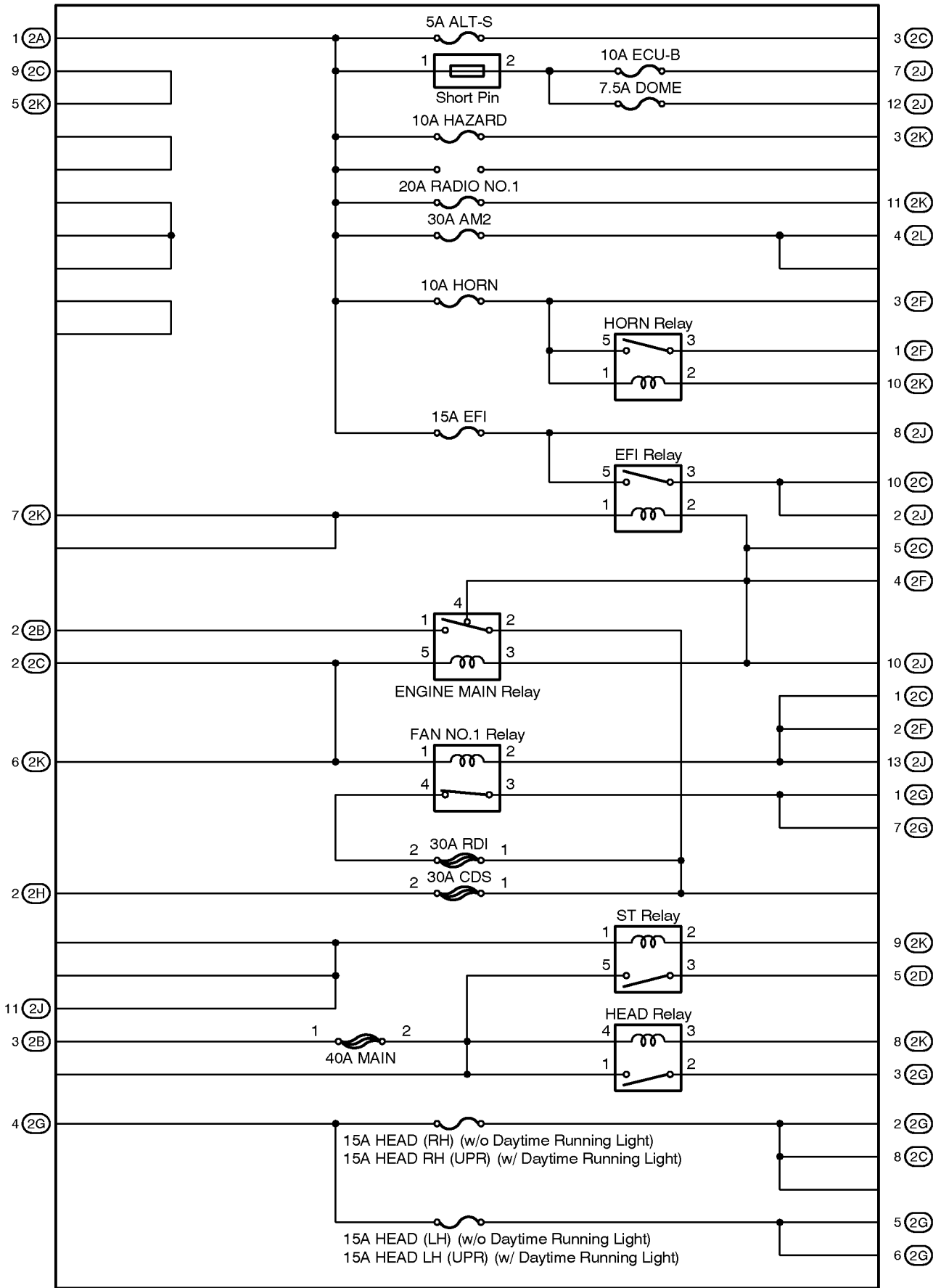

F RELAY LOCATIONS

① : Engine Room R/B No.1 **Engine Compartment Left (See Page 18)**
(Inside Engine Room J/B No.2)

*1 : California

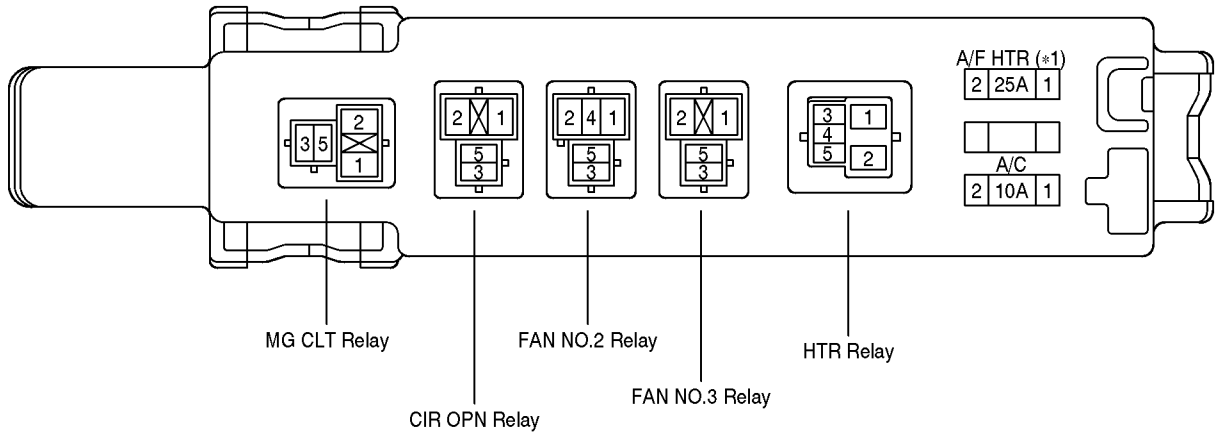

② : Engine Room R/B No.2 **Near the Battery (See Page 18)**

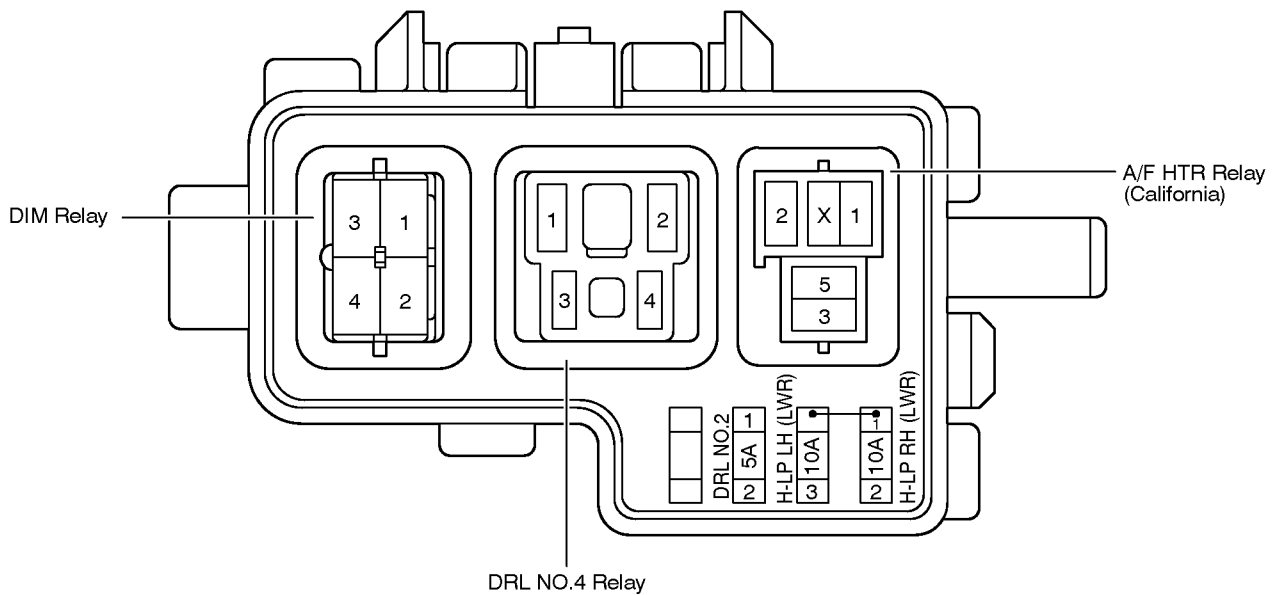

③ : Engine Room R/B No.3 | Radiator Upper Support RH (See Page 18)
(TMMK Made w/ ABS and Traction Control)
(TMC Made w/ ABS, w/ ABS and Traction Control)

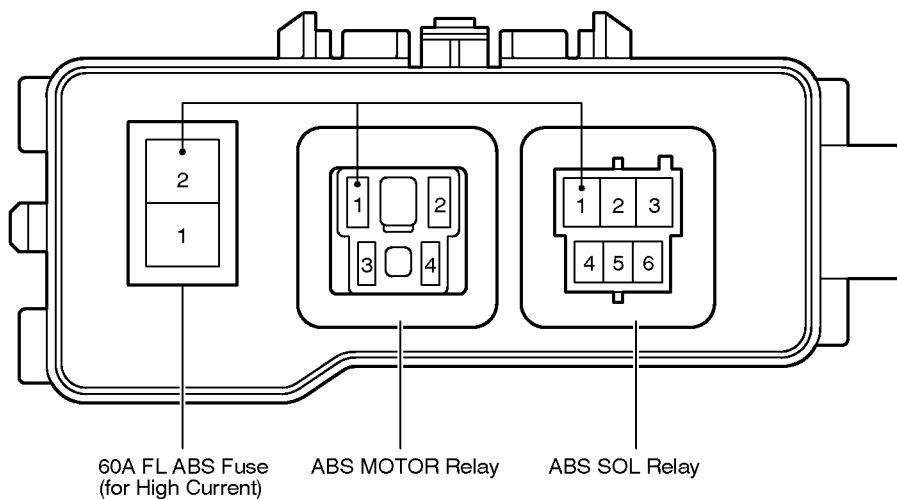

③ : Fusible Link Block | Radiator Upper Support RH (See Page 18)
(TMMK Made w/ ABS w/o Traction Control)

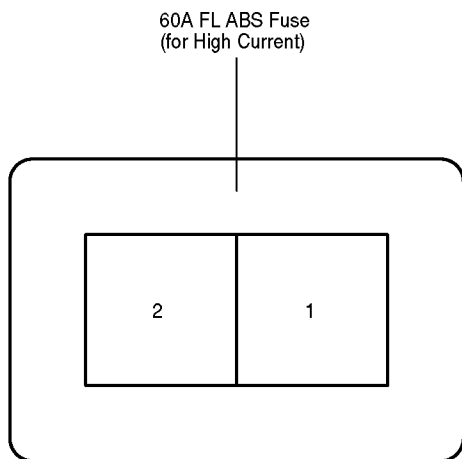

G ELECTRICAL WIRING ROUTING

Position of Parts in Engine Compartment

[1MZ-FE]

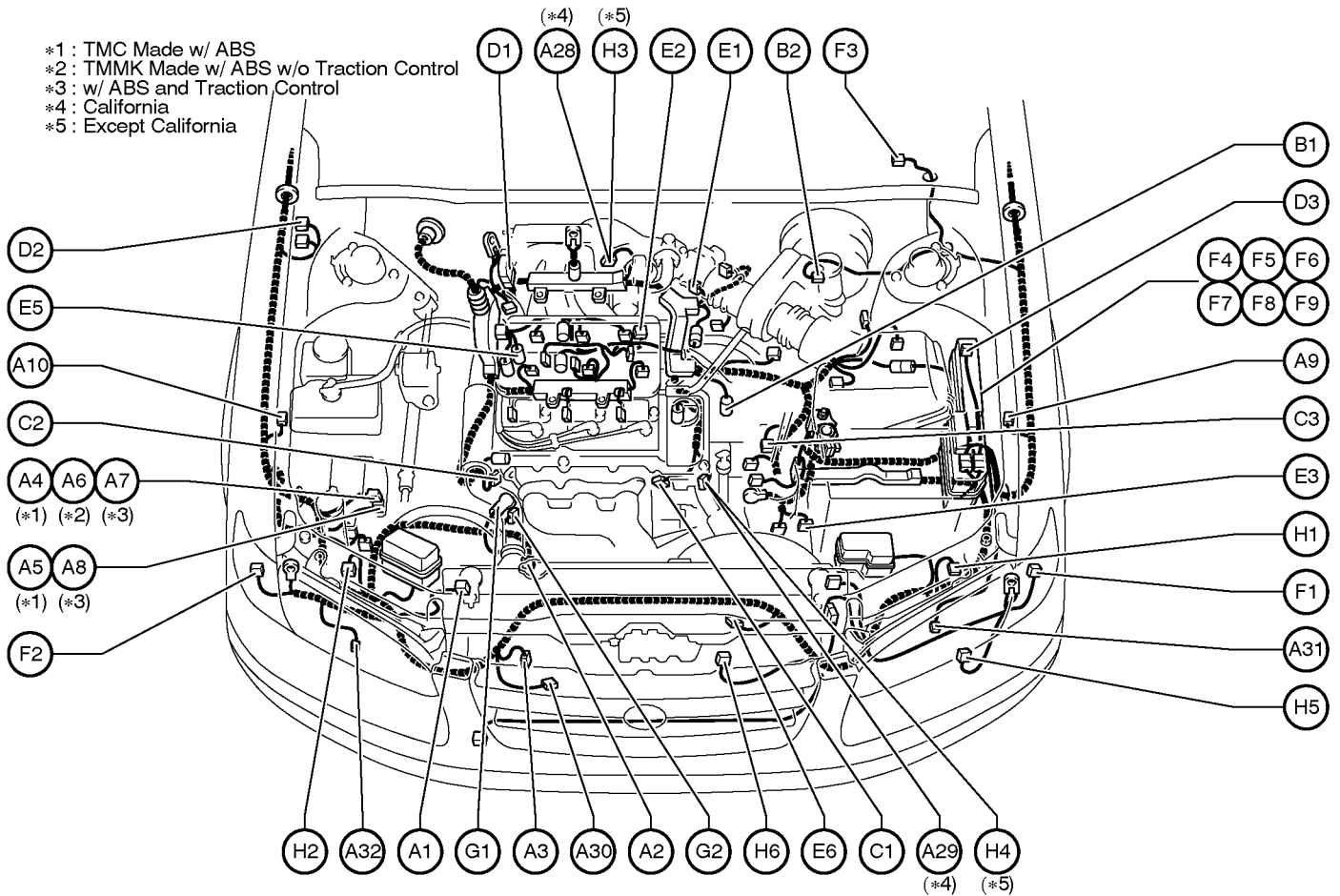

- *1 : TMC Made w/ ABS
- *2 : TMMK Made w/ ABS w/o Traction Control
- *3 : w/ ABS and Traction Control
- *4 : California
- *5 : Except California

- | | |
|---|---|
| A 1 A/C Condenser Fan Motor | E 1 EGR Gas Temp. Sensor |
| A 2 A/C Magnetic Clutch and Lock Sensor | E 2 EGR Valve Position Sensor |
| A 3 A/C Triple Pressure SW
(A/C Dual and Single Pressure SW) | E 3 Electronically Controlled Transmission Solenoid |
| A 4 ABS Actuator | E 5 Engine Coolant Temp. Sensor |
| A 5 ABS Actuator | E 6 Engine Hood Courtesy SW |
| A 6 ABS Actuator and ECU | F 1 Front Turn Signal Light and Parking Light LH |
| A 7 ABS and Traction Actuator | F 2 Front Turn Signal Light and Parking Light RH |
| A 8 ABS and Traction Actuator | F 3 Front Wiper Motor |
| A 9 ABS Speed Sensor Front LH | F 4 Fusible Link Block |
| A 10 ABS Speed Sensor Front RH | F 5 Fusible Link Block |
| A 28 Air Fuel Ratio Sensor (Bank 1 Sensor 1) | F 6 Fusible Link Block |
| A 29 Air Fuel Ratio Sensor (Bank 2 Sensor 1) | F 7 Fusible Link Block |
| A 30 A/C Ambient Temp. Sensor | F 8 Fusible Link Block |
| A 31 Airbag Sensor Front LH | F 9 Fusible Link Block |
| A 32 Airbag Sensor Front RH | |
| B 1 Back-Up Light SW | G 1 Generator |
| B 2 Brake Fluid Level Warning SW | G 2 Generator |
| C 1 Camshaft Position Sensor | H 1 Headlight LH |
| C 2 Crankshaft Position Sensor | H 2 Headlight RH |
| C 3 Cruise Control Actuator | H 3 Heated Oxygen Sensor (Bank 1 Sensor 1) |
| D 1 Data Link Connector 1 | H 4 Heated Oxygen Sensor (Bank 2 Sensor 1) |
| D 2 Daytime Running Light Resistor | H 5 Horn (High) |
| D 3 Diode (A/C) | H 6 Horn (Low) |

Position of Parts in Engine Compartment

[1MZ-FE]

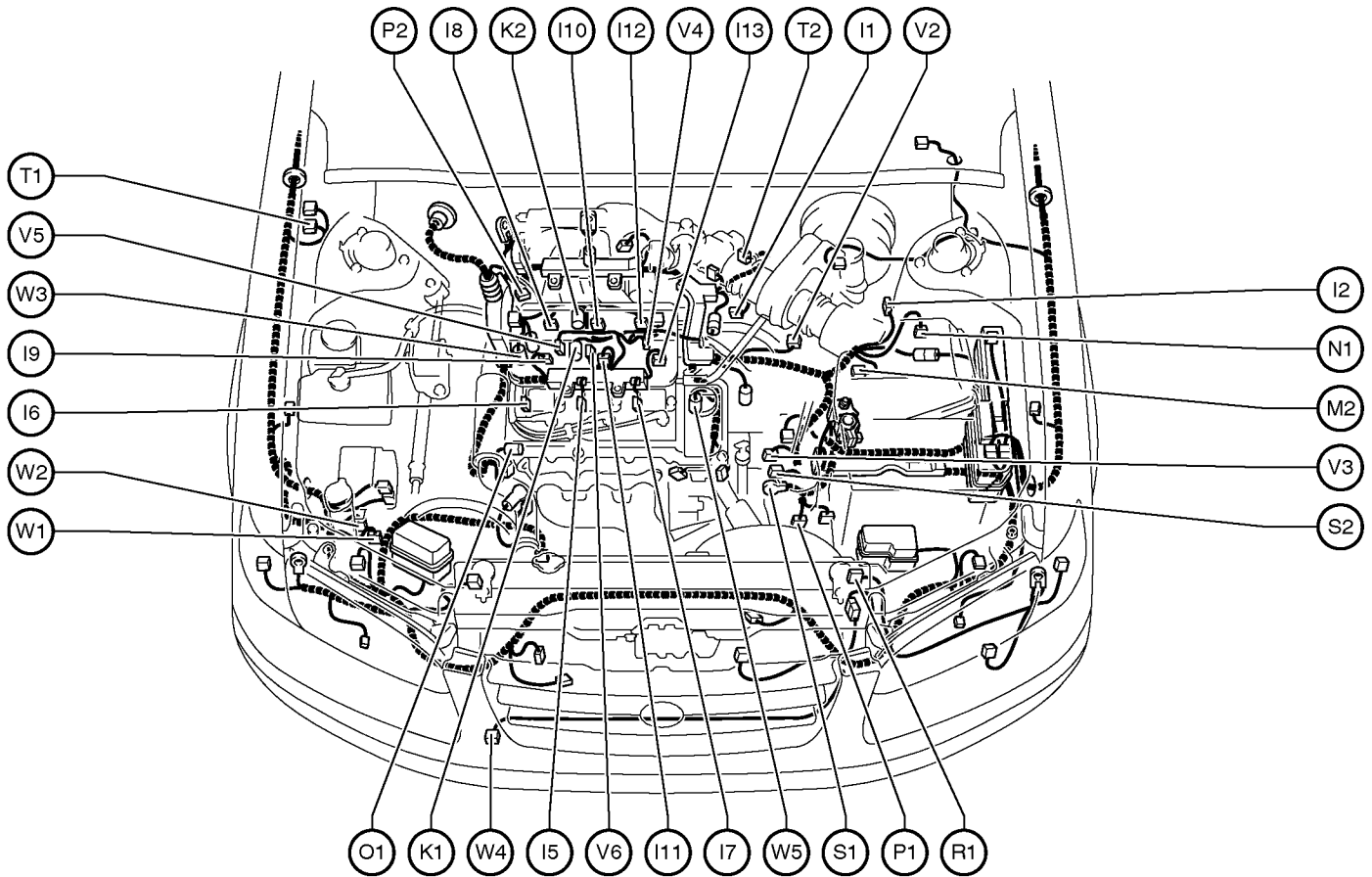

I 1 Idle Air Control Valve
 I 2 Igniter
 I 5 Ignition Coil No.1
 I 6 Ignition Coil No.2
 I 7 Ignition Coil No.3
 I 8 Injector No.1
 I 9 Injector No.2
 I 10 Injector No.3
 I 11 Injector No.4
 I 12 Injector No.5
 I 13 Injector No.6

K 1 Knock Sensor 1
 K 2 Knock Sensor 2

M 2 Mass Air Flow Meter

N 1 Noise Filter (Ignition)

O 1 Oil Pressure SW

P 1 Park/Neutral Position SW,A/T Indicator Light SW and
 Back-Up Light SW

P 2 Power Steering Oil Pressure SW

R 1 Radiator Fan Motor

S 1 Starter

S 2 Starter

T 1 Theft Deterrent Horn

T 2 Throttle Position Sensor

V 2 Vehicle Speed Sensor (Combination Meter)

V 3 Vehicle Speed Sensor
 (Electronically Controlled Transmission)

V 4 VSV (EGR)

V 5 VSV (EVAP)

V 6 VSV (Intake Air Control)

W 1 Washer Level Warning SW

W 2 Washer Motor

W 3 Water Temp. Sender

W 4 Water Temp. SW No.1

W 5 Water Temp. SW No.2

G ELECTRICAL WIRING ROUTING

Position of Parts in Engine Compartment

[5S-FE]

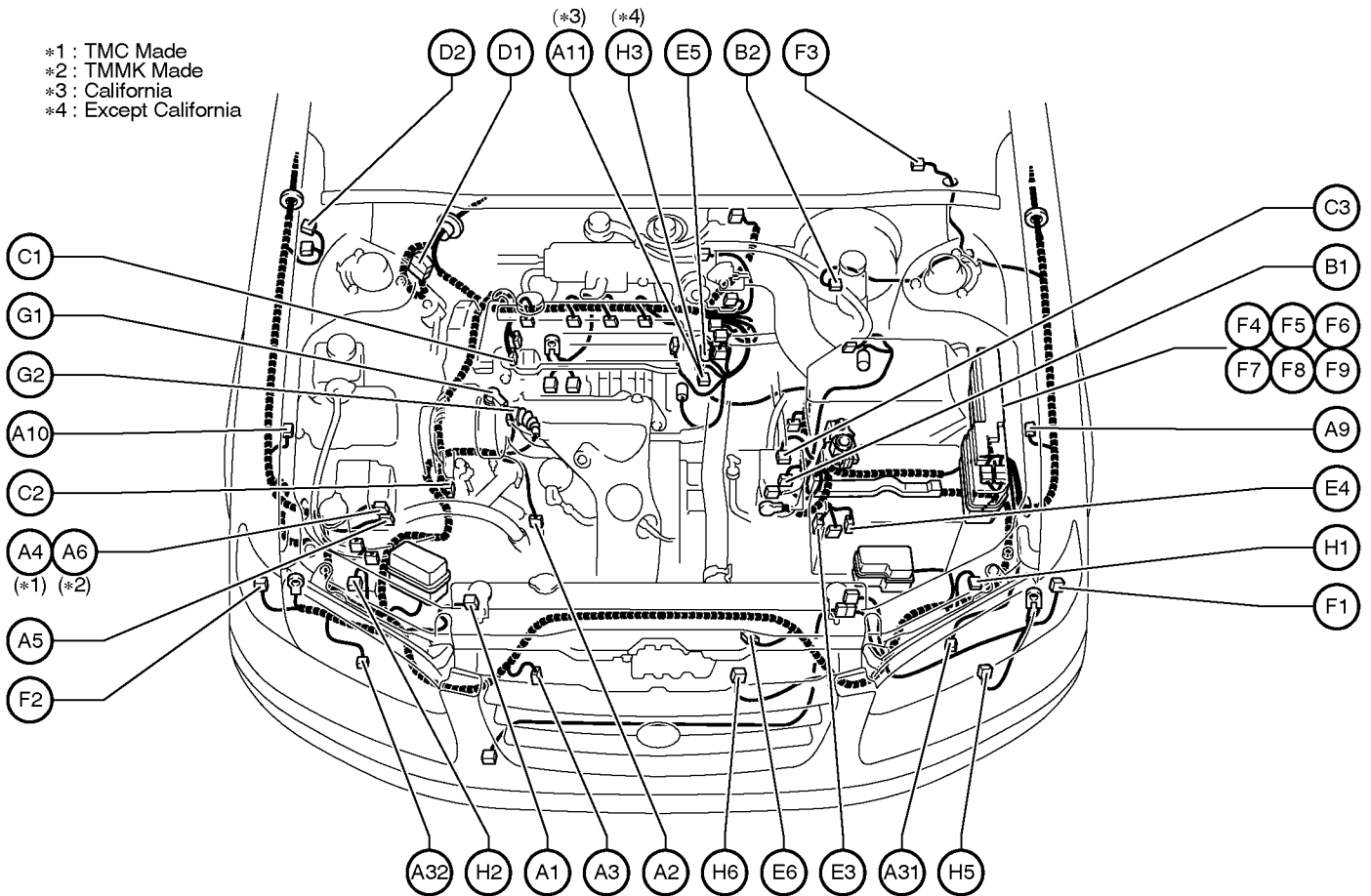

- A 1 A/C Condenser Fan Motor
- A 2 A/C Magnetic Clutch and Lock Sensor
- A 3 A/C Triple Pressure SW
(A/C Dual and Single Pressure SW)
- A 4 ABS Actuator
- A 5 ABS Actuator
- A 6 ABS Actuator and ECU
- A 9 ABS Speed Sensor Front LH
- A 10 ABS Speed Sensor Front RH
- A 11 Air Fuel Ratio Sensor
- A 31 Airbag Sensor Front LH
- A 32 Airbag Sensor Front RH

- B 1 Back-Up Light SW
- B 2 Brake Fluid Level Warning SW

- C 1 Camshaft Position Sensor
- C 2 Crankshaft Position Sensor
- C 3 Cruise Control Actuator

- D 1 Data Link Connector 1
- D 2 Daytime Running Light Resistor

- E 3 Electronically Controlled Transmission Solenoid
- E 4 Electronically Controlled Transmission Solenoid
- E 5 Engine Coolant Temp. Sensor
- E 6 Engine Hood Courtesy SW

- F 1 Front Turn Signal Light and Parking Light LH
- F 2 Front Turn Signal Light and Parking Light RH
- F 3 Front Wiper Motor
- F 4 Fusible Link Block
- F 5 Fusible Link Block
- F 6 Fusible Link Block
- F 7 Fusible Link Block
- F 8 Fusible Link Block
- F 9 Fusible Link Block

- G 1 Generator
- G 2 Generator

- H 1 Headlight LH
- H 2 Headlight RH
- H 3 Heated Oxygen Sensor (Bank 1 Sensor 1)
- H 5 Horn (High)
- H 6 Horn (Low)

Position of Parts in Engine Compartment

[5S-FE]

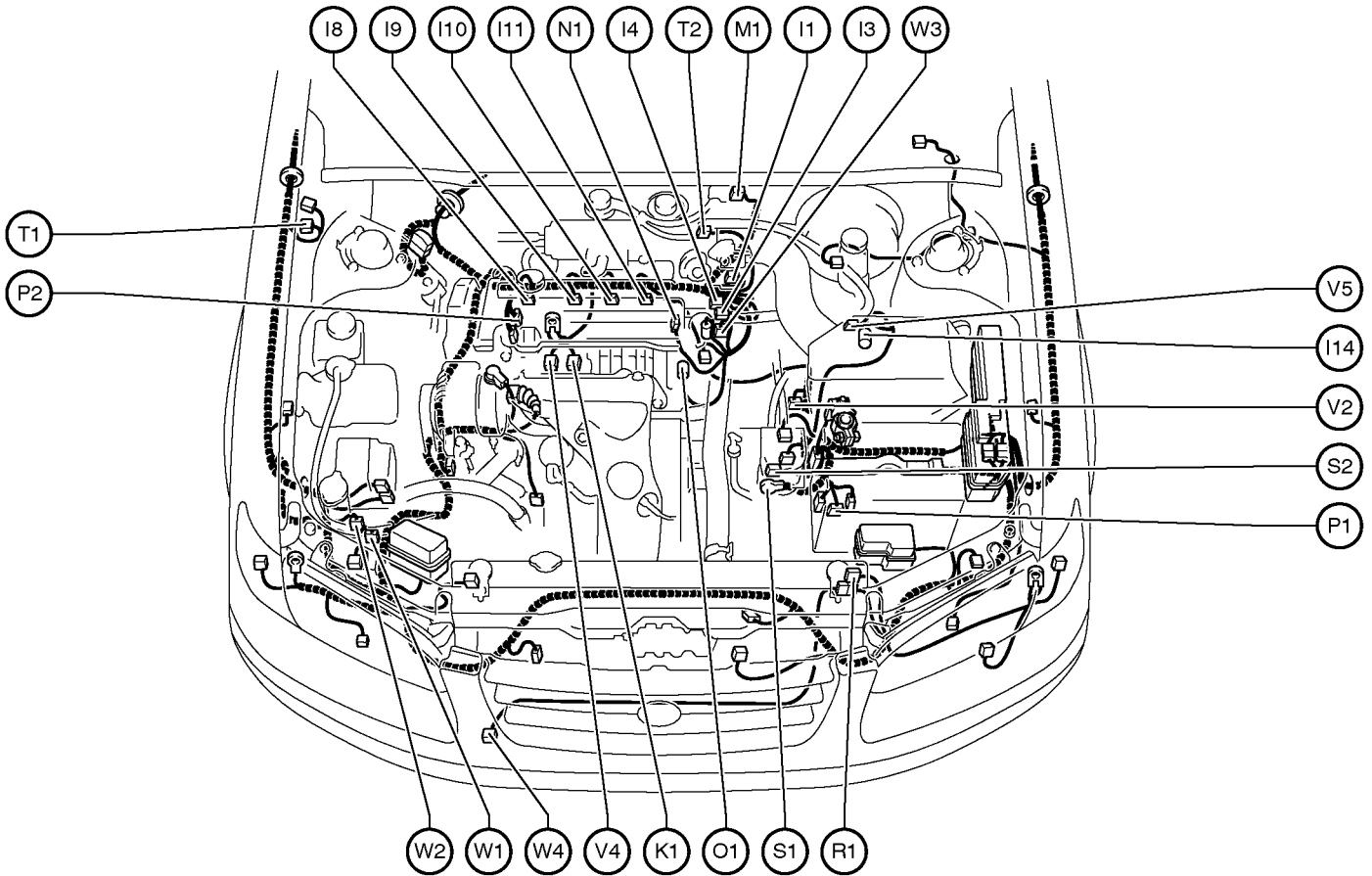

- | | |
|--|--|
| I 1 Idle Air Control Valve | R 1 Radiator Fan Motor |
| I 3 Ignition Coil and Igniter No.1 | S 1 Starter |
| I 4 Ignition Coil and Igniter No.2 | S 2 Starter |
| I 8 Injector No.1 | T 1 Theft Deterrent Horn |
| I 9 Injector No.2 | T 2 Throttle Position Sensor |
| I 10 Injector No.3 | V 2 Vehicle Speed Sensor (Combination Meter) |
| I 11 Injector No.4 | V 4 VSV (EGR) |
| I 14 Intake Air Temp. Sensor | V 5 VSV (EVAP) |
| K 1 Knock Sensor 1 | W 1 Washer Level Warning SW |
| M 1 Manifold Absolute Pressure Sensor | W 2 Washer Motor |
| N 1 Noise Filter (Ignition) | W 3 Water Temp. Sender |
| O 1 Oil Pressure SW | W 4 Water Temp. SW No.1 |
| P 1 Park/Neutral Position SW,A/T Indicator Light SW and Back-Up Light SW | |
| P 2 Power Steering Oil Pressure SW | |

G ELECTRICAL WIRING ROUTING

Position of Parts in Instrument Panel

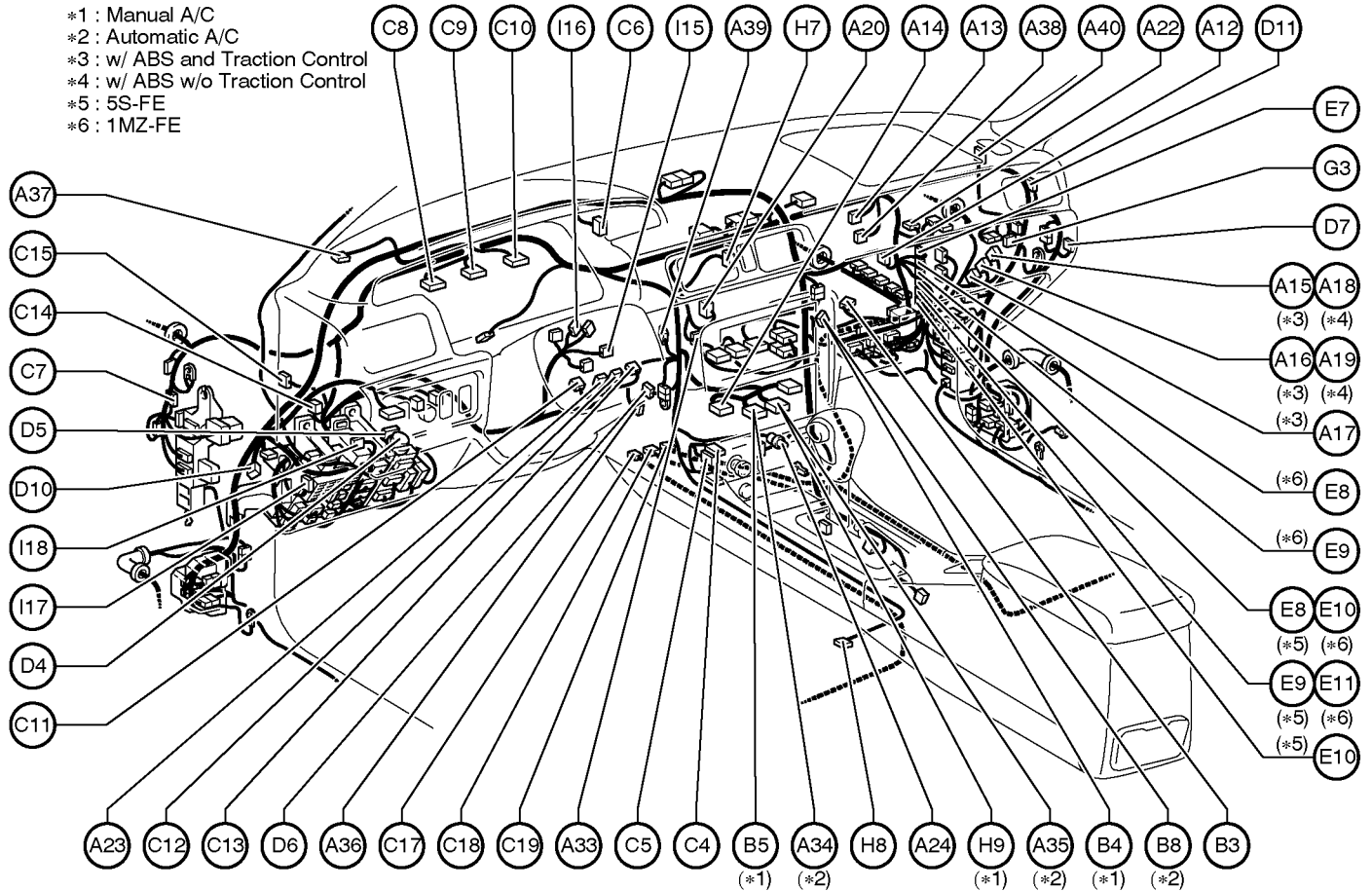

- *1 : Manual A/C
- *2 : Automatic A/C
- *3 : w/ ABS and Traction Control
- *4 : w/ ABS w/o Traction Control
- *5 : 5S-FE
- *6 : 1MZ-FE

- | | |
|---|--|
| A 12 A/C Amplifier | C 11 Combination SW |
| A 13 A/C Evaporator Temp. Sensor | C 12 Combination SW |
| A 14 A/C SW | C 13 Combination SW |
| A 15 ABS and Traction ECU | C 14 Cruise Control Clutch SW |
| A 16 ABS and Traction ECU | C 15 Cruise Control ECU |
| A 17 ABS and Traction ECU | C 17 Center Airbag Sensor Assembly |
| A 18 ABS ECU | C 18 Center Airbag Sensor Assembly |
| A 19 ABS ECU | C 19 Center Airbag Sensor Assembly |
| A 20 Air Vent Mode Control Servo Motor | D 4 Data Link Connector 2 |
| A 22 Airbag Squib (Front Passenger Airbag Assembly) | D 5 Data Link Connector 3 |
| A 23 Airbag Squib (Steering Wheel Pad) | D 6 Daytime Running Light Relay (Main) |
| A 24 Ashtray Illumination | D 7 Diode (Courtesy) |
| A 33 A/C Blower Motor Linear Controller | D 10 Diode (Dome) |
| A 34 A/C Control Assembly | D 11 Diode (Idle-Up) |
| A 35 A/C Control Assembly | E 7 Engine Control Module |
| A 36 A/C Room Temp. Sensor | E 8 Engine Control Module |
| A 37 A/C Solar Sensor | E 9 Engine Control Module |
| A 38 Air Inlet Control Servo Motor | E 10 Engine Control Module |
| A 39 Air Mix Control Servo Motor | E 11 Engine Control Module |
| A 40 Automatic Light Control Sensor | G 3 Glove Box Light and SW |
| B 3 Blower Motor | H 7 Hazard SW |
| B 4 Blower Resistor | H 8 Heated Oxygen Sensor (Bank 1 Sensor 2) |
| B 5 Blower SW | H 9 Heater Control SW |
| B 8 Blower Resistor (Low Speed) | I 15 Ignition Key Cylinder Light |
| C 4 Cigarette Lighter | I 16 Ignition SW |
| C 5 Cigarette Lighter Illumination | I 17 Integration Relay |
| C 6 Clock | I 18 Integration Relay |
| C 7 Clutch Start SW | |
| C 8 Combination Meter | |
| C 9 Combination Meter | |
| C 10 Combination Meter | |

Position of Parts in Instrument Panel

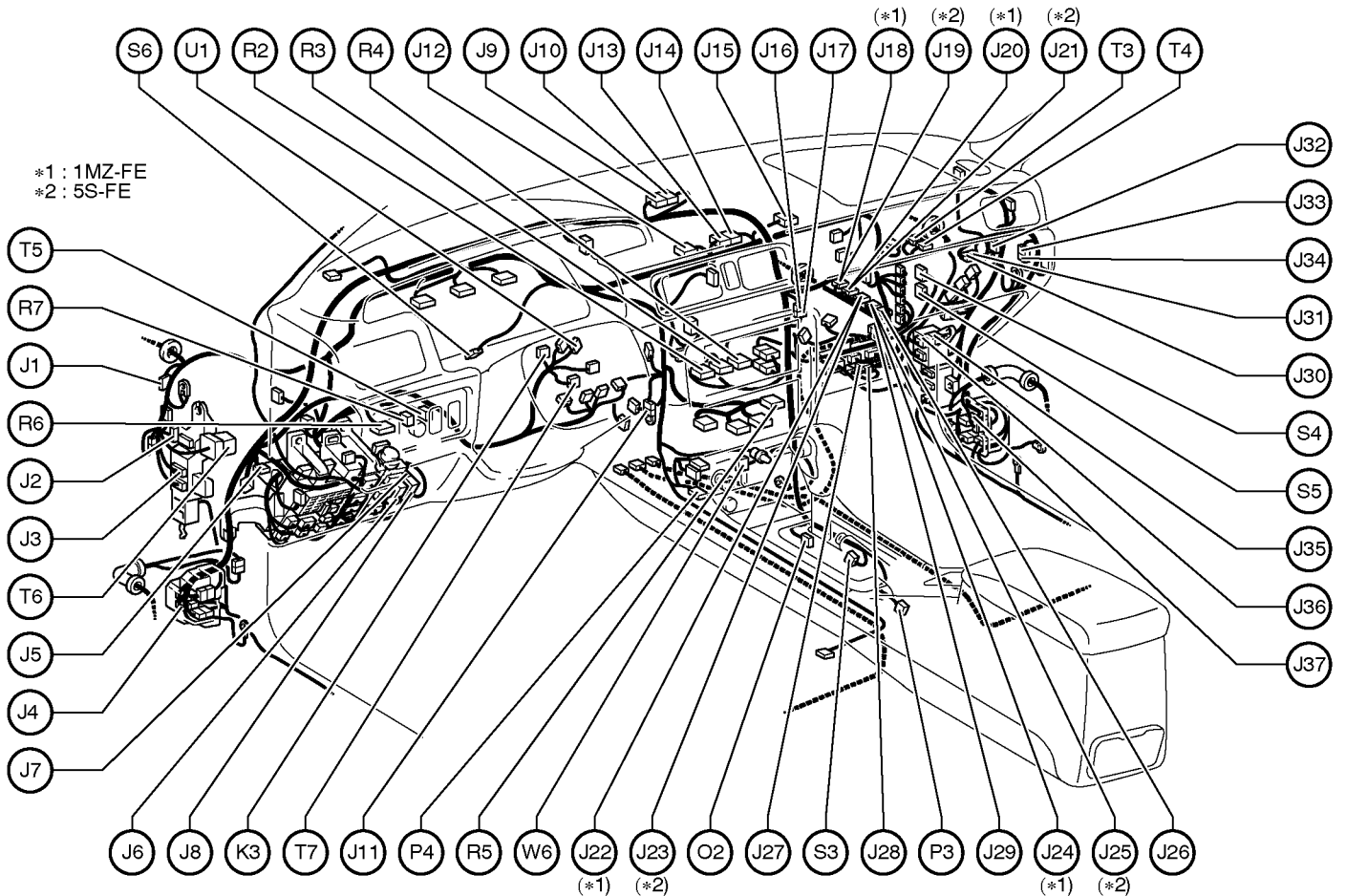

- J 1 Junction Connector
- J 2 Junction Connector
- J 3 Junction Connector
- J 4 Junction Connector
- J 5 Junction Connector
- J 6 Junction Connector
- J 7 Junction Connector
- J 8 Junction Connector
- J 9 Junction Connector
- J 10 Junction Connector
- J 11 Junction Connector
- J 12 Junction Connector
- J 13 Junction Connector
- J 14 Junction Connector
- J 15 Junction Connector
- J 16 Junction Connector
- J 17 Junction Connector
- J 18 Junction Connector
- J 19 Junction Connector
- J 20 Junction Connector
- J 21 Junction Connector
- J 22 Junction Connector
- J 23 Junction Connector
- J 24 Junction Connector
- J 25 Junction Connector
- J 26 Junction Connector
- J 27 Junction Connector
- J 28 Junction Connector
- J 29 Junction Connector
- J 30 Junction Connector
- J 31 Junction Connector
- J 32 Junction Connector
- J 33 Junction Connector

- J 34 Junction Connector
- J 35 Junction Connector
- J 36 Junction Connector
- J 37 Junction Connector

- K 3 Key Interlock Solenoid

- O 2 O/D Main SW and A/T Shift Lever Illumination

- P 3 Parking Brake SW
- P 4 Power Outlet

- R 2 Radio and Player
- R 3 Radio and Player
- R 4 Radio and Player
- R 5 Rear Window Defogger SW
- R 6 Remote Control Mirror SW
- R 7 Rheostat

- S 3 Shift Lock ECU
- S 4 Stereo Component Amplifier
- S 5 Stereo Component Amplifier
- S 6 Stop Light SW

- T 3 Theft Deterrent ECU
- T 4 Theft Deterrent ECU
- T 5 Traction Off SW
- T 6 Turn Signal Flasher
- T 7 Transponder Key Amplifier

- U 1 Unlock Warning SW

- W 6 Wireless Door Lock ECU

G ELECTRICAL WIRING ROUTING

Position of Parts in Body

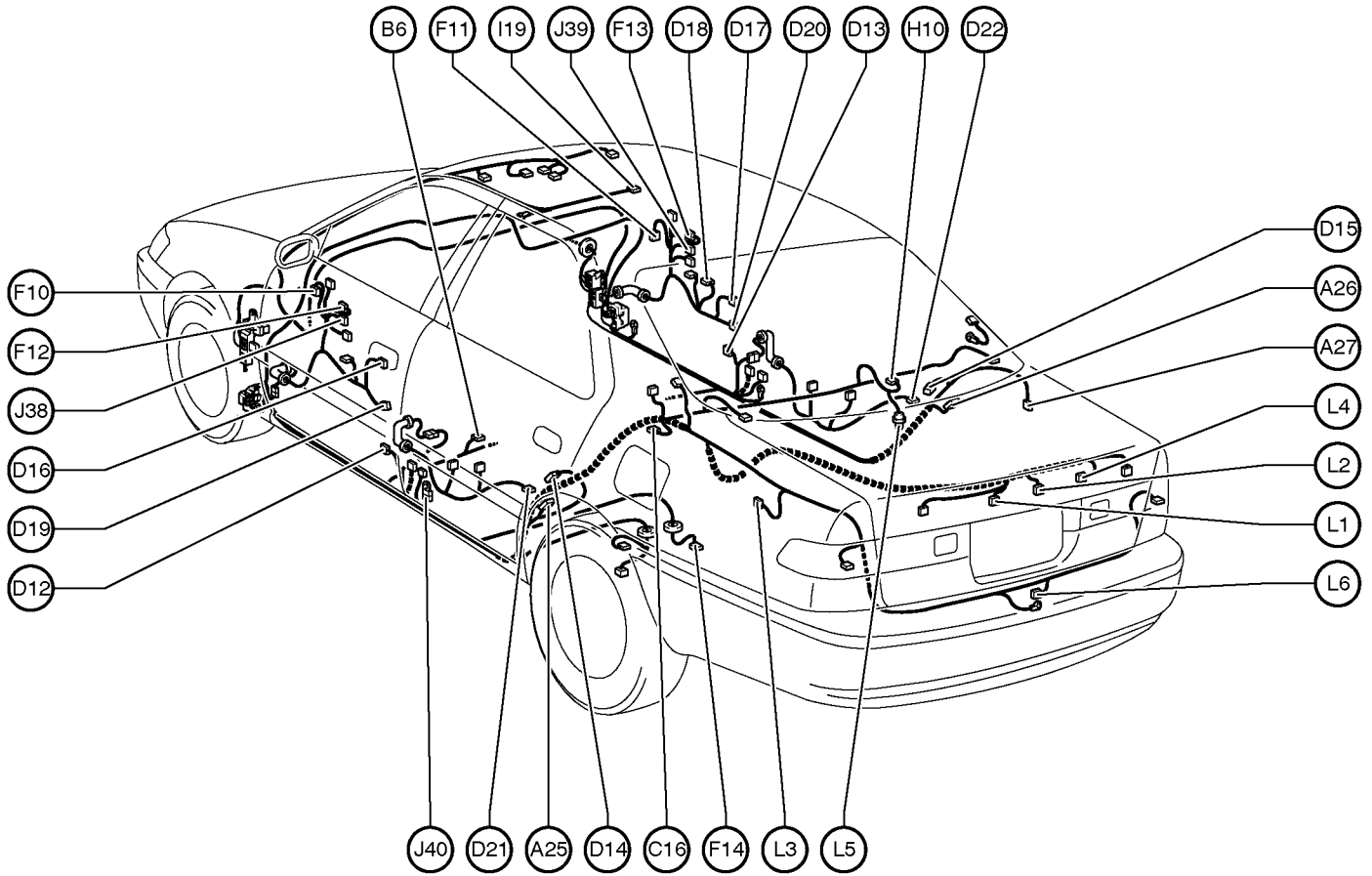

A25 ABS Speed Sensor Rear LH
 A26 ABS Speed Sensor Rear RH
 A27 Auto Antenna Motor and Relay

B 6 Buckle SW LH

C16 Condenser

D12 Door Courtesy SW Front LH
 D13 Door Courtesy SW Front RH
 D14 Door Courtesy SW Rear LH
 D15 Door Courtesy SW Rear RH
 D16 Door Key Lock and Unlock SW Front LH
 D17 Door Key Lock and Unlock SW Front RH
 D18 Door Lock Control SW RH
 D19 Door Lock Motor and Door Unlock Detection SW Front LH
 D20 Door Lock Motor and Door Unlock Detection SW Front RH
 D21 Door Lock Motor and Door Unlock Detection SW Rear LH
 D22 Door Lock Motor and Door Unlock Detection SW Rear RH

F10 Front Door Speaker LH
 F11 Front Door Speaker RH
 F12 Front Tweeter (Speaker) LH
 F13 Front Tweeter (Speaker) RH
 F14 Fuel Pump and Sender

H10 High Mounted Stop Light

I 19 Interior Light

J38 Junction Connector
 J39 Junction Connector
 J40 Junction Connector

L 1 License Plate Light LH
 L 2 License Plate Light RH
 L 3 Light Failure Sensor
 L 4 Luggage Compartment Key Unlock SW
 L 5 Luggage Compartment Light
 L 6 Luggage Compartment Light SW

Position of Parts in Body

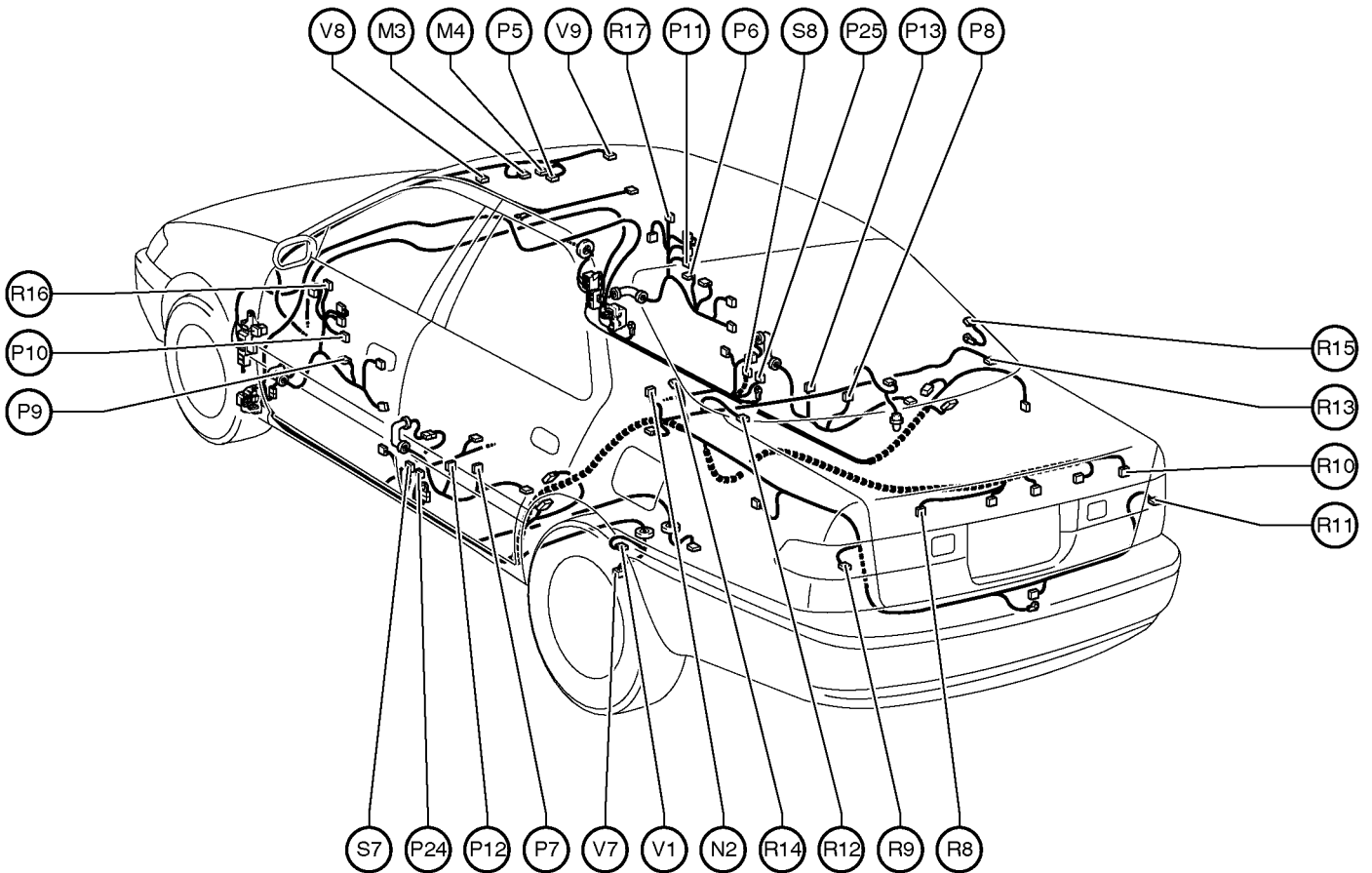

M 3 Moon Roof Control SW and Relay

M 4 Moon Roof Motor and Limit SW

N 2 Noise Filter (Rear Window Defogger)

P 5 Personal Light

P 6 Power Window Control SW Front RH

P 7 Power Window Control SW Rear LH

P 8 Power Window Control SW Rear RH

P 9 Power Window Master SW and Door Lock Control SW LH

P10 Power Window Motor Front LH

P11 Power Window Motor Front RH

P12 Power Window Motor Rear LH

P13 Power Window Motor Rear RH

P24 Pretensioner LH

P25 Pretensioner RH

R 8 Rear Combination Light LH

R 9 Rear Combination Light LH

R10 Rear Combination Light RH

R11 Rear Combination Light RH

R12 Rear Speaker LH

R13 Rear Speaker RH

R14 Rear Window Defogger

R15 Rear Window Defogger

R16 Remote Control Mirror LH

R17 Remote Control Mirror RH

S 7 Side Airbag Sensor LH

S 8 Side Airbag Sensor RH

V 1 Vapor Pressure Sensor

V 7 VSV (Vapor Pressure Sensor)

V 8 Vanity Light LH

V 9 Vanity Light RH

G ELECTRICAL WIRING ROUTING

Position of Parts in Seat

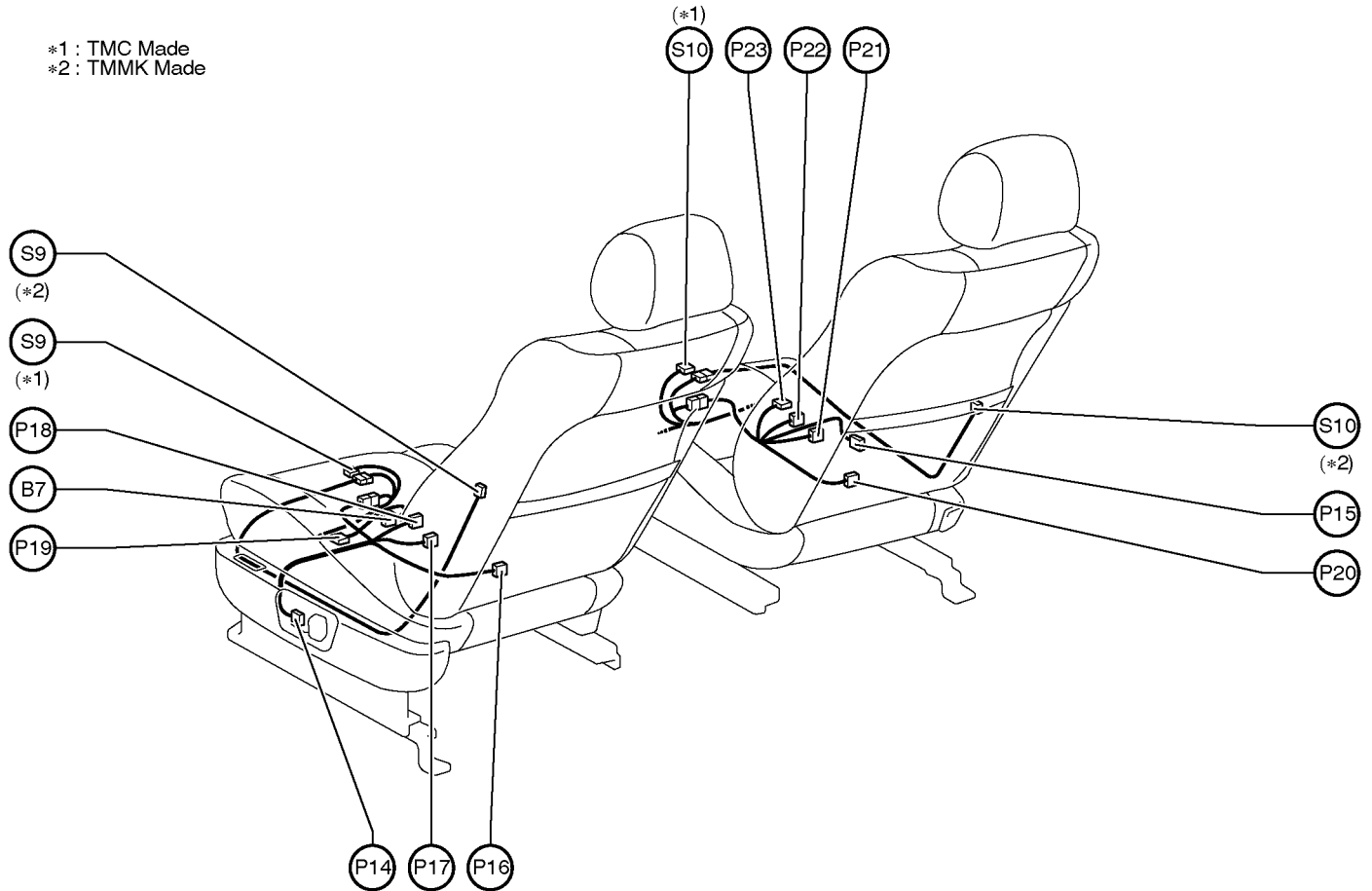

B 7 Buckle SW LH

S 9 Side Airbag Squib LH

S 10 Side Airbag Squib RH

- P 14 Power Seat Control SW (Driver's Seat)
- P 15 Power Seat Control SW (Front Passenger's Seat)
- P 16 Power Seat Motor (Driver's Seat Rear Vertical Control)
- P 17 Power Seat Motor (Driver's Seat Reclining Control)
- P 18 Power Seat Motor (Driver's Seat Slide Control)
- P 19 Power Seat Motors (Driver's Seat)
- P 20 Power Seat Motor
(Front Passenger's Seat Rear Vertical Control)
- P 21 Power Seat Motor
(Front Passenger's Seat Reclining Control)
- P 22 Power Seat Motor (Front Passenger's Seat Slide Control)
- P 23 Power Seat Motors (Front Passenger's Seat)

G ELECTRICAL WIRING ROUTING

□ : Location of Connector Joining Wire Harness and Wire Harness

▽ : Location of Ground Points

[1MZ-FE]

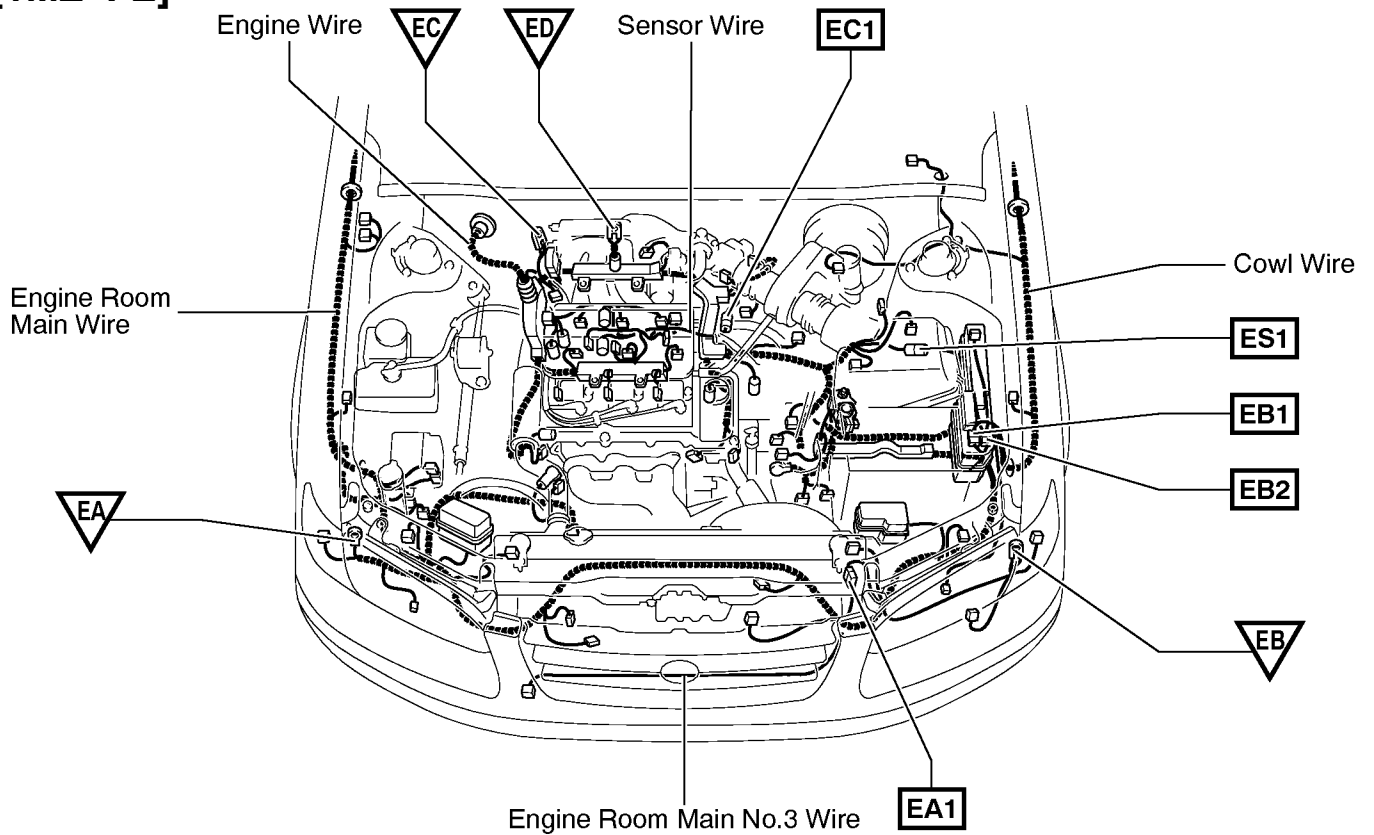

○ : Location of Splice Points

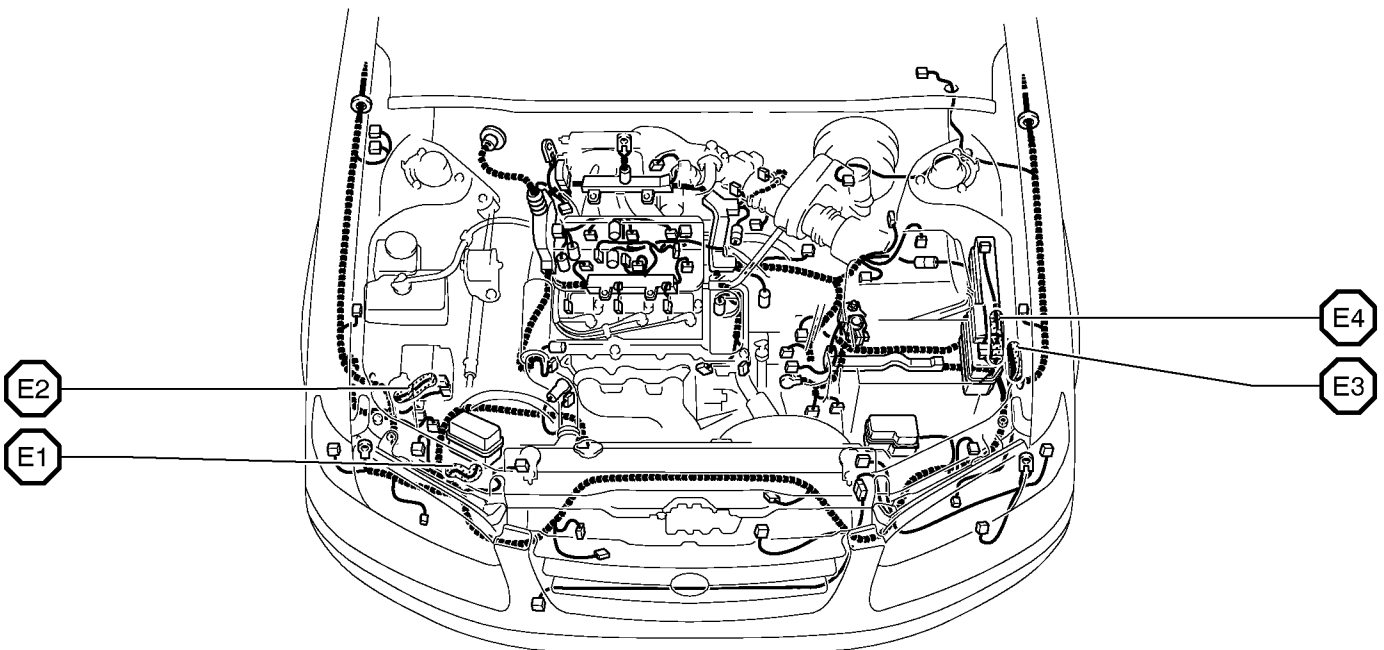

Connector Joining Wire Harness and Wire Harness

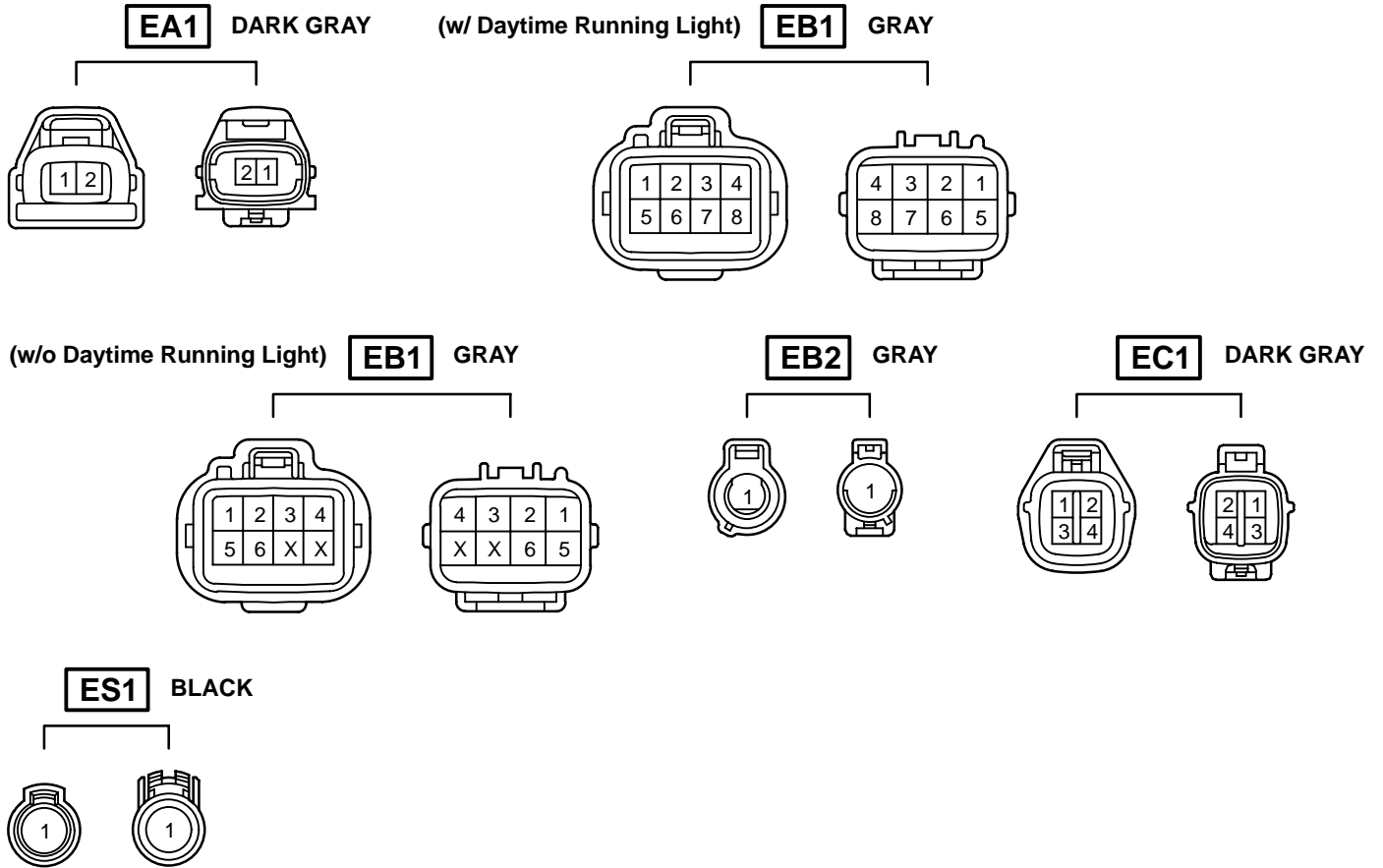

Code	Joining Wire Harness and Wire Harness (Connector Location)
EA1	Engine Room Main Wire and Engine Room Main No.3 Wire (Radiator LH)
EB1	Cowl Wire and Engine Room Main Wire (Under the Engine Room J/B No.2)
EB2	
EC1	Engine Wire and Sensor Wire (Head Cover RH)
ES1	Engine Wire and Engine Room Main Wire (Under the Engine Room J/B No.2)

G ELECTRICAL WIRING ROUTING

□ : Location of Connector Joining Wire Harness and Wire Harness

▽ : Location of Ground Points

[5S-FE]

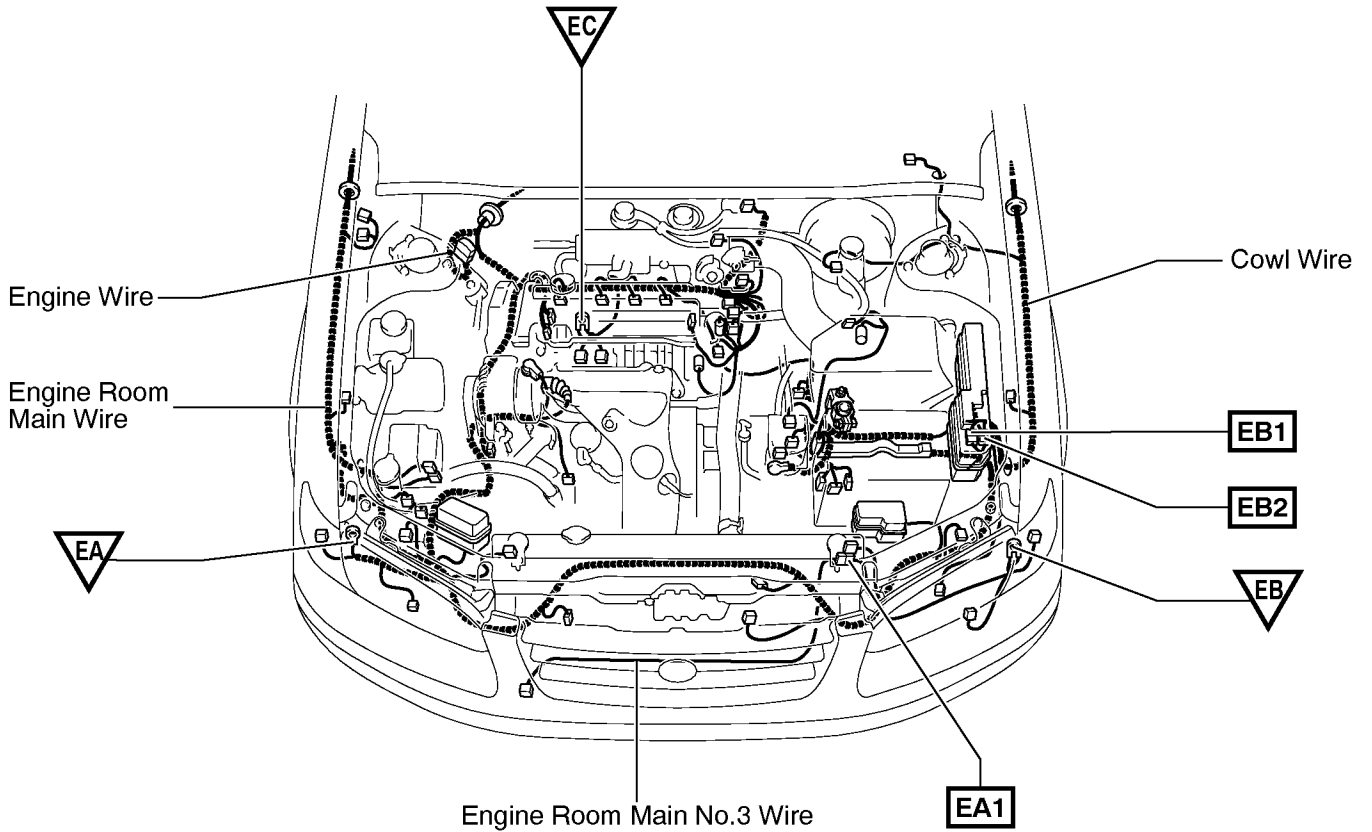

○ : Location of Splice Points

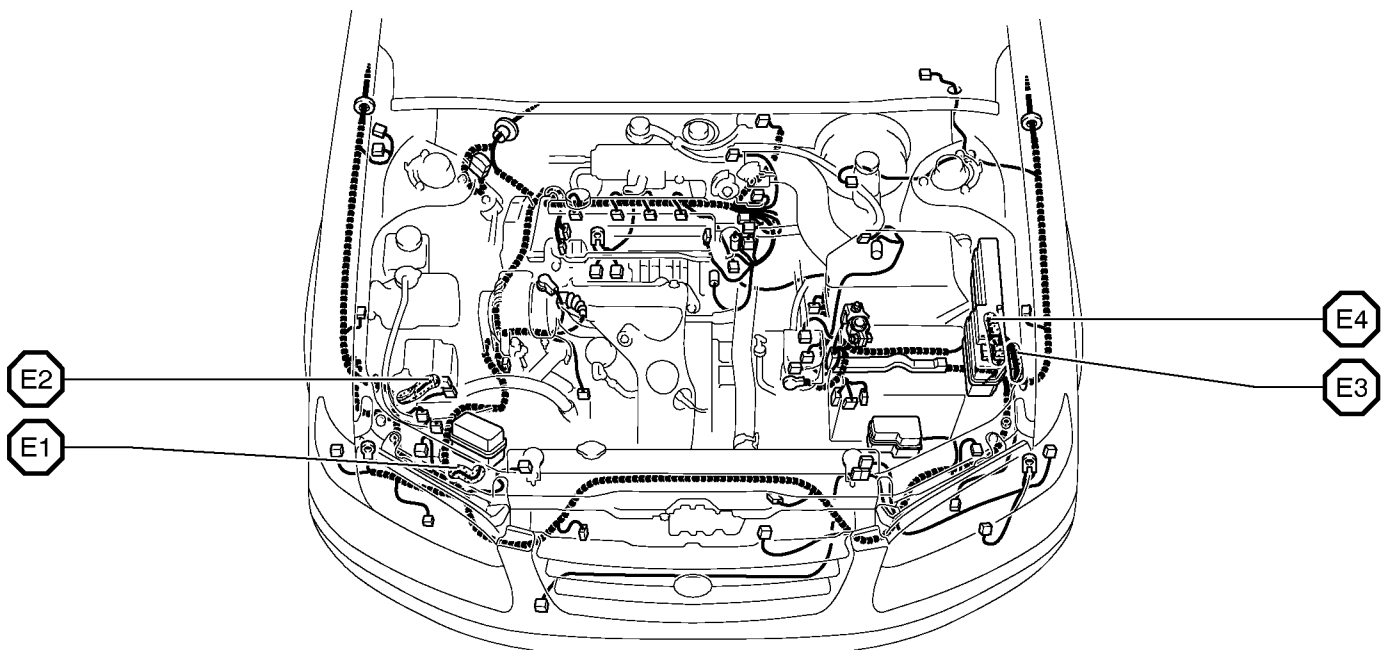

Connector Joining Wire Harness and Wire Harness

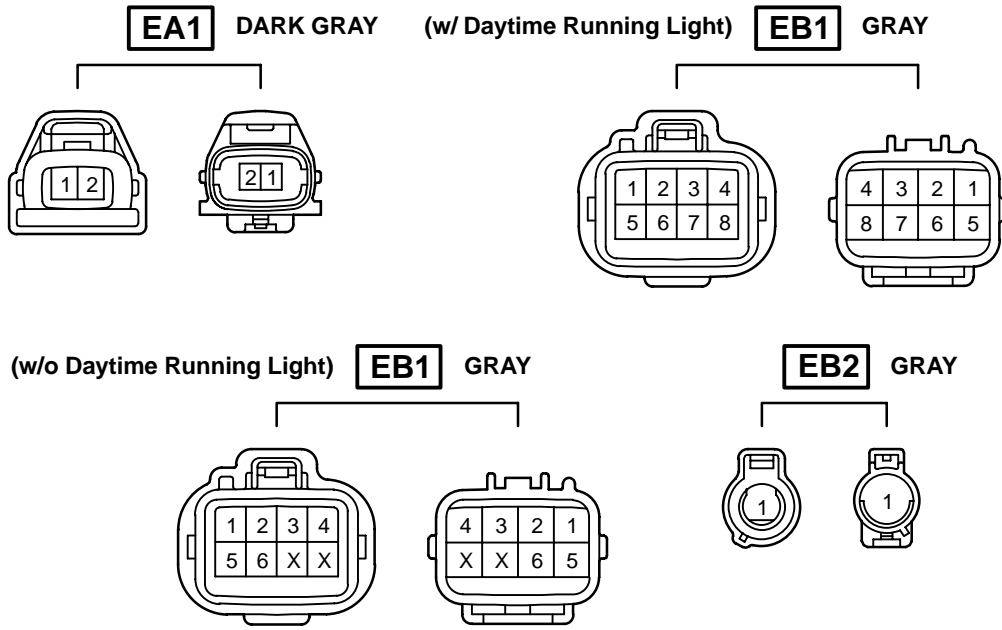

Code	Joining Wire Harness and Wire Harness (Connector Location)
EA1	Engine Room Main Wire and Engine Room Main No.3 Wire (Radiator LH)
EB1	Cowl Wire and Engine Room Main Wire (Under the Engine Room J/B No.2)
EB2	

G ELECTRICAL WIRING ROUTING

□ : Location of Connector Joining Wire Harness and Wire Harness

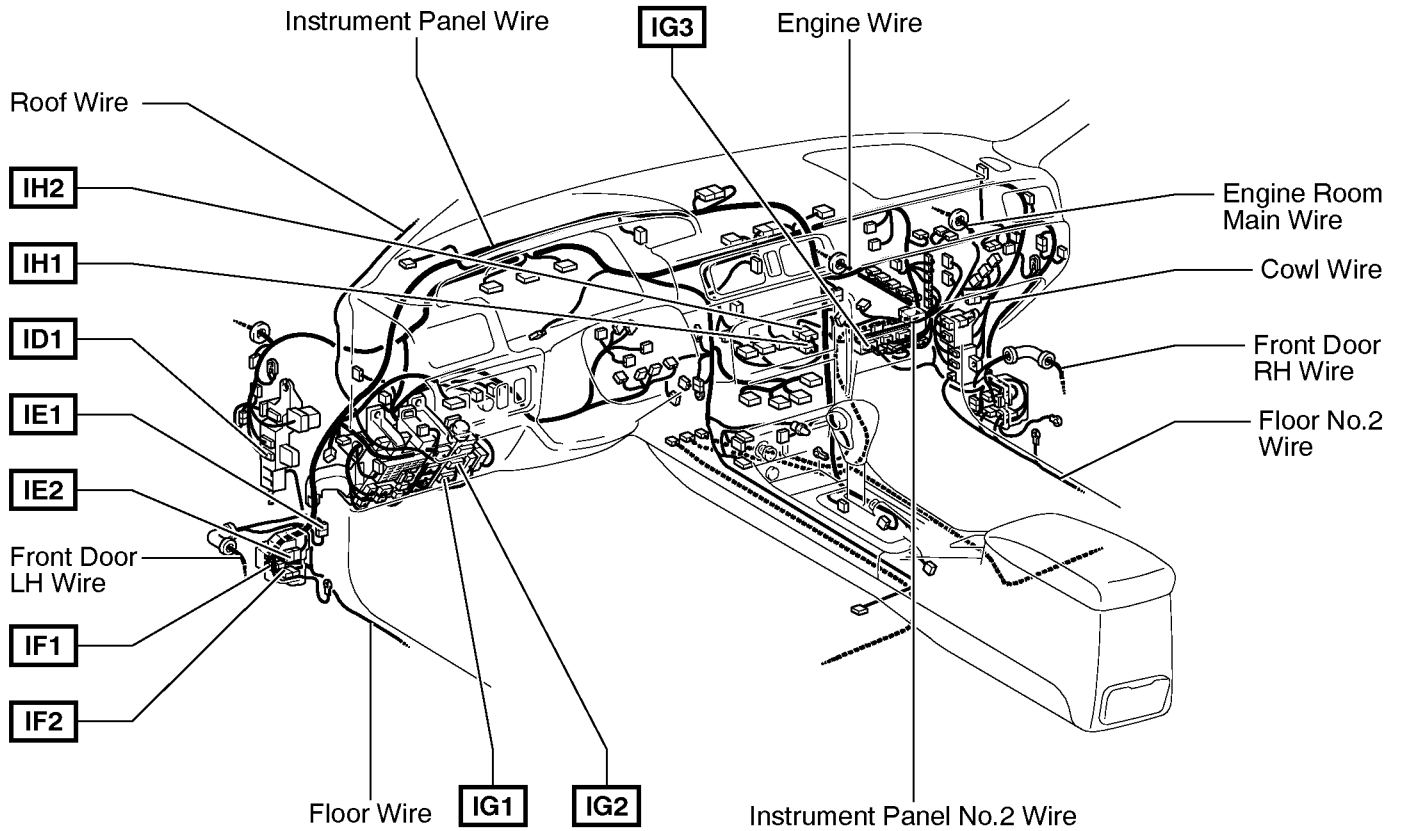

▽ : Location of Ground Points

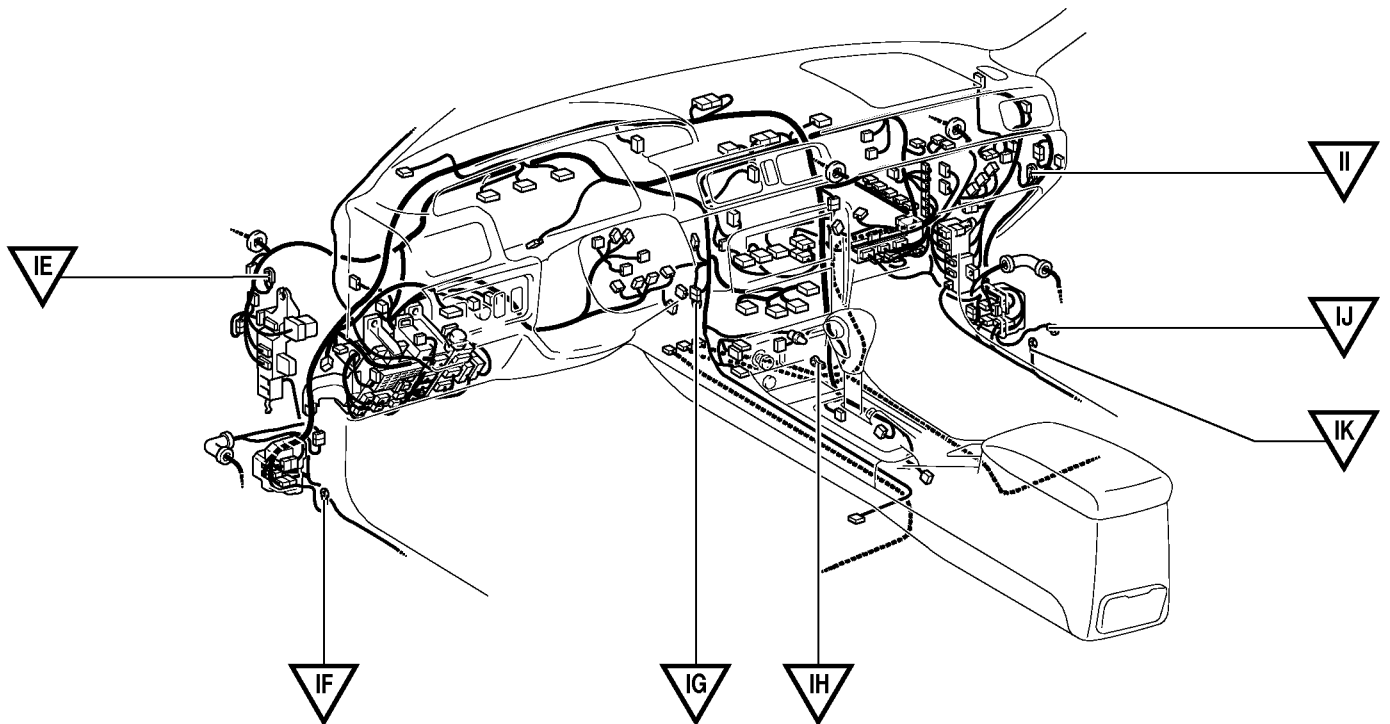

Connector Joining Wire Harness and Wire Harness

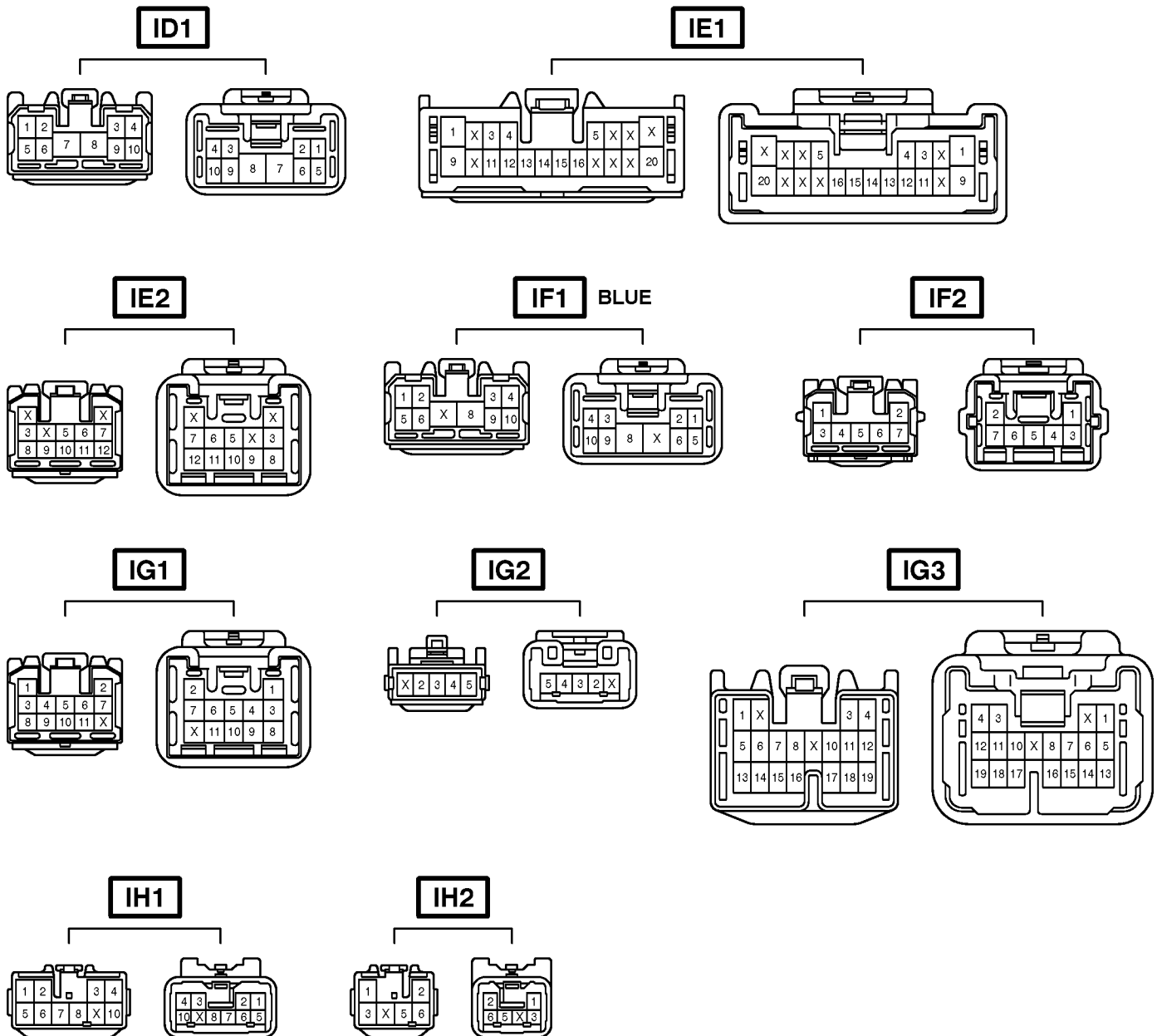

Code	Joining Wire Harness and Wire Harness (Connector Location)
ID1	Floor Wire and Cowl Wire (Left Kick Panel)
IE1	Front Door LH Wire and Instrument Panel Wire (Left Kick Panel)
IE2	Front Door LH Wire and Cowl Wire (Left Kick Panel)
IF1	Floor Wire and Instrument Panel Wire (Left Kick Panel)
IF2	Floor Wire and Instrument Panel Wire (Left Kick Panel)
IG1	Instrument Panel Wire and Cowl Wire (Lower Finish Panel)
IG2	Instrument Panel Wire and Cowl Wire (Lower Finish Panel)
IG3	Instrument Panel Wire and Cowl Wire (Under the Blower Motor)
IH1	Instrument Panel Wire and Instrument Panel No.2 Wire (Instrument Panel Brace RH)
IH2	Instrument Panel Wire and Instrument Panel No.2 Wire (Instrument Panel Brace RH)

G ELECTRICAL WIRING ROUTING

□ : Location of Connector Joining Wire Harness and Wire Harness

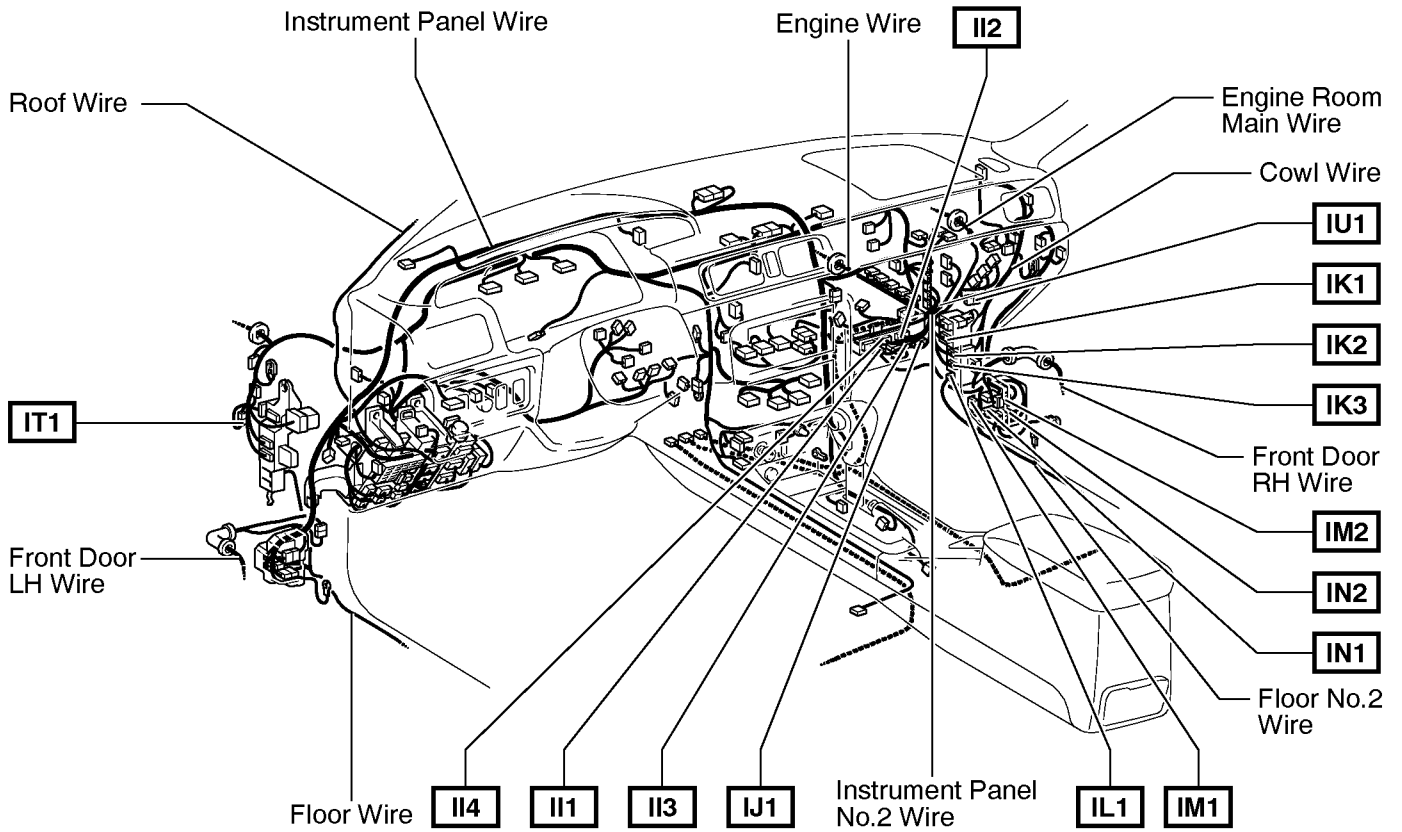

○ : Location of Splice Points

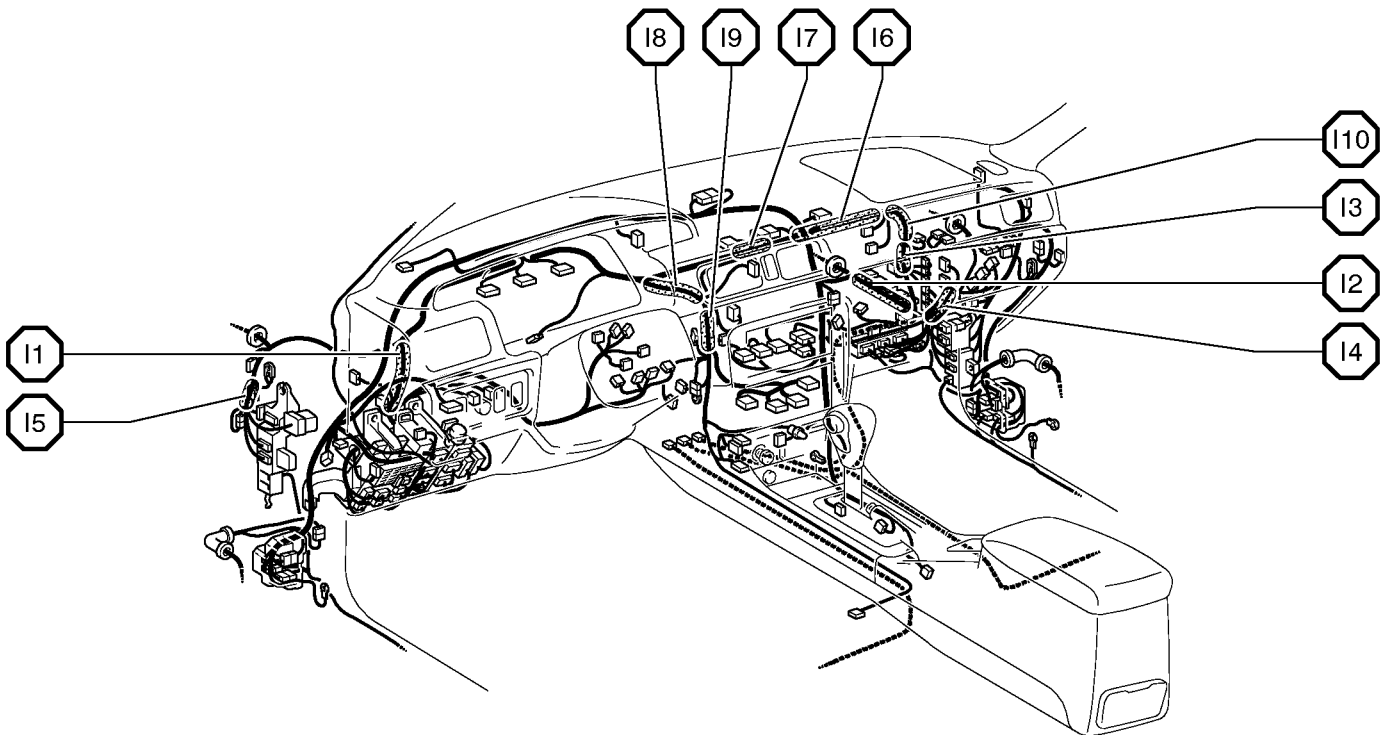

Connector Joining Wire Harness and Wire Harness

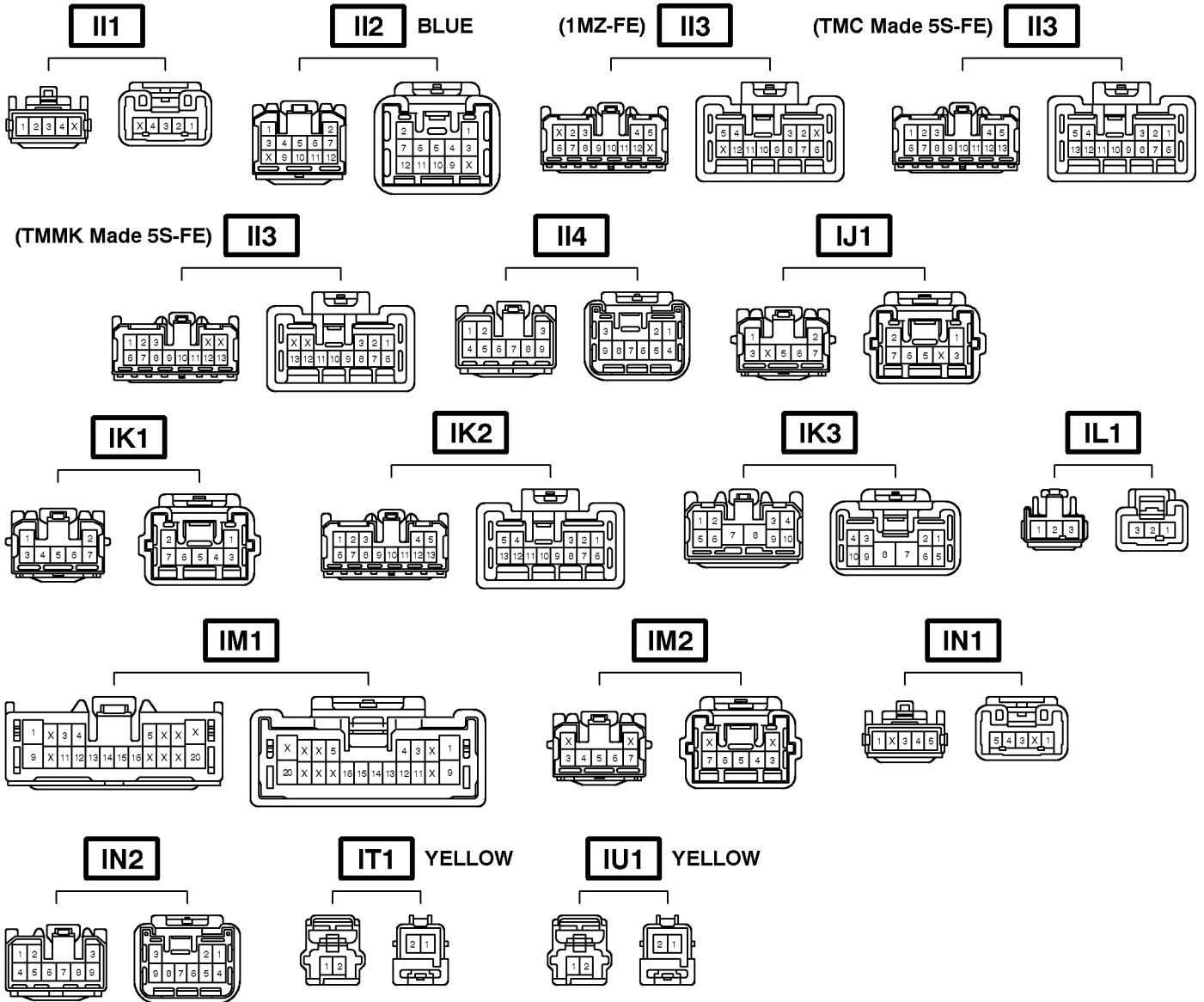

Code	Joining Wire Harness and Wire Harness (Connector Location)
II1	Engine Wire and Cowl Wire (Under the Blower Motor)
II2	
II3	
II4	
IJ1	Engine Wire and Instrument Panel Wire (Under the Blower Motor)
IK1	Engine Room Main Wire and Cowl Wire (Right Kick Panel)
IK2	
IK3	
IL1	Floor No.2 Wire and Cowl Wire (Right Kick Panel)
IM1	Front Door RH Wire and Instrument Panel Wire (Right Kick Panel)
IM2	
IN1	Floor No.2 Wire and Instrument Panel Wire (Right Kick Panel)
IN2	
IT1	Cowl Wire and Cowl Wire (Left Kick Panel)
IU1	Engine Room Main Wire and Cowl Wire (Right Kick Panel)

G ELECTRICAL WIRING ROUTING

□ : Location of Connector Joining Wire Harness and Wire Harness
 ▽ : Location of Ground Points

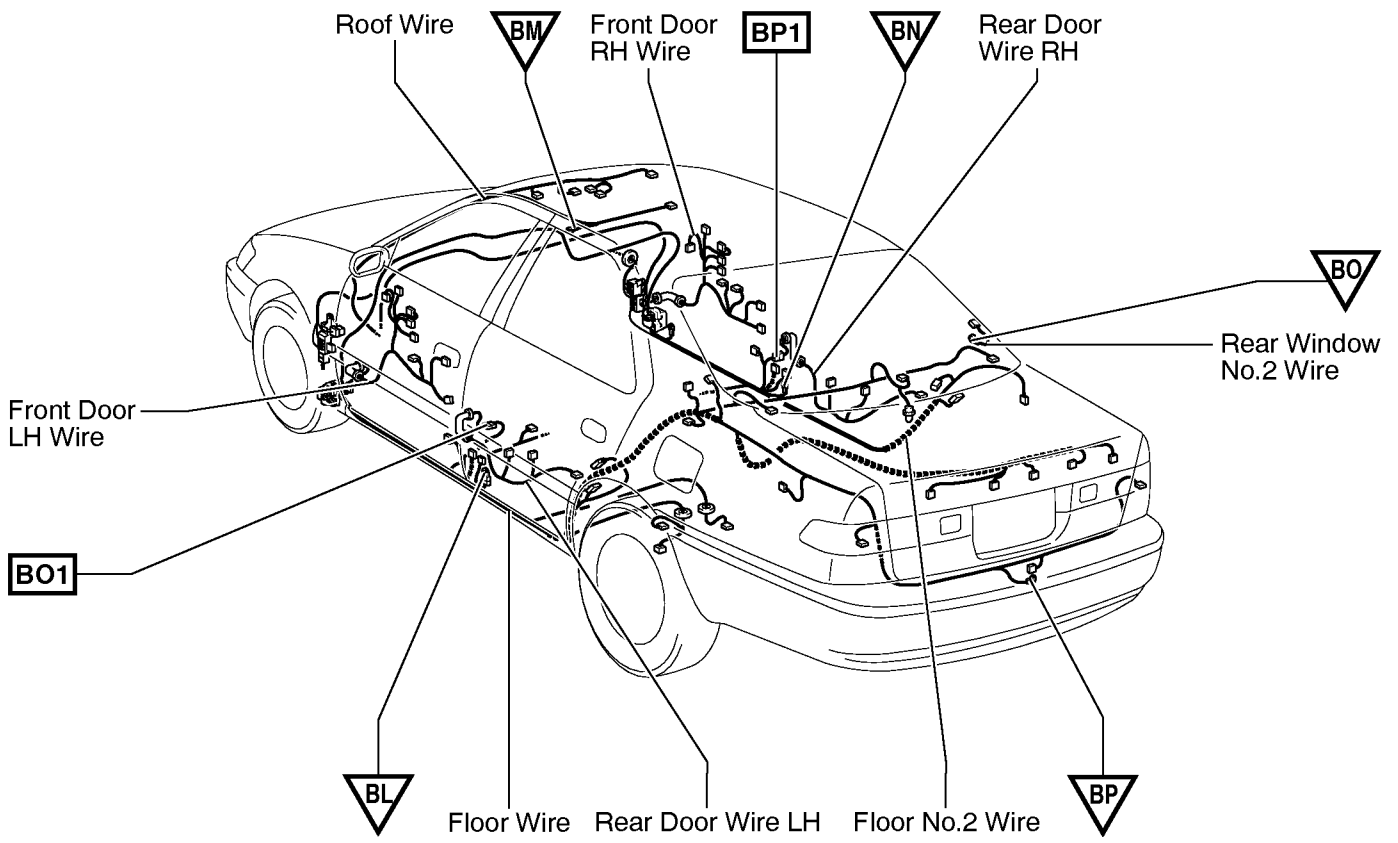

○ : Location of Splice Points

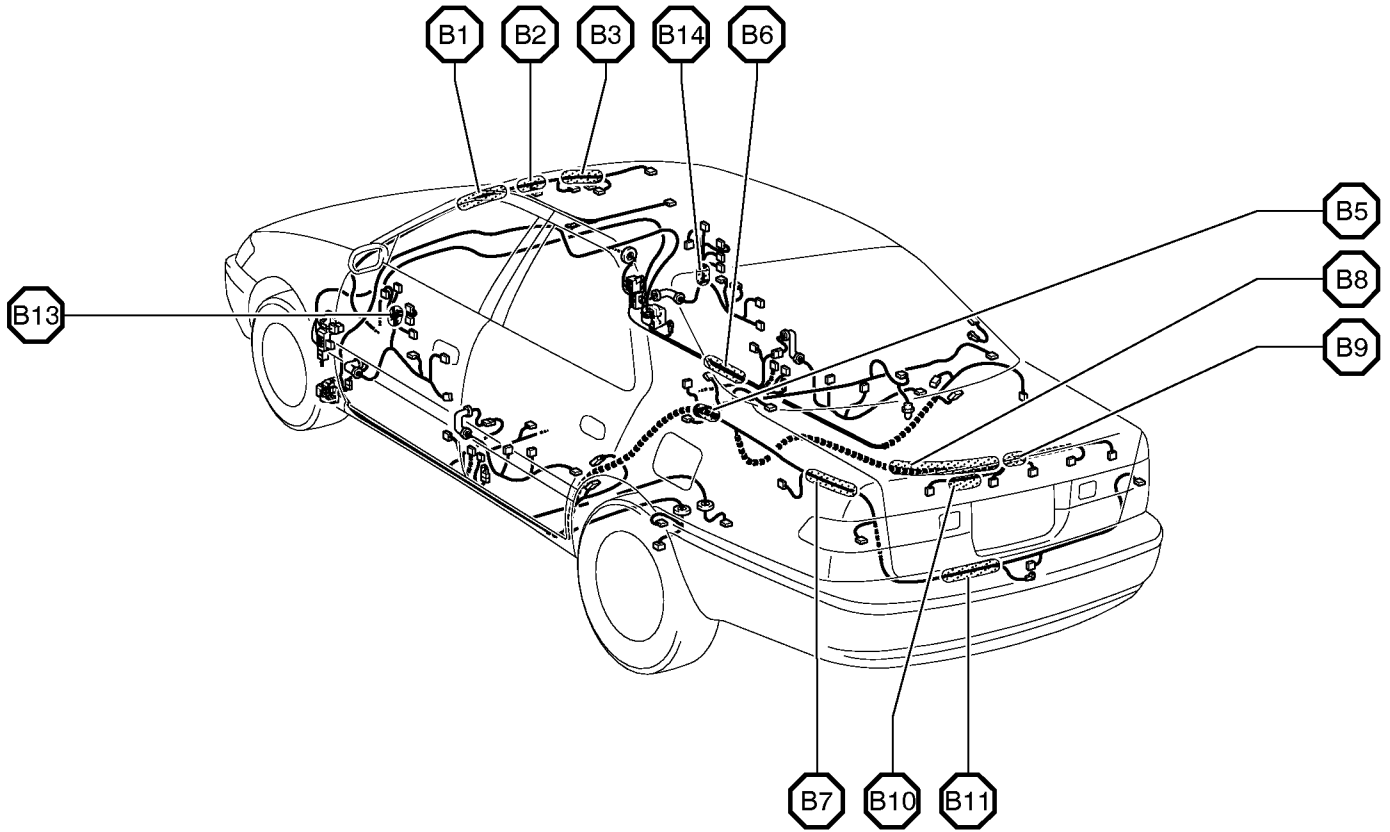

Connector Joining Wire Harness and Wire Harness

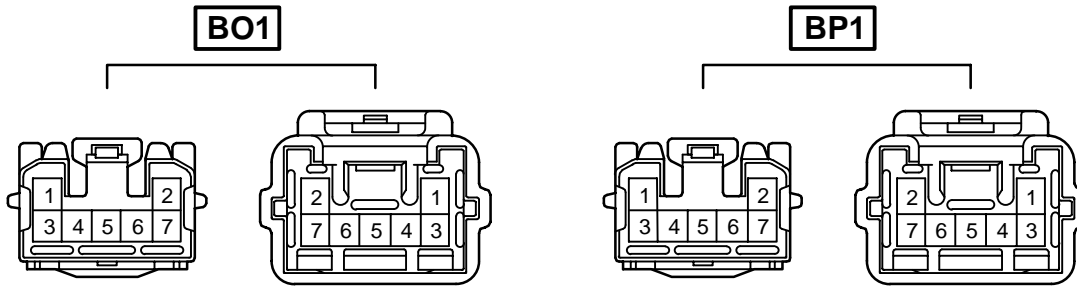

Code	Joining Wire Harness and Wire Harness (Connector Location)
BO1	Rear Door Wire LH and Floor Wire (Under the Left Center Pillar)
BP1	Rear Door Wire RH and Floor No.2 Wire (Under the Right Center Pillar)

G ELECTRICAL WIRING ROUTING

□ : Location of Connector Joining Wire Harness and Wire Harness

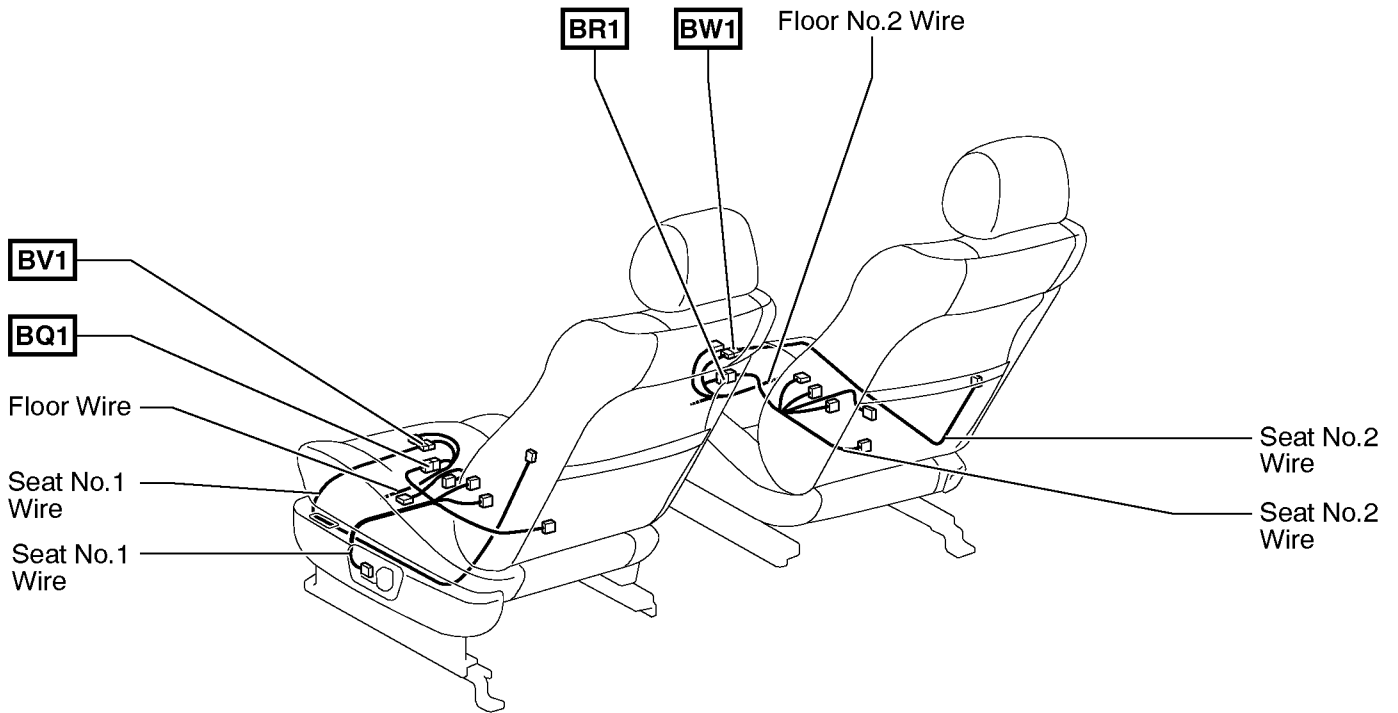

○ : Location of Splice Points

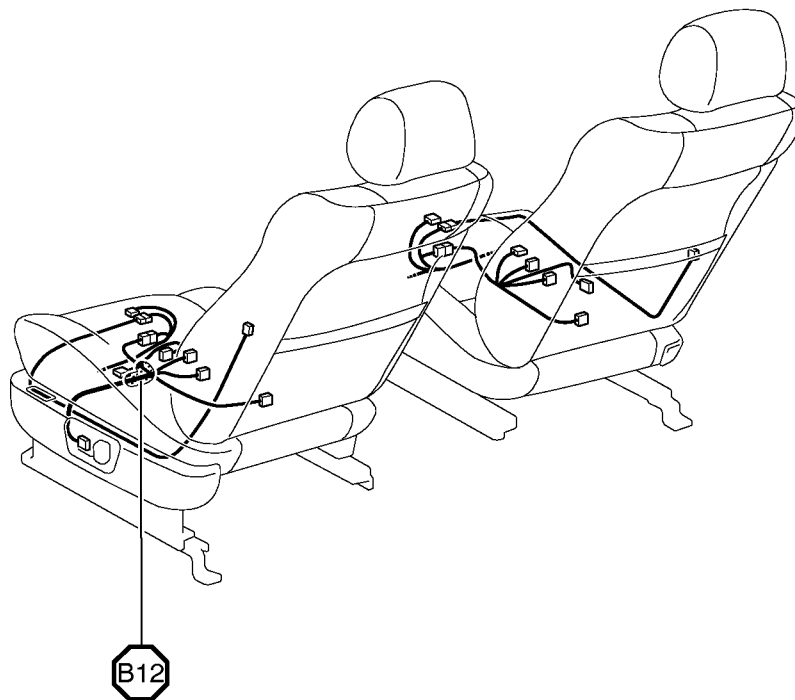

Connector Joining Wire Harness and Wire Harness

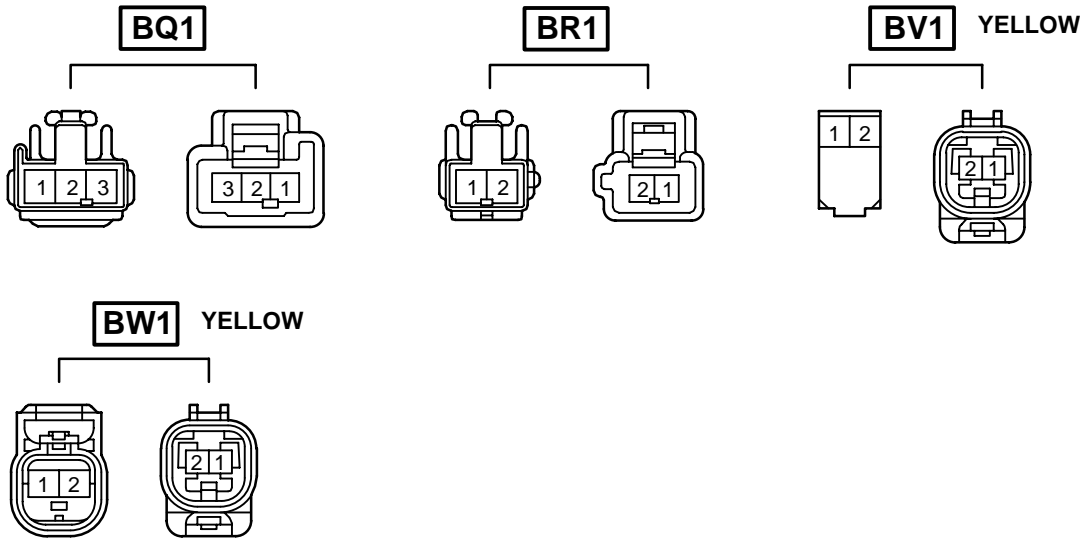

Code	Joining Wire Harness and Wire Harness (Connector Location)
BQ1	Floor Wire and Seat No.1 Wire (Under the Driver's Seat)
BR1	Floor No.2 Wire and Seat No.2 Wire (Under the Passenger's Seat)
BV1	Floor Wire and Seat No.1 Wire (Under the Driver's Seat)
BW1	Floor No.2 Wire and Seat No.2 Wire (Under the Passenger's Seat)

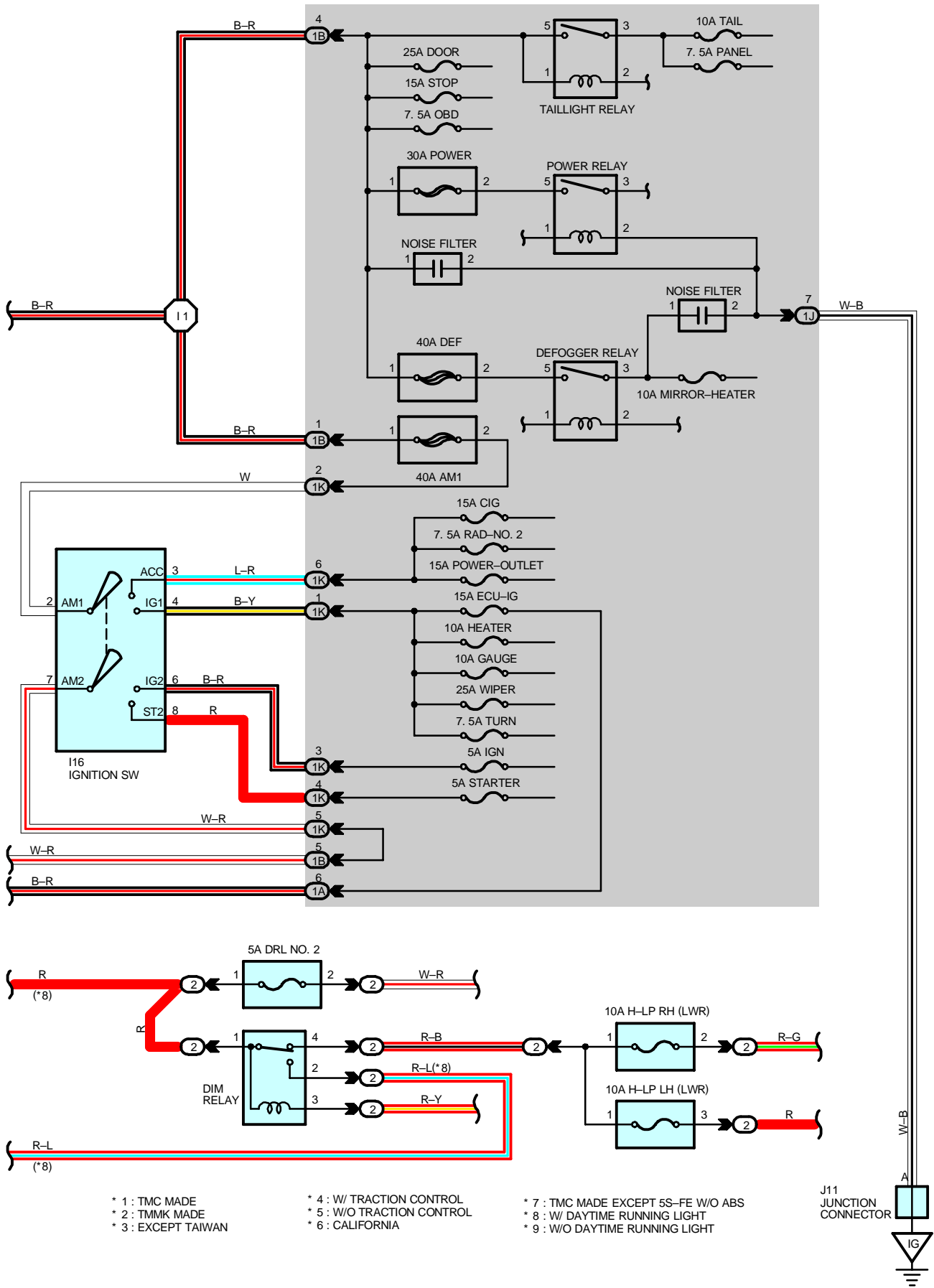

* 1 : TMC MADE
 * 2 : TMMK MADE
 * 3 : EXCEPT TAIWAN

* 4 : W/ TRACTION CONTROL
 * 5 : W/O TRACTION CONTROL
 * 6 : CALIFORNIA

* 7 : TMC MADE EXCEPT 5S-FE W/O ABS
 * 8 : W/ DAYTIME RUNNING LIGHT
 * 9 : W/O DAYTIME RUNNING LIGHT

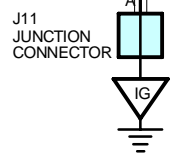

POWER SOURCE

SERVICE HINTS

HEAD RELAY [ENGINE ROOM J/B NO.2]

2-1 : Closed with the light control SW at **HEAD** position or the dimmer SW at **FLASH** position
 Closed with the engine running and the parking brake pedal released (Parking brake SW off) (w/ Daytime Running Light)

TAILLIGHT RELAY [INSTRUMENT PANEL J/B]

5-3 : Closed with the light control SW at **TAIL** or **HEAD** position

I16 IGNITION SW

2-3 : Closed with the ignition SW at **ACC** or **ON** position
 2-4 : Closed with the ignition SW at **ON** or **ST** position
 7-6 : Closed with the ignition SW at **ON** or **ST** position
 7-8 : Closed with the ignition SW at **ST** position

○ : PARTS LOCATION

Code	See Page	Code	See Page	Code	See Page
F4	A	F7	D	G1	26 (1MZ-FE)
					28 (5S-FE)
F5	B	F8	E	I16	26 (1MZ-FE)
					28 (5S-FE)
F6	C	F9	F	J11	26 (1MZ-FE)
					28 (5S-FE)

○ : RELAY BLOCKS

Code	See Page	Relay Blocks (Relay Block Location)
1	24	Engine Room R/B No.1 (Engine Compartment Left)
2	24	Engine Room R/B No.2 (Near the Battery)
3	25	Engine Room R/B No.3 (Radiator Upper Support RH)

○ : JUNCTION BLOCK AND WIRE HARNESS CONNECTOR

Code	See Page	Junction Block and Wire Harness (Connector Location)
1A	20	Cowl Wire and J/B Instrument Panel J/B (Lower Finish Panel)
1B		
1J		
1K		
2A	22	Engine Room Main Wire and Engine Room J/B No.2 (Engine Compartment Left)
2B		
2C		
2F		
2G	22	Cowl Wire and Engine Room J/B No.2 (Engine Compartment Left)
2K		
2L		

▽ : GROUND POINTS

Code	See Page	Ground Points Location
EB	36 (1MZ-FE)	Left Radiator Side Support
	38 (5S-FE)	
IG	40	Instrument Panel Brace LH

○ : SPLICE POINTS

Code	See Page	Wire Harness with Splice Points	Code	See Page	Wire Harness with Splice Points
E3	36 (1MZ-FE)	Cowl Wire	I1	42	Cowl Wire
	38 (5S-FE)				

F4 (A)

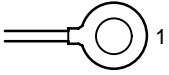

F5 (B)

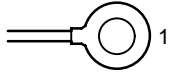

F6 (C)

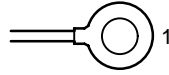

F7 (D)

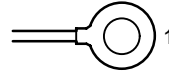

F8 (E)

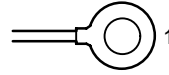

F9 (F)
ORANGE

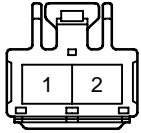

G1

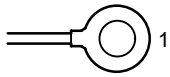

I16

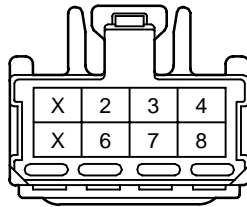

J11

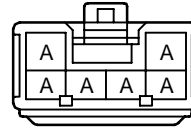

(Hint : See Page 7)

STARTING AND IGNITION (1MZ-FE)

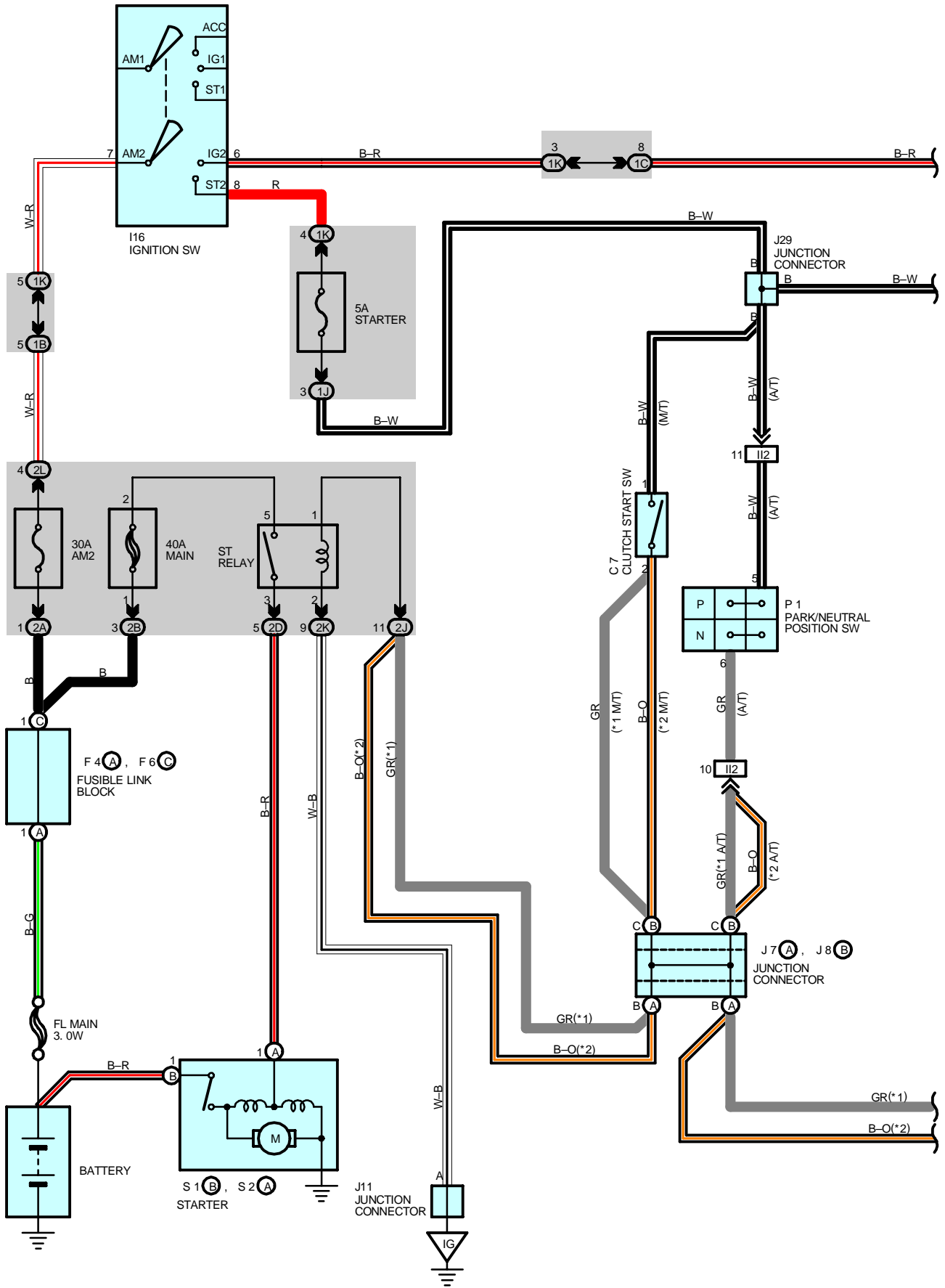

STARTING AND IGNITION (1MZ-FE)

SERVICE HINTS

I16 IGNITION SW

7-6 : Closed with the ignition SW at **ON** or **ST** position

7-8 : Closed with the ignition SW at **ST** position

P1 PARK/NEUTRAL POSITION SW

5-6 : Closed with the A/T shift lever in **P** or **N** position (A/T)

S1 (B), S2 (A) STARTER

Points closed with the Park/Neutral position SW at **P** or **N** position and the ignition SW at **ST** position (A/T)

Points closed with the clutch start SW on and the ignition SW at **ST** position (M/T)

○ : PARTS LOCATION

Code	See Page	Code	See Page	Code	See Page
C7	30	I5	27 (1MZ-FE)	J18	31
E7	A 30	I6	27 (1MZ-FE)	J29	31
E8	B 30	I7	27 (1MZ-FE)	N1	27 (1MZ-FE)
E11	E 30	I16	30	P1	27 (1MZ-FE)
F4	A 26 (1MZ-FE)	J7	A 31	S1	B 27 (1MZ-FE)
F6	C 26 (1MZ-FE)	J8	B 31	S2	A 27 (1MZ-FE)
I2	27 (1MZ-FE)	J11	31		

○ : JUNCTION BLOCK AND WIRE HARNESS CONNECTOR

Code	See Page	Junction Block and Wire Harness (Connector Location)
1B	20	Cowl Wire and Instrument Panel J/B (Lower Finish Panel)
1C		
1J		
1K		
2A	22	Engine Room Main Wire and Engine Room J/B No.2 (Engine Compartment Left)
2B		
2D		
2J	22	Cowl Wire and Engine Room J/B No.2 (Engine Compartment Left)
2K		
2L		

□ : CONNECTOR JOINING WIRE HARNESS AND WIRE HARNESS

Code	See Page	Joining Wire Harness and Wire Harness (Connector Location)
I12	42	Engine Wire and Cowl Wire (Under the Blower Motor)
I13		

▽ : GROUND POINTS

Code	See Page	Ground Points Location
ED	36 (1MZ-FE)	Rear Side of the Surge Tank
IG	40	Instrument Panel Brace LH

C7

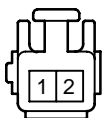

E7 (A)

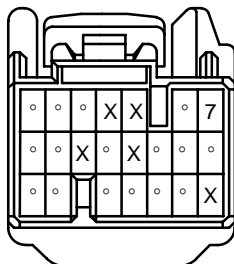

E8 (B)

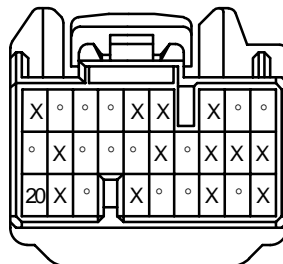

E11 (E)
(California)

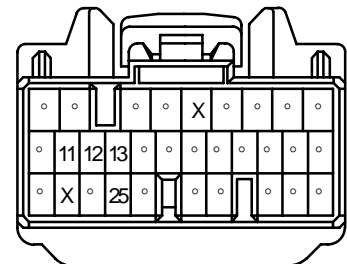

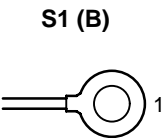
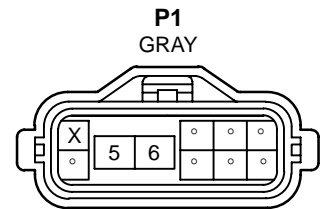
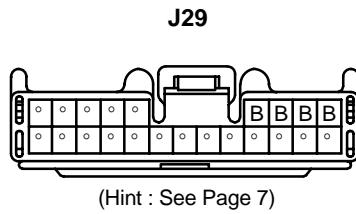
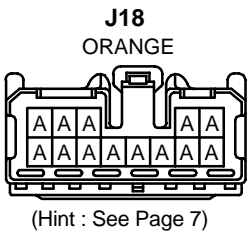
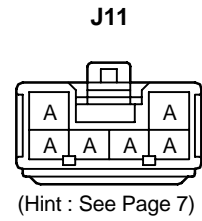
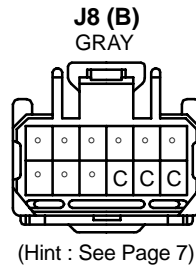
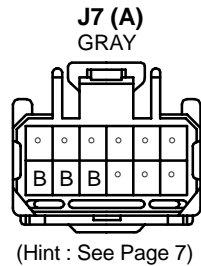
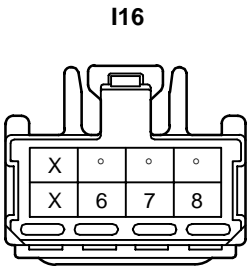
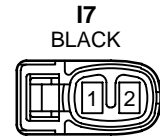
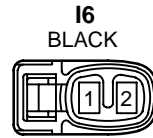
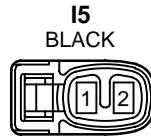
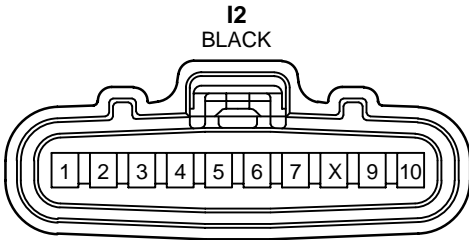
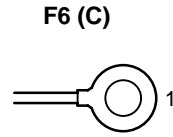
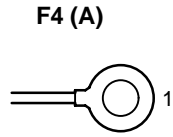
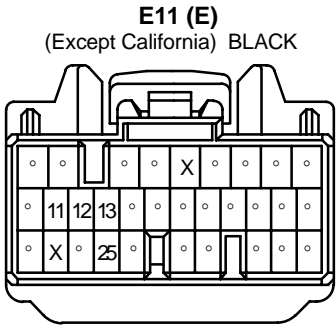

STARTING AND IGNITION (5S-FE)

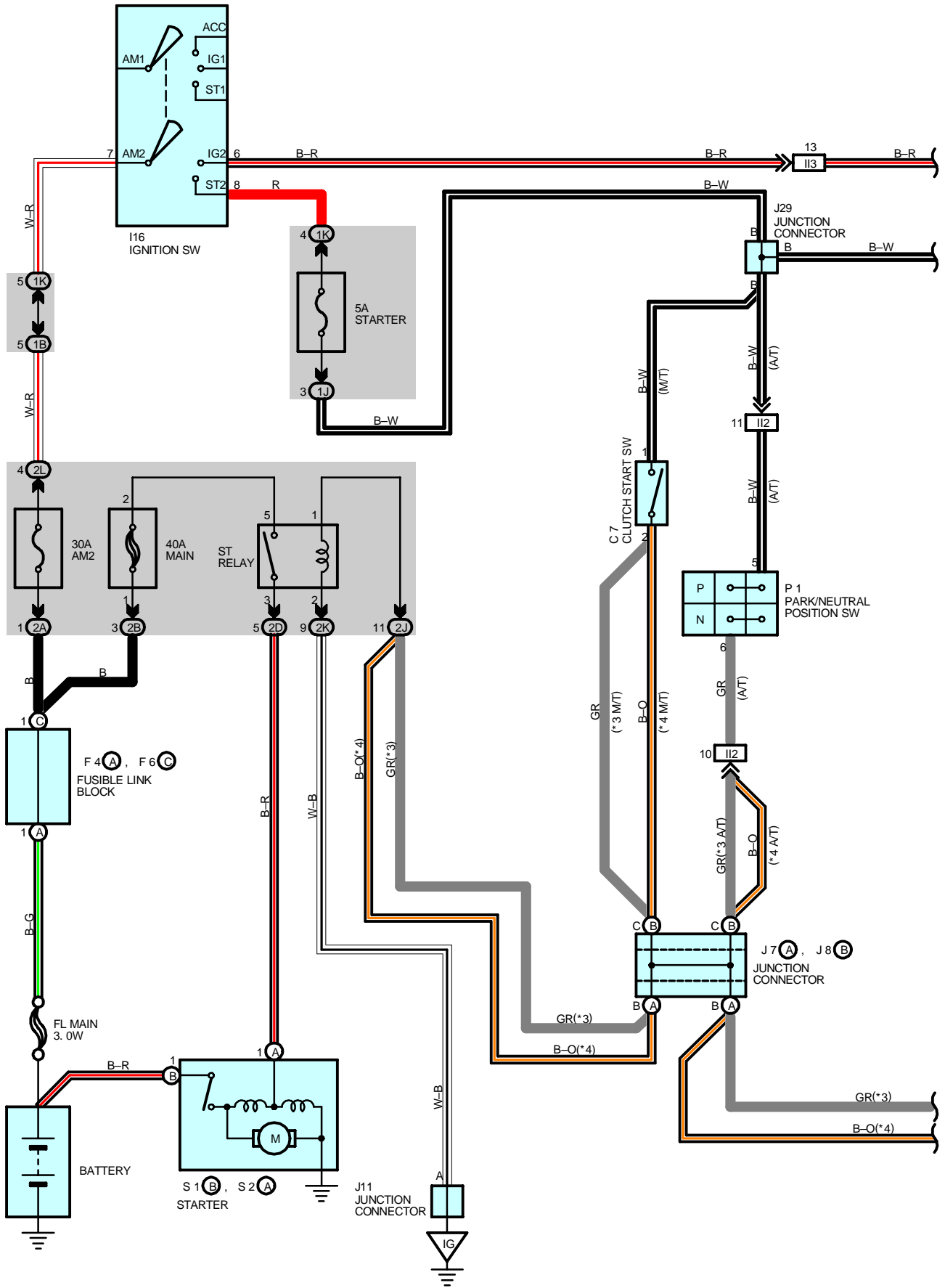

* 1 : W/ ENGINE IMMOBILISER SYSTEM
 * 2 : W/O ENGINE IMMOBILISER SYSTEM

* 3 : TMC MADE
 * 4 : TMMK MADE

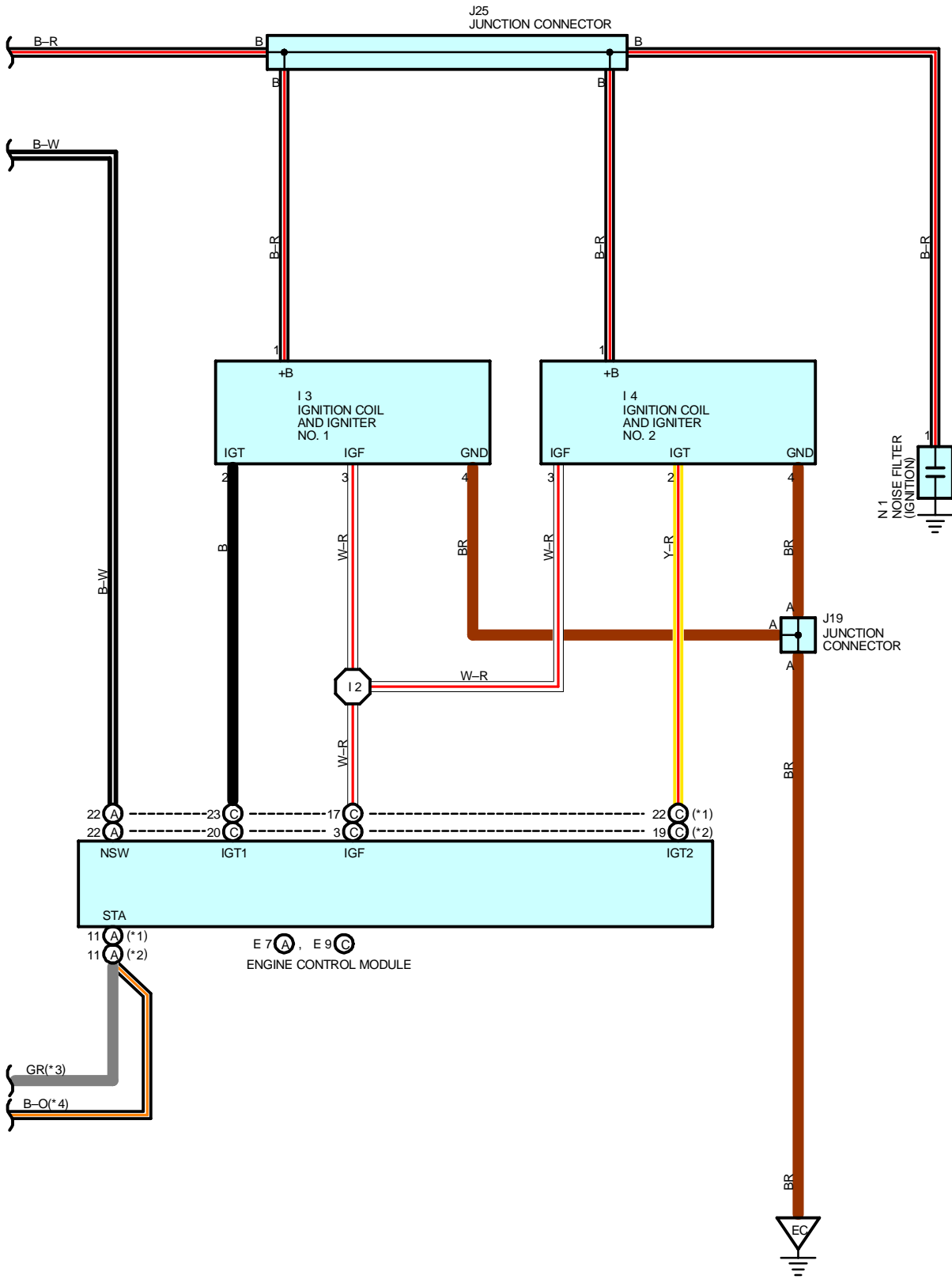

STARTING AND IGNITION (5S-FE)

SERVICE HINTS

I16 IGNITION SW

7-6 : Closed with the ignition SW at **ON** or **ST** position

7-8 : Closed with the ignition SW at **ST** position

P1 PARK/NEUTRAL POSITION SW

5-6 : Closed with the A/T shift lever in **P** or **N** position (A/T)

S1 (B), S2 (A) STARTER

Points closed with the Park/Neutral position SW at **P** or **N** position and the ignition SW at **ST** position (A/T)

Points closed with the clutch start SW on and the ignition SW at **ST** position (M/T)

○ : PARTS LOCATION

Code	See Page	Code	See Page	Code	See Page
C7	30	I16	30	N1	29 (5S-FE)
E7	A 30	J7	A 31	P1	29 (5S-FE)
E9	C 30	J8	B 31	S1	B 29 (5S-FE)
F4	A 28 (5S-FE)	J11	31	S2	A 29 (5S-FE)
F6	C 28 (5S-FE)	J19	31		
I3	29 (5S-FE)	J25	31		
I4	29 (5S-FE)	J29	31		

○ : JUNCTION BLOCK AND WIRE HARNESS CONNECTOR

Code	See Page	Junction Block and Wire Harness (Connector Location)
1B	20	Cowl Wire and Instrument Panel J/B (Lower Finish Panel)
1J		
1K		
2A	22	Engine Room Main Wire and Engine Room J/B No.2 (Engine Compartment Left)
2B		
2D		
2J	22	Cowl Wire and Engine Room J/B No.2 (Engine Compartment Left)
2K		
2L		

□ : CONNECTOR JOINING WIRE HARNESS AND WIRE HARNESS

Code	See Page	Joining Wire Harness and Wire Harness (Connector Location)
I12	42	Engine Wire and Cowl Wire (Under the Blower Motor)
I13		

▽ : GROUND POINTS

Code	See Page	Ground Points Location
EC	38 (5S-FE)	Surge Tank RH
IG	40	Instrument Panel Brace LH

○ : SPLICE POINTS

Code	See Page	Wire Harness with Splice Points	Code	See Page	Wire Harness with Splice Points
I2	42	Engine Wire			

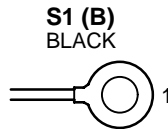
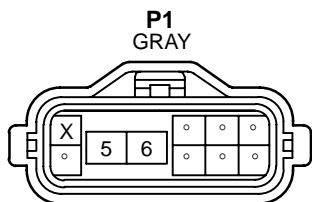
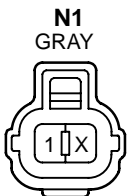
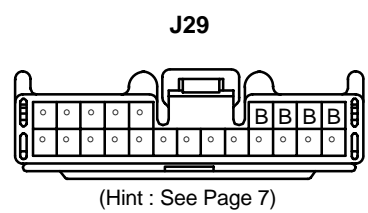
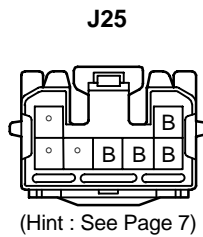
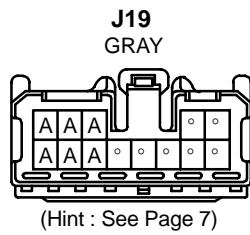
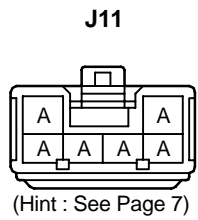
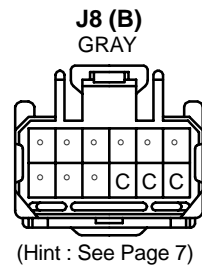
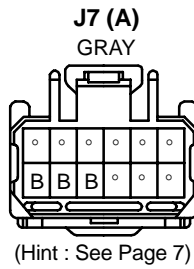
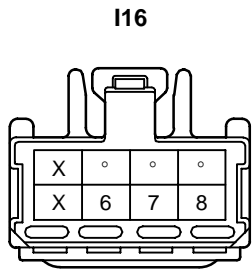
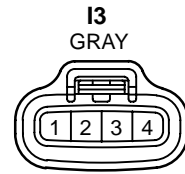
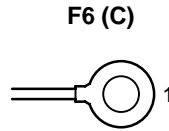
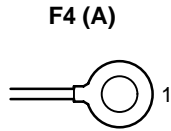
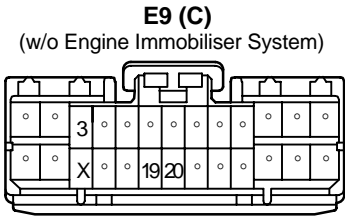
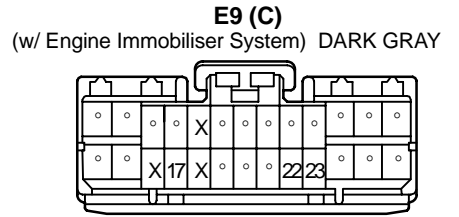
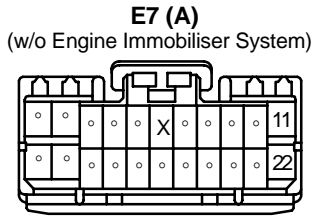
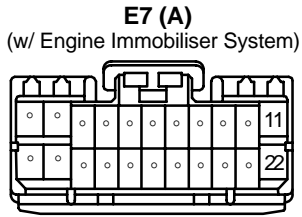
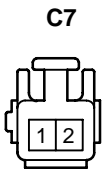

CHARGING

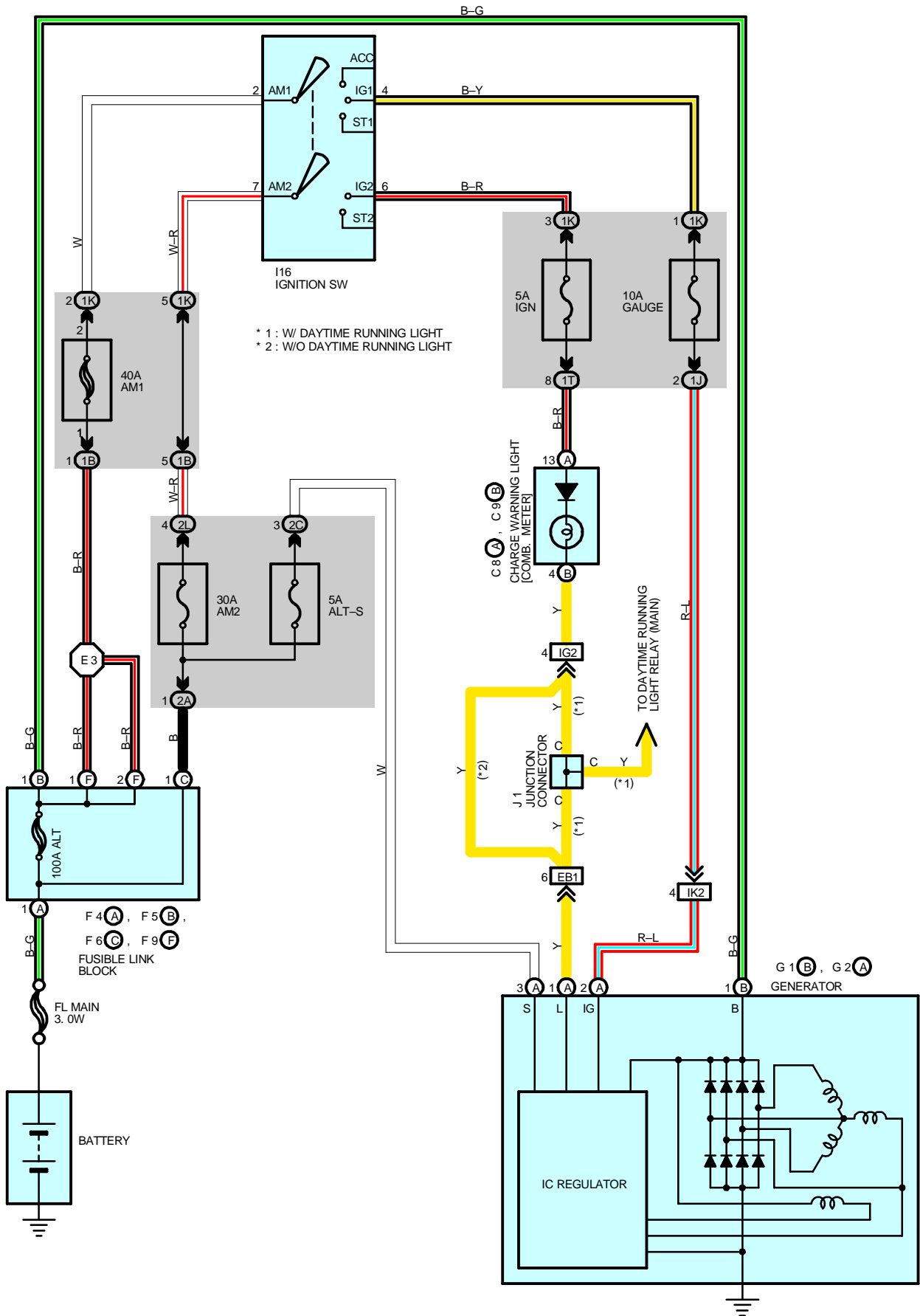

SERVICE HINTS**G2 (A) GENERATOR**

- (A) 3-GROUND : **13.9–15.1** volts with the engine running at **2000** rpm and **25°C (77°F)**
13.5–14.3 volts with the engine running at **5000** rpm and **115°C (239°F)**
 (A) 1-GROUND : **0–4** volts with the ignition SW at **ON** position and the engine not running

○ : PARTS LOCATION

Code		See Page	Code		See Page	Code		See Page
C8	A	30	F6	C	26 (1MZ-FE)	G2	A	26 (1MZ-FE)
C9	B	30			28 (5S-FE)			28 (5S-FE)
F4	A	26 (1MZ-FE)	F9	F	26 (1MZ-FE)	I16	J1	30
		28 (5S-FE)			28 (5S-FE)			31
F5	B	26 (1MZ-FE)	G1	B	26 (1MZ-FE)			
		28 (5S-FE)			28 (5S-FE)			

○ : JUNCTION BLOCK AND WIRE HARNESS CONNECTOR

Code	See Page	Junction Block and Wire Harness (Connector Location)
1B	20	Cowl Wire and Instrument Panel J/B (Lower Finish Panel)
1J		
1K		
1T	20	Instrument Panel Wire and Instrument Panel J/B (Lower Finish Panel)
2A	22	Engine Room Main Wire and Engine Room J/B No.2 (Engine Compartment Left)
2C		
2L	22	Cowl Wire and Engine Room J/B No.2 (Engine Compartment Left)

□ : CONNECTOR JOINING WIRE HARNESS AND WIRE HARNESS

Code	See Page	Joining Wire Harness and Wire Harness (Connector Location)
EB1	36 (1MZ-FE)	Cowl Wire and Engine Room Main Wire (Under the Engine Room J/B No.2)
	38 (5S-FE)	
IG2	40	Instrument Panel Wire and Cowl Wire (Lower Finish Panel)
IK2	42	Engine Room Main Wire and Cowl Wire (Right Kick Panel)

○ : SPLICE POINTS

Code	See Page	Wire Harness with Splice Points	Code	See Page	Wire Harness with Splice Points
E3	36 (1MZ-FE)	Cowl Wire	E3	38 (5S-FE)	Cowl Wire

CHARGING

C8 (A)
(TMC Made) BLUE

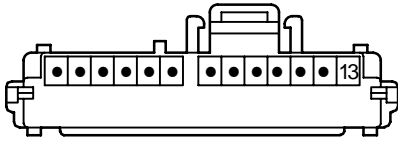

C8 (A)
(TMMK Made) BLUE

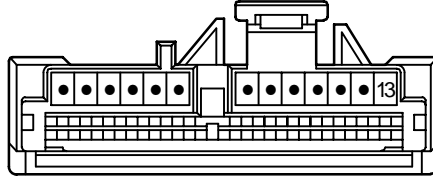

C9 (B)
(TMC Made)

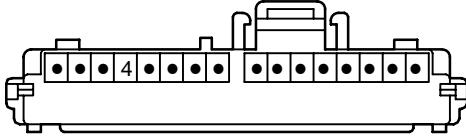

C9 (B)

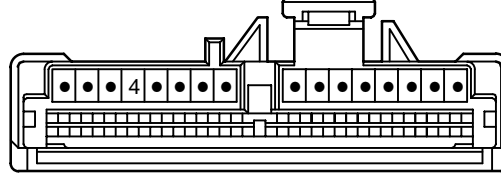

F4 (A)

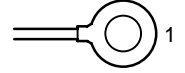

F5 (B)

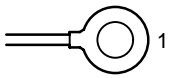

F6 (C)

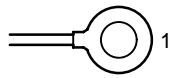

F9 (F)
ORANGE

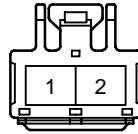

G1 (B)

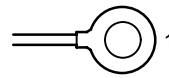

G2 (A)
BLACK

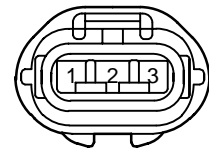

I16

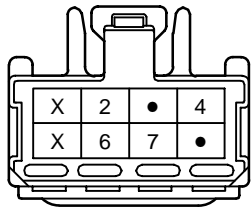

J1

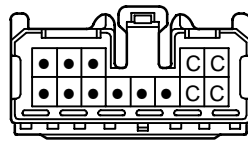

(Hint : See Page 7)

ENGINE CONTROL (1MZ-FE)

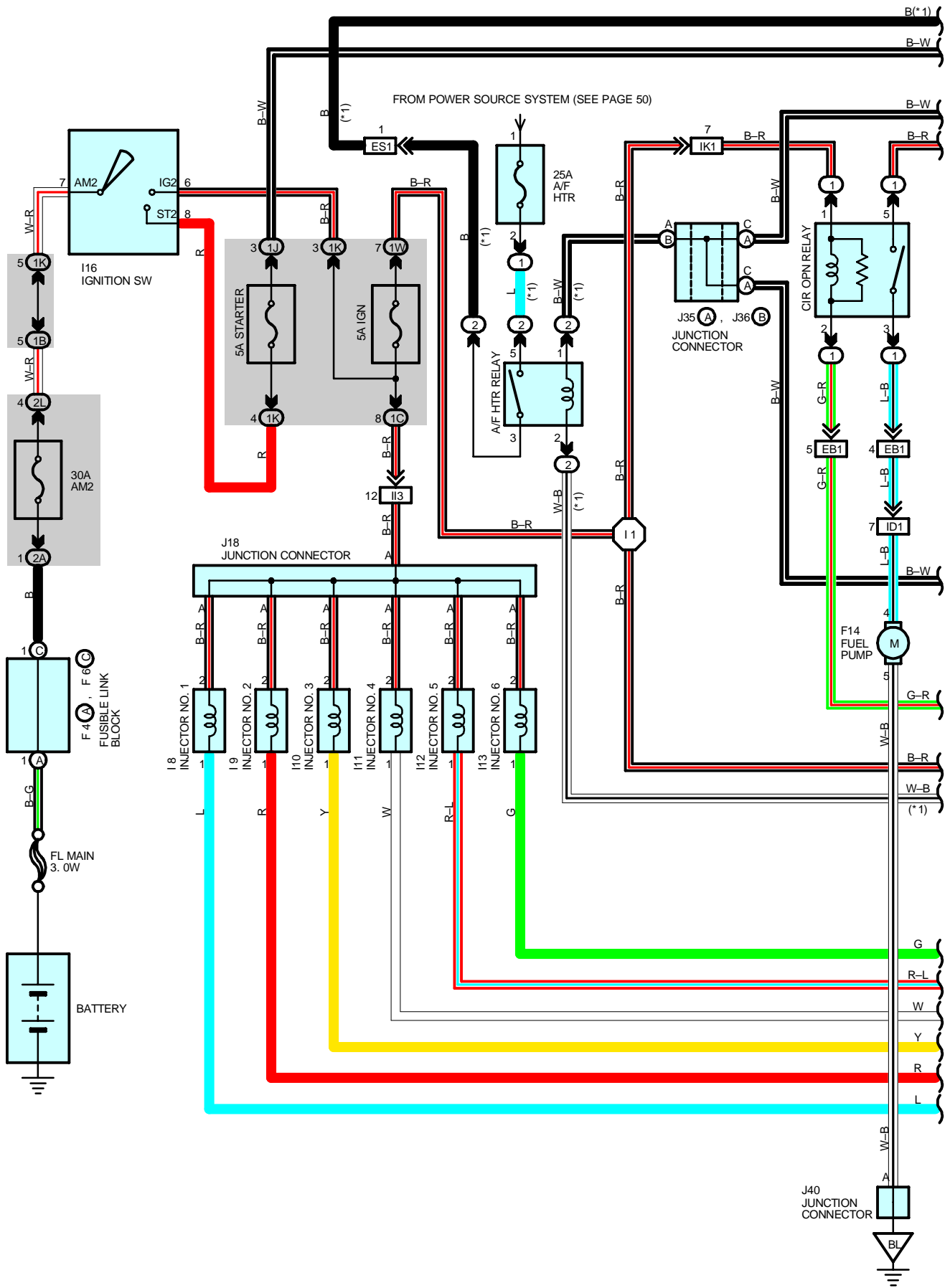

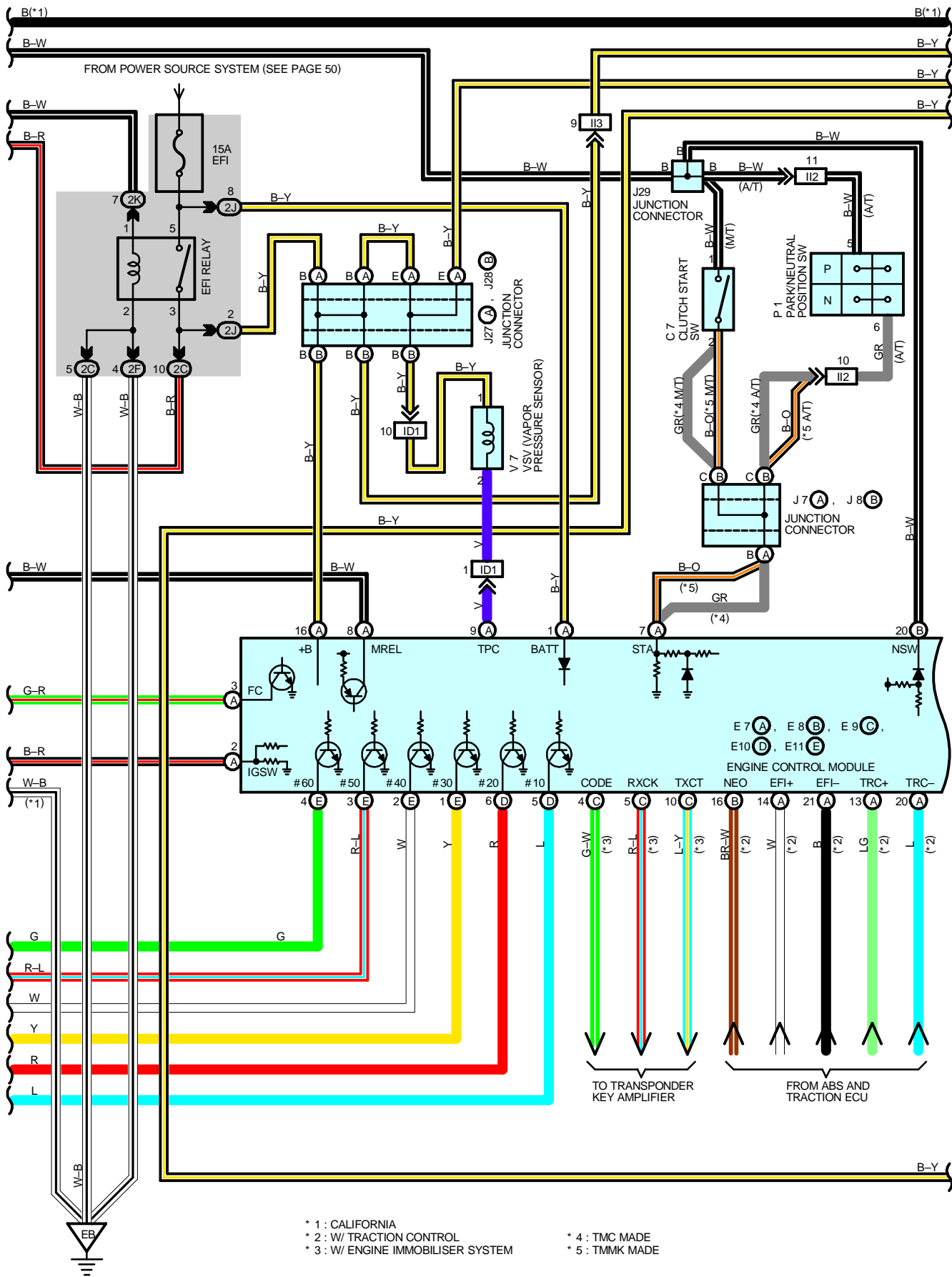

* 1 : CALIFORNIA
 * 2 : W/ TRACTION CONTROL
 * 3 : W/ ENGINE IMMOBILISER SYSTEM
 * 4 : TMC MADE
 * 5 : TMMK MADE

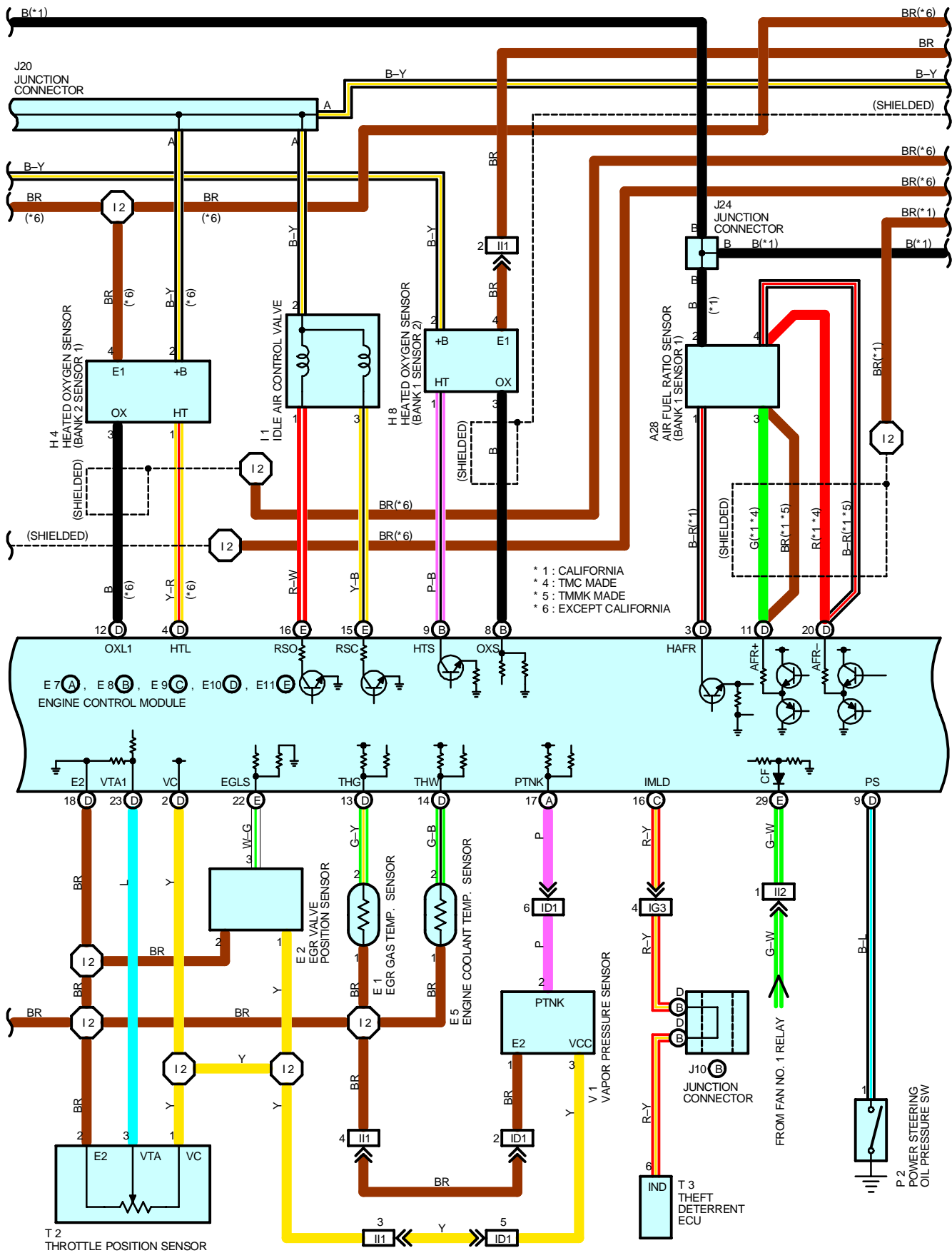

ENGINE CONTROL (1MZ-FE)

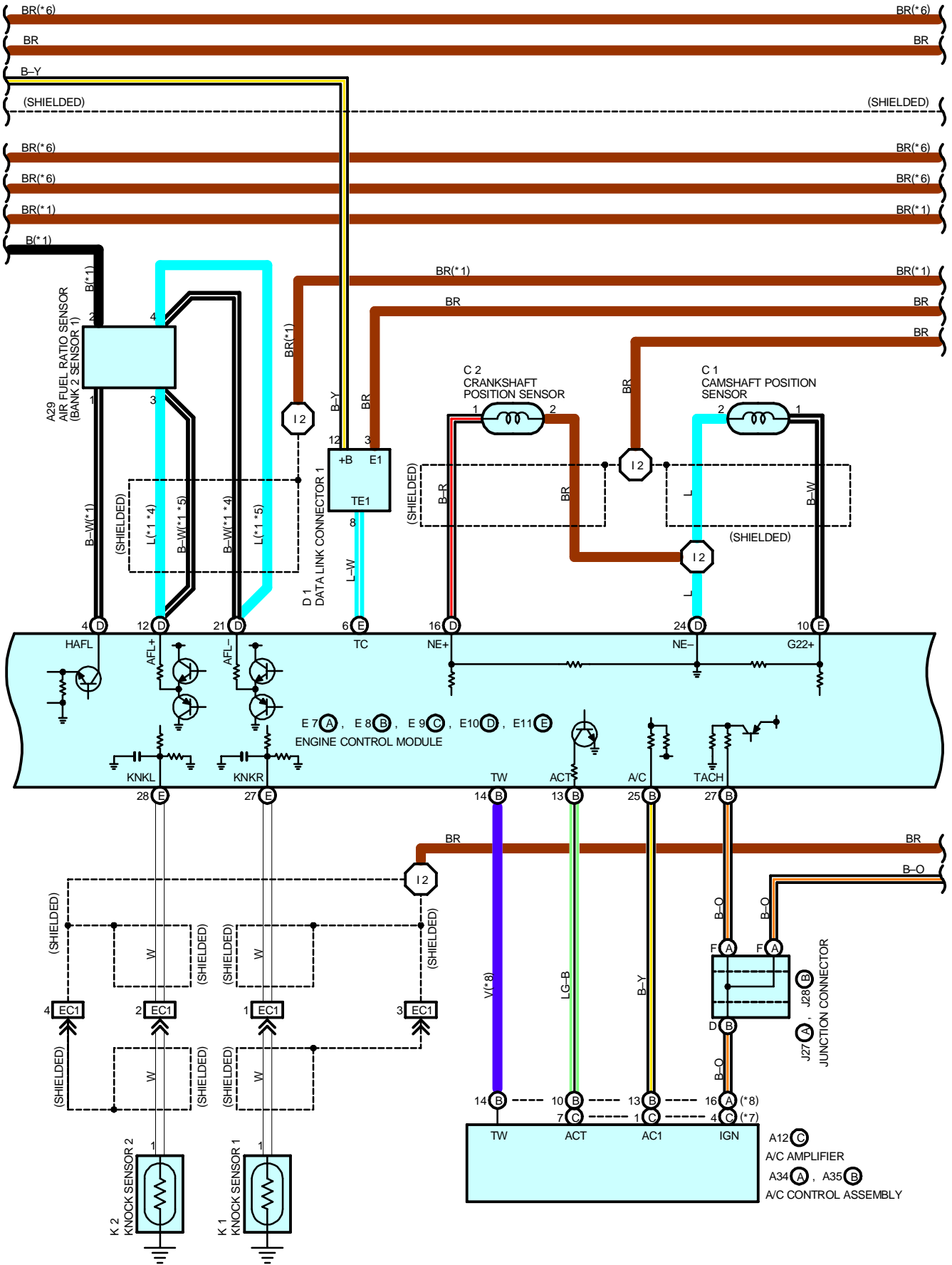

SYSTEM OUTLINE

This system utilizes an engine control module and maintains overall control of the engine, transmission and so on. An outline of the engine control is explained here.

1. INPUT SIGNALS

- (1) Engine coolant temp. signal circuit
The engine coolant temp. sensor detects the engine coolant temp. and has a built-in thermistor with a resistance which varies according to the water temp. is input into TERMINAL THW of the engine control module as a control signal.
- (2) Intake air temp. signal circuit
The intake air temp. sensor is installed in the mass air flow meter and detects the intake air temp., which is input as a control signal into TERMINAL THA of the engine control module.
- (3) Oxygen sensor signal circuit
The oxygen density in the exhaust gases is detected and input as a control signal into TERMINALS OXL1, OXR1 (Except California) and OXS of the engine control module. To maintain stable detection performance by the heated oxygen sensor, a heater is used for warming the sensor. The heater is also controlled by the engine control module (HTL, HTR (Except California) and HTS).
- (4) RPM signal circuit
Camshaft position and crankshaft position are detected by the camshaft position sensor and crankshaft position sensor. The camshaft position is input as a control signal to TERMINAL G22+ of the engine control module, and the engine RPM is input into TERMINAL NE+.
- (5) Throttle signal circuit
The throttle position sensor detects the throttle valve opening angle as a control signal, which is input into TERMINAL VTA1 of the engine control module.
- (6) Vehicle speed signal circuit
The vehicle speed sensor, installed inside the transmission, detects the vehicle speed and inputs a control signal into TERMINAL SPD of the engine control module.
- (7) Park/Neutral position SW signal circuit
The Park/Neutral position SW detects whether the shift position is in neutral, parking or not, and inputs a control signal into TERMINAL STA of the engine control module.
- (8) A/C SW signal circuit
The A/C control assembly (Automatic A/C) or A/C Amplifier (Manual A/C) inputs the A/C operations into TERMINAL A/C of the engine control module as a control signal.
- (9) Battery signal circuit
(California or w/ engine immobiliser and/or traction control)
Voltage is always supplies to TERMINAL BATT of the engine control module.
If you turn on the ignition SW, the current goes from TERMINAL MREL of the engine control module to the EFI relay and put on the relay, and the voltage related to the engine control module operation is supplied to TERMINAL +B of the engine control module through the EFI relay.
(Except California or w/ engine immobiliser and/or traction control)
Voltage is constantly applied to TERMINAL BATT of the engine control module. When the ignition SW is turned on, voltage for engine control module start-up power supply is applied to TERMINAL +B of engine control module via EFI relay.
- (10) Intake air volume signal circuit
Intake air volume is detected by the mass air flow meter and a signal is input into TERMINAL VG of the engine control module as a control signal.
- (11) NSW signal circuit
To confirm whether the engine is cranking, the voltage applied to the starter motor during cranking is detected and the signal is input into TERMINAL NSW of the engine control module as a control signal.
- (12) Engine knock signal circuit
Engine knocking is detected by the knock sensor 1 and 2, then the signals are input into TERMINALS KNKR and KNKL of the engine control module as a control signal.
- (13) Air fuel ratio signal circuit (California)
The air fuel ratio is detected and input as a control signal into TERMINALS AFL+, AFR+ of the engine control module.

ENGINE CONTROL (1MZ-FE)

2. CONTROL SYSTEM

* SFI system

The SFI system monitors the engine condition through the signals, which are input from each sensor (Input signals (1) to (12)). The best fuel injection volume is decided based on this data and the program memorized by the engine control module, and the control signal is output to TERMINALS #10, #20, #30, #40, #50 and #60 of the engine control module to operate the injector (Inject the fuel). The SFI system produces control of fuel injection operation by the engine control module in response to the driving conditions.

* ESA system

The ESA system monitors the engine condition through the signals, which are input to the engine control module from each sensor (Input signals from 1, 3, 4, 12). The best ignition timing is decided according to this data and the memorized data in the engine control module and the control signal is output to TERMINALS IGT1, IGT2 and IGT3. This signal controls the igniter to provide the best ignition timing for the driving conditions.

* Heated oxygen sensor heater control system

The heated oxygen sensor heater control system turns the heater on when the intake air volume is low (Temp. of exhaust emissions is low), and warms up the heated oxygen sensor to improve detection performance of the sensor.

The engine control module evaluates the signals from each sensor (Input signals from 1, 4, 9, 10), current is output to TERMINALS HTL, HTR and HTS, controlling the heater.

* Idle air control system

The idle air control system (Rotary solenoid type) increases the RPM and provides idle stability for fast idle-up when the engine is cold, and when the idle speed has dropped due to electrical load and so on, the engine control module evaluates the signals from each sensor (Input signals from 1, 4, 5, 8, 9), current is output to TERMINALS RSO and RSC to control idle air control valve.

* EGR control system

The EGR control system detects the signal from each sensor (Input signals from 1, 4, 9, 10), and outputs current to TERMINAL EGR to control the VSV (EGR).

The EGR valve position sensor is mounted on the EGR valve. this sensor converts the EGR valve opening height into a voltage and sends it to the engine control module as the EGR valve position signal.

* ACIS

ACIS includes a valve in the bulkhead separating the surge tank into two parts. This valve is opened and closed in accordance with the driving conditions to control the intake manifold length in two stages for increased engine output in all ranges from low to high speeds.

The engine control module judges the engine speed by the signals ((4), (5)) from each sensor and outputs signals to the TERMINAL ACIS to control the VSV (Intake air control).

3. DIAGNOSIS SYSTEM

With the diagnosis system, when there is a malfunction in the engine control module signal system, the malfunctioning system is recorded in the memory.

4. FAIL-SAFE SYSTEM

When a malfunction occurs in any systems, if there is a possibility of engine trouble being caused by continued control based on the signals from that system, the fail-safe system either controls the system by using data (Standard values) recorded in the engine control module memory or else stops the engine.

SERVICE HINTS

E5 ENGINE COOLANT TEMP. SENSOR

- 1-2 : Approx. **15.04** k Ω (**-20**°C, **-4**°F)
- Approx. **5.74** k Ω (**0**°C, **32**°F)
- Approx. **2.45** k Ω (**20**°C, **68**°F)
- Approx. **1.15** k Ω (**40**°C, **104**°F)
- Approx. **0.584** k Ω (**60**°C, **140**°F)
- Approx. **0.318** k Ω (**80**°C, **176**°F)

E7 (A), E8 (B), E9 (C), E10 (D), E11 (E) ENGINE CONTROL MODULE

Voltage at engine control module wiring connector

- BATT-E1 : Always **9.0-14.0** volts
 - +B-E1 : **9.0-14.0** volts (Ignition SW at **ON** position)
- VC-E2 : Always **4.5-5.5** volts (Ignition SW at **ON** position)
- VTA1-E2 : **0.3-0.8** volts (Ignition SW on and throttle valve fully closed)
 - : **3.2-4.9** volts (Ignition SW on and throttle valve fully open)
- VG-E2G : **1.1-1.5** volts (Engine idling and A/C SW **OFF** position)
- THA-E2 : **0.5-3.4** volts (Engine idling and intake air temp. **20**°C, **68**°F)
- THW-E2 : **0.2-1.0** volts (Engine idling and engine coolant temp. **80**°C, **176**°F)
- IGF-E1 : **4.5-5.5** volts (Ignition SW at **ON** position)
 - Pulse generation (Engine idling)
- G22+-NE- : Pulse generation (Engine idling)
- NE+-NE- : Pulse generation (Engine idling)
- NSW-E1 : **9.0-14.0** volts (Ignition SW on and other shift position in **P** or **N** position)
 - Below **3.0** volts (Ignition SW on and shift position in **P** or **N** position)
- SPD-E1 : Pulse generation (Ignition SW on and rotate driving wheel slowly)
- TC-E1 : **9.0-14.0** volts (Ignition SW at **ON** Position)
- W-E1 : Below **3.0** volts
- A/C-E1 : Below **2.0** volts (Engine idling and A/C SW on)
 - 9.0-14.0** volts (A/C SW off)
- ACT-E1 : **9.0-14.0** volts (Engine idling and A/C SW on)
 - Below **2.0** volts (A/C SW off)
- ACIS-E01 : **9.0-14.0** volts (Ignition SW at **ON** position)
- STA-E1 : **6.0** volts or more (Engine cranking)
- THG-E2 : **4.5-5.5** volts (Ignition SW at **ON** position)
- ELS-E1 : **7.5-14.0** volts (Taillight SW at **ON** position)
 - 0-1.5** volts (Taillight SW at **OFF** position)
- ELS2-E1 : **7.5-14.0** volts (Defogger SW at **ON** position)
 - 0-1.5** volts (Defogger SW at **OFF** position)
- EGR-E01 : **9.0-14.0** volts (Ignition SW at **ON** position)
- FC-E1 : **9.0-14.0** volts (Ignition SW at **ON** position)
 - 0-3.0** volts (Engine idling)
- EVP1-E01 : **9.0-14.0** volts (Ignition SW at **ON** position)
 - CF-E1 : **9.0-14.0** volts (Electric cooling fan is operating on high speed)
 - 0-2.0** volts (Electric cooling fan is operating on low speed or off)
- TACH-E1 : Pulse generation (Engine idling)
- TPC-E1 : **9.0-14.0** volts (Ignition SW on and disconnect the vacuum hose from the vapor pressure sensor)
- PTNK-E1 : **3.0-3.6** volts (Ignition SW at **ON** position)
 - 1.3-2.1** volts (Ignition SW on and apply vacuum **2.0** kpa (**15.0** mmHg, **0.6** in.Hg))
- STP-E1 : **7.5-14.0** volts (Ignition SW on and brake pedal depressed)
 - Below **1.5** volts (Ignition SW on and brake pedal released)
- SIL-E1 : Pulse generation (During transmission)
 - RSC, RSO-E01 : **9.0-14.0** volts (Ignition SW on and disconnect **E 7** of engine control module connector)
- KNKL, KNKR-E1 : Pulse generation (Engine idling)
- HTS, HTL, HTR-E03 : **9.0-14.0** volts (Ignition SW at **ON** position)
 - 0-3.0** volts (Engine idling)
- OXS, OXL, OXR-E1 : Pulse generation (Maintain engine speed at **2500** rpm for two minutes after warning up)
- IGT1, IGT2, IGT3-E1 : Pulse generation (Engine idling)
- #10, #20, #30, #40, #50, #60-E01 : **9.0-14.0** volts (Ignition SW at **ON** position)
 - Pulse generation (Engine idling)

ENGINE CONTROL (1MZ-FE)

I8, I9, I10, I11, I12, I13 INJECTOR

2-1 : Approx. 13.8 Ω

CIR OPN RELAY [R/B NO.1]

3-5 : Closed with starter running

EFI RELAY [ENGINE ROOM J/B NO.2]

3-5 : Closed with ignition SW at ON or ST position

○ : PARTS LOCATION

Code	See Page	Code	See Page	Code	See Page
A12 C	30	H8	30	J24	31
A28	26 (1MZ-FE)	H3	26 (1MZ-FE)	J26	31
A29	26 (1MZ-FE)	H4	26 (1MZ-FE)	J27 A	31
A34 A	30	I1	27 (1MZ-FE)	J28 B	31
A35 B	30	I8	27 (1MZ-FE)	J29	31
C1	26 (1MZ-FE)	I9	27 (1MZ-FE)	J35 A	31
C2	26 (1MZ-FE)	I10	27 (1MZ-FE)	J26 B	31
C7	30	I11	27 (1MZ-FE)	J40	32
C9 B	30	I12	27 (1MZ-FE)	K1	27 (1MZ-FE)
C10 C	30	I13	27 (1MZ-FE)	K2	27 (1MZ-FE)
D1	26 (1MZ-FE)	I16	30	M2	27 (1MZ-FE)
D5	30	J3	31	P1	27 (1MZ-FE)
E1	26 (1MZ-FE)	J4	31	P2	27 (1MZ-FE)
E2	26 (1MZ-FE)	J7 A	31	S6	31
E5	26 (1MZ-FE)	J8 B	31	T2	27 (1MZ-FE)
E7 A	30	J9 A	31	T3	31
E8 B	30	J10 B	31	U1	31
E9 C	30	J11	31	V1	27 (1MZ-FE)
E10 D	30	J12	31	V2	27 (1MZ-FE)
E11 E	30	J15	31	V4	27 (1MZ-FE)
F4 A	26 (1MZ-FE)	J18	31	V5	27 (1MZ-FE)
F6 C	26 (1MZ-FE)	J20	31	V6	27 (1MZ-FE)
F14	32	J22	31	V7	27 (1MZ-FE)

○ : RELAY BLOCKS

Code	See Page	Relay Blocks (Relay Block Location)
1	24	Engine Room R/B No.1 (Engine Compartment Left)
2	24	Engine Room R/B No.2 (Near the Battery)

 : JUNCTION BLOCK AND WIRE HARNESS CONNECTOR

Code	See Page	Junction Block and Wire Harness (Connector Location)
1B	20	Cowl Wire and Instrument Panel J/B (Lower Finish Panel)
1C		
1D		
1J	20	Cowl Wire and Instrument Panel J/B (Lower Finish Panel)
1K		
1M		
1R		
1W		
2A	22	Engine Room Main Wire and Engine Room J/B No.2 (Engine Compartment Left)
2C		
2F		
2J	22	Cowl Wire and Engine Room J/B No.2 (Engine Compartment Left)
2K		
2L		

 : CONNECTOR JOINING WIRE HARNESS AND WIRE HARNESS

Code	See Page	Joining Wire Harness and Wire Harness (Connector Location)
EB1	36 (1MZ-FE)	Cowl Wire and Engine Room Main Wire (Under the Engine Room J/B No.2)
EC1	36 (1MZ-FE)	Engine Wire and Sensor Wire (Head Cover RH)
ES1	36 (1MZ-FE)	Engine Wire and Engine Room Main Wire (Under the Engine Room J/B No.2)
ID1	40	Floor Wire and Cowl Wire (Left Kick Panel)
IG3	40	Instrument Panel Wire and Cowl Wire (Under the Blower Motor)
II1	42	Engine Wire and Cowl Wire (Under the Blower Motor)
II2		
II3		
IJ1	42	Engine Wire and Instrument Panel Wire (Under the Blower Motor)
IK3	42	Engine Room Main Wire and Cowl Wire (Right Kick Panel)

 : GROUND POINTS

Code	See Page	Ground Points Location
EB	36 (1MZ-FE)	Left Radiator Side Support
EC	36 (1MZ-FE)	Surge Tank RH
ED	36 (1MZ-FE)	Rear Side of the Surge Tank
IG	40	Instrument Panel Brace LH
IH	40	Instrument Panel Brace RH
BL	44	Under the Left Center Pillar

 : SPLICE POINTS

Code	See Page	Wire Harness with Splice Points	Code	See Page	Wire Harness with Splice Points
I1	42	Cowl Wire	I3	42	Cowl Wire
I2	42	Engine Wire	I5		

ENGINE CONTROL (1MZ-FE)

A12 (C)
ORANGE

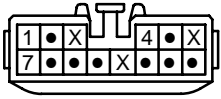

A28
DARK GRAY



A29
DARK GRAY



A34 (A)

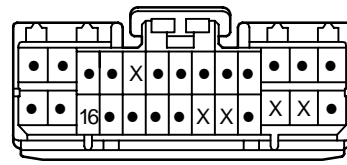

A35 (B)

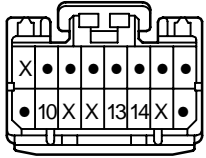

C1
BLACK



C2
BLACK



C7

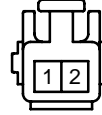

C9 (B)
(TMC Made)

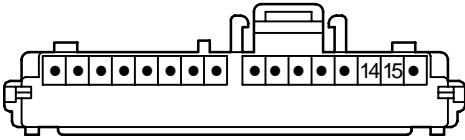

C9 (B)
(TMMK Made)

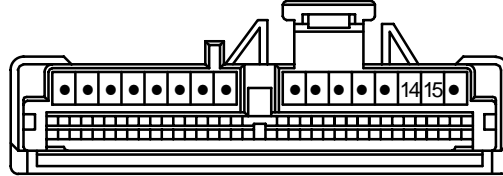

C10 (C)
(TMC Made) BROWN

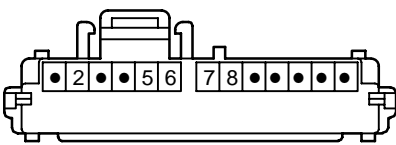

C10 (C)
(TMMK Made) BROWN

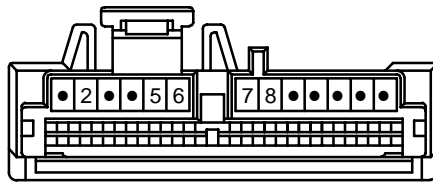

D1
BLACK

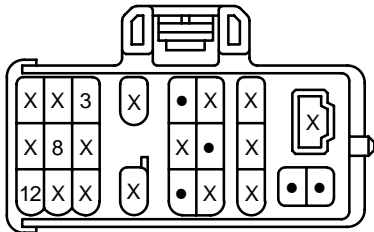

D5

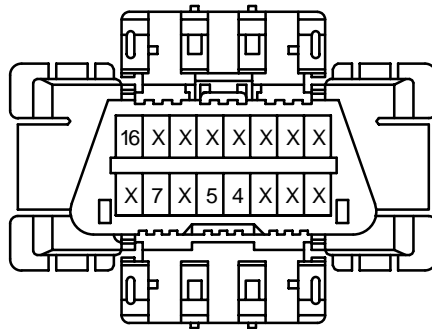

E1
DARK GRAY



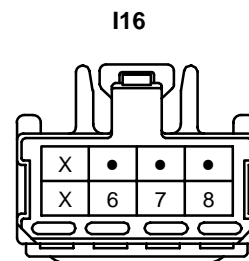
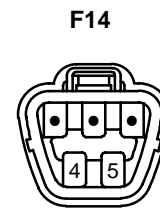
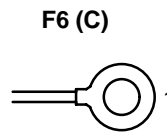
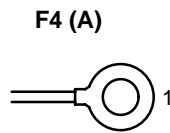
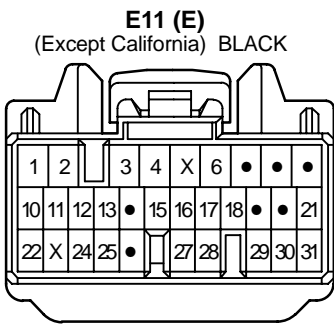
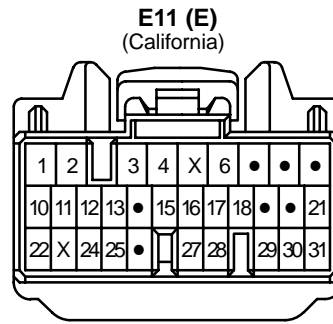
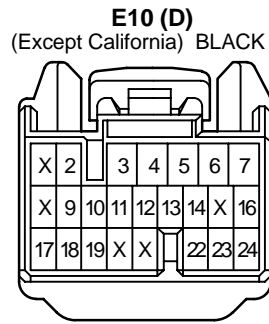
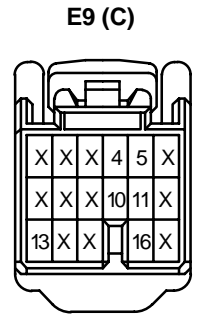
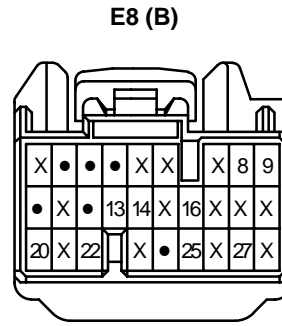
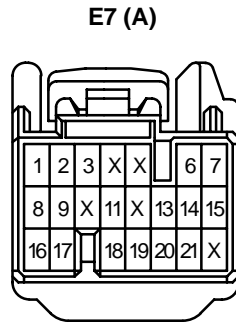

ENGINE CONTROL (1MZ-FE)

J3

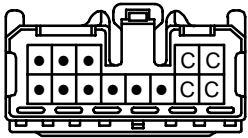

(Hint : See Page 7)

J4
BLACK

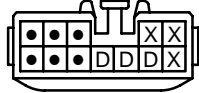

(Hint : See Page 7)

J7 (A)
GRAY

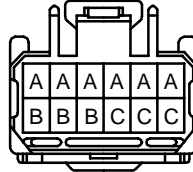

(Hint : See Page 7)

J8 (B)
GRAY

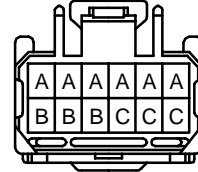

(Hint : See Page 7)

J9 (A)
BLACK

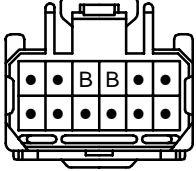

(Hint : See Page 7)

J10 (B)
BLACK

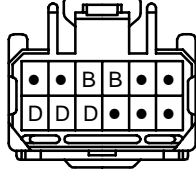

(Hint : See Page 7)

J11

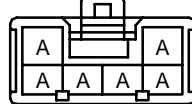

(Hint : See Page 7)

J12
BLACK



(Hint : See Page 7)

J15
BLACK

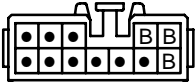

(Hint : See Page 7)

J18
ORANGE

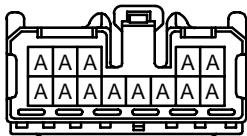

(Hint : See Page 7)

J20



(Hint : See Page 7)

J22

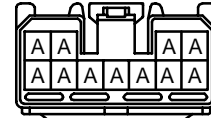

(Hint : See Page 7)

J24

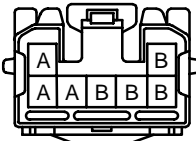

(Hint : See Page 7)

J26

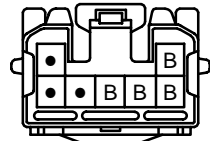

(Hint : See Page 7)

J27 (A)

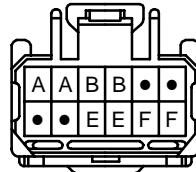

(Hint : See Page 7)

J28 (B)

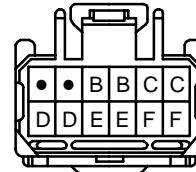

(Hint : See Page 7)

J29

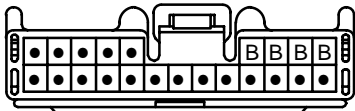

(Hint : See Page 7)

J35 (A)

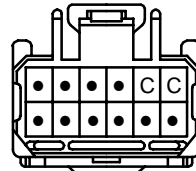

(Hint : See Page 7)

J36 (B)

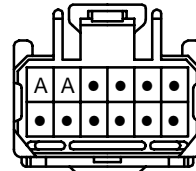

(Hint : See Page 7)

J40

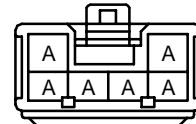

(Hint : See Page 7)

K1
DARK GRAY



K2
DARK GRAY



M2
BLACK

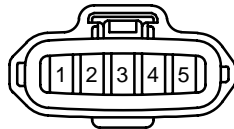

P1
GRAY

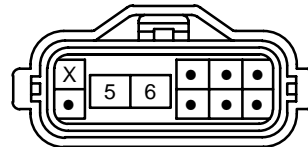

P2
BLACK



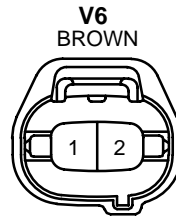
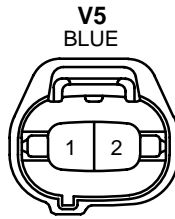
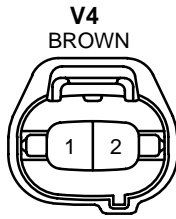
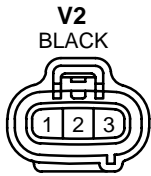
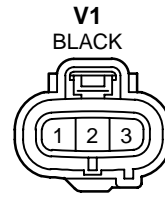
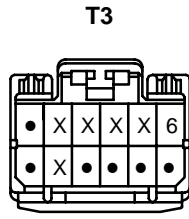
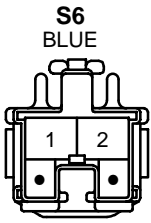

ENGINE CONTROL (5S-FE)

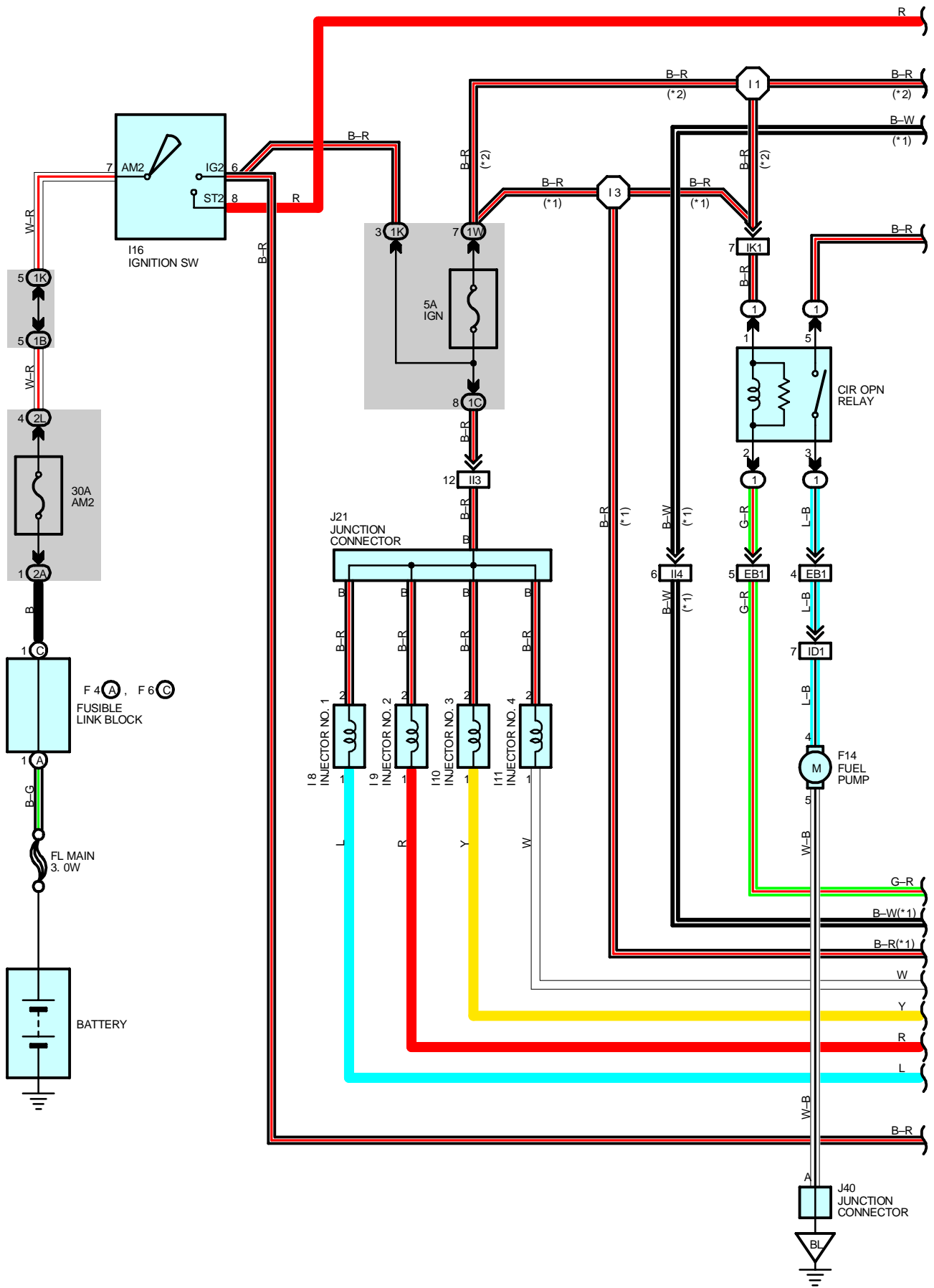

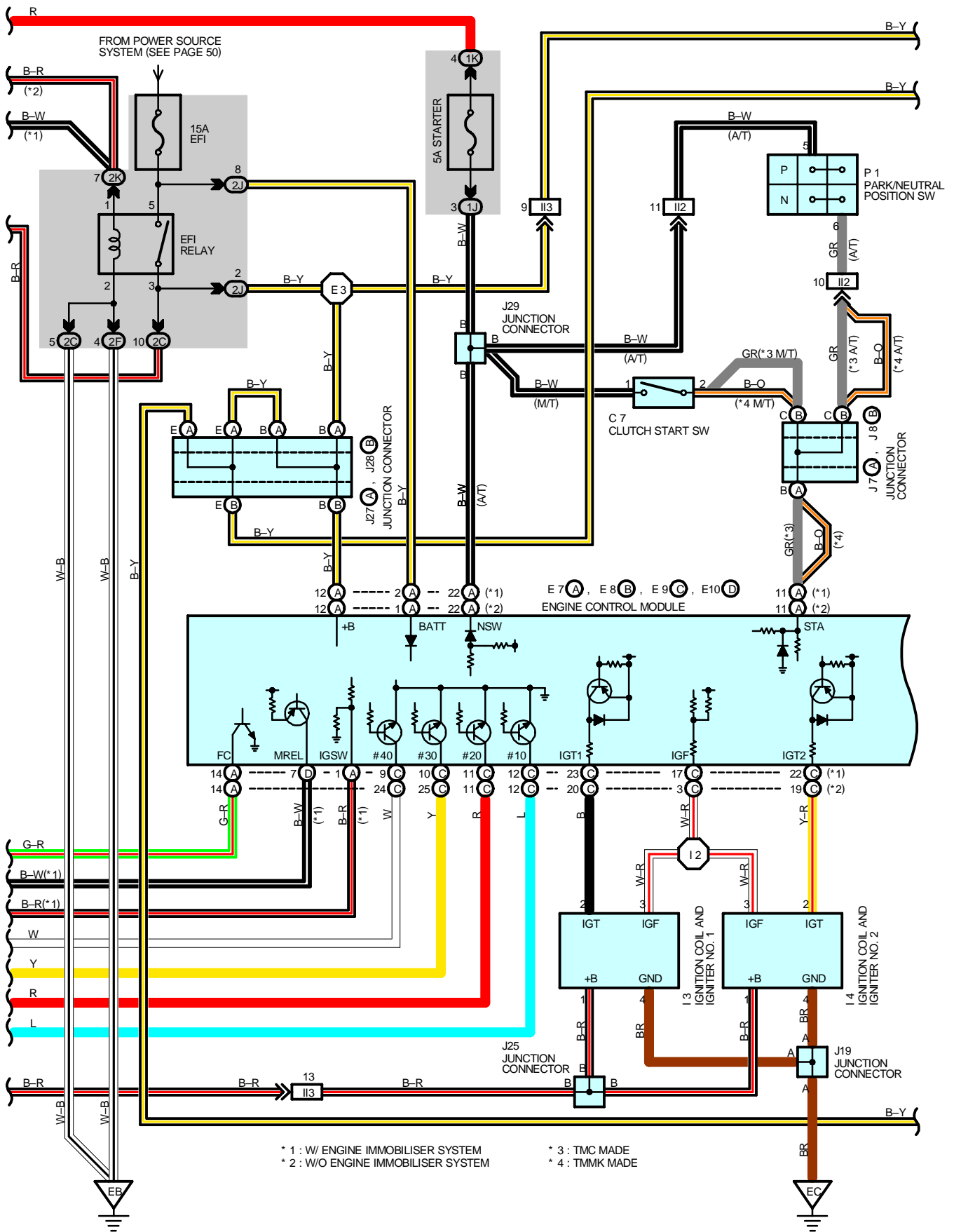

ENGINE CONTROL (5S-FE)

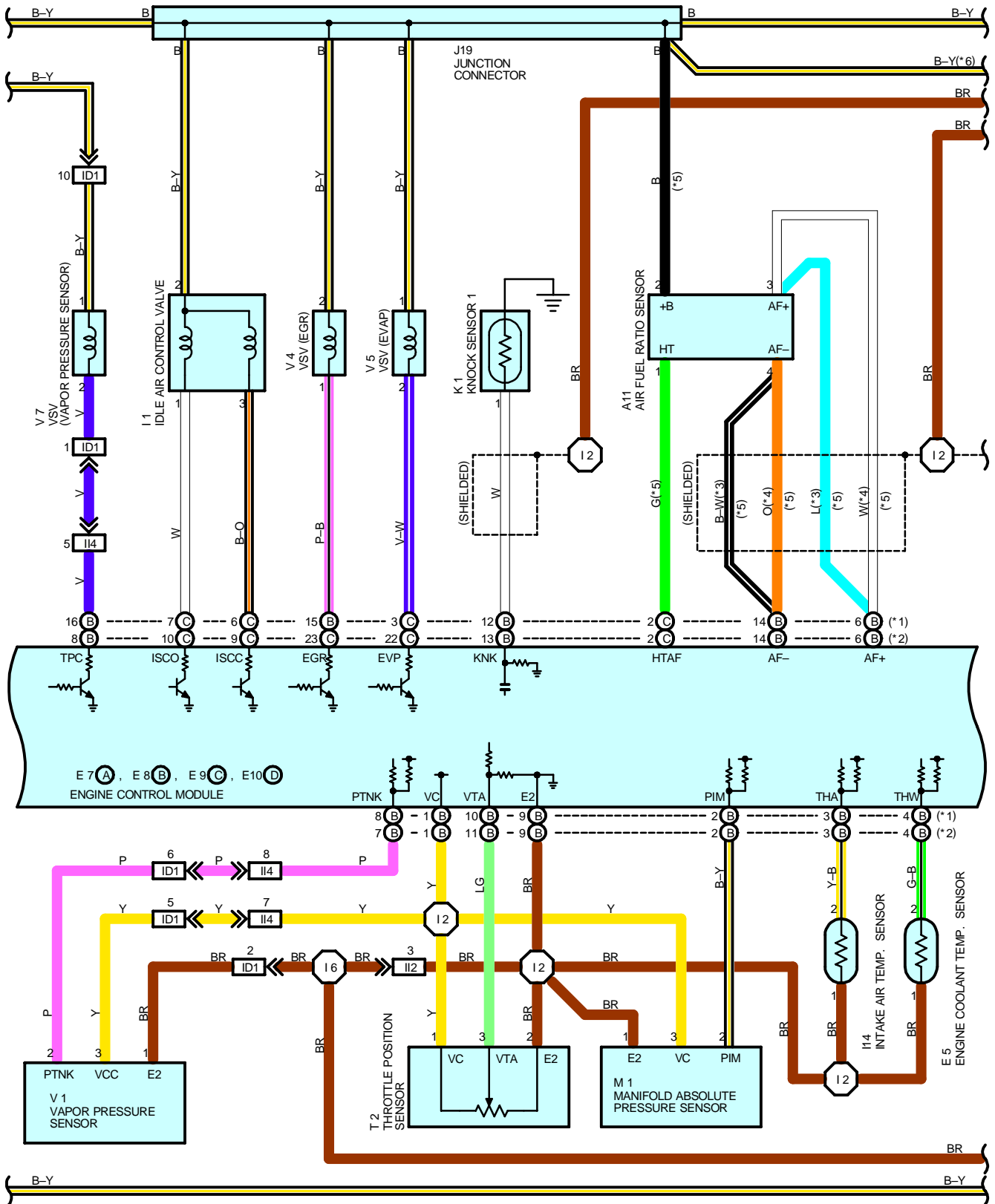

* 1 : W/ ENGINE IMMOBILISER SYSTEM
 * 2 : W/O ENGINE IMMOBILISER SYSTEM

* 3 : TMC MADE
 * 4 : TMMK MADE

* 5 : CALIFORNIA
 * 6 : EXCEPT CALIFORNIA

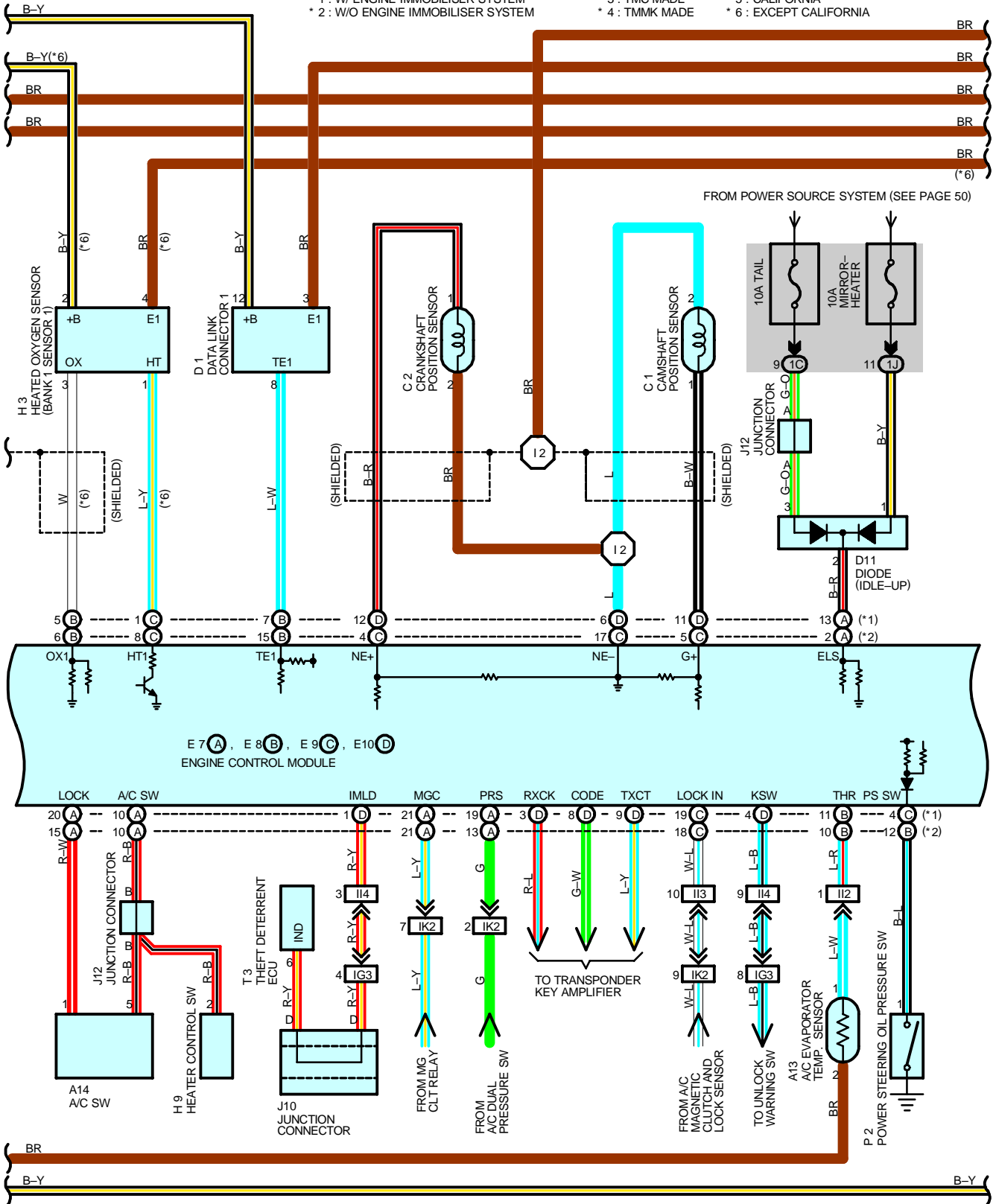

ENGINE CONTROL (5S-FE)

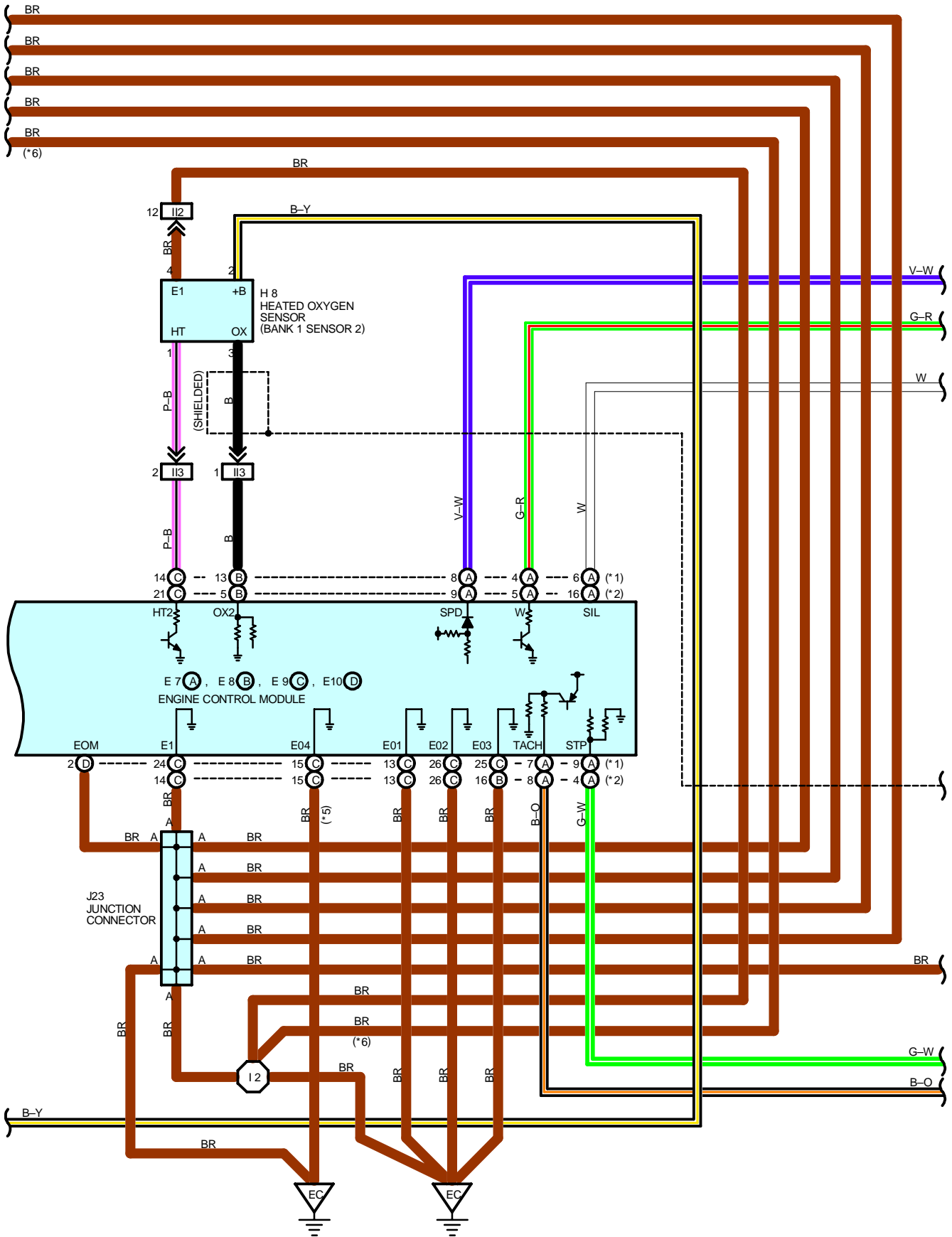

FROM POWER SOURCE SYSTEM (SEE PAGE 50)

FROM POWER SOURCE SYSTEM (SEE PAGE 50)

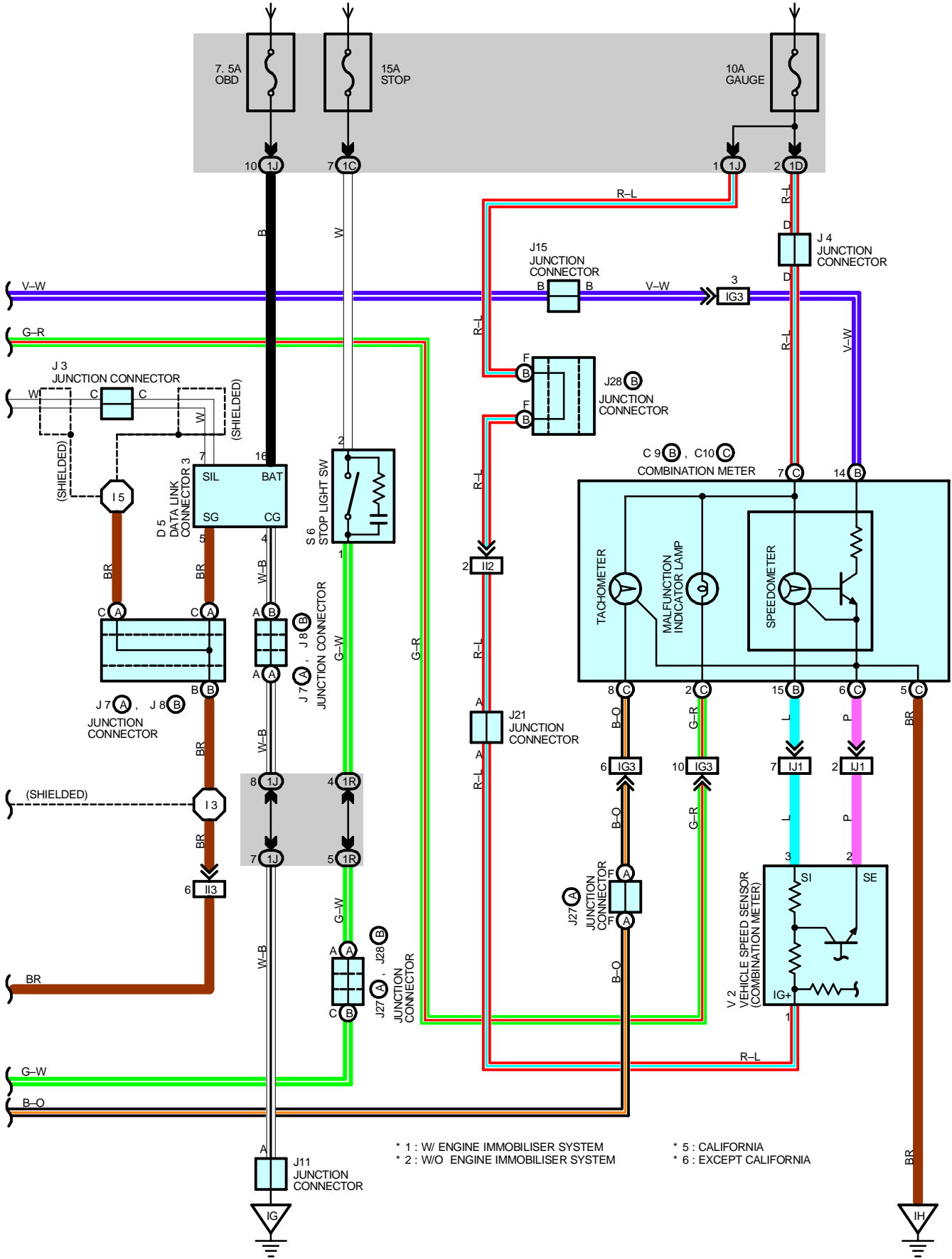

* 1 : W/ ENGINE IMMOBILISER SYSTEM
 * 2 : W/O ENGINE IMMOBILISER SYSTEM

* 5 : CALIFORNIA
 * 6 : EXCEPT CALIFORNIA

ENGINE CONTROL (5S-FE)

SYSTEM OUTLINE

This system utilizes an engine control module and maintains overall control of the engine, transmission and so on. An outline of the engine control is explained here.

1. INPUT SIGNALS

(1) Engine coolant temp. signal circuit

The engine coolant temp. sensor detects the engine coolant temp. and has a built-in thermistor with a resistance which varies according to the engine coolant temp. thus the engine coolant temp. is input in the form of a control signal into TERMINAL THW of the engine control module.

(2) Intake air temp. signal circuit

The intake air temp. sensor detects the intake air temp., which is input as a control signal into TERMINAL THA of the engine control module.

(3) Oxygen sensor signal circuit

The oxygen density in the exhaust gases is detected and input as a control signal into TERMINAL OX1 (except California) and OX2 of the engine control module.

(4) RPM signal circuit

Camshaft position and crankshaft position are detected by the camshaft position sensor and crankshaft position sensor. Camshaft position is input as a control signal to TERMINAL G+ of the engine control module, and engine RPM is input into TERMINAL NE+.

(5) Throttle signal circuit

The throttle position sensor detects the throttle valve opening angle, which is input as a control signal into TERMINAL VTA of the engine control module.

(6) Vehicle speed signal circuit

The vehicle speed sensor, installed inside the transmission, detects the vehicle speed and inputs a control signal into TERMINAL SPD of the engine control module.

(7) Park/Neutral position SW signal circuit (A/T)

The Park/Neutral position SW detects whether the shift position are in neutral, parking or not, and inputs a control signal into TERMINAL STA of the engine control module.

(8) A/C SW signal circuit

The A/C amplifier function is built in the engine control module. The A/C SW signal inputs into the TERMINAL A/C SW of the engine control module.

(9) Battery signal circuit

Voltage is constantly applied to TERMINAL BATT of the engine control module. When the ignition SW is turned on, the voltage for engine control module start-up power supply is applied to TERMINAL +B of engine control module via EFI relay.

(10) Intake air volume signal circuit

Intake air volume is detected by the manifold absolute pressure sensor (for manifold pressure) and is input as a control signal into TERMINAL PIN of the engine control module.

(11) Starter signal circuit

To confirm whether the engine is cranking, the voltage applied to the starter motor during cranking is detected and the signal is input into TERMINAL NSW of the engine control module as a control signal.

(12) Engine knock signal circuit

Engine knocking is detected by knock sensor 1 and the signal is input into TERMINAL KNK as a control signal.

(13) Electrical load signal circuit

The signal when systems such as the rear window defogger, headlights, etc. Which cause a high electrical burden are on is input to TERMINAL ELS as a control signal.

(14) Air fuel ratio signal circuit (California)

The air fuel ratio is detected and input as a control signal into TERMINAL AF+ of the engine control module.

2. CONTROL SYSTEM

* SFI system

The SFI system monitors the engine condition through the signals, which are input from each sensor (Input signals from (1) to (14) etc.) to the engine control module. The best fuel injection volume is decided based on this data and the program memorized by the engine control module, and the control signal is output to TERMINALS #10, #20, #30 and #40 of the engine control module to operate the injector. (Inject the fuel). The SFI system produces control of fuel injection operation by the engine control module in response to the driving conditions.

* ESA system

The ESA system monitors the engine condition through the signals, which are input to the engine control module from each sensor (Input signals from (1), (2), (4) to (12) etc.) the best ignition timing is detected according to this data and the memorized data in the engine control module, and the control signal is output to TERMINALS IGT1 and IGT2. This signal controls the igniter to provide the best ignition timing for the driving conditions.

* Idle Air Control system

The IAC system (Step motor type) increases the RPM and provides idling stability for fast idle-up when the engine is cold and when the idle speed has dropped due to electrical load, etc. The engine control module evaluates the signals from each sensor (Input signals (1), (4) to (8), (13) etc.), outputs current to TERMINALS ISCO and ISCC, and controls the idle air control valve.

* Fuel pump control system

The engine control module operation outputs to TERMINAL FC and controls the CIR OPN relay. Thus controls the fuel pump drive speed in response to conditions.

* EGR control system

The EGR cut control system controls the VSV (EGR) by evaluating the signals from each sensor which are input to the engine control module (Input signals (1), (5), (6), (9) etc.) and by sending output to TERMINAL EGR of the engine control module.

* A/C conditioning operation system

In addition to the conventional A/C cut control, the engine control module performs the air conditioning operation as well since the A/C amplifier function is built in it.

3. DIAGNOSIS SYSTEM

With the diagnosis system, when there is a malfunctioning in the engine control module signal system, the malfunction system is recorded in the memory. The malfunctioning system can then be found by reading the display (Code) of the malfunction indicator lamp.

4. FAIL-SAFE SYSTEM

When a malfunction occurs in any system, if there is a possibility of engine trouble being caused by continued control based on the signals from that system, the fail-safe system either controls the system by using data (Standard values) recorded in the engine control module memory or else stops the engine.

SERVICE HINTS

E7 (A), E8 (B), E9 (C), E10 (D) ENGINE CONTROL MODULE

Voltage at engine control module wiring connector

BATT-E1 : Always **9.0–14.0** volts

+B-E1 : **9.0–14.0** volts (Ignition SW at **ON** position)

VC-E2 : **4.5– 5.5** volts (Ignition SW at **ON** position)

VTA-E2 : **0.3– 0.8** volts (Ignition SW on and throttle valve fully closed)

3.2–4.9 volts (Ignition SW on and throttle valve open)

PIM-E2 : **3.3– 3.9** volts (Ignition SW at **ON** position)

THA-E2 : **0.5–3.4** volts (Ignition SW on and intake air temp. **20°C, 68°F**)

THW-E2 : **0.2– 1.0** volts (Ignition SW on and coolant temp. **80°C, 176°F**)

STA-E1 : **6.0–14.0** volts (Engine cranking)

W-E1 : **9.0–14.0** volts (No trouble and engine running)

TE1-E1 : **9.0–14.0** volts (Ignition SW at **ON** position)

NSW-E1 : **0– 3.0** volts (Ignition SW on and Park/Neutral position SW position **P** or **N** position)

9.0–14.0 volts (Ignition SW on and except Park/Neutral position SW position **P** or **N** position)

IGT1, IGT2-E1 : Pulse generation (Engine cranking or idling)

#10, #20, #30, #40-E01, E02 : **9.0–14.0** volts (Ignition SW at **ON** position)

RESISTANCE AT ENGINE CONTROL MODULE WIRING CONNECTORS

(Disconnect wiring connector)

VC-E2 : **2.5–5.0** k Ω

THA-E2 : **2.21–2.69** k Ω (Intake air temp. **20°C, 68°F**)

THW-E2 : **0.29–0.354** k Ω (Coolant temp. **80°C, 176°F**)

ENGINE CONTROL (5S-FE)

○ : PARTS LOCATION

Code	See Page	Code	See Page	Code	See Page
A11	28 (5S-FE)	H8	30	J21	31
A13	30	H9	30	J23	31
A14	30	I1	29 (5S-FE)	J25	31
C1	28 (5S-FE)	I3	29 (5S-FE)	J27	A 31
C2	28 (5S-FE)	I4	29 (5S-FE)	J28	B 31
C7	30	I8	29 (5S-FE)	J29	31
C9	B 30	I9	29 (5S-FE)	J40	32
C10	C 30	I10	29 (5S-FE)	K1	29 (5S-FE)
D1	28 (5S-FE)	I11	29 (5S-FE)	M1	29 (5S-FE)
D5	30	I14	29 (5S-FE)	P1	29 (5S-FE)
D11	30	I16	30	P2	29 (5S-FE)
E5	28 (5S-FE)	J3	31	S6	31
E7	A 30	J4	31	T2	29 (5S-FE)
E8	B 30	J7	A 31	T3	31
E9	C 30	J8	B 31	V1	29 (5S-FE)
E10	D 30	J10	31	V2	29 (5S-FE)
F4	A 28 (5S-FE)	J11	31	V4	29 (5S-FE)
F6	C 28 (5S-FE)	J12	31	V5	29 (5S-FE)
F14	32	J15	31	V7	29 (5S-FE)
H3	28 (5S-FE)	J19	31		

○ : RELAY BLOCKS

Code	See Page	Relay Blocks (Relay Block Location)
1	24	Engine Room R/B No.1 (Engine Compartment Left)

○ : JUNCTION BLOCK AND WIRE HARNESS CONNECTOR

Code	See Page	Junction Block and Wire Harness (Connector Location)
1B	20	Cowl Wire and Instrument Panel J/B (Lower Finish Panel)
1C		
1D	20	Instrument Panel Wire and Instrument Panel J/B (Lower Finish Panel)
1J	20	Cowl Wire and Instrument Panel J/B (Lower Finish Panel)
1K		
1R		
1W		
2A	22	Engine Room Main Wire and Engine Room J/B No.2 (Engine Compartment Left)
2C		
2F		
2J	22	Cowl Wire and Engine Room J/B No.2 (Engine Compartment Left)
2K		
2L		

□ : CONNECTOR JOINING WIRE HARNESS AND WIRE HARNESS

Code	See Page	Joining Wire Harness and Wire Harness (Connector Location)
EB1	38 (5S-FE)	Cowl Wire and Engine Room Main Wire (Under the Engine Room J/B No.2)
ID1	40	Floor Wire and Cowl Wire (Left Kick Panel)
IG3	40	Instrument Panel Wire and Cowl Wire (Under the Blower Motor)
II2	42	Engine Wire and Cowl Wire (Under the Blower Motor)
II3		
II4		
IJ1	42	Engine Wire and Instrument Panel Wire (Under the Blower Motor)
IK1	42	Engine Room Main Wire and Cowl Wire (Right Kick Panel)
IK2		

▽ : GROUND POINTS

Code	See Page	Ground Points Location
EB	38 (5S-FE)	Left Radiator Side Support
EC	38 (5S-FE)	Intake Manifold
IG	40	Instrument Panel Brace LH
IH	40	Instrument Panel Brace RH
BL	44	Under the Left Center Pillar

○ : SPLICE POINTS

Code	See Page	Wire Harness with Splice Points	Code	See Page	Wire Harness with Splice Points
E3	38 (5S-FE)	Cowl Wire	I3	42	Cowl Wire
I1	42		I5		
I2	42	Engine Wire	I6		

A11
DARK GRAY



A13

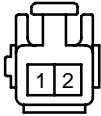

A14

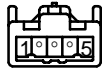

C1
DARK GRAY



C2
DARK GRAY



C7

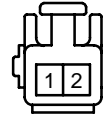

C9 (B)
(TMC Made)

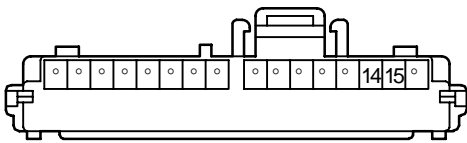

C9 (B)
(TMMK Made)

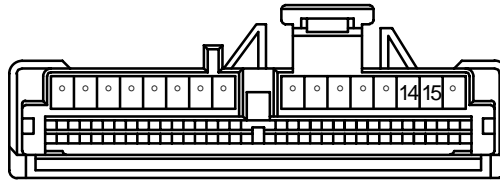

C10 (C)
(TMC Made) BROWN

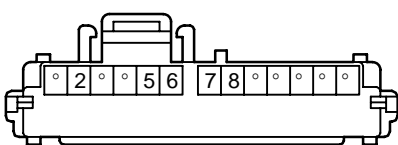

C10 (C)
BROWN

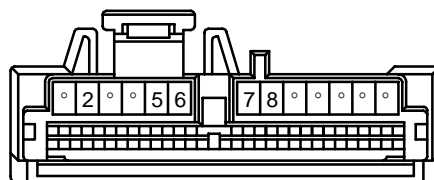

ENGINE CONTROL (5S-FE)

* 1 : w/ Engine Immobiliser System
 * 2 : w/o Engine Immobiliser System

D1
BLACK

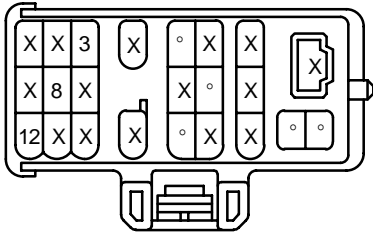

D5

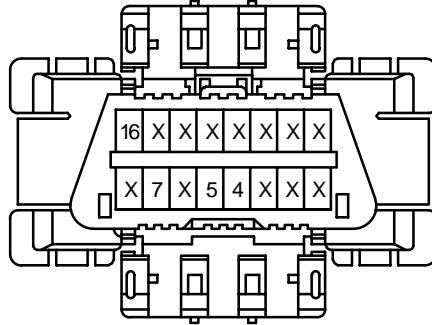

D11
ORANGE

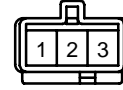

E5
GREEN



E7 (A)
(* 1)

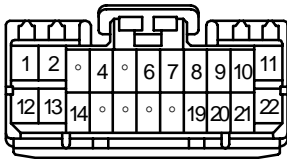

E7 (A)
(* 2)

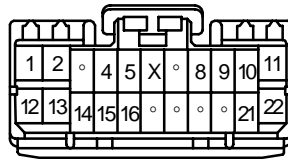

E8 (B)
(* 1) DARK GRAY

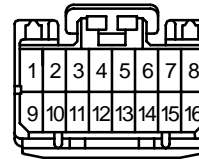

E8 (B)
(* 2)

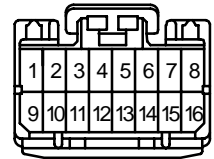

E9 (C)
(* 1) DARK GRAY

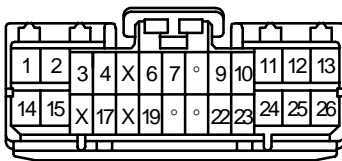

E9 (C)
(* 2)

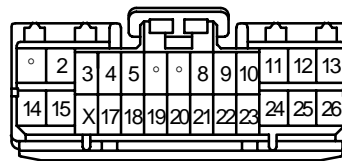

E10 (D)
DARK GRAY

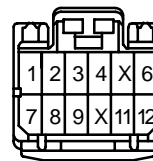

F4 (A)

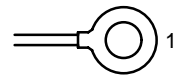

F6 (C)

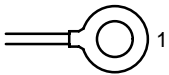

F14



H3
DARK GRAY



H8
DARK GRAY



H9



I1
GRAY



I3
GRAY

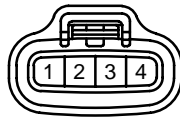

I4
BLACK

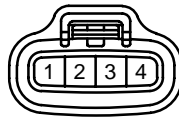

I8
BROWN



I9
GRAY



I10
BROWN



I11
GRAY



I14
BLACK



I16

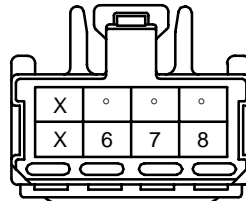

J3

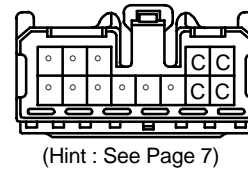

(Hint : See Page 7)

J4
BLACK

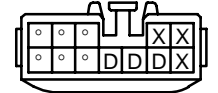

(Hint : See Page 7)

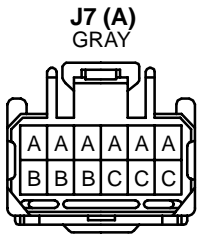

(Hint : See Page 7)

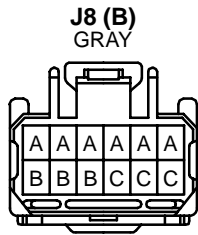

(Hint : See Page 7)

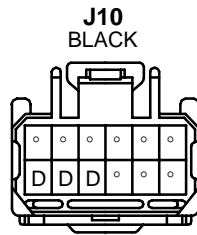

(Hint : See Page 7)

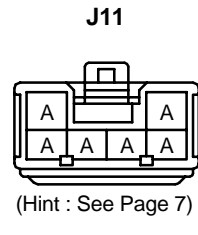

(Hint : See Page 7)

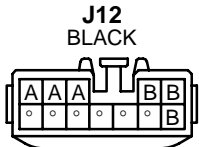

(Hint : See Page 7)

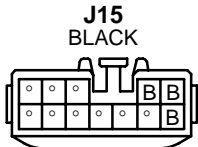

(Hint : See Page 7)

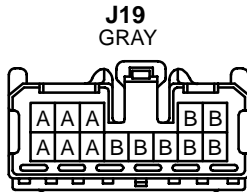

(Hint : See Page 7)

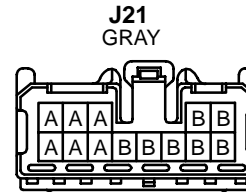

(Hint : See Page 7)

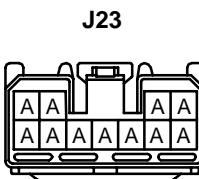

(Hint : See Page 7)

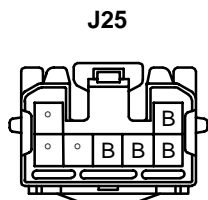

(Hint : See Page 7)

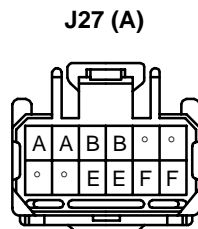

(Hint : See Page 7)

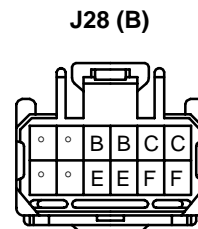

(Hint : See Page 7)

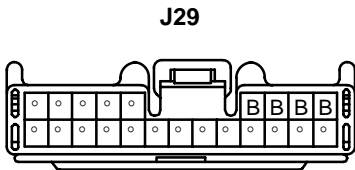

(Hint : See Page 7)

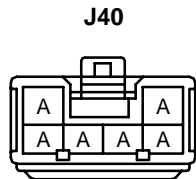

(Hint : See Page 7)

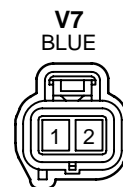
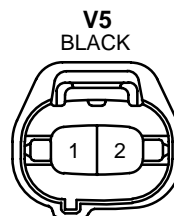
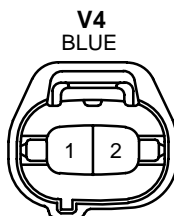
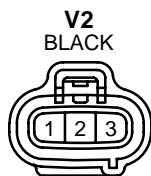
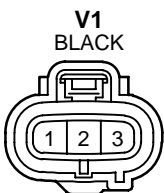
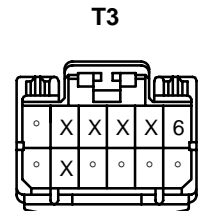
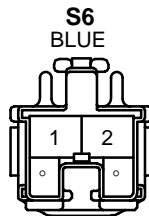
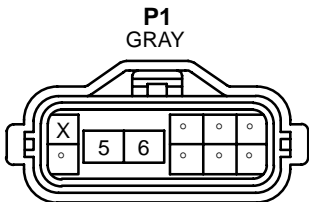
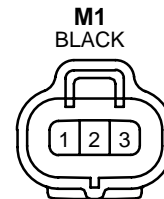

ENGINE IMMOBILISER SYSTEM

FROM POWER SOURCE SYSTEM (SEE PAGE 50)

* 1: 1MZ-FE
* 2: 5S-FE

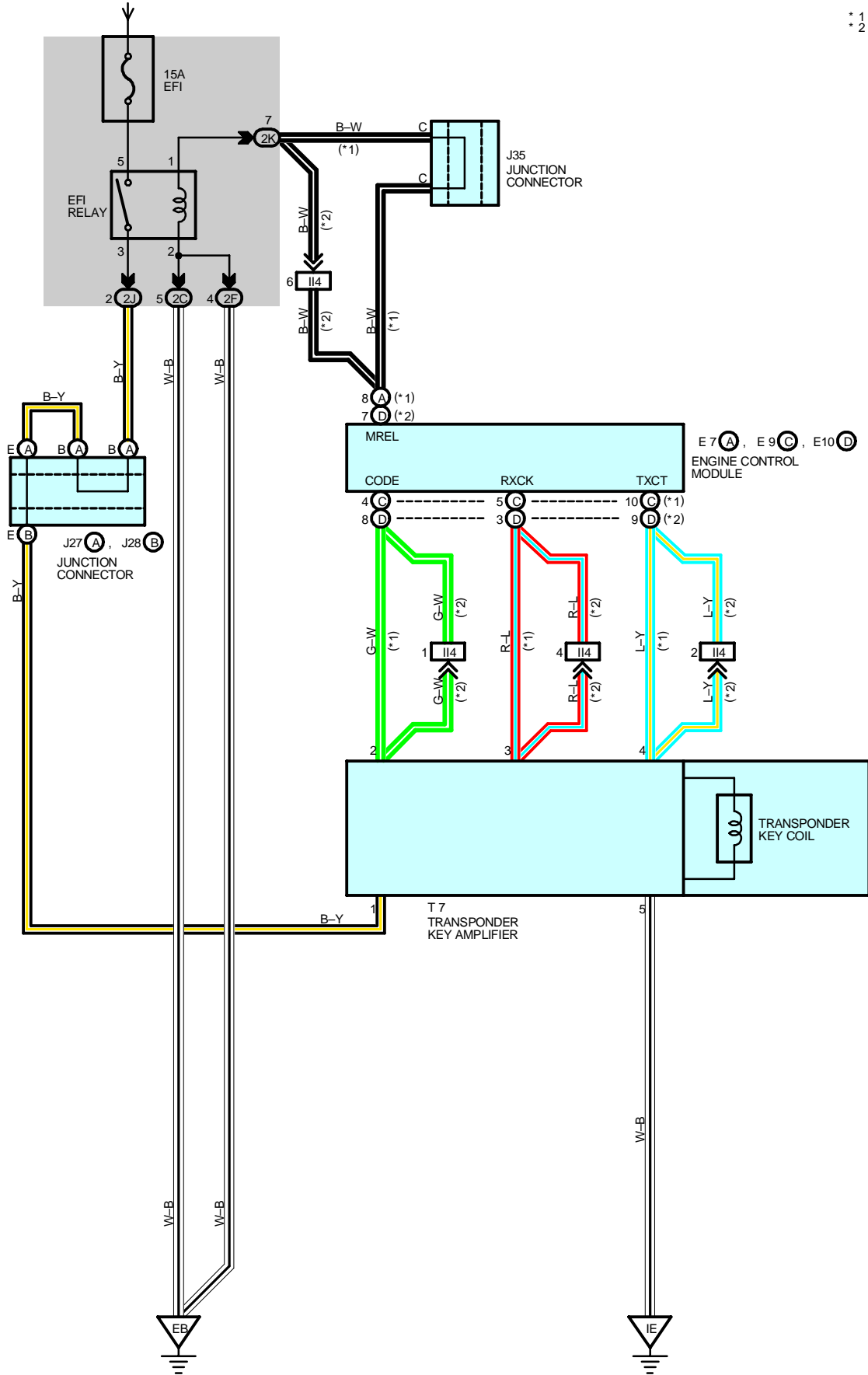

○ : PARTS LOCATION

Code	See Page	Code	See Page	Code	See Page
E7	A	30	J27	A	31
E9	C	30	J28	B	31
E10	D	30	J35		31

○ : JUNCTION BLOCK AND WIRE HARNESS CONNECTOR

Code	See Page	Junction Block and Wire Harness (Connector Location)
2C	22	Engine Room Main Wire and Engine Room J/B No.2 (Engine Compartment Left)
2F		
2J	22	Cowl Wire and Engine Room J/B No.2 (Engine Compartment Left)
2K		

□ : CONNECTOR JOINING WIRE HARNESS AND WIRE HARNESS

Code	See Page	Joining Wire Harness and Wire Harness (Connector Location)
II4	42	Engine Wire and Cowl Wire (Under the Blower Motor)

▽ : GROUND POINTS

Code	See Page	Ground Points Location
EB	36(1MZ-FE)	Left Radiator Side Support
	38(5S-FE)	
IE	40	Cowl Side Panel LH

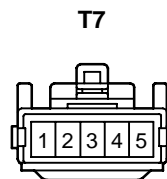
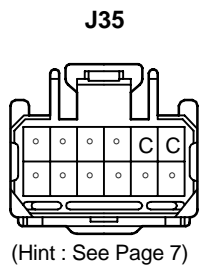
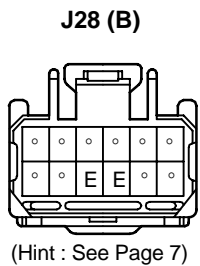
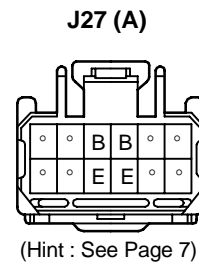
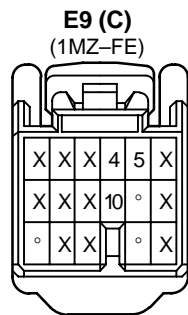
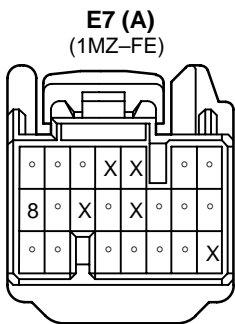

HEADLIGHT (w/o DAYTIME RUNNING LIGHT)

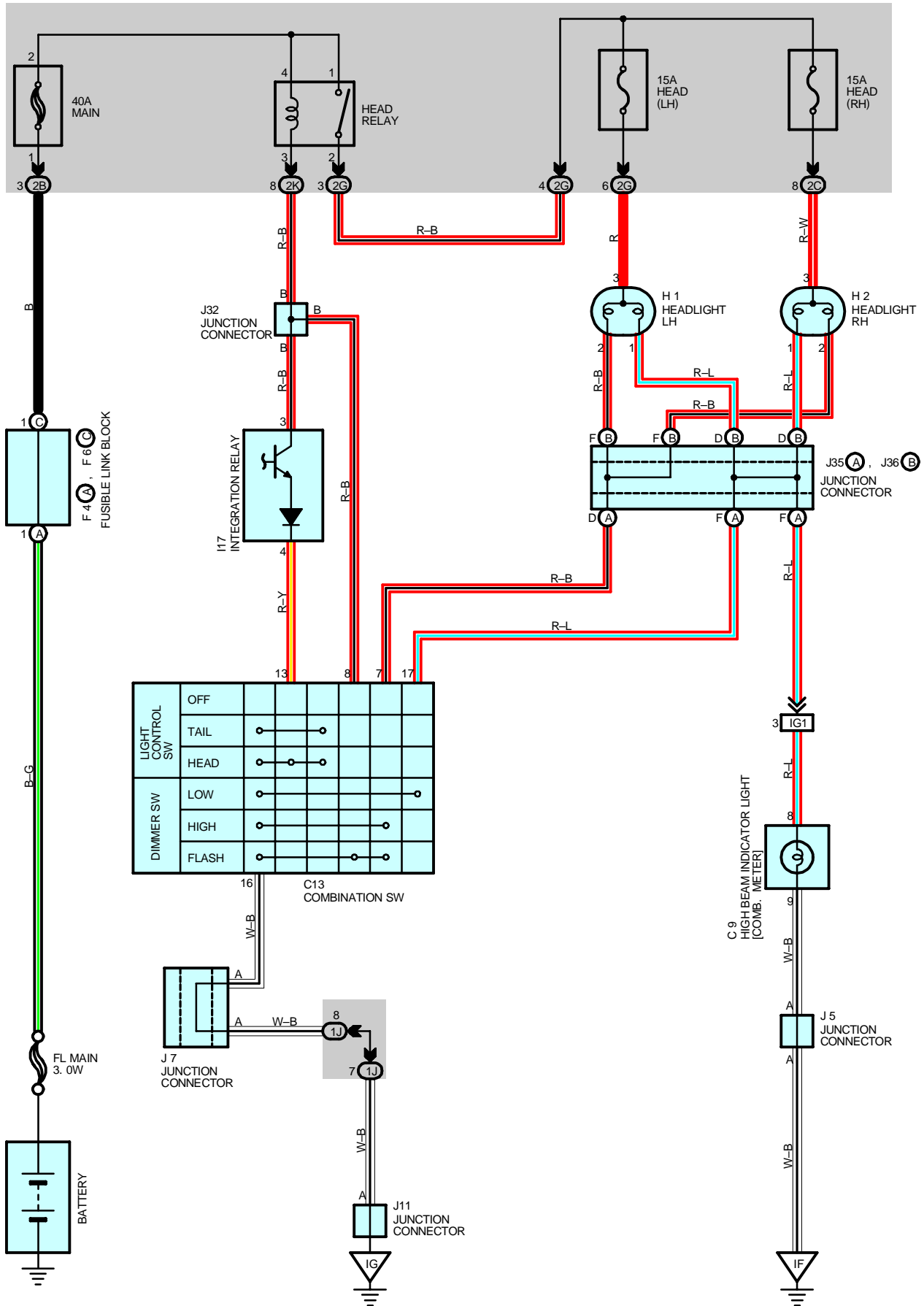

SERVICE HINTS**HEAD RELAY [ENGINE ROOM J/B NO.2]**

2-1 : Closed with the light control SW at **HEAD** position or the dimmer SW at **FLASH** position

C13 COMBINATION SW

13-16 : Continuity with the light control SW at **HEAD** position

8-16 : Continuity with the dimmer SW at **FLASH** position

7-16 : Continuity with the dimmer SW at **HIGH** or **FLASH** position

○ : PARTS LOCATION

Code	See Page	Code	See Page	Code	See Page	
C9	30	H1	26 (1MZ-FE)	J7	31	
C13	30		28 (5S-FE)	J11	31	
F4	A	H2	26 (1MZ-FE)	J32	31	
			28 (5S-FE)	J35	A	31
F6	C	I17	30	J36	B	31
		J5	31			

○ : JUNCTION BLOCK AND WIRE HARNESS CONNECTOR

Code	See Page	Junction Block and Wire Harness (Connector Location)
1J	20	Cowl Wire and Instrument Panel J/B (Lower Finish Panel)
2B	22	Engine Room Main Wire and Engine Room J/B No.2 (Engine Compartment Left)
2C		
2G		
2K	22	Cowl Wire and Engine Room J/B No.2 (Engine Compartment Left)

□ : CONNECTOR JOINING WIRE HARNESS AND WIRE HARNESS

Code	See Page	Joining Wire Harness and Wire Harness (Connector Location)
IG1	40	Instrument Panel Wire and Cowl Wire (Lower Finish Panel)

▽ : GROUND POINTS

Code	See Page	Ground Points Location
IF	40	Left Kick Panel
IG	40	Instrument Panel Brace LH

HEADLIGHT (w/o DAYTIME RUNNING LIGHT)

C9
(TMC Made)

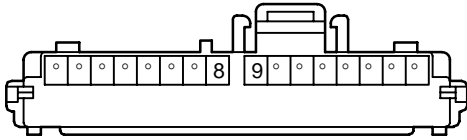

C9
(TMMK Made)

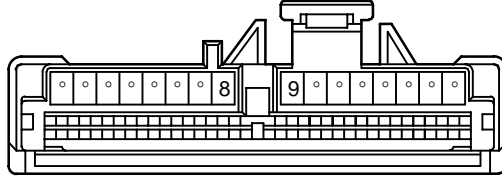

C13

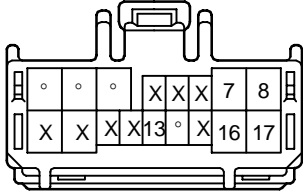

F4 (A)

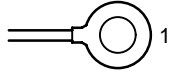

F6 (C)

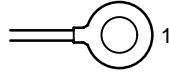

H1
BLACK

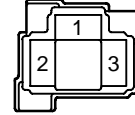

H2
BLACK

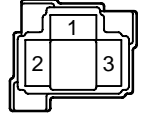

I17

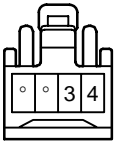

J5
ORANGE

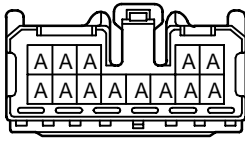

(Hint : See Page 7)

J7
GRAY

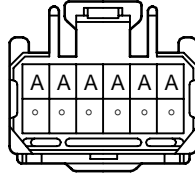

(Hint : See Page 7)

J11

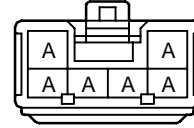

(Hint : See Page 7)

J32
GRAY

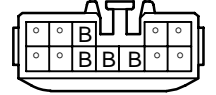

(Hint : See Page 7)

J35 (A)

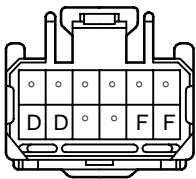

(Hint : See Page 7)

J36 (B)

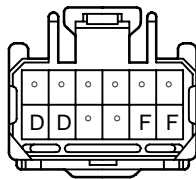

(Hint : See Page 7)

HEADLIGHT (w/ DAYTIME RUNNING LIGHT)

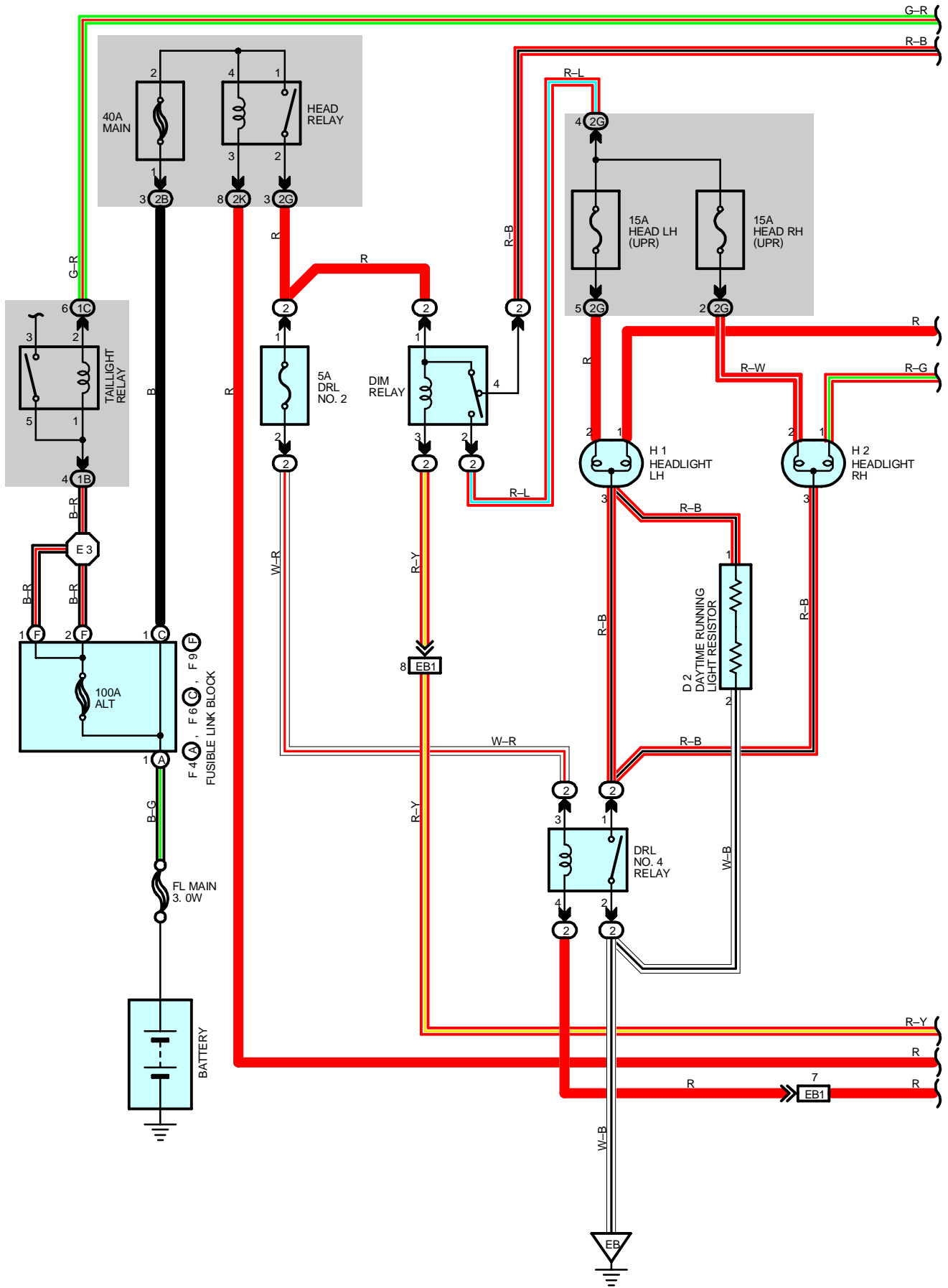

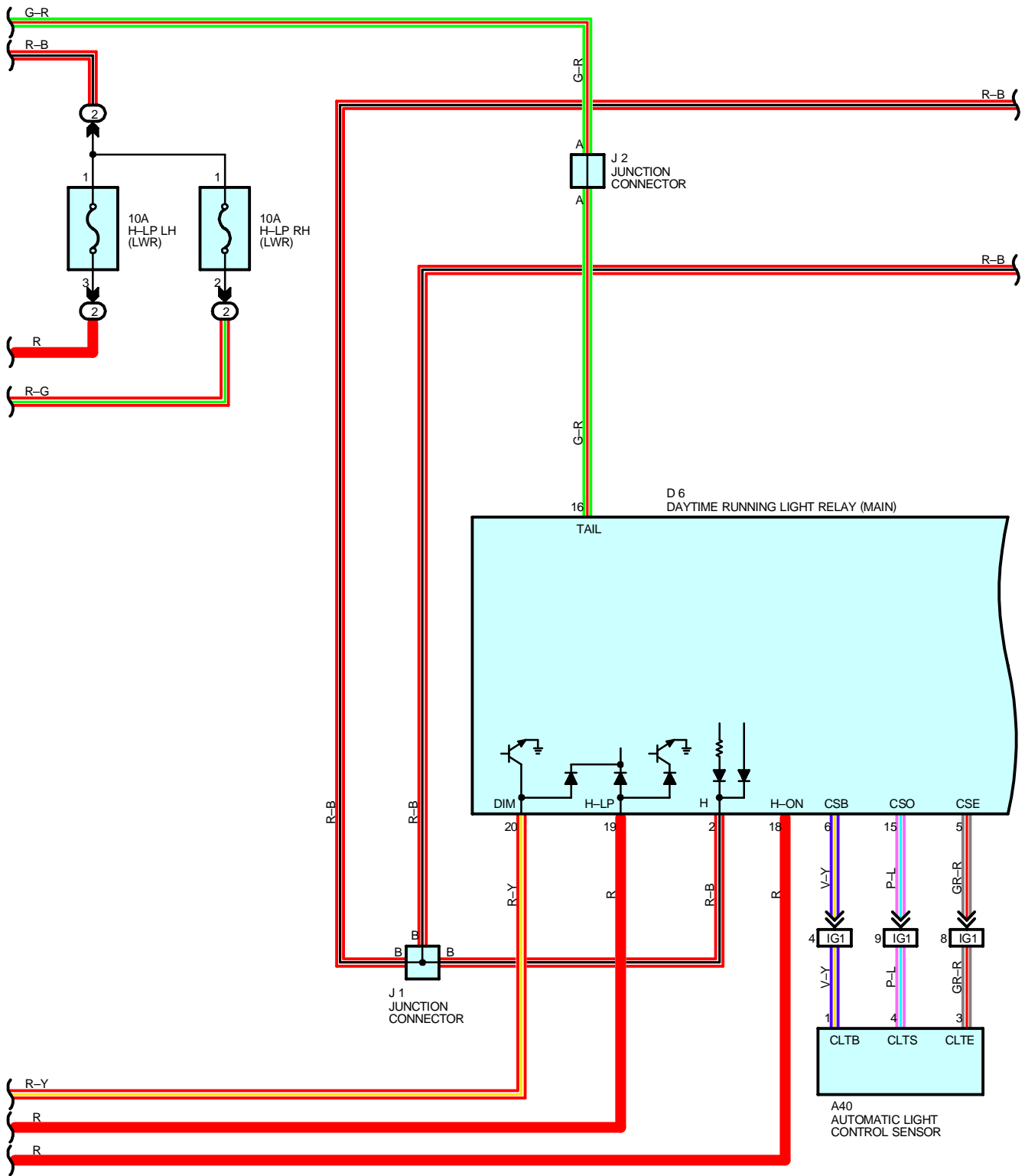

HEADLIGHT (w/ DAYTIME RUNNING LIGHT)

FROM POWER SOURCE SYSTEM (SEE PAGE 50)

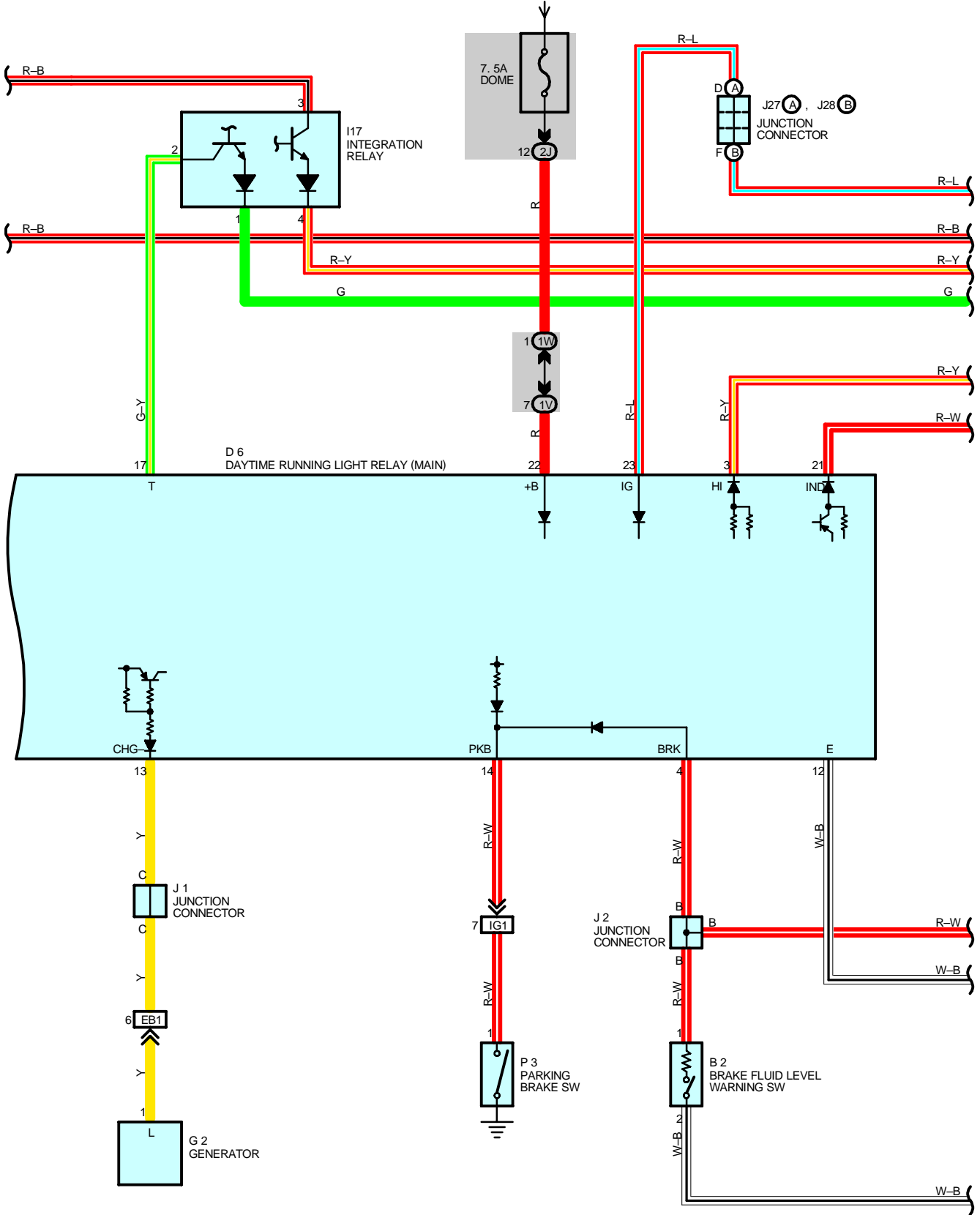

HEADLIGHT (w/ DAYTIME RUNNING LIGHT)

SYSTEM OUTLINE

The current from the FL MAIN is always flowing from the MAIN fuse to HEAD relay (Coil side) to TERMINAL H–LP of the daytime running light relay (Main), from DOME fuse to TERMINAL +B of the daytime running light relay (Main) and from the ALT fuse to Taillight relay (Coil side) to TERMINAL TAIL (TMMK Made) of the daytime running light relay (Main).

When the ignition SW is turned on, the current flowing through the GAUGE fuse flows to TERMINAL IG of the daytime running light relay (Main).

1. DAYTIME RUNNING LIGHT OPERATION

When the engine is started, voltage generated at TERMINAL L of the generator is applied to TERMINAL CHG– of the daytime running light relay (Main). If the parking brake lever is pulled up (Parking brake SW on) at this time, the relay is not activated so the daytime running light system does not operate. If the parking brake lever is then released (Parking brake SW off), a signal is input to TERMINAL PKB of the relay.

This activates the daytime running light relay (Main) and the HEAD relay is turned to on, so the current flows from the MAIN fuse to the HEAD relay (Point side) to TERMINAL 1 of the DIM relay to TERMINAL 4 to H–LP LH (LWR), H–LP RH (LWR) fuses to TERMINAL 1 of the headlights to TERMINAL 3 to TERMINAL 1 of the daytime running light resistor to TERMINAL 2 to GROUND, causing the headlights to light up (Headlights light up dimmer than normal brightness.). Once the daytime running light system operates and the headlights light up, the headlights remain on even if the parking brake lever is pulled up (Parking brake SW on).

If the engine stalls and the ignition SW remains on, the headlights remain light up even through current is no longer output from TERMINAL L of the generator. If the ignition SW is then turned off, the headlights go off.

If the engine is started with the parking brake lever released (Parking brake SW off), the daytime running light system operates and headlights light up when the engine starts.

2. HEADLIGHT OPERATION

When the light control SW is switched to HEAD position and the dimmer SW is set to LOW position, causing the daytime running light relay (Main) and the HEAD relay to turn on, so the current flows from the MAIN fuse to HEAD relay (Point side) to DRL NO.2 fuse to TERMINAL 3 of the DRL NO.4 relay to TERMINAL 4 to TERMINAL H–ON of the daytime running light relay (Main) to TERMINAL H to TERMINAL 3 of the integration relay to TERMINAL 4 to TERMINAL 13 of the light control SW to TERMINAL 16 to GROUND, activating the DRL NO.4 relay. The current to HEAD relay (Point side) then flows to TERMINAL 1 of the DIM relay to TERMINAL 4 to H–LP LH (LWR), H–LP RH (LWR) fuses to TERMINAL 1 of the headlights to TERMINAL 3 to TERMINAL 1 of the DRL NO.4 relay to TERMINAL 2 to GROUND, causing the headlights to light up at normal intensity.

When the light control SW is switched to HEAD position and the dimmer SW is set to HIGH position, the signal from the dimmer SW is input to the daytime running light relay (Main). This activates the daytime running light relay (Main) and the HEAD relay is turned on, so the current flows from the MAIN fuse to HEAD relay (Point side) to TERMINAL 1 of the DIM relay to TERMINAL 3 to TERMINAL DIM of the daytime running light relay (Main), activating the DIM relay. This causes current to flow from TERMINAL 1 of the DIM relay to TERMINAL 2 to HEAD LH (UPR), HEAD RH (UPR) fuses to TERMINAL 2 of the headlights to TERMINAL 3 to TERMINAL 1 of the DRL NO.4 relay to TERMINAL 2 to GROUND, causing the headlights to light up at high beam and the high beam indicator light to light up.

When the dimmer SW is switched to FLASH position, the signal from the dimmer SW is input to the daytime running light relay (Main). This activates the daytime running light relay (Main) and the HEAD relay is turned on, so the current flows from the MAIN fuse to HEAD relay (Point side) to DRL NO.2 fuse to TERMINAL 3 of the DRL NO.4 relay to TERMINAL 4 to TERMINAL H–ON of the daytime running light relay (Main) to TERMINAL H to TERMINAL 8 of the dimmer SW to TERMINAL 16 to GROUND, activating the DRL NO.4 relay. At the same time, the current flows from the TERMINAL 1 of the DIM relay to TERMINAL 3 to TERMINAL DIM of the daytime running light relay (Main), activating the DIM relay, and also flows from the HEAD LH (UPR), HEAD RH (UPR) fuses to TERMINAL 2 of the headlights to TERMINAL 3 to TERMINAL 1 of the DRL NO.4 relay to TERMINAL 2 to GROUND, causing the headlights to light up at high beam and the high beam indicator light to light up.

3. AUTOMATIC LIGHT CONTROL OPERATION

When the daytime running light is operating and the Automatic control sensor detects a decrease in the ambient light (It continues less than approx. 2500 lux over about 20 seconds, and it is less than 1000 lux.), the automatic light control operation starts. At the same time, daytime running light relay (Main) is activated, so current flows from the ALT fuse to the Taillight relay (Coil side) to TERMINAL TAIL of the daytime running light relay (Main), and the DRL NO.2 fuse to the DRL NO.4 relay (Coil side) to TERMINAL H-ON of the daytime running light relay (Main), activating both the Taillight relay and the DRL NO.4 relay, so that the taillights and headlights light up.

When the automatic light control sensor detects an increase in the ambient light (It continues more than approx. 1000 lux over about 20 seconds, and it is more than approx. 2500 lux), the ignition SW is turned to off, the light control SW is turned to HEAD position, and the automatic light control operation stops.

SERVICE HINTS

HEAD RELAY [ENGINE ROOM J/B NO.2]

- 1-2 : Closed with the light control SW at **HEAD** position or the dimmer SW at **FLASH** position
- Closed with the engine running and the parking brake lever is released (Parking brake SW off)

TAILLIGHT RELAY [INSTRUMENT PANEL J/B]

- 5-3 : Closed with the light control SW at **TAIL** or **HEAD** position

D6 DAYTIME RUNNING LIGHT RELAY (MAIN)

- 2-GROUND : Approx. **12** volts with the ignition SW at **ON** position
- 5, 7, 17-GROUND : Approx. **12** volts with the light control SW at **HEAD** position or the dimmer SW at **FLASH** position
- Approx. **12** volts with the engine running and the parking brake lever is released (Parking brake SW off)
- 6, 15-GROUND : Always approx. **12** volts
- 8-GROUND : Continuity with the parking brake lever pulled up
- 11-GROUND : **13.9-15.1** volts with the engine running at **2000** rpm **25°C (77°F)**
- 12-GROUND : Approx. **12** volts with the high beam light up
- 13-GROUND : Always continuity
- 16-GROUND : Continuity with the dimmer SW at **HIGH** or **FLASH** position
- 18-GROUND : Continuity with the brake fluid level not enough

○ : PARTS LOCATION

Code	See Page	Code	See Page	Code	See Page	
A40	30	F6	C	26 (1MZ-FE)	J1	31
B2	26 (1MZ-FE)			28 (5S-FE)	J2	31
		28 (5S-FE)	F9	F	26 (1MZ-FE)	J4
C9	B	30			28 (5S-FE)	J5
C10	C	30	G2	26 (1MZ-FE)	J7	31
C13	30	28 (5S-FE)		J11	31	
D2	26 (1MZ-FE)	H1	26 (1MZ-FE)	J27	A	31
	28 (5S-FE)		28 (5S-FE)	J28	B	31
D6	30	H2	26 (1MZ-FE)	P3	31	
F4	26 (1MZ-FE)		28 (5S-FE)			
	A	28 (5S-FE)	I17	30		

HEADLIGHT (w/ DAYTIME RUNNING LIGHT)

: RELAY BLOCKS

Code	See Page	Relay Blocks (Relay Block Location)
2	24	Engine Room R/B No.2 (Near the Battery)

: JUNCTION BLOCK AND WIRE HARNESS CONNECTOR

Code	See Page	Junction Block and Wire Harness (Connector Location)
1B	20	Cowl Wire and Instrument Panel J/B (Lower Finish Panel)
1C		
1D	20	Instrument Panel Wire and Instrument Panel J/B (Lower Finish Panel)
1J	20	Cowl Wire and Instrument Panel J/B (Lower Finish Panel)
1V		
1W		
2B	22	Engine Room Main Wire and Engine Room J/B No.2 (Engine Compartment Left)
2G		
2J	22	Cowl Wire and Engine Room J/B No.2 (Engine Compartment Left)
2K		

: CONNECTOR JOINING WIRE HARNESS AND WIRE HARNESS

Code	See Page	Joining Wire Harness and Wire Harness (Connector Location)
EB1	36 (1MZ-FE)	Cowl Wire and Engine Room Main Wire (Under the Engine Room J/B No.2)
	38 (5S-FE)	
IG1	40	Instrument Panel Wire and Cowl Wire (Lower Finish Panel)
IG2		

: GROUND POINTS

Code	See Page	Ground Points Location
EB	36 (1MZ-FE)	Left Radiator Side Support
	38 (5S-FE)	
IF	40	Left Kick Panel
IG	40	Instrument Panel Brace LH

: SPLICE POINTS

Code	See Page	Wire Harness with Splice Points	Code	See Page	Wire Harness with Splice Points
E3	36 (1MZ-FE)	Cowl Wire	E3	38 (5S-FE)	Cowl Wire

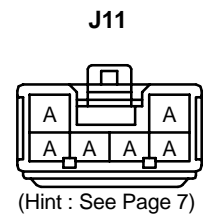
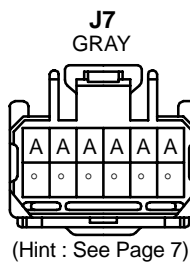
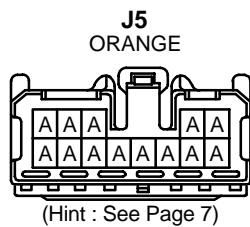
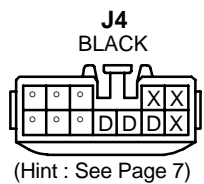
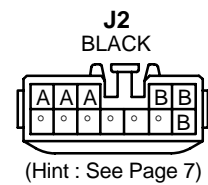
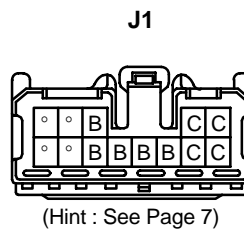
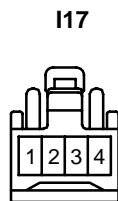
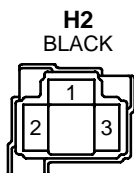
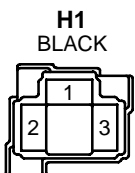
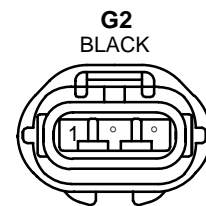
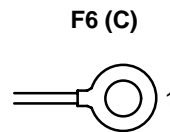
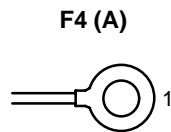
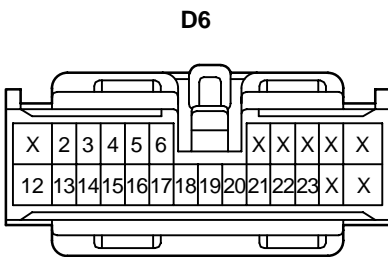
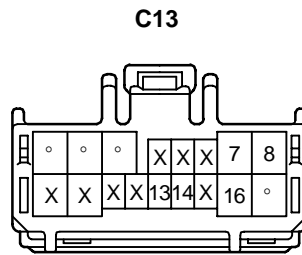
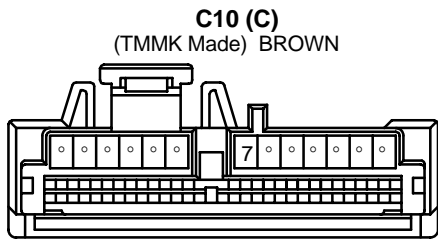
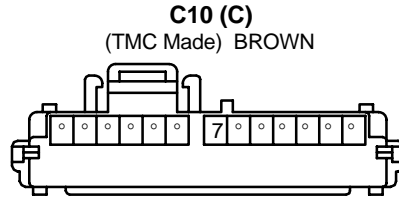
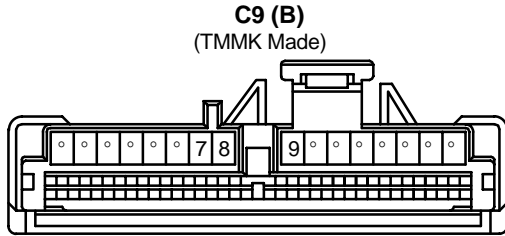
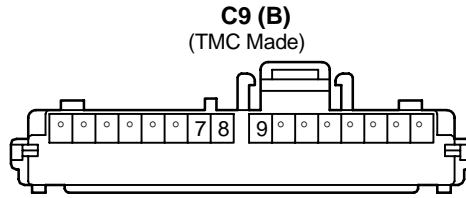
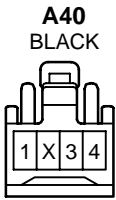

HEADLIGHT (w/ DAYTIME RUNNING LIGHT)

J27 (A)

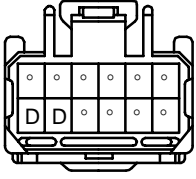

(Hint : See Page 7)

J28 (B)

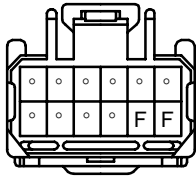

(Hint : See Page 7)

P3



LIGHT AUTO TURN OFF

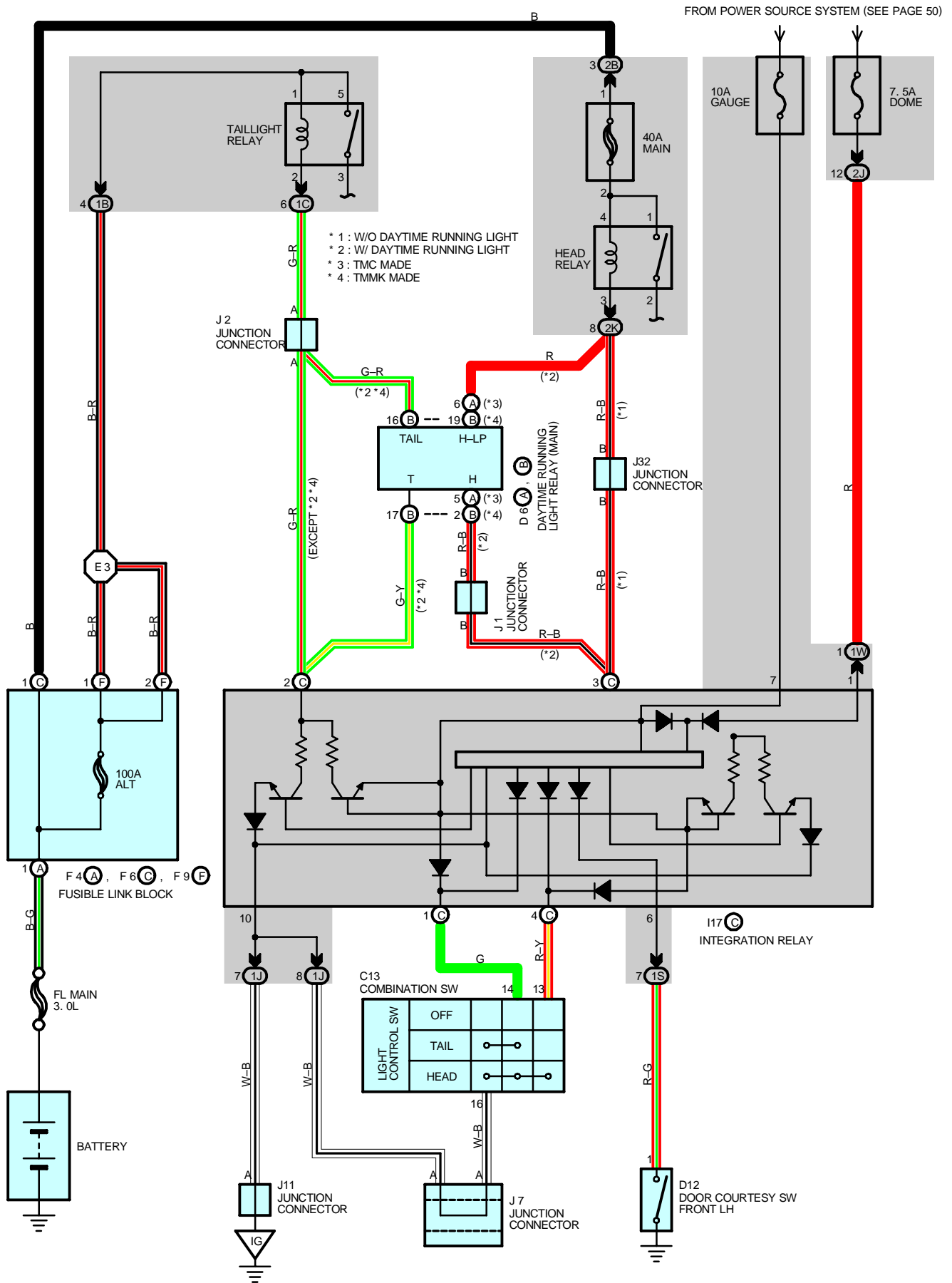

SYSTEM OUTLINE

With the ignition SW turned on, the current flows to TERMINAL 7 of the integration relay through GAUGE fuse. Voltage is applied at all times to TERMINAL (C) 2 of the integration relay through the taillight relay coil side, and to TERMINAL (C) 3 through the HEAD relay coil side (w/o daytime running light) or through the daytime running light relay (Main) (w/ daytime running light).

1. NORMAL LIGHTING OPERATION

<Turn taillight on>

With the light control SW turned to TAIL position, a signal is input into TERMINAL (C) 1 of the integration relay. Due to this signal, the current flowing to TERMINAL (C) 2 of the relay flows to TERMINAL (C) 1 to TERMINAL 14 of the light control SW to TERMINAL 16 to GROUND, and taillight relay causes taillights to turn on.

<Turn headlight on>

With the light control SW turned to HEAD position, a signal is input into TERMINALS (C) 1 and (C) 4 of the integration relay. Due to this signal, the current flowing to TERMINAL (C) 3 of the relay flows to TERMINAL (C) 4 to TERMINAL 13 of the light control SW to TERMINAL 16 to GROUND in the headlight circuit, and causes taillight and HEAD relay to turn the lights on. The taillight circuit is same as above.

2. LIGHT AUTO TURN OFF OPERATION

With light on and ignition SW turned off (Input signal goes to TERMINAL 7 of the relay), when the driver's door is opened (Input signal goes to TERMINAL 6 of the relay), the relay operates and the current is cut off which flows from TERMINAL (C) 2 of the relay to TERMINAL (C) 1 In taillight circuit and from TERMINAL (C) 3 to TERMINAL (C) 4 in headlight circuit. As a result, all lights are turned off automatically.

SERVICE HINTS

HEAD RELAY [ENGINE ROOM J/B NO.2]

- 2-1 : Closed with the light control SW at **HEAD** position or the dimmer SW at **FLASH** position
- Closed with the engine running and the parking brake lever released (w/ daytime running light)

TAILLIGHT RELAY [INSTRUMENT PANEL J/B]

- 3-5 : Closed with the light control SW at **TAIL** or **HEAD** position

D12 DOOR COURTESY SW FRONT LH

- 1-GROUND : Continuity with the front LH door open

I17 (C) INTEGRATION RELAY

- 7-GROUND : Approx. **12** volts with the ignition SW at **ON** position
- 6-GROUND : Continuity with the front LH door open
- 1-GROUND : Always approx. **12** volts
- 10-GROUND : Always continuity
- (C) 2-GROUND : Always approx. **12** volts
- (C) 3-GROUND : Always approx. **12** volts
- (C) 4-GROUND : Continuity with the light control SW at **HEAD** position
- (C) 1-GROUND : Continuity with the light control SW at **TAIL** or **HEAD** position

○ : PARTS LOCATION

Code	See Page	Code	See Page	Code	See Page	
C13	30	F6	C	26 (1MZ-FE)	J2	31
D6	A			30	28 (5S-FE)	J7
	B	30	F9	F	26 (1MZ-FE)	J11
D12	32	28 (5S-FE)			J32	31
F4	A	I17	C	30		
				J1	31	

LIGHT AUTO TURN OFF

○ : JUNCTION BLOCK AND WIRE HARNESS CONNECTOR

Code	See Page	Junction Block and Wire Harness (Connector Location)
1B	20	Cowl Wire and Instrument Panel J/B (Lower Finish Panel)
1C		
1J		
1S	20	Floor Wire and Instrument Panel J/B (Lower Finish Panel)
1W	20	Cowl Wire and Instrument Panel J/B (Lower Finish Panel)
2B	22	Engine Room Main Wire and Engine Room J/B No.2 (Engine Compartment Left)
2J	22	Cowl Wire and Engine Room J/B No.2 (Engine Compartment Left)
2K		

▽ : GROUND POINTS

Code	See Page	Ground Points Location
IG	40	Instrument Panel Brace LH

○ : SPLICE POINTS

Code	See Page	Wire Harness with Splice Points	Code	See Page	Wire Harness with Splice Points
E3	36 (1MZ-FE)	Cowl Wire	E3	38 (5S-FE)	Cowl Wire

C13

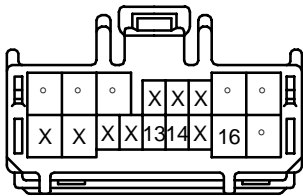

D6 (A)
(TMC Made) GRAY

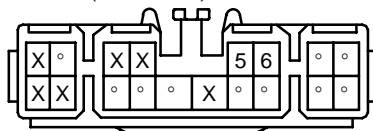

D6 (B)
(TMMK Made)

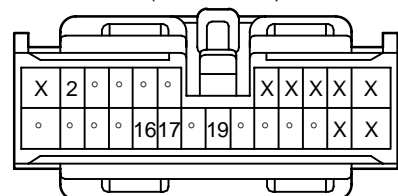

D12



F4 (A)

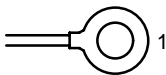

F6 (C)

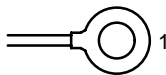

F9 (F)
ORANGE

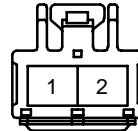

I17 (C)

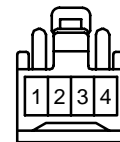

J1

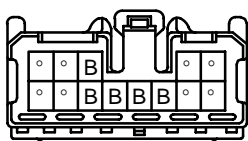

(Hint : See Page 7)

J2
BLACK

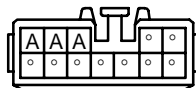

(Hint : See Page 7)

J7
GRAY

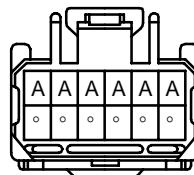

(Hint : See Page 7)

J11

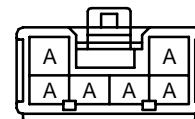

(Hint : See Page 7)

J32
GRAY

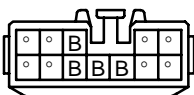

(Hint : See Page 7)

SERVICE HINTS**T6 TURN SIGNAL FLASHER**2-GROUND : Approx. **12** volts with the ignition SW on or the hazard SW on1-GROUND : Changes from **12** to **0** volts with the ignition SW on and the turn signal SW **LEFT** or **RIGHT** position,
and with the hazard SW on

3-GROUND : Always continuity

 : **PARTS LOCATION**

Code	See Page	Code	See Page	Code	See Page		
C9	B	30	F2	28 (5S-FE)	J36	B	31
C10	C	30	H7	30	R9		33
C13		30	J5	31	R11		33
F1		26 (1MZ-FE)	J11	31	T6		31
		28 (5S-FE)	J15	31			
F2		26 (1MZ-FE)	J35	A			31

 : **JUNCTION BLOCK AND WIRE HARNESS CONNECTOR**

Code	See Page	Junction Block and Wire Harness (Connector Location)
1A	20	Cowl Wire and Instrument Panel J/B (Lower Finish Panel)
1C		
1H	20	Instrument Panel Wire and Instrument Panel J/B (Lower Finish Panel)
1L	20	Cowl Wire and Instrument Panel J/B (Lower Finish Panel)
1S	20	Floor Wire and Instrument Panel J/B (Lower Finish Panel)
1V	20	Cowl Wire and Instrument Panel J/B (Lower Finish Panel)
2K	22	Cowl Wire and Engine Room J/B No.2 (Engine Compartment Left)

 : **CONNECTOR JOINING WIRE HARNESS AND WIRE HARNESS**

Code	See Page	Joining Wire Harness and Wire Harness (Connector Location)
EB1	36 (1MZ-FE)	Cowl Wire and Engine Room Main Wire (Under the Engine Room J/B No.2)
	38 (5S-FE)	

 : **GROUND POINTS**

Code	See Page	Ground Points Location
EB	36 (1MZ-FE)	Left Radiator Side Support
	38 (5S-FE)	
IF	40	Left Kick Panel
IG	40	Instrument Panel Brace LH
BP	44	Back Panel Center

 : **SPLICE POINTS**

Code	See Page	Wire Harness with Splice Points	Code	See Page	Wire Harness with Splice Points
E4	36 (1MZ-FE)	Engine Room Main Wire	B11	44	Floor Wire
	38 (5S-FE)				

TURN SIGNAL AND HAZARD WARNING LIGHT

C9 (B)
(TMC Made)

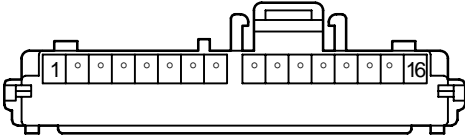

C9 (B)
(TMMK Made)

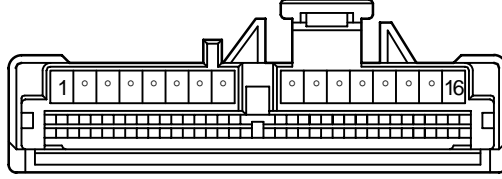

C10 (C)
(TMC Made) BROWN

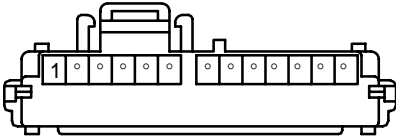

C10 (C)
(TMMK Made) BROWN

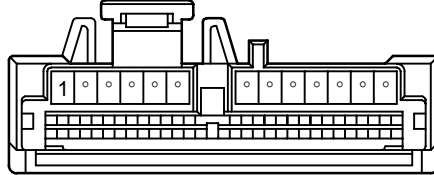

C13

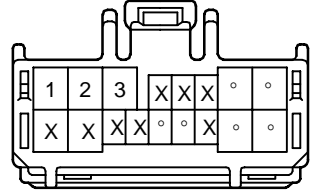

F1
GRAY



F2
GRAY



H7
BLACK

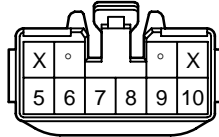

J5
ORANGE

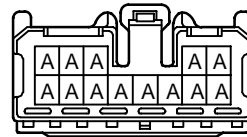

(Hint : See Page 7)

J11

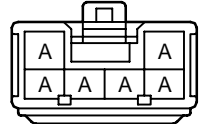

(Hint : See Page 7)

J15
BLACK

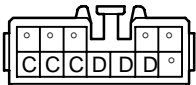

(Hint : See Page 7)

J35 (A)

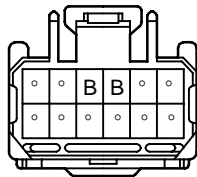

(Hint : See Page 7)

J36 (B)

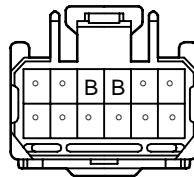

(Hint : See Page 7)

R9

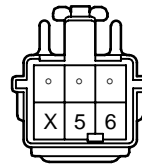

R11

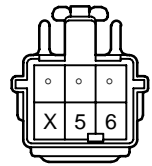

T6

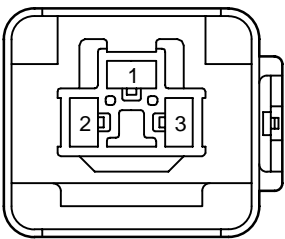

SYSTEM OUTLINE

Current is applied at all times through the STOP fuse to TERMINAL 2 of the stop light SW.

When the ignition SW is turned on, current flows from the GAUGE fuse to TERMINAL 8 of the light failure sensor, and also flows through the rear lights warning light to TERMINAL 4 of the light failure sensor.

STOP LIGHT DISCONNECTION WARNING

When the ignition SW is turned on and the brake pedal is pressed (Stop light SW on), if the stop light circuit is open, the current flowing from TERMINAL 7 of the light failure sensor to TERMINAL 2 and 1 changes, so the light failure sensor detects the disconnection and the warning circuit of the light failure sensor is activated.

As a result, the current flows from TERMINAL 4 of the light failure sensor to TERMINAL 11 to GROUND and turns the rear lights warning light on. By pressing the brake pedal, the current flowing to TERMINAL 8 of the light failure sensor keeps the warning circuit on holding and the warning light on until the ignition SW is turned off.

SERVICE HINTS

S6 STOP LIGHT SW

2-1 : Closed with the brake pedal depressed

L3 LIGHT FAILURE SENSOR

1, 2, 7-GROUND : Approx. 12 volts with the stop light SW on

4, 8-GROUND : Approx. 12 volts with the ignition SW at **ON** position

11-GROUND : Always continuity

○ : PARTS LOCATION

Code	See Page	Code	See Page	Code	See Page	
C8	A	30	J4	31	R9	33
C10	C	30	J40	32	R11	33
H10	32	L3	32	S6	31	

○ : JUNCTION BLOCK AND WIRE HARNESS CONNECTOR

Code	See Page	Junction Block and Wire Harness (Connector Location)
1C	20	Cowl Wire and Instrument Panel J/B (Lower Finish Panel)
1D	20	Instrument Panel Wire and Instrument Panel J/B (Lower Finish Panel)
1R	20	Cowl Wire and Instrument Panel J/B (Lower Finish Panel)
1S	20	Floor Wire and Instrument Panel J/B (Lower Finish Panel)

□ : CONNECTOR JOINING WIRE HARNESS AND WIRE HARNESS

Code	See Page	Joining Wire Harness and Wire Harness (Connector Location)
IF2	40	Floor Wire and Instrument Panel Wire (Left Kick Panel)

▽ : GROUND POINTS

Code	See Page	Ground Points Location
BL	44	Under the Left Center Pillar
BP	44	Back Panel Center

○ : SPLICE POINTS

Code	See Page	Wire Harness with Splice Points	Code	See Page	Wire Harness with Splice Points
B7	44	Floor Wire	B11	44	Floor Wire

STOP LIGHT

C8 (A)

(TMC Made) BLUE

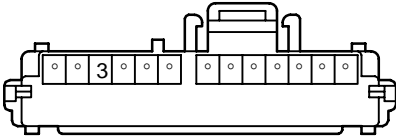

C8 (A)

(TMMK Made) BLUE

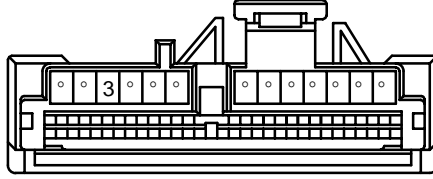

C10 (C)

(TMC Made) BROWN

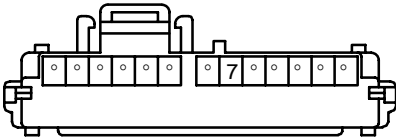

C10 (C)

(TMMK Made) BROWN

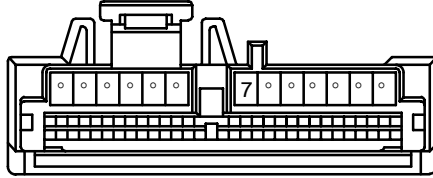

H10



J4

BLACK

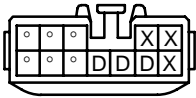

(Hint : See Page 7)

J40

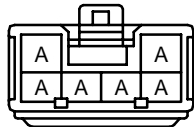

(Hint : See Page 7)

L3

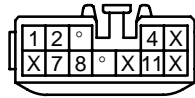

R9

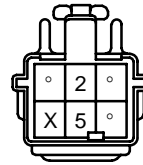

R11

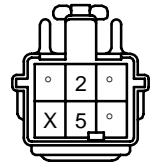

S6

BLUE

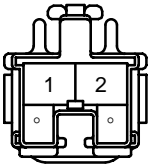

INTERIOR LIGHT

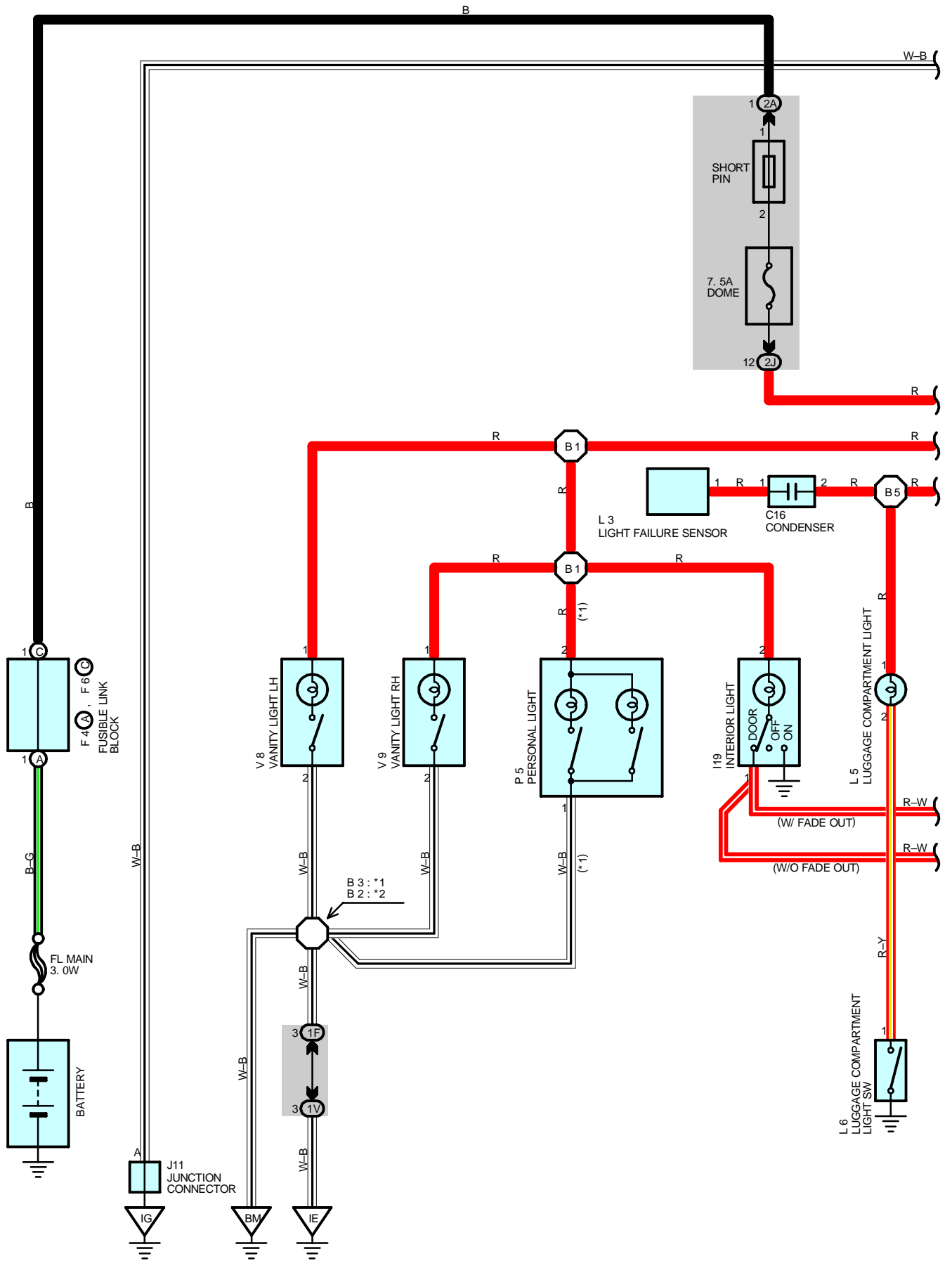

INTERIOR LIGHT

SERVICE HINTS

I18 (A), (B) INTEGRATION RELAY

- 1-GROUND : Always approx. 12 volts
- 4-GROUND : Continuity with the one of each door (Front LH, RH, rear LH and RH) open
- 6-GROUND : Continuity with the front LH door open
- 10-GROUND : Always continuity

D12, D13, D14, D15 DOOR COURTESY SW FRONT LH, RH, REAR LH, RH

- 1-GROUND : Closed with the door open

L6 LUGGAGE COMPARTMENT LIGHT SW

- 1-GROUND : Closed with the luggage compartment door open

○ : PARTS LOCATION

Code	See Page	Code	See Page	Code	See Page		
C9	30	F4	A	28 (5S-FE)	J33	A	31
C16	32	F6	C	26 (1MZ-FE)	J34	B	31
D7	30			28 (5S-FE)	L3	32	
D10	30	I15	30	L5	32		
D12	32	I18	A	30	L6	32	
D13	32		B	30	P5	33	
D14	32	I19	32	V8	33		
D15	32	J11	31	V9	33		
F4	A	26 (1MZ-FE)	J16	31			

○ : JUNCTION BLOCK AND WIRE HARNESS CONNECTOR

Code	See Page	Junction Block and Wire Harness (Connector Location)
1F	20	Roof Wire and Instrument Panel J/B (Lower Finish Panel)
1G	20	Instrument Panel Wire and Instrument Panel J/B (Lower Finish Panel)
1H		
1J	20	Cowl Wire and Instrument Panel J/B (Lower Finish Panel)
1M		
1S	20	Floor Wire and Instrument Panel J/B (Lower Finish Panel)
1V	20	Cowl Wire and Instrument Panel J/B (Lower Finish Panel)
1W		
2A	22	Engine Room Main Wire and Engine Room J/B No.2 (Engine Compartment Left)
2J	22	Cowl Wire and Engine Room J/B No.2 (Engine Compartment Left)

□ : CONNECTOR JOINING WIRE HARNESS AND WIRE HARNESS

Code	See Page	Joining Wire Harness and Wire Harness (Connector Location)
IN2	42	Floor No.2 Wire and Instrument Panel Wire (Right Kick Panel)

▽ : GROUND POINTS

Code	See Page	Ground Points Location
IE	40	Cowl Side Panel LH
IG	40	Instrument Panel Brace LH
BM	44	Roof Left

○ : SPLICE POINTS

Code	See Page	Wire Harness with Splice Points	Code	See Page	Wire Harness with Splice Points
B1	44	Roof Wire	B3	44	Roof Wire
B2			B5	44	Floor Wire

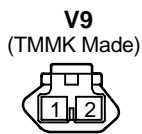
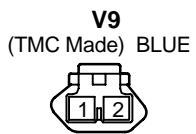
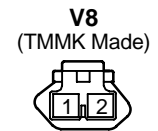
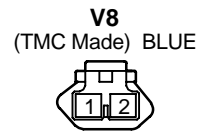
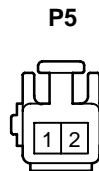
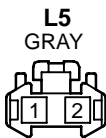
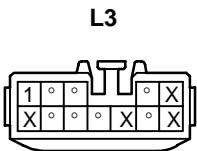
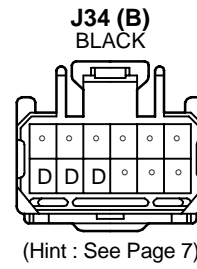
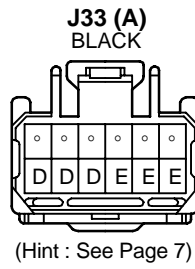
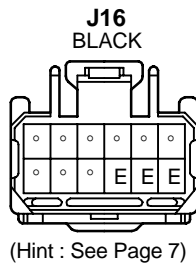
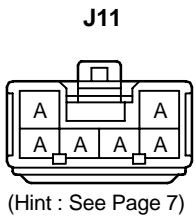
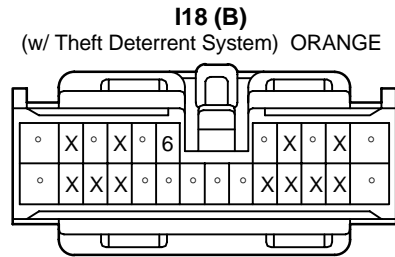
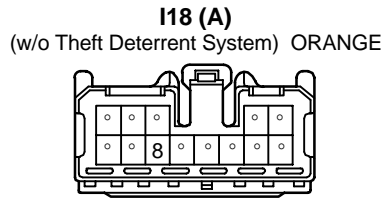
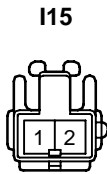
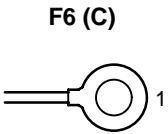
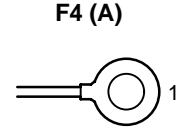
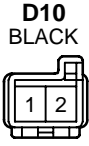
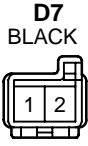
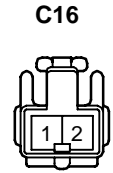
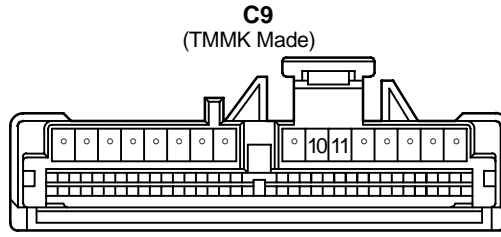
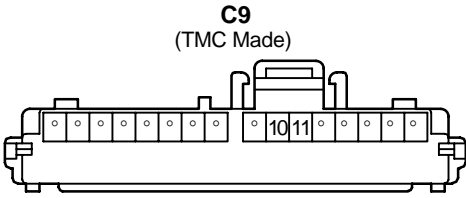

ILLUMINATION

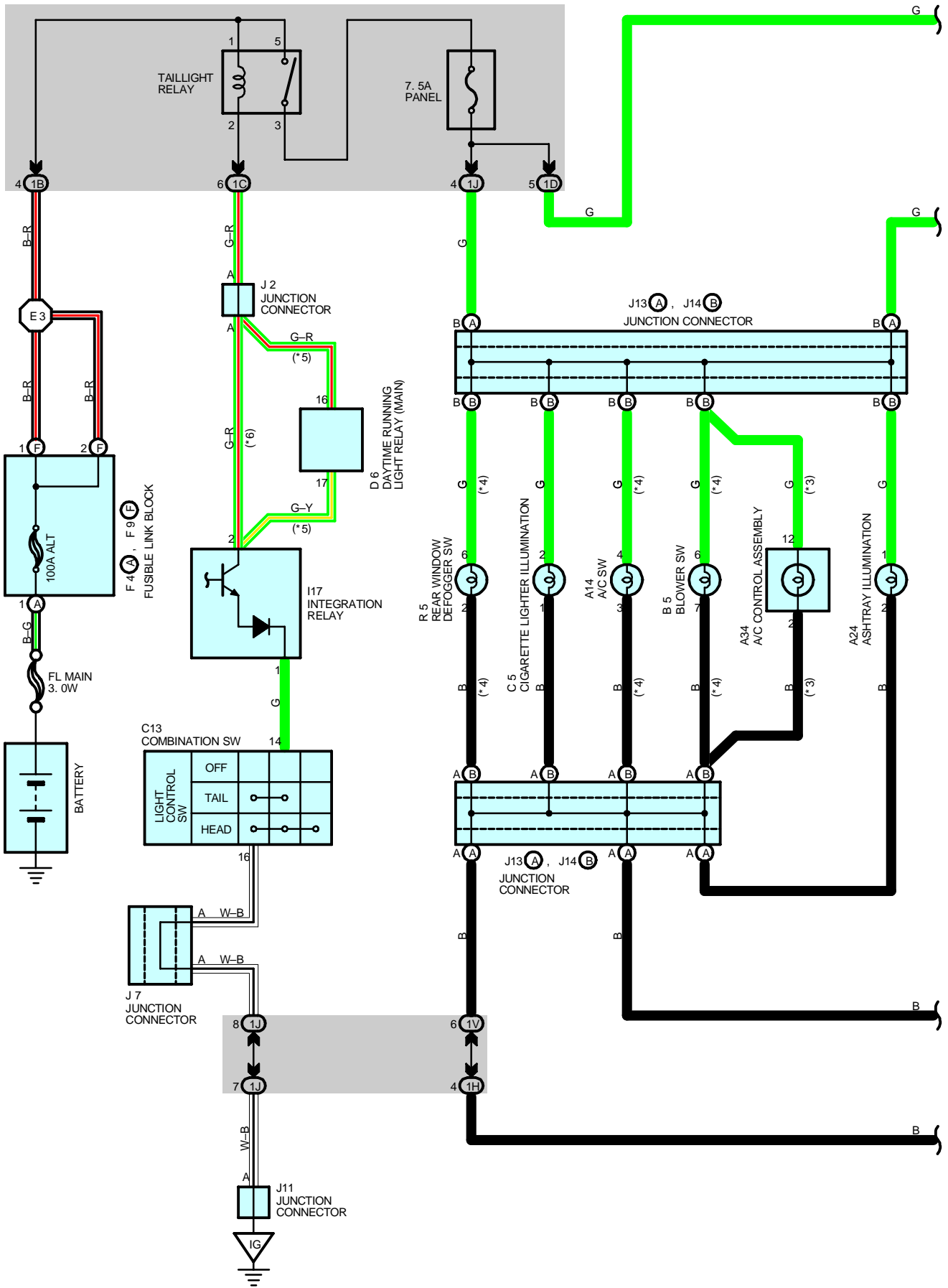

C13 COMBINATION SW

LIGHT CONTROL SW	OFF			
	TAIL	○	○	
	HEAD	○	○	○

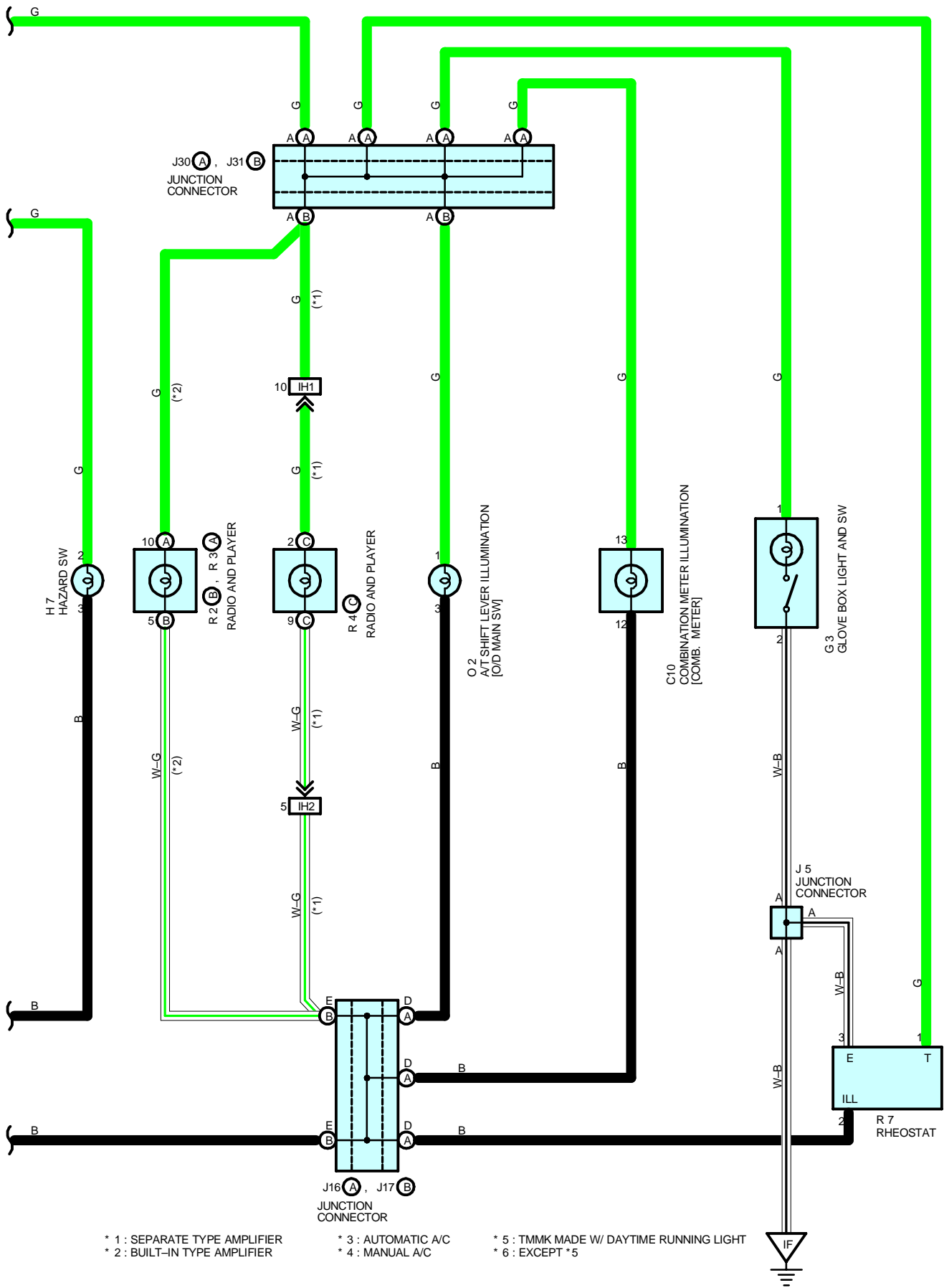

* 1 : SEPARATE TYPE AMPLIFIER
 * 2 : BUILT-IN TYPE AMPLIFIER

* 3 : AUTOMATIC A/C
 * 4 : MANUAL A/C

* 5 : TMMK MADE W/ DAYTIME RUNNING LIGHT
 * 6 : EXCEPT * 5

ILLUMINATION

SERVICE HINTS

TAILLIGHT RELAY [INSTRUMENT PANEL J/B]

5-3 : Closed with the light control SW at **TAIL** or **HEAD** position

C13 COMBINATION SW

14-16 : Closed with the light control SW at **TAIL** or **HEAD** position

○ : PARTS LOCATION

Code	See Page	Code	See Page	Code	See Page
A14	30	F9 F	28 (5S-FE)	J17 B	31
A24	30	G3	30	J30 A	31
A34	30	H7	30	J31 B	31
B5	30	I7	30	O2	31
C5	30	J2	31	R2 B	31
C10	30	J5	31	R3 A	31
C13	30	J7	31	R4 C	31
D6	30	J11	31	R5	31
F4 A	26 (1MZ-FE)	J13 A	31	R7	31
	28 (5S-FE)	J14 B	31		
F9 F	26 (1MZ-FE)	J16 A	31		

○ : JUNCTION BLOCK AND WIRE HARNESS CONNECTOR

Code	See Page	Junction Block and Wire Harness (Connector Location)
1B	20	Cowl Wire and Instrument Panel J/B (Lower Finish Panel)
1C		
1D	20	Instrument Panel Wire and Instrument Panel J/B (Lower Finish Panel)
1H		
1J	20	Cowl Wire and Instrument Panel J/B (Lower Finish Panel)
1V		

□ : CONNECTOR JOINING WIRE HARNESS AND WIRE HARNESS

Code	See Page	Joining Wire Harness and Wire Harness (Connector Location)
IH1	40	Instrument Panel Wire and Instrument Panel No.2 Wire (Instrument Panel Brace RH)
IH2		

▽ : GROUND POINTS

Code	See Page	Ground Points Location
IF	40	Left Kick Panel
IG	40	Instrument Panel Brace LH

○ : SPLICE POINTS

Code	See Page	Wire Harness with Splice Points	Code	See Page	Wire Harness with Splice Points
E3	36 (1MZ-FE)	Cowl Wire	E3	38 (5S-FE)	Cowl Wire

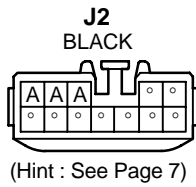
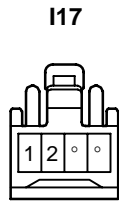
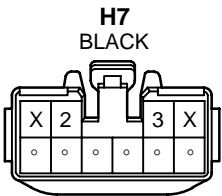
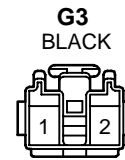
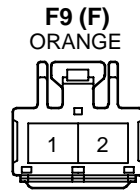
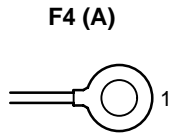
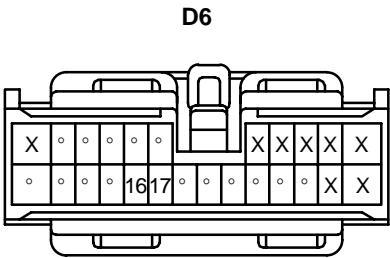
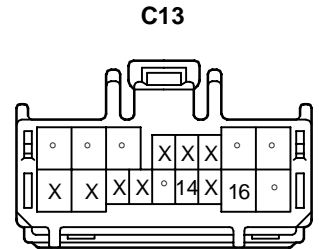
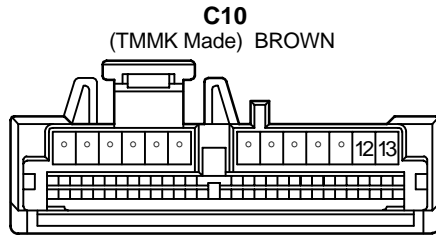
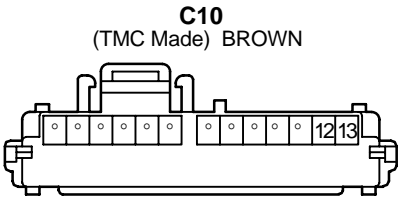
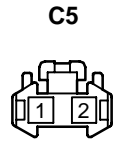
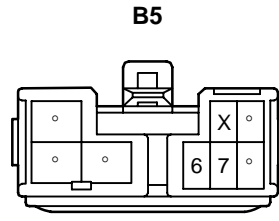
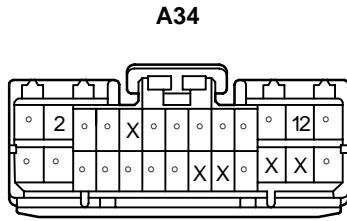

(Hint : See Page 7)

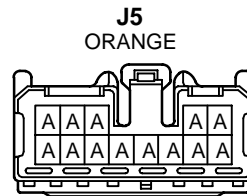

(Hint : See Page 7)

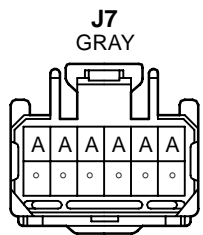

(Hint : See Page 7)

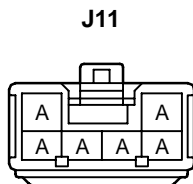

(Hint : See Page 7)

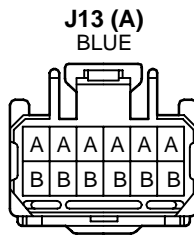

(Hint : See Page 7)

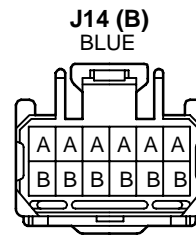

(Hint : See Page 7)

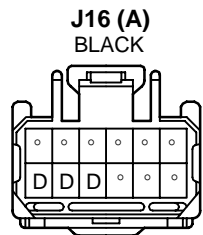

(Hint : See Page 7)

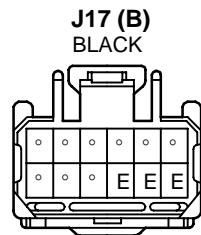

(Hint : See Page 7)

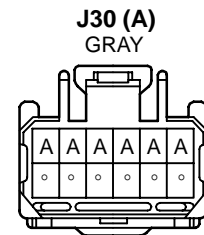

(Hint : See Page 7)

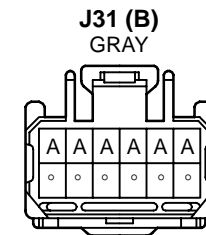

(Hint : See Page 7)

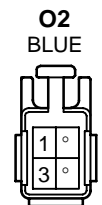

ILLUMINATION

R2 (B)

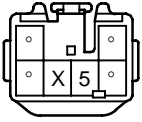

R3 (A)

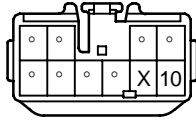

R4 (C)

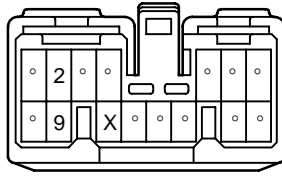

R5
BLACK

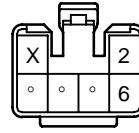

R7
BLACK

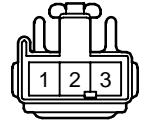

FROM POWER SOURCE SYSTEM (SEE PAGE 50)

- * 1 : TMMK MADE W/ DAYTIME RUNNING LIGHT
- * 2 : EXCEPT *1
- * 3 : TMC MADE

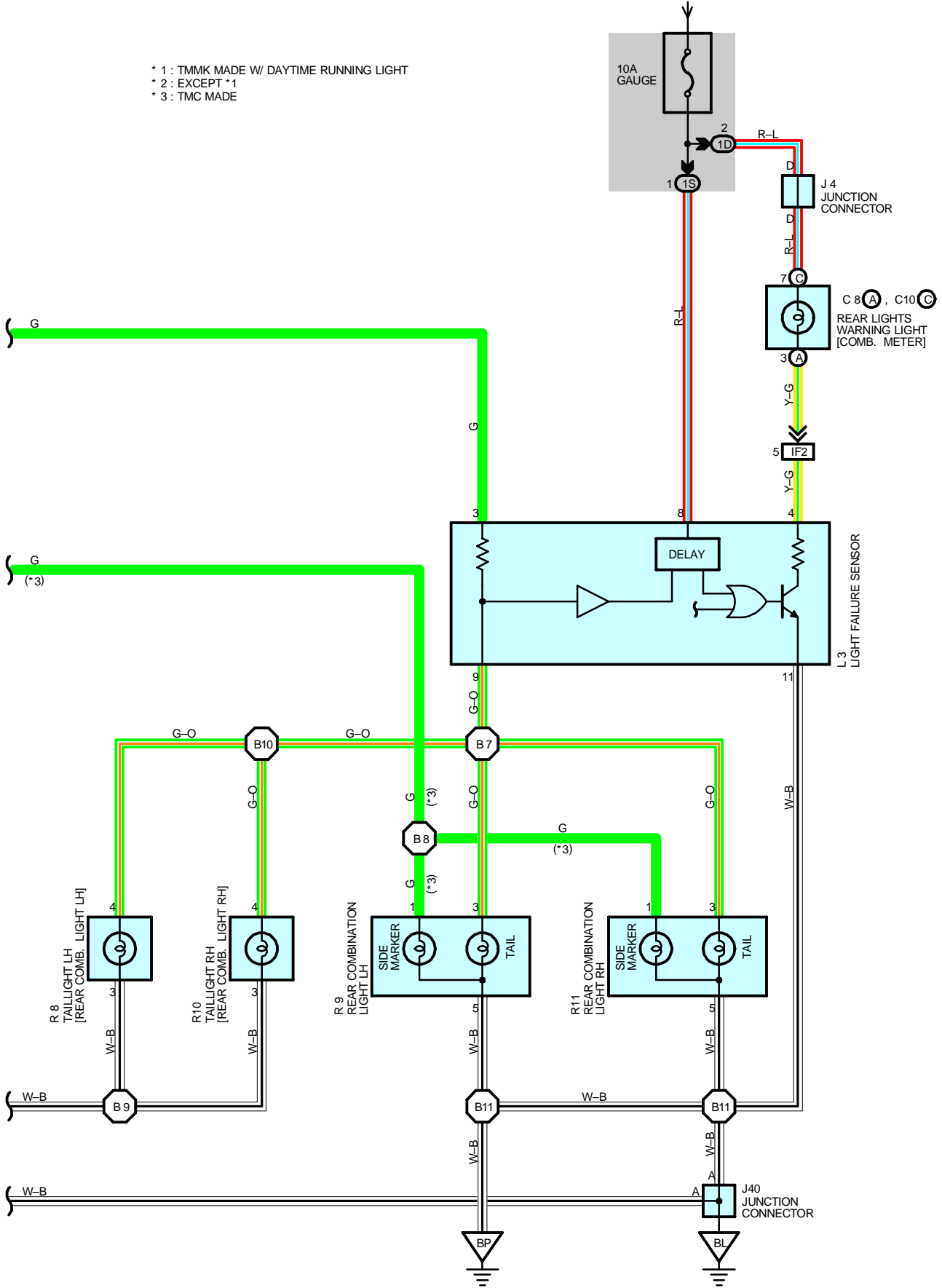

TAILLIGHT

SYSTEM OUTLINE

When the light control SW is turned to TAIL or HEAD position. The current flows to TERMINAL 3 of the light failure sensor through the TAIL fuse.

When the ignition SW is turned on, the current flows from the GAUGE fuse to TERMINAL 8 of the light failure sensor, and also flows through the rear lights warning light to TERMINAL 4 of the light failure sensor.

TAILLIGHT DISCONNECTION WARNING

With the ignition SW on and the light control SW turned to TAIL or HEAD position, if the taillight circuit is open, the light failure sensor detects the failure by the change in current flowing from TERMINAL 3 of the light failure sensor to TERMINAL 9, and the warning circuit of the light failure sensor is activated.

As a result, the current flows from TERMINAL 4 of the light failure sensor to TERMINAL 11 to GROUND and turns the rear lights warning light on, which remains on until the light control SW is turned off

SERVICE HINTS

TAILLIGHT RELAY [INSTRUMENT PANEL J/B]

5-3 : Closed with the light control SW at **TAIL** or **HEAD** position

L3 LIGHT FAILURE SENSOR

4, 8-GROUND : Approx. **12** volts with the ignition SW at **ON** position

3-GROUND : Approx. **12** volts with the light control SW at **TAIL** or **HEAD** position

11-GROUND : Always continuity

○ : PARTS LOCATION

Code	See Page	Code	See Page	Code	See Page	
C8	A	F9	F	26 (1MZ-FE)	J40	32
C10	C			28 (5S-FE)	L1	32
C13	30	I17	30	L2	32	
D6	30	J2	31	L3	32	
F1	26 (1MZ-FE)	J4	31	R8	33	
	28 (5S-FE)	J7	31	L9	33	
F2	26 (1MZ-FE)	J11	31	R10	33	
	28 (5S-FE)	J12	31	R11	33	
F4	A	J35	A	31		
		J36	B	31		

○ : JUNCTION BLOCK AND WIRE HARNESS CONNECTOR

Code	See Page	Junction Block and Wire Harness (Connector Location)
1B	20	Cowl Wire and Instrument Panel J/B (Lower Finish Panel)
1C		
1D	20	Instrument Panel Wire and Instrument Panel J/B (Lower Finish Panel)
1J	20	Cowl Wire and Instrument Panel J/B (Lower Finish Panel)
1S	20	Floor Wire and Instrument Panel J/B (Lower Finish Panel)

□ : CONNECTOR JOINING WIRE HARNESS AND WIRE HARNESS

Code	See Page	Joining Wire Harness and Wire Harness (Connector Location)
IF2	40	Floor Wire and Instrument Panel Wire (Left Kick Panel)

▽ : GROUND POINTS

Code	See Page	Ground Points Location
EB	36 (1MZ-FE)	Left Radiator Side Support
	38 (5S-FE)	
IG	40	Instrument Panel Brace LH
BL	44	Under the Left Center Pillar
BP	44	Back Panel Center



: SPLICE POINTS

Code	See Page	Wire Harness with Splice Points	Code	See Page	Wire Harness with Splice Points
E3	36 (1MZ-FE)	Cowl Wire	B7	44	Floor Wire
	38 (5S-FE)		B8		
E4	36 (1MZ-FE)	Engine Room Main Wire	B9		
	38 (5S-FE)		B10		
B5	44	Floor Wire	B11		

C8 (A)
(TMC Made) BLUE

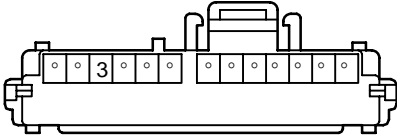

C8 (A)
(TMMK Made) BLUE

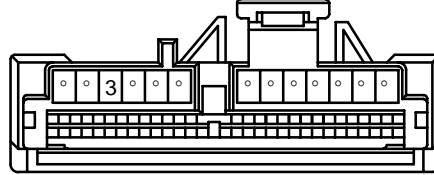

C10 (C)
(TMC Made) BROWN

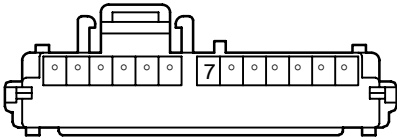

C10 (C)
(TMMK Made) BROWN

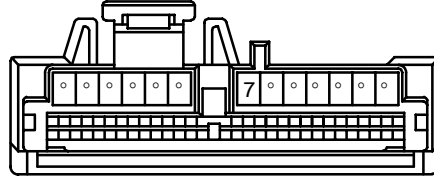

C13

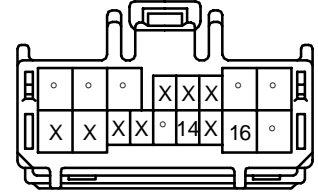

D6

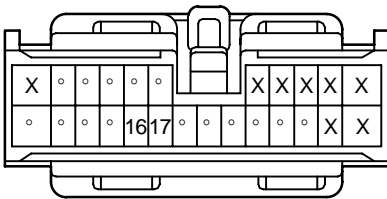

F1
GRAY



F2
GRAY



F4 (A)

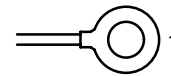

F9 (F)
ORANGE

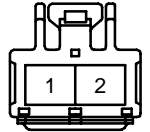

I17

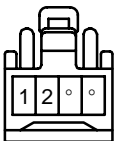

J2
BLACK

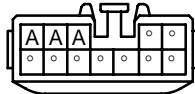

(Hint : See Page 7)

J4
BLACK

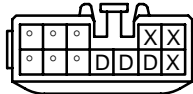

(Hint : See Page 7)

J7
GRAY

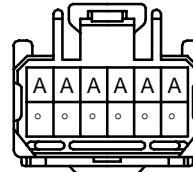

(Hint : See Page 7)

J11



(Hint : See Page 7)

J12
BLACK

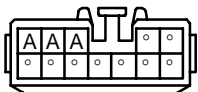

(Hint : See Page 7)

J35 (A)

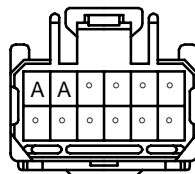

(Hint : See Page 7)

J36 (B)

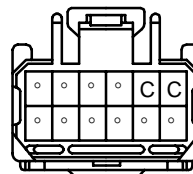

(Hint : See Page 7)

J40

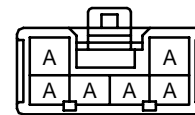

(Hint : See Page 7)

L1
GRAY



TAILLIGHT

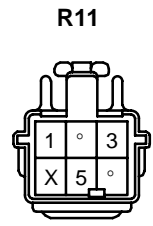
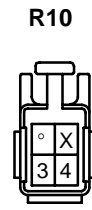
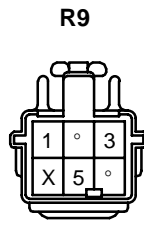
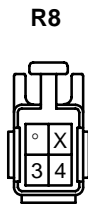
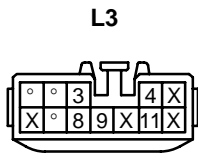

BACK-UP LIGHT

FROM POWER SOURCE SYSTEM (SEE PAGE 50)

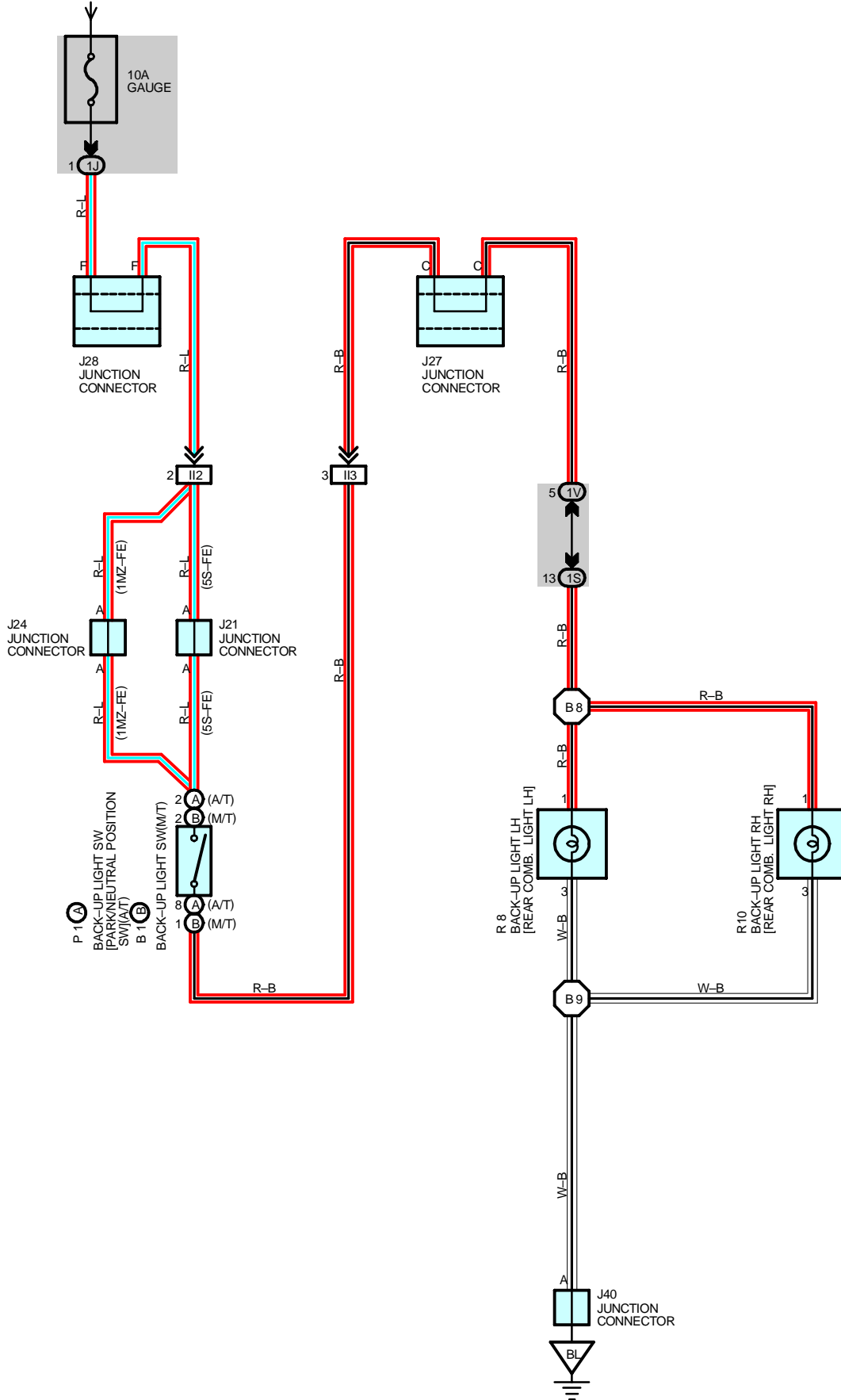

SERVICE HINTS

P1 (A) BACK-UP LIGHT SW [PARK/NEUTRAL POSITION SW] (A/T)

(A) 2-(A) 8 : Closed with the shift lever at **R** position

B1 (B) BACK-UP LIGHT SW (M/T)

(B) 2-(B) 1 : Closed with the shift lever at **R** position

○ : PARTS LOCATION

Code		See Page	Code		See Page	Code		See Page
B1	B	26 (1MZ-FE)	J27	31	P1	A	29 (5S-FE)	
		28 (5S-FE)	J28	31	R 8	33		
J21	31	J40	32	R10	33			
J24	31	P1	A	27 (1MZ-FE)				

○ : JUNCTION BLOCK AND WIRE HARNESS CONNECTOR

Code	See Page	Junction Block and Wire Harness (Connector Location)
1J	20	Cowl Wire and Instrument Panel J/B (Lower Finish Panel)
1S	20	Floor Wire And Instrument Panel J/B (Lower Finish Panel)
1V	20	Cowl Wire and Instrument Panel J/B (Lower Finish Panel)

□ : CONNECTOR JOINING WIRE HARNESS AND WIRE HARNESS

Code	See Page	Joining Wire Harness and Wire Harness (Connector Location)
II2	42	Engine Wire and Cowl Wire (Under the Blower Motor)
II3		

▽ : GROUND POINTS

Code	See Page	Ground Points Location
BL	44	Under the Left Center Pillar

○ : SPLICE POINTS

Code	See Page	Wire Harness with Splice Points	Code	See Page	Wire Harness with Splice Points
B8	44	Floor Wire	B9	44	Floor Wire

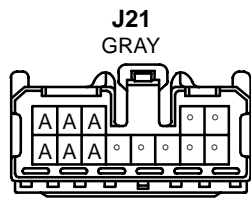
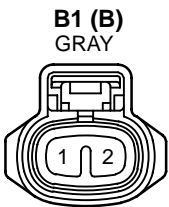

(Hint : See Page 7)

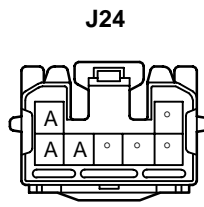

(Hint : See Page 7)

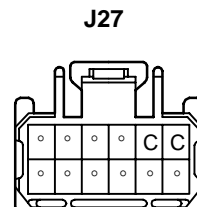

(Hint : See Page 7)

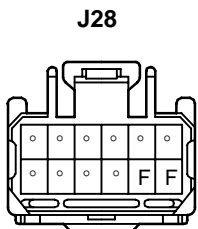

(Hint : See Page 7)

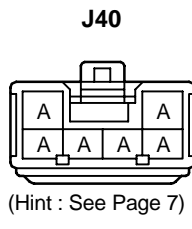

(Hint : See Page 7)

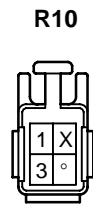
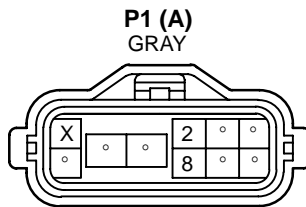

WIPER AND WASHER

- * 1 : W/ INT TIME ADJUST
- * 2 : W/O INT TIME ADJUST

FROM POWER SOURCE SYSTEM (SEE PAGE 50)

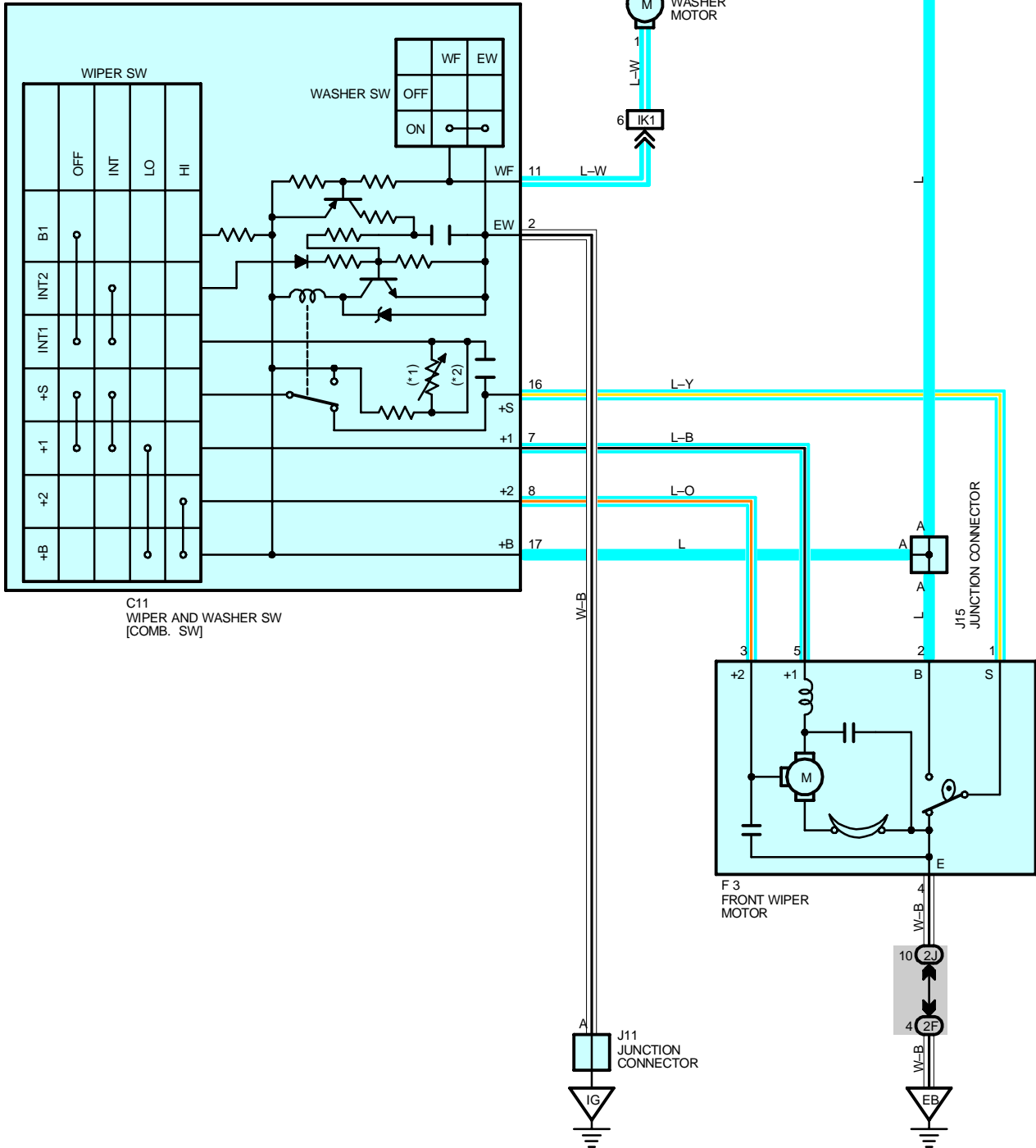

SYSTEM OUTLINE

With the ignition SW turned on, the current flows to TERMINAL 17 of the wiper and washer SW, TERMINAL 2 of the washer motor and TERMINAL 2 of the front wiper motor through the WIPER fuse.

1. LOW SPEED POSITION

With the wiper and washer SW turned to LO position, the current flows from TERMINAL 17 of the wiper and washer SW to TERMINAL 7 to TERMINAL 5 of the front wiper motor to TERMINAL 4 to GROUND and causes the front wiper motor to run at low speed.

2. HIGH SPEED POSITION

With the wiper and washer SW turned to HI position, the current flows from TERMINAL 17 of the wiper and washer SW to TERMINAL 8 to TERMINAL 3 of the front wiper motor to TERMINAL 4 to GROUND and causes the front wiper motor to run at high speed.

3. INT POSITION

With the wiper and washer SW turned to INT position, the wiper relay operates and current flows from TERMINAL 17 of the wiper and washer SW to TERMINAL 2 to GROUND. This activates the intermittent circuit and the current flows from TERMINAL 17 of the wiper and washer SW to TERMINAL 7 to TERMINAL 5 of the front wiper motor to TERMINAL 4 to GROUND and the wiper operates. Intermittent operation is controlled by a condenser charge and discharge function in the relay.

4. WASHER CONTINUOUS OPERATION

With the wiper and washer SW pulled to WASHER position (Washer SW ON position), the current flows from the WIPER fuse to TERMINAL 2 of the washer motor to TERMINAL 1 to TERMINAL 11 of the wiper and washer SW to TERMINAL 2 to GROUND and causes the washer motor to run and the window washer to spray. Simultaneously, current flows from the WIPER fuse to TERMINAL 17 of the wiper and washer SW to TERMINAL 7 to TERMINAL 5 of the front wiper motor to TERMINAL 4 to GROUND, causing the wiper to function.

SERVICE HINTS

C11 WIPER AND WASHER SW [COMB. SW]

2-GROUND : Always continuity

17-GROUND : Approx. **12** volts with the ignition SW at **ON** position

7-GROUND : Approx. **12** volts with the ignition SW on and the wiper and washer SW at **LO** position
Approx. **12** volts every approx. **1** to **10** seconds intermittently with the ignition SW on and the wiper and washer SW at **INT** position

16-GROUND : Approx. **12** volts with the ignition SW on and unless the front wiper motor at **STOP** position

8-GROUND : Approx. **12** volts with the ignition SW on and the wiper and washer SW at **HI** position

F3 FRONT WIPER MOTOR

1-2 : Closed unless the front wiper motor at **STOP** position

○ : PARTS LOCATION

Code	See Page	Code	See Page	Code	See Page
C11	30	J11	31	J36 B	31
F3	26 (1MZ-FE)	J15	31	W2	27 (1MZ-FE)
	28 (5S-FE)	J35 A	31		29 (5S-FE)

○ : JUNCTION BLOCK AND WIRE HARNESS CONNECTOR

Code	See Page	Junction Block and Wire Harness (Connector Location)
1A	20	Cowl Wire and Instrument Panel J/B (Lower Finish Panel)
1C		
2F	22	Engine Room Main Wire and Engine Room J/B No.2 (Engine Compartment Left)
2J	22	Cowl Wire and Engine Room J/B No.2 (Engine Compartment Left)

□ : CONNECTOR JOINING WIRE HARNESS AND WIRE HARNESS

Code	See Page	Joining Wire Harness and Wire Harness (Connector Location)
IK1	42	Engine Room Main Wire and Cowl Wire (Right Kick Panel)

WIPER AND WASHER

▽ : GROUND POINTS

Code	See Page	Ground Points Location
EB	36 (1MZ-FE)	Left Radiator Side Support
	38 (5S-FE)	
IG	40	Instrument Panel Brace LH

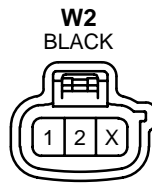
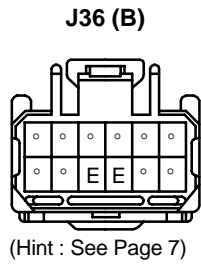
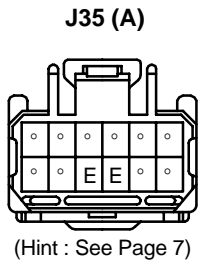
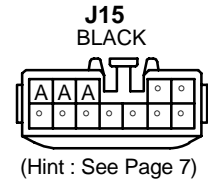
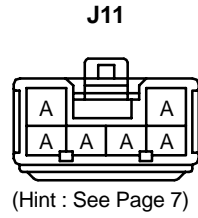
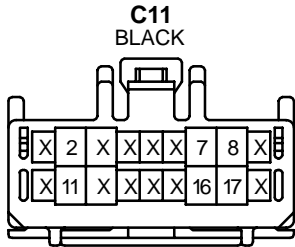

* 1 : W/O THEFT DETERRENT SYSTEM
 * 2 : W/ THEFT DETERRENT SYSTEM

* 3 : TMC MADE
 * 4 : TMMK MADE

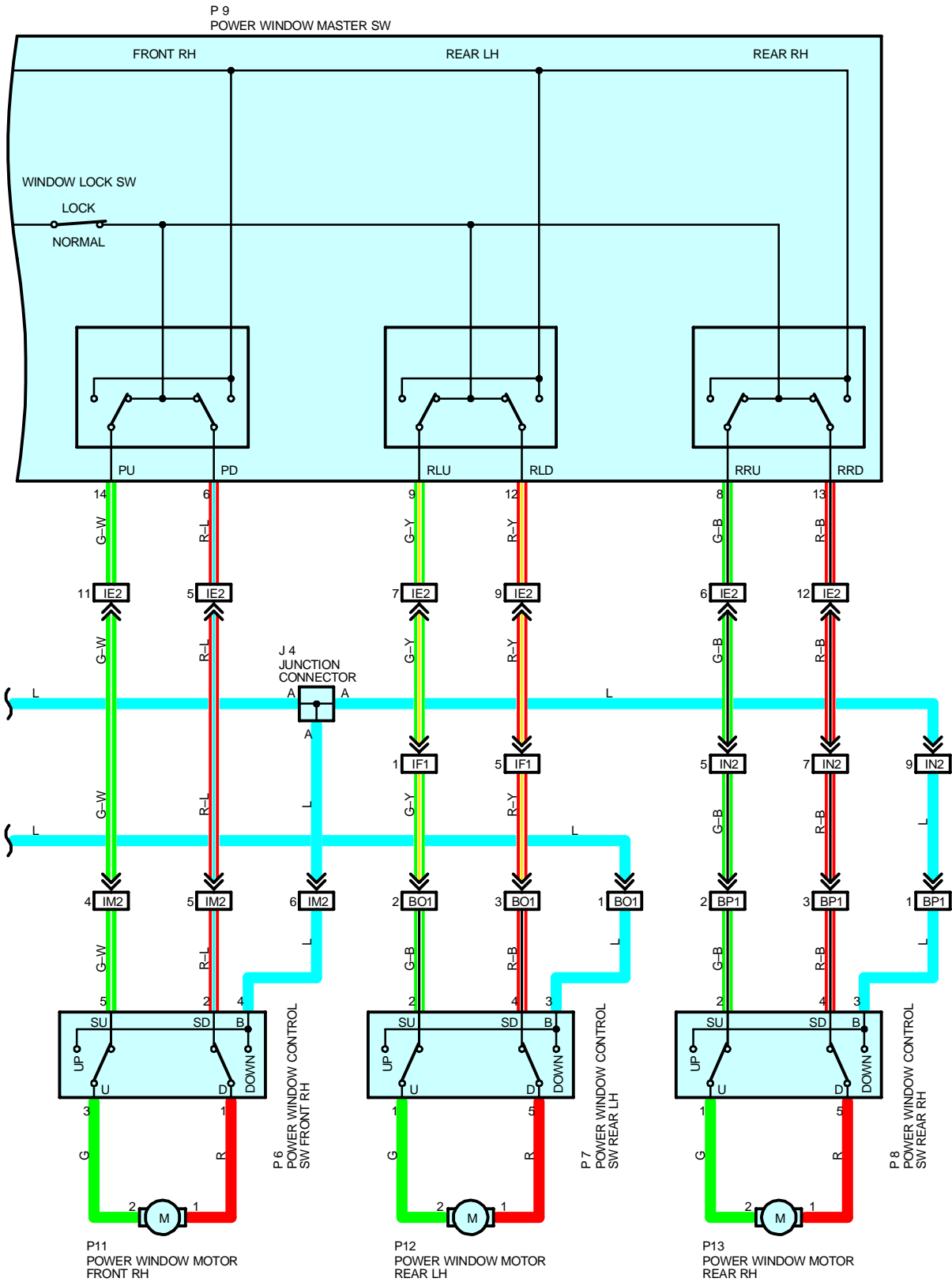

POWER WINDOW

SYSTEM OUTLINE

With the ignition SW turned on, current flows through the GAUGE fuse to TERMINAL 7 of the integration relay to TERMINAL (A) 12 (w/o theft deterrent system), (B) 3 (w/ theft deterrent system) to TERMINAL 1 of the power relay to TERMINAL 2 to GROUND, this activates the relay and the current flowing to TERMINAL 5 of the relay from the POWER fuse flows to TERMINAL 3 of the relay to TERMINALS 10 and 11 of the power window master SW.

1. MANUAL OPERATION (DRIVER'S WINDOW)

With the ignition SW turned on and with the power window master SW (Driver's) in UP position, the current flowing from TERMINALS 10 and 11 of the power window master SW flows to TERMINAL 1 of the master SW to TERMINAL 1 of the power window motor to TERMINAL 2 to TERMINAL 5 of the master SW to TERMINALS 3 and 4 to GROUND and causes the power window motor to rotate in the up direction. The window ascends only while the SW is being pushed.

In down operation, the flow of current from TERMINALS 10 and 11 of the power window master SW to TERMINAL 5 of the master SW causes the flow of current from TERMINAL 2 of the power window motor to TERMINAL 1 to TERMINAL 1 of the master SW to TERMINALS 3 and 4 to GROUND, flowing in the opposite direction to manual up operation and causing the motor to rotate in reverse, lowering the window.

2. AUTO DOWN OPERATION (DRIVER'S WINDOW)

When the driver's window SW is pushed strongly to the down side, the current flowing to TERMINALS 10 and 11 of the power window master SW flows to the down contact point and auto down contact point of the driver's SW.

This activates the relay (Down side) inside the power window master SW and the hold circuit also turns on at the same time, so the relay (Down side) remains activated even when the SW is released.

Current flows at this time from TERMINALS 10 and 11 of the power window master SW to TERMINAL 5 to TERMINAL 2 of the power window motor to TERMINAL 1 to TERMINAL 1 of the power window master SW to TERMINALS 3 and 4 to GROUND, so the motor continues to operate until the driver's window is fully down.

When the driver's window finishes down operation and the hold circuit goes off, so the relay (Down side) also turns off. This stops the current flowing from TERMINALS 10 and 11 of the power window master SW to TERMINAL 5 is cut off, so the power window motor stops and auto down operation stops.

When the driver's SW is pulled to the up side during auto down operation, the hold circuit is turned off so the current flowing from TERMINALS 10 and 11 of the power window master SW to TERMINAL 5 is cut off and the power window motor stops. If the SW remains pulled up the relay (Up side) is activated, so current flows from TERMINALS 10 and 11 of the power window master SW to TERMINAL 1 to TERMINAL 1 of the power window motor to TERMINAL 2 to TERMINAL 5 to TERMINALS 3 and 4 to GROUND, the power window motor rotates in the up direction and manual up operation occurs while the SW is pulled up.

3. MANUAL OPERATION (FRONT RH WINDOW)

With the power window control SW front RH pulled to the up side, the current flowing from TERMINAL 4 of the power window control SW flows to TERMINAL 3 of the power window control SW to TERMINAL 2 of the power window motor to TERMINAL 1 to TERMINAL 1 of the power window control SW to TERMINAL 2 to TERMINAL 6 of the master SW to TERMINALS 3 and 4 to GROUND and causes the power window motor front RH to rotate in the up direction. The up operation continues only while the power window control SW is pulled to the up side. When the window descends, the current flowing to the motor flows in the opposite direction, from TERMINAL 1 to TERMINAL 2, and the motor rotates in reverse. When the window lock SW is pushed to the lock side, the ground circuit to the front RH window becomes open.

As a result, even if Open/Close operation of the front RH window is tried, the current from TERMINALS 3 and 4 of the power window master SW is not grounded and the motor does not rotate, so the front RH window can not be operated and window lock occurs.

4. MANUAL OPERATION (REAR LH, RH WINDOW)

With the power window control SW rear LH, RH pulled to the up side, the current flowing from TERMINAL 3 of the power window control SW flows to TERMINAL 1 of the power control SW to TERMINAL 2 of the power window motor to TERMINAL 1 to TERMINAL 5 of the power window control SW to TERMINAL 4 to TERMINAL 12 or 13 of the master SW to TERMINALS 3 and 4 to GROUND and causes the power window motor rear LH, RH to rotate in the up direction. The up operation continues only while the power window control SW is pulled to the up side. When the window descends, the current flowing to the motor flows in the opposite direction, from TERMINAL 1 to TERMINAL 2, and the motor rotates in reverse. When the window lock SW is pushed to the lock side, the ground circuit to the rear LH, RH window becomes open.

As a result, even if Open/Close operation of the rear LH, RH window is tried, the current from TERMINALS 3 and 4 of the power window master SW is not grounded and the motor does not rotate, so the rear LH, RH window can not be operated and window lock occurs.

5. KEY OFF POWER WINDOW OPERATION

With the ignition SW turned from on to off, the integration relay operates and current flows from the DOOR fuse to TERMINAL (A) 13 (w/o theft deterrent system), (B) 1 (w/ theft deterrent system) of the relay to TERMINAL (A) 12 (w/o theft deterrent system), (B) 3 (w/ theft deterrent system) to TERMINAL 1 of the power relay to TERMINAL 2 to GROUND for about 43 seconds. The same as normal operation, the current flows from the POWER fuse to TERMINAL 5 of the power relay to TERMINAL 3 to TERMINALS 10 and 11 of the power window master SW and TERMINAL 4 (Front RH) or 3 (Rear LH, RH) of the power window control SW. As a result, for about 43 seconds after the ignition SW is turned off, the functioning of this relay makes it possible to raise and lower the power window. Also, by opening the front doors (Door courtesy SW on) within about 43 seconds after turning the ignition SW to off, a signal is input to TERMINAL 6 or (A) 8 (w/o theft deterrent system), (B) 6 (w/ theft deterrent system) of the integration relay. As a result, the relay turned off, and up and down movement of the power window stops.

SERVICE HINTS

P9 POWER WINDOW MASTER SW

- 10, 11-GROUND : Approx. **12** volts with the ignition SW at **ON** position or key off power window operation
- 3, 4-GROUND : Always continuity
- 1-GROUND : Approx. **12** volts with the ignition SW on and the master SW (Driver's window) at **UP** position
- 5-GROUND : Approx. **12** volts with the ignition SW on and the master SW (Driver's window) at **DOWN** or **AUTO DOWN** position

WINDOW LOCK SW

Open with the window lock SW at **LOCK** position

○ : PARTS LOCATION

Code	See Page	Code	See Page	Code	See Page
D12	32	J33	A 31	P9	33
D13	32	J34	B 31	P10	33
I18	A	J38	32	P11	33
	B	P6	33	P12	33
J4	31	P7	33	P13	33
J11	31	P8	33		

○ : JUNCTION BLOCK AND WIRE HARNESS CONNECTOR

Code	See Page	Junction Block and Wire Harness (Connector Location)
1D	20	Instrument Panel Wire and Instrument Panel J/B (Lower Finish Panel)
1G		
1J	20	Cowl Wire and Instrument Panel J/B (Lower Finish Panel)
1S	20	Floor Wire and Instrument Panel J/B (Lower Finish Panel)
1V	20	Cowl Wire and Instrument Panel J/B (Lower Finish Panel)

□ : CONNECTOR JOINING WIRE HARNESS AND WIRE HARNESS

Code	See Page	Joining Wire Harness and Wire Harness (Connector Location)
IE1	40	Front Door LH Wire and Instrument Panel Wire (Left Kick Panel)
IE2		
IF1	40	Floor Wire and Instrument Panel Wire (Left Kick Panel)
IM2	42	Front Door RH Wire and Instrument Panel Wire (Right Kick Panel)
IN2	42	Floor No.2 Wire and Instrument Panel Wire (Right Kick Panel)
BO1	44	Rear Door Wire LH and Floor Wire (Under the Left Center Pillar)
BP1	44	Rear Door Wire RH and Floor No.2 Wire (Under the Right Center Pillar)

▽ : GROUND POINTS

Code	See Page	Ground Points Location
IE	40	Cowl Side Panel LH
IG	40	Instrument Panel Brace LH

POWER WINDOW

 : SPLICE POINTS

Code	See Page	Wire Harness with Splice Points	Code	See Page	Wire Harness with Splice Points
B13	44	Front Door LH Wire			

D12



D13



I18 (A)

(w/o Theft Deterrent System) ORANGE

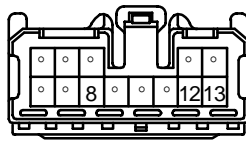

I18 (B)

(w/ Theft Deterrent System) ORANGE

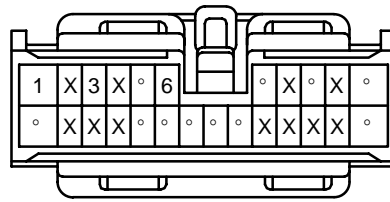

J4

BLACK

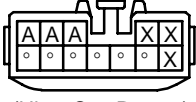

(Hint : See Page 7)

J11

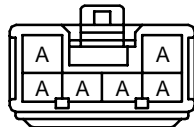

(Hint : See Page 7)

J33 (A)

BLACK

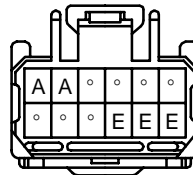

(Hint : See Page 7)

J34 (B)

BLACK

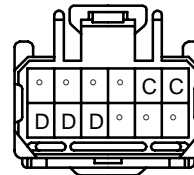

(Hint : See Page 7)

J38



(Hint : See Page 7)

P6

(TMC Made) BLACK

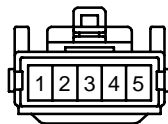

P6

(TMMK Made)

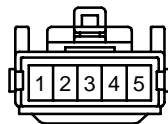

P7



P8



P9

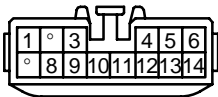

P10



P11



P12



P13



DOOR LOCK CONTROL (TMC MADE)

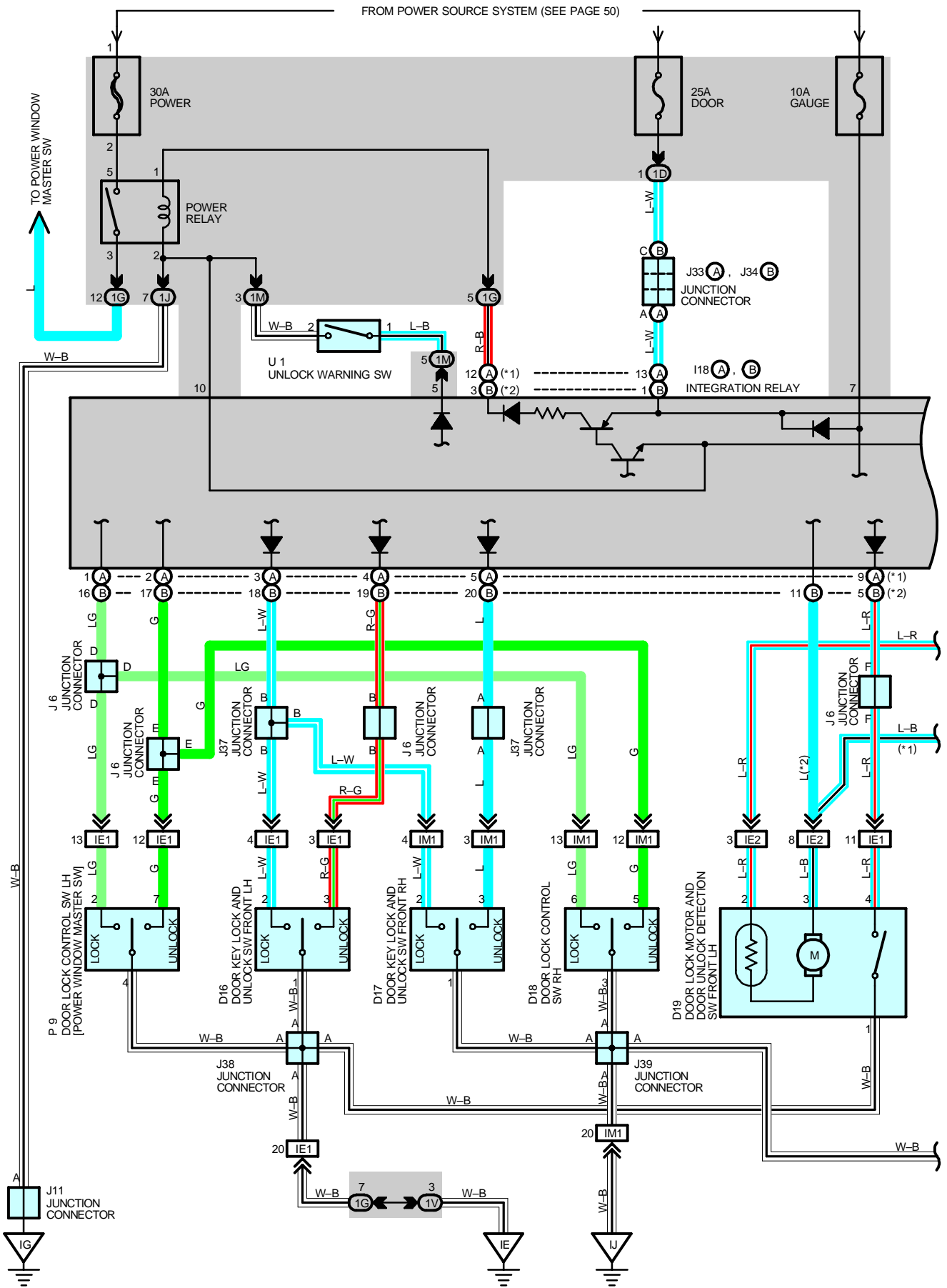

* 1 : W/O THEFT DETERRENT SYSTEM
 * 2 : W/ THEFT DETERRENT SYSTEM

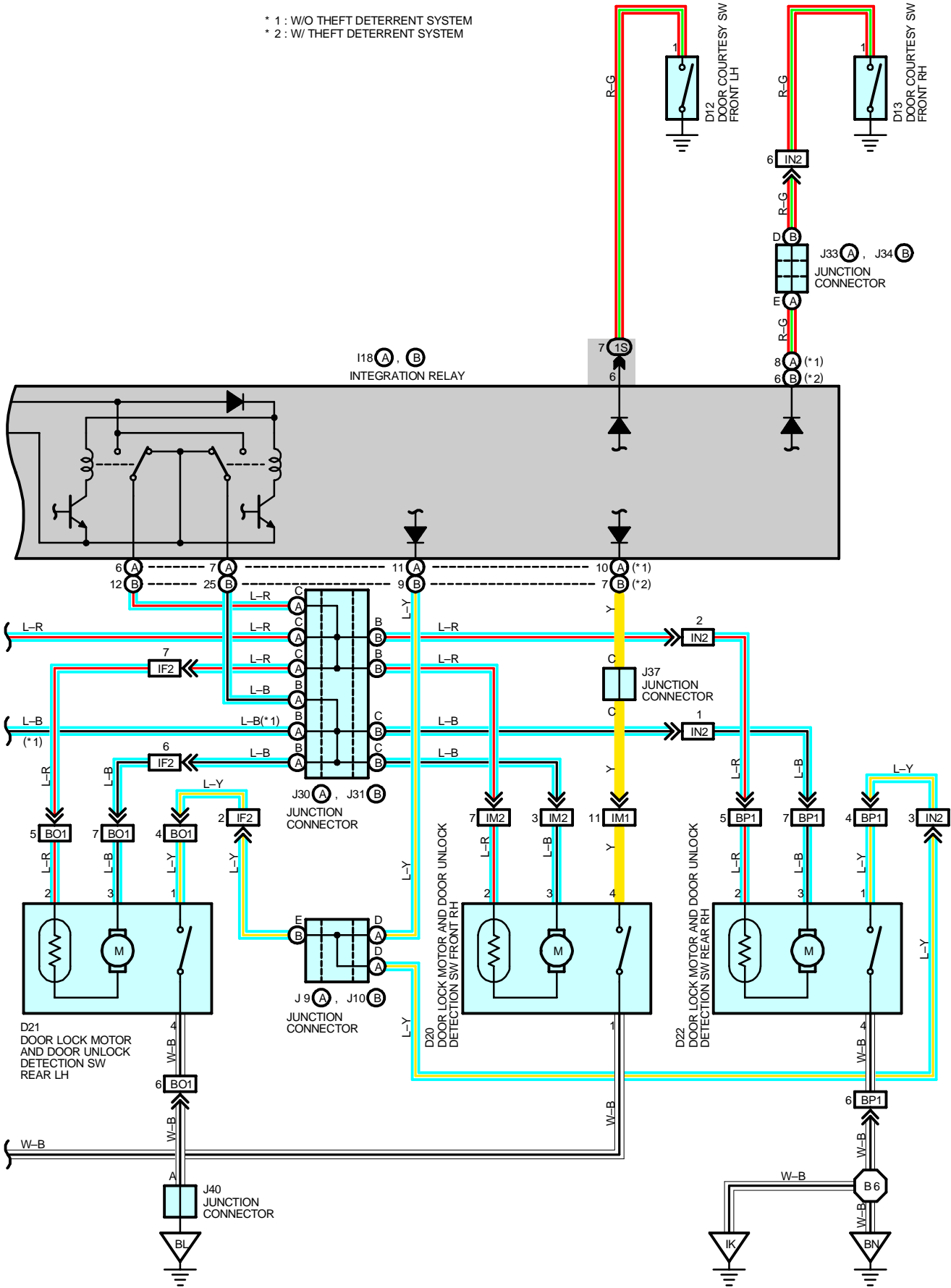

DOOR LOCK CONTROL (TMC MADE)

SYSTEM OUTLINE

Current always flows to TERMINAL (A) 13 (w/o theft deterrent system), (B) 1 (w/ theft deterrent system) of the integration relay through the DOOR fuse.

When the ignition SW is turned on, the current flowing through the GAUGE Fuse flows to TERMINAL 7 of the integration relay to TERMINAL (A) 12 (w/o theft deterrent system), (B) 3 (w/ theft deterrent system) to the power relay (Coil side) to GROUND.

1. MANUAL LOCK OPERATION

When the door lock control SW or door key lock and unlock SW are operated to LOCK position, a lock signal is input to TERMINAL (A) 1 or (A) 3 (w/o theft deterrent system), (B) 16 or (B) 18 (w/ theft deterrent system) of the integration relay and causes the relay to function. Current flows from TERMINAL (A) 13 (w/o theft deterrent system), (B) 1 (w/ theft deterrent system) of the relay to (A) 6 (w/o theft deterrent system), (B) 12 (w/ theft deterrent system) to TERMINAL 2 of the door lock motors to TERMINAL 3 to TERMINAL (A) 7 (w/o theft deterrent system), (B) 11 and (B) 25 (w/ theft deterrent system) of the relay to TERMINAL 10 to GROUND and the door lock motor causes the door to lock.

2. MANUAL UNLOCK OPERATION

When the door lock control SW or door key lock and unlock SW are operated to UNLOCK position, an unlock signal is input to TERMINAL (A) 2, (A) 4 or (A) 5 (w/o theft deterrent system), (B) 17, (B) 19 or (B) 20 (w/ theft deterrent system) of the integration relay and causes the relay to function. Current flows from TERMINAL (A) 13 (w/o theft deterrent system), (B) 1 (w/ theft deterrent system) of the relay to TERMINAL (A) 7 (w/o theft deterrent system), (B) 11 and (B) 25 (w/ theft deterrent system) to TERMINAL 3 of the door lock motors to TERMINAL 2 to TERMINAL (A) 6 (w/o theft deterrent system), (B) 12 (w/ theft deterrent system) of the relay to TERMINAL 10 to GROUND and door lock motors causes door to unlock.

3. DOUBLE OPERATION UNLOCK OPERATION

When the door key lock and unlock SW front LH is turned to the unlock side, only the driver's door is mechanically unlocked. Turning the door key lock and unlock SW front LH to the unlock side causes a signal to be input to TERMINAL (A) 4 (w/o theft deterrent system), (B) 19 (w/ theft deterrent system) of the relay, and if the signal is input again within 3 seconds by turning the SW to the unlock side again, current flows from TERMINAL (A) 7 (w/o theft deterrent system), (B) 11 and (B) 25 (w/ theft deterrent system) of the integration relay to TERMINAL 3 of the door lock motors to TERMINAL 2 of the door lock motors to TERMINAL (A) 6 (w/o theft deterrent system), (B) 12 (w/ theft deterrent system) of the relay to TERMINAL 10 to GROUND, causing the door lock motors to operate and unlock the doors.

4. IGNITION KEY REMINDER OPERATION

* Operating door lock knob (Operation of door lock motors)

With ignition key in cylinder (Unlock warning SW on), when the door is opened and locked using door lock knob (Door lock motor), the door is locked once but each door is unlocked soon by the function of the relay. As a result, the current flows from TERMINAL (A) 13 (w/o theft deterrent system), (B) 1 (w/ theft deterrent system) of the integration relay to TERMINAL (A) 7 (w/o theft deterrent system), (B) 11 and (B) 25 (w/ theft deterrent system) to TERMINAL 3 of the door lock motors to TERMINAL 2 of the door lock motors to TERMINAL (A) 6 (w/o theft deterrent system), (B) 12 (w/ theft deterrent system) of the relay to TERMINAL 10 to GROUND and causes all the doors to unlock.

* Operating door lock control SW or door key lock and unlock SW

With ignition key in cylinder (Unlock warning SW on), when the door is opened and locked using door lock control SW or key SW, the door is locked once but each door is unlock by the function of SW contained in motors, which the signal is input to TERMINAL (A) 9 or (A) 10 (w/o theft deterrent system), (B) 5 or (B) 7 (w/ theft deterrent system) of the relay. According to this input signal, the current in ECU flows from TERMINAL (A) 13 (w/o theft deterrent system), (B) 1 (w/ theft deterrent system) of the relay to TERMINAL (A) 7 (w/o theft deterrent system), (B) 11 and (B) 25 (w/ theft deterrent system) to TERMINAL 3 of the door lock motors to TERMINAL 2 of the door lock motors to TERMINAL (A) 6 (w/o theft deterrent system), (B) 12 (w/ theft deterrent system) of the relay to TERMINAL 10 to GROUND and causes all the doors to unlock.

* In case of key less lock

With ignition key in cylinder (Unlock warning SW on), when the unlock function is disturbed more than 0.2 seconds, for example pushing the door lock knob etc., the door holds on lock condition. Closing the door after, door courtesy SW inputs the signal into TERMINAL 6 or (A) 8 (w/o theft deterrent system), (B) 6 (w/ theft deterrent system) of the integration relay. By this input signal, the ECU works and current flows from TERMINAL (A) 13 (w/o theft deterrent system), (B) 1 (w/ theft deterrent system) of the relay to TERMINAL (A) 7 (w/o theft deterrent system), (B) 11 and (B) 25 (w/ theft deterrent system) to TERMINAL 3 of the door lock motors to TERMINAL 2 of the door lock motors to TERMINAL (A) 6 (w/o theft deterrent system), (B) 12 (w/ theft deterrent system) of the relay to TERMINAL 10 to GROUND and causes all the doors to unlock.

SERVICE HINTS

I18 (A), (B) INTEGRATION RELAY

10-GROUND : Always continuity

6-GROUND : Continuity with driver's door open

7-GROUND : Approx. **12** volts with ignition SW at **ON** position

(A)13 or (B) 1-GROUND: Always approx. **12** volts

(A) 6 or (B)12-GROUND: Approx. **12** volts **0.2** seconds with following operation

* Door lock control SW locked

* Locking driver's, front passenger's door cylinder with key

(A) 1or (B)16-GROUND : Continuity with door lock control SW locked

(A) 8 or (B) 6-GROUND : Continuity with front passenger's door open

(A) 9 or (B) 5-GROUND : Continuity with driver's door lock knob unlocked

(A)10 or (B) 7-GROUND: Continuity with front passenger's door lock knob unlock

(A) 2 or (B)17-GROUND: Continuity with door lock control SW unlocked

(A) 5 or (B)20-GROUND: Continuity with front passenger's door lock cylinder unlocked with key

(A) 4 or (B)19-GROUND: Continuity with driver's door lock cylinder unlocked with key

(A) 3 or (B)18-GROUND: Continuity with driver's, front passenger's door lock cylinder locked with key

(A) 7 or (B)11, (B)25-GROUND : Approx. **12** volts **0.2** seconds with following operation

* Door lock control SW unlocked

* Door lock control SW locked with ignition key in cylinder and driver's door open
(Ignition key reminder function)

* Door lock knob locked with ignition key in cylinder and driver's door open
(Ignition key reminder function)

* Unlocking driver's, front passenger's door cylinder with key

D12, D13 DOOR COURTESY SW FRONT LH,RH

1-GROUND : Closed with each door open

D16, D17 DOOR KEY LOCK AND UNLOCK SW FRONT LH,RH

1-2 : Closed with door lock cylinder locked with key

1-3 : Closed with door lock cylinder unlocked with key

D19, D20 DOOR LOCK MOTOR AND DOOR UNLOCK DETECTION SW FRONT LH,RH

1-4 : Closed with door lock knob **UNLOCK** position

U1 UNLOCK WARNING SW

1-2 : Closed with ignition key in cylinder

○ : PARTS LOCATION

Code	See Page	Code	See Page	Code	See Page
D12	32	I18	A 30	J34	B 31
D13	32		B 30	J37	31
D16	32	J6		J38	32
D17	32	J9	A 31	J39	32
D18	32	J10	B 31	J40	32
D19	32	J11		P9	33
D20	32	J30	A 31	U1	31
D21	32	J31	B 31		
D22	32	J33	A 31		

○ : JUNCTION BLOCK AND WIRE HARNESS CONNECTOR

Code	See Page	Junction Block and Wire Harness (Connector Location)
1D	20	Instrument Panel Wire and Instrument Panel J/B (Lower Finish Panel)
1G		
1J	20	Cowl Wire and Instrument Panel J/B (Lower Finish Panel)
1M		
1S	20	Floor Wire and Instrument Panel J/B (Lower Finish Panel)
1V	20	Cowl Wire and Instrument Panel J/B (Lower Finish Panel)

DOOR LOCK CONTROL (TMC MADE)

 : CONNECTOR JOINING WIRE HARNESS AND WIRE HARNESS

Code	See Page	Joining Wire Harness and Wire Harness (Connector Location)
IE1	40	Front Door LH Wire and Instrument Panel Wire (Left Kick Panel)
IE2		
IF2	40	Floor Wire and Instrument Panel Wire (Left Kick Panel)
IM1	42	Front Door RH Wire and Instrument Panel Wire (Right Kick Panel)
IM2		
IN2	42	Floor No.2 Wire and Instrument Panel Wire (Right Kick Panel)
BO1	44	Rear Door Wire LH and Floor Wire (Under the Left Center Pillar)
BP1	44	Rear Door Wire RH and Floor No.2 Wire (Under the Right Center Pillar)

 : GROUND POINTS

Code	See Page	Ground Points Location
IE	40	Cowl Side Panel LH
IG	40	Instrument Panel Brace LH
IJ	40	Right Kick Panel
IK		
BL	44	Under the Left Center Pillar
BN	44	Under the Right Center Pillar

 : SPLICE POINTS

Code	See Page	Wire Harness with Splice Points	Code	See Page	Wire Harness with Splice Points
B6	44	Floor No.2 Wire			

D12



D13



D16

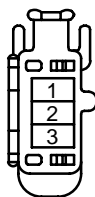

D17

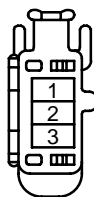

D18



D19
BLACK

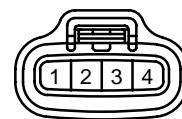

D20
BLACK



D21
BLACK

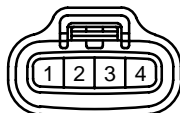

D22
BLACK

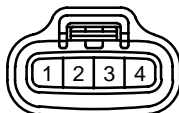

I18 (A)
(w/o Theft Deterrent System) ORANGE

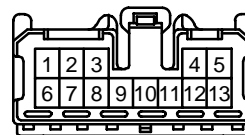

I18 (B)

(w/ Theft Deterrent System) ORANGE

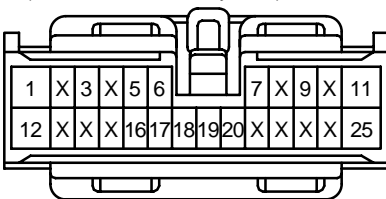

J6

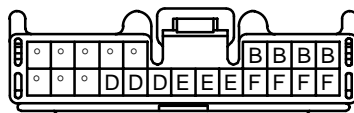

(Hint : See Page 7)

J9 (A)
BLACK

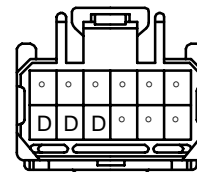

(Hint : See Page 7)

J10 (B)
BLACK

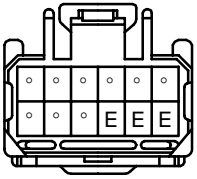

(Hint : See Page 7)

J11

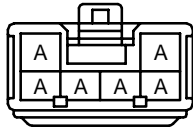

(Hint : See Page 7)

J30 (A)
GRAY

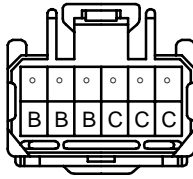

(Hint : See Page 7)

J31 (B)
GRAY

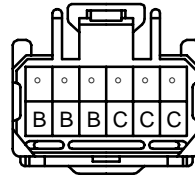

(Hint : See Page 7)

J33 (A)
BLACK

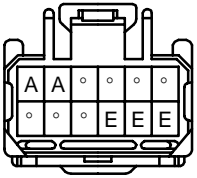

(Hint : See Page 7)

J34 (B)
BLACK

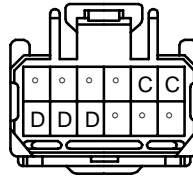

(Hint : See Page 7)

J37

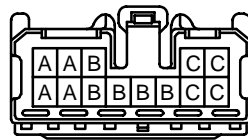

(Hint : See Page 7)

J38

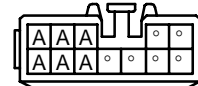

(Hint : See Page 7)

J39



(Hint : See Page 7)

J40

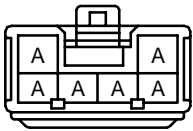

(Hint : See Page 7)

P9

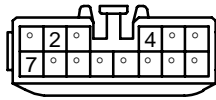

U1

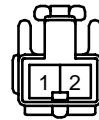

DOOR LOCK CONTROL (TMMK MADE)

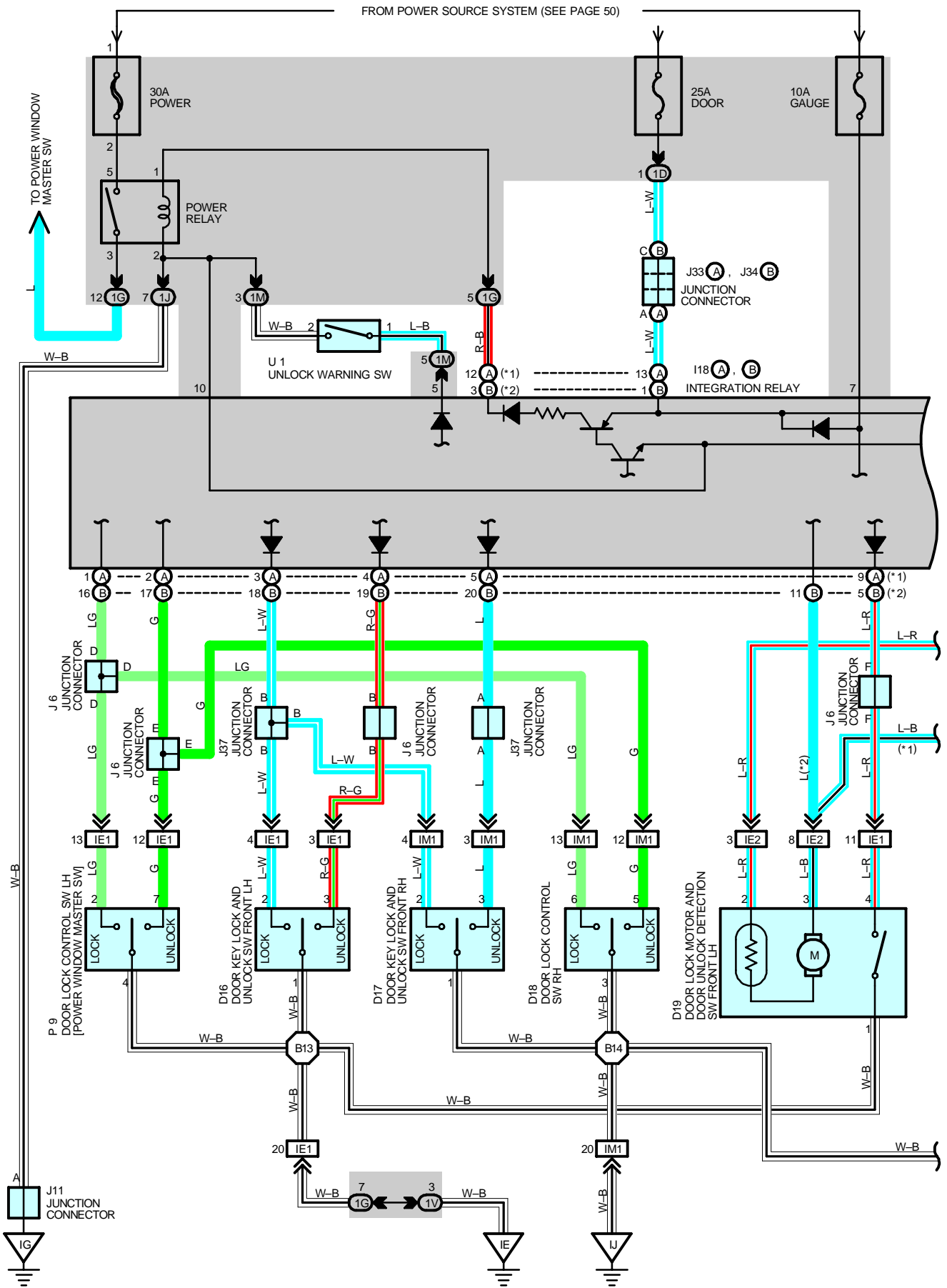

* 1 : W/O THEFT DETERRENT SYSTEM
 * 2 : W/ THEFT DETERRENT SYSTEM

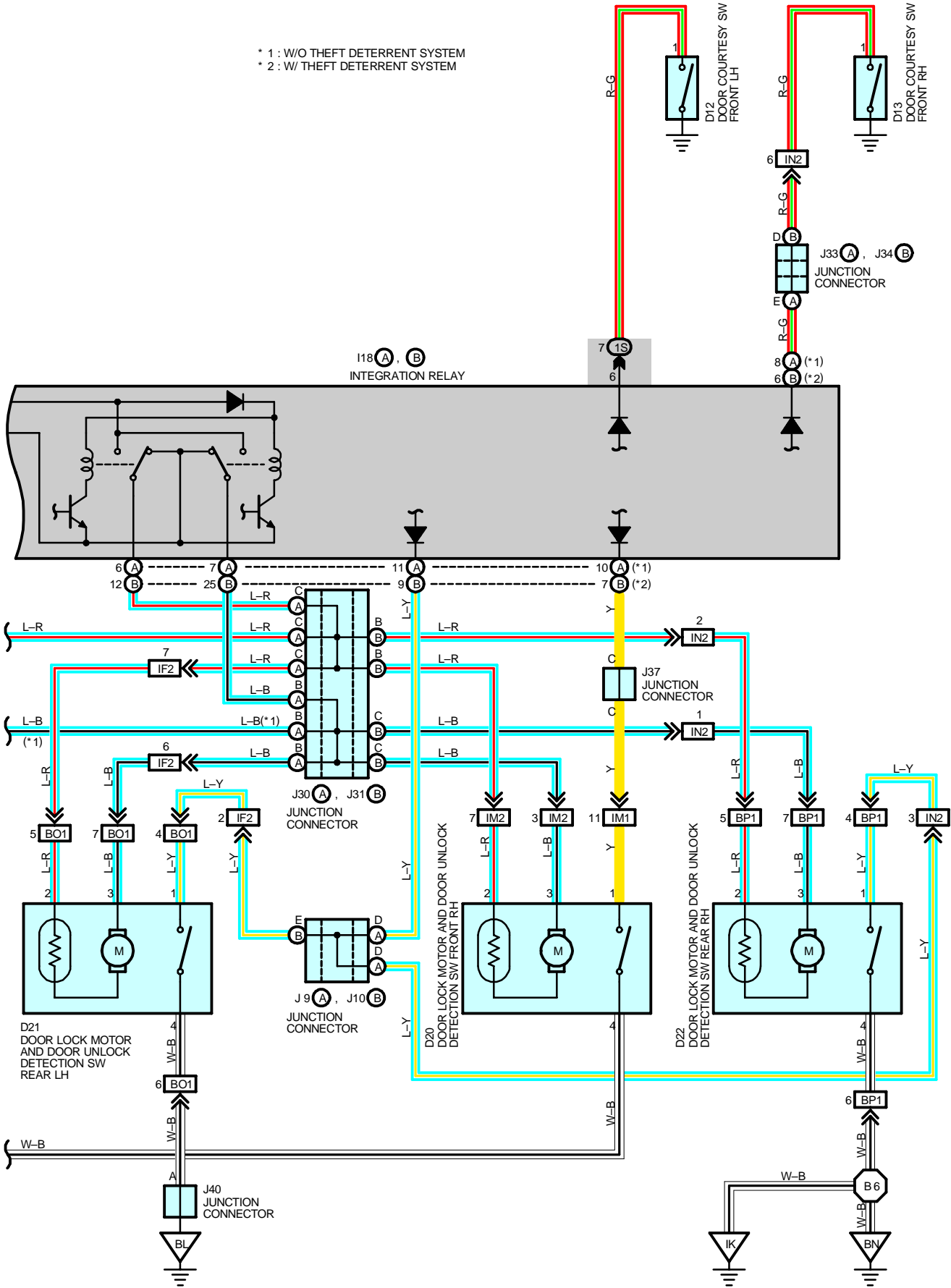

DOOR LOCK CONTROL (TMMK MADE)

SYSTEM OUTLINE

Current always flows to TERMINAL (A) 13 (w/o theft deterrent system), (B) 1 (w/ theft deterrent system) of the integration relay through the DOOR fuse.

When the ignition SW is turned on, the current flowing through the GAUGE Fuse flows to TERMINAL 7 of the integration relay to TERMINAL (A) 12 (w/o theft deterrent system), (B) 3 (w/ theft deterrent system) to the power relay (Coil side) to GROUND.

1. MANUAL LOCK OPERATION

When the door lock control SW or door key lock and unlock SW are operated to LOCK position, a lock signal is input to TERMINAL (A) 1 or (A) 3 (w/o theft deterrent system), (B) 16 or (B) 18 (w/ theft deterrent system) of the integration relay and causes the relay to function. Current flows from TERMINAL (A) 13 (w/o theft deterrent system), (B) 1 (w/ theft deterrent system) of the relay to (A) 6 (w/o theft deterrent system), (B) 12 (w/ theft deterrent system) to TERMINAL 2 of the door lock motors to TERMINAL 3 to TERMINAL (A) 7 (w/o theft deterrent system), (B) 11 and (B) 25 (w/ theft deterrent system) of the relay to TERMINAL 10 to GROUND and the door lock motor causes the door to lock.

2. MANUAL UNLOCK OPERATION

When the door lock control SW or door key lock and unlock SW are operated to UNLOCK position, an unlock signal is input to TERMINAL (A) 2, (A) 4 or (A) 5 (w/o theft deterrent system), (B) 17, (B) 19 or (B) 20 (w/ theft deterrent system) of the integration relay and causes the relay to function. Current flows from TERMINAL (A) 13 (w/o theft deterrent system), (B) 1 (w/ theft deterrent system) of the relay to TERMINAL (A) 7 (w/o theft deterrent system), (B) 11 and (B) 25 (w/ theft deterrent system) to TERMINAL 3 of the door lock motors to TERMINAL 2 to TERMINAL (A) 6 (w/o theft deterrent system), (B) 12 (w/ theft deterrent system) of the relay to TERMINAL 10 to GROUND and door lock motors causes door to unlock.

3. DOUBLE OPERATION UNLOCK OPERATION

When the door key lock and unlock SW front LH is turned to the unlock side, only the driver's door is mechanically unlocked. Turning the door key lock and unlock SW front LH to the unlock side causes a signal to be input to TERMINAL (A) 4 (w/o theft deterrent system), (B) 19 (w/ theft deterrent system) of the relay, and if the signal is input again within 3 seconds by turning the SW to the unlock side again, current flows from TERMINAL (A) 7 (w/o theft deterrent system), (B) 11 and (B) 25 (w/ theft deterrent system) of the integration relay to TERMINAL 3 of the door lock motors to TERMINAL 2 of the door lock motors to TERMINAL (A) 6 (w/o theft deterrent system), (B) 12 (w/ theft deterrent system) of the relay to TERMINAL 10 to GROUND, causing the door lock motors to operate and unlock the doors.

4. IGNITION KEY REMINDER OPERATION

* Operating door lock knob (Operation of door lock motors)

With ignition key in cylinder (Unlock warning SW on), when the door is opened and locked using door lock knob (Door lock motor), the door is locked once but each door is unlocked soon by the function of the relay. As a result, the current flows from TERMINAL (A) 13 (w/o theft deterrent system), (B) 1 (w/ theft deterrent system) of the integration relay to TERMINAL (A) 7 (w/o theft deterrent system), (B) 11 and (B) 25 (w/ theft deterrent system) to TERMINAL 3 of the door lock motors to TERMINAL 2 of the door lock motors to TERMINAL (A) 6 (w/o theft deterrent system), (B) 12 (w/ theft deterrent system) of the relay to TERMINAL 10 to GROUND and causes all the doors to unlock.

* Operating door lock control SW or door key lock and unlock SW

With ignition key in cylinder (Unlock warning SW on), when the door is opened and locked using door lock control SW or key SW, the door is locked once but each door is unlock by the function of SW contained in motors, which the signal is input to TERMINAL (A) 9 or (A) 10 (w/o theft deterrent system), (B) 5 or (B) 7 (w/ theft deterrent system) of the relay. According to this input signal, the current in ECU flows from TERMINAL (A) 13 (w/o theft deterrent system), (B) 1 (w/ theft deterrent system) of the relay to TERMINAL (A) 7 (w/o theft deterrent system), (B) 11 and (B) 25 (w/ theft deterrent system) to TERMINAL 3 of the door lock motors to TERMINAL 2 of the door lock motors to TERMINAL (A) 6 (w/o theft deterrent system), (B) 12 (w/ theft deterrent system) of the relay to TERMINAL 10 to GROUND and causes all the doors to unlock.

* In case of key less lock

With ignition key in cylinder (Unlock warning SW on), when the unlock function is disturbed more than 0.2 seconds, for example pushing the door lock knob etc., the door holds on lock condition. Closing the door after, door courtesy SW inputs the signal into TERMINAL 6 or (A) 8 (w/o theft deterrent system), (B) 6 (w/ theft deterrent system) of the integration relay. By this input signal, the ECU works and current flows from TERMINAL (A) 13 (w/o theft deterrent system), (B) 1 (w/ theft deterrent system) of the relay to TERMINAL (A) 7 (w/o theft deterrent system), (B) 11 and (B) 25 (w/ theft deterrent system) to TERMINAL 3 of the door lock motors to TERMINAL 2 of the door lock motors to TERMINAL (A) 6 (w/o theft deterrent system), (B) 12 (w/ theft deterrent system) of the relay to TERMINAL 10 to GROUND and causes all the doors to unlock.

SERVICE HINTS

I18 (A), (B) INTEGRATION RELAY

10-GROUND : Always continuity

6-GROUND : Continuity with driver's door open

7-GROUND : Approx. **12** volts with ignition SW at **ON** position

(A)13 or (B) 1-GROUND: Always approx. **12** volts

(A) 6 or (B)12-GROUND: Approx. **12** volts **0.2** seconds with following operation

* Door lock control SW locked

* Locking driver's, front passenger's door cylinder with key

(A) 1 or (B)16-GROUND: Continuity with door lock control SW locked

(A) 8 or (B) 6-GROUND : Continuity with front passenger's door open

(A) 9 or (B) 5-GROUND : Continuity with driver's door lock knob unlocked

(A)10 or (B) 7-GROUND: Continuity with front passenger's door lock knob unlock

(A) 2 or (B)17-GROUND: Continuity with door lock control SW unlocked

(A) 5 or (B)20-GROUND: Continuity with front passenger's door lock cylinder unlocked with key

(A) 4 or (B)19-GROUND: Continuity with driver's door lock cylinder unlocked with key

(A) 3 or (B)18-GROUND: Continuity with driver's, front passenger's door lock cylinder locked with key

(A) 7 or (B)11, (B)25-GROUND : Approx. **12** volts **0.2** seconds with following operation

* Door lock control SW unlocked

* Door lock control SW locked with ignition key in cylinder and driver's door open
(Ignition key reminder function)

* Door lock knob locked with ignition key in cylinder and driver's door open
(Ignition key reminder function)

* Unlocking driver's, front passenger's door cylinder with key

D12, D13 DOOR COURTESY SW FRONT LH,RH

1-GROUND : Closed with each door open

D16, D17 DOOR KEY LOCK AND UNLOCK SW FRONT LH,RH

1-2 : Closed with door lock cylinder locked with key

1-3 : Closed with door lock cylinder unlocked with key

D19, D20 DOOR LOCK MOTOR AND DOOR UNLOCK DETECTION SW FRONT LH,RH

1-4 : Closed with door lock knob **UNLOCK** position

U1 UNLOCK WARNING SW

1-2 : Closed with ignition key in cylinder

○ : PARTS LOCATION

Code	See Page	Code	See Page	Code	See Page
D12	32	D22	32	J31 B	31
D13	32	I18	A	J33 A	31
D16	32		B	J34 B	31
D17	32	J6	31	J37	31
D18	32	J9 A	31	J40	32
D19	32	J10 B	31	P9	33
D20	32	J11	31	U1	31
D21	32	J30 A	31		

○ : JUNCTION BLOCK AND WIRE HARNESS CONNECTOR

Code	See Page	Junction Block and Wire Harness (Connector Location)
1D	20	Instrument Panel Wire and Instrument Panel J/B (Lower Finish Panel)
1G		
1J	20	Cowl Wire and Instrument Panel J/B (Lower Finish Panel)
1M		
1S	20	Floor Wire and Instrument Panel J/B (Lower Finish Panel)
1V	20	Cowl Wire and Instrument Panel J/B (Lower Finish Panel)

DOOR LOCK CONTROL (TMMK MADE)

□ : CONNECTOR JOINING WIRE HARNESS AND WIRE HARNESS

Code	See Page	Joining Wire Harness and Wire Harness (Connector Location)
IE1	40	Front Door LH Wire and Instrument Panel Wire (Left Kick Panel)
IE2		
IF2	40	Floor Wire and Instrument Panel Wire (Left Kick Panel)
IM1	42	Front Door RH Wire and Instrument Panel Wire (Right Kick Panel)
IM2		
IN2	42	Floor No.2 Wire and Instrument Panel Wire (Right Kick Panel)
BO1	44	Rear Door Wire LH and Floor Wire (Under the Left Center Pillar)
BP1	44	Rear Door Wire RH and Floor No.2 Wire (Under the Right Center Pillar)

▽ : GROUND POINTS

Code	See Page	Ground Points Location
IE	40	Cowl Side Panel LH
IG	40	Instrument Panel Brace LH
IJ	40	Right Kick Panel
IK		
BL	44	Under the Left Center Pillar
BN	44	Under the Right Center Pillar

○ : SPLICE POINTS

Code	See Page	Wire Harness with Splice Points	Code	See Page	Wire Harness with Splice Points
B6	44	Floor No.2 Wire	B14	44	Front Door RH Wire
B13	44	Front Door LH Wire			

D12



D13



D16

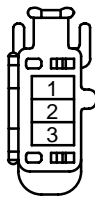

D17

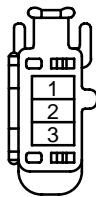

**D18
BLACK**

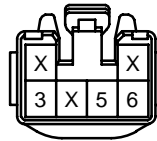

**D19
BLACK**

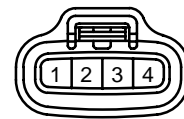

**D20
BLACK**



**D21
BLACK**



**D22
BLACK**

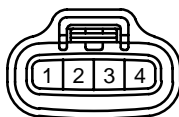

**I18 (A)
(w/o Theft Deterrent System) ORANGE**

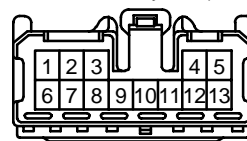

**I18 (B)
(w/ Theft Deterrent System) ORANGE**

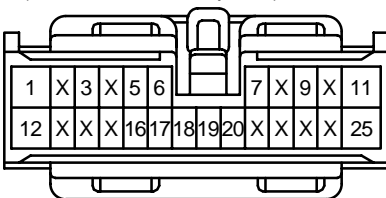

J6

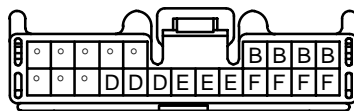

(Hint : See Page 7)

**J9 (A)
BLACK**

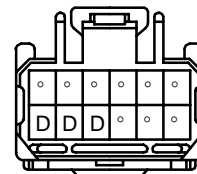

(Hint : See Page 7)

J10 (B)
BLACK

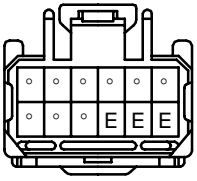

(Hint : See Page 7)

J11

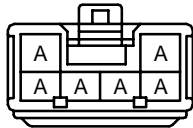

(Hint : See Page 7)

J30 (A)
GRAY

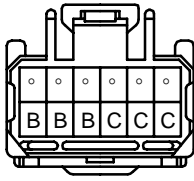

(Hint : See Page 7)

J31 (B)
GRAY

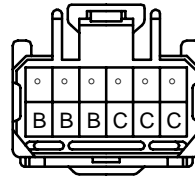

(Hint : See Page 7)

J33 (A)
BLACK

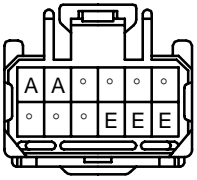

(Hint : See Page 7)

J34 (B)
BLACK

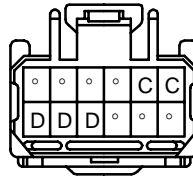

(Hint : See Page 7)

J37

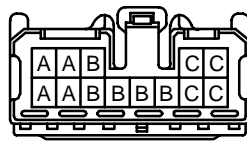

(Hint : See Page 7)

J40

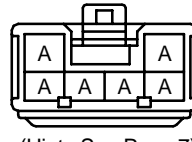

(Hint : See Page 7)

P9

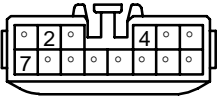

U1



WIRELESS DOOR LOCK CONTROL (TMC MADE)

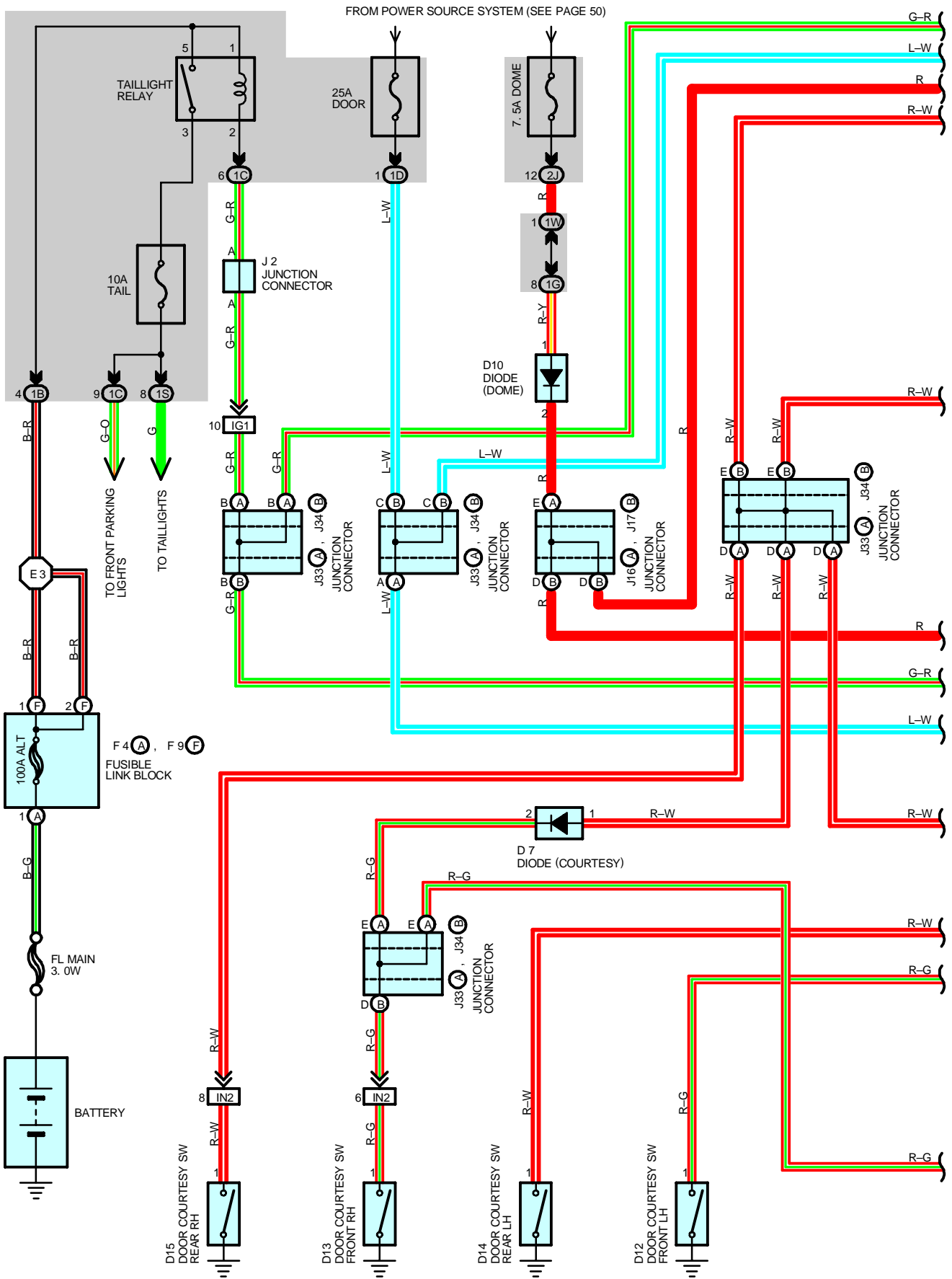

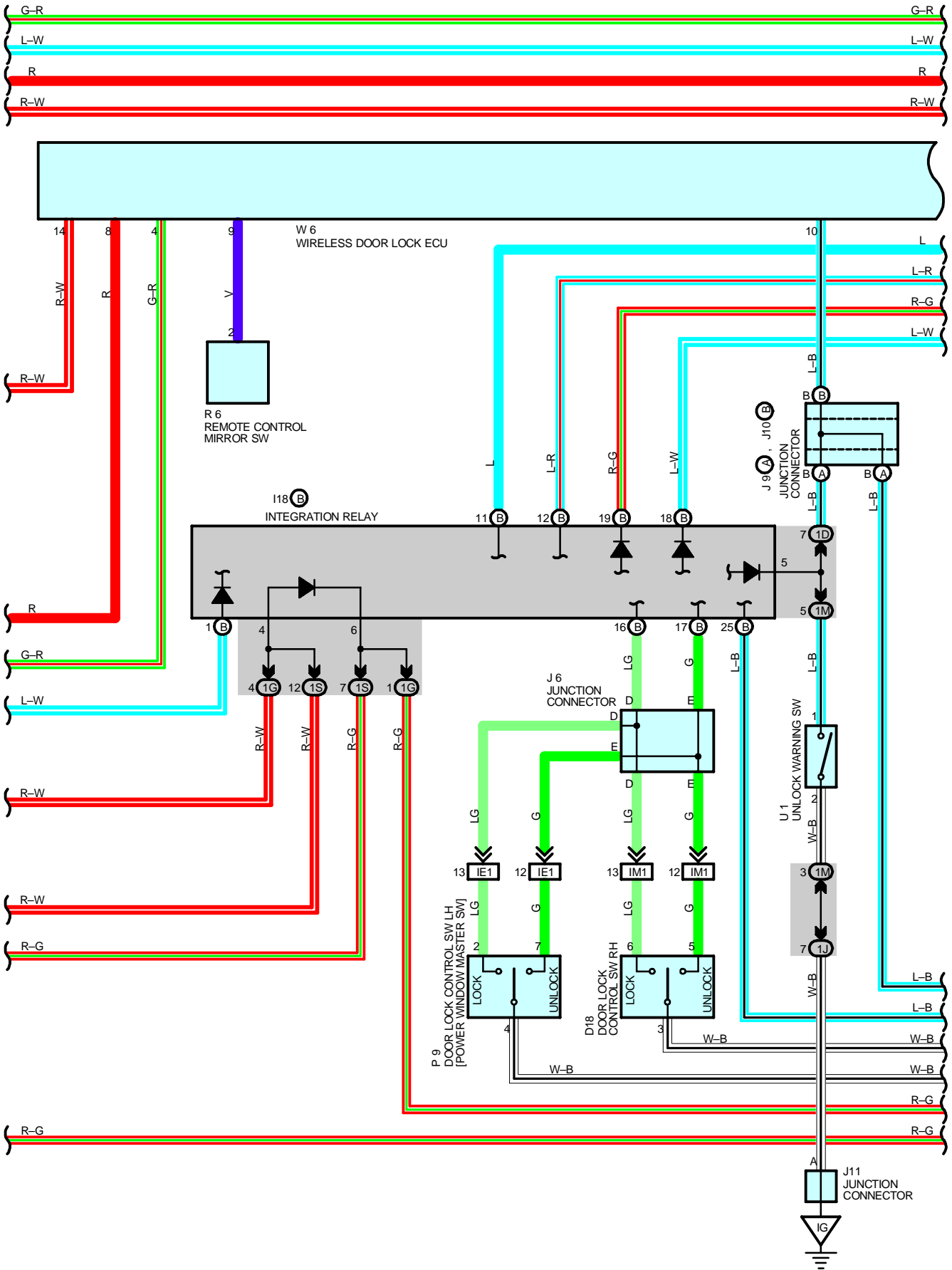

WIRELESS DOOR LOCK CONTROL (TMC MADE)

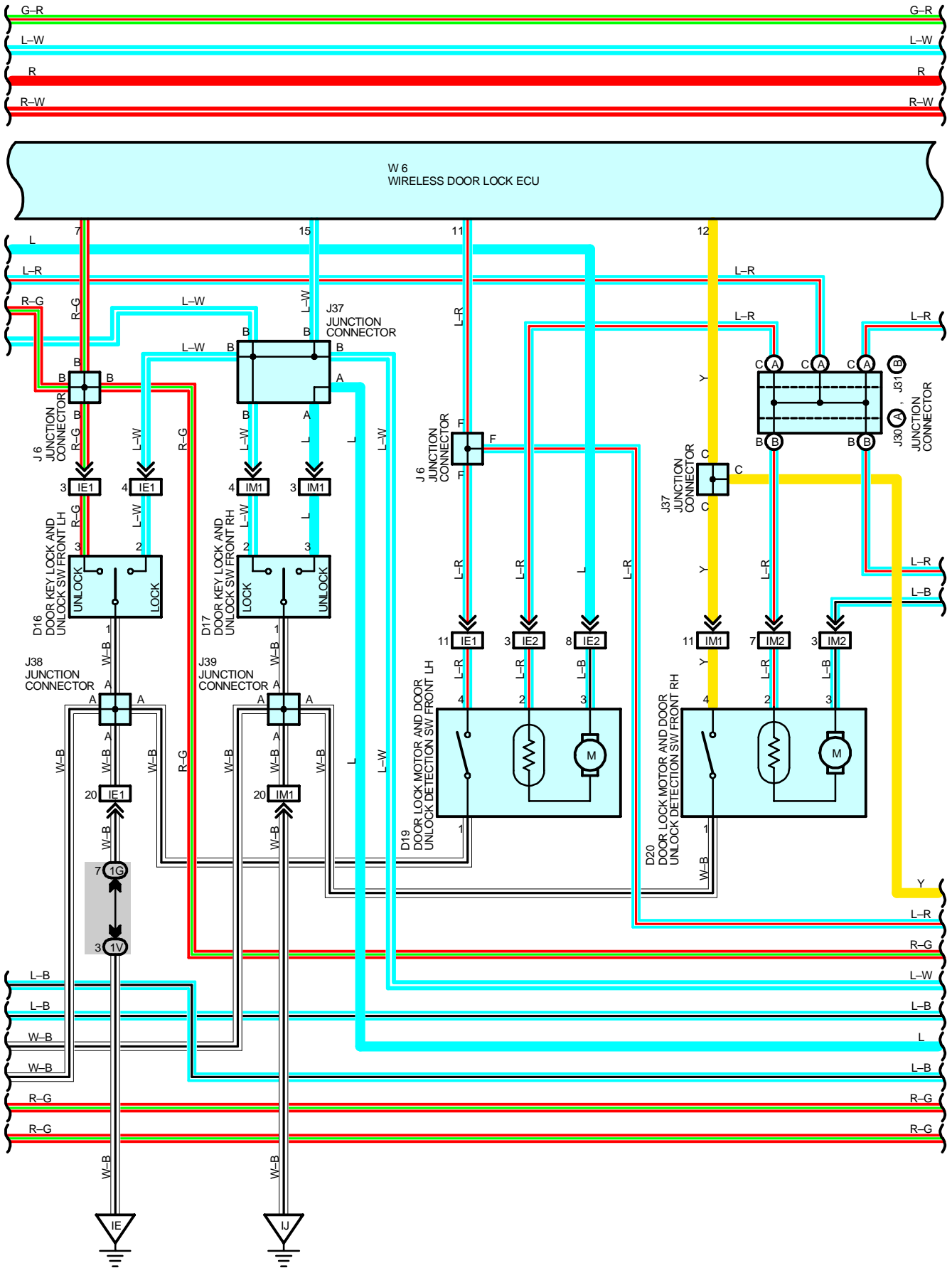

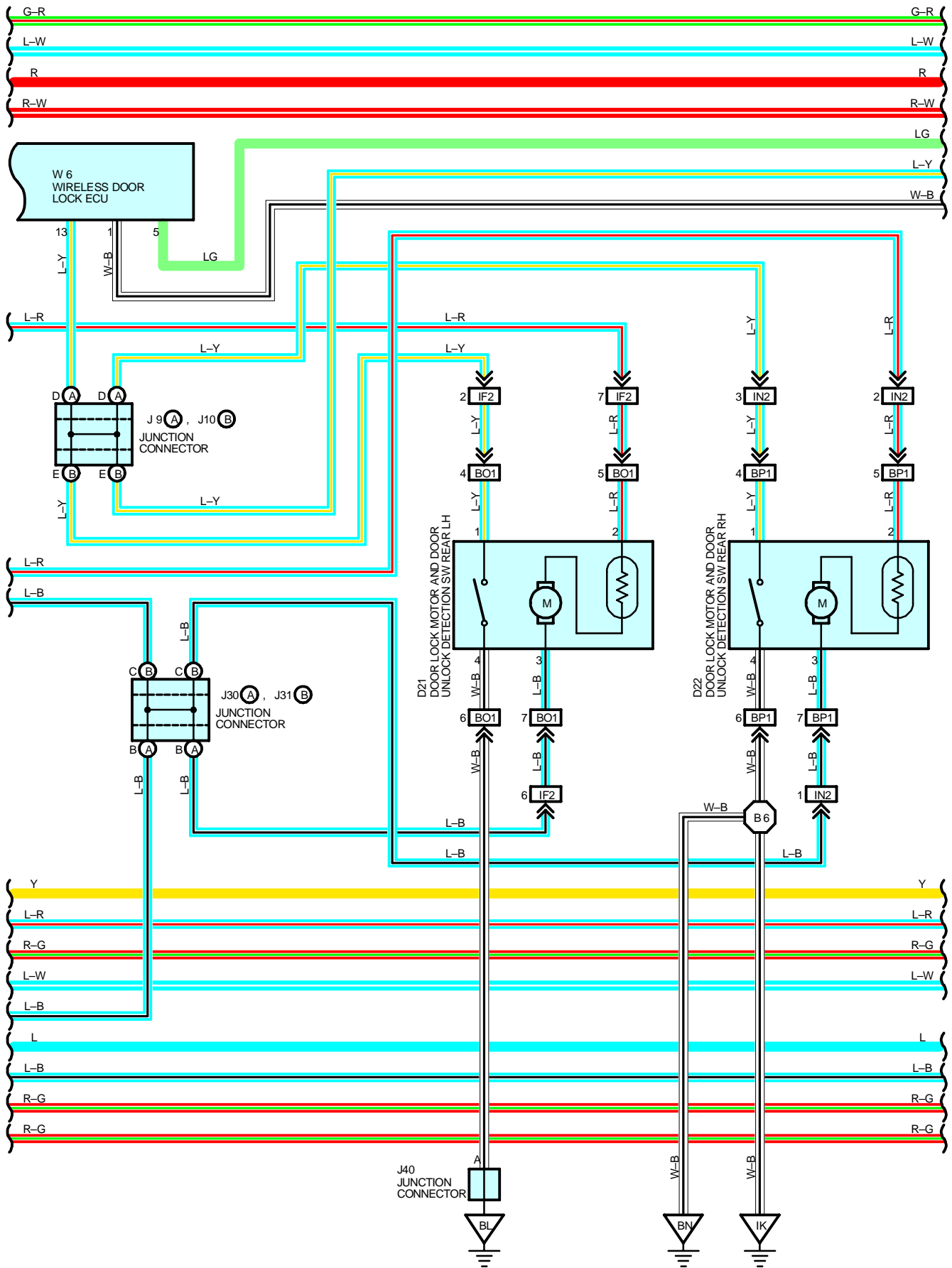

WIRELESS DOOR LOCK CONTROL (TMC MADE)

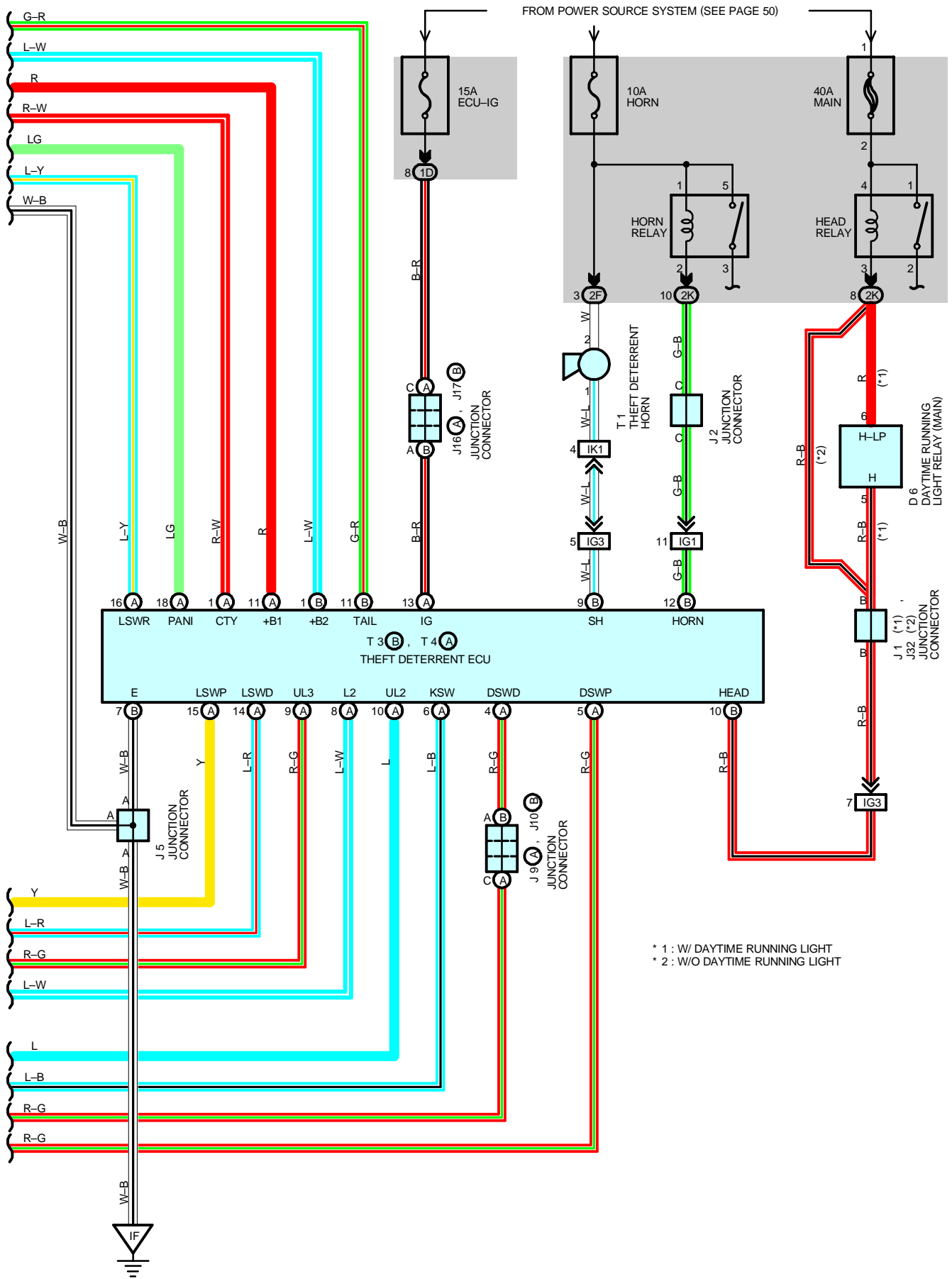

SYSTEM OUTLINE

Door lock control (Lock and unlock) and panic control (Theft alarm and flash) is performed by remote control, without the ignition key inserted in the door key cylinder, using low-power electrical waves emitted by a transmitter.

1. WIRELESS DOOR LOCK OR UNLOCK NORMAL OPERATION

With the ignition key not inserted into the ignition key cylinder (Unlock warning SW off) and all the doors completely closed, when the lock or unlock button (Transmitter) is pushed, the wireless door lock ECU receives the electrical waves from the transmitter, causing it to operate.

As a result, the ECU judges whether the door is locked or unlocked based on the signal from the door lock motor and door unlock detection SW, and sends a signal to the theft deterrent ECU and integration relay to switch the condition from lock to unlock or vice versa, causing the door lock motor to operate.

2. VISUAL CONFIRMATION OF LOCK OR UNLOCK

If all doors indicate that they are locked after the lock command, parking lights and taillight will flash once. If any door indicates that it is open after the unlock command, parking lights and taillights will flash twice.

3. WIRELESS DOOR UNLOCK OPERATION

Pushing the unlock button (Transmitter) once, driver's door is unlocked. Furthermore, pushing the button again within 3 seconds, the other doors are unlocked.

4. AUTOMATIC LOCK OPERATION

With the ignition key not inserted into the ignition key cylinder (Unlock warning SW off) and all the doors completely closed, after pushing the button (Transmitter) to unlock all the doors, if a door is not opened within 30 seconds, all the doors will be automatically relocked.

5. WIRELESS CONTROL STOP FUNCTION

If a door is open (Door courtesy SW on), a signal is input from the door courtesy SW to the wireless door lock ECU, stopping wireless door lock or unlock.

If the ignition key is in the ignition key cylinder (Unlock warning SW on), the unlock warning SW inputs a signal to the wireless door lock ECU, stopping wireless door lock or unlock.

6. DOOR LOCK MOTOR PROTECTIVE FUNCTION

If the door lock or unlock condition does not change after wireless door lock or unlock operation, 2 seconds later, the integration relay ECU sends current three times to the door lock motor. If the door lock condition still has not changed as a result, the wireless door lock ECU stops reception and stops door lock and unlock function.

7. REMOTE PANIC OPERATION

Panic will function when doors are locked or unlocked, open or closed. When the panic button (Transmitter) is pushed once, theft alarm sounds and headlights and taillight flash. Then, the panic or the unlock button (Transmitter) is pushed once more, sounding and flashing will stop. Panic will not function when ignition key is in ignition key cylinder.

SERVICE HINTS

D12, D13, D14, D15 DOOR COURTESY SW FRONT LH, RH, REAR LH, RH

1-GROUND : Continuity with the door open

U1 UNLOCK WARNING SW

2-1 : Continuity with the ignition key in the cylinder

W6 WIRELESS DOOR LOCK ECU

8-GROUND : Always approx. 12 volts

1-GROUND : Always continuity

14-GROUND : Continuity with each of the door open

10-GROUND : Continuity with the ignition key in the cylinder

WIRELESS DOOR LOCK CONTROL (TMC MADE)

○ : PARTS LOCATION

Code	See Page	Code	See Page	Code	See Page		
D6	30	F4	A	28 (5S-FE)	J32	31	
D7	30	F9	F	26 (1MZ-FE)	J33	A	31
D10	30			28 (5S-FE)	J34	B	31
D12	32	I18	B	30	J37	31	
D13	32	J1		31	J38	32	
D14	32	J2		31	J39	32	
D15	32	J5		31	J40	32	
D16	32	J6		31	P9	33	
D17	32	J9	A	31	R6	31	
D18	32	J10	B	31	T1	27 (1MZ-FE)	
D19	32	J11		31		29 (5S-FE)	
D20	32	J16	A	31	T3	B	31
D21	32	J17	B	31	T4	A	31
D22	32	J30	A	31	U1		31
F4	A	26 (1MZ-FE)	J31	B	31	W6	31

○ : JUNCTION BLOCK AND WIRE HARNESS CONNECTOR

Code	See Page	Junction Block and Wire Harness (Connector Location)
1B	20	Cowl Wire and Instrument Panel J/B (Lower Finish Panel)
1C		
1D	20	Instrument Panel Wire and Instrument Panel J/B (Lower Finish Panel)
1G		
1J	20	Cowl Wire and Instrument Panel J/B (Lower Finish Panel)
1M		
1S	20	Floor Wire and Instrument Panel J/B (Lower Finish Panel)
1V	20	Cowl Wire and Instrument Panel J/B (Lower Finish Panel)
1W		
2F	22	Engine Room Main Wire and Engine Room J/B No.2 (Engine Compartment Left)
2J	22	Cowl Wire and Engine Room J/B No.2 (Engine Compartment Left)
2K		

□ : CONNECTOR JOINING WIRE HARNESS AND WIRE HARNESS

Code	See Page	Joining Wire Harness and Wire Harness (Connector Location)
IE1	40	Front Door LH Wire and Instrument Panel Wire (Left Kick Panel)
IE2		
IF2	40	Floor Wire and Instrument Panel Wire (Left Kick Panel)
IG1	40	Instrument Panel Wire and Cowl Wire (Lower Finish Panel)
IG3	40	Instrument Panel Wire and Cowl Wire (Under the Blower Motor)
IK1	42	Engine Room Main Wire and Cowl Wire (Right Kick Panel)
IM1	42	Front Door RH Wire and Instrument Panel Wire (Right Kick Panel)
IM2		
IN2	42	Floor No.2 Wire and Instrument Panel Wire (Right Kick Panel)
BO1	44	Rear Door Wire LH and Floor Wire (Under the Left Center Pillar)
BP1	44	Rear Door Wire RH and Floor No.2 Wire (Under the Right Center Pillar)



: GROUND POINTS

Code	See Page	Ground Points Location
IE	40	Cowl Side Panel LH
IF	40	Left Kick Panel
IG	40	Instrument Panel Brace LH
IJ	40	Right Kick Panel
IK		
BL	44	Under the Left Center Pillar
BN	44	Under the Right Center Pillar



: SPLICE POINTS

Code	See Page	Wire Harness with Splice Points	Code	See Page	Wire Harness with Splice Points
E3	36 (1MZ-FE)	Cowl Wire	B6	44	Floor No.2 Wire
	38 (5S-FE)				

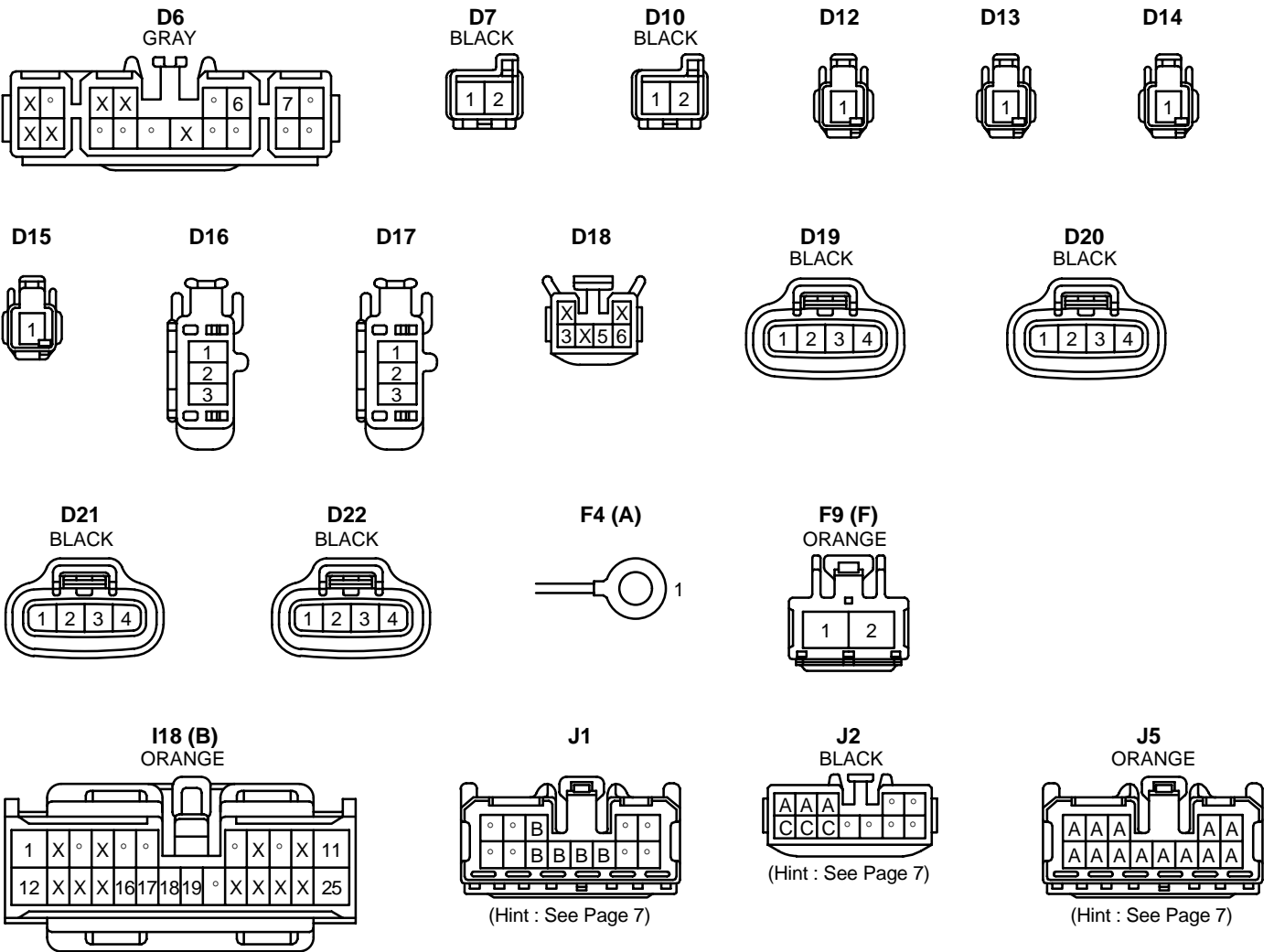

WIRELESS DOOR LOCK CONTROL (TMC MADE)

J6

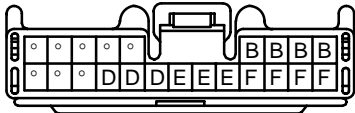

(Hint : See Page 7)

J9 (A)
BLACK

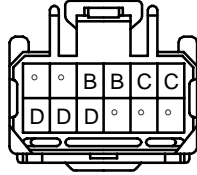

(Hint : See Page 7)

J10 (B)
BLACK

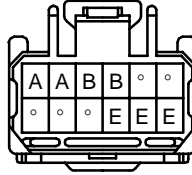

(Hint : See Page 7)

J11

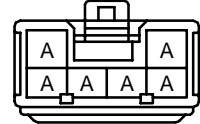

(Hint : See Page 7)

J16 (A)
BLACK

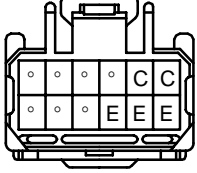

(Hint : See Page 7)

J17 (B)
BLACK

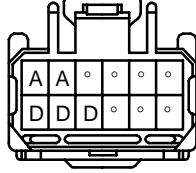

(Hint : See Page 7)

J30 (A)
GRAY

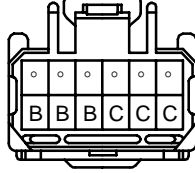

(Hint : See Page 7)

J31 (B)
GRAY

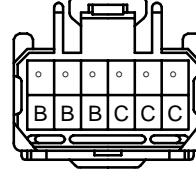

(Hint : See Page 7)

J32
GRAY



(Hint : See Page 7)

J33 (A)
BLACK

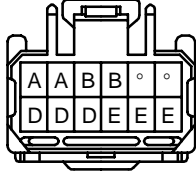

(Hint : See Page 7)

J34 (B)
BLACK

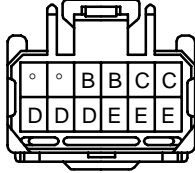

(Hint : See Page 7)

J37

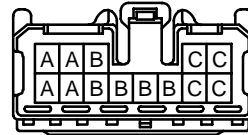

(Hint : See Page 7)

J38



(Hint : See Page 7)

J39



(Hint : See Page 7)

J40

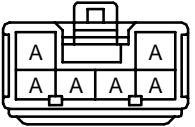

(Hint : See Page 7)

P9

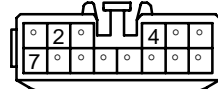

R6

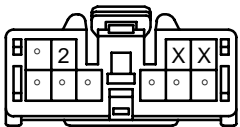

T1
BLACK



T3 (B)

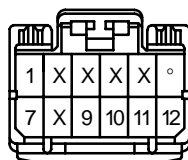

T4 (A)

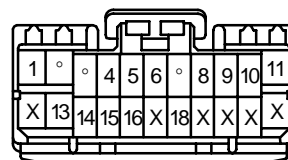

U1



W6
BLUE

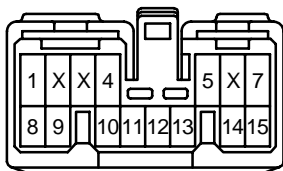

WIRELESS DOOR LOCK CONTROL (TMMK MADE)

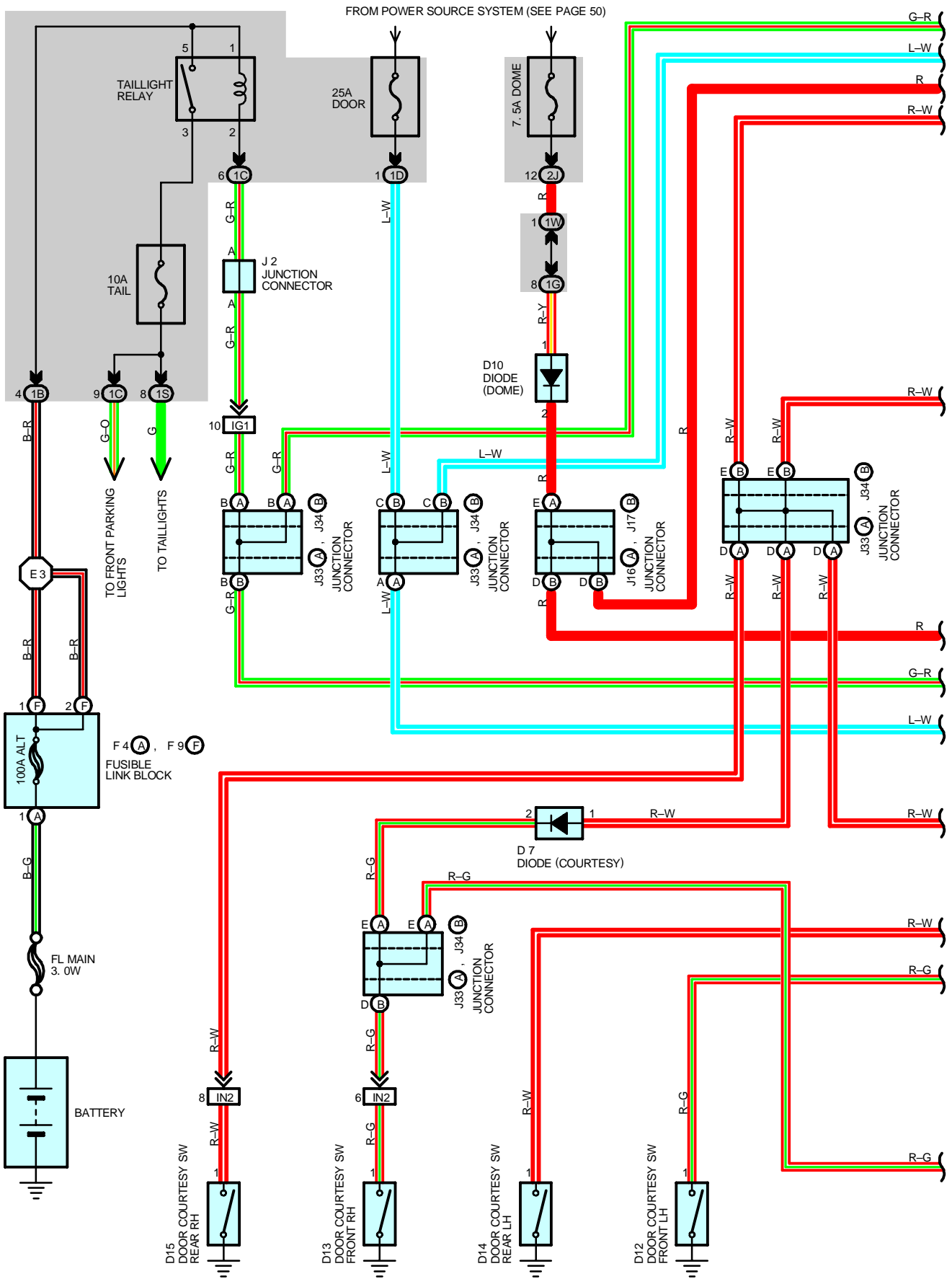

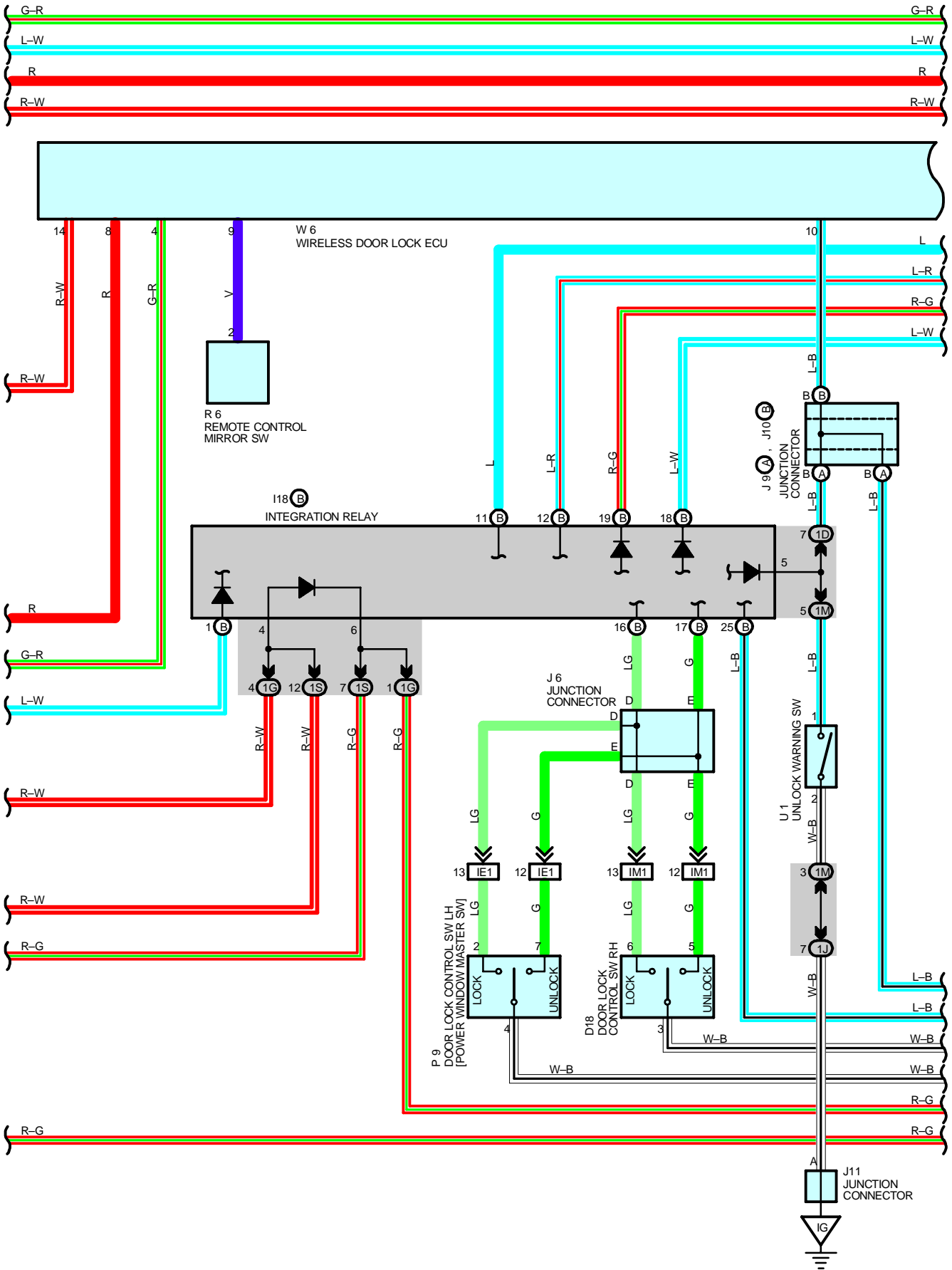

WIRELESS DOOR LOCK CONTROL (TMMK MADE)

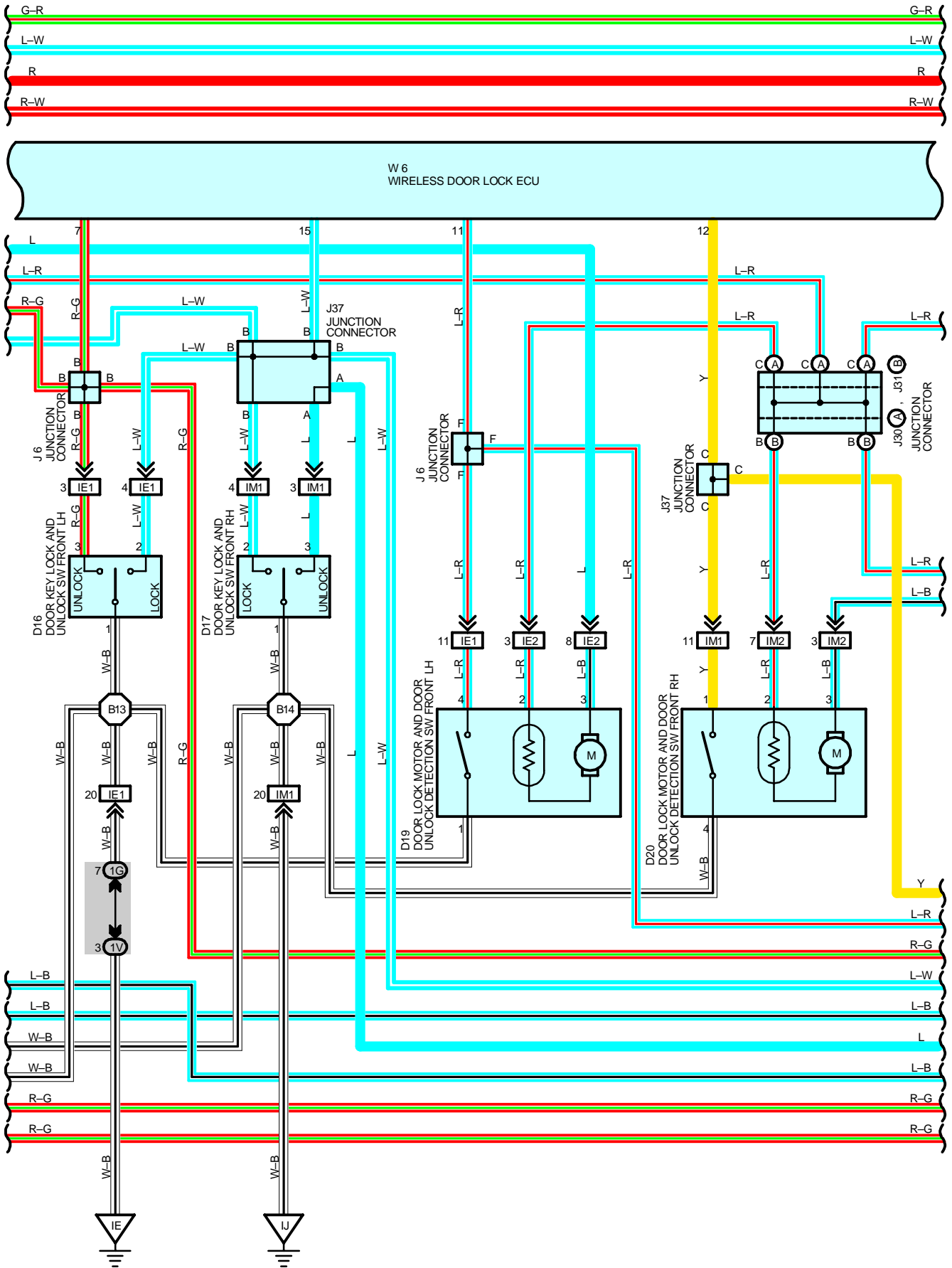

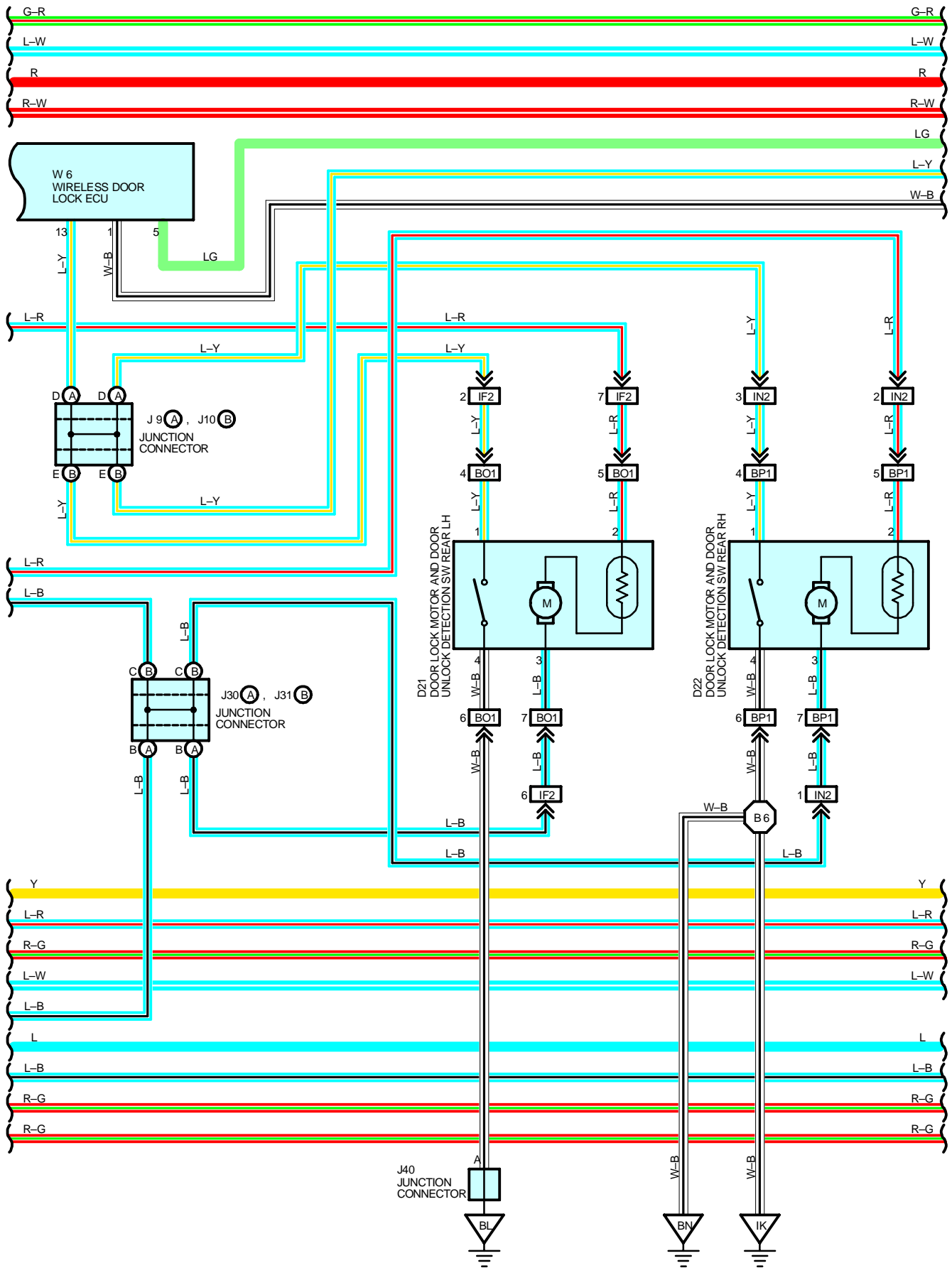

WIRELESS DOOR LOCK CONTROL (TMMK MADE)

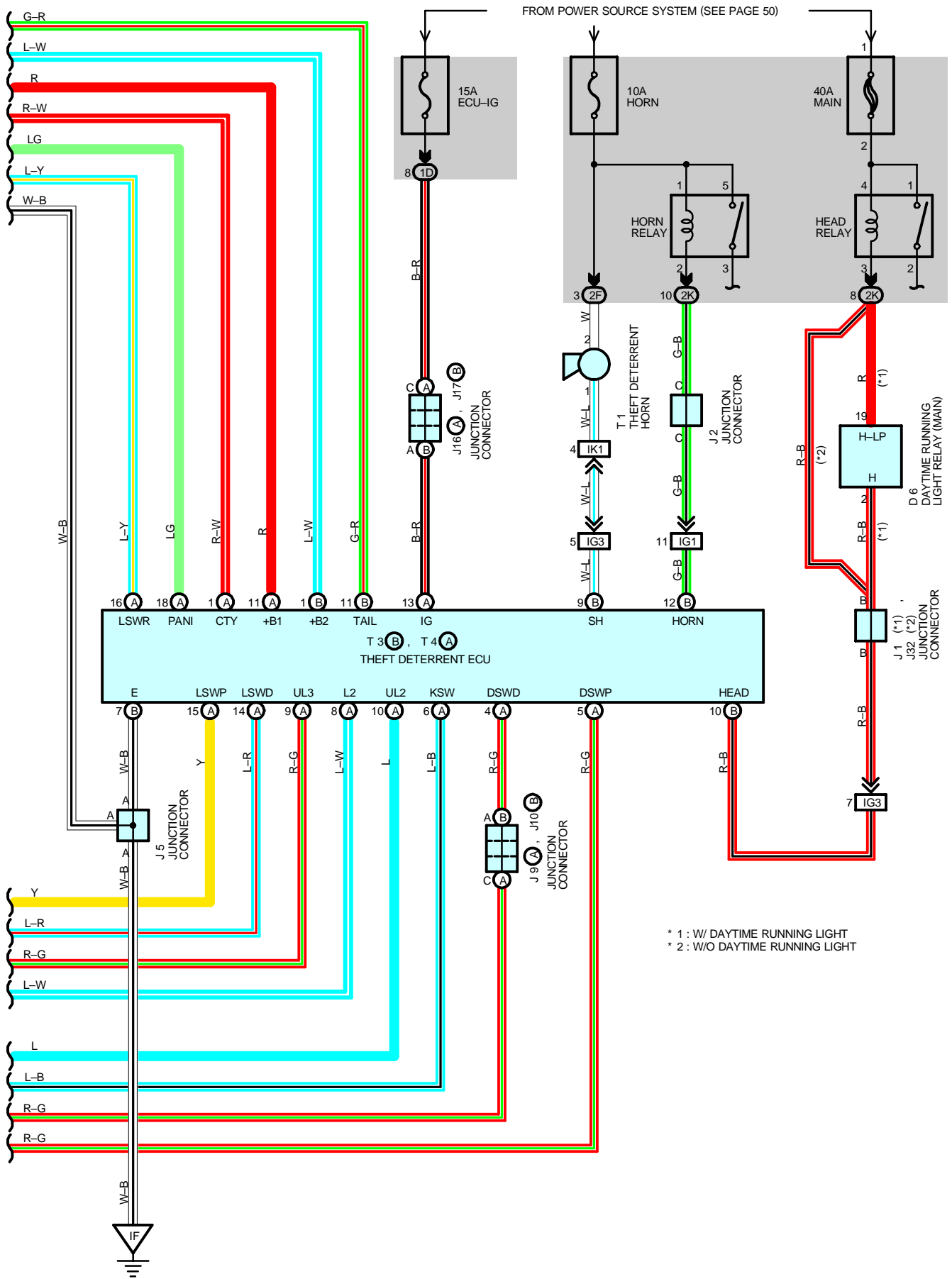

* 1 : W/ DAYTIME RUNNING LIGHT
 * 2 : W/O DAYTIME RUNNING LIGHT

SYSTEM OUTLINE

Door lock control (Lock and unlock) and panic control (Theft alarm and flash) is performed by remote control, without the ignition key inserted in the door key cylinder, using low-power electrical waves emitted by a transmitter.

1. WIRELESS DOOR LOCK OR UNLOCK NORMAL OPERATION

With the ignition key not inserted into the ignition key cylinder (Unlock warning SW off) and all the doors completely closed, when the lock or unlock button (Transmitter) is pushed, the wireless door lock ECU receives the electrical waves from the transmitter, causing it to operate.

As a result, the ECU judges whether the door is locked or unlocked based on the signal from the door lock motor and door unlock detection SW, and sends a signal to the theft deterrent ECU and integration relay to switch the condition from lock to unlock or vice versa, causing the door lock motor to operate.

2. VISUAL CONFIRMATION OF LOCK OR UNLOCK

If all doors indicate that they are locked after the lock command, parking lights and taillight will flash once. If any door indicates that it is open after the unlock command, parking lights and taillights will flash twice.

3. WIRELESS DOOR UNLOCK OPERATION

Pushing the unlock button (Transmitter) once, driver's door is unlocked. Furthermore, pushing the button again within 3 seconds, the other doors are unlocked.

4. AUTOMATIC LOCK OPERATION

With the ignition key not inserted into the ignition key cylinder (Unlock warning SW off) and all the doors completely closed, after pushing the button (Transmitter) to unlock all the doors, if a door is not opened within 30 seconds, all the doors will be automatically relocked.

5. WIRELESS CONTROL STOP FUNCTION

If a door is open (Door courtesy SW on), a signal is input from the door courtesy SW to the wireless door lock ECU, stopping wireless door lock or unlock.

If the ignition key is in the ignition key cylinder (Unlock warning SW on), the unlock warning SW inputs a signal to the wireless door lock ECU, stopping wireless door lock or unlock.

6. DOOR LOCK MOTOR PROTECTIVE FUNCTION

If the door lock or unlock condition does not change after wireless door lock or unlock operation, 2 seconds later, the integration relay ECU sends current three times to the door lock motor. If the door lock condition still has not changed as a result, the wireless door lock ECU stops reception and stops door lock and unlock function.

7. REMOTE PANIC OPERATION

Panic will function when doors are locked or unlocked, open or closed. When the panic button (Transmitter) is pushed once, theft alarm sounds and headlights and taillight flash. Then, the panic or the unlock button (Transmitter) is pushed once more, sounding and flashing will stop. Panic will not function when ignition key is in ignition key cylinder.

SERVICE HINTS

D12, D13, D14, D15 DOOR COURTESY SW FRONT LH, RH, REAR LH, RH

1-GROUND : Continuity with the door open

U1 UNLOCK WARNING SW

2-1 : Continuity with the ignition key in the cylinder

W6 WIRELESS DOOR LOCK ECU

8-GROUND : Always approx. 12 volts

1-GROUND : Always continuity

14-GROUND : Continuity with each of the door open

10-GROUND : Continuity with the ignition key in the cylinder

WIRELESS DOOR LOCK CONTROL (TMMK MADE)

○ : PARTS LOCATION

Code	See Page	Code	See Page	Code	See Page		
D6	30	F4	A	28 (5S-FE)	J32	31	
D7	30	F9	F	26 (1MZ-FE)	J33	A	31
D10	30			28 (5S-FE)	J34	B	31
D12	32	I18	B	30	J37	31	
D13	32	J1		31	J40	32	
D14	32	J2		31	P9	33	
D15	32	J5		31	R6	31	
D16	32	J6		31	T1	27 (1MZ-FE)	
D17	32	J9	A	31		29 (5S-FE)	
D18	32	J10	B	31	T3	B	31
D19	32	J11		31	T4	A	31
D20	32	J16	A	31	U1		31
D21	32	J17	B	31	W6		31
D22	32	J30	A	31			
F4	A	26 (1MZ-FE)	J31	B	31		

○ : JUNCTION BLOCK AND WIRE HARNESS CONNECTOR

Code	See Page	Junction Block and Wire Harness (Connector Location)
1B	20	Cowl Wire and Instrument Panel J/B (Lower Finish Panel)
1C		
1D	20	Instrument Panel Wire and Instrument Panel J/B (Lower Finish Panel)
1G		
1J	20	Cowl Wire and Instrument Panel J/B (Lower Finish Panel)
1M		
1S	20	Floor Wire and Instrument Panel J/B (Lower Finish Panel)
1V	20	Cowl Wire and Instrument Panel J/B (Lower Finish Panel)
1W		
2F	22	Engine Room Main Wire and Engine Room J/B No.2 (Engine Compartment Left)
2J	22	Cowl Wire and Engine Room J/B No.2 (Engine Compartment Left)
2K		

□ : CONNECTOR JOINING WIRE HARNESS AND WIRE HARNESS

Code	See Page	Joining Wire Harness and Wire Harness (Connector Location)
IE1	40	Front Door LH Wire and Instrument Panel Wire (Left Kick Panel)
IE2		
IF2	40	Floor Wire and Instrument Panel Wire (Left Kick Panel)
IG1	40	Instrument Panel Wire and Cowl Wire (Lower Finish Panel)
IG3	40	Instrument Panel Wire and Cowl Wire (Under the Blower Motor)
IK1	42	Engine Room Main Wire and Cowl Wire (Right Kick Panel)
IM1	42	Front Door RH Wire and Instrument Panel Wire (Right Kick Panel)
IM2		
IN2	42	Floor No.2 Wire and Instrument Panel Wire (Right Kick Panel)
BO1	44	Rear Door Wire LH and Floor Wire (Under the Left Center Pillar)
BP1	44	Rear Door Wire RH and Floor No.2 Wire (Under the Right Center Pillar)

▽ : GROUND POINTS

Code	See Page	Ground Points Location
IE	40	Cowl Side Panel LH
IF	40	Left Kick Panel
IG	40	Instrument Panel Brace LH
IJ	40	Right Kick Panel
IK		
BL	44	Under the Left Center Pillar
BN	44	Under the Right Center Pillar

○ : SPLICE POINTS

Code	See Page	Wire Harness with Splice Points	Code	See Page	Wire Harness with Splice Points
E3	36 (1MZ-FE)	Cowl Wire	B13	44	Front Door LH Wire
	38 (5S-FE)		B14	44	Front Door RH Wire
B6	44	Floor No.2 Wire			

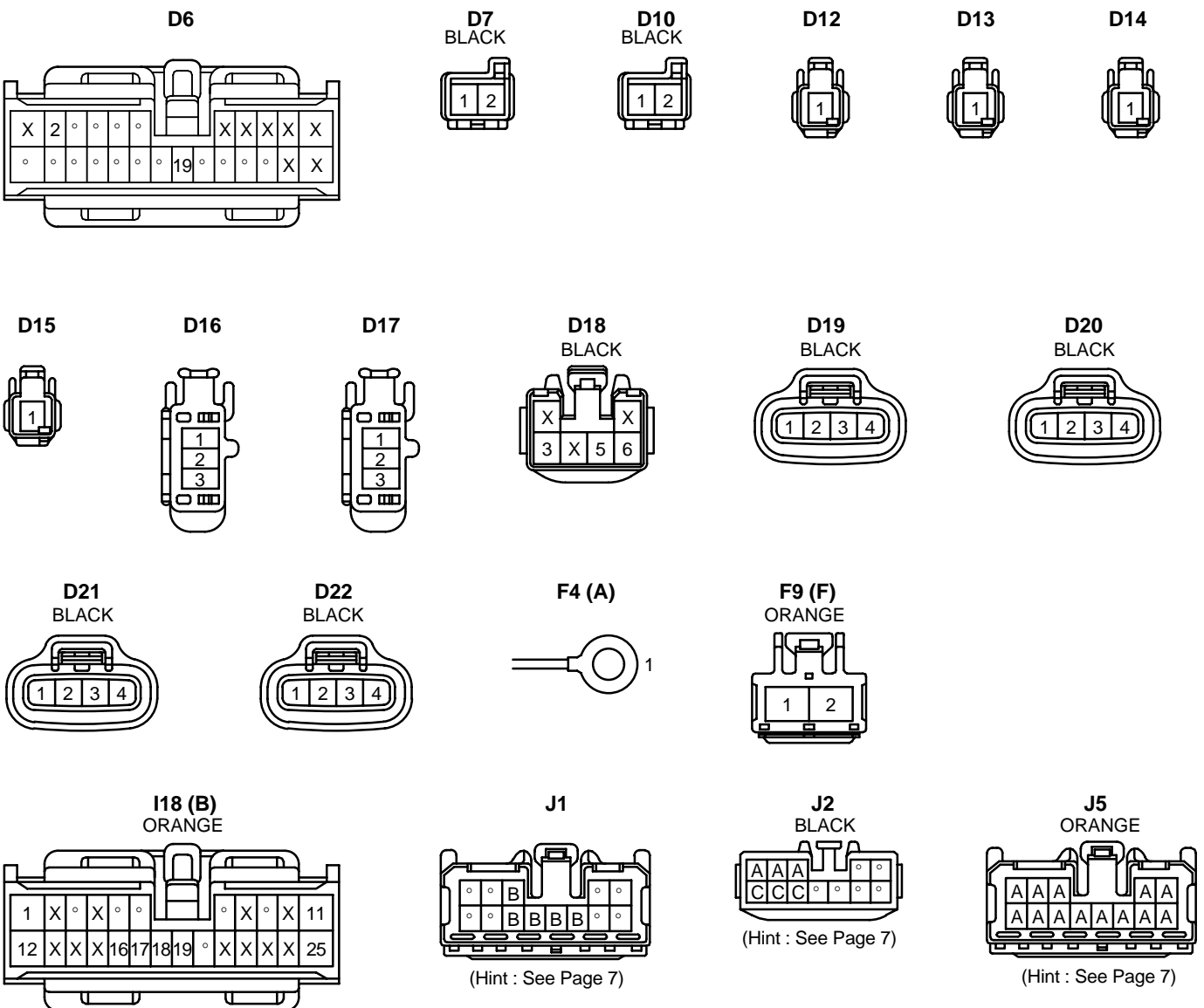

WIRELESS DOOR LOCK CONTROL (TMMK MADE)

J6

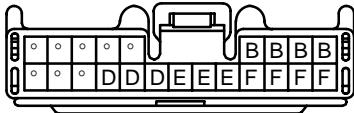

(Hint : See Page 7)

J9 (A)
BLACK

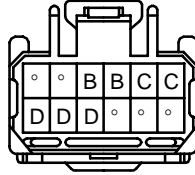

(Hint : See Page 7)

J10 (B)
BLACK

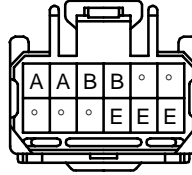

(Hint : See Page 7)

J11

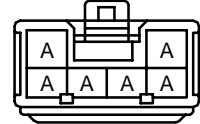

(Hint : See Page 7)

J16 (A)
BLACK

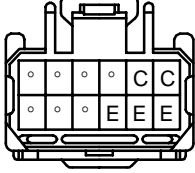

(Hint : See Page 7)

J17 (B)
BLACK

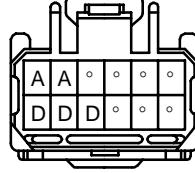

(Hint : See Page 7)

J30 (A)
GRAY

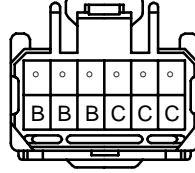

(Hint : See Page 7)

J31 (B)
GRAY

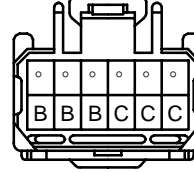

(Hint : See Page 7)

J32
GRAY



(Hint : See Page 7)

J33 (A)
BLACK

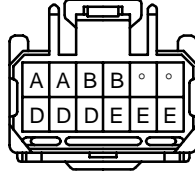

(Hint : See Page 7)

J34 (B)
BLACK

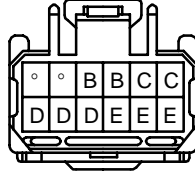

(Hint : See Page 7)

J37

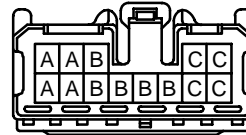

(Hint : See Page 7)

J40

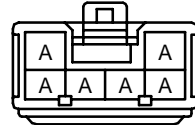

(Hint : See Page 7)

P9

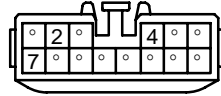

R6

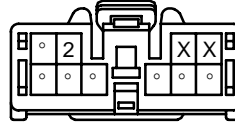

T1
BLACK



T3 (B)

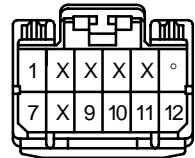

T4 (A)

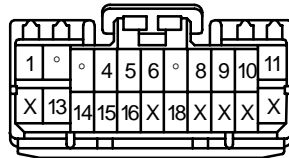

U1



W6
BLUE

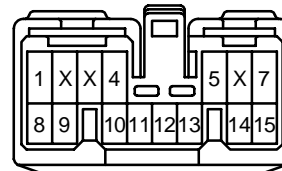

THEFT DETERRENT (TMC MADE)

FROM POWER SOURCE SYSTEM (SEE PAGE 50)

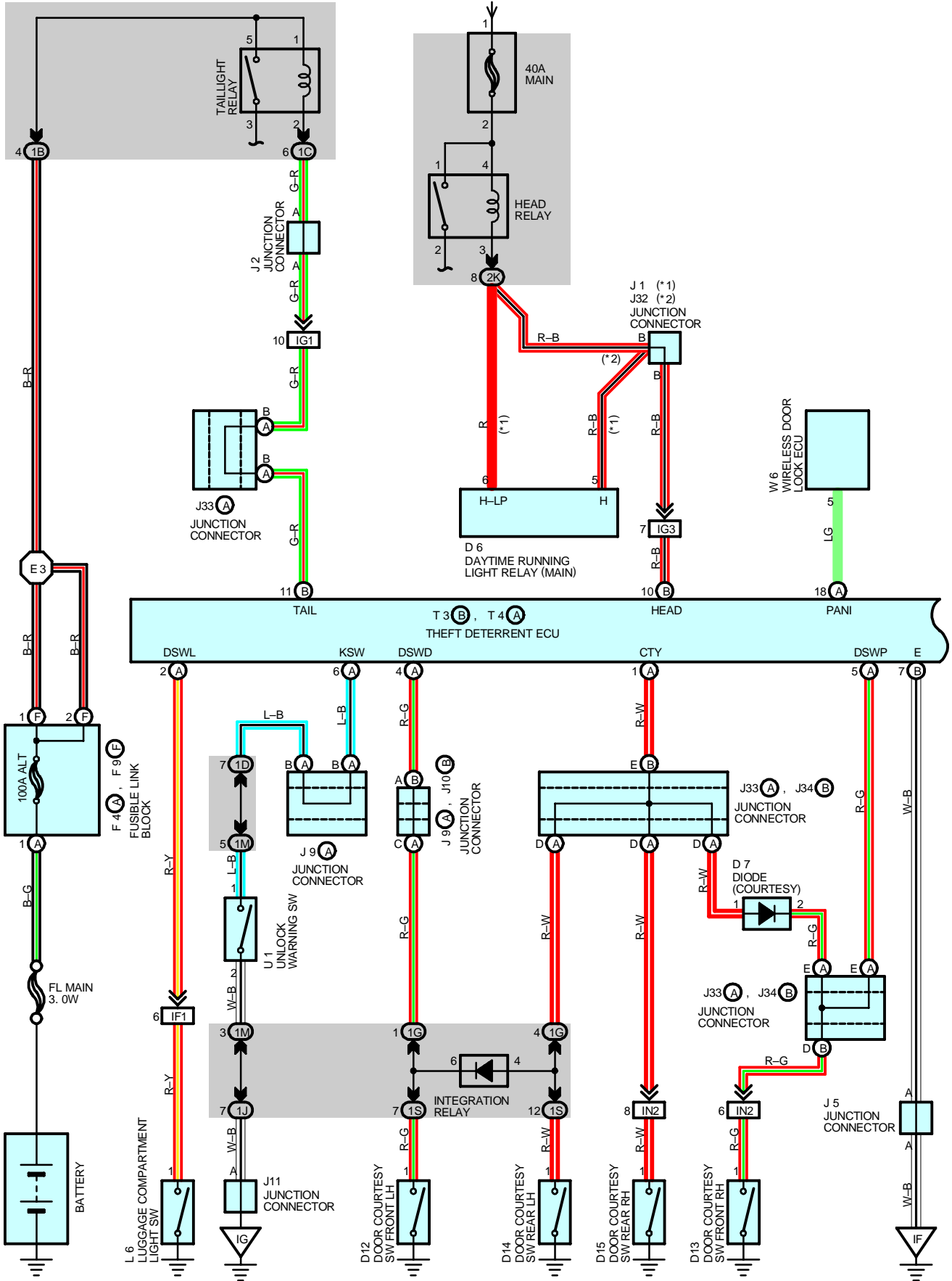

FROM POWER SOURCE SYSTEM (SEE PAGE 50)

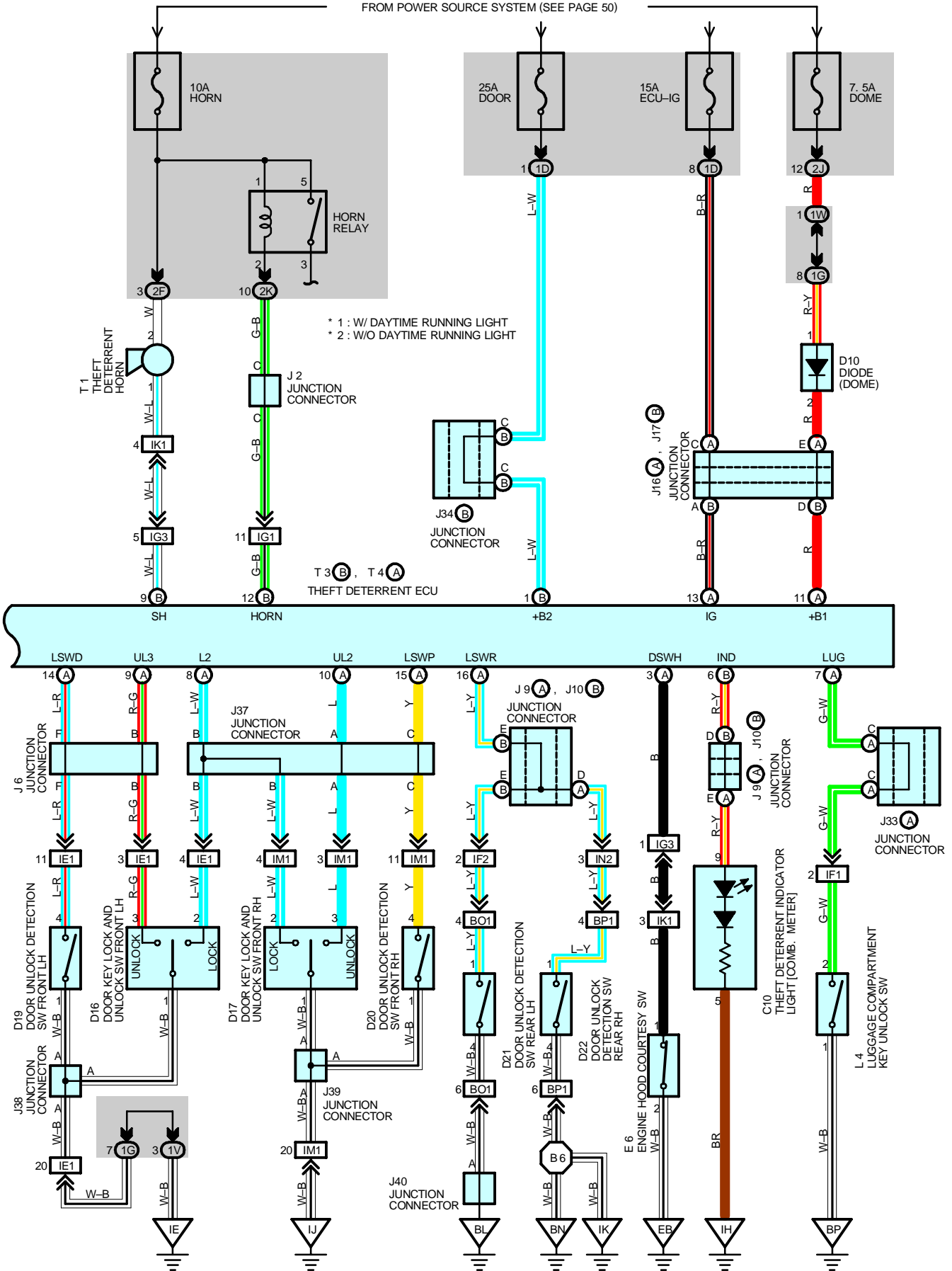

THEFT DETERRENT (TMC MADE)

SERVICE HINTS

D16, D17 DOOR KEY LOCK AND UNLOCK SW FRONT LH, RH

- 1-3 : Closed with door lock cylinder unlocked with key
- 1-2 : Closed with door lock cylinder locked with key

E6 ENGINE HOOD COURTESY SW

- 2-1 : Open with engine hood open

U1 UNLOCK WARNING SW

- 2-1 : Closed with ignition key in cylinder

L4 LUGGAGE COMPARTMENT KEY UNLOCK SW

- 2-1 : Closed with luggage compartment door lock cylinder unlock

L6 LUGGAGE COMPARTMENT LIGHT SW

- 1-GROUND : Closed with luggage compartment door open

T3 (B), T4 (A) THEFT DETERRENT ECU

- (A) 6-GROUND : Continuity with ignition key in cylinder
- (A)15-GROUND : Continuity with front RH door unlocked
- (A)14-GROUND : Continuity with front LH door unlocked
- (A) 5-GROUND : Continuity with front RH door open
- (A) 4-GROUND : Continuity with front LH door open
- (A) 8-GROUND : Continuity with door key lock and unlock SW to **LOCK** position
- (B) 7-GROUND : Always continuity
- (A) 7-GROUND : Continuity with luggage compartment door unlocked
- (A) 1-GROUND : Continuity with each door opened
- (A) 3-GROUND : Continuity with engine hood close
- (A) 2-GROUND : Continuity with luggage compartment door open
- (A)16-GROUND : Continuity with rear door unlocked
- (A) 9, (A) 10-GROUND : Continuity with door key lock and unlock SW to **UNLOCK** position
- (B) 1, (B) 12, (B) 11, (B) 10, (A) 11-GROUND : Always approx. 12 volts

○ : PARTS LOCATION

Code	See Page	Code	See Page	Code	See Page
C10	30	E6	28 (5S-FE)	J33 A	31
D6	30	F4 A	26 (1MZ-FE)	J34 B	31
D7	30		28 (5S-FE)	J37	31
D10	30	F9 F	26 (1MZ-FE)	J38	32
D12	32		28 (5S-FE)	J39	32
D13	32	J1	31	J40	32
D14	32	J2	31	L4	32
D15	32	J5	31	L6	32
D16	32	J6	31	T1	27 (1MZ-FE)
D17	32	J9 A	31		29 (5S-FE)
D19	32	J10 B	31	T3 B	31
D20	32	J11	31	T4 A	31
D21	32	J16 A	31	U1	31
D22	32	J17 B	31	W6	31
E6	26 (1MZ-FE)	J32	31		

 : JUNCTION BLOCK AND WIRE HARNESS CONNECTOR

Code	See Page	Junction Block and Wire Harness (Connector Location)
1B	20	Cowl Wire and Instrument Panel J/B (Lower Finish Panel)
1C		
1D	20	Instrument Panel Wire and Instrument Panel J/B (Lower Finish Panel)
1G		
1J	20	Cowl Wire and Instrument Panel J/B (Lower Finish Panel)
1M		
1S	20	Floor Wire and Instrument Panel J/B (Lower Finish Panel)
1V	20	Cowl Wire and Instrument Panel J/B (Lower Finish Panel)
1W		
2F	22	Engine Room Main Wire and Engine Room J/B No.2 (Engine Compartment Left)
2J	22	Cowl Wire and Engine Room J/B No.2 (Engine Compartment Left)
2K		

 : CONNECTOR JOINING WIRE HARNESS AND WIRE HARNESS

Code	See Page	Joining Wire Harness and Wire Harness (Connector Location)
IE1	40	Front Door LH Wire and Instrument Panel Wire (Left Kick Panel)
IF1	40	Floor Wire and Instrument Panel Wire (Left Kick Panel)
IF2		
IG1	40	Instrument Panel Wire and Cowl Wire (Lower Finish Panel)
IG3	40	Instrument Panel Wire and Cowl Wire (Under the Blower Motor)
IK1	42	Engine Room Main Wire and Cowl Wire (Right Kick Panel)
IM1	42	Front Door RH Wire and Instrument Panel Wire (Right Kick Panel)
IN2	42	Floor No.2 Wire and Instrument Panel Wire (Right Kick Panel)
BO1	44	Rear Door Wire LH and Floor Wire (Under the Left Center Pillar)
BP1	44	Rear Door Wire RH and Floor No.2 Wire (Under the Right Center Pillar)

 : GROUND POINTS

Code	See Page	Ground Points Location
EB	36 (1MZ-FE)	Left Radiator Side Support
	38 (5S-FE)	
IE	40	Cowl Side Panel LH
IF	40	Left Kick Panel
IG	40	Instrument Panel Brace LH
IH	40	Instrument Panel Brace RH
IJ	40	Right Kick Panel
IK		
BL	44	Under the Left Center Pillar
BN	44	Under the Right Center Pillar
BP	44	Back Panel Center

 : SPLICE POINTS

Code	See Page	Wire Harness with Splice Points	Code	See Page	Wire Harness with Splice Points
E3	36 (1MZ-FE)	Cowl Wire	B6	44	Floor No.2 Wire
	38 (5S-FE)				

THEFT DETERRENT (TMC MADE)

C10
BROWN

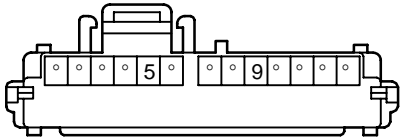

D6
GRAY

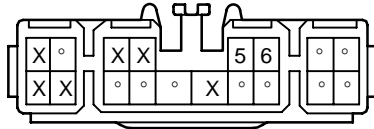

D7
BLACK



D10
BLACK



D12



D13



D14



D15



D16

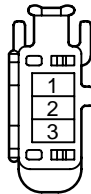

D17

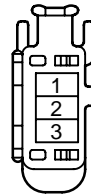

D19
BLACK

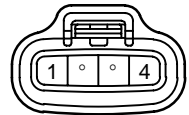

D20
BLACK

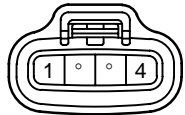

D21
BLACK

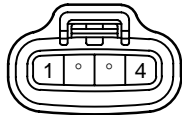

D22
BLACK

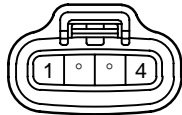

E6
BLACK



F4 (A)

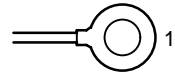

F9 (F)
ORANGE

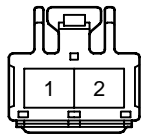

J1

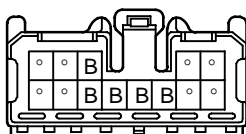

(Hint : See Page 7)

J2
BLACK



(Hint : See Page 7)

J5
ORANGE

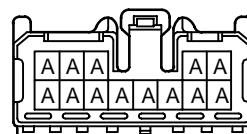

(Hint : See Page 7)

J6

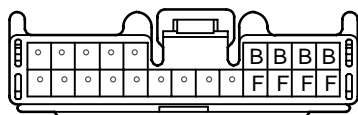

(Hint : See Page 7)

J9 (A)
BLACK

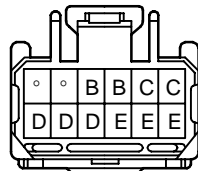

(Hint : See Page 7)

J10 (B)
BLACK

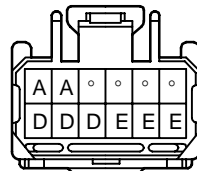

(Hint : See Page 7)

J11

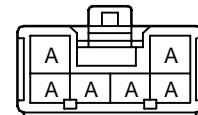

(Hint : See Page 7)

J16 (A)
BLACK

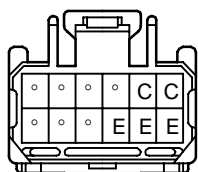

(Hint : See Page 7)

J17 (B)
BLACK

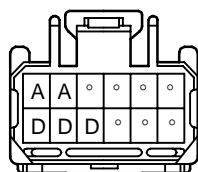

(Hint : See Page 7)

J32
GRAY

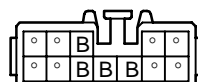

(Hint : See Page 7)

J33 (A)
BLACK

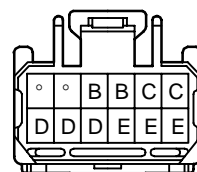

(Hint : See Page 7)

J34 (B)
BLACK

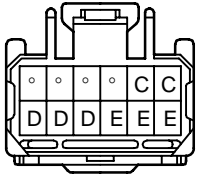

(Hint : See Page 7)

J37

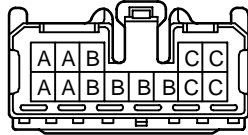

(Hint : See Page 7)

J38



(Hint : See Page 7)

J39



(Hint : See Page 7)

J40

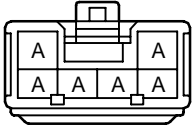

(Hint : See Page 7)

L4

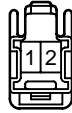

L6
GRAY



T1
BLACK



T3 (B)

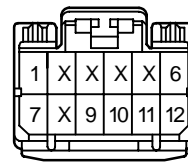

T4 (A)

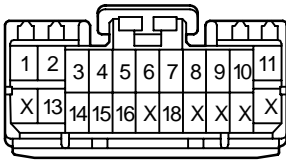

U1

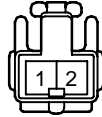

W6
BLUE

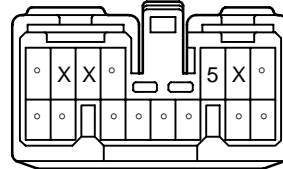

THEFT DETERRENT (TMMK MADE)

SERVICE HINTS

D16, D17 DOOR KEY LOCK AND UNLOCK SW FRONT LH, RH

- 1-3 : Closed with door lock cylinder unlocked with key
- 1-2 : Closed with door lock cylinder locked with key

E6 ENGINE HOOD COURTESY SW

- 2-1 : Open with engine hood open

U1 UNLOCK WARNING SW

- 2-1 : Closed with ignition key in cylinder

L4 LUGGAGE COMPARTMENT KEY UNLOCK SW

- 2-1 : Closed with luggage compartment door lock cylinder unlock

L6 LUGGAGE COMPARTMENT LIGHT SW

- 1-GROUND : Closed with luggage compartment door open

T3 (B), T4 (A) THEFT DETERRENT ECU

- (A) 6-GROUND : Continuity with ignition key in cylinder
- (A)15-GROUND : Continuity with front RH door unlocked
- (A)14-GROUND : Continuity with front LH door unlocked
- (A) 5-GROUND : Continuity with front RH door open
- (A) 4-GROUND : Continuity with front LH door open
- (A) 8-GROUND : Continuity with door key lock and unlock SW to **LOCK** position
- (B) 7-GROUND : Always continuity
- (A) 7-GROUND : Continuity with luggage compartment door unlocked
- (A) 1-GROUND : Continuity with each door opened
- (A) 3-GROUND : Continuity with engine hood close
- (A) 2-GROUND : Continuity with luggage compartment door open
- (A)16-GROUND : Continuity with rear door unlocked
- (A) 9, (A) 10-GROUND : Continuity with door key lock and unlock SW to **UNLOCK** position
- (B) 1, (B) 12, (B) 11, (B) 10, (A) 11-GROUND : Always approx. 12 volts

○ : PARTS LOCATION

Code	See Page	Code	See Page	Code	See Page
C10	30	E6	26 (1MZ-FE)	J17 B	31
D6	30	E6	28 (5S-FE)	J32	31
D7	30	F4 A	26 (1MZ-FE)	J33 A	31
D10	30		28 (5S-FE)	J34 B	31
D12	32	F9 F	26 (1MZ-FE)	J37	31
D13	32		28 (5S-FE)	J40	32
D14	32	J1	31	L4	32
D15	32	J2	31	L6	32
D16	32	J5	31	T1	27 (1MZ-FE)
D17	32	J6	31		29 (5S-FE)
D19	32	J9 A	31	T3 B	31
D20	32	J10 B	31	T4 A	31
D21	32	J11	31	U1	31
D22	32	J16 A	31	W6	31

 : JUNCTION BLOCK AND WIRE HARNESS CONNECTOR

Code	See Page	Junction Block and Wire Harness (Connector Location)
1B	20	Cowl Wire and Instrument Panel J/B (Lower Finish Panel)
1C		
1D	20	Instrument Panel Wire and Instrument Panel J/B (Lower Finish Panel)
1G		
1J	20	Cowl Wire and Instrument Panel J/B (Lower Finish Panel)
1M		
1S	20	Floor Wire and Instrument Panel J/B (Lower Finish Panel)
1V	20	Cowl Wire and Instrument Panel J/B (Lower Finish Panel)
1W		
2F	22	Engine Room Main Wire and Engine Room J/B No.2 (Engine Compartment Left)
2J	22	Cowl Wire and Engine Room J/B No.2 (Engine Compartment Left)
2K		

 : CONNECTOR JOINING WIRE HARNESS AND WIRE HARNESS

Code	See Page	Joining Wire Harness and Wire Harness (Connector Location)
IE1	40	Front Door LH Wire and Instrument Panel Wire (Left Kick Panel)
IF1	40	Floor Wire and Instrument Panel Wire (Left Kick Panel)
IF2		
IG1	40	Instrument Panel Wire and Cowl Wire (Lower Finish Panel)
IG3	40	Instrument Panel Wire and Cowl Wire (Under the Blower Motor)
IK1	42	Engine Room Main Wire and Cowl Wire (Right Kick Panel)
IM1	42	Front Door RH Wire and Instrument Panel Wire (Right Kick Panel)
IN2	42	Floor No.2 Wire and Instrument Panel Wire (Right Kick Panel)
BO1	44	Rear Door Wire LH and Floor Wire (Under the Left Center Pillar)
BP1	44	Rear Door Wire RH and Floor No.2 Wire (Under the Right Center Pillar)

 : GROUND POINTS

Code	See Page	Ground Points Location
EB	36 (1MZ-FE)	Left Radiator Side Support
	38 (5S-FE)	
IE	40	Cowl Side Panel LH
IF	40	Left Kick Panel
IG	40	Instrument Panel Brace LH
IH	40	Instrument Panel Brace RH
IJ	40	Right Kick Panel
IK		
BL	44	Under the Left Center Pillar
BN	44	Under the Right Center Pillar
BP	44	Back Panel Center

 : SPLICE POINTS

Code	See Page	Wire Harness with Splice Points	Code	See Page	Wire Harness with Splice Points
E3	36 (1MZ-FE)	Cowl Wire	B13	44	Front Door LH Wire
	38 (5S-FE)		B14	44	Front Door RH Wire
B6	44	Floor No.2 Wire			

THEFT DETERRENT (TMMK MADE)

C10
BROWN

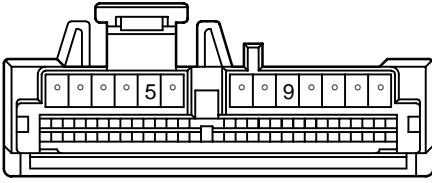

D6

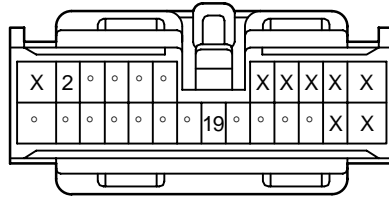

D7
BLACK



D10
BLACK



D12



D13



D14



D15



D16

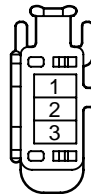

D17

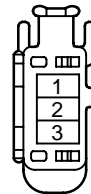

D19
BLACK

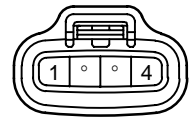

D20
BLACK

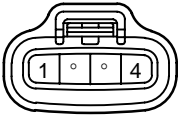

D21
BLACK

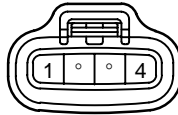

D22
BLACK

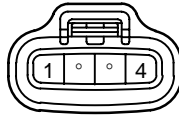

E6
BLACK



F4 (A)

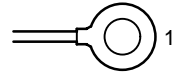

F9 (F)
ORANGE

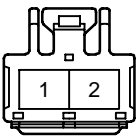

J1

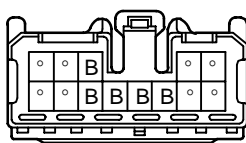

(Hint : See Page 7)

J2
BLACK

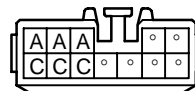

(Hint : See Page 7)

J5
ORANGE

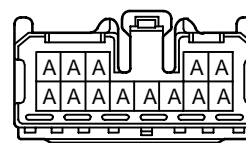

(Hint : See Page 7)

J6

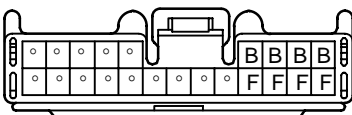

(Hint : See Page 7)

J9 (A)
BLACK

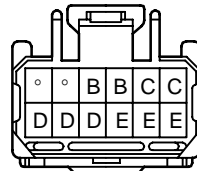

(Hint : See Page 7)

J10 (B)
BLACK

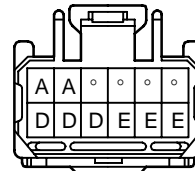

(Hint : See Page 7)

J11

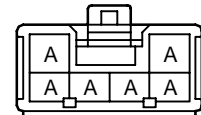

(Hint : See Page 7)

J16 (A)
BLACK

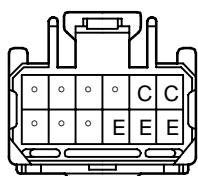

(Hint : See Page 7)

J17 (B)
BLACK

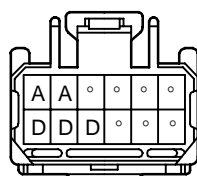

(Hint : See Page 7)

J32
GRAY

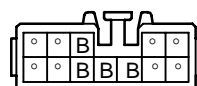

(Hint : See Page 7)

J33 (A)
BLACK

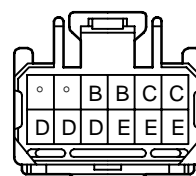

(Hint : See Page 7)

J34 (B)
BLACK

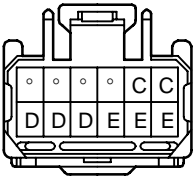

(Hint : See Page 7)

J37

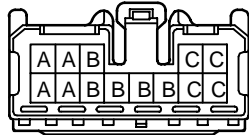

(Hint : See Page 7)

J40

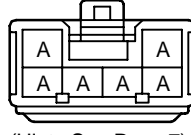

(Hint : See Page 7)

L4

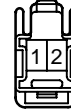

L6
GRAY



T1
BLACK



T3 (B)

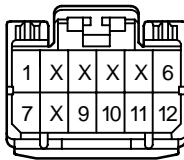

T4 (A)

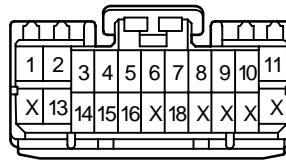

U1

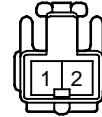

W6
BLUE

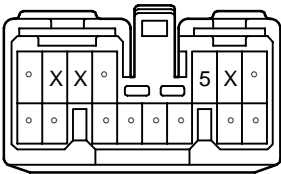

MOON ROOF

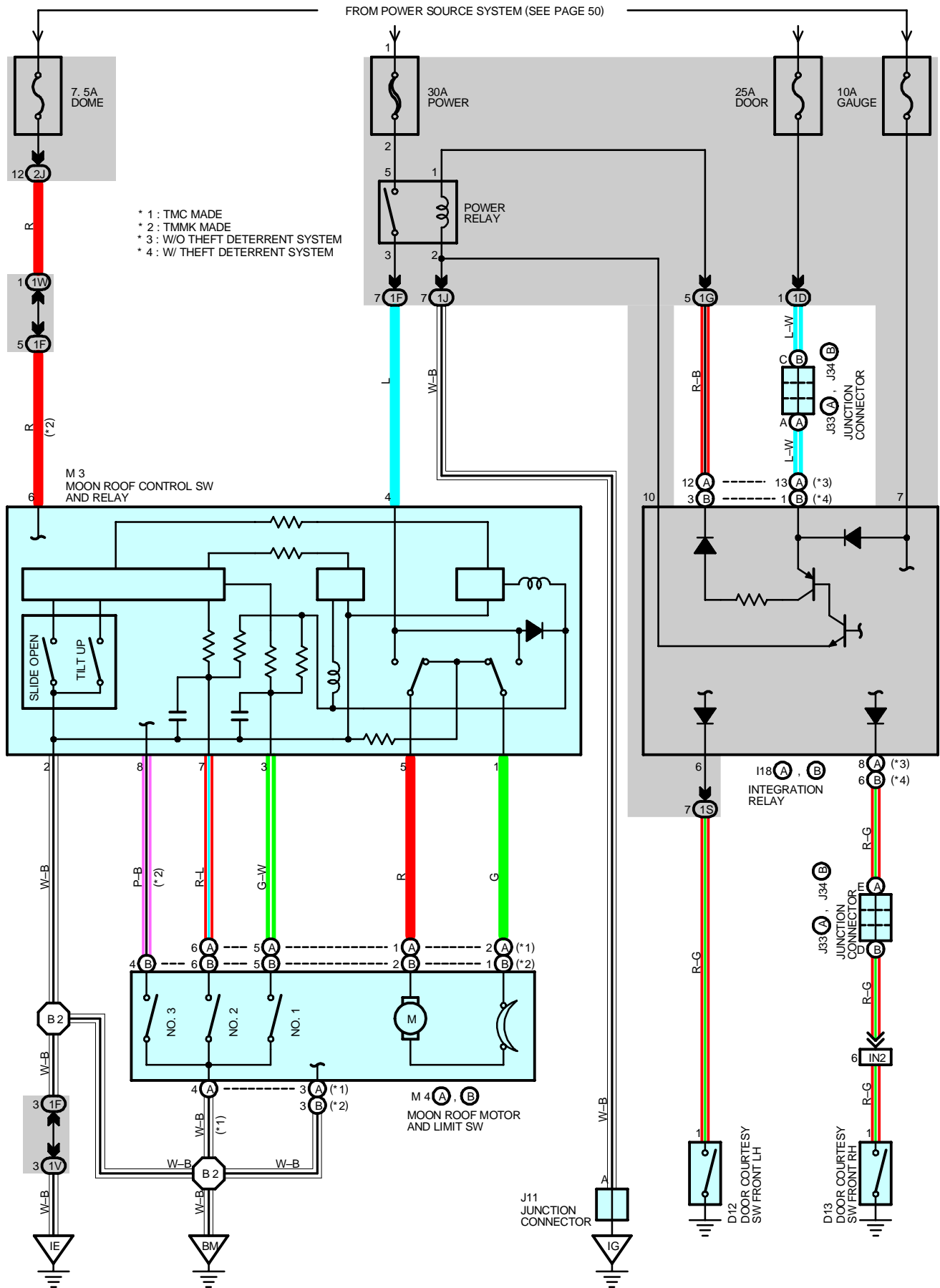

SYSTEM OUTLINE

Current is applied at all times through the POWER fuse to TERMINAL 5 of the power relay. With the ignition SW turned on, the current flows through the GAUGE fuse to TERMINAL 7 of the integration relay to TERMINAL (A) 12 (w/o theft deterrent system), (B) 3 (w/ theft deterrent system) to TERMINAL 1 of the power relay to TERMINAL 2 to GROUND, as a result, power relay is activated and the current to TERMINAL 5 of the power relay flows from TERMINAL 3 of the power relay to TERMINAL 4 of the moon roof control relay.

1. SLIDE OPEN OPERATION

Only when the slide open switch is valid and actuated the moon roof motor continually will operate towards the open direction of the roof panel.

Releasing and again depressing the open switch, or depressing another operation switch shall cancel this express open function. The relay shall only operate the moon roof motor continually for approx. 20 seconds per actuation.

2. SLIDE CLOSE OPERATION

Only when the tilt up switch is valid and actuated the moon roof motor will operate towards the close direction of the roof panel.

When the moon roof reaches about 120 mm short of the fully closed position, the limit switch No.2 is turned from on to off. Thereby signaling the moon roof control relay to stop the motor. The motor can not continue to operate until the close switch is released and again depressed.

3. TILT UP OPERATION

Only when the tilt up switch is valid and actuated the moon roof motor will operate towards the closed direction of the roof panel.

4. TILT DOWN OPERATION

Only when the slide open switch is valid and actuated the moon roof motor will operate towards the open direction of the roof panel.

5. KEY OFF MOON ROOF OPERATION

With the ignition SW turned from on to off, the integration relay operates and current flows from the DOOR fuse to TERMINAL (A) 13 (w/o theft deterrent system), (B) 1 (w/ theft deterrent system) of the relay to TERMINAL (A) 12 (w/o theft deterrent system), (B) 3 (w/ theft deterrent system) to TERMINAL 1 of the power relay to TERMINAL 2 to GROUND for about 43 seconds. In the same way as normal operation, the current flows from the POWER fuse to TERMINAL 5 of the power relay to TERMINAL 3 to TERMINAL 4 of the moon roof control relay. As a result, for about 43 seconds after the ignition SW is turned off, the functioning of this relay makes it possible to open and close the moon roof. Also, by opening the front door (Door courtesy SW on) within about 43 seconds after turning the ignition SW to off, a signal is input to TERMINALS 6 or (A) 8 (w/o theft deterrent system), (B) 6 (w/ theft deterrent system) of the integration relay. As a result, the relay turns off and open close movement of the moon roof stops.

SERVICE HINTS

POWER RELAY [INSTRUMENT PANEL J/B]

5-3 : Closed with the ignition SW at **ON** position or key off moon roof operation

M3 MOON ROOF CONTROL SW AND RELAY

2-GROUND : Always continuity

4-GROUND : Approx. 12 volts with the ignition SW at **ON** position or key off moon roof operation

○ : PARTS LOCATION

Code	See Page	Code	See Page	Code	See Page
D12	32	J11	31	M4	A 33
D13	32	J33	A 31		B 33
I18	A 30	J34	B 31		
	B 30	M3	33		

MOON ROOF

: JUNCTION BLOCK AND WIRE HARNESS CONNECTOR

Code	See Page	Junction Block and Wire Harness (Connector Location)
1D	20	Instrument Panel Wire and Instrument Panel J/B (Lower Finish Panel)
1F	20	Roof Wire and Instrument Panel J/B (Lower Finish Panel)
1G	20	Instrument Panel Wire and Instrument Panel J/B (Lower Finish Panel)
1J	20	Cowl Wire and Instrument Panel J/B (Lower Finish Panel)
1S	20	Floor Wire and Instrument Panel J/B (Lower Finish Panel)
1V	20	Cowl Wire and Instrument Panel J/B (Lower Finish Panel)
1W		
2J	22	Cowl Wire and Engine Room J/B No.2 (Engine Compartment Left)

: CONNECTOR JOINING WIRE HARNESS AND WIRE HARNESS

Code	See Page	Joining Wire Harness and Wire Harness (Connector Location)
IN2	42	Floor No.2 Wire and Instrument Panel Wire (Right Kick Panel)

: GROUND POINTS

Code	See Page	Ground Points Location
IE	40	Cowl Side Panel LH
IG	40	Instrument Panel Brace LH
BM	44	Roof Left

: SPLICE POINTS

Code	See Page	Wire Harness with Splice Points	Code	See Page	Wire Harness with Splice Points
B2	44	Roof Wire			

D12



D13



I18 (A)

(w/o Theft Deterrent System) ORANGE

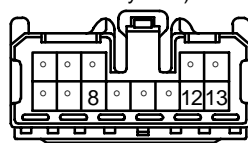

I18 (B)

(w/ Theft Deterrent System) ORANGE

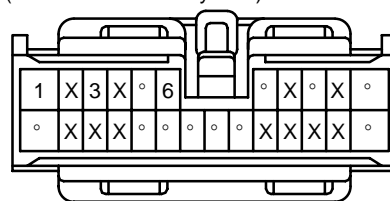

J11

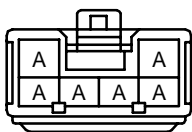

(Hint : See Page 7)

J33 (A)
BLACK

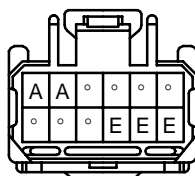

(Hint : See Page 7)

J34 (B)
BLACK

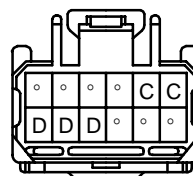

(Hint : See Page 7)

M3

(TMC Made)



M3

(TMMK Made)



M4 (A)

(TMC Made)

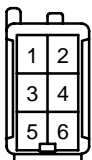

M4 (B)

(TMMK Made)

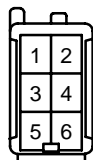

POWER SEAT

FROM POWER SOURCE SYSTEM (SEE PAGE 50)

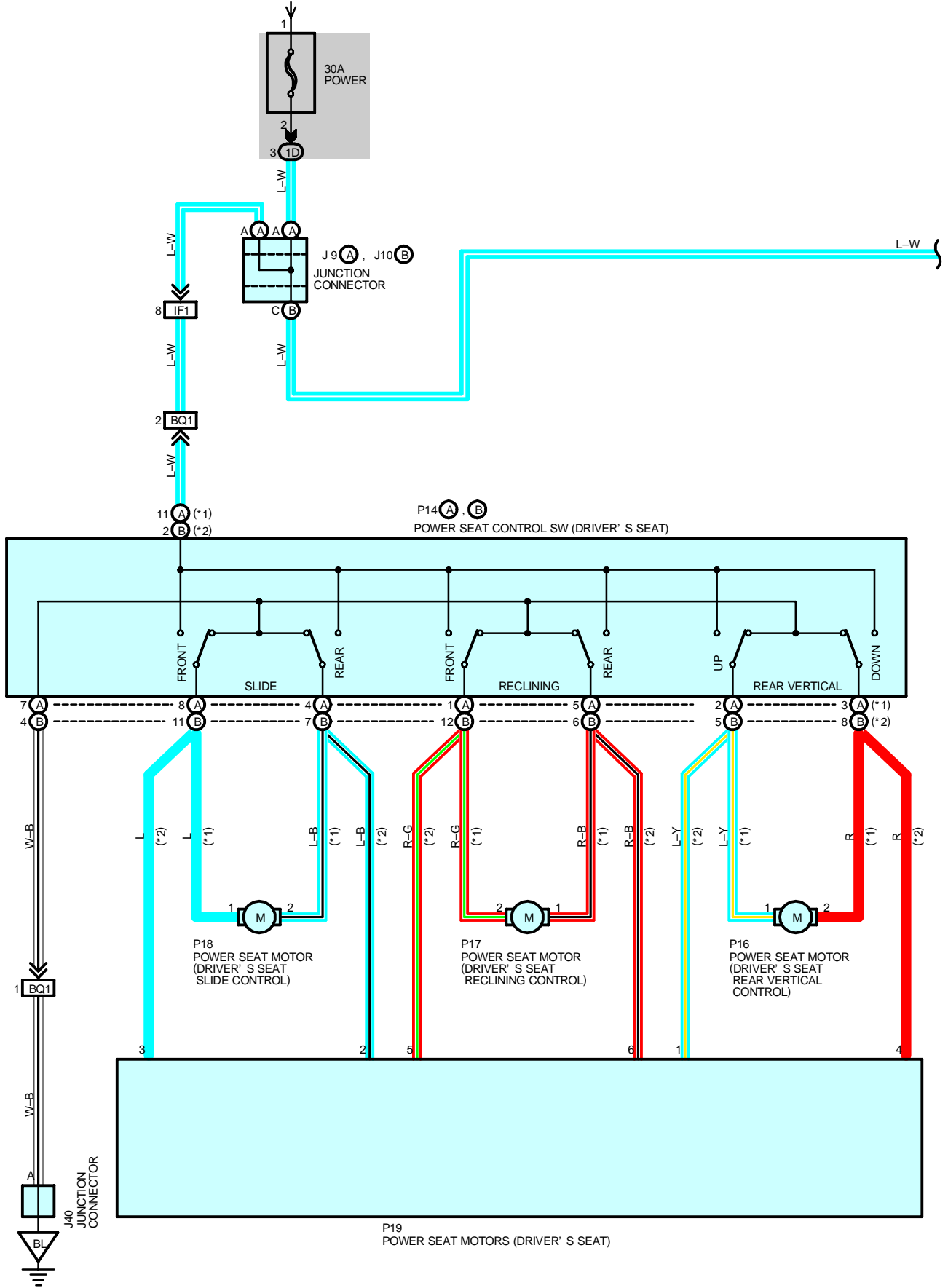

* 1 : TMC MADE
 * 2 : TMMK MADE

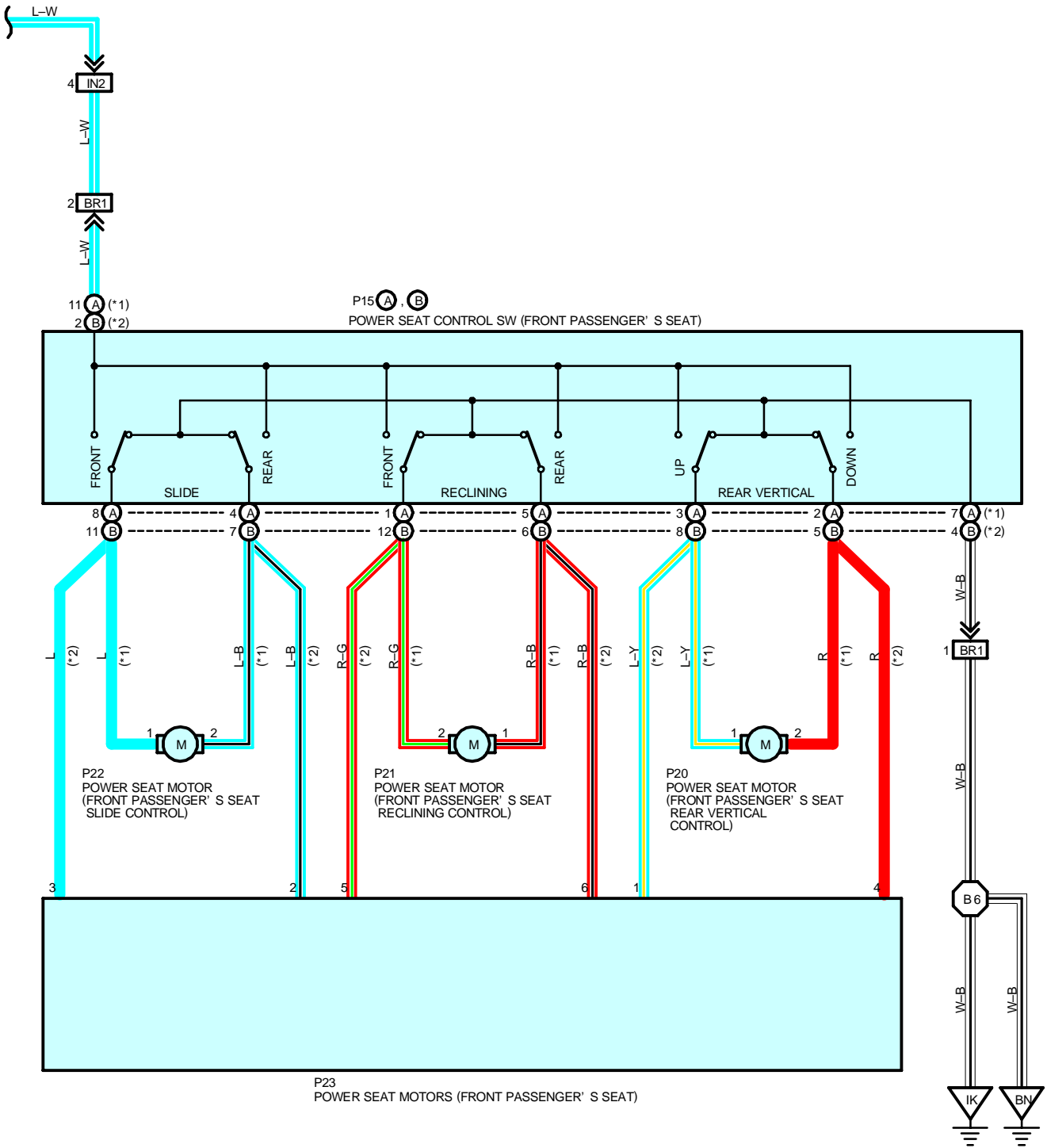

POWER SEAT

SERVICE HINTS

P14 (A), (B) POWER SEAT CONTROL SW (DRIVER'S SEAT)

(A) 11, (B) 2-GROUND : Always approx. 12 volts

(A) 7, (B) 4-GROUND : Always continuity

P15 (A), (B) POWER SEAT CONTROL SW (FRONT PASSENGER'S SEAT)

(A) 11, (B) 2-GROUND : Always approx. 12 volts

(A) 7, (B) 4-GROUND : Always continuity

○ : PARTS LOCATION

Code	See Page	Code	See Page	Code	See Page
J9	A 31	P15	A 34	P19	34
J10	B 31		B 34	P20	34
J40	32	P16	34	P21	34
P14	A 34	P17	34	P22	34
	B 34	P18	34	P23	34

○ : JUNCTION BLOCK AND WIRE HARNESS CONNECTOR

Code	See Page	Junction Block and Wire Harness (Connector Location)
1D	20	Instrument Panel Wire and Instrument Panel J/B (Lower Finish Panel)

□ : CONNECTOR JOINING WIRE HARNESS AND WIRE HARNESS

Code	See Page	Joining Wire Harness and Wire Harness (Connector Location)
IF1	40	Floor Wire and Instrument Panel Wire (Left Kick Panel)
IN2	42	Floor No.2 Wire and Instrument Panel Wire (Right Kick Panel)
BQ1	46	Floor Wire and Seat No.1 Wire (Under the Driver's Seat)
BR1	46	Floor No.2 Wire and Seat No.2 Wire (Under the Passenger's Seat)

▽ : GROUND POINTS

Code	See Page	Ground Points Location
IK	40	Right Kick Panel
BL	44	Under the Left Center Pillar
BN	44	Under the Right Center Pillar

○ : SPLICE POINTS

Code	See Page	Wire Harness with Splice Points	Code	See Page	Wire Harness with Splice Points
B6	44	Floor No.2 Wire			

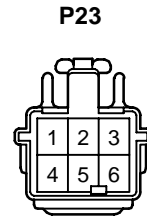
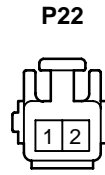
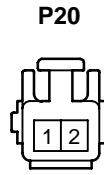
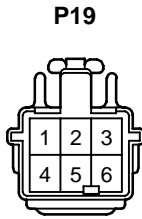
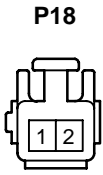
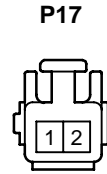
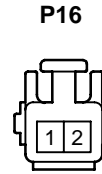
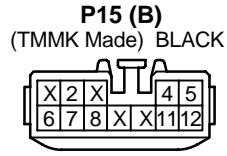
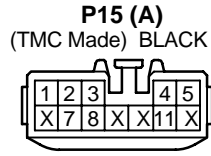
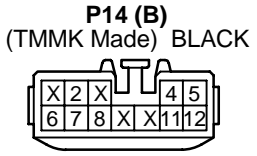
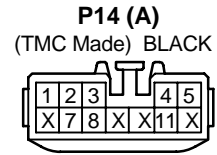
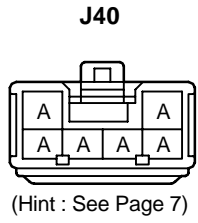
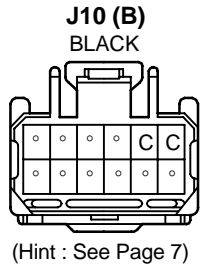
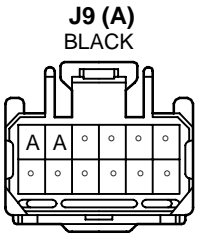

ELECTRONICALLY CONTROLLED TRANSMISSION AND AT INDICATOR

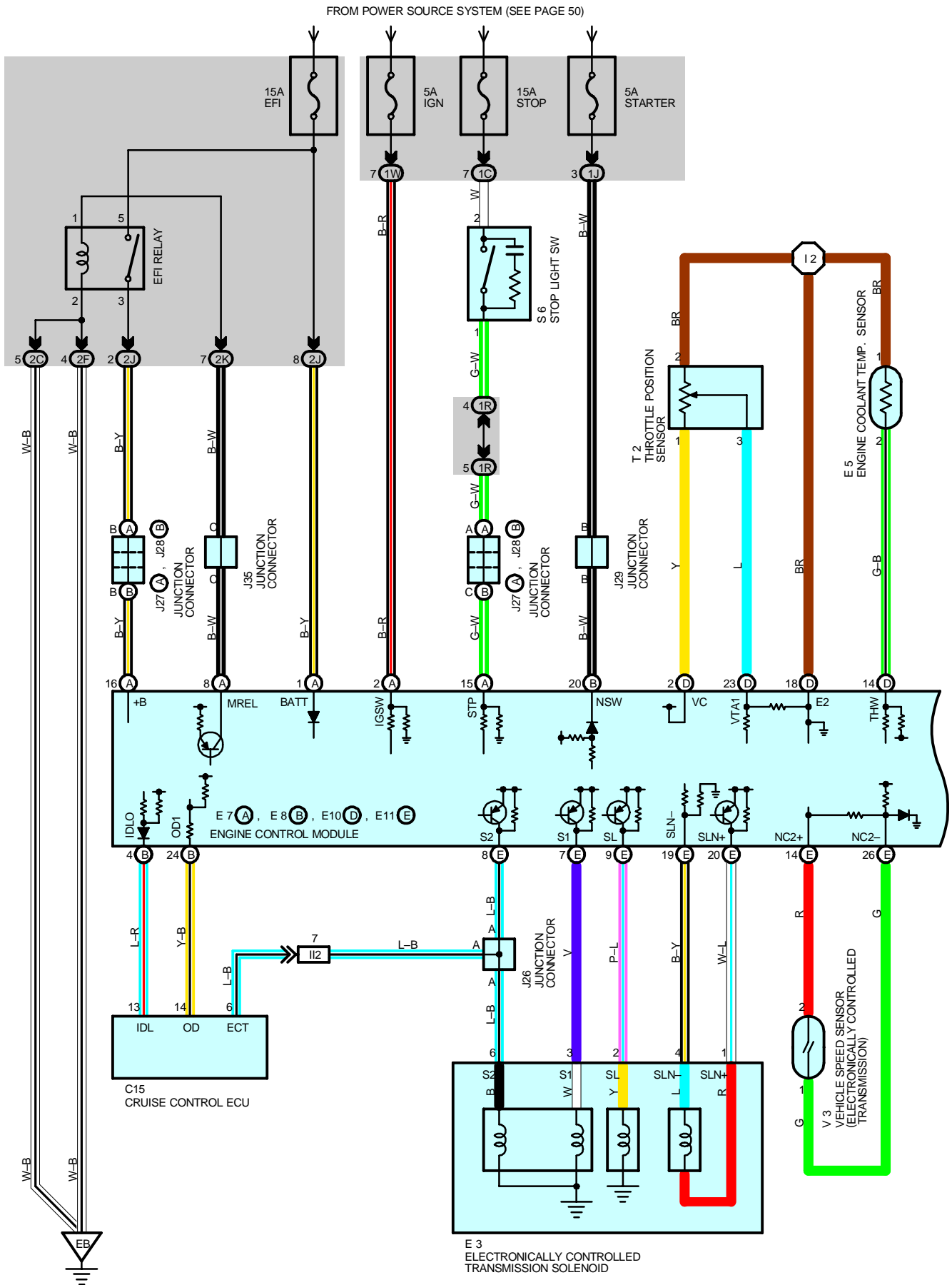

(1MZ-FE)

FROM POWER SOURCE SYSTEM (SEE PAGE 50)

- * 1 : CALIFORNIA
- * 2 : EXCEPT CALIFORNIA
- * 3 : TMMK MADE
- * 4 : TMC MADE

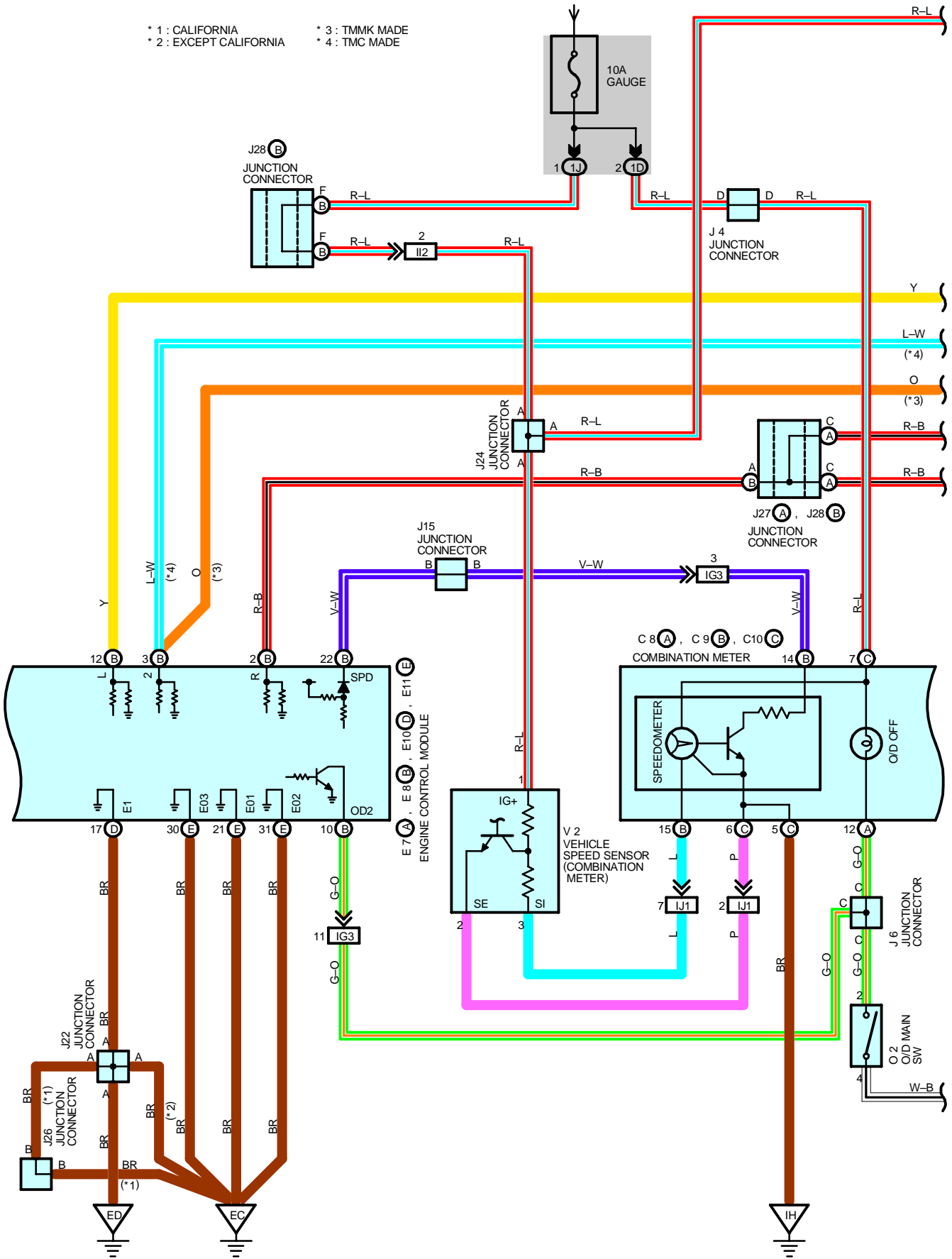

ELECTRONICALLY CONTROLLED TRANSMISSION AND A/T INDICATOR

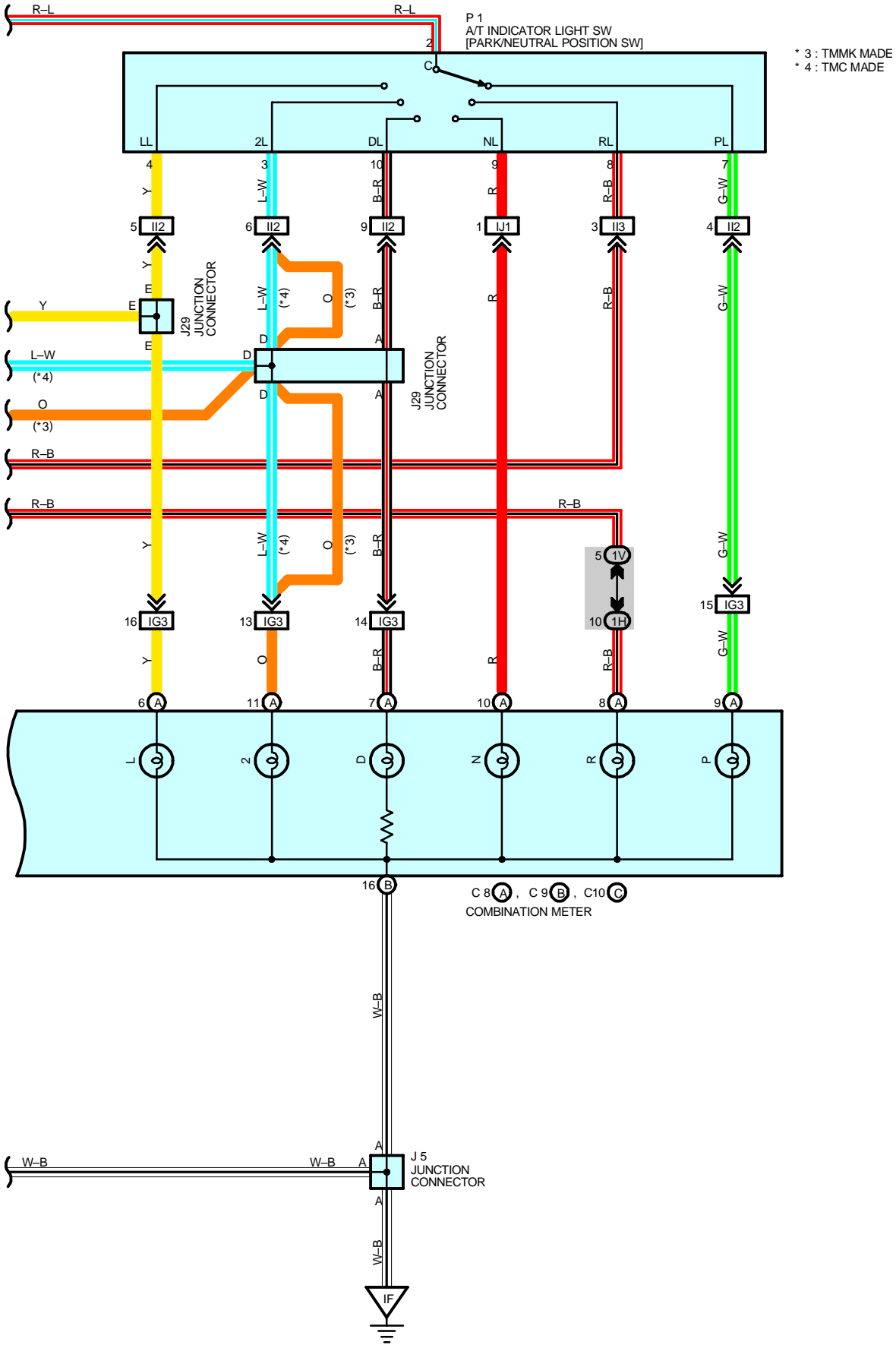

(1MZ-FE)

SYSTEM OUTLINE

Previous automatic transaxle have selected each gear shift using the mechanically controlled throttle hydraulic pressure, governor hydraulic pressure and lock-up hydraulic pressure. The electronically controlled transmission, however, electrically controls the line pressure and lock-up pressure etc., through the solenoid valve. Engine control module control of the solenoid valve based on the input signals from each sensor makes smooth driving possible by shift selection for each gear which is most appropriate to the driving conditions at that time.

1. GEAR SHIFT OPERATION

During driving, the engine control module selects the shift for each gear which is most appropriate to the driving conditions, based on input signals from the engine coolant temp. sensor to TERMINAL THW of the engine control module, and also the input signals to TERMINAL NC2+ of the engine control module from the vehicle speed sensor devoted to the O/D direct clutch. Current is then output to the electronically controlled transmission solenoid. When shifting to 1st speed, current flows from TERMINAL S1 of the engine control module to TERMINAL 3 of the electronically controlled transmission solenoid to GROUND, and continuity to the No.1 solenoid causes the shift.

For the 2nd speed, current flows from TERMINAL S1 of the engine control module to TERMINAL 3 of the electronically controlled transmission solenoid to GROUND, and from TERMINAL S2 of the engine control module to TERMINAL 6 of the electronically controlled transmission solenoid to GROUND, and continuity to solenoids No.1 and No.2 causes the shift.

For the 3rd speed, there is no continuity to No.1 solenoid, only to No.2, causing the shift.

Shifting into 4th speed (Overdrive) takes place when there is no continuity to either No.1 or No.2 solenoid.

2. LOCK-UP OPERATION

When the engine control module judges from each signal that lock-up operation conditions have been met, current flows from TERMINAL SL of the engine control module to TERMINAL 2 of the electronically controlled transmission solenoid to GROUND, causing continuity to the lock-up solenoid and causing lock-up operation.

3. STOP LIGHT SW CIRCUIT

If the brake pedal is depressed (Stop light SW on) when driving in lock-up condition, a signal is input to TERMINAL STP of the engine control module, the engine control module operates and continuity to the lock-up solenoid is cut.

4. OVERDRIVE CIRCUIT

* Overdrive on

When the O/D main SW is turned on (O/D off indicator light turns off), a signal is input to TERMINAL OD2 of the engine control module and engine control module operation causes gear shift when the conditions for overdrive are met.

* Overdrive off

When the O/D main SW is turned to off (O/D off indicator light turns on), the current flowing through the O/D off indicator light flows through the O/D main SW to GROUND. Causing the indicator light to light up. At the same time, a signal is input to TERMINAL OD2 of the engine control module and engine control module operation prevents shift into overdrive.

SERVICE HINTS

E7 (A), E8 (B), E10 (D), E11 (E) ENGINE CONTROL MODULE (TURN ON THE IGNITION SW)

S1, S2-E1 : 9.0-14.0 volts with the solenoid on

0-1.5 volts with the solenoid off

L-E1 : 7.5-14.0 volts with the shift lever at L position

2-E1 : 7.5-14.0 volts with the shift lever at 2 position

R-E1 : 7.5-14.0 volts with the shift lever at R position

STP-E1 : 7.5-14.0 volts with the brake pedal depressed

THW-E2 : 0.2-1.0 volts with the engine coolant temp. 80°C (176°F)

VAT1-E2 : 0.3-0.8 volts with the throttle valve fully closed

3.2-4.9 volts with the throttle valve fully opened

VC-E2 : 4.5-5.5 volts

OD2-E1 : 9.0-14.0 volts with the O/D main SW turned off

0-3.0 volts with the O/D main SW turned on

+B-E1 : 9.0-14.0 volts

OD1-E1 : 9.0-14.0 volts

E3 ELECTRONICALLY CONTROLLED TRANSMISSION SOLENOID

2, 3, 6-GROUND : Each 11-15 Ω

O2 O/D MAIN SW

2-4 : Closed with the O/D main SW off, open with the O/D main SW on

ELECTRONICALLY CONTROLLED TRANSMISSION AND A/T INDICATOR

: PARTS LOCATION

Code		See Page	Code		See Page	Code		See Page
C8	A	30	E11	E	30	J28	B	31
C9	B	30	J4		31	J29		31
C10	C	30	J5		31	J35		31
C15		30	J6		31	O2		31
E3		26 (1MZ-FE)	J15		31	P1		27 (1MZ-FE)
E5		26 (1MZ-FE)	J22		31	S6		31
E7	A	30	J24		31	T2		27 (1MZ-FE)
E8	B	30	J26		31	V2		27 (1MZ-FE)
E10	D	30	J27	A	31	V3		27 (1MZ-FE)

: JUNCTION BLOCK AND WIRE HARNESS CONNECTOR

Code	See Page	Junction Block and Wire Harness (Connector Location)
1C	20	Cowl Wire and Instrument Panel J/B (Lower Finish Panel)
1D	20	Instrument Panel Wire and Instrument Panel J/B (Lower Finish Panel)
1H		
1J	20	Cowl Wire and Instrument Panel J/B (Lower Finish Panel)
1R		
1V		
1W		
2C		
2F	22	Engine Room Main Wire and Engine Room J/B No.2 (Engine Compartment Left)
2J	22	Cowl Wire and Engine Room J/B No.2 (Engine Compartment Left)
2K		

: CONNECTOR JOINING WIRE HARNESS AND WIRE HARNESS

Code	See Page	Joining Wire Harness and Wire Harness (Connector Location)
IG3	40	Instrument Panel Wire and Cowl Wire (Under the Blower Motor)
II2	42	Engine Wire and Cowl Wire (Under the Blower Motor)
II3		
IJ1	42	Engine Wire and Instrument Panel Wire (Under the Blower Motor)

: GROUND POINTS

Code	See Page	Ground Points Location
EB	36 (1MZ-FE)	Left Radiator Side Support
EC	36 (1MZ-FE)	Surge Tank RH
ED	36 (1MZ-FE)	Rear Side of the Surge Tank
IF	40	Left Kick Panel
IH	40	Instrument Panel Brace RH

: SPLICE POINTS

Code	See Page	Wire Harness with Splice Points	Code	See Page	Wire Harness with Splice Points
I2	42	Engine Wire			

(1MZ-FE)

C8 (A)
(TMC Made) BLUE

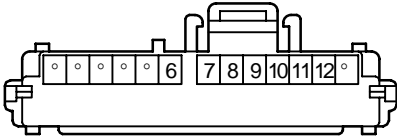

C8 (A)
(TMMK Made) BLUE

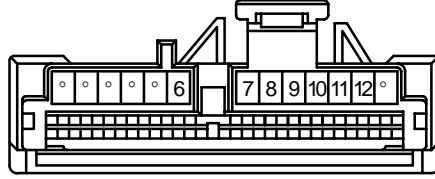

C9 (B)
(TMC Made)

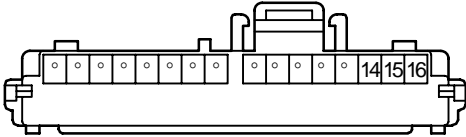

C9 (B)
(TMMK Made)

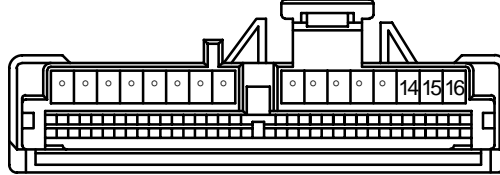

C10 (C)
(TMC Made) BROWN

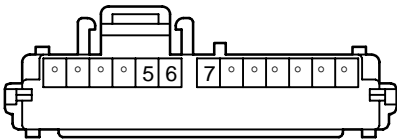

C10 (C)
(TMMK Made) BROWN

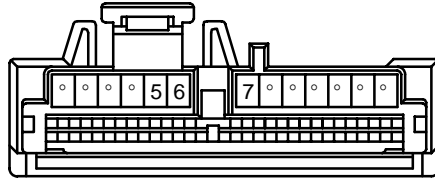

C15

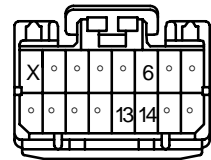

E3
GRAY



E5
DARK GRAY



E7 (A)

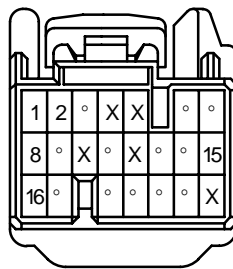

E8 (B)

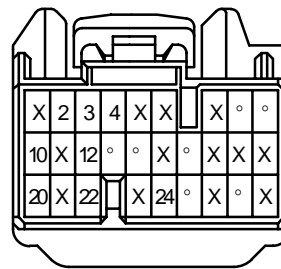

E10 (D)
(California)

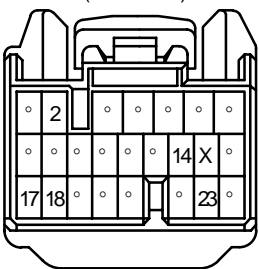

E10 (D)
(Except California) BLACK

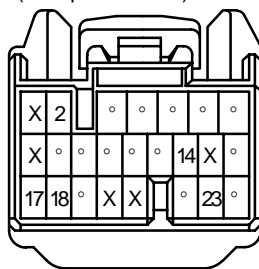

E11 (E)
(California)

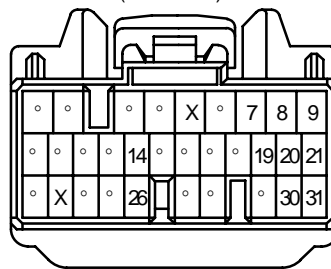

ELECTRONICALLY CONTROLLED TRANSMISSION AND A/T INDICATOR (1MZ-FE)

E11 (E)
(Except California) BLACK

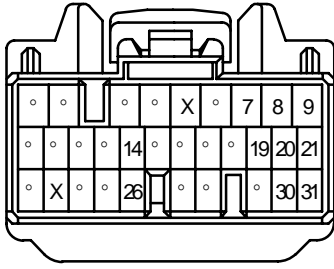

J4
BLACK



(Hint : See Page 7)

J5
ORANGE

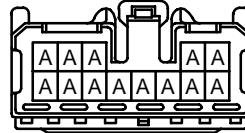

(Hint : See Page 7)

J6

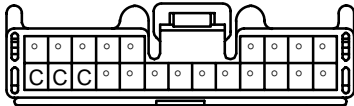

(Hint : See Page 7)

J15
BLACK

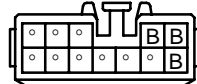

(Hint : See Page 7)

J22

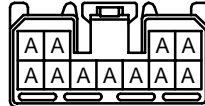

(Hint : See Page 7)

J24

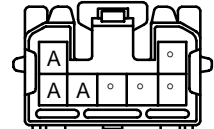

(Hint : See Page 7)

J26

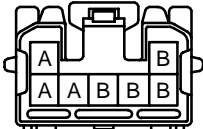

(Hint : See Page 7)

J27 (A)

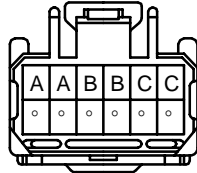

(Hint : See Page 7)

J28 (B)

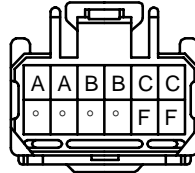

(Hint : See Page 7)

J29

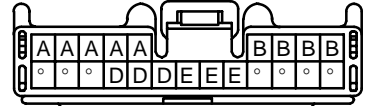

(Hint : See Page 7)

J35

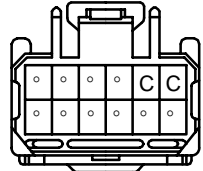

(Hint : See Page 7)

O2
BLUE

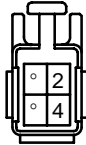

P1
GRAY

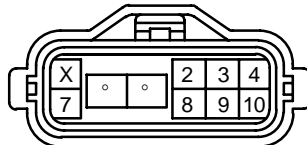

S6
BLUE

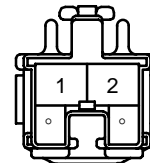

T2
BLACK



V2
BLACK



V3
BLACK

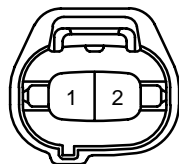

ELECTRONICALLY CONTROLLED TRANSMISSION AND AT INDICATOR

FROM POWER SOURCE SYSTEM (SEE PAGE 50)

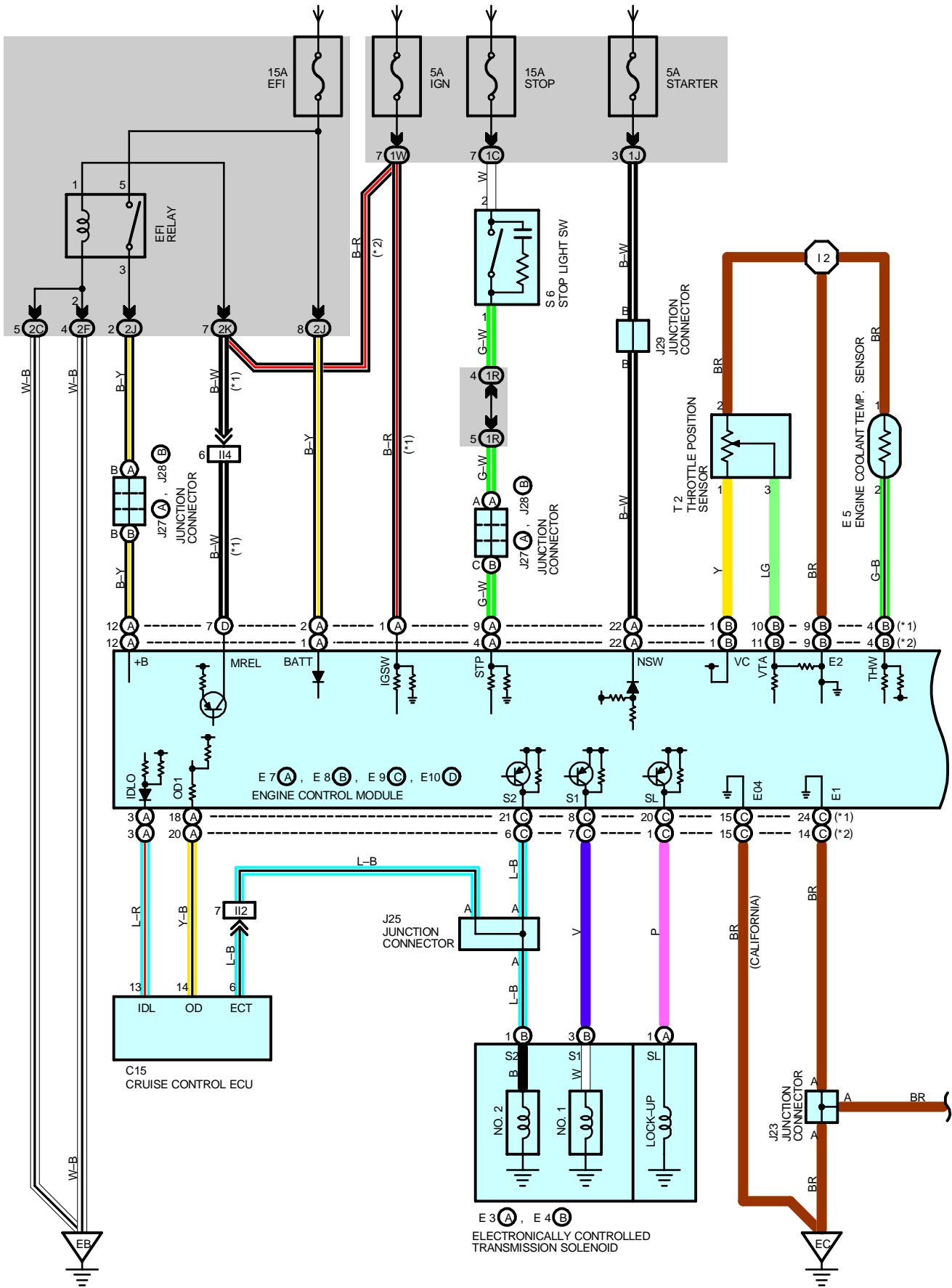

(5S-FE)

FROM POWER SOURCE SYSTEM (SEE PAGE 50)

- * 1 : W/ ENGINE IMMOBILISER SYSTEM
- * 2 : W/O ENGINE IMMOBILISER SYSTEM

- * 3 : TMC MADE
- * 4 : TMMK MADE

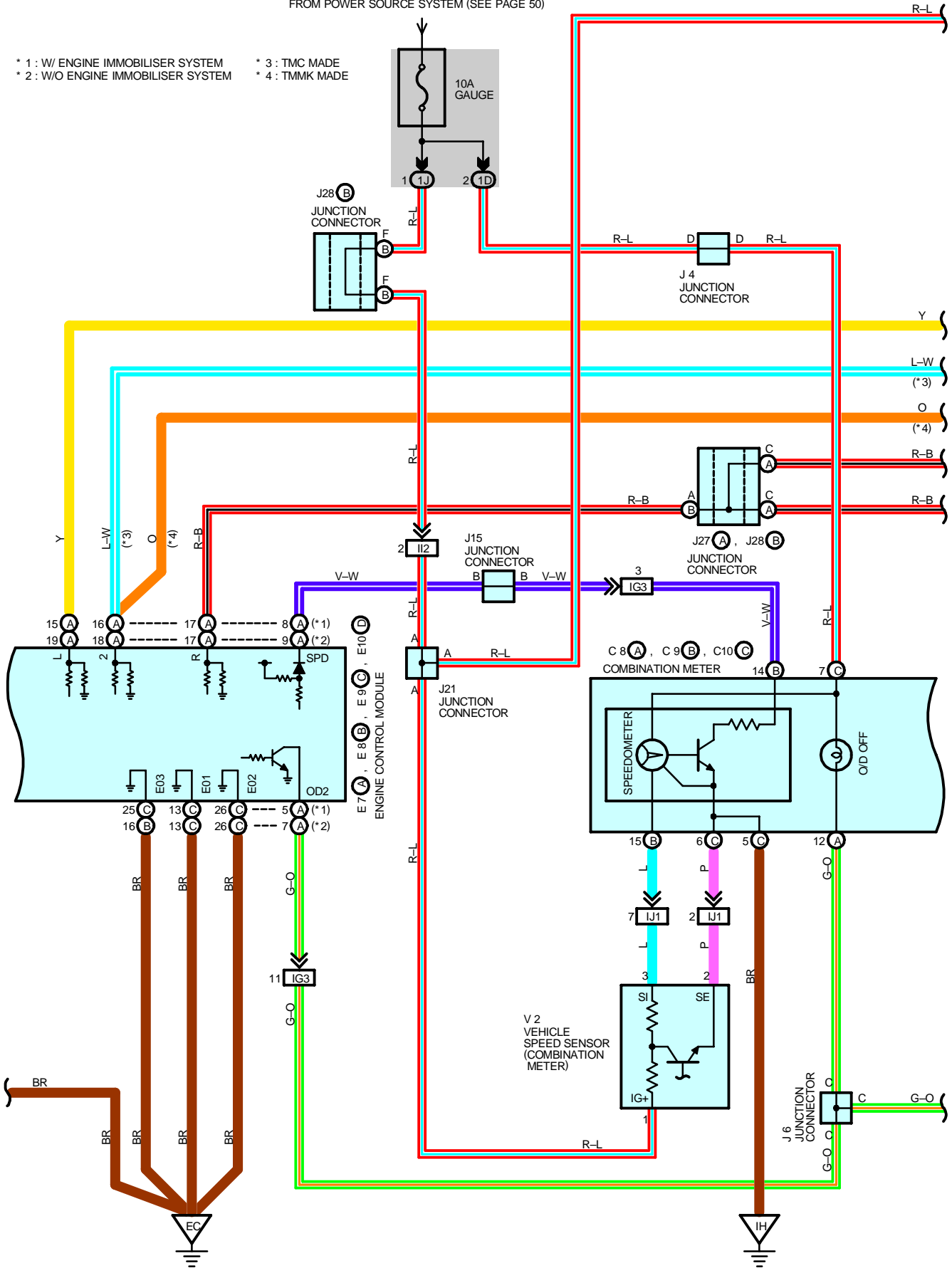

ELECTRONICALLY CONTROLLED TRANSMISSION AND A/T INDICATOR

* 3 : TMC MADE
 * 4 : TMMK MADE

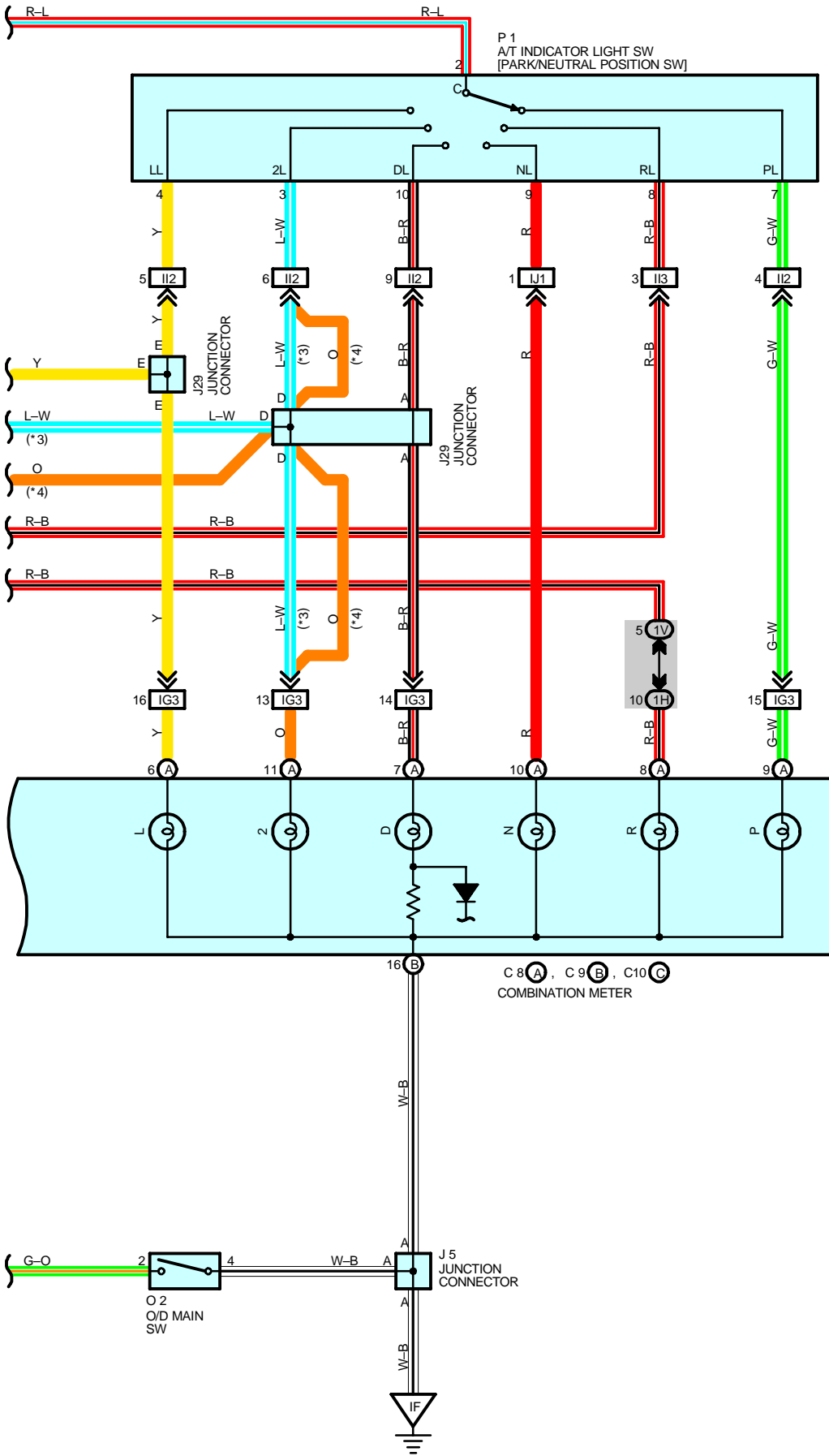

(5S-FE)

SYSTEM OUTLINE

Previous automatic transaxle have selected each gear shift using mechanically controlled throttle hydraulic pressure, governor hydraulic pressure and lock-up hydraulic pressure. The electronically controlled transmission, however, electrically controls the line pressure and lock-up pressure etc., through the solenoid valve. Engine control module controls of the solenoid valve based on the input signals from each sensor which makes smooth driving possible by shift selection for each gear which is most appropriate to the driving conditions at that time.

1. GEAR SHIFT OPERATION

During driving, the engine control module selects the shift for each gear which is most appropriate to the driving conditions, based on input signals from the engine coolant temp. sensor to TERMINAL THW of the engine control module, and also the input signals to TERMINAL SPD of the engine control module from the vehicle speed sensor devoted to the electronically controlled transmission. Current is then output to the electronically controlled transmission solenoid. When shifting to 1st speed, current flows from TERMINAL S1 of the engine control module to TERMINAL (B) 3 of the solenoid to GROUND, and continuity to the No.1 solenoid causes the shift.

For 2nd speed, current flows from TERMINAL S1 of the engine control module to TERMINAL (B) 3 of the solenoid to GROUND, and from TERMINAL S2 of the engine control module to TERMINAL (B) 1 of the solenoid to GROUND, and continuity to solenoids No.1 and No.2 causes the shift.

For 3rd speed, there is no continuity to No.1 solenoid, only to No.2, causing the shift.

Shifting into 4th speed (Overdrive) takes place when there is no continuity to either No.1 or No.2 solenoid.

2. LOCK-UP OPERATION

When the engine control module judges from each signal that lock-up operation conditions have been met, current flows from TERMINAL SL of the engine control module to TERMINAL (A) 1 of the electronically controlled transmission solenoid to GROUND, causing continuity to the lock-up solenoid and causing lock-up operation.

3. STOP LIGHT SW CIRCUIT

If the brake pedal is depressed (Stop light SW on) when driving in lock-up condition, a signal is input to TERMINAL STP of the engine control module, the engine control module operates and continuity to the lock-up solenoid is cut.

4. OVERDRIVE CIRCUIT

* O/D main SW on

When the O/D main SW is turned on (O/D off indicator light turns off), a signal is input into TERMINAL OD2 of the engine control module and engine control module operation causes gear shift when the conditions for overdrive are met.

* O/D main SW off

When the O/D main SW is turned to off, the current through the O/D off indicator light flows through the O/D main SW to GROUND, causing the indicator light to light up. At the same time, a signal is input into TERMINAL OD2 of the engine control module and engine control module operation prevents shift into overdrive.

SERVICE HINTS

E7 (A), E8 (B), E9 (C) ENGINE CONTROL MODULE (TURN ON THE IGNITION SW)

S1, S2-E1 : 9.0-14.0 volts with the solenoid on

0-1.5 volts with the solenoid off

L-E1 : 7.5-14.0 volts with the shift lever at L position

2-E1 : 7.5-14.0 volts with the shift lever at 2 position

R-E1 : 7.5-14.0 volts with the shift lever at R position

STP-E1 : 9.0-14.0 volts with the brake pedal depressed

THW-E2 : 0.2-1.0 volts with the engine coolant temp. 60°C (140°F) - 120°C (248°F)

VTA-E2 : 0.3-0.8 volts with the throttle valve fully closed

3.2-4.9 volts with the throttle valve fully opened

VC-E2 : 4.5-5.5 volts

OD2-E1 : 9.0-14.0 volts with the O/D main SW turned on

0-3.0 volts with the O/D main SW turned off

+B-E1 : 9.0-14.0 volts

E3 (A), E4 (B) ELECTRONICALLY CONTROLLED TRANSMISSION SOLENOID

(A) 1, (B) 1, (B) 3-GROUND : Each 11-15 Ω

O2 O/D MAIN SW

2-4 : Closed with the O/D main SW off, open with the O/D main SW on

ELECTRONICALLY CONTROLLED TRANSMISSION AND A/T INDICATOR

: PARTS LOCATION

Code		See Page	Code		See Page	Code		See Page
C8	A	30	E9	C	30	J27	A	31
C9	B	30	E10	D	30	J28	B	31
C10	C	30	J4		31	J29		31
C15		30	J5		31	O2		31
E3	A	28 (5S-FE)	J6		31	P1		29 (5S-FE)
E4	B	28 (5S-FE)	J15		31	S6		31
E5		28 (5S-FE)	J21		31	T2		29 (5S-FE)
E7	A	30	J23		31	V2		29 (5S-FE)
E8	B	30	J25		31			

: JUNCTION BLOCK AND WIRE HARNESS CONNECTOR

Code	See Page	Junction Block and Wire Harness (Connector Location)
1C	20	Cowl Wire and Instrument Panel J/B (Lower Finish Panel)
1D	20	Instrument Panel Wire and Instrument Panel J/B (Lower Finish Panel)
1H		
1J	20	Cowl Wire and Instrument Panel J/B (Lower Finish Panel)
1R		
1V		
1W		
2C		
2F	22	Engine Room Main Wire and Engine Room J/B No.2 (Engine Compartment Left)
2J	22	Cowl Wire and Engine Room J/B No.2 (Engine Compartment Left)
2K		

: CONNECTOR JOINING WIRE HARNESS AND WIRE HARNESS

Code	See Page	Joining Wire Harness and Wire Harness (Connector Location)
IG3	40	Instrument Panel Wire and Cowl Wire (Under the Blower Motor)
II2	42	Engine Wire and Cowl Wire (Under the Blower Motor)
II3		
II4		
IJ1	42	Engine Wire and Instrument Panel Wire (Under the Blower Motor)

: GROUND POINTS

Code	See Page	Ground Points Location
EB	38 (5S-FE)	Left Radiator Side Support
EC	38 (5S-FE)	Intake Manifold
IF	40	Left Kick Panel
IH	40	Instrument Panel Brace RH

: SPLICE POINTS

Code	See Page	Wire Harness with Splice Points	Code	See Page	Wire Harness with Splice Points
I2	42	Engine Wire			

* 1 : w/ Engine Immobiliser System
 * 2 : w/o Engine Immobiliser System

C8 (A)
 (TMC Made) BLUE

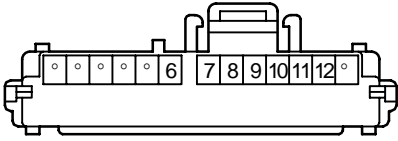

C8 (A)
 (TMMK Made) BLUE

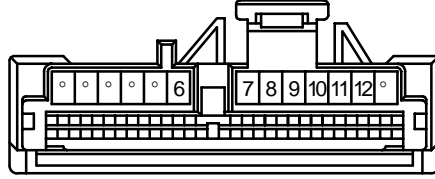

C9 (B)
 (TMC Made)

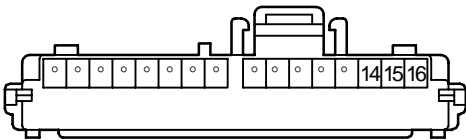

C9 (B)
 (TMMK Made)

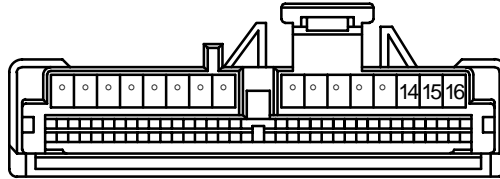

C10 (C)
 (TMC Made) BROWN

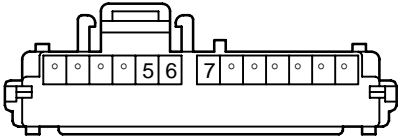

C10 (C)
 (TMMK Made) BROWN

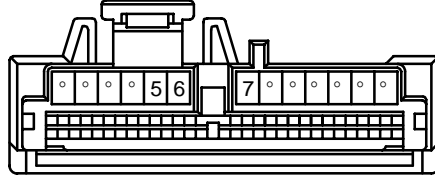

C15

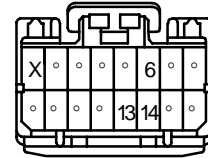

E3 (A)
 BLACK

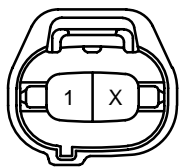

E4 (B)
 BLACK



E5
 GREEN



E7 (A)
 (* 1)

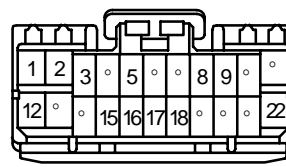

E7 (A)
 (* 2)

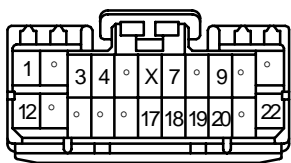

E8 (B)
 (* 1) DARK GRAY

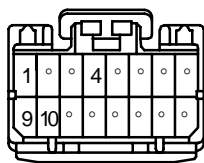

E8 (B)
 (* 2)

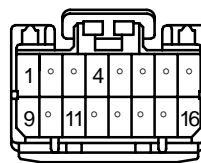

E9 (C)
 (* 1) DARK GRAY

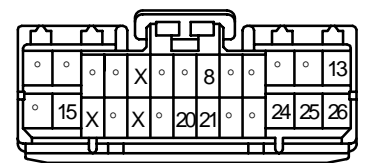

E9 (C)
 (* 2)

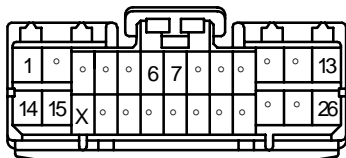

E10 (D)
 (* 1) DARK GRAY

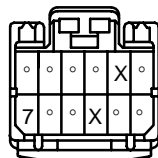

J4
 BLACK

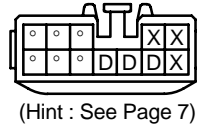

(Hint : See Page 7)

J5
 ORANGE

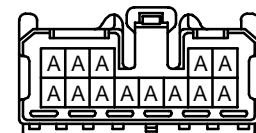

(Hint : See Page 7)

ELECTRONICALLY CONTROLLED TRANSMISSION AND A/T INDICATOR (5S-FE)

J6

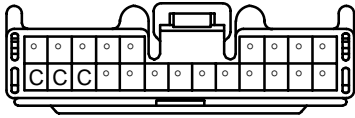

(Hint : See Page 7)

J15
BLACK

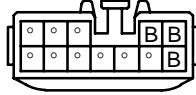

(Hint : See Page 7)

J21
GRAY

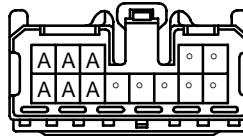

(Hint : See Page 7)

J23



(Hint : See Page 7)

J25

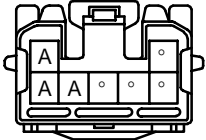

(Hint : See Page 7)

J27 (A)

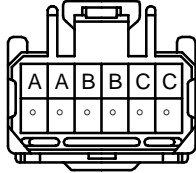

(Hint : See Page 7)

J28 (B)

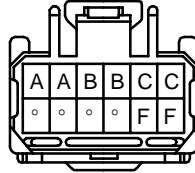

(Hint : See Page 7)

J29

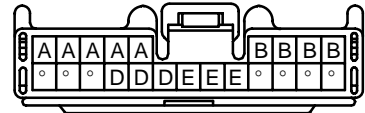

(Hint : See Page 7)

O2
BLUE

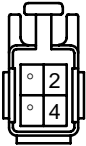

P1
GRAY

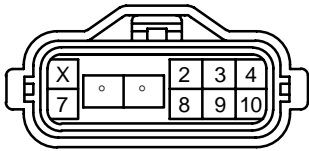

S6
BLUE

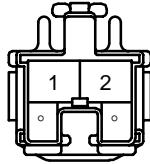

T2
BLACK



V2
BLACK



CRUISE CONTROL

FROM POWER SOURCE SYSTEM (SEE PAGE 50)

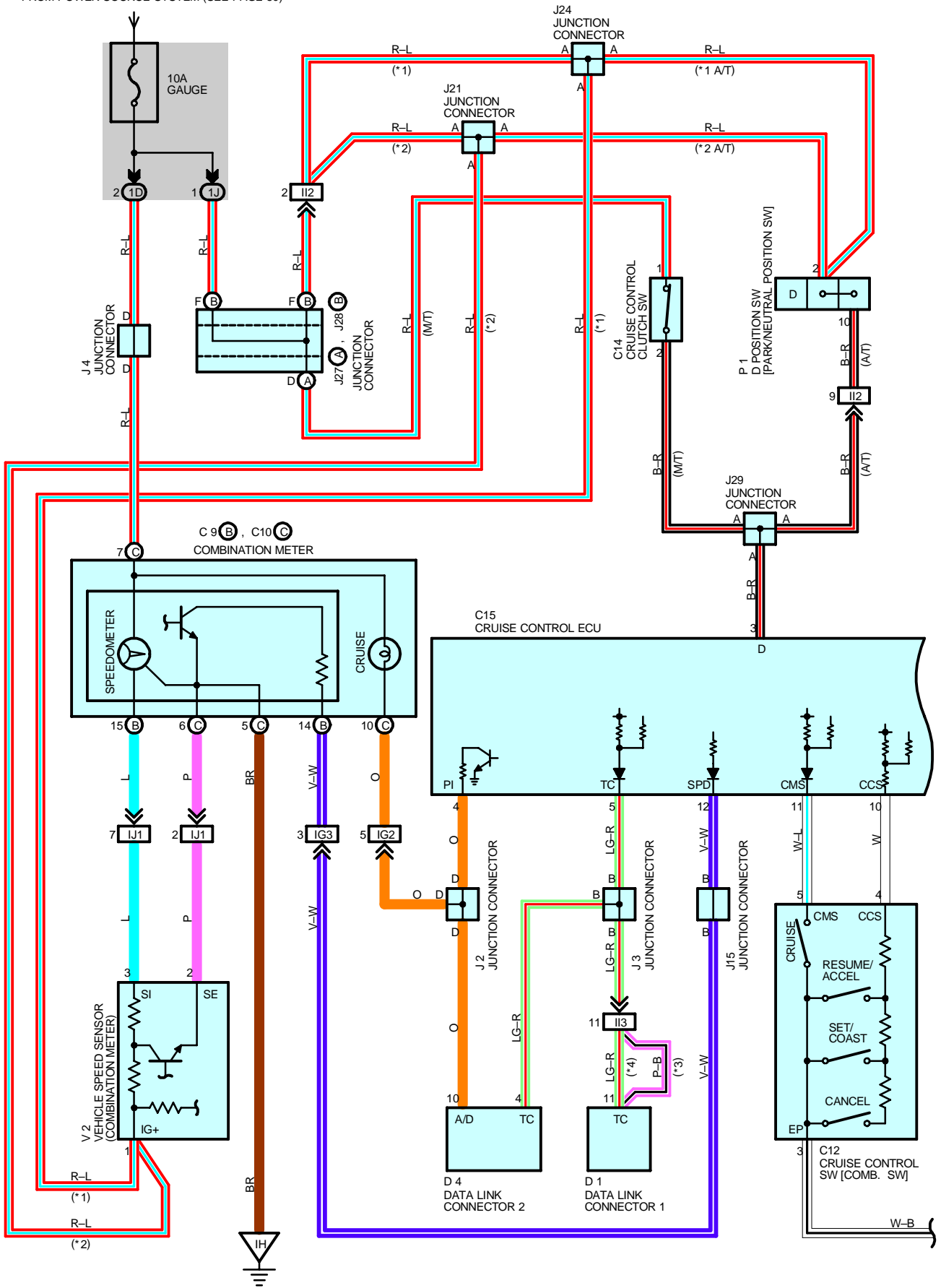

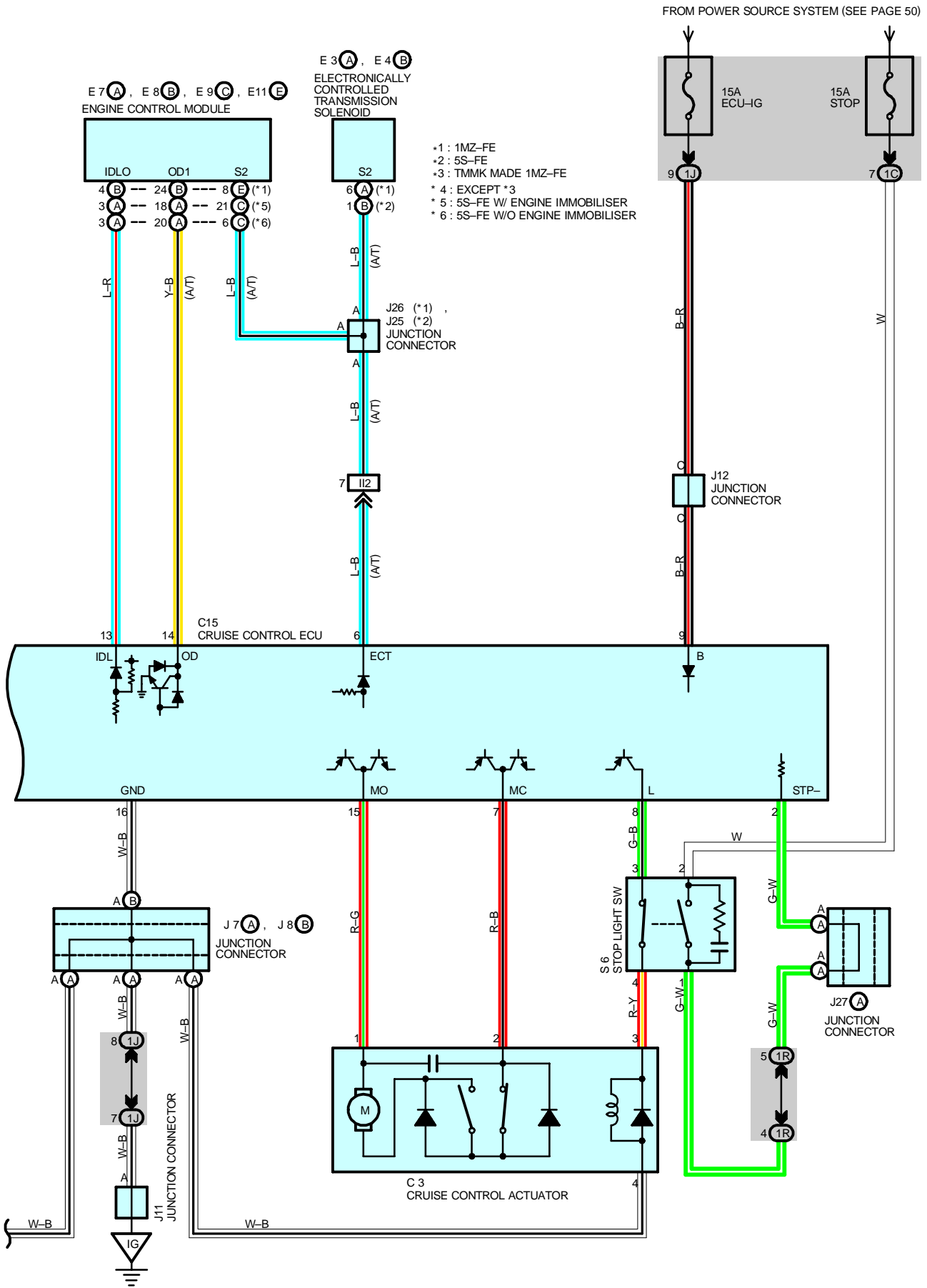

CRUISE CONTROL

SYSTEM OUTLINE

Current is applied at all times through the STOP fuse to TERMINAL 2 of the stop light SW.

With the ignition SW turned on, current flows through the GAUGE fuse to TERMINAL (C) 7 of the combination meter and the current through the ECU-IG fuse flows to TERMINAL 9 of the cruise control ECU.

When the ignition SW is on and the cruise control SW is turned on, a signal is input from TERMINAL 5 of the cruise control SW to TERMINAL 11 of the cruise control ECU. As a result, the cruise control ECU functions and the current flows from the ECU-IG fuse to TERMINAL 9 of the cruise control ECU to TERMINAL 16 to GROUND, and the cruise control system is in a condition ready for operation.

At the same time, the current through the GAUGE fuse flows to TERMINAL (C) 7 of the cruise control indicator light to TERMINAL (C) 10 to TERMINAL 4 of the cruise control ECU to TERMINAL 16 to GROUND, causing the cruise control indicator light to light up, indicating that cruise control is ready for operation.

1. SET OPERATION

When the cruise control SW is turned on and the set SW is pushed with the vehicle speed within the set limit (Approx. 40 km/h, 25 mph to 200 km/h, 124 mph), a signal is input to TERMINAL 10 of the cruise control ECU and the vehicle speed at the time the set SW is released is memorized in the ECU as the set speed.

2. SET SPEED CONTROL

During cruise control driving, the cruise control ECU compares the set speed memorized in the cruise control ECU with the actual vehicle speed input into TERMINAL 12 of the cruise control ECU from the speed sensor, and controls the cruise control actuator to maintain the set speed.

When the actual speed is lower than the set speed, the ECU causes the current to the cruise control actuator to flow from TERMINAL 15 of the cruise control ECU to TERMINAL 1 of the cruise control actuator to TERMINAL 2 to TERMINAL 7 of the cruise control ECU. As a result, the motor in the cruise control actuator is rotated to open the than the set speed, the current to the cruise control actuator flows from TERMINAL 7 of the cruise control ECU to TERMINAL 2 of the cruise control actuator to TERMINAL 1 to TERMINAL 15 of the cruise control ECU.

This causes the motor in the cruise control actuator to rotate to close the throttle valve and return the throttle cable to decrease the vehicle speed.

3. COAST CONTROL

During cruise control driving, while the coast SW is on, the cruise control actuator returns the throttle cable to close the throttle valve and decrease the driving speed. The vehicle speed when the coast SW is turned off is memorized and the vehicle continues at the new set speed.

4. ACCEL CONTROL

During cruise control driving, while the accel SW is turned on, the cruise control actuator pulls the throttle cable to open the throttle valve and increase the driving speed.

The vehicle speed when the accel SW is turned off is memorized and the vehicle continues at the new set speed.

5. RESUME CONTROL

Unless the vehicle speed falls below the minimum speed limit (Approx. 40km/h, 25mph) after canceling the set speed by the cancel SW, pushing the resume SW will cause the vehicle to resume the speed set before cancellation.

6. MANUAL CANCEL MECHANISM

If any of the following operations occurs during cruise control operation, the magnetic clutch of the actuator turns off and the motor rotates to close the throttle valve and the cruise control is released.

- * Placing the shift lever except D position (Park/Neutral position SW except D position). "Signal is not input to TERMINAL 3 of the cruise control ECU" (A/T)
- * Depressing the clutch pedal (Cruise control clutch SW off). "Signal input to TERMINAL 3 of the cruise control ECU" (M/T)
- * Depressing the brake pedal (Stop light SW on). "Signal input to TERMINAL 2 of the cruise control ECU"
- * Pushing the cancel switch (Cancel SW on). "Signal input to TERMINAL 10 of the cruise control ECU"
- * Pushing the cruise switch off "signal input to TERMINAL 11 of the cruise control ECU".

7. TAP-UP CONTROL FUNCTION

When the difference between the actual vehicle speed and the set speed is less than 5 km/h (3 mph), the set speed can be increased 1.6 km/h (1 mph) each time by operation the RESUME/ACCEL SW quickly within 0.6 seconds.

8. TAP-DOWN CONTROL FUNCTION

When the difference between the actual vehicle speed and the set speed is less than 5 km/h (3 mph), the set speed can be lowered 1.6 km/h (1 mph) each time by operating the SET/COAST SW quickly within 0.6 seconds.

9. AUTO CANCEL FUNCTION

A) If any of the following operating conditions occurs during cruise control operation, the set speed is erased, the current flow to the magnetic clutch is stopped and the cruise control is released. (Cruise SW turns off).

When this occurs, the ignition SW must be turned off once before the cruise SW will turn on.

- * When current continued to flow to the motor inside the actuator in the throttle valve "OPEN" direction.
- * The motor does not operate despite the motor drive signal being output.

B) If any of the following operating conditions occurs during cruise control operation, the set speed is erased, the current flow to the magnetic clutch is stopped and the cruise control is released. (Cruise SW turn off).

When this occurs, the cancel state is cleared as the cruise SW will turn on again.

- * Over current to transistor driving the motor and/or the magnetic clutch.
- * Open circuit in the magnetic clutch.
- * Momentary interruption of vehicle speed signal.
- * Short circuit in the cruise control SW.
- * When the vehicle speed falls more than 16 km/h (10 mph) below the set speed, E.G. on an upward slope.

C) If any of the following conditions occurs during cruise control operation, the set speed is erased and the cruise control is released. (The power to the magnetic clutch is cut off until the set SW is ON again.)

- * When the vehicle speed falls below the minimum speed limit, approx. 40 km/h (25 mph).
- * When power to the cruise control system is momentarily cut off.

D) If any of the following conditions occurs during cruise control operation, the cruise control is released.

- * Open the circuit for TERMINAL 2 of the stop light SW.

10. AUTOMATIC TRANSAXLE CONTROL FUNCTION

* In overdrive. If the vehicle speed becomes lower than the overdrive cut speed (Set speed minus approx. 4 km/h, 2.5 mph) during cruise control operation, such as driving up a hill, the overdrive is released and the power increased to prevent a reduction in vehicle speed.

* After releasing the overdrive, vehicle speed becomes higher than the overdrive return speed (Set speed minus approx. 2 km/h, 1.2 mph) and the cruise control ECU judges by the signals from the actuator's potentiometer that the upward slope has finished, the overdrive is resumed after approximately 2 seconds.

* During cruise control driving, the cruise control operation signal is output from the cruise control ECU to the engine control module. Upon receiving this signal, the engine control module changes the shift pattern to normal.

To maintain smooth cruise control operation (on a downward slope etc.), the lock-up release of the transmission when the idling point of the throttle position is ON is forbidden.

SERVICE HINTS

C3 CRUISE CONTROL ACTUATOR

3-4 : Approx. **38.5** Ω

C12 CRUISE CONTROL SW [COMB. SW]

5-3 : Continuity with the CRUISE SW on

4-3 : Approx. **418** Ω with the CANCEL SW on
Approx. **68** Ω with the RESUME/ACCEL SW on
Approx. **198** Ω with the SET/COAST SW on

C15 CRUISE CONTROL ECU

9-GROUND : **10-14** volts with the ignition SW at **ON** position

12-GROUND : **4** pulses with **1** rotation of rotor shaft

10-GROUND : Approx. **418** Ω with the CANCEL SW on in the cruise control SW
Approx. **198** Ω with the SET/COAST SW on in the cruise control SW
Approx. **68** Ω with the RESUME/ACCEL SW on in the cruise control SW

16-GROUND : Always continuity

CRUISE CONTROL

: PARTS LOCATION

Code		See Page	Code		See Page	Code		See Page
C3		26 (1MZ-FE)	E7	A	30	J21	31	
		28 (5S-FE)	E8	B	30	J24	31	
C9	B	30	E9	C	30	J25	31	
C10	C	30	E11	E	30	J26	31	
C12		30	J2		31	J27	A	31
C14		30	J3		31	J28	B	31
C15		30	J4		31	J29		31
D1		26 (1MZ-FE)	J7	A	31	P1		27 (1MZ-FE)
		28 (5S-FE)	J8	B	31			29 (5S-FE)
D4		30	J11		31	S6		31
E3	A	26 (1MZ-FE)	J12		31	V2		27 (1MZ-FE)
E4	B	28 (1S-FE)	J15		31			29 (5S-FE)

: JUNCTION BLOCK AND WIRE HARNESS CONNECTOR

Code	See Page	Junction Block and Wire Harness (Connector Location)
1C	20	Cowl Wire and Instrument Panel J/B (Lower Finish Panel)
1D	20	Instrument Panel Wire and Instrument Panel J/B (Lower Finish Panel)
1J	20	Cowl Wire and Instrument Panel J/B (Lower Finish Panel)
1R		

: CONNECTOR JOINING WIRE HARNESS AND WIRE HARNESS

Code	See Page	Joining Wire Harness and Wire Harness (Connector Location)
IG2	40	Instrument Panel Wire and Cowl Wire (Lower Finish Panel)
IG3	40	Instrument Panel Wire and Cowl Wire (Under the Blower Motor)
II2	42	Engine Wire and Cowl Wire (Under the Blower Motor)
II3		
IJ1	42	Engine Wire and Instrument Panel Wire (Under the Blower Motor)

: GROUND POINTS

Code	See Page	Ground Points Location
IG	40	Instrument Panel Brace LH
IH	40	Instrument Panel Brace RH

CRUISE CONTROL

E9 (C)
(5S-FE w/o Engine Immobiliser System)

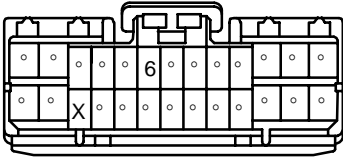

E11 (E)
(1MZ-FE Except California) BLACK

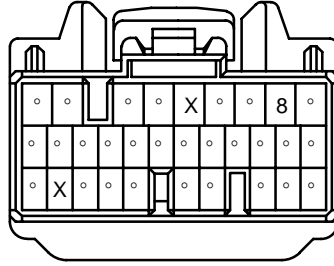

E11 (E)
(1MZ-FE California)

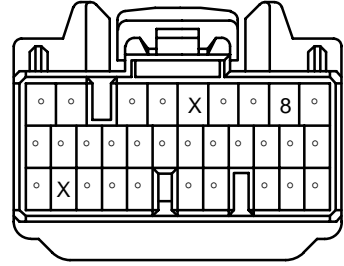

J2
BLACK

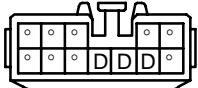

(Hint : See Page 7)

J3

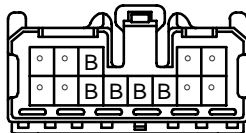

(Hint : See Page 7)

J4
BLACK

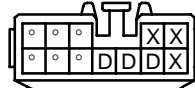

(Hint : See Page 7)

J7 (A)
GRAY

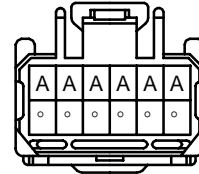

(Hint : See Page 7)

J8 (B)
GRAY

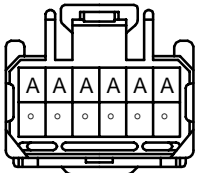

(Hint : See Page 7)

J11

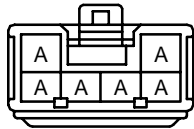

(Hint : See Page 7)

J12
BLACK

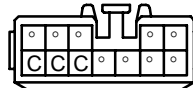

(Hint : See Page 7)

J15
BLACK

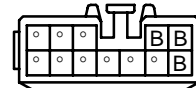

(Hint : See Page 7)

J21
GRAY

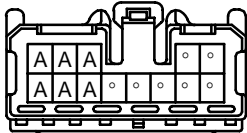

(Hint : See Page 7)

J24

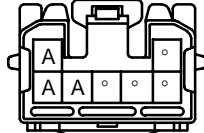

(Hint : See Page 7)

J25

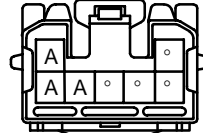

(Hint : See Page 7)

J26

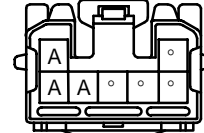

(Hint : See Page 7)

J27 (A)

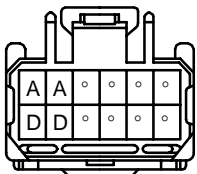

(Hint : See Page 7)

J28 (B)

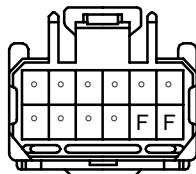

(Hint : See Page 7)

J29

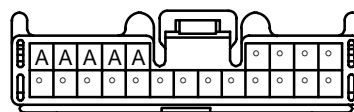

(Hint : See Page 7)

P1
GRAY

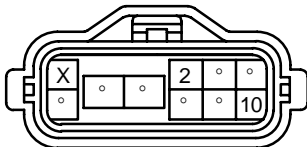

S6
BLUE

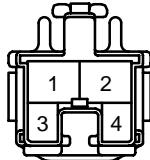

V2
BLACK



ABS AND TRACTION CONTROL

FROM POWER SOURCE SYSTEM (SEE PAGE 50)

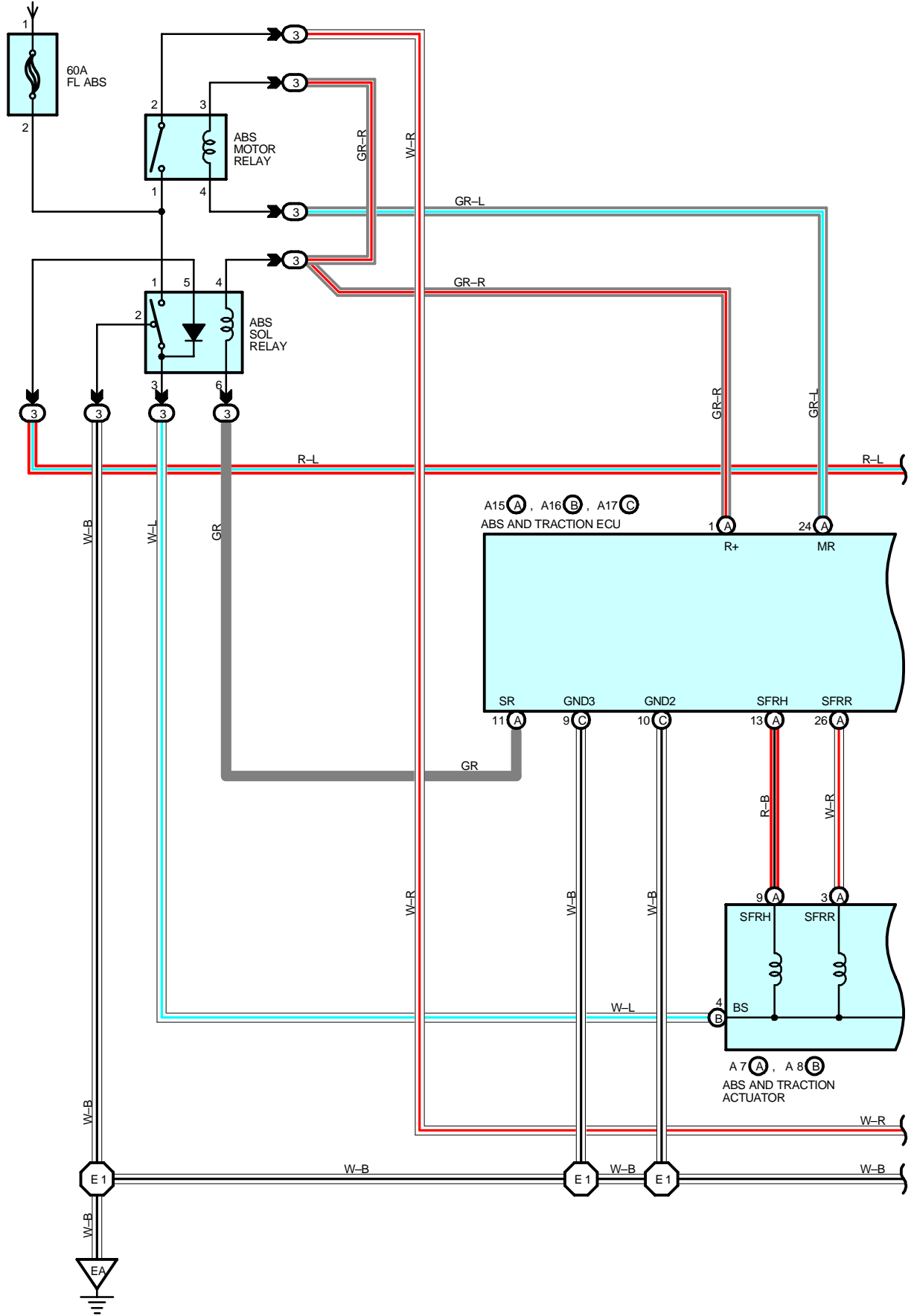

FROM POWER SOURCE SYSTEM (SEE PAGE 50)

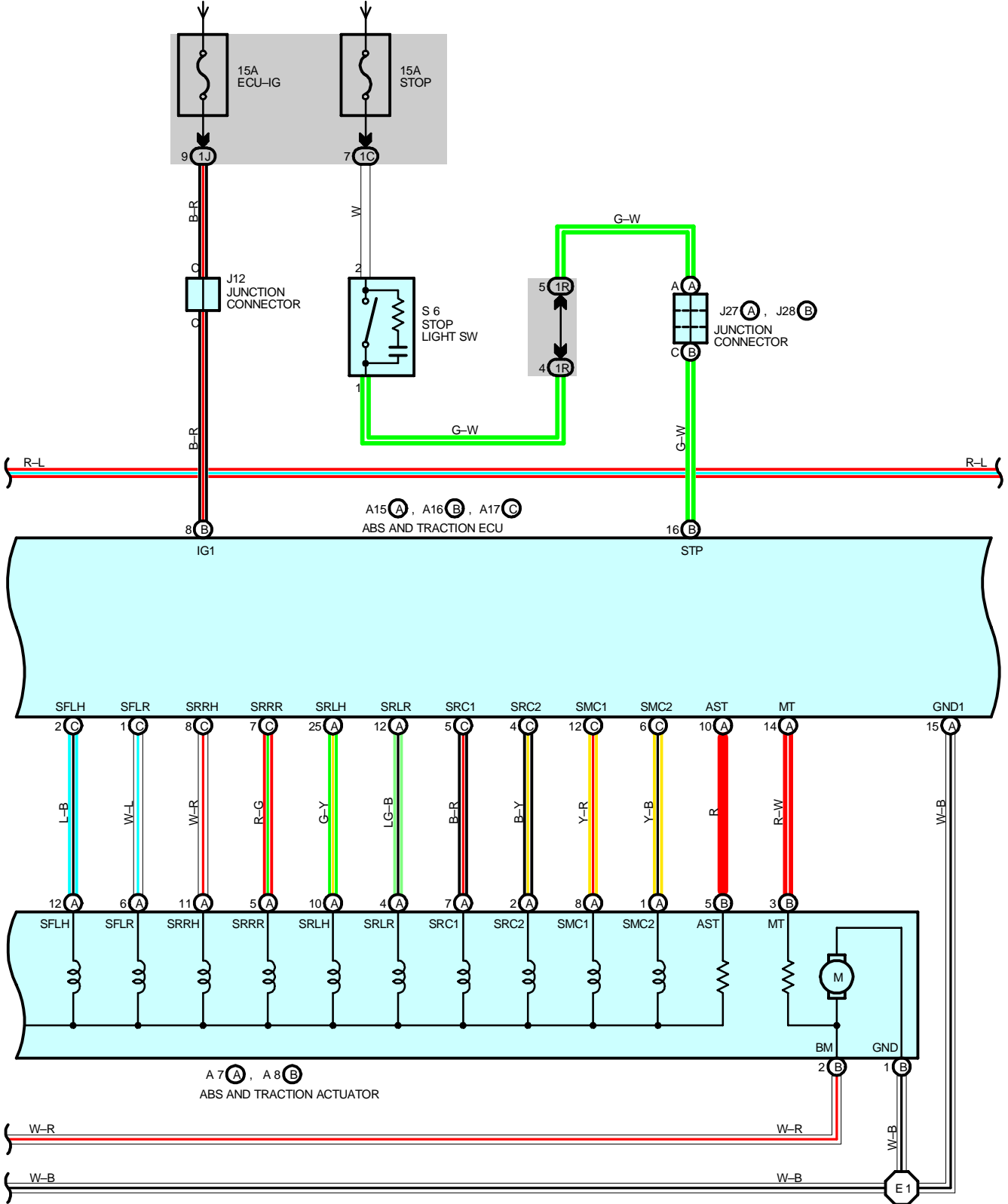

FROM POWER SOURCE SYSTEM (SEE PAGE 50)

* 1 : TMC MADE
* 2 : TMMK MADE

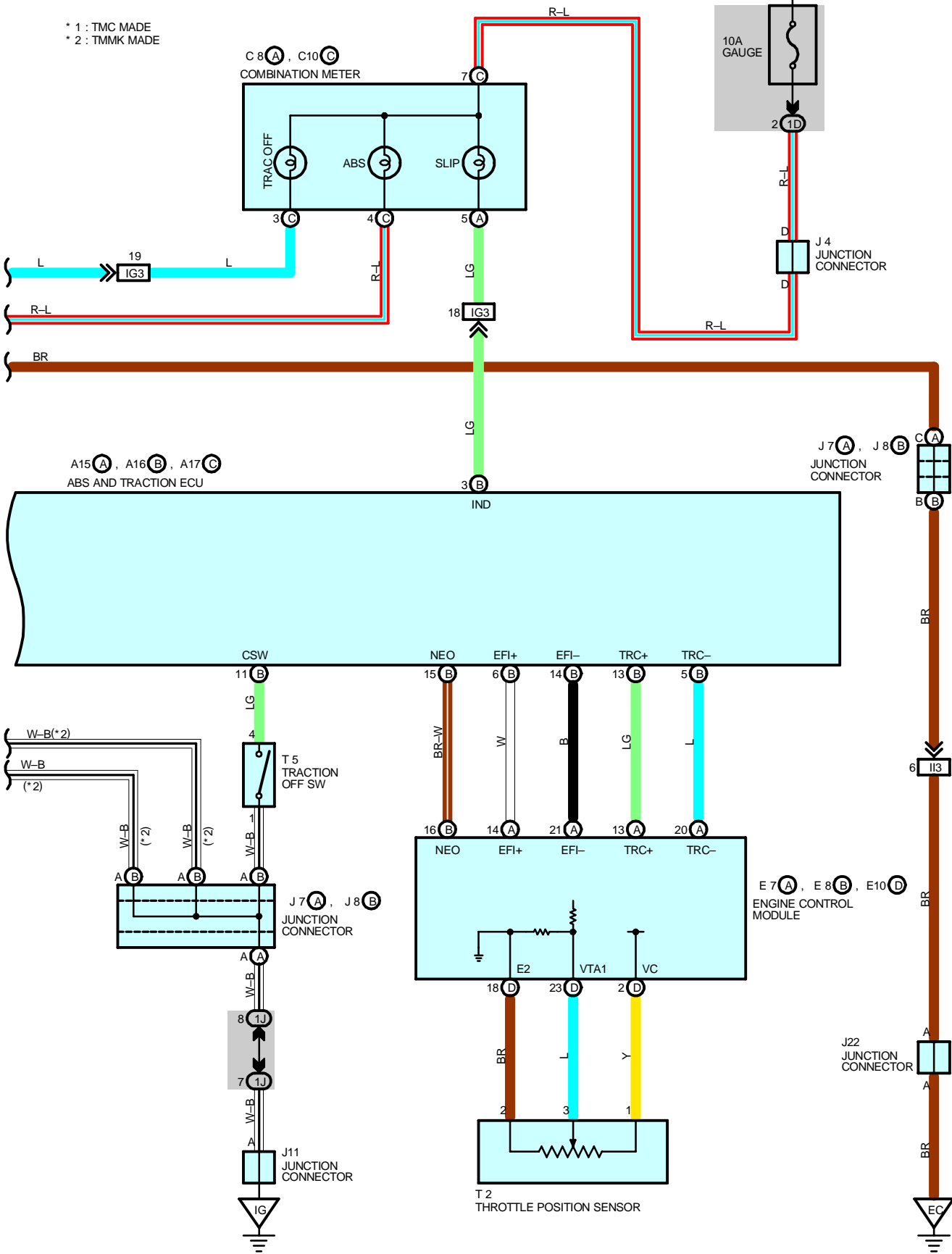

ABS AND TRACTION CONTROL

SYSTEM OUTLINE

(ABS)

ABS is a brake system designed for the purpose to improve the operating ability securing the stability of the vehicle by preventing the locking-up of the vehicle controlling the wheel cylinder pressure of all the four wheels at the time of sudden braking.

1. INPUT SIGNALS

(1) Speed sensor signal

The speed of the wheels is detected and input to TERMINALS FL+, FR+, RL+, and RR+ of the ABS and traction ECU.

(2) Stop light SW signal

A signal is input to TERMINAL STP of the ABS and traction ECU when brake pedal is depressed.

2. SYSTEM OPERATION

When the wheels are to be locked-up, the solenoid inside the actuator will be controlled by the signal from the ABS and traction ECU and the brake fluid in the wheel cylinder will flow through the reservoir and reduce the hydraulic pressure.

While the ABS is in operation, as the ABS and traction ECU always outputs the operation signal to the pump inside the actuator, brake fluid stored inside the reservoir will be suctioned up by the pump inside the actuator and returned to the master cylinder.

When the hydraulic pressure of the wheel cylinder is decompressed or increased until the necessary hydraulic pressure, the solenoid inside the actuator is controlled by the control signal from the ABS and traction ECU and as a result, hydraulic pressure of the wheel cylinder will be closed at both routes of the master cylinder and reservoir sides and the hydraulic pressure of the wheel cylinder will become to be in the holding condition.

If the increase of hydraulic pressure volume of the wheel cylinder becomes necessary, with the control signal from the ABS and traction ECU, the solenoid inside the actuator will be controlled and become the same condition as usual and the brake fluid of the master cylinder will be sent to the wheel cylinder and will increase the hydraulic pressure of the wheel cylinder. At this time, in the case that the brake fluid stays left in the reservoir, it will be sucked up by the pump inside the actuator and will be sent to the wheel cylinder.

Also, increasing speed of the hydraulic pressure is controlled by outputting the increasing and the said holding one after another.

(Traction control)

Traction control system is designed to perform the engine output control by the fuel cut and hydraulic pressure control of driving wheel brake and control the spinning of the driving wheels. By doing this, it improves starting acceleration and operating ability of the vehicle securing the driving ability in accordance with the road surface condition.

3. TRACTION CONTROL OPERATION

Estimating the vehicle speed from the rear wheel speed, comparing it with the front, driving wheel speed and judging the grip condition of the driving wheels. From the estimated vehicle speed, target speed of the driving speed will be set. When the front, driving wheel speed exceeds the control starting speed, it judges that the tire slip is occurred and performs the fuel cut cylinder number control and brake control and then adjust to make the front wheel speed become the traction control target speed. Controlling of the traction control will be completed when the vehicle move onto the road where the driving wheels will not have a tire slip or when the driver decelerate.

SERVICE HINTS

ABS MOTOR RELAY [R/B NO.3]

3-4 : Approx. 62 Ω

ABS SOL RELAY [R/B NO.3]

4-6 : Approx. 80 Ω

A9, A10 ABS SPEED SENSOR FRONT LH, RH

1-2 : 0.6 k Ω -2.5 k Ω

A15 (A), A16 (B), A17 (C) ABS AND TRACTION ECU

(B) 8-GROUND : Approx. 12 volts with the ignition SW at ON position

(B)11-GROUND : Continuity with the ignition SW on and the traction off SW on (Traction control off)

(B)16-GROUND : Approx. 12 volts with the brake pedal depressed

(A)15, (C) 9, (C) 10-GROUND : Always continuity

A25, A26 ABS SPEED SENSOR REAR LH, RH

1-2 : 1.2 k Ω -2.3 k Ω

T2 THROTTLE POSITION SENSOR

1-2 : 3.5 k Ω -5.0 k Ω

 : PARTS LOCATION

Code		See Page	Code		See Page	Code		See Page
A7	A	26 (1MZ-FE)	C10	C	30	J11	31	
A8	B	26 (1MZ-FE)	D1		26 (1MZ-FE)	J12	31	
A9		26 (1MZ-FE)	D4		30	J22	31	
A10		26 (1MZ-FE)	E7	A	30	J27	A 31	
A15	A	30	E8	B	30	J28	B 31	
A16	B	30	E10	D	30	J29 31		
A17	C	30	J3		31	J32 31		
A25		32	J4		31	S6 31		
A26		32	J7	A	31	T2 27 (1MZ-FE)		
C8	A	30	J8	B	31	T5 31		

 : RELAY BLOCKS

Code	See Page	Relay Blocks (Relay Block Location)
3	25	Engine Room R/B No.3 (Radiator Upper Support RH)

 : JUNCTION BLOCK AND WIRE HARNESS CONNECTOR

Code	See Page	Junction Block and Wire Harness (Connector Location)
1C	20	Cowl Wire and Instrument Panel J/B (Lower Finish Panel)
1D	20	Instrument Panel Wire and Instrument Panel J/B (Lower Finish Panel)
1J	20	Cowl Wire and Instrument Panel J/B (Lower Finish Panel)
1R		

 : CONNECTOR JOINING WIRE HARNESS AND WIRE HARNESS

Code	See Page	Joining Wire Harness and Wire Harness (Connector Location)
ID1	40	Floor Wire and Cowl Wire (Left Kick Panel)
IG3	40	Instrument Panel Wire and Cowl Wire (Under the Blower Motor)
II3	42	Engine Wire and Cowl Wire (Under the Blower Motor)
IK1	42	Engine Room Main Wire and Cowl Wire (Right Kick Panel)
IK2		
IL1	42	Floor No.2 Wire and Cowl Wire (Right Kick Panel)

 : GROUND POINTS

Code	See Page	Ground Points Location
EA	36 (1MZ-FE)	Right Radiator Side Support
EC	36 (1MZ-FE)	Surge Tank RH
IG	40	Instrument Panel Brace LH

 : SPLICE POINTS

Code	See Page	Wire Harness with Splice Points	Code	See Page	Wire Harness with Splice Points
E1	36 (1MZ-FE)	Engine Room Main Wire			

ABS AND TRACTION CONTROL

A7 (A)
BLACK

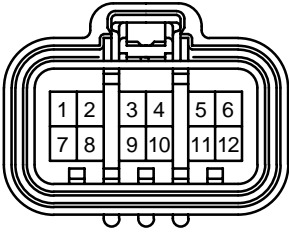

A8 (B)
GRAY

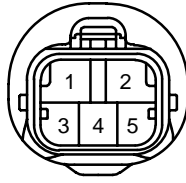

A9
GRAY



A10
GRAY



A15 (A)

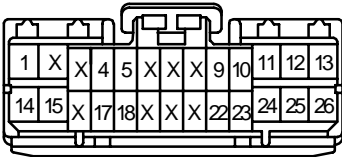

A16 (B)

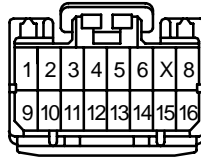

A17 (C)

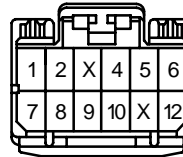

A25



A26



C8 (A)
(TMC Made) BLUE

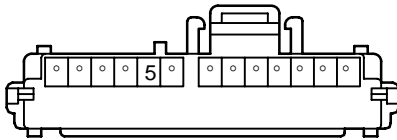

C8 (A)
(TMMK Made) BLUE

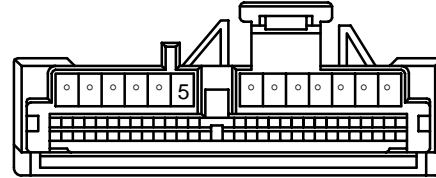

C10 (C)
(TMC Made) BROWN

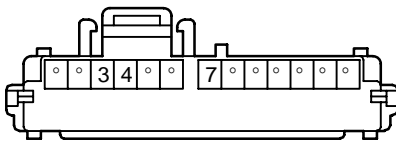

C10 (C)
(TMMK Made) BROWN

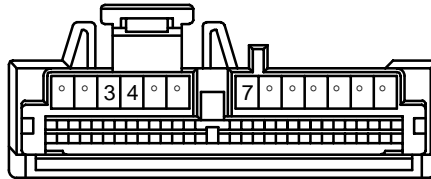

D1
BLACK

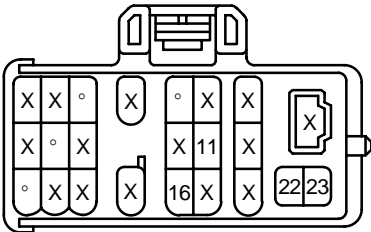

D4
DARK GRAY

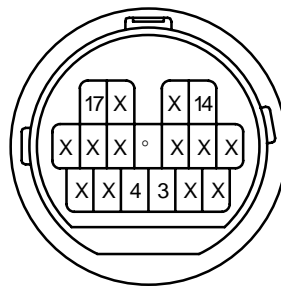

E7 (A)

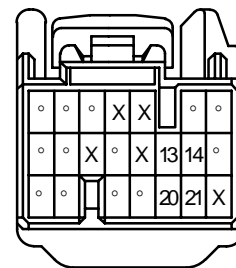

E8 (B)

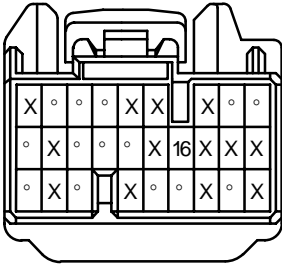

E10 (D)
(California)

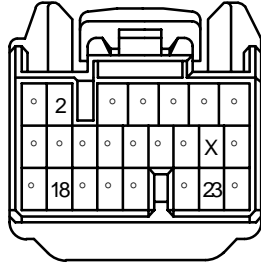

E10 (D)
(Except California) BLACK

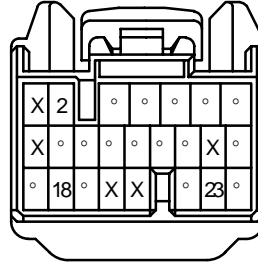

J3

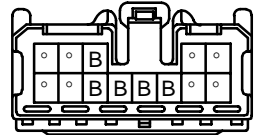

(Hint : See Page 7)

J4
BLACK

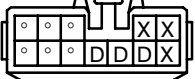

(Hint : See Page 7)

J7 (A)
GRAY

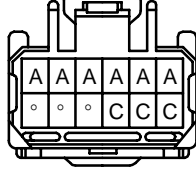

(Hint : See Page 7)

J8 (B)
GRAY

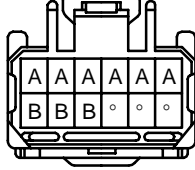

(Hint : See Page 7)

J11

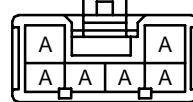

(Hint : See Page 7)

J12
BLACK

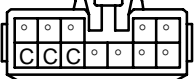

(Hint : See Page 7)

J22



(Hint : See Page 7)

J27 (A)

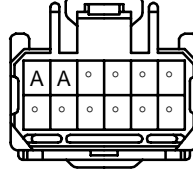

(Hint : See Page 7)

J28 (B)

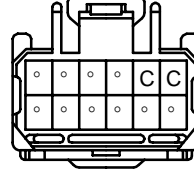

(Hint : See Page 7)

J29

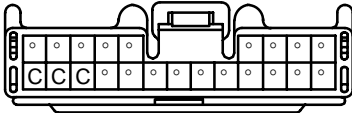

(Hint : See Page 7)

J32
GRAY

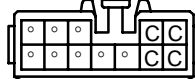

(Hint : See Page 7)

S6
BLUE

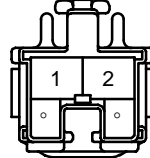

T2
BLACK



T5
BLACK

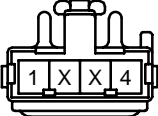

ABS (TMC MADE)

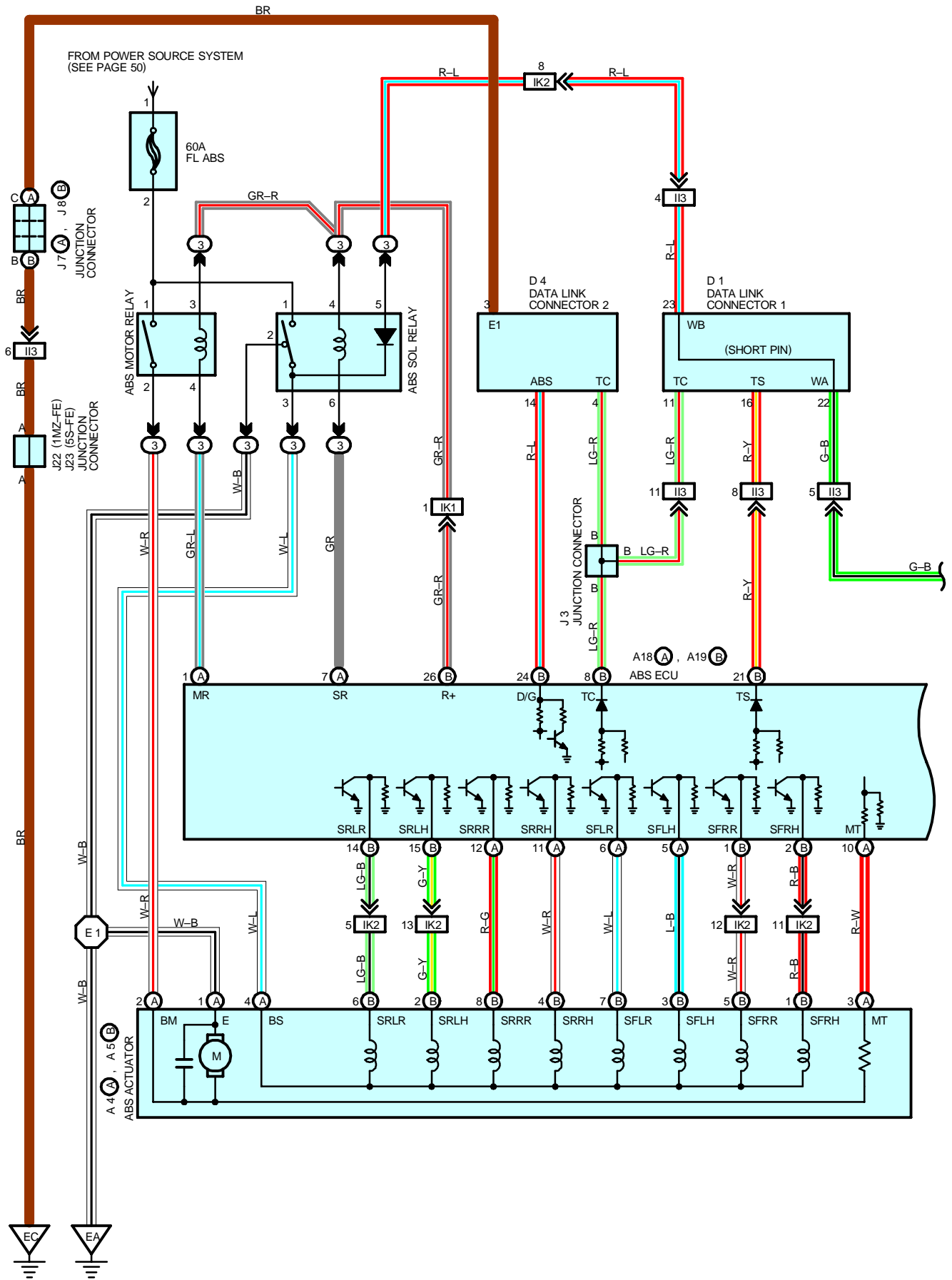

ABS (TMC MADE)

SYSTEM OUTLINE

This system controls the respective brake fluid pressures acting on the disc brake cylinders of the right front wheel, left front wheel and rear wheels when the brakes are applied in a panic stop so that the wheels do not lock. This results in improved directional stability and steerability during panic braking.

1. INPUT SIGNALS

(1) Speed sensor signal

The speed of the wheels is detected and input to TERMINALS FL+, FR+, RL+ and RR+ of the ABS ECU.

(2) Stop light SW signal

A signal is input to TERMINAL STP of the ABS ECU when the brake pedal is depressed.

2. SYSTEM OPERATION

During sudden braking the ABS ECU has signals input from each sensor, which controls the current to the solenoid inside the actuator and lets the hydraulic pressure acting on each wheel cylinder escape to the reservoir. The pump inside the actuator is also operating at this time and it returns the brake fluid from the reservoir to the master cylinder, thus preventing locking of the vehicle wheels.

If the ABS ECU judges that the hydraulic pressure acting on the wheel cylinder is insufficient, the current on the solenoid is controlled and the hydraulic pressure is increased. Holding of the hydraulic pressure is also controlled by the ABS ECU, by the same method as above. Pressure reduction, holding and increase are repeated to maintain vehicle stability and to improve steerability during sudden braking.

SERVICE HINTS

A9, A10 ABS SPEED SENSOR FRONT LH, RH

2-1 : 0.6 kΩ-2.5 kΩ

A25, A26 ABS SPEED SENSOR REAR LH, RH

2-1 : 1.2 kΩ-2.3 kΩ

A18 (A), A19 (B) ABS ECU

(Connect the ABS ECU connectors)

(B)21-GROUND : Approx. 12 volts with the ignition SW at **ON** position and the data link connector 1
TS-E1, TC-E1 not connected

(B) 8-GROUND : Approx. 12 volts with the ignition SW at **ON** position and the data link connector 1
TS-E1, TC-E1 not connected

(B)13-GROUND : Approx. 12 volts with the ignition SW at **ON** position

(B) 5-GROUND : Approx. 12 volts with the brake pedal depressed

(B)12, (B) 25-GROUND :

Always continuity

○ : PARTS LOCATION

Code		See Page	Code		See Page	Code		See Page
A4	A	26 (1MZ-FE)	A25	32	J11	31		
		28 (5S-FE)	A26	32	J12	31		
A5	B	26 (1MZ-FE)	C10	30	J22	31		
		28 (5S-FE)	D1	26 (1MZ-FE)	J23	31		
A9		26 (1MZ-FE)		D4	28 (5S-FE)	J27	A	31
		28 (5S-FE)	30		J28	B	31	
A10		26 (1MZ-FE)	J3	31	J29	31		
		28 (5S-FE)	J4	31	S6	31		
A18	A	30	J7	A	31			
A19	B	30	J8	B	31			

○ : RELAY BLOCKS

Code	See Page	Relay Blocks (Relay Block Location)
3	25	Engine Room R/B No.3 (Radiator Upper Support RH)

○ : JUNCTION BLOCK AND WIRE HARNESS CONNECTOR

Code	See Page	Junction Block and Wire Harness (Connector Location)
1C	20	Cowl Wire and Instrument Panel J/B (Lower Finish Panel)
1D	20	Instrument Panel Wire and Instrument Panel J/B (Lower Finish Panel)
1J	20	Cowl Wire and Instrument Panel J/B (Lower Finish Panel)
1R		

□ : CONNECTOR JOINING WIRE HARNESS AND WIRE HARNESS

Code	See Page	Joining Wire Harness and Wire Harness (Connector Location)
ID1	40	Floor Wire and Cowl Wire (Left Kick Panel)
IG3	40	Instrument Panel Wire and Cowl Wire (Under the Blower Motor)
II3	42	Engine Wire and Cowl Wire (Under the Blower Motor)
IK1	42	Engine Room Main Wire and Cowl Wire (Right Kick Panel)
IK2		
IL1	42	Floor No.2 Wire and Cowl Wire (Right Kick Panel)

▽ : GROUND POINTS

Code	See Page	Ground Points Location
EA	36 (1MZ-FE)	Right Radiator Side Support
	38 (5S-FE)	
EC	36 (1MZ-FE)	Surge Tank RH
	38 (5S-FE)	Intake Manifold
IG	40	Instrument Panel Brace LH

○ : SPLICE POINTS

Code	See Page	Wire Harness with Splice Points	Code	See Page	Wire Harness with Splice Points
E1	36 (1MZ-FE)	Engine Room Main Wire	E1	38 (5S-FE)	Engine Room Main Wire

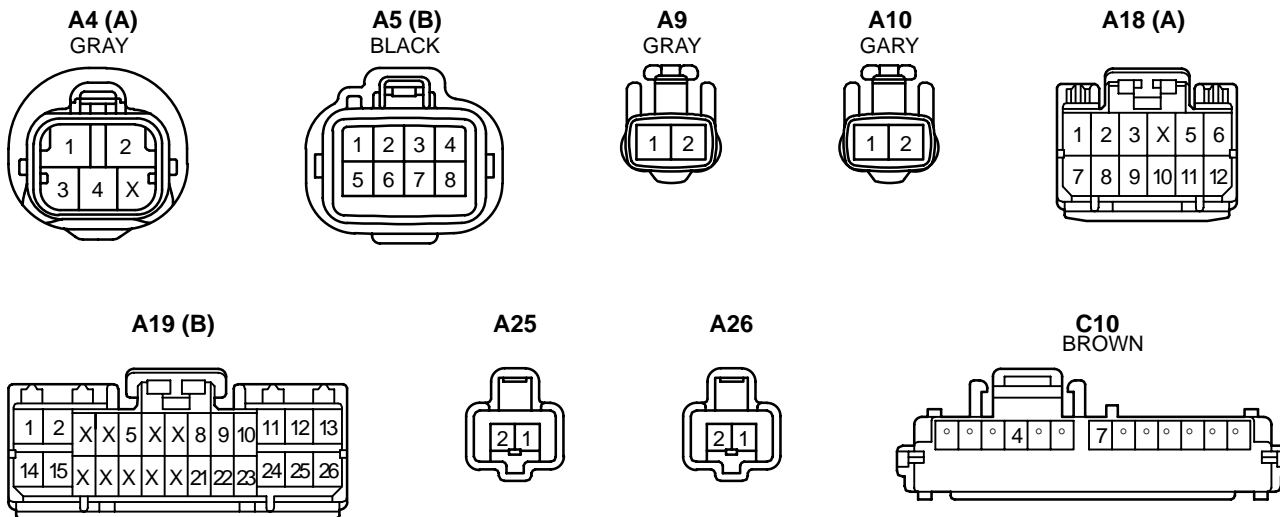

ABS (TMMK MADE)

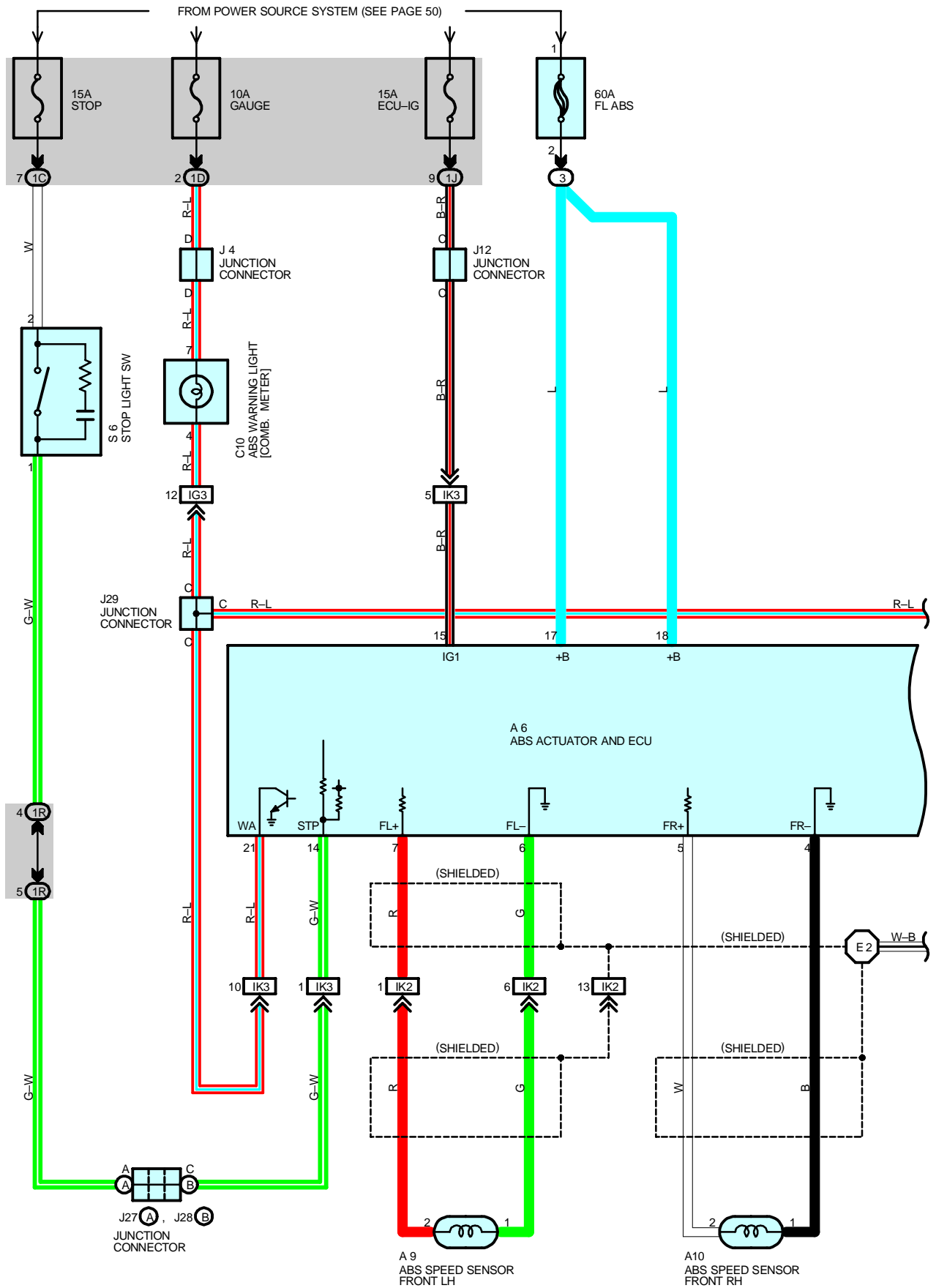

ABS (TMMK MADE)

SYSTEM OUTLINE

This system controls the respective brake fluid pressures acting on the disc brake cylinders of the right front wheel, left front wheel and rear wheels when the brakes are applied in a panic stop so that the wheels do not lock. This results in improved directional stability and steerability during panic braking.

1. INPUT SIGNALS

(1) Speed sensor signal

The speed of the wheels is detected and input to TERMINALS FL+, FR+, RL+ and RR+ of the ABS actuator and ECU.

(2) Stop light SW signal

A signal is input to TERMINAL STP of the ABS actuator and ECU when the brake pedal is depressed.

2. SYSTEM OPERATION

During sudden braking the ABS actuator and ECU has signals input from each sensor, which controls the current to the solenoid inside the actuator and lets the hydraulic pressure acting on each wheel cylinder escape to the reservoir. The pump inside the actuator is also operating at this time and it returns the brake fluid from the reservoir to the master cylinder, thus preventing locking of the vehicle wheels.

If the ABS actuator and ECU judges that the hydraulic pressure acting on the wheel cylinder is insufficient, the current on the solenoid is controlled and the hydraulic pressure is increased. Holding of the hydraulic pressure is also controlled by the ABS actuator and ECU, by the same method as above. Pressure reduction, holding and increase are repeated to maintain vehicle stability and to improve steerability during sudden braking.

SERVICE HINTS

A9, A10 ABS SPEED SENSOR FRONT LH, RH

2-1 : Approx. 1.6 kΩ

A25, A26 ABS SPEED SENSOR REAR LH, RH

2-1 : Approx. 1.6 kΩ

A6 ABS ACTUATOR AND ECU

(Connect the ABS actuator and ECU connectors)

12-GROUND : Approx. 12 volts with the ignition SW at **ON** position and the data link connector 1
TS-E1, TC-E1 not connected

11-GROUND : Approx. 12 volts with the ignition SW at **ON** position and the data link connector 1
TS-E1, TC-E1 not connected

16, 19-GROUND : Always continuity

15-GROUND : Approx. 12 volts with the ignition SW at **ON** position

14-GROUND : Approx. 12 volts with the brake pedal depressed

17, 18-GROUND : Always approx. 12 volts

○ : PARTS LOCATION

Code	See Page	Code	See Page	Code	See Page
A6	26 (1MZ-FE)	C10	30	J12	31
	28 (5S-FE)	D1	26 (1MZ-FE)	J22	31
A9	26 (1MZ-FE)		28 (5S-FE)	J23	31
	28 (5S-FE)	D4	30	J27	A 31
A10	26 (1MZ-FE)	J3	31	J28	B 31
	28 (5S-FE)	J4	31	J29	31
A25	32	J7	A 31	S6	31
A26	32	J8	B 31		

○ : RELAY BLOCKS

Code	See Page	Relay Blocks (Relay Block Location)
3	25	Fusible Link Block (Radiator Upper Support RH)

○ : JUNCTION BLOCK AND WIRE HARNESS CONNECTOR

Code	See Page	Junction Block and Wire Harness (Connector Location)
1C	20	Cowl Wire and Instrument Panel J/B (Lower Finish Panel)
1D	20	Instrument Panel Wire and Instrument Panel J/B (Lower Finish Panel)
1J	20	Cowl Wire and Instrument Panel J/B (Lower Finish Panel)
1R		

□ : CONNECTOR JOINING WIRE HARNESS AND WIRE HARNESS

Code	See Page	Joining Wire Harness and Wire Harness (Connector Location)
ID1	40	Floor Wire and Cowl Wire (Left Kick Panel)
IG3	40	Instrument Panel Wire and Cowl Wire (Under the Blower Motor)
II3	42	Engine Wire and Cowl Wire (Under the Blower Motor)
IK2	42	Engine Room Main Wire and Cowl Wire (Right Kick Panel)
IK3	42	
IL1	42	

▽ : GROUND POINTS

Code	See Page	Ground Points Location
EA	36 (1MZ-FE)	Right Radiator Side Support
	38 (5S-FE)	
EC	36 (1MZ-FE)	Surge Tank RH
	38 (5S-FE)	Intake Manifold

○ : SPLICE POINTS

Code	See Page	Wire Harness with Splice Points	Code	See Page	Wire Harness with Splice Points
E1	36 (1MZ-FE)	Engine Room Main Wire	E2	36 (1MZ-FE)	Engine Room Main Wire
	38 (5S-FE)			38 (5S-FE)	

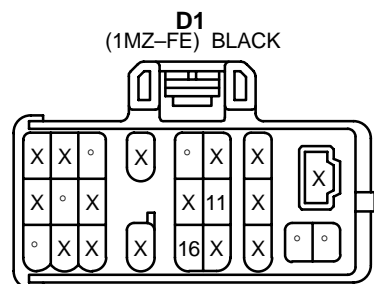
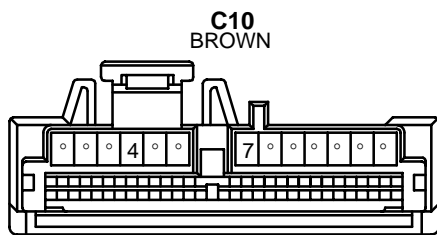
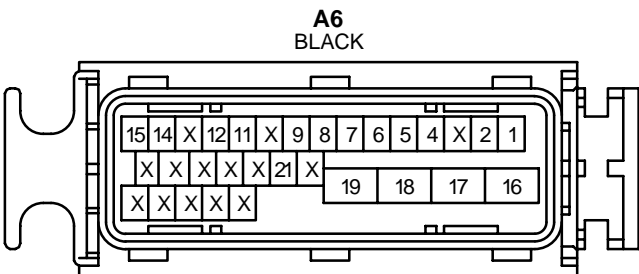

NOTICE: When inspecting or repairing the SRS, perform the operation in accordance with the following precautionary instructions and the procedure and precautions in the Repair Manual for the applicable model year.

- Malfunction symptoms of the SRS are difficult to confirm, so the DTCs become the most important source of information when troubleshooting. When troubleshooting the SRS, always inspect the DTCs before disconnecting the battery.
- **Work must be started after 90 seconds from when the ignition switch is turned to the "LOCK" position and the negative (-) terminal cable is disconnected from the battery.**
(The SRS is equipped with a back-up power source so that if work is started within 90 seconds from disconnecting the negative (-) terminal cable of the battery, the SRS may be deployed.)
- When the negative (-) terminal cable is disconnected from the battery, the memory of the clock and audio system will be canceled. So before starting work, make a record of the contents memorized in the audio memory system. When work is finished, reset the audio systems as they were before and adjust the clock. To avoid erasing the memory in each memory system, never use a back-up power supply from outside the vehicle.
- Before repairs, remove the airbag sensor if shocks are likely to be applied to the sensor during repairs.
- Do not expose the steering wheel pad, front passenger airbag assembly, side airbag assembly, seat belt pretensioner, center airbag sensor assembly, front airbag sensor assembly or side airbag sensor assembly directly to hot air or flames.
- Even in cases of a minor collision where the SRS does not deploy, the steering wheel pad, front passenger airbag assembly, side airbag assembly, seat belt pretensioner, center airbag sensor assembly, front airbag sensor assembly and side airbag sensor assembly should be inspected.
- Never use SRS parts from another vehicle. When replacing parts, replace them with new parts.
- Never disassemble and repair the steering wheel pad, front passenger airbag assembly, side airbag assembly, seat belt pretensioner, center airbag sensor assembly, front airbag sensor assembly or side airbag sensor assembly in order to reuse it.
- If the steering wheel pad, front passenger airbag assembly, side airbag assembly, seat belt pretensioner, center airbag sensor assembly, front airbag sensor assembly or side airbag sensor assembly has been dropped, or if there are cracks, dents or other defects in the case, bracket or connector, replace them with new ones.
- Use a volt/ohmmeter with high impedance (10 k Ω /V minimum) for troubleshooting the system's electrical circuits.
- Information labels are attached to the periphery of the SRS components. Follow the instructions on the notices.
- After work on the SRS is completed, perform the SRS warning light check.
- If the vehicle is equipped with a mobile communication system, refer to the precaution in the IN section of the Repair Manual.

SRS

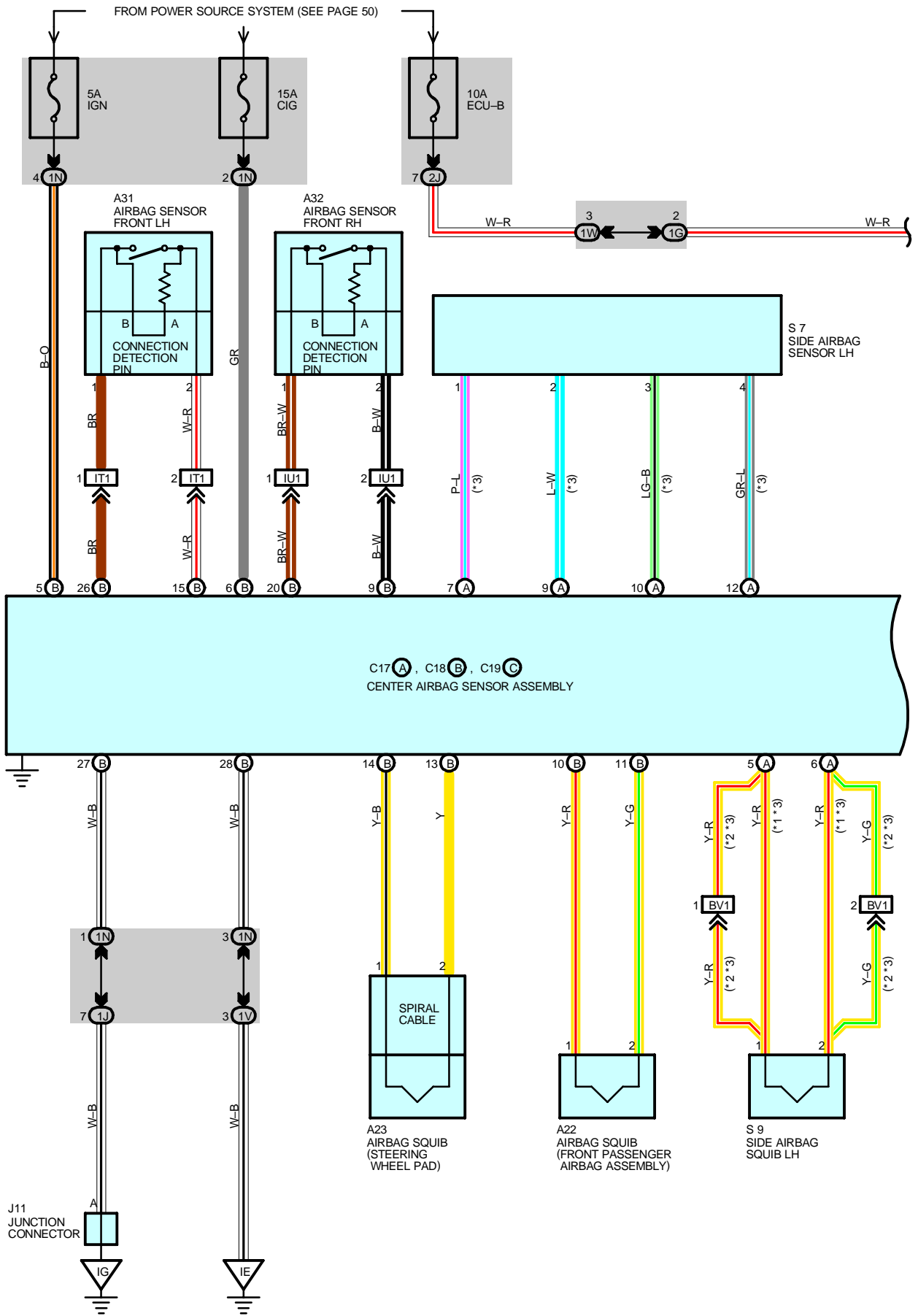

- * 1 : TMC MADE
- * 2 : TMMK MADE
- * 3 : W/ SIDE AIRBAG
- * 4 : TMMK MADE 1MZ-FE
- * 5 : EXCEPT *4

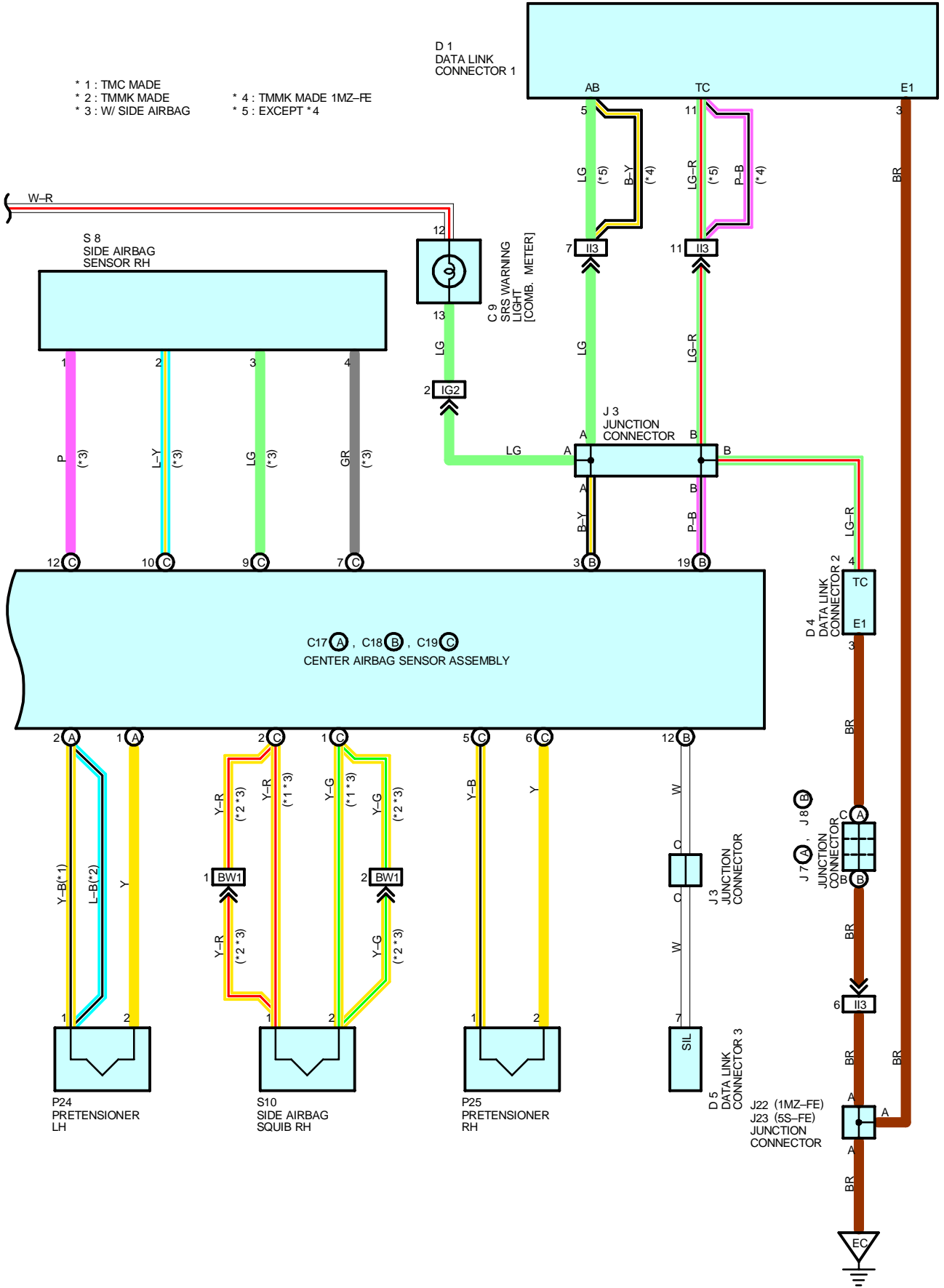

SYSTEM OUTLINE

The SRS is a driver and front passenger protection device which has a supplemental role to the seat belts.

When the ignition SW is turned to ACC or ON, current from the CIG fuse flows to TERMINAL (B) 6 of the center airbag sensor assembly. Only when the ignition SW is on does the current flow from the IGN fuse to TERMINAL (B) 5 of the center airbag sensor assembly.

If an accident occurs while driving, when the frontal impact exceeds a set level, current from the CIG or IGN fuse flows to TERMINALS (B) 14, (B) 10, (A) 2 and (C) 5 of the center airbag sensor assembly to TERMINAL 1 of the airbag squibs and the pretensioners to TERMINAL 2 to TERMINALS (B) 13, (B) 11, (A) 1 and (C) 6 of the center airbag sensor assembly to TERMINAL (B) 27, (B) 28 or BODY GROUND to GROUND, so that current flows to the front airbag squibs and the pretensioners and causes them to operate.

When the side impact also exceeds a set level, current from the CIG or IGN fuse flows to TERMINALS (A) 5, (C) 2, (A) 2 and (C) 5 of the center airbag sensor assembly to TERMINAL 1 of the side airbag squibs and the pretensioners to TERMINAL 2 to TERMINALS (A) 6, (C) 1, (A) 1 and (C) 6 of the center airbag sensor assembly to TERMINAL (B) 27, (B) 28 or BODY GROUND to GROUND, causing side airbag squibs and the pretensioners to operate.

The airbag stored inside the steering wheel pad is instantaneously expanded to soften the shock to the driver.

The airbag stored inside the passenger's instrument panel is instantaneously expanded to soften the shock to the front passenger.

Side airbags are instantaneously expanded to soften the shock of side to the driver and front passenger.

The pretensioners make sure of the seat belt restrainability.

○ : PARTS LOCATION

Code	See Page	Code	See Page	Code	See Page
A22	30	D4	30	P24	33
A23	30	D5	30	P25	33
C9	30	J3	31	S7	33
C17	A 30	J7	A 31	S8	33
C18	B 30	J8	B 31	S9	34
C19	C 30	J11	31	S10	34
D1	26 (1MZ-FE)	J22	31		
	28 (5S-FE)	J23	31		

○ : JUNCTION BLOCK AND WIRE HARNESS CONNECTOR

Code	See Page	Junction Block and Wire Harness (Connector Location)
1G	20	Instrument Panel Wire and Instrument Panel J/B (Lower Finish Panel)
1J	20	Cowl Wire and Instrument Panel J/B (Lower Finish Panel)
1N		
1V		
1W		
2J	22	Cowl Wire and Engine Room J/B No.2 (Engine Compartment Left)

□ : CONNECTOR JOINING WIRE HARNESS AND WIRE HARNESS

Code	See Page	Joining Wire Harness and Wire Harness (Connector Location)
IG2	40	Instrument Panel Wire and Cowl Wire (Lower Finish Panel)
II3	42	Engine Wire and Cowl Wire (Under the Blower Motor)
IT1	42	Cowl Wire and Cowl Wire (Left Kick Panel)
IU1	42	Engine Room Main Wire and Cowl Wire (Right Kick Panel)
BV1	46	Floor Wire and Seat No.1 Wire (Under the Driver's Seat)
BW1	46	Floor No.2 Wire and Seat No.2 Wire (Under the Front Passenger's Seat)

▽ : GROUND POINTS

Code	See Page	Ground Points Location
EC	36 (1MZ-FE)	Surge Tank RH
	38 (5S-FE)	Intake Manifold
IE	40	Cowl Side Panel LH
IG	40	Instrument Panel Brace LH

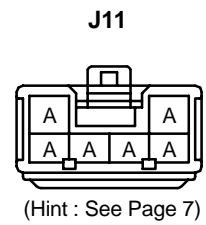
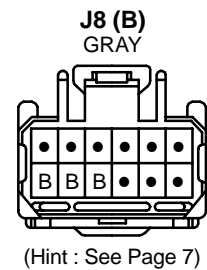
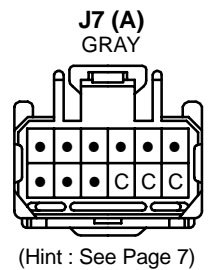
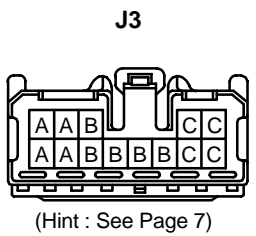
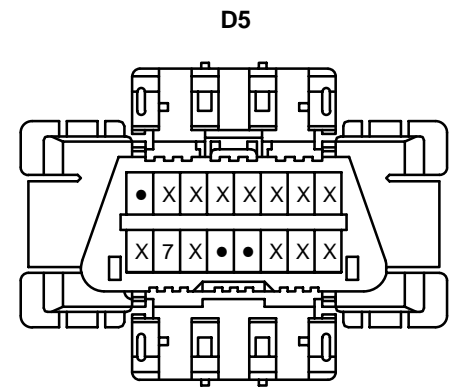
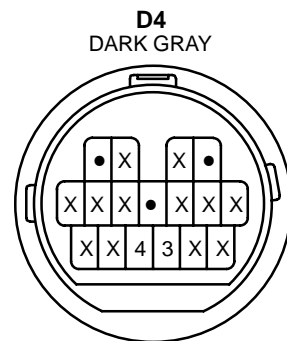
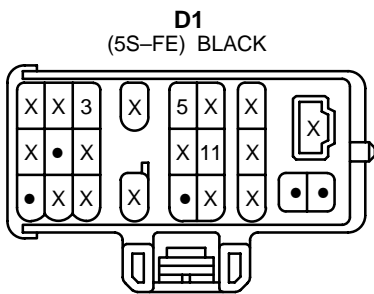
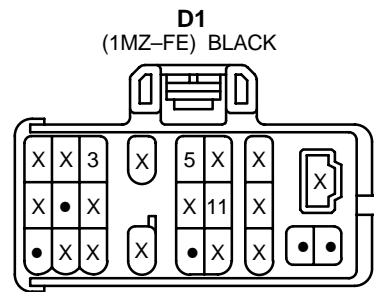
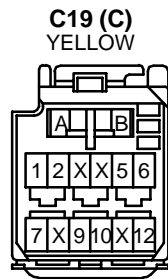
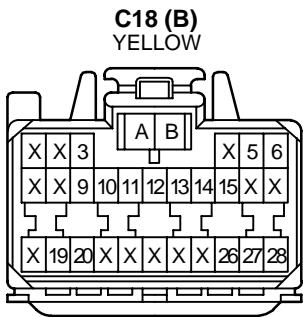
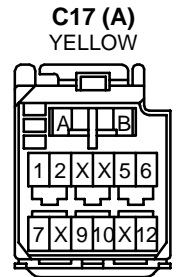
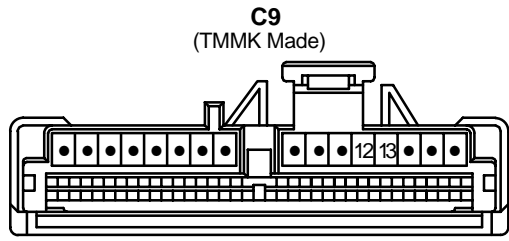
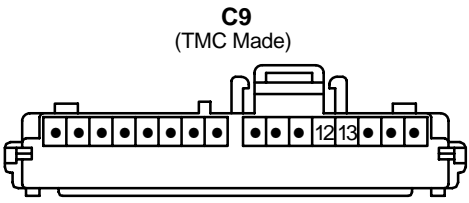
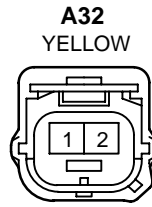
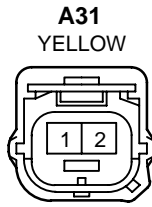
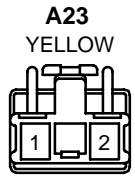
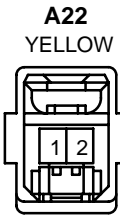

SRS

J22

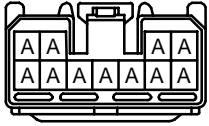

(Hint : See Page 7)

J23

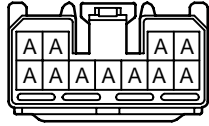

(Hint : See Page 7)

P24
YELLOW

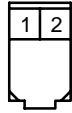

P25
YELLOW

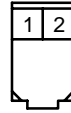

S7
YELLOW

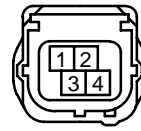

S8
YELLOW

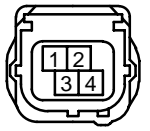

S9
YELLOW



S10
YELLOW



SHIFT LOCK

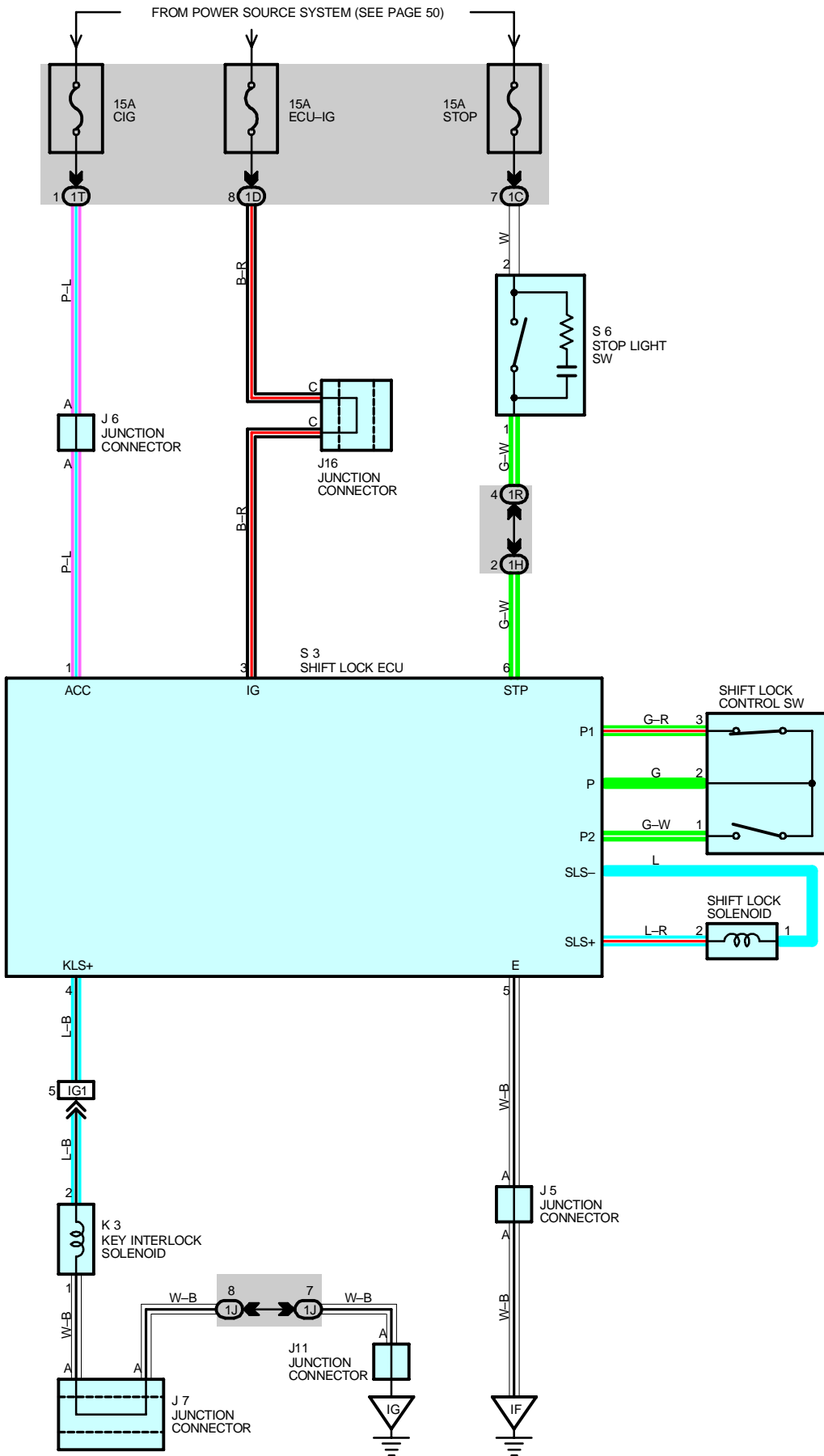

SYSTEM OUTLINE

When the ignition SW is turned to ACC position the current from the CIG fuse flows to TERMINAL 1 of the shift lock ECU, in the ON position, the current from the ECU-IG fuse flows to TERMINAL 3 of the ECU.

1. SHIFT LOCK MECHANISM

With the ignition SW on, when a signal that the brake pedal is depressed (Stop light SW on) and a signal that the shift lever is put in P position (Continuity between P1 and P of the shift lock control SW) is input to the shift lock ECU, the ECU operates and current flows from TERMINAL 3 of the ECU to TERMINAL SLS+ of the shift lock solenoid to solenoid to TERMINAL SLS- to TERMINAL 5 of the ECU to GROUND. This causes the shift lock solenoid to turn on (Plate stopper disengages) and the shift lever can shift into position other than the P.

2. KEY INTERLOCK MECHANISM

With the ignition SW ON or ACC position, when the shift lever is put in P position (No continuity between P2 and P of shift lock control SW), the current flowing from TERMINAL 4 of the shift lock ECU to the key interlock solenoid is cut off. This causes the key interlock solenoid to turn off (Lock lever disengages from LOCK position) and the ignition key can be turned from ACC to LOCK position.

SERVICE HINTS

S3 SHIFT LOCK ECU

- 1-GROUND : Approx. **12** volts with the ignition SW at **ACC** or **ON** position
- 3-GROUND : Approx. **12** volts with the ignition SW at **ON** position
- 5-GROUND : Always continuity
- 6-GROUND : Approx. **12** volts with the brake pedal depressed

S6 STOP LIGHT SW

- 2-1 : Closed with the brake pedal depressed

○ : PARTS LOCATION

Code	See Page	Code	See Page	Code	See Page
J5	31	J11	31	S3	31
J6	31	J16	31	S6	31
J7	31	K3	31		

○ : JUNCTION BLOCK AND WIRE HARNESS CONNECTOR

Code	See Page	Junction Block and Wire Harness (Connector Location)
1C	20	Cowl Wire and Instrument Panel J/B (Lower Finish Panel)
1D	20	Instrument Panel Wire and Instrument Panel J/B (Lower Finish Panel)
1H		
1J	20	Cowl Wire and Instrument Panel J/B (Lower Finish Panel)
1R		
1T	20	Instrument Panel Wire and Instrument Panel J/B (Lower Finish Panel)

□ : CONNECTOR JOINING WIRE HARNESS AND WIRE HARNESS

Code	See Page	Joining Wire Harness and Wire Harness (Connector Location)
IG1	40	Instrument Panel Wire and Cowl Wire (Lower Finish Panel)

▽ : GROUND POINTS

Code	See Page	Ground Points Location
IF	40	Left Kick Panel
IG	40	Instrument Panel Brace LH

SHIFT LOCK

J5
ORANGE

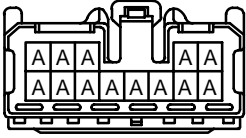

(Hint : See Page 7)

J6

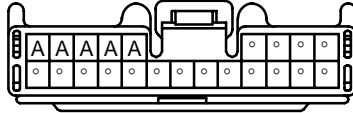

(Hint : See Page 7)

J7
GRAY

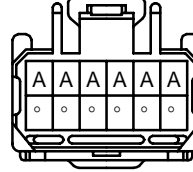

(Hint : See Page 7)

J11

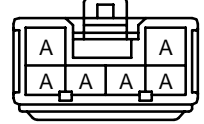

(Hint : See Page 7)

J16
BLACK

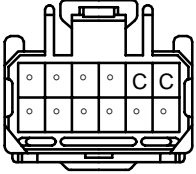

(Hint : See Page 7)

K3
BLACK

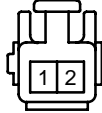

S3

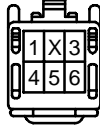

S6
BLUE

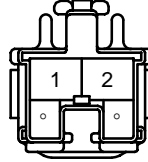

HORN

FROM POWER SOURCE SYSTEM (SEE PAGE 50)

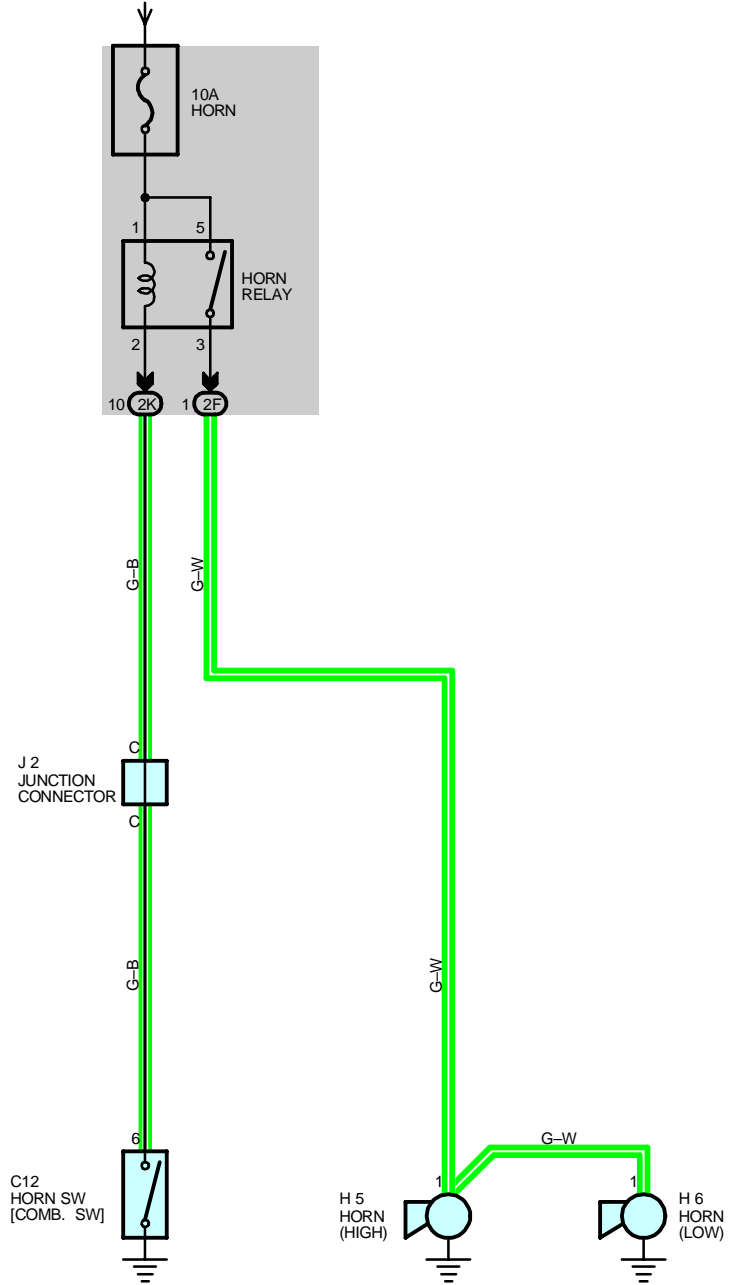

SERVICE HINTS

HORN RELAY [ENGINE ROOM J/B NO.2]

5-3 : Closed with the horn SW on

○ : PARTS LOCATION

Code	See Page	Code	See Page	Code	See Page
C12	30	H5	28 (5S-FE)	H6	28 (5S-FE)
H5	26 (1MZ-FE)	H6	26 (1MZ-FE)	J2	31

○ : JUNCTION BLOCK AND WIRE HARNESS CONNECTOR

Code	See Page	Junction Block and Wire Harness (Connector Location)
2F	22	Engine Room Main Wire and Engine Room J/B No.2 (Engine Compartment Left)
2K	22	Cowl Wire And Engine Room J/B No.2 (Engine Compartment Left)

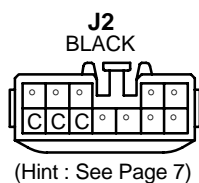
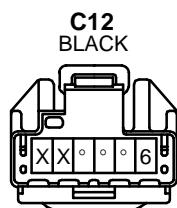

SERVICE HINTS

C4 CIGARETTE LIGHTER

- 2-GROUND : Approx. **12** volts with the ignition SW at **ACC** or **ON** position
- 1-GROUND : Always continuity

C6 CLOCK

- 4-GROUND : Approx. **12** volts with the ignition SW at **ACC** or **ON** position
- 1-GROUND : Always approx. **12** volts
- 2-GROUND : Always continuity
- 3-GROUND : Approx. **12** volts with the light control SW at **TAIL** or **HEAD** position

○ : PARTS LOCATION

Code	See Page	Code	See Page	Code	See Page
C4	30	J6	31	J30	A 31
C6	30	J11	31	J31	B 31
D10	30	J16	A 31		
J5	31	J17	B 31		

○ : JUNCTION BLOCK AND WIRE HARNESS CONNECTOR

Code	See Page	Junction Block and Wire Harness (Connector Location)
1D	20	Instrument Panel Wire and Instrument Panel J/B (Lower Finish Panel)
1G		
1J	20	Cowl Wire and Instrument Panel J/B (Lower Finish Panel)
1T	20	Instrument Panel Wire and Instrument Panel J/B (Lower Finish Panel)
1W	20	Cowl Wire and Instrument Panel J/B (Lower Finish Panel)
2J	22	Cowl Wire and Engine Room J/B No.2 (Engine Compartment Left)

▽ : GROUND POINTS

Code	See Page	Ground Points Location
IF	40	Left Kick Panel
IG	40	Instrument Panel Brace LH

C4



C6
BLACK

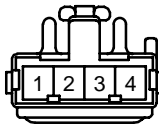

D10
BLACK



J5
ORANGE

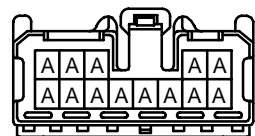

(Hint : See Page 7)

J6

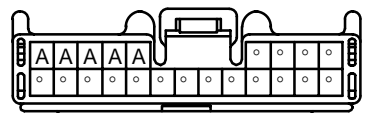

(Hint : See Page 7)

J11

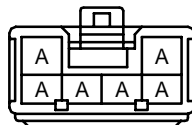

(Hint : See Page 7)

J16 (A)
BLACK

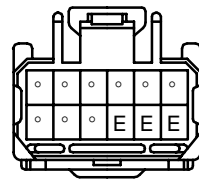

(Hint : See Page 7)

J17 (B)
BLACK

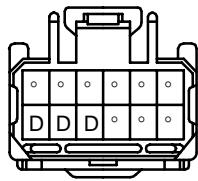

(Hint : See Page 7)

J30 (A)
GRAY

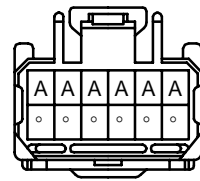

(Hint : See Page 7)

J31 (B)
GRAY

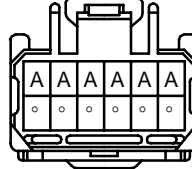

(Hint : See Page 7)

KEY REMINDER AND SEAT BELT WARNING

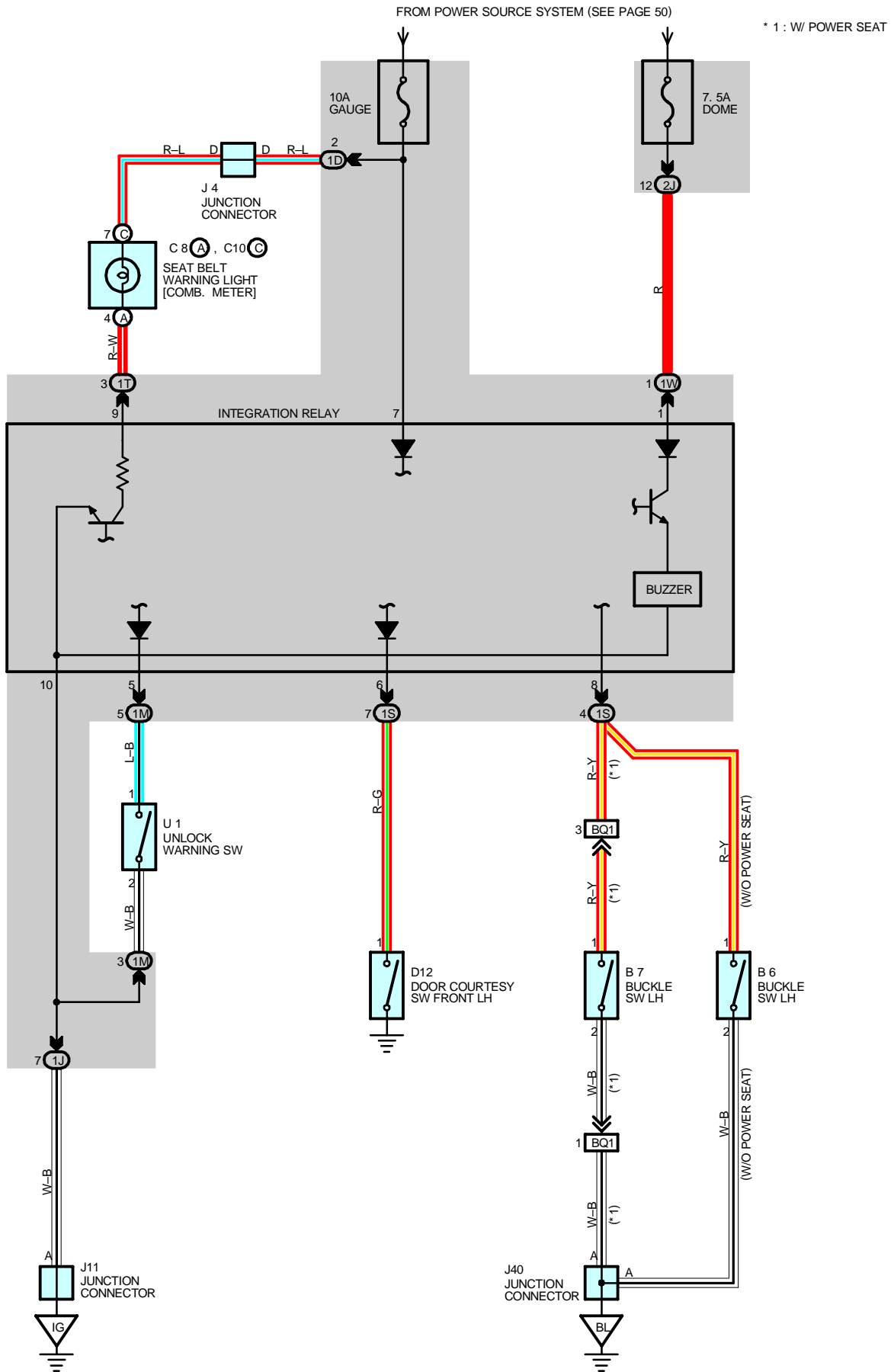

SYSTEM OUTLINE

Current always flows to TERMINAL 1 of the integration relay through the DOME fuse.

1. SEAT BELT WARNING SYSTEM

When the ignition SW is turned on, current flows from the GAUGE fuse to TERMINAL 7 of the integration relay. At the same time, current flows to TERMINAL 9 of the relay from the GAUGE fuse through the seat belt warning light. This current activates the relay and the current flowing through the warning light flows from TERMINAL 9 of the relay to TERMINAL 10 to GROUND, causing the warning light to light up. A buckle SW off signal is input to TERMINAL 8 of the relay to TERMINAL 10 to GROUND, causing the warning light to light up. A buckle SW on signal is input to TERMINAL 8 of the relay, the current flowing to TERMINAL 1 of the relay flows from TERMINAL 10 to GROUND and the seat belt warning buzzer sounds for approx. 6 seconds. However, if the seat belt is put on during this period (While the buzzer is sounding), signal input to TERMINAL 8 of the relay stops and the current flow from TERMINAL 1 of the relay to TERMINAL 10 to GROUND is cut, causing the buzzer to stop.

2. KEY REMINDER SYSTEM

With the ignition key inserted in the key cylinder (Unlock warning SW on), the ignition SW still off and driver's door open (Door courtesy SW on), when a signal is input to TERMINAL 6 of the integration relay, the relay operates, current flows from TERMINAL 1 of the relay to TERMINAL 10 to GROUND and key reminder buzzer sounds.

SERVICE HINTS

B6, B7 BUCKLE SW LH

1-2 : Closed with driver's seat belt in use

D12 DOOR COURTESY SW FRONT LH

1-GROUND : Closed with front LH door open

U1 UNLOCK WARNING SW

1-2 : Closed with ignition key in cylinder

INTEGRATION RELAY [INSTRUMENT PANEL J/B]

10-GROUND : Always continuity

6-GROUND : Continuity with the driver's door open

5-GROUND : Continuity with the ignition key in cylinder

8-GROUND : Continuity with the driver's seat belt in use

1-GROUND : Always approx. 12 volts

○ : PARTS LOCATION

Code	See Page	Code	See Page	Code	See Page	
B6	32	C10	C	30	J11	31
B7	34	D12		32	J40	32
C8	A	J4		31	U1	31

○ : JUNCTION BLOCK AND WIRE HARNESS CONNECTOR

Code	See Page	Junction Block and Wire Harness (Connector Location)
1D	20	Instrument Panel Wire and Instrument Panel J/B (Lower Finish Panel)
1J	20	Cowl Wire and Instrument Panel J/B (Lower Finish Panel)
1M		
1S	20	Floor Wire and Instrument Panel J/B (Lower Finish Panel)
1T	20	Instrument Panel Wire and Instrument Panel J/B (Lower Finish Panel)
1W	20	Cowl Wire and Instrument Panel J/B (Lower Finish Panel)
2J	22	Cowl Wire and Engine Room J/B No.2 (Engine Compartment Left)

□ : CONNECTOR JOINING WIRE HARNESS AND WIRE HARNESS

Code	See Page	Joining Wire Harness and Wire Harness (Connector Location)
BQ1	46	Floor Wire and Seat No.1 Wire (Under the Driver's Seat)

KEY REMINDER AND SEAT BELT WARNING

 : GROUND POINTS

Code	See Page	Ground Points Location
IG	40	Instrument Panel Brace LH
BL	44	Under the Left Center Pillar

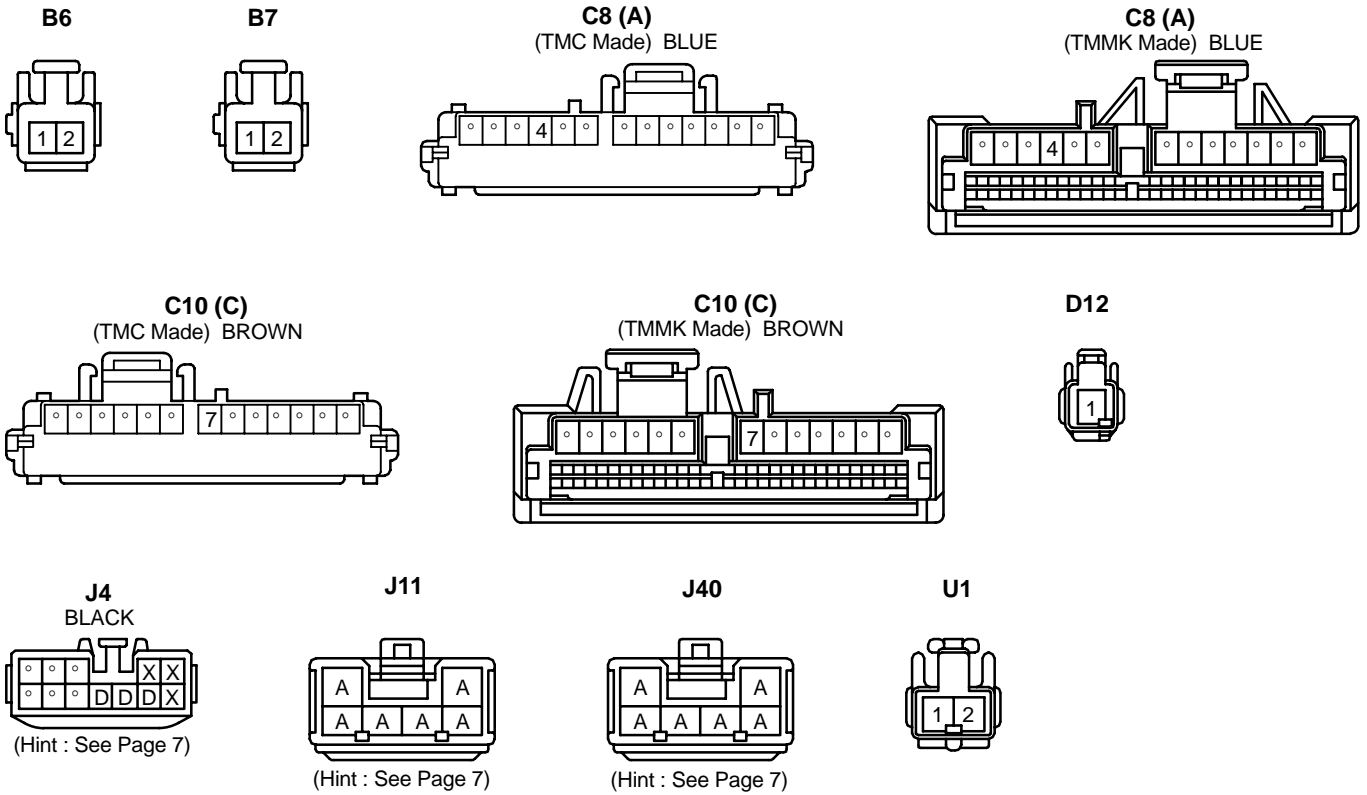

POWER OUTLET

FROM POWER SOURCE SYSTEM (SEE PAGE 50)

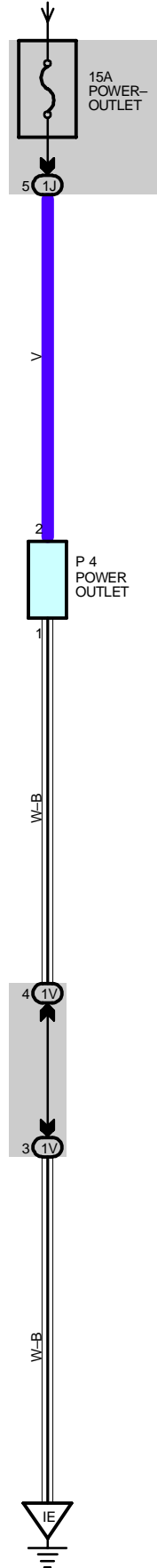

SERVICE HINTS**P4 POWER OUTLET**2-GROUND : Approx. **12** volts with the ignition SW at **ACC** or **ON** position

1-GROUND : Always continuity

○ : PARTS LOCATION

Code	See Page	Code	See Page	Code	See Page
P4	31				

○ : JUNCTION BLOCK AND WIRE HARNESS CONNECTOR

Code	See Page	Junction Block and Wire Harness (Connector Location)
1J	20	Cowl Wire and Instrument Panel J/B (Lower Finish Panel)
1V		

▽ : GROUND POINTS

Code	See Page	Ground Points Location
IE	40	Cowl Side Panel LH

P4
ORANGE

REMOTE CONTROL MIRROR

FROM POWER SOURCE SYSTEM (SEE PAGE 50)

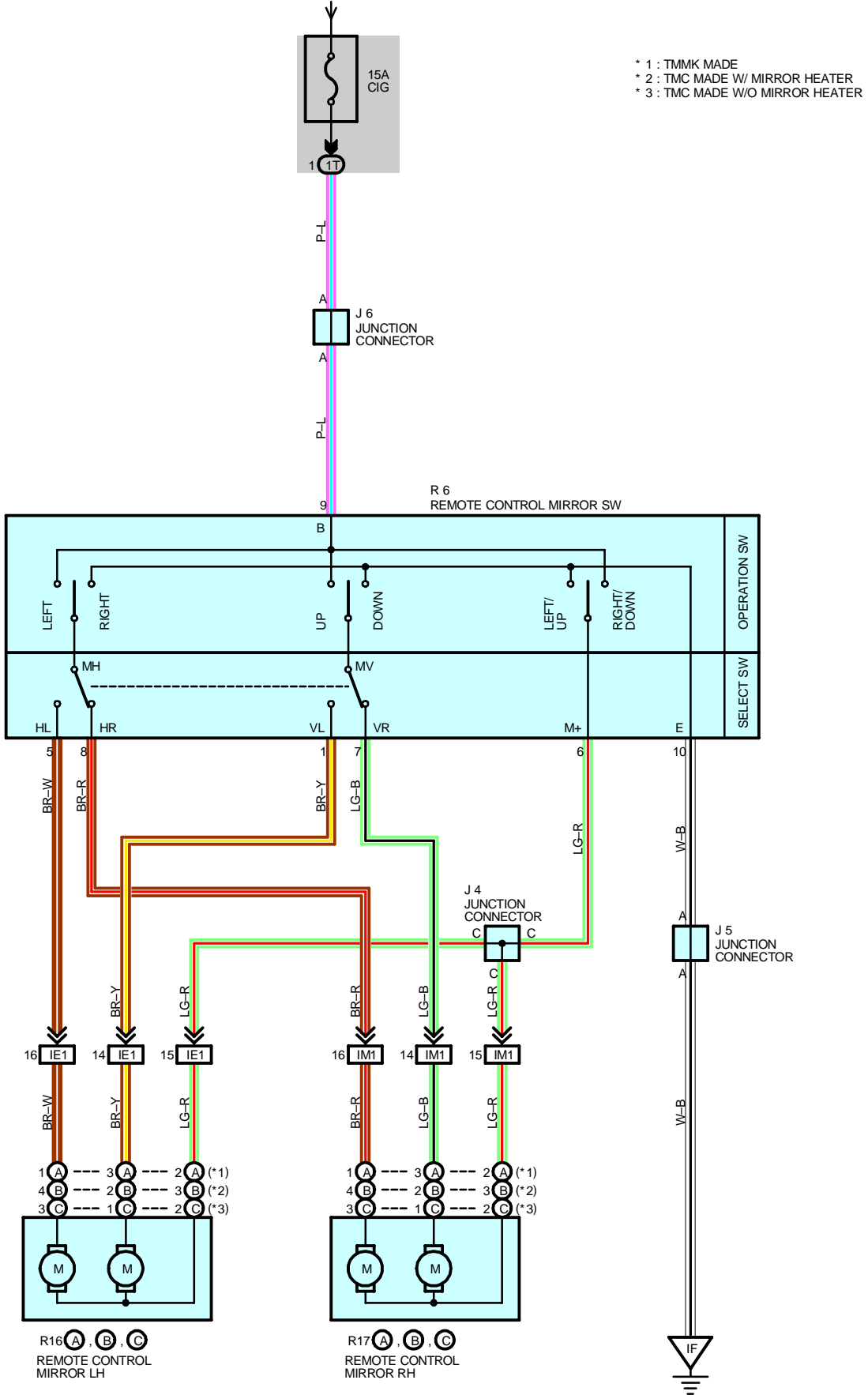

SERVICE HINTS

R6 REMOTE CONTROL MIRROR SW

- 9-GROUND : Approx. 12 volts with the ignition SW at **ACC** or **ON** position
- 6-10 : Continuity with the operation SW at **UP** or **LEFT** position
- 9-6 : Continuity with the operation SW at **DOWN** or **RIGHT** position

○ : PARTS LOCATION

Code	See Page	Code	See Page	Code	See Page
J4	31	R16	A 33	R17	B 33
J5	31		B 33		C 33
J6	31		C 33		
R6	31	R17	A 33		

○ : JUNCTION BLOCK AND WIRE HARNESS CONNECTOR

Code	See Page	Junction Block and Wire Harness (Connector Location)
1T	20	Instrument Panel Wire and Instrument Panel J/B (Lower Finish Panel)

□ : CONNECTOR JOINING WIRE HARNESS AND WIRE HARNESS

Code	See Page	Joining Wire Harness and Wire Harness (Connector Location)
IE1	40	Front Door LH Wire and Instrument Panel Wire (Left Kick Panel)
IM1	42	Front Door RH Wire and Instrument Panel Wire (Right Kick Panel)

▽ : GROUND POINTS

Code	See Page	Ground Points Location
IF	40	Left Kick Panel

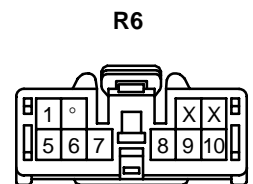
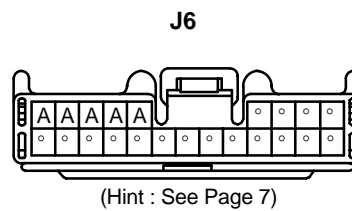
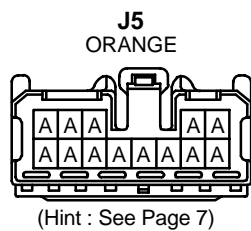
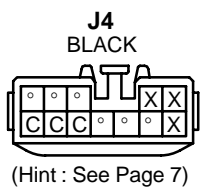

R16 (A), R17 (A)
(TMMK Made w/ Mirror Heater)

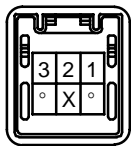

R16 (A), R17 (A)
(TMMK Made w/o Mirror Heater)

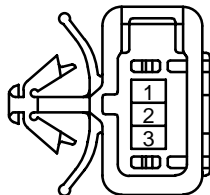

R16 (B), R17 (B)
(TMC Made w/ Mirror Heater)

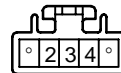

R16 (C), R17 (C)
(TMC Made w/o Mirror Heater)



SERVICE HINTS

DEFOGGER RELAY [INSTRUMENT PANEL J/B]

5-3 : Closed with the ignition SW on and the rear window defogger SW on

R5 REAR WINDOW DEFOGGER SW

4-GROUND : Approx. 12 volts with the ignition SW on

3-GROUND : Always continuity

5-GROUND : Continuity with the rear window defogger SW on and approx. 15 minutes thereafter

R16 (A), (B), R17 (A), (B) MIRROR HEATER LH, RH [REMOTE CONTROL MIRROR LH, RH]

(A)1, (B) 6-GROUND : Approx. 12 volts with the rear window defogger SW on

(A)5, (B) 4-GROUND : Always continuity

○ : PARTS LOCATION

Code	See Page	Code	See Page	Code	See Page
A34	30	N2	33	R16	B 33
J11	31	R5	31	R17	A 33
J32	31	R14	A 33		B 33
J38	32	R15	B 33		
J39	32	R16	A 33		

○ : JUNCTION BLOCK AND WIRE HARNESS CONNECTOR

Code	See Page	Junction Block and Wire Harness (Connector Location)
1D	20	Instrument Panel Wire and Instrument Panel J/B (Lower Finish Panel)
1G		
1J	20	Cowl Wire and Instrument Panel J/B (Lower Finish Panel)
1L		
1R		
1T	20	Instrument Panel Wire and Instrument Panel J/B (Lower Finish Panel)
1V	20	Cowl Wire and Instrument Panel J/B (Lower Finish Panel)

□ : CONNECTOR JOINING WIRE HARNESS AND WIRE HARNESS

Code	See Page	Joining Wire Harness and Wire Harness (Connector Location)
ID1	40	Floor Wire and Cowl Wire (Left Kick Panel)
IE1	40	Front Door LH Wire and Instrument Panel Wire (Left Kick Panel)
IM1	42	Front Door RH Wire and Instrument Panel Wire (Right Kick Panel)

▽ : GROUND POINTS

Code	See Page	Ground Points Location
IE	40	Cowl Side Panel LH
IG	40	Instrument Panel Brace LH
IJ	40	Right Kick Panel
BO	44	Right Quarter Pillar

REAR WINDOW DEFOGGER AND MIRROR HEATER

A34

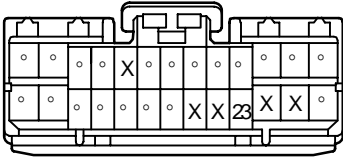

J11

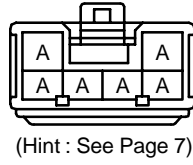

(Hint : See Page 7)

J32
GRAY

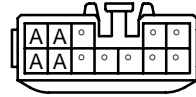

(Hint : See Page 7)

J38

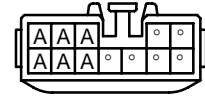

(Hint : See Page 7)

J39



(Hint : See Page 7)

N2

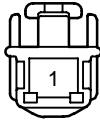

R5
BLACK

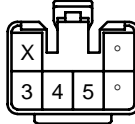

R14 (A)
BLACK



R15 (B)
BLACK



R16 (A)
(TMC Made)

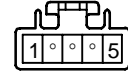

R16 (B)
(TMMK Made)

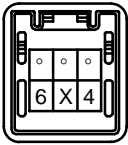

R17 (A)
(TMC Made)

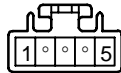

R17 (B)
(TMMK Made)

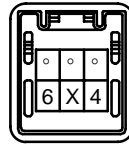

AUTO ANTENNA

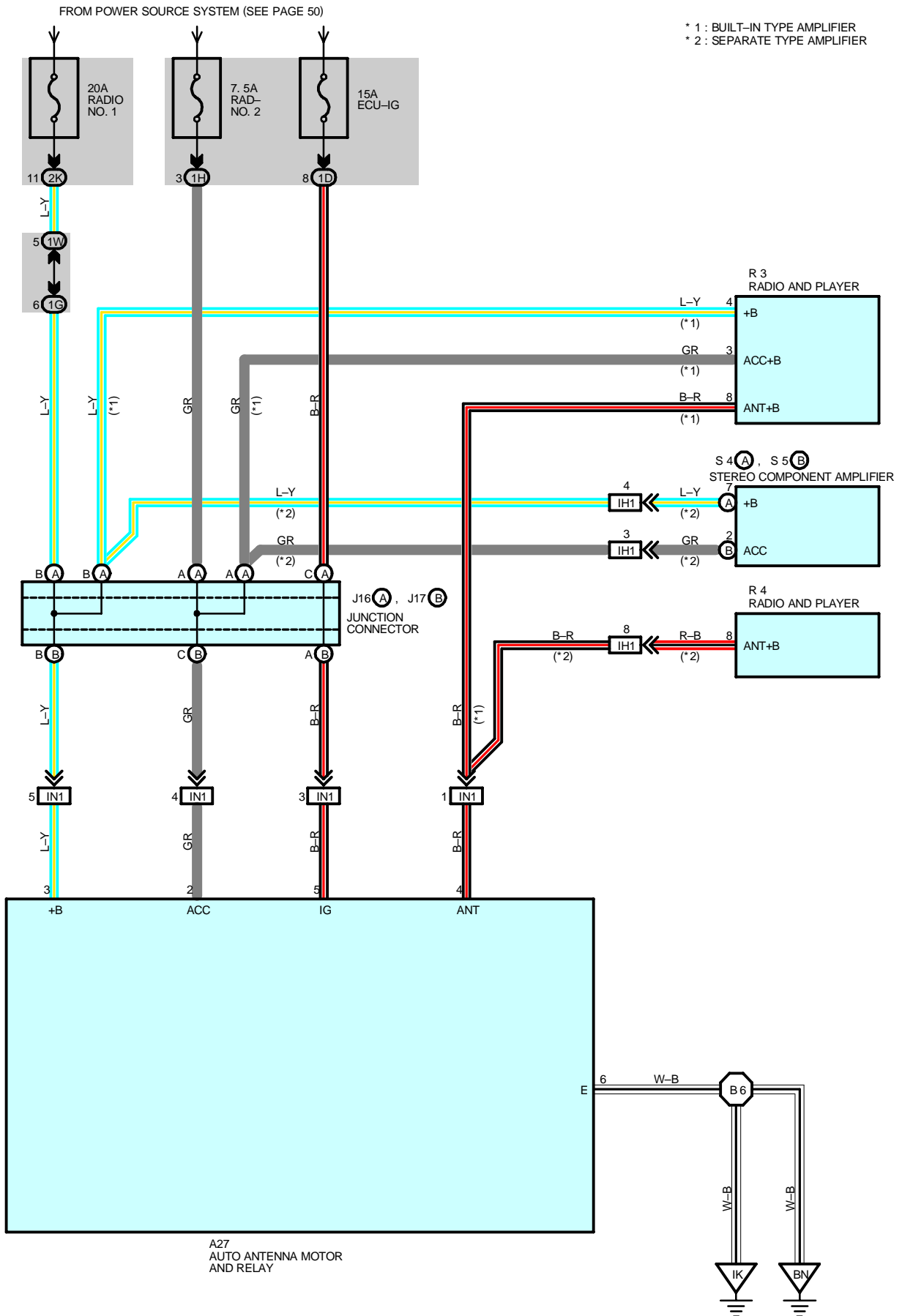

SERVICE HINTS

A27 AUTO ANTENNA MOTOR AND RELAY

- 3-GROUND : Always approx. 12 volts
- 5-GROUND : Approx. 12 volts with the ignition SW at **ON** position
- 2-GROUND : Approx. 12 volts with the ignition SW at **ACC** or **ON** position
- 6-GROUND : Always continuity

○ : PARTS LOCATION

Code	See Page	Code	See Page	Code	See Page
A27	32	R3	31	S5	B
J16	A	31	R4	31	
J17	B	31	S4	A	31

□ : JUNCTION BLOCK AND WIRE HARNESS CONNECTOR

Code	See Page	Junction Block and Wire Harness (Connector Location)
1D	20	Instrument Panel Wire and Instrument Panel J/B (Lower Finish Panel)
1G		
1H		
1W	20	Cowl Wire and Instrument Panel J/B (Lower Finish Panel)
2K	22	Cowl Wire and Engine Room J/B No.2 (Engine Compartment Left)

□ : CONNECTOR JOINING WIRE HARNESS AND WIRE HARNESS

Code	See Page	Joining Wire Harness and Wire Harness (Connector Location)
IH1	40	Instrument Panel Wire and Instrument Panel No.2 Wire (Instrument Panel Brace RH)
IN1	42	Floor No.2 Wire and Instrument Panel Wire (Right Kick Panel)

▽ : GROUND POINTS

Code	See Page	Ground Points Location
IK	40	Right Kick Panel
BN	44	Under the Right Center Pillar

○ : SPLICE POINTS

Code	See Page	Wire Harness with Splice Points	Code	See Page	Wire Harness with Splice Points
B6	44	Floor No.2 Wire			

A27

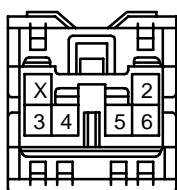

J16 (A)
BLACK

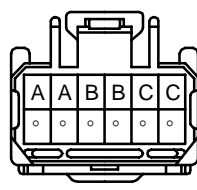

(Hint : See Page 7)

J17 (B)
BLACK

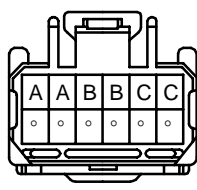

(Hint : See Page 7)

R3

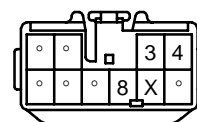

R4

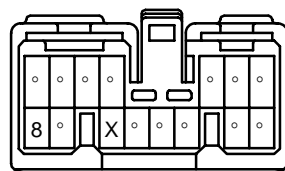

S4 (A)

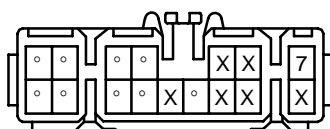

S5 (B)

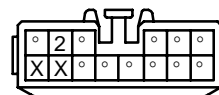

RADIO AND PLAYER (SEPARATE TYPE AMPLIFIER)

FROM POWER SOURCE SYSTEM (SEE PAGE 50)

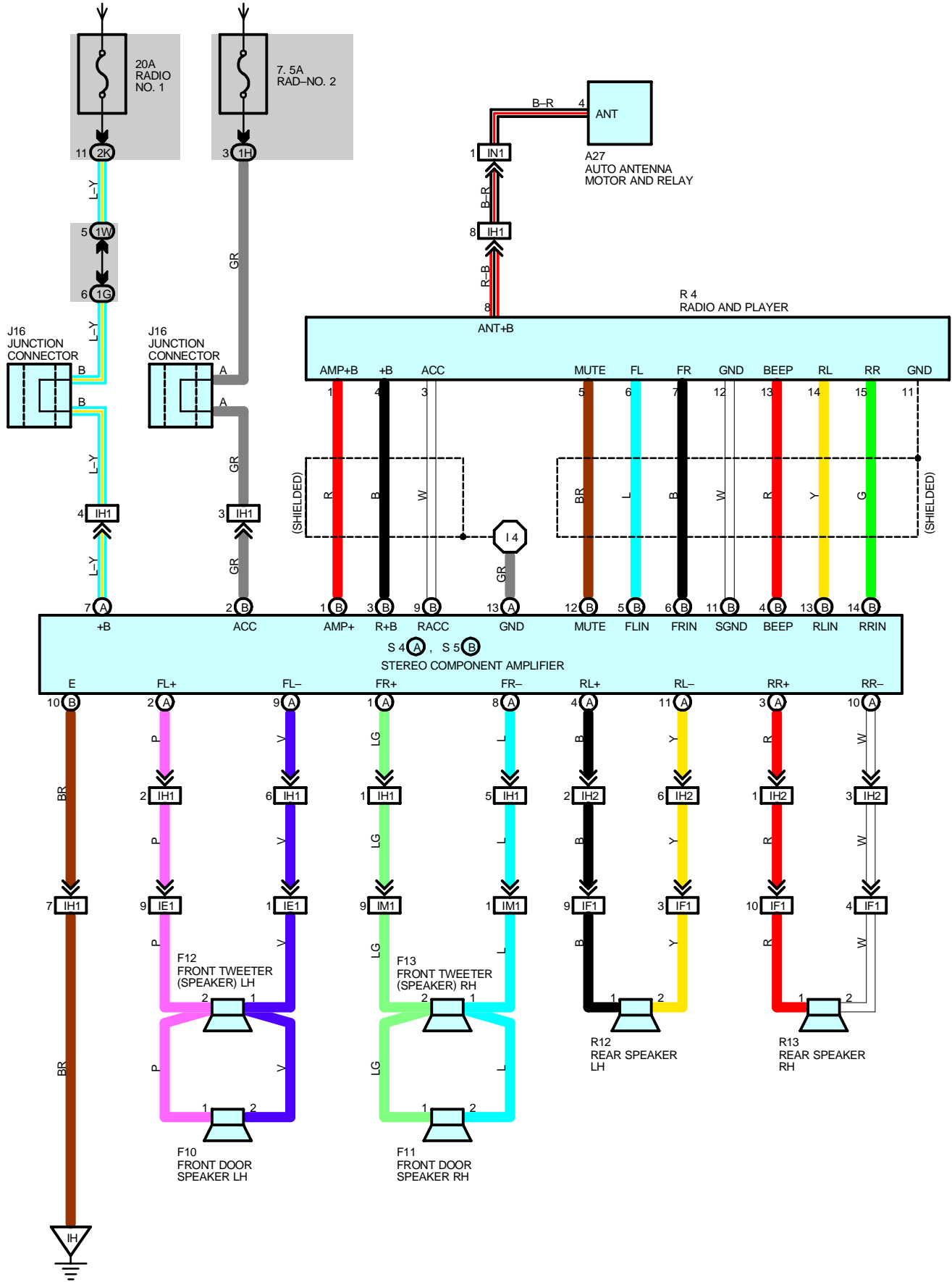

SERVICE HINTS**S4 (A), S5 (B) STEREO COMPONENT AMPLIFIER**(A) 7-GROUND : Always approx. **12** volts(B) 2-GROUND : Approx. **12** volts with the ignition SW at **ON** or **ACC** position

(B)10-GROUND : Always continuity

○ : PARTS LOCATION

Code	See Page	Code	See Page	Code	See Page
A27	32	F13	32	R13	33
F10	32	J16	31	S4	A 31
F11	32	R4	31	S5	B 31
F12	32	R12	33		

○ : JUNCTION BLOCK AND WIRE HARNESS CONNECTOR

Code	See Page	Junction Block and Wire Harness (Connector Location)
1G	20	Instrument Panel Wire and Instrument Panel J/B (Lower Finish Panel)
1H		
1W	20	Cowl Wire and Instrument Panel J/B (Lower Finish Panel)
2K	22	Cowl Wire and Engine Room J/B No.2 (Engine Compartment Left)

□ : CONNECTOR JOINING WIRE HARNESS AND WIRE HARNESS

Code	See Page	Joining Wire Harness and Wire Harness (Connector Location)
IE1	40	Front Door LH Wire and Instrument Panel Wire (Left Kick Panel)
IF1	40	Floor Wire and Instrument Panel Wire (Left Kick Panel)
IH1	40	Instrument Panel Wire and Instrument Panel No.2 Wire (Instrument Panel Brace RH)
IH2		
IM1	42	Front Door RH Wire and Instrument Panel Wire (Right Kick Panel)
IN1	42	Floor No.2 Wire and Instrument Panel Wire (Right Kick Panel)

▽ : GROUND POINTS

Code	See Page	Ground Points Location
IH	40	Instrument Panel Brace RH

○ : SPLICE POINTS

Code	See Page	Wire Harness with Splice Points	Code	See Page	Wire Harness with Splice Points
I4	42	Instrument Panel No.2 Wire			

RADIO AND PLAYER (SEPARATE TYPE AMPLIFIER)

A27

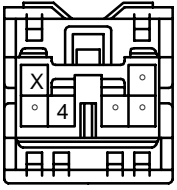

F10
BLUE

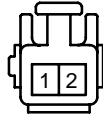

F11
BLUE

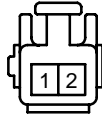

F12

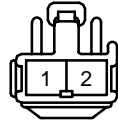

F13

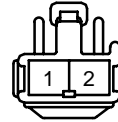

J16
BLACK

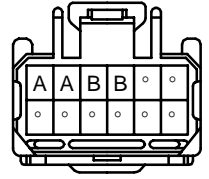

(Hint : See Page 7)

R4

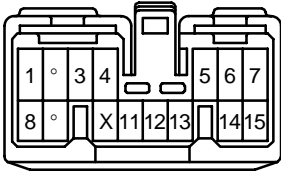

R12



R13



S4 (A)

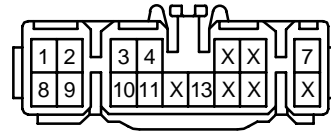

S5 (B)

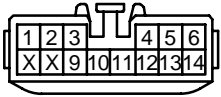

RADIO AND PLAYER (BUILT-IN TYPE AMPLIFIER)

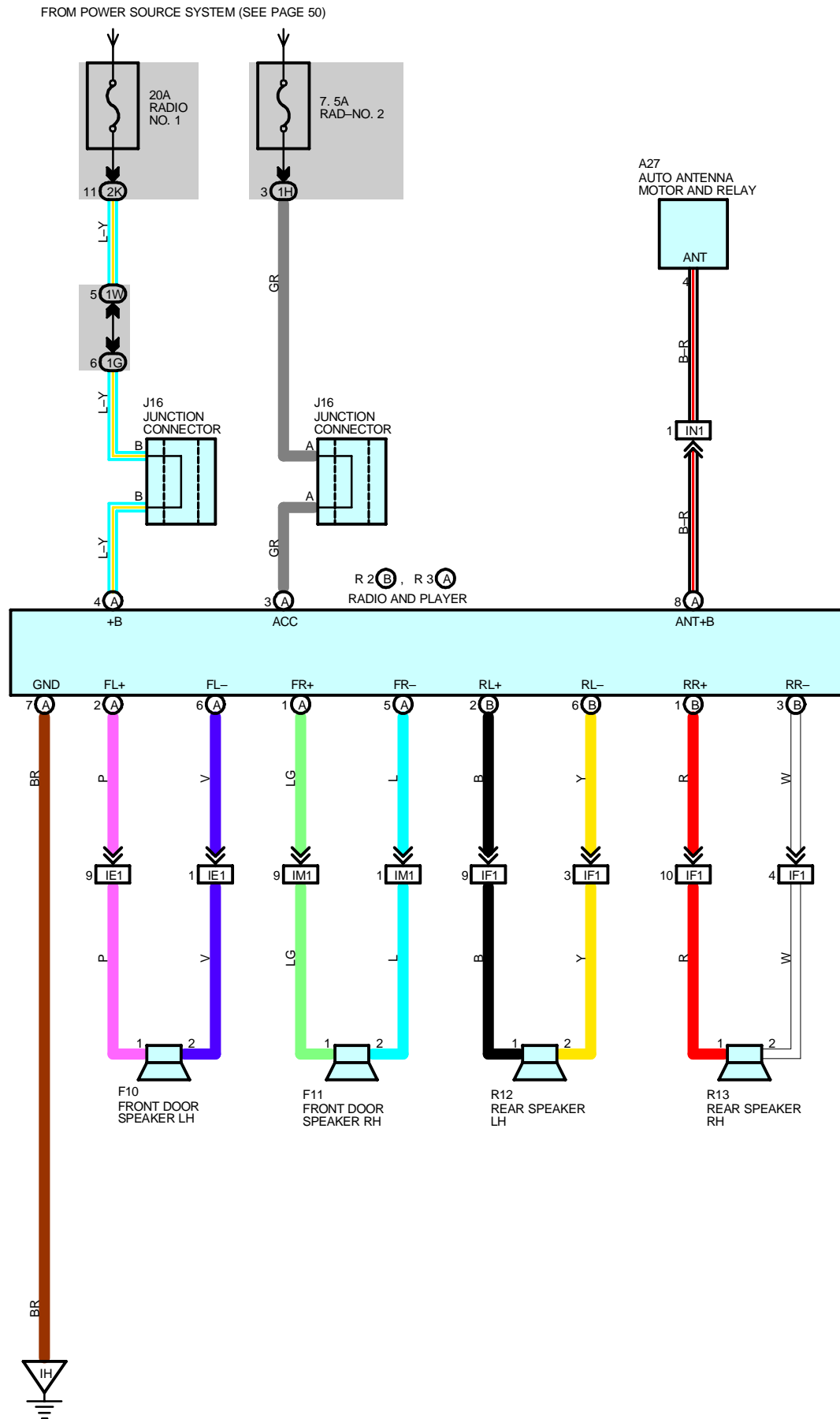

SERVICE HINTS

R3 (A) RADIO AND PLAYER

- (A) 4-GROUND : Always approx. **12** volts
- (A) 3-GROUND : Approx. **12** volts with the ignition SW at **ON** or **ACC** position
- (A) 7-GROUND : Always continuity

○ : PARTS LOCATION

Code	See Page	Code	See Page	Code	See Page
A27	32	J16	31	R12	33
F10	32	R2	B	R13	33
F11	32	R3	A		

○ : JUNCTION BLOCK AND WIRE HARNESS CONNECTOR

Code	See Page	Junction Block and Wire Harness (Connector Location)
1G	20	Instrument Panel Wire and Instrument Panel J/B (Lower Finish Panel)
1H		
1W	20	Cowl Wire and Instrument Panel J/B (Lower Finish Panel)
2K	22	Cowl Wire and Engine Room J/B No.2 (Engine Compartment Left)

□ : CONNECTOR JOINING WIRE HARNESS AND WIRE HARNESS

Code	See Page	Joining Wire Harness and Wire Harness (Connector Location)
IE1	40	Front Door LH Wire and Instrument Panel Wire (Left Kick Panel)
IF1	40	Floor Wire and Instrument Panel Wire (Left Kick Panel)
IM1	42	Front Door RH Wire and Instrument Panel Wire (Right Kick Panel)
IN1	42	Floor No.2 Wire and Instrument Panel Wire (Right Kick Panel)

▽ : GROUND POINTS

Code	See Page	Ground Points Location
IH	40	Instrument Panel Brace RH

A27

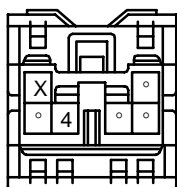

F10
BLUE

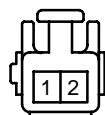

F11
BLUE

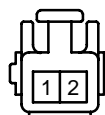

J16
BLACK

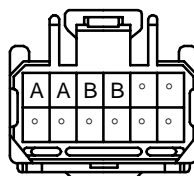

(Hint : See Page 7)

R2 (B)



R3 (A)

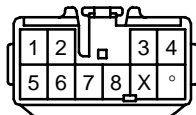

R12



R13



COMBINATION METER

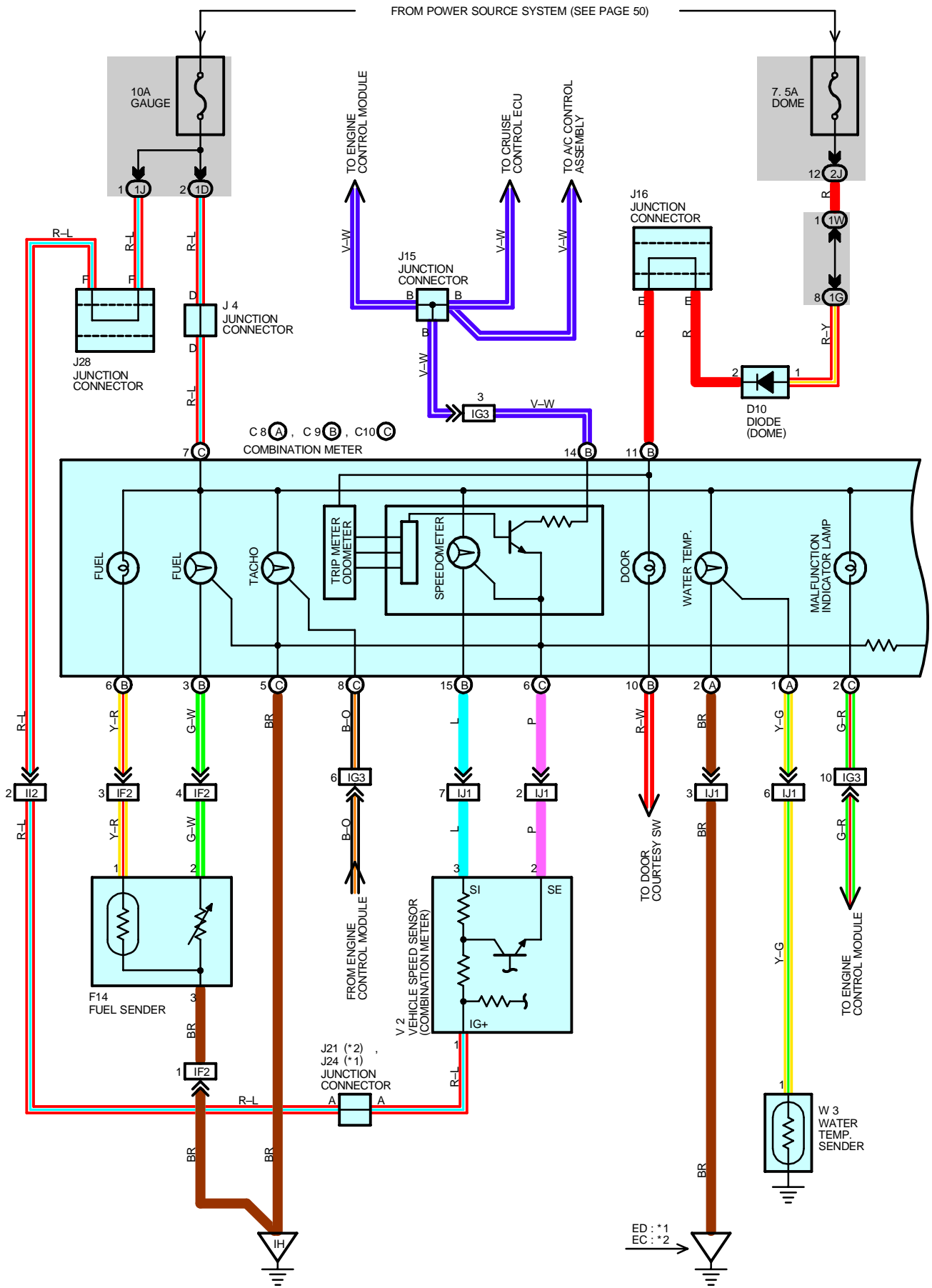

FROM POWER SOURCE SYSTEM (SEE PAGE 50)

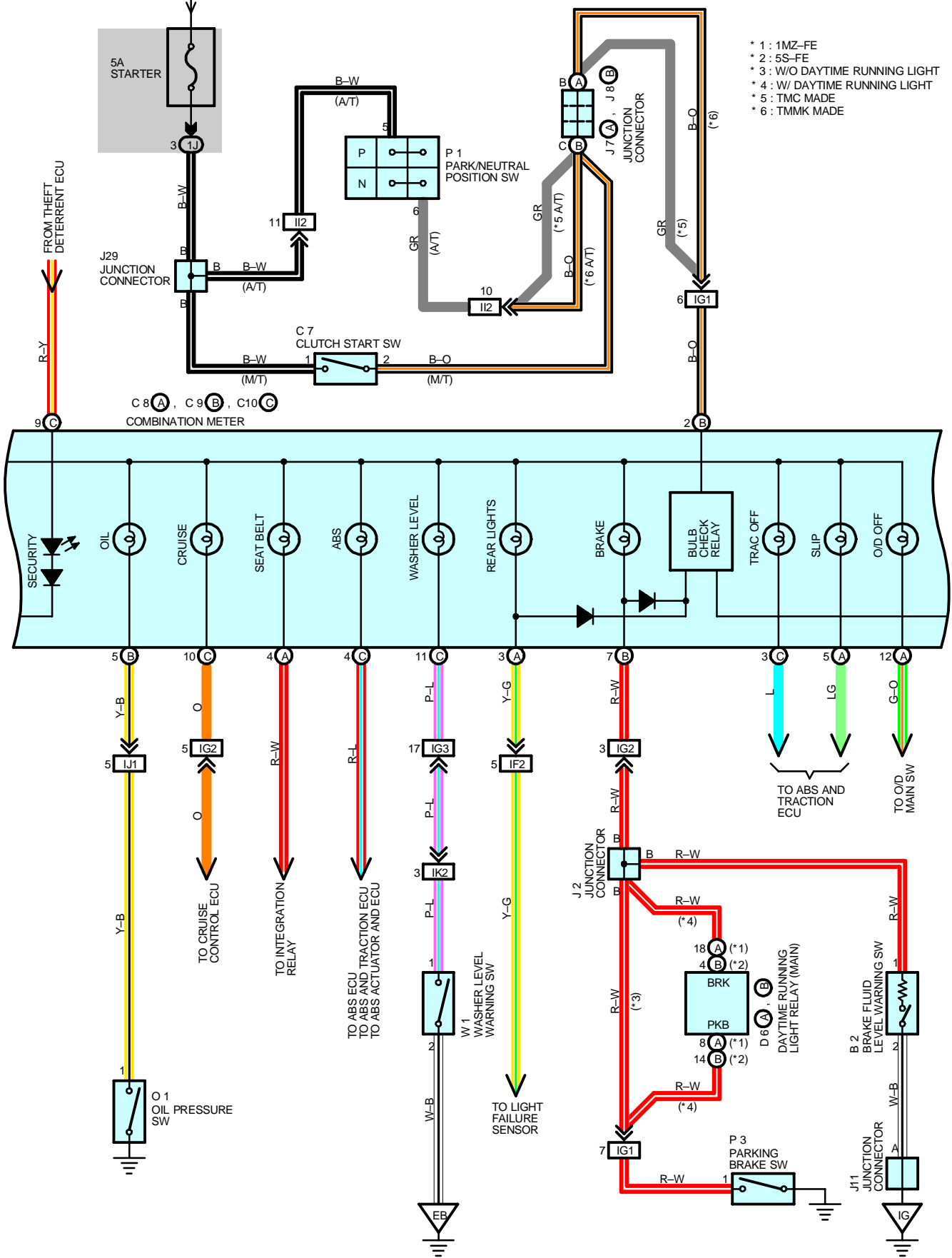

COMBINATION METER

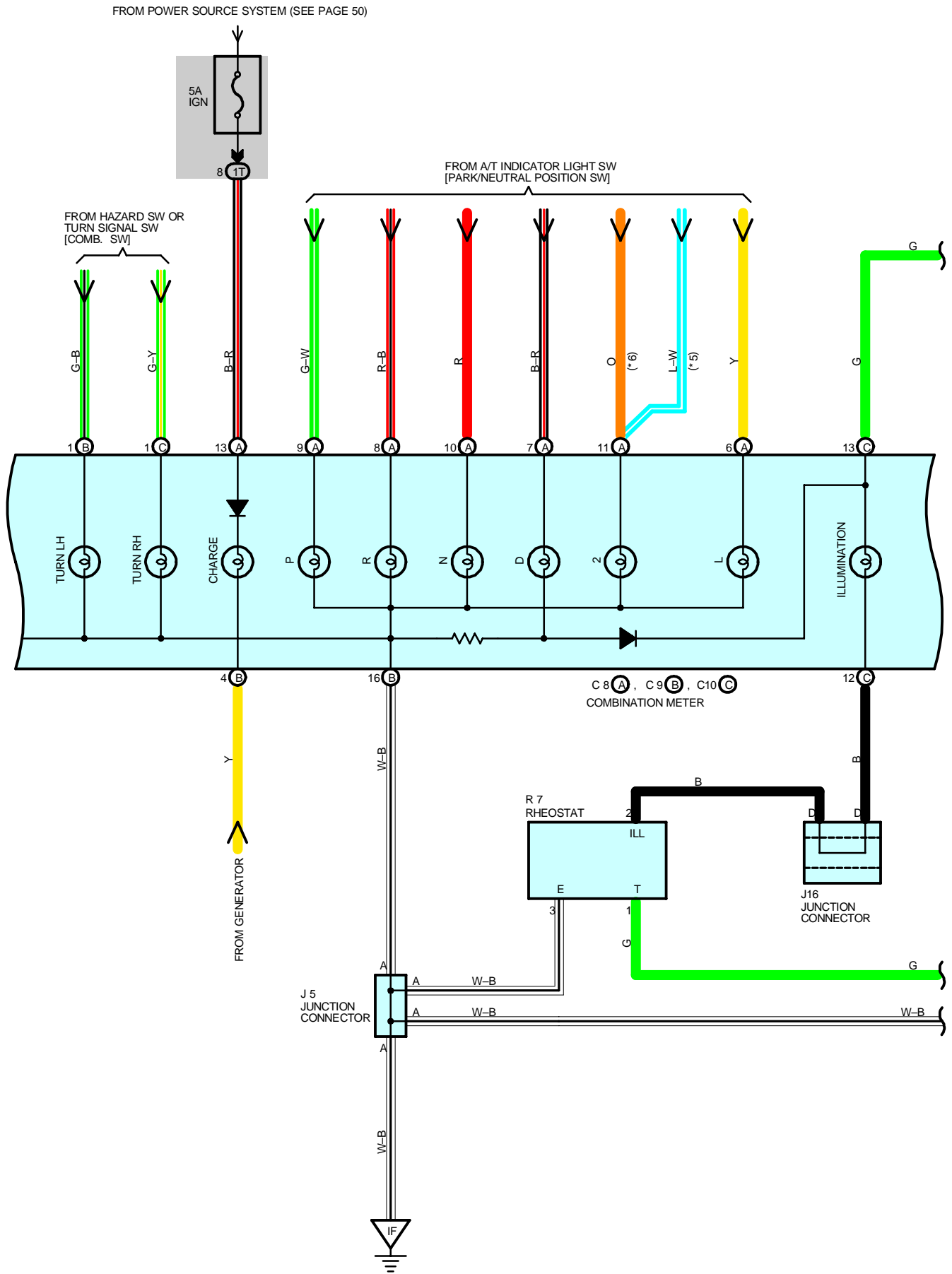

FROM POWER SOURCE SYSTEM (SEE PAGE 50)

* 3 : W/O DAYTIME RUNNING LIGHT
* 4 : W/ DAYTIME RUNNING LIGHT

* 5 : TMC MADE
* 6 : TMMK MADE

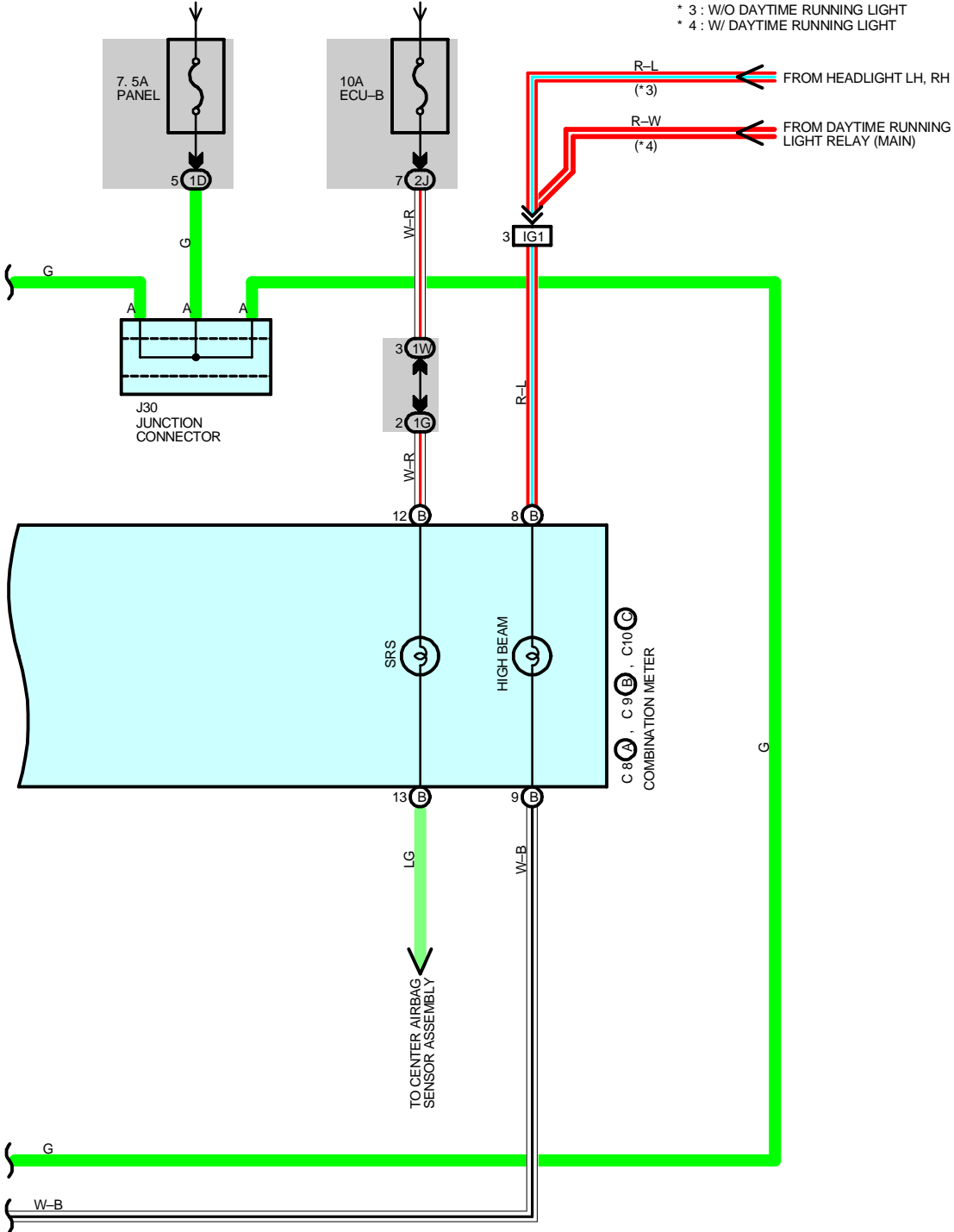

COMBINATION METER

SERVICE HINTS

B2 BRAKE FLUID LEVEL WARNING SW

1-2 : Closed with the float down

C8 (A), C9 (B), C10 (C) COMBINATION METER

(B) 2-GROUND : Approx. **12** volts with the ignition SW at **ST** position and the shift lever at **P** or **N** position (A/T)

Approx. **12** volts with the ignition SW at **ST** position and the clutch pedal depressed (M/T)

(A) 13, (C) 7-GROUND : Approx. **12** volts with the ignition SW at **ON** position

(B) 11, (B) 12-GROUND: Always approx. **12** volts

(A) 2, (B) 9, (B) 16, (C) 5-GROUND : Always continuity

O1 OIL PRESSURE SW

1-GROUND : Closed with the oil pressure above approx. **20** kpa (**2.8** psi, **0.2** kgf/cm²)

P3 PARKING BRAKE SW

1-GROUND : Closed with the parking brake lever pulled up

W3 WATER TEMP. SENDER

1-GROUND : Approx. **160-240** Ω (**50** °C, **122** °F)

Approx. **17.1-21.2** Ω (**120** °C, **248** °F)

○ : PARTS LOCATION

Code	See Page	Code	See Page	Code	See Page
B2	26 (1MZ-FE)	J5	31	O1	29 (5S-FE)
	28 (5S-FE)	J7	A 31	P1	27 (1MZ-FE)
C7	30	J8	B 31		29 (5S-FE)
C8	A 30	J11	31	P3	31
C9	B 30	J15	31	R7	31
C10	C 30	J16	31	V2	27 (1MZ-FE)
D6	A 30	J21	31		29 (5S-FE)
	B 30	J24	31	W1	27 (1MZ-FE)
D10	30	J28	31		29 (5S-FE)
F14	32	J29	31	W3	27 (1MZ-FE)
J2	31	J30	31		29 (5S-FE)
J4	31	O1	27 (1MZ-FE)		

○ : JUNCTION BLOCK AND WIRE HARNESS CONNECTOR

Code	See Page	Junction Block and Wire Harness (Connector Location)
1D	20	Instrument Panel Wire and Instrument Panel J/B (Lower Finish Panel)
1G		
1J	20	Cowl Wire and Instrument Panel J/B (Lower Finish Panel)
1T	20	Instrument Panel Wire and Instrument Panel J/B (Lower Finish Panel)
1W	20	Cowl Wire and Instrument Panel J/B (Lower Finish Panel)
2J	22	Cowl Wire and Engine Room J/B No.2 (Engine Compartment Left)

□ : CONNECTOR JOINING WIRE HARNESS AND WIRE HARNESS

Code	See Page	Joining Wire Harness and Wire Harness (Connector Location)
IF2	40	Floor Wire and Instrument Panel Wire (Left Kick Panel)
IG1	40	Instrument Panel Wire and Cowl Wire (Lower Finish Panel)
IG2	40	
IG3	40	Instrument Panel Wire and Cowl Wire (Under The Blower Motor)
II2	42	Engine Wire and Cowl Wire (Under the Blower Motor)
IJ1	42	Engine Wire and Instrument Panel Wire (Under the Blower Motor)
IK2	42	Engine Room Main Wire and Cowl Wire (Right Kick Panel)



: GROUND POINTS

Code	See Page	Ground Points Location
EB	36 (1MZ-FE)	Left Radiator Side Support
	38 (5S-FE)	
EC	38 (5S-FE)	Intake Manifold
ED	36 (1MZ-FE)	Rear Side of the Surge Tank
IF	40	Left Kick Panel
IG	40	Instrument Panel Brace LH
IH	40	Instrument Panel Brace RH

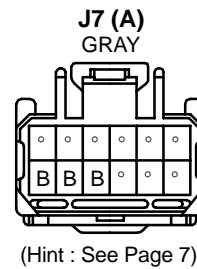
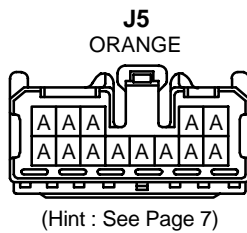
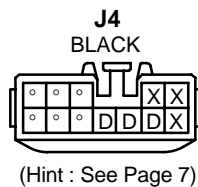
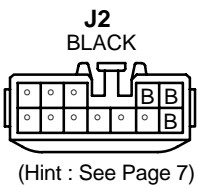
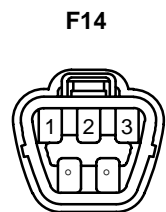
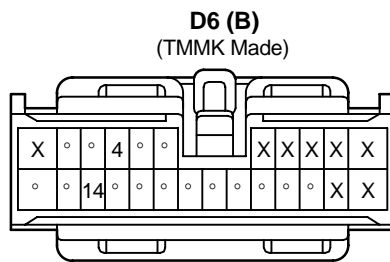
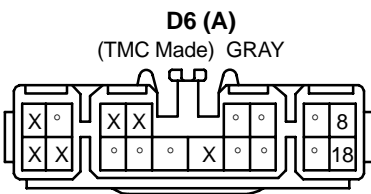
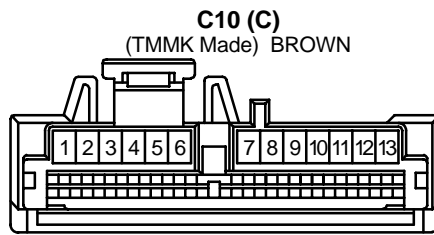
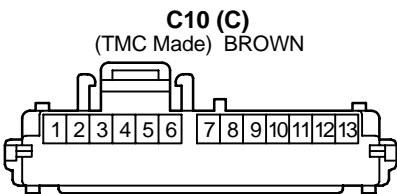
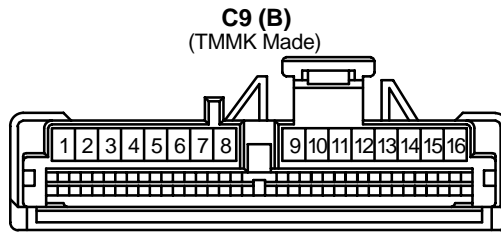
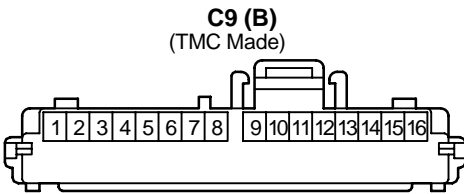
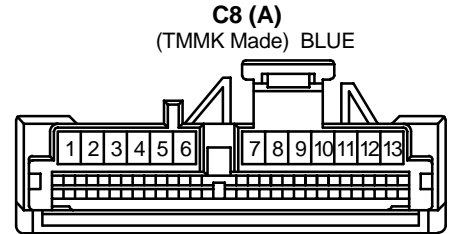
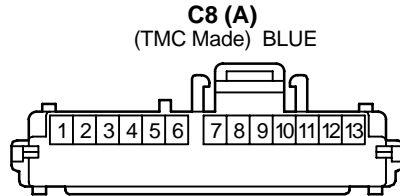

COMBINATION METER

J8 (B)
GRAY

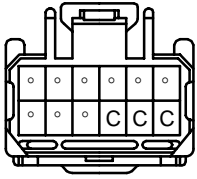

(Hint : See Page 7)

J11

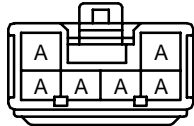

(Hint : See Page 7)

J15
BLACK

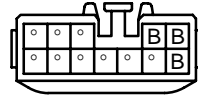

(Hint : See Page 7)

J16
BLACK

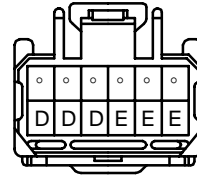

(Hint : See Page 7)

J21
GRAY

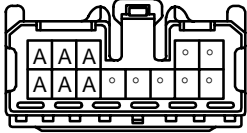

(Hint : See Page 7)

J24

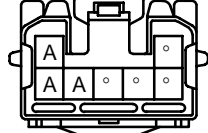

(Hint : See Page 7)

J28

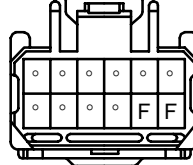

(Hint : See Page 7)

J29

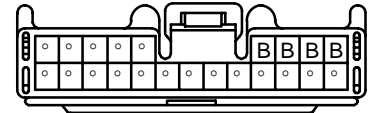

(Hint : See Page 7)

J30
GRAY

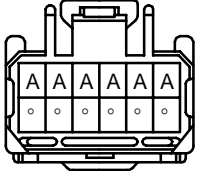

(Hint : See Page 7)

O1
GRAY



P1
GRAY

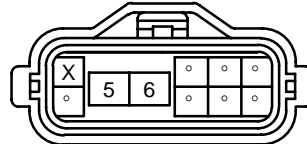

P3



R7
BLACK



V2
BLACK



W1
BLACK

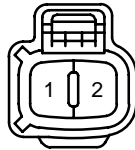

W3
(1MZ-FE) DARK GRAY



W3
(5S-FE) GRAY



RADIATOR FAN AND CONDENSER FAN

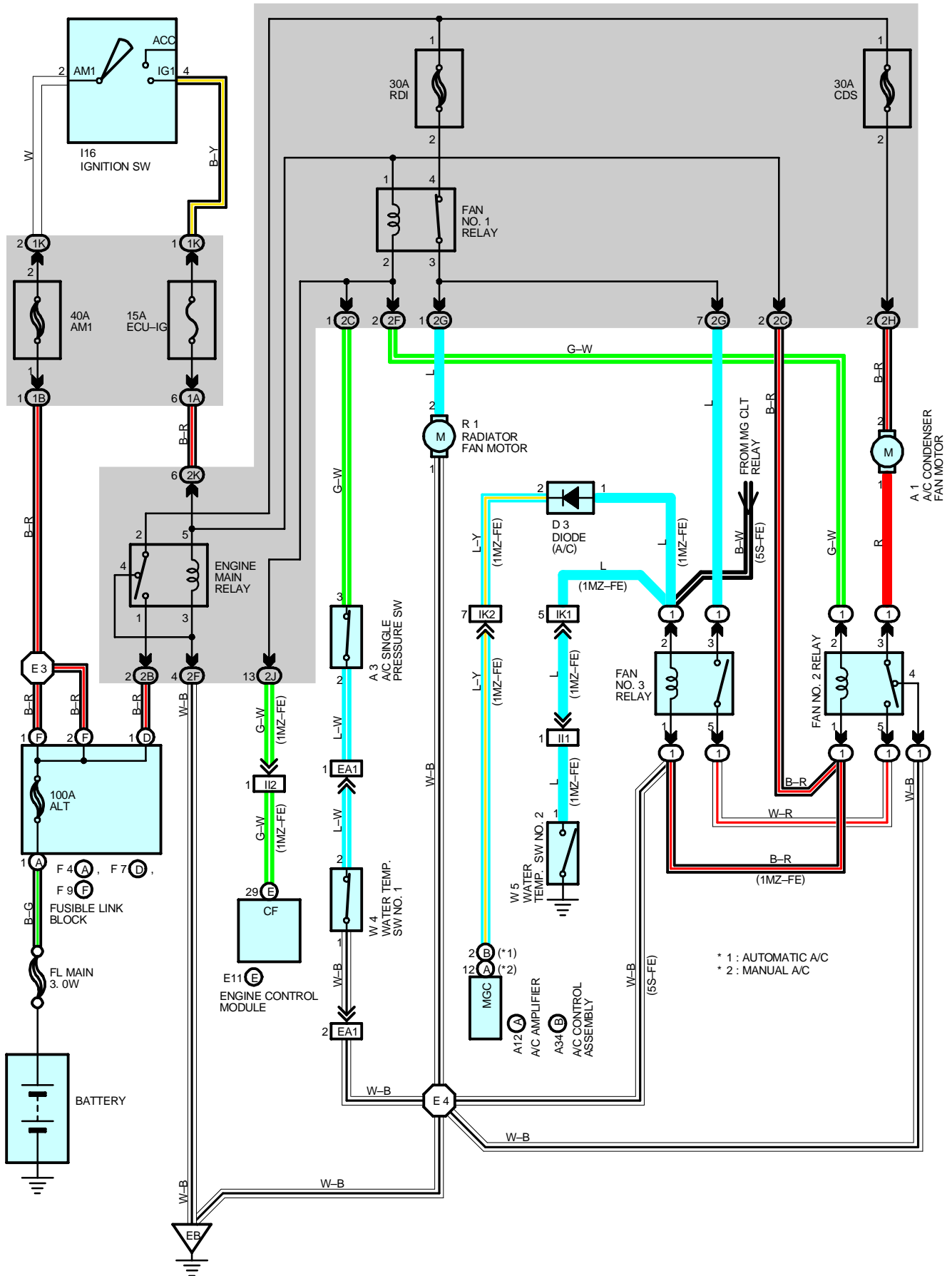

SYSTEM OUTLINE

FAN MOTOR OPERATION (1MZ-FE)

With the ignition SW turned on, the current through the ECU-IG fuse flows to the FAN NO.1 relay (Coil side), FAN NO.2 relay (Coil side) and FAN NO.3 relay (Coil side). Furthermore, the current through the FAN NO.1 relay (Coil side) or the FAN NO.2 relay (Coil side) flows to TERMINAL 3 of the A/C single pressure SW to TERMINAL 2 to TERMINAL 2 of the water temp. SW No.1 to TERMINAL 1 to GROUND, causing the FAN NO.1 relay to turn off and the FAN NO.2 relay to turn on.

1. LOW SPEED OPERATION

Only when the A/C system is activated or the water temp. SW No.2 is turned on, the A/C condenser fan motor and the radiator fan motor rotates at low speed.

When the A/C system is activated, the current from ECU-IG fuse flows to the FAN NO.3 relay (Coil side) to TERMINAL 1 of the diode (A/C) to TERMINAL 2 to TERMINAL (A)12 of the A/C amplifier (Manual A/C) or (B) 2 of the A/C control assembly (Automatic A/C) causing the FAN NO.3 relay to turn on. As a result, the current through the CDS fuse flows to TERMINAL 2 of the A/C condenser fan motor to TERMINAL 1 to TERMINAL 3 of the FAN NO.2 relay to TERMINAL 5 to TERMINAL 5 of the FAN NO.3 relay to TERMINAL 3 to TERMINAL 2 of the radiator fan motor to TERMINAL 1 to GROUND. As this flowing in series for the motors, the motors rotate at low speed.

When the water temp. SW No.2 is turned on, the current from ECU-IG fuse flows to the FAN NO.3 relay (Coil side) to TERMINAL 1 of the water temp. SW No.2 to GROUND, causing the FAN NO.3 relay to turn on. As a result, the current through the CDS fuse flows the same route as above, rotating the motors at low speed.

2. HIGH SPEED OPERATION

Only when the A/C single pressure SW is turned off or the water temp. SW No.1 is turned off, the A/C condenser fan motor and the radiator fan motor rotate at high speed.

When the A/C single pressure SW is turned off, the current from the RDI fuse flows to the FAN NO.1 relay (Point side) to TERMINAL 2 of the radiator fan motor to TERMINAL 1 to GROUND. At the same time, the current from the CDS fuse flows to TERMINAL 2 of the A/C condenser fan motor to TERMINAL 1 to TERMINAL 3 of the FAN NO.2 relay to TERMINAL 4 to GROUND.

As the current flowing in parallel for the motors as above, the motors rotate at high speed.

FAN MOTOR OPERATION (5S-FE)

With the ignition SW turned on, the current through the ECU-IG fuse flows to the FAN NO.1 relay (Coil side), FAN NO.2 relay (Coil side). furthermore, the current through the FAN NO.1 relay (Coil side) or the FAN NO.2 relay (Coil side) flows to TERMINAL 3 of the A/C single pressure SW to TERMINAL 2 to TERMINAL 2 of the water temp. SW No.1 to TERMINAL 1 to GROUND, causing the FAN NO.1 relay to turn off and the FAN NO.2 relay to turn on.

1. LOW SPEED OPERATION

When the ignition SW is turned on and the A/C system is activated, the A/C condenser fan motor and the radiator fan motor rotates at low speed.

When the A/C system is activated, the current from MG CLT relay flows to the FAN NO.3 relay (Coil side) to GROUND, causing the FAN NO.3 relay to turn on. As a result, the current through the CDS fuse flows to TERMINAL 2 of the A/C condenser fan motor to TERMINAL 1 to TERMINAL 3 of the FAN NO.2 relay to TERMINAL 5 to TERMINAL 5 of the FAN NO.3 relay to TERMINAL 3 to TERMINAL 2 of the radiator fan motor to TERMINAL 1 to GROUND. As this flowing in series for the motors, the motors rotate at low speed.

2. HIGH SPEED OPERATION

Only when the A/C single pressure SW is turned off or the water temp. SW No.1 is turned off, the A/C condenser fan motor and the radiator fan motor rotate at high speed.

When the A/C single pressure SW is turned off, the current from the RDI fuse flows to the FAN NO.1 relay (Point side) to TERMINAL 2 of the radiator fan motor to TERMINAL 1 to GROUND. At the same time, the current from the CDS fuse flows to TERMINAL 2 of the A/C condenser fan motor to TERMINAL 1 to TERMINAL 3 of the FAN NO.2 relay to TERMINAL 4 to GROUND.

As the current flowing in parallel for the motors as above, the motors rotate at high speed.

SERVICE HINTS

A3 A/C SINGLE PRESSURE SW

3-2 : Open above approx. **15.5 kgf/cm² (224 psi, 1520 kpa)**
Closed below approx. **12.5 kgf/cm² (181 psi, 1225 kpa)**

W4 WATER TEMP. SW NO.1

2-1 : Open above approx. **95°C (203° F)**

W5 WATER TEMP. SW NO.2 (1MZ-FE)

1-GROUND : Closed above approx. **90°C (194°F)**

RADIATOR FAN AND CONDENSER FAN

: PARTS LOCATION

Code	See Page	Code	See Page	Code	See Page	
A1	26 (1MZ-FE)	E11	E	30	I16	30
	28 (5S-FE)	F4	A	26 (1MZ-FE)	R1	27 (1MZ-FE)
A3	26 (1MZ-FE)			28 (5S-FE)		29 (5S-FE)
	A12	A	F7	D	W4	26 (1MZ-FE)
28 (5S-FE)						27 (1MZ-FE)
A34	B	F9	F	W5	26 (1MZ-FE)	27 (1MZ-FE)
D3	26 (1MZ-FE)				28 (5S-FE)	

: RELAY BLOCKS

Code	See Page	Relay Blocks (Relay Block Location)
1	24	Engine Room R/B No.1 (Engine Compartment Left)

: JUNCTION BLOCK AND WIRE HARNESS CONNECTOR

Code	See Page	Junction Block and Wire Harness (Connector Location)
1A	20	Cowl Wire and Instrument Panel J/B (Lower Finish Panel)
1B		
1K		
2B	22	Engine Room Main Wire and Engine Room J/B No.2 (Engine Compartment Left)
2C		
2F		
2G		
2H		
2J	22	Cowl Wire and Engine Room J/B No.2 (Engine Compartment Left)
2K		

: CONNECTOR JOINING WIRE HARNESS AND WIRE HARNESS

Code	See Page	Joining Wire Harness and Wire Harness (Connector Location)
EA1	36 (1MZ-FE)	Engine Room Main Wire and Engine Room Main No.3 Wire (Radiator LH)
	38 (5S-FE)	
II1	42	Engine Wire and Cowl Wire (Under the Blower Motor)
II2		
IK1	42	Engine Room Main Wire and Cowl Wire (Right Kick Panel)
IK2		

: GROUND POINTS

Code	See Page	Ground Points Location
EB	36 (1MZ-FE)	Left Radiator Side Support
	38 (5S-FE)	

: SPLICE POINTS

Code	See Page	Wire Harness with Splice Points	Code	See Page	Wire Harness with Splice Points
E3	36 (1MZ-FE)	Cowl Wire	E4	36 (1MZ-FE)	Engine Room Main Wire
	38 (5S-FE)			38 (5S-FE)	

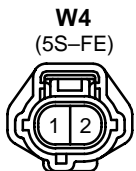
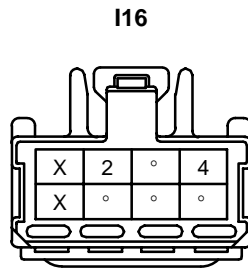
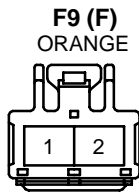
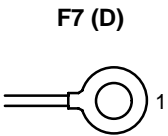
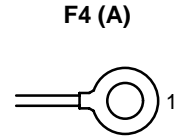
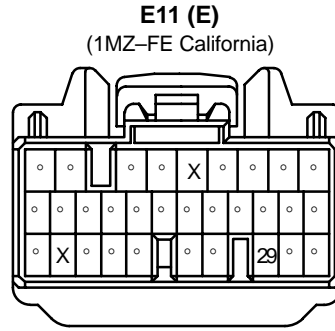
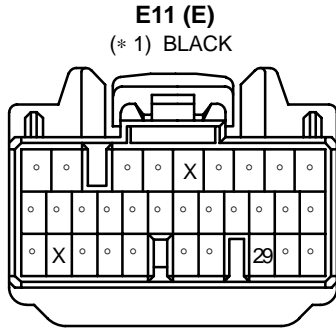
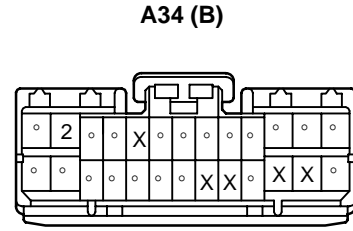
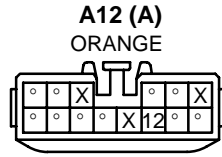
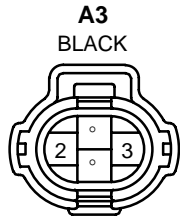
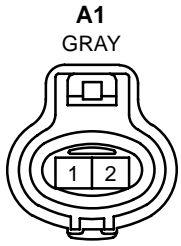

AIR CONDITIONING (AUTOMATIC A/C)

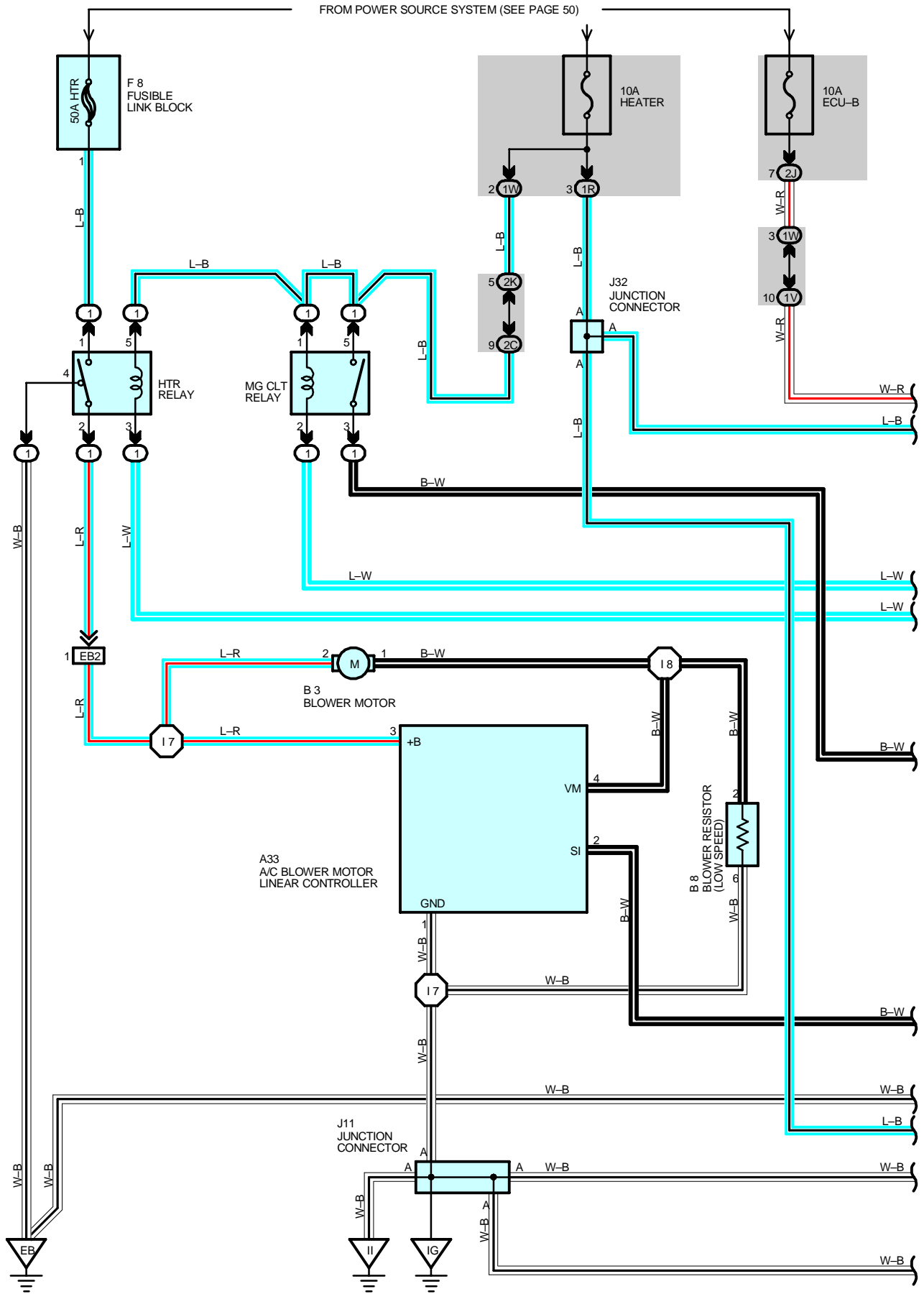

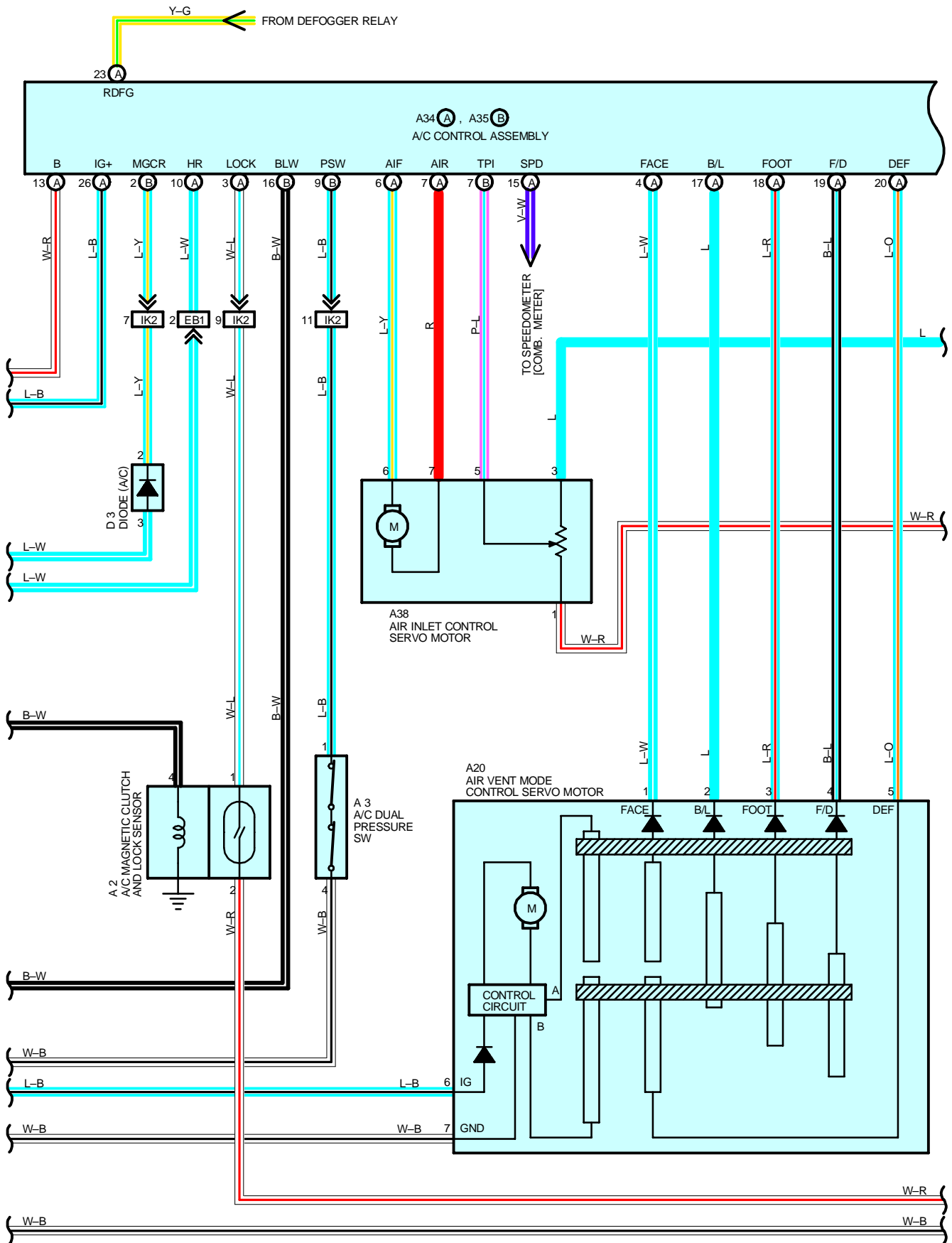

AIR CONDITIONING (AUTOMATIC A/C)

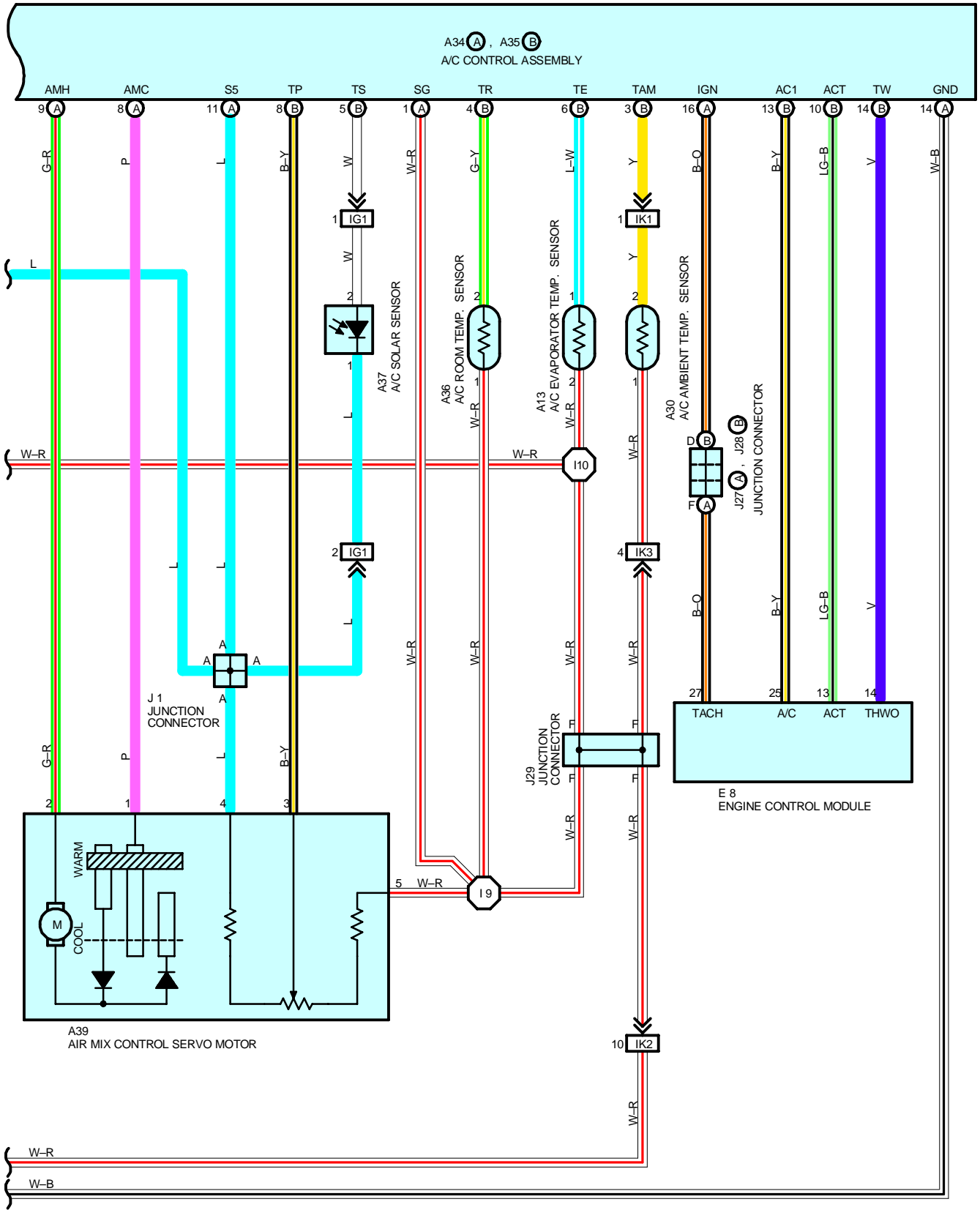

SYSTEM OUTLINE

1. HEATER BLOWER MOTOR OPERATION

Current is applied at all times through HTR fuse to TERMINAL 1 of the HTR relay. When the ignition SW is turned on, current flows through the HEATER fuse to TERMINAL 5 of the HTR relay to TERMINAL 3 to TERMINAL HR of the A/C control assembly. At the same time, current also flows from HEATER fuse to TERMINAL IG+ of the A/C control assembly.

* Low speed operation

When the blower SW (A/C control assembly) is pushed to LOW SPEED position, the current to TERMINAL HR of the A/C control assembly flows to TERMINAL GND of the A/C control assembly to GROUND and turns the HTR relay on. As a result, the current to TERMINAL 1 of the HTR relay flows to TERMINAL 2 of the relay to TERMINAL 2 of the blower motor to TERMINAL 1 to TERMINAL 2 of the blower resistor to TERMINAL 6 to GROUND and causes the blower motor to rotate at low speed.

* High speed operation

When the blower SW (A/C control assembly) is pushed to HIGH SPEED position, the current to TERMINAL HR of the A/C control assembly flows to TERMINAL GND of the A/C control assembly to GROUND and turns the HTR relay on. As a result, the current to TERMINAL 1 of the HTR relay flows to TERMINAL 2 to TERMINAL 2 of the blower motor to TERMINAL 1 to TERMINAL 4 of the A/C blower motor linear controller to TERMINAL 2 to TERMINAL BLW of the A/C control assembly (Which is activated when the blower SW is pushed to high speed position) to TERMINAL GND to GROUND without passing through the blower resistor, causing the blower motor to rotate at high speed.

2. AIR INLET CONTROL SERVO MOTOR OPERATION

(Switching from FRESH to RECIRC)

With the ignition SW turned on, the current flows from HEATER fuse to TERMINAL IG+ of the A/C control assembly to TERMINAL AIR to TERMINAL 7 of the air inlet control servo motor to TERMINAL 6 to TERMINAL AIF of the A/C control assembly to TERMINAL GND to GROUND, the motor rotates and the damper moves to the RECIRC side. When the damper operates with the A/C SW at RECIRC position, the damper position signal is input from TERMINAL 5 of the servo motor to TERMINAL TPI of the A/C control assembly. As a result, current to the servo motor circuit is cut off by the A/C control assembly, so the damper stops at that position.

(Switching from RECIRC to FRESH)

With the ignition SW turned on, when the RECIRC/FRESH SW is switched to the FRESH side, the current flows from TERMINAL IG+ of the A/C control assembly to TERMINAL AIF to TERMINAL 6 of the air inlet control servo motor to TERMINAL 7 to TERMINAL AIR of the A/C control assembly to TERMINAL GND to GROUND, The motor rotates and the damper stops at that position.

3. AIR VENT MODE CONTROL SERVO MOTOR OPERATION

When the ignition SW turned on, the current flows from HEATER fuse to TERMINAL IG+ of the A/C control assembly.

(Switching from DEF to FACE)

The current flows from TERMINAL FACE of the A/C control assembly to TERMINAL 1 of the air vent mode control servo motor to TERMINAL 5 to TERMINAL DEF of the A/C control assembly to TERMINAL GND to GROUND. The motor rotates and the damper moves to the FACE side. When the damper operates with the A/C SW at FACE position, the damper position signal is input from TERMINAL 5 of the servo motor to the TERMINAL DEF of the A/C control assembly. As a result, current to the servo motor circuit is cut off by the A/C control assembly, so the damper stops at that position.

(Switching from FACE to DEF)

The current flows from TERMINAL DEF of the A/C control assembly to TERMINAL 5 of the air vent control servo motor to TERMINAL 1 to TERMINAL FACE of the A/C control assembly to TERMINAL GND to GROUND, the motor rotates and the damper stops at that position.

4. AIR MIX CONTROL SERVO MOTOR OPERATION

When the temperature control SW (A/C control assembly) is turned to the "COOL" side the current flows from TERMINAL AMC of the A/C control assembly to TERMINAL 1 of the air mix control servo motor to motor to TERMINAL 2 to TERMINAL AMH of the A/C control assembly to GROUND and the motor rotates. The damper opening angle at this time is input from TERMINAL 3 of the servo motor to TERMINAL TP of the A/C control assembly, this is used to determine the DAMPER STOP position and maintain the set temperature.

When the temperature control SW (A/C control assembly) is turned to the "HOT" side, the current flows from servo motor to TERMINAL AMH of the A/C control assembly to TERMINAL 2 of the air mix control servo motor to motor to TERMINAL 1 to TERMINAL AMC of the A/C control assembly, rotating the motor in reverse and switching the damper from "COOL" to "HOT" side.

AIR CONDITIONING (AUTOMATIC A/C)

5. AIR CONDITIONING OPERATION

The A/C control assembly receives various signals, I.E., the engine RPM from the engine control module, outside air temperature signal from the A/C ambient temp. sensor, coolant temperature from the engine control module and the lock signal from the A/C compressor, etc.

When the engine is started and the A/C SW (A/C control assembly) is on, a signal is input to the A/C control assembly.

As a result, the ground circuit in A/C control assembly is closed and current flows from HEATER fuse to TERMINAL 1 of the MG CLT relay to TERMINAL 2 to TERMINAL 3 of the diode (A/C) to TERMINAL 2 to TERMINAL MGCR of the A/C control assembly to TERMINAL GND to GROUND, turning the MG CLT relay on, so that the magnetic clutch is on and the A/C compressor operates.

At the same time, the engine control module detects the magnetic clutch is on and the A/C compressor operates.

If the A/C control assembly detects the following conditions, it stops the air conditioning:

- * Evaporator outlet air is too low.
- * There is a marked difference between the compressor speed and the engine speed.
- * The refrigerant pressure is abnormally high or abnormally low.
- * The engine speed is too low.
- * Rapid acceleration occurs.

SERVICE HINTS

A3 A/C DUAL PRESSURE SW

4-1 : Open above approx. **2.0 kgf/cm² (29 psi, 196 kpa)** or **32 kgf/cm² (464 psi, 3138 kpa)**

A2 A/C MAGNETIC CLUTCH AND LOCK SENSOR

4-GROUND : Approx. **3.7 Ω**

A34 (A), A35 (B) A/C CONTROL ASSEMBLY

B-GROUND : Always approx. **12 volts**

IG+ -GROUND : Approx. **12 volts** with the ignition SW at **ON** position

HR -GROUND : Approx. **12 volts** with the ignition SW at **ON** position and do not turn the blower motor

Below **1 volts** with the ignition SW at **ON** position and turn the blower motor

PSW-GROUND : Below **1 volts** with the ignition SW at **ON** position

AC1-GROUND : Below **1 volts** at start the engine, operate the compressor

+ OR MORE volts at start the engine, do not operate the compressor

BLW-GROUND : Below **1.5 volts** with the ignition SW on and turn the blower motor

S5-SG : **4-6 volts** with the ignition SW at **ON** position

SG-GROUND : Always continuity

AMH-AMC : **1.3-1.9 volts** with the ignition SW off

AIF-GROUND : Approx. **12 volts** with the FRESH SW on

AIR-GROUND : Approx. **12 volts** with the RECIRC SW on

FACE-GROUND : Approx. **12 volts** with the FACE SW on

DEF-GROUND : Approx. **12 volts** with the DEF SW on

GND-GROUND : Always continuity

○ : PARTS LOCATION

Code	See Page	Code	See Page	Code	See Page
A2	26 (1MZ-FE)	A36	30	F8	26 (1MZ-FE)
A3	26 (1MZ-FE)	A37	30	J1	31
A13	30	A38	30	J11	31
A20	30	A39	30	J27	A 31
A30	26 (1MZ-FE)	B3	30	J28	B 31
A33	30	B8	30	J29	31
A34	A 30	D3	30	J32	31
A35	B 30	E8	30		

○ : RELAY BLOCKS

Code	See Page	Relay Blocks (Relay Block Location)
1	24	Engine Room R/B No.1 (Engine Compartment Left)

○ : JUNCTION BLOCK AND WIRE HARNESS CONNECTOR

Code	See Page	Junction Block and Wire Harness (Connector Location)
1R	20	Cowl Wire and Instrument Panel J/B (Lower Finish Panel)
1V		
1W		
2C	22	Engine Room Main Wire and Engine Room J/B No.2 (Engine Compartment Left)
2J	22	Cowl Wire and Engine Room J/B No.2 (Engine Compartment Left)
2K		

□ : CONNECTOR JOINING WIRE HARNESS AND WIRE HARNESS

Code	See Page	Joining Wire Harness and Wire Harness (Connector Location)
EB2	36 (1MZ-FE)	Cowl Wire and Engine Room Main Wire (Under the Engine Room J/B No.2)
IG1	40	Instrument Panel Wire and Cowl Wire (Lower Finish Panel)
IK1	42	Engine Room Main Wire and Cowl Wire (Right Kick Panel)
IK2		
IK3		

▽ : GROUND POINTS

Code	See Page	Ground Points Location
EB	36 (1MZ-FE)	Left Radiator Side Support
IG	40	Instrument Panel Brace LH
II	40	Cowl Side Panel RH

○ : SPLICE POINTS

Code	See Page	Wire Harness with Splice Points	Code	See Page	Wire Harness with Splice Points
I7	42	Cowl Wire	I9	42	Cowl Wire
I8			I10		

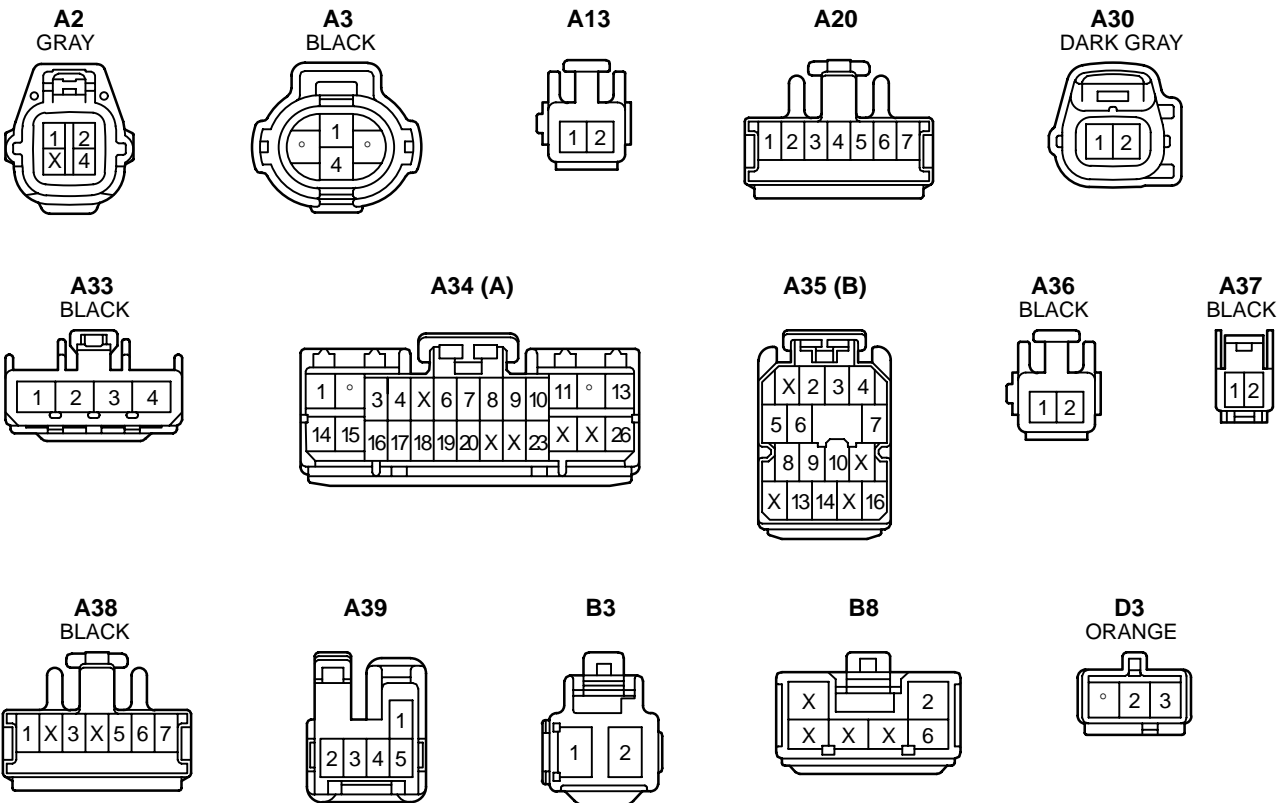

AIR CONDITIONING (AUTOMATIC A/C)

E8

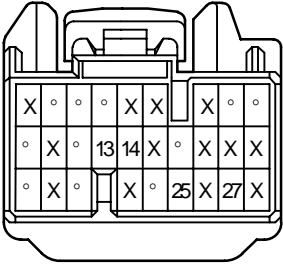

F8

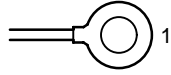

J1

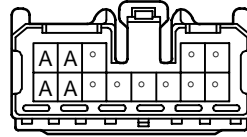

(Hint : See Page 7)

J11

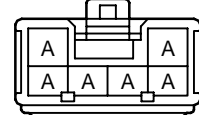

(Hint : See Page 7)

J27 (A)

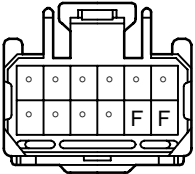

(Hint : See Page 7)

J28 (B)

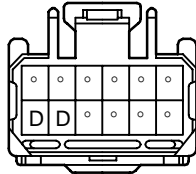

(Hint : See Page 7)

J29

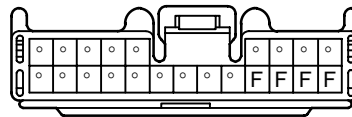

(Hint : See Page 7)

**J32
GRAY**

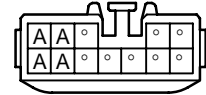

(Hint : See Page 7)

AIR CONDITIONING (MANUAL A/C)

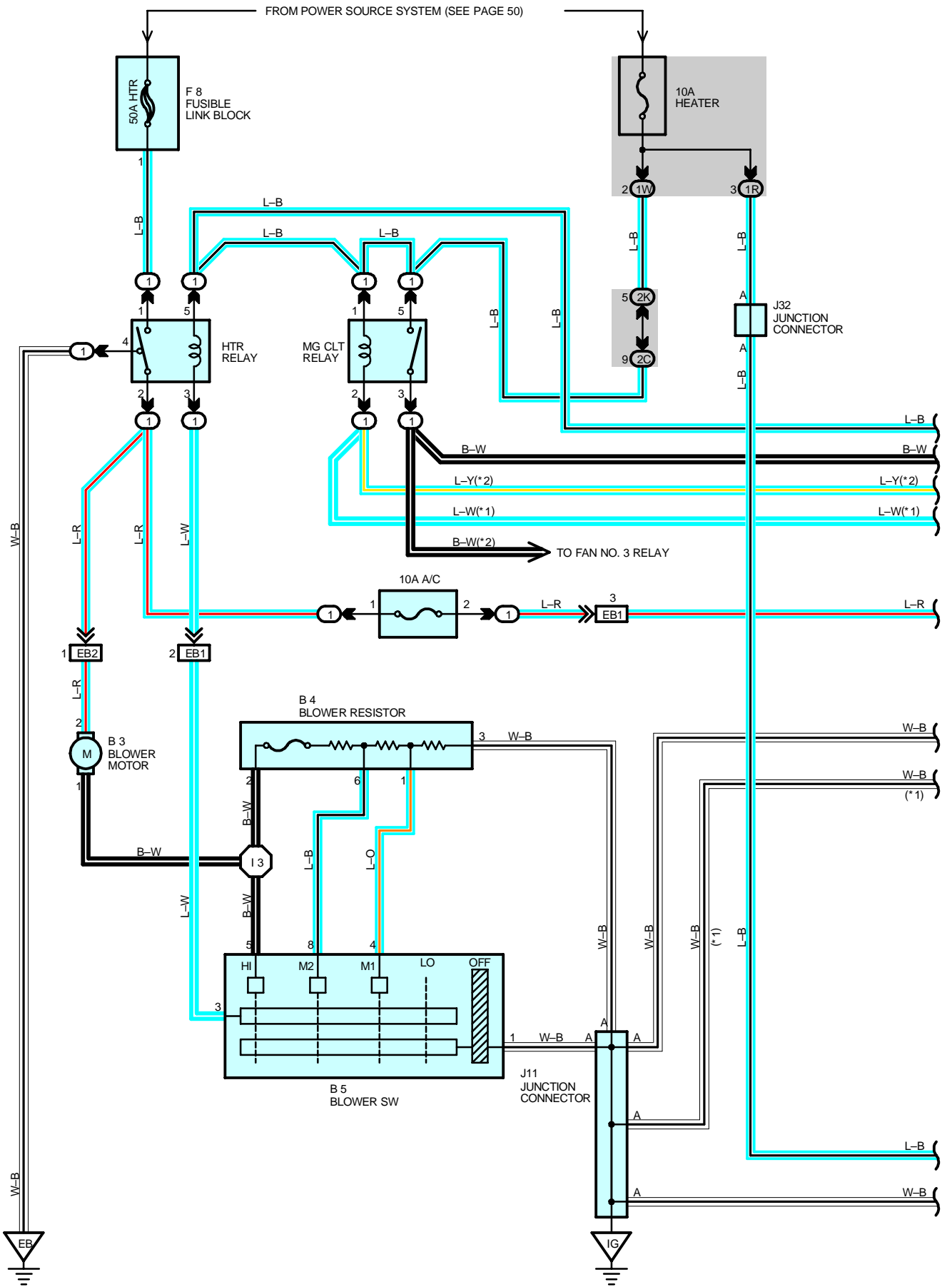

* 1 : 1MZ-FE
 * 2 : 5S-FE

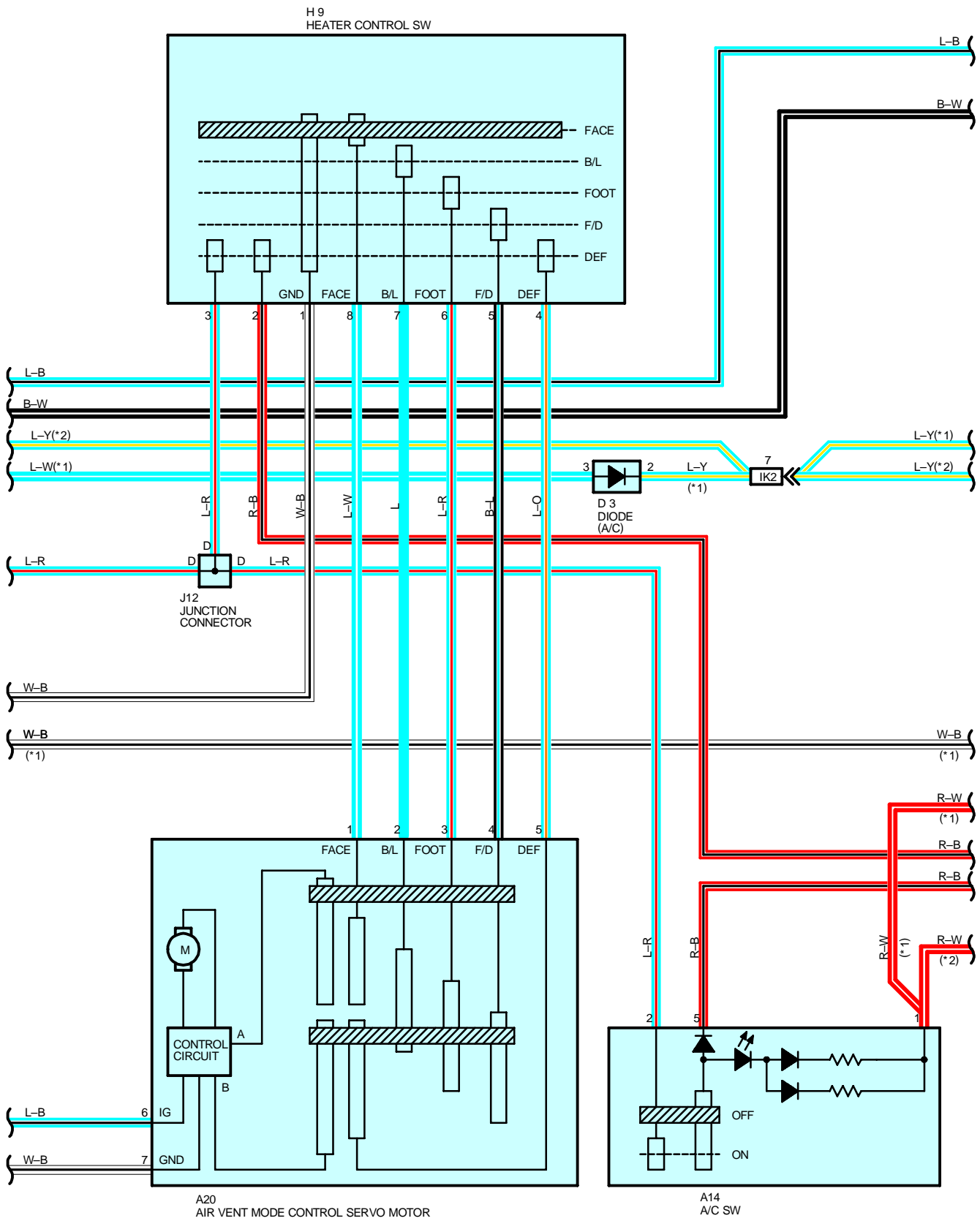

AIR CONDITIONING (MANUAL A/C)

- * 1 : 1MZ-FE
- * 2 : 5S-FE
- * 3 : 5S-FE W/ ENGINE IMMOBILISER
- * 4 : 5S-FE W/O ENGINE IMMOBILISER

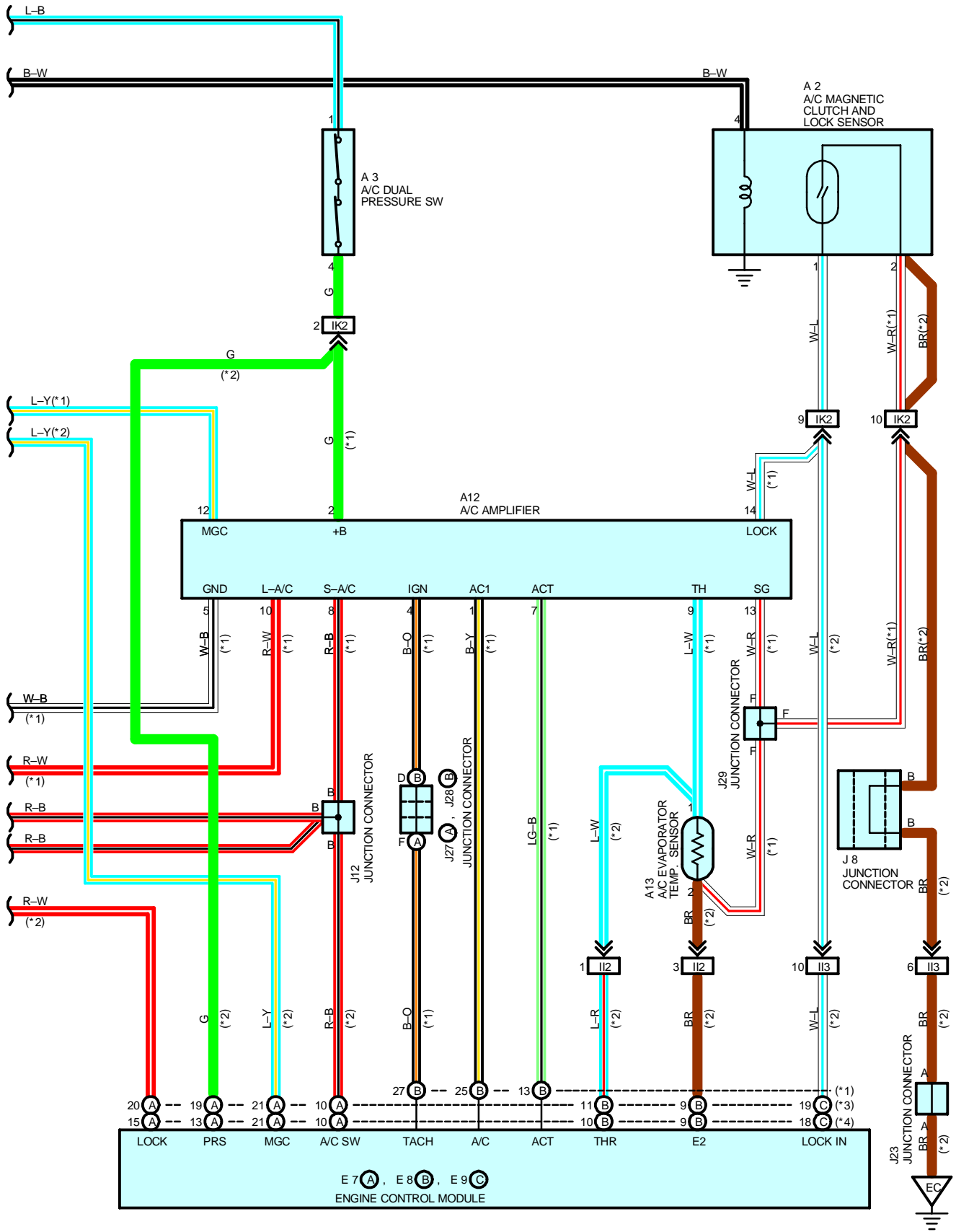

SYSTEM OUTLINE

Current always flows from the HTR fuse to TERMINAL 1 of the HTR relay. When the ignition SW is turned on, the current from the HEATER fuse flows to TERMINAL 6 of the air vent mode control servo motor, to the MG CLT relay (Coil side) to TERMINAL MGC of the A/C amplifier (1MZ-FE) or TERMINAL MGC of the engine control module (5S-FE), to TERMINAL 1 of the A/C dual pressure SW to TERMINAL 4 to TERMINAL +B of the A/C amplifier (1MZ-FE) or TERMINAL PRS of the engine control module (5S-FE), current also to the HTR relay (Coil side) to TERMINAL 3 of the blower SW.

1. AIR VENT MODE CONTROL SERVO MOTOR OPERATION

When the damper is in FACE position and B/L mode on the heater control SW is selected, current flows from TERMINAL 7 of the heater control SW to TERMINAL 2 of the air vent mode control servo motor so that a signal that the ground circuit is activated is input into TERMINAL B of the control circuit inside the air vent mode control servo motor. Simultaneously, a signal that the ground circuit is not activated is input into TERMINAL A of the control circuit inside the servo motor. These two signals activate the control circuit so that current flows from the HEATER fuse to the servo motor, causing the servo motor to operate and the damper to move to B/L position. When the damper reaches B/L position. A ground cut signal is input into TERMINAL B of the control circuit, the control circuit operates, the servo motor stops rotating and the damper stops at B/L. When another mode position is selected, input of signals into TERMINAL A and TERMINAL B of the control circuit that ground is made or not (as explained above) activates the control circuit and moves the servo motor to the desired position.

2. AIR CONDITIONING OPERATION

When the blower SW is on, current flows from the HEATER fuse to the HTR relay (Coil side) to TERMINAL 3 of the blower SW to TERMINAL 1 to GROUND, activating the HTR relay. This causes current to flow from the HTR fuse to the HTR relay (Point side) to A/C fuse to TERMINAL 2 of the A/C SW. If the A/C SW is turned on at this time, a signal is input into the A/C amplifier (1MZ-FE) or engine control module (5S-FE). This activates the A/C amplifier (1MZ-FE) or engine control module (5S-FE) and MG CLT relay so that current flows from the HEATER fuse to the MG CLT relay (Point side) to A/C magnetic clutch. Causing The compressor to operate.

When blower SW is on and heater control SW is at DEF position, it causes A/C to run whether A/C SW is on or not.

SERVICE HINTS

HTR RELAY [R/B NO.1]

1-2 : Closed with the ignition SW on and the blower SW on

MG CLT RELAY [R/B NO.1]

5-3 : Closed with the ignition SW on, the blower SW on and the A/C SW on or the heater control SW at **DEF** position

A3 A/C DUAL PRESSURE SW

1-4 : Open with pressure **2.0 kgf/cm² (29 psi, 196 kpa)** or above **32 kgf/cm² (464 psi, 3138 kpa)**

B4 BLOWER RESISTOR

6-1 : Approx. **0.62 Ω**

1-3 : Approx. **1.46 Ω**

2-6 : Approx. **0.38 Ω**

○ : PARTS LOCATION

Code	See Page	Code	See Page	Code	See Page		
A2	26 (1MZ-FE)	B4	30	J8	31		
	28 (5S-FE)	B5	30	J11	31		
A3	26 (1MZ-FE)	D3	26 (1MZ-FE)	J12	31		
	28 (5S-FE)	E7	A	30	J23	31	
A12	30	E8	B	30	J27	A	31
A13	30	E9	C	30	J28	B	31
A14	30	F8	26 (1MZ-FE)	J29	31		
A20	30		28 (5S-FE)	J32	31		
B3	30	H9	30				

○ : RELAY BLOCKS

Code	See Page	Relay Blocks (Relay Block Location)
1	24	Engine Room R/B No.1 (Engine Compartment Left)

AIR CONDITIONING (MANUAL A/C)

○ : JUNCTION BLOCK AND WIRE HARNESS CONNECTOR

Code	See Page	Junction Block and Wire Harness (Connector Location)
1R	20	Cowl Wire and Instrument Panel J/B (Lower Finish Panel)
1W		
2C	22	Engine Room Main Wire and Engine Room J/B No.2 (Engine Compartment Left)
2K	22	Cowl Wire and Engine Room J/B No.2 (Engine Compartment Left)

□ : CONNECTOR JOINING WIRE HARNESS AND WIRE HARNESS

Code	See Page	Joining Wire Harness and Wire Harness (Connector Location)
EB1	36 (1MZ-FE)	Cowl Wire and Engine Room Main Wire (Under the Engine Room J/B No.2)
	38 (5S-FE)	
EB2	36 (1MZ-FE)	
	38 (5S-FE)	
II2	42	Engine Wire and Cowl Wire (Under the Blower Motor)
II3		
IK2	42	Engine Room Main Wire and Cowl Wire (Right Kick Panel)

▽ : GROUND POINTS

Code	See Page	Ground Points Location
EB	36 (1MZ-FE)	Left Radiator Side Support
	38 (5S-FE)	
EC	38 (5S-FE)	Intake Manifold
IG	40	Instrument Panel Brace LH

○ : SPLICE POINTS

Code	See Page	Wire Harness with Splice Points	Code	See Page	Wire Harness with Splice Points
I3	42	Cowl Wire			

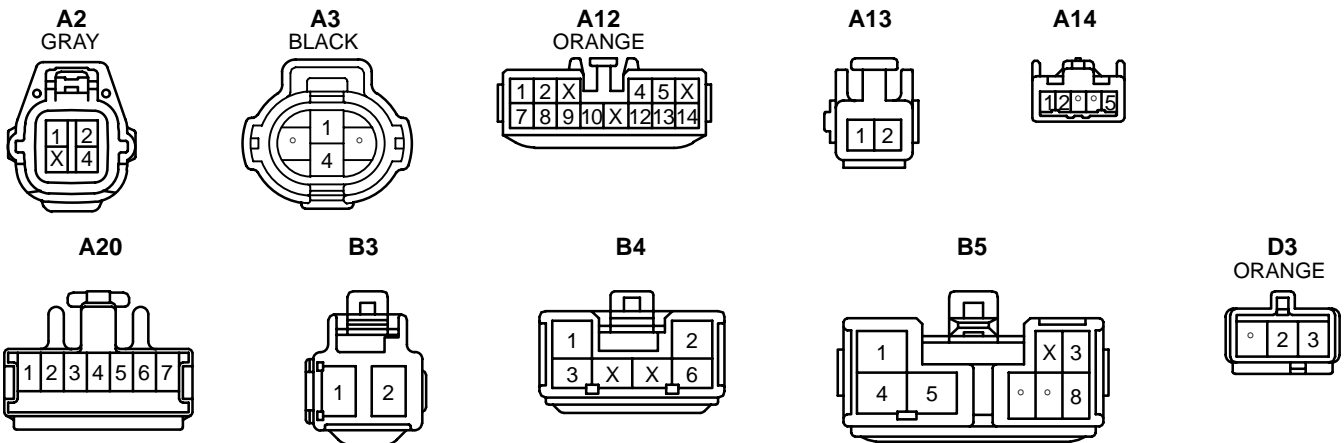

* 1 : 5S-FE w/ Engine Immobiliser System
 * 2 : 5S-FE w/o Engine Immobiliser System

E7 (A)
 (* 1)

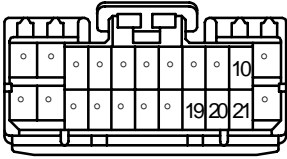

E7 (A)
 (* 2)

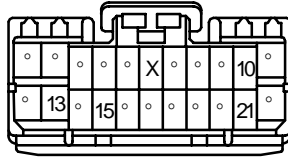

E8 (B)
 (1MZ-FE)

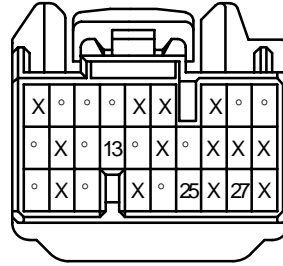

E8 (B)
 (* 1) DARK GRAY

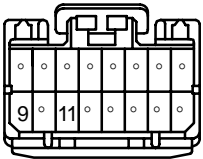

E8 (B)
 (* 2)

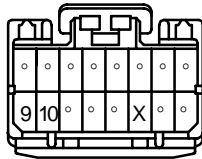

E9 (C)
 (* 1) DARK GRAY

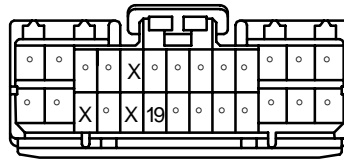

E9 (C)
 (* 2)

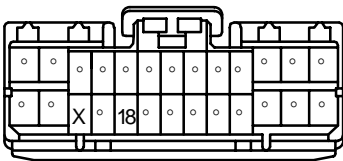

F8

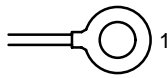

H9

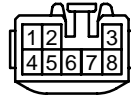

J8
 GRAY

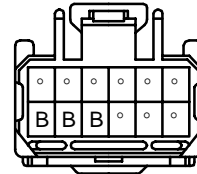

(Hint : See Page 7)

J11

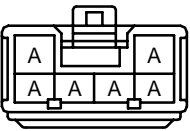

(Hint : See Page 7)

J12
 BLACK

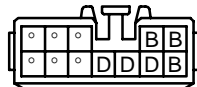

(Hint : See Page 7)

J23

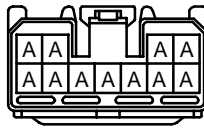

(Hint : See Page 7)

J27(A)

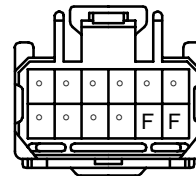

(Hint : See Page 7)

J28 (B)

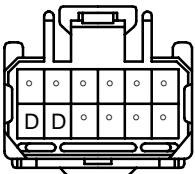

(Hint : See Page 7)

J29

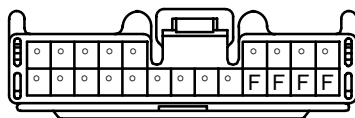

(Hint : See Page 7)

J32
 GRAY

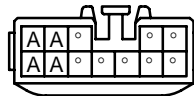

(Hint : See Page 7)

I GROUND POINT

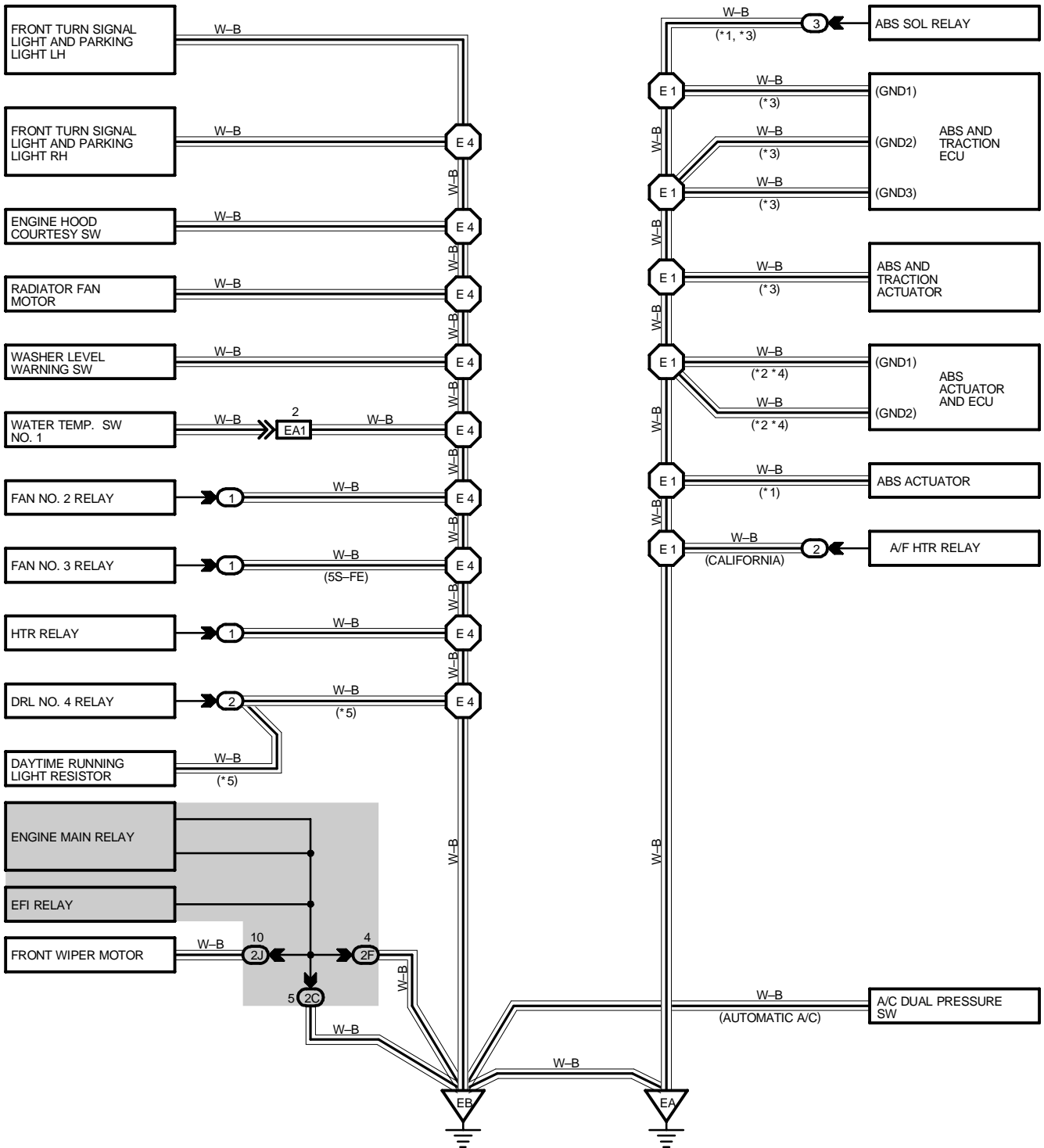

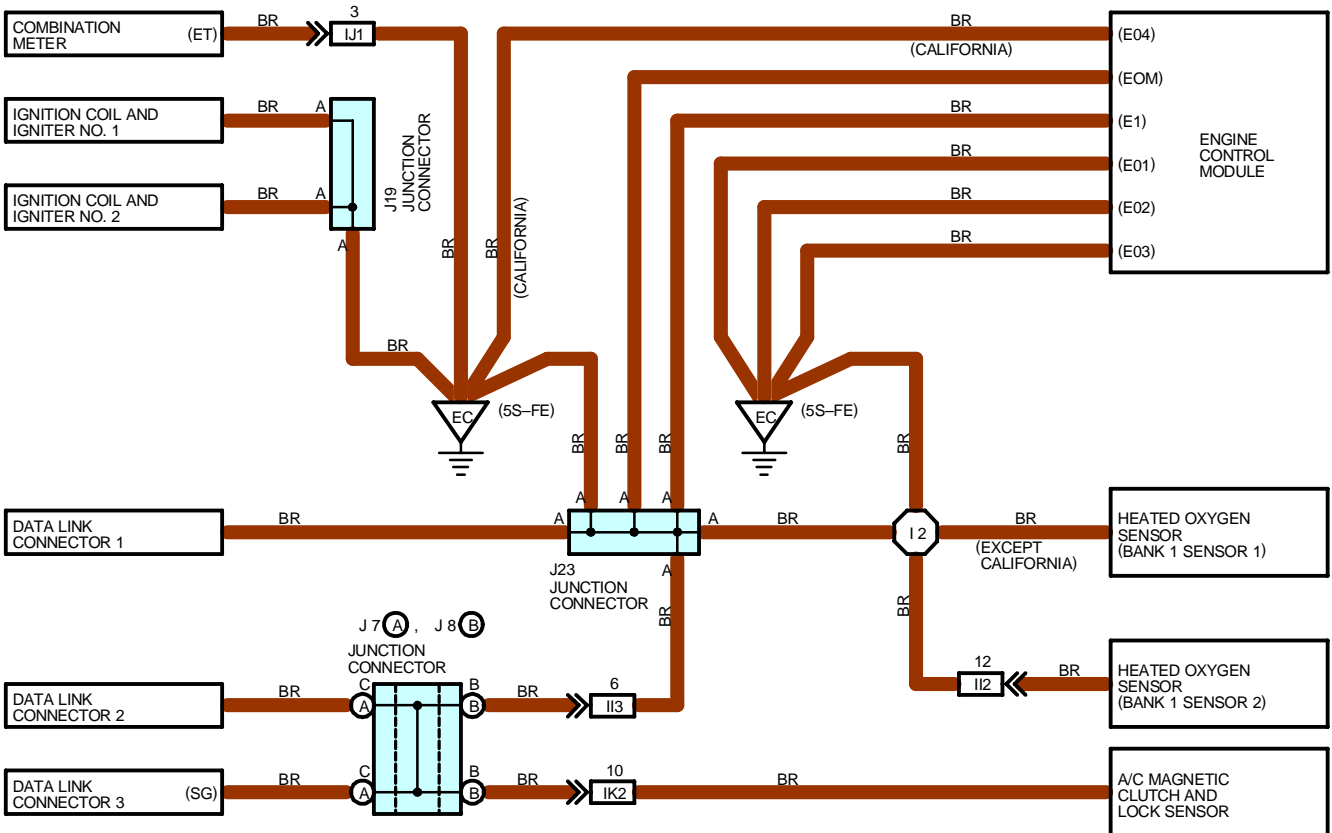
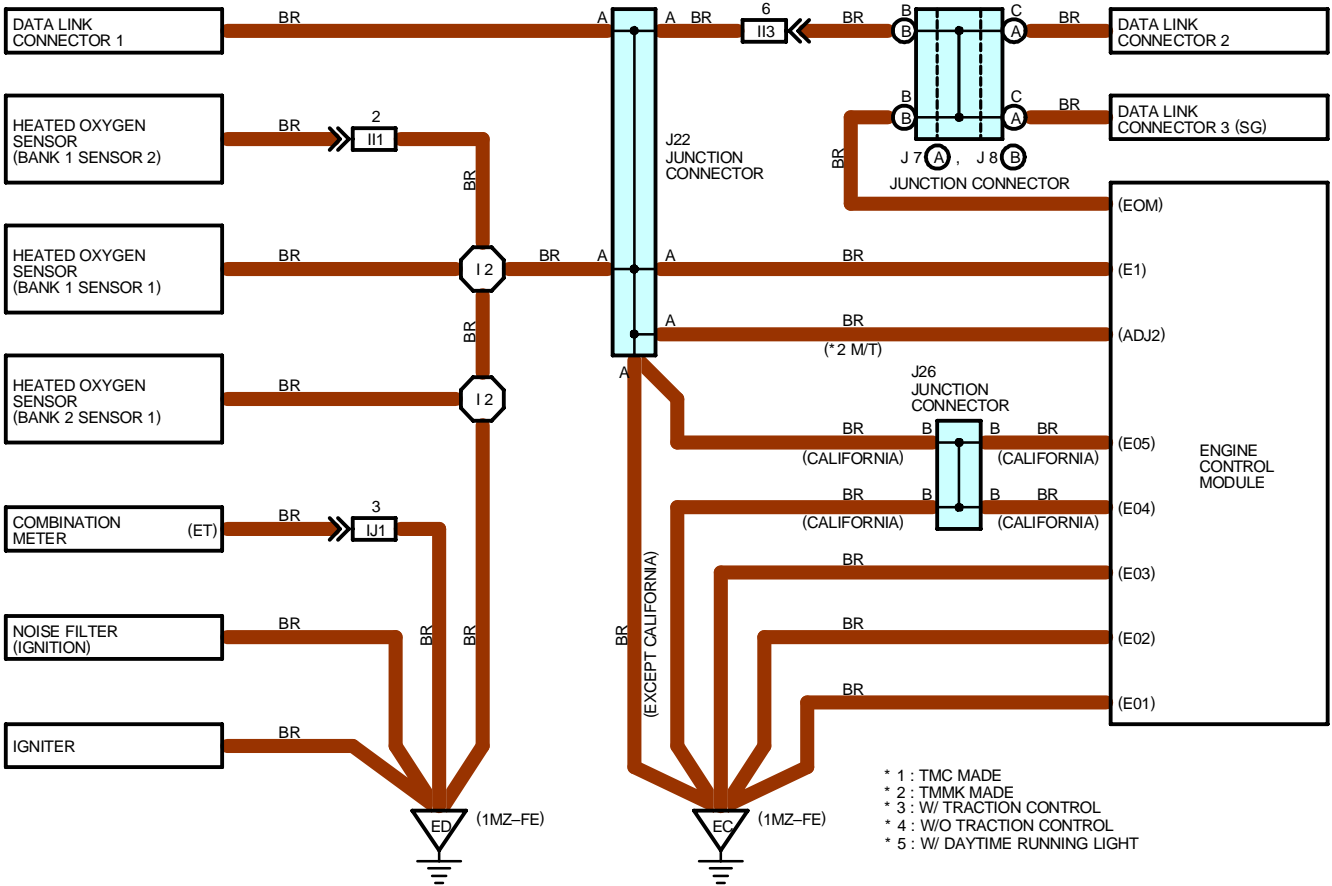

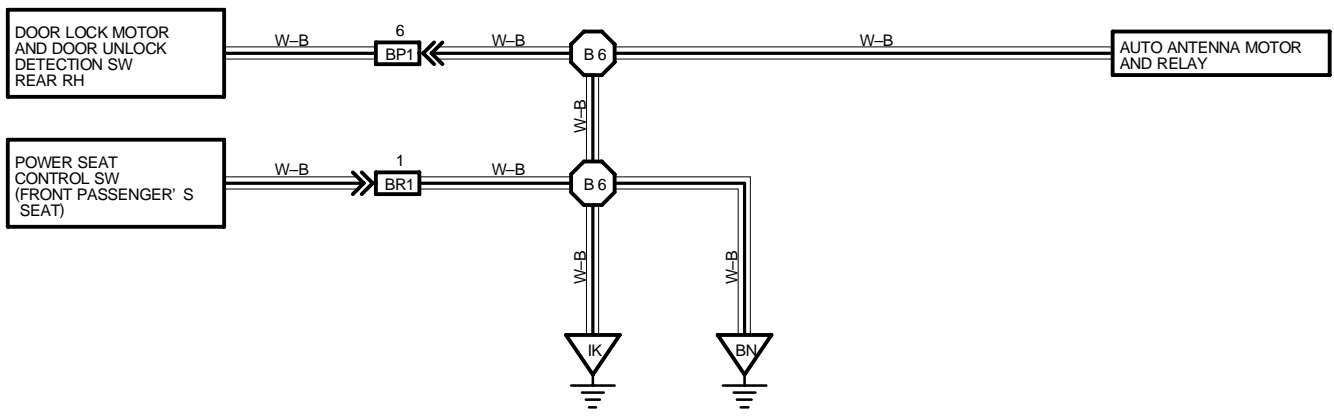
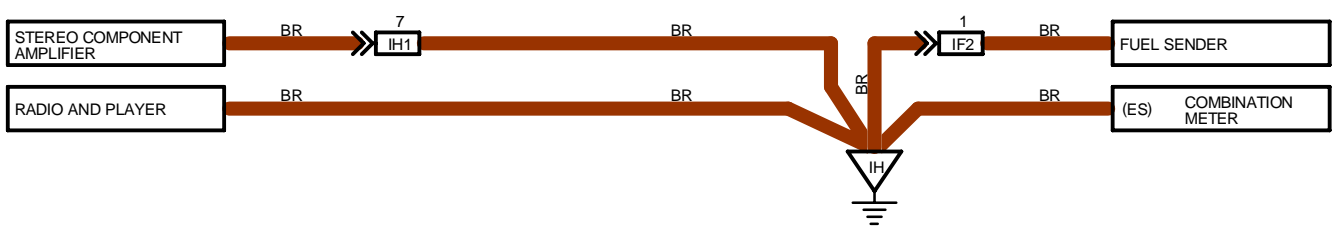
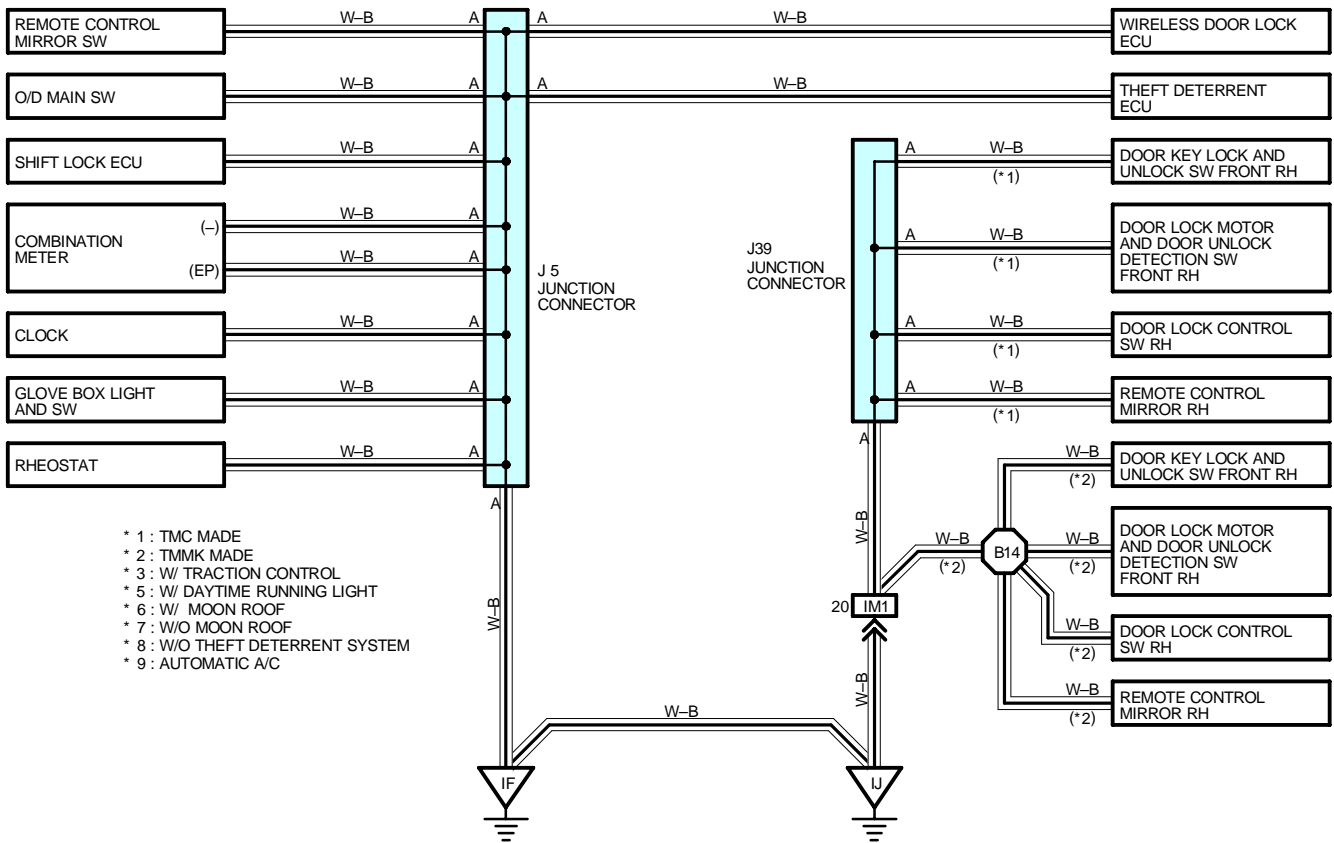

I GROUND POINT

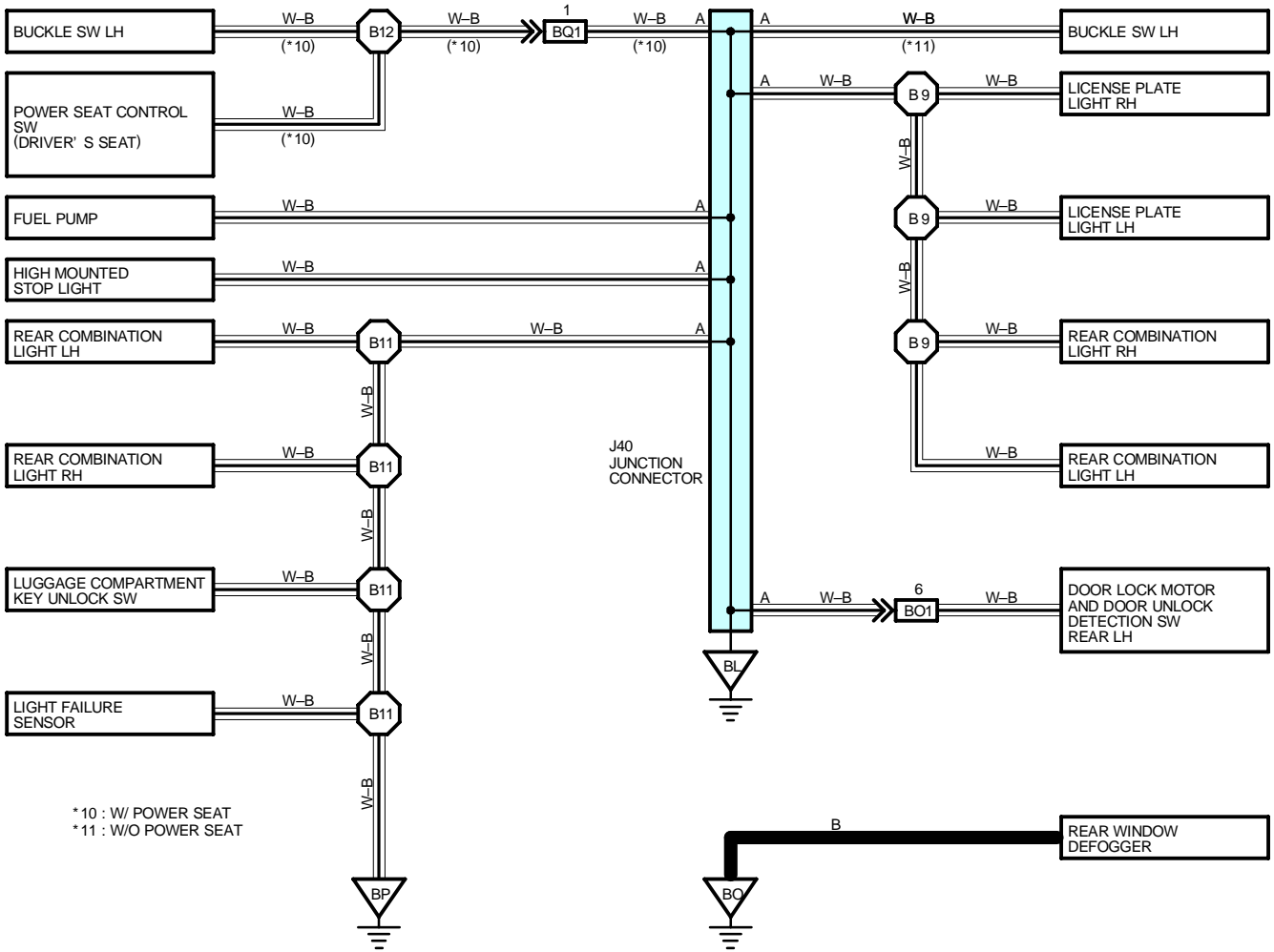

○ : PARTS LOCATION

Code	See Page	Code	See Page	Code	See Page
J5	31	J19	31	J38	32
J7	A 31	J22	31	J39	32
J8	B 31	J23	31	J40	32
J11	31	J26	31		

○ : RELAY BLOCKS

Code	See Page	Relay Blocks (Relay Block Location)
1	24	Engine Room R/B No.1 (Engine Compartment Left)
2	24	Engine Room R/B No.2 (Near The Battery)
3	25	Engine Room R/B No.3 (Radiator Upper Support RH)

○ : JUNCTION BLOCK AND WIRE HARNESS CONNECTOR

Code	See Page	Junction Block and Wire Harness (Connector Location)
1F	20	Roof Wire and Instrument Panel J/B (Lower Finish Panel)
1G	20	Instrument Panel Wire and Instrument Panel J/B (Lower Finish Panel)
1J	20	Cowl Wire and Instrument Panel J/B (Lower Finish Panel)
1M		
1N		
1V		
2C	22	Engine Room Main Wire and Engine Room J/B No.2 (Engine Compartment Left)
2F		
2J	22	Cowl Wire and Engine Room J/B No.2 (Engine Compartment Left)
2K		

□ : CONNECTOR JOINING WIRE HARNESS AND WIRE HARNESS

Code	See Page	Joining Wire Harness and Wire Harness (Connector Location)
EA1	36 (1MZ-FE)	Engine Room Main Wire and Engine Room Main No.3 Wire (Radiator LH)
	38 (5S-FE)	
IE1	40	Front Door LH Wire and Instrument Panel Wire (Left Kick Panel)
IF2	40	Floor Wire and Instrument Panel Wire (Left Kick Panel)
IH1	40	Instrument Panel Wire and Instrument Panel No.2 Wire (Instrument Panel Brace RH)
II1	42	Engine Wire and Cowl Wire (Under the Blower Motor)
II2		
II3		
IJ1	42	Engine Wire and Instrument Panel Wire (Under the Blower Motor)
IK2	42	Engine Room Main Wire and Cowl Wire (Right Kick Panel)
IM1	42	Front Door RH Wire and Instrument Panel Wire (Right Kick Panel)
BO1	44	Rear Door Wire LH and Floor Wire (Under the Left Center Pillar)
BP1	44	Rear Door Wire RH and Floor No.2 Wire (Under the Right Center Pillar)
BQ1	46	Floor Wire and Seat No.1 Wire (Under the Driver's Seat)
BR1	46	Floor No.2 Wire and Seat No.2 Wire (Under the Passenger's Seat)

I GROUND POINT

▽ : GROUND POINTS

Code	See Page	Ground Points Location
EA	36 (1MZ-FE)	Right Radiator Side Support
	38 (5S-FE)	
EB	36 (1MZ-FE)	Left Radiator Side Support
	38 (5S-FE)	
EC	36 (1MZ-FE)	Surge Tank RH
	38 (5S-FE)	Intake Manifold
ED	36 (1MZ-FE)	Rear Side of the Surge Tank
IE	40	Cowl Side Panel LH
IF	40	Left Kick Panel
IG	40	Instrument Panel Brace LH
IH	40	Instrument Panel Brace RH
II	40	Cowl Side Panel RH
IJ	40	Right Kick Panel
IK		
BL	44	Under the Left Center Pillar
BM	44	Roof Left
BN	44	Under the Right Center Pillar
BO	44	Right Quarter Pillar
BP	44	Back Panel Center

○ : SPLICE POINTS

Code	See Page	Wire Harness with Splice Points	Code	See Page	Wire Harness with Splice Points	
E1	36 (1MZ-FE)	Engine Room Main Wire	B3	44	Roof Wire	
	38 (5S-FE)		B6	44	Floor No.2 Wire	
E4	36 (1MZ-FE)		B9	44	Floor Wire	
	38 (5S-FE)		B11			
I1	42		Cowl Wire	B12	46	Seat No.1 Wire
I2	42		Engine Wire	B13	44	Front Door LH Wire
I7	42	Cowl Wire	B14	44	Front Door RH Wire	
B2	44	Roof Wire				

J5
ORANGE

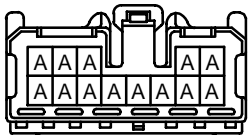

(Hint : See Page 7)

J7 (A)
GRAY

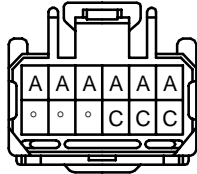

(Hint : See Page 7)

J8 (B)
GRAY

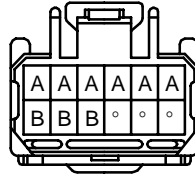

(Hint : See Page 7)

J11

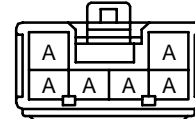

(Hint : See Page 7)

J19
GRAY

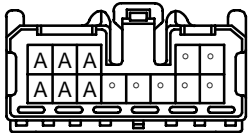

(Hint : See Page 7)

J22



(Hint : See Page 7)

J23



(Hint : See Page 7)

J26

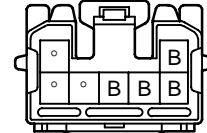

(Hint : See Page 7)

J38

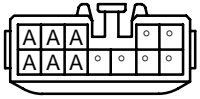

(Hint : See Page 7)

J39

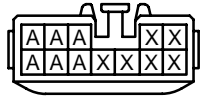

(Hint : See Page 7)

J40

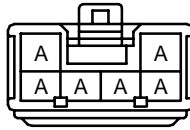

(Hint : See Page 7)

J OVERALL ELECTRICAL WIRING DIAGRAM

* The system shown here is an EXAMPLE ONLY. It is different to the actual circuit shown in the wiring diagram section.

HOW TO READ THIS SECTION

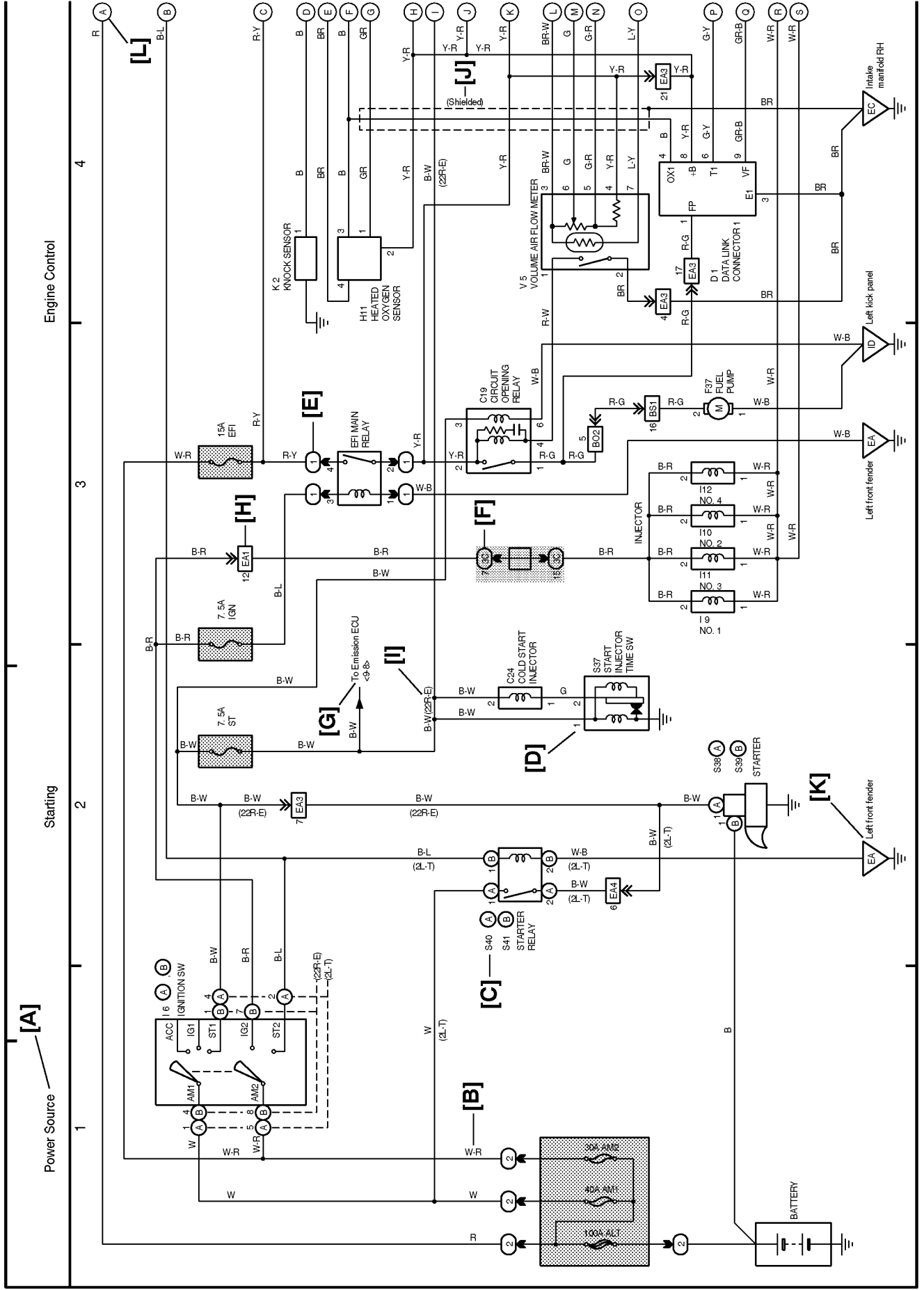

[A] : System Title

[B] : Indicates the wiring color.

Wire colors are indicated by an alphabetical code.

B = Black W = White BR = Brown
L = Blue V = Violet SB = Sky Blue
R = Red O = Orange LG = Light Green
P = Pink Y = Yellow GR = Gray
G = Green

The first letter indicates the basic wire color and the second letter indicates the color of the stripe.

Example: L - Y

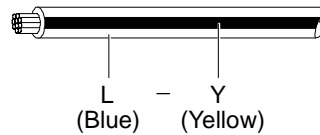

[C] : The position of the parts is the same as shown in the wiring diagram and wire routing.

[D] : Indicates the pin number of the connector. The numbering system is different for female and male connectors.

Example : Numbered in order from upper left to lower right

Numbered in order from upper right to lower left

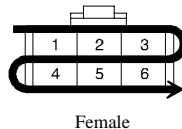

Female

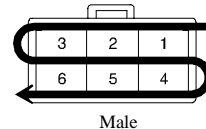

Male

The numbering system for the overall wiring diagram is the same as above

[E] : Indicates a Relay Block. No shading is used and only the Relay Block No. is shown to distinguish it from the J/B.

Example : ① Indicates Relay Block No.1

[F] : Junction Block (The number in the circle is the J/B No. and the connector code is shown beside it). Junction Blocks are shaded to clearly separate them from other parts.

Example:

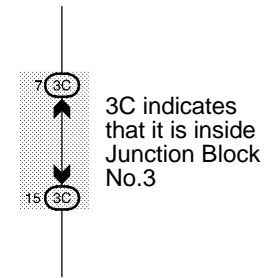

[G] : Indicates related system.

[H] : Indicates the wiring harness and wiring harness connector. The wiring harness with male terminal is shown with arrows (↘). Outside numerals are pin numbers.

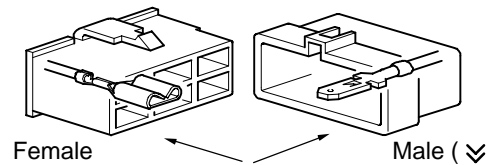

[I] : () is used to indicate different wiring and connector, etc. when the vehicle model, engine type, or specification is different.

[J] : Indicates a shielded cable.



[K] : Indicates and located on ground point.

[L] : The same code occurring on the next page indicates that the wire harness is continuous.

SYSTEM INDEX

SYSTEMS	LOCATION	SYSTEMS	LOCATION
ABS		Light Auto Turn Off	9-1
TMC Made	19-2	Moon Roof	21-2
TMMK Made	20-2	Power Outlet	16-3
ABS and Traction Control	18-2	Power Seat	22-2
Air Conditioning		Power Source	1-29-1
Automatic A/C	29-2	Power Window	13-2
Manual A/C	27-2	Radiator Fan and Condenser Fan	26-3
Auto Antenna	24-2	Radio and Player	
Back-Up Light	8-4	Built-In Type Amplifier	24-3
Charging	1-4	Separate Type Amplifier	23-2
Cigarette Lighter and Clock	16-4	Rear Window Defogger and Mirror Heater	26-2
Combination Meter	25-2	Remote Control Mirror	12-4
Cruise Control	17-2	Shift Lock	16-2
Door Lock Control	14-2	SRS	28-2
Electronically Controlled Transmission and A/T Indicator		Starting and Ignition	1-2
1MZ-FE	4-2	Stop Light	11-4
5S-FE	5-2	Taillight	11-2
Engine Control and Engine Immobiliser System		Theft Deterrent	15-2
1MZ-FE	2-2	Turn Signal and Hazard Warning Light	8-2
5S-FE	3-2	Wiper and Washer	12-2
Headlight		Wireless Door Lock Control	14-5
w/ Daytime Running Light	7-2		
w/o Daytime Running Light	6-2		
Horn	21-4		
Illumination	10-2		
Interior Light	9-3		
Key Reminder and Seat Belt Warning	21-3		

1 CAMRY ELECTRICAL WIRING DIAGRAM

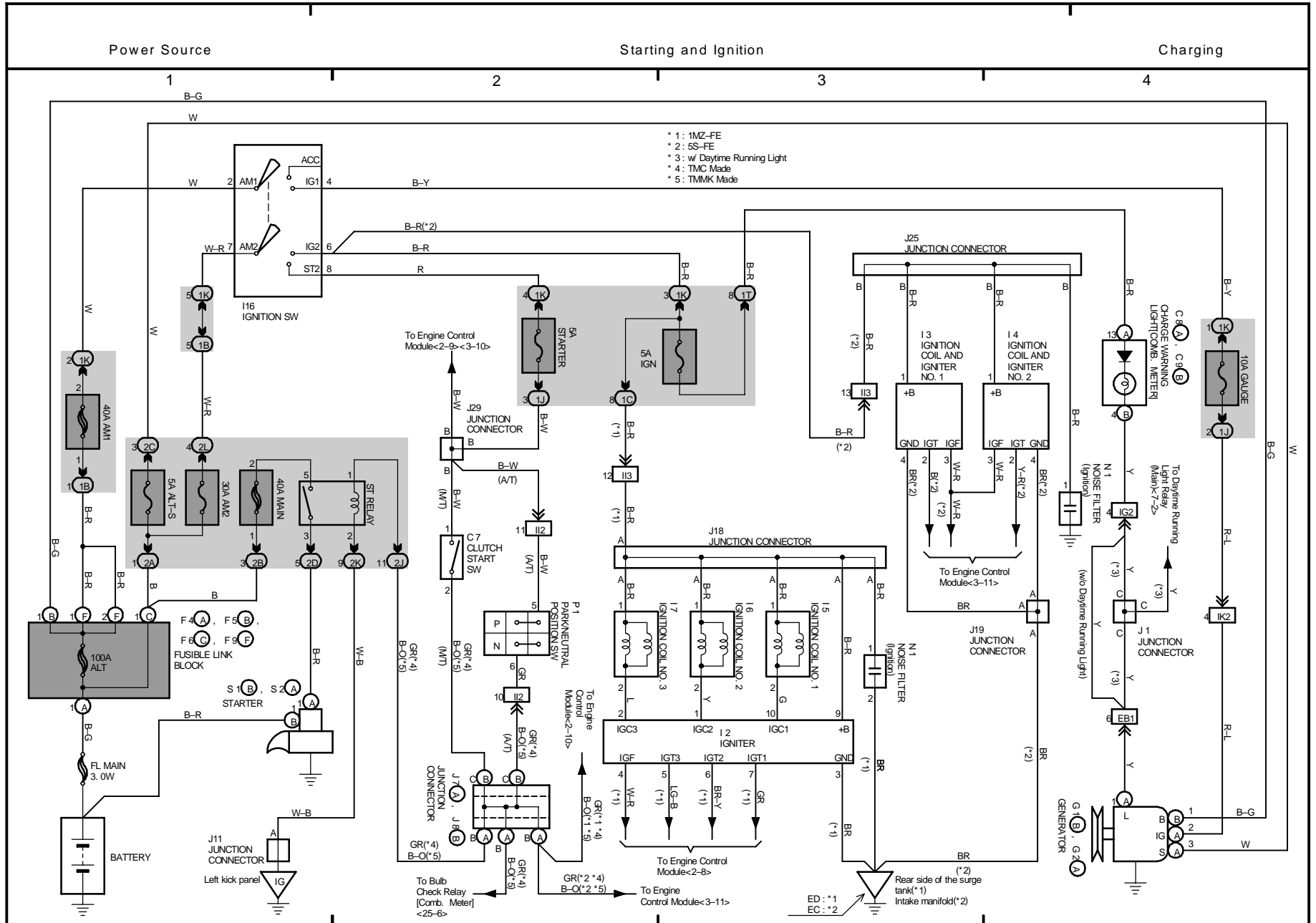

J OVERALL ELECTRICAL WIRING DIAGRAM

2 CAMRY

(Cont. next page)

Engine Control and Engine Immobiliser System (1MZ-FE)

* 1: California

Power Source

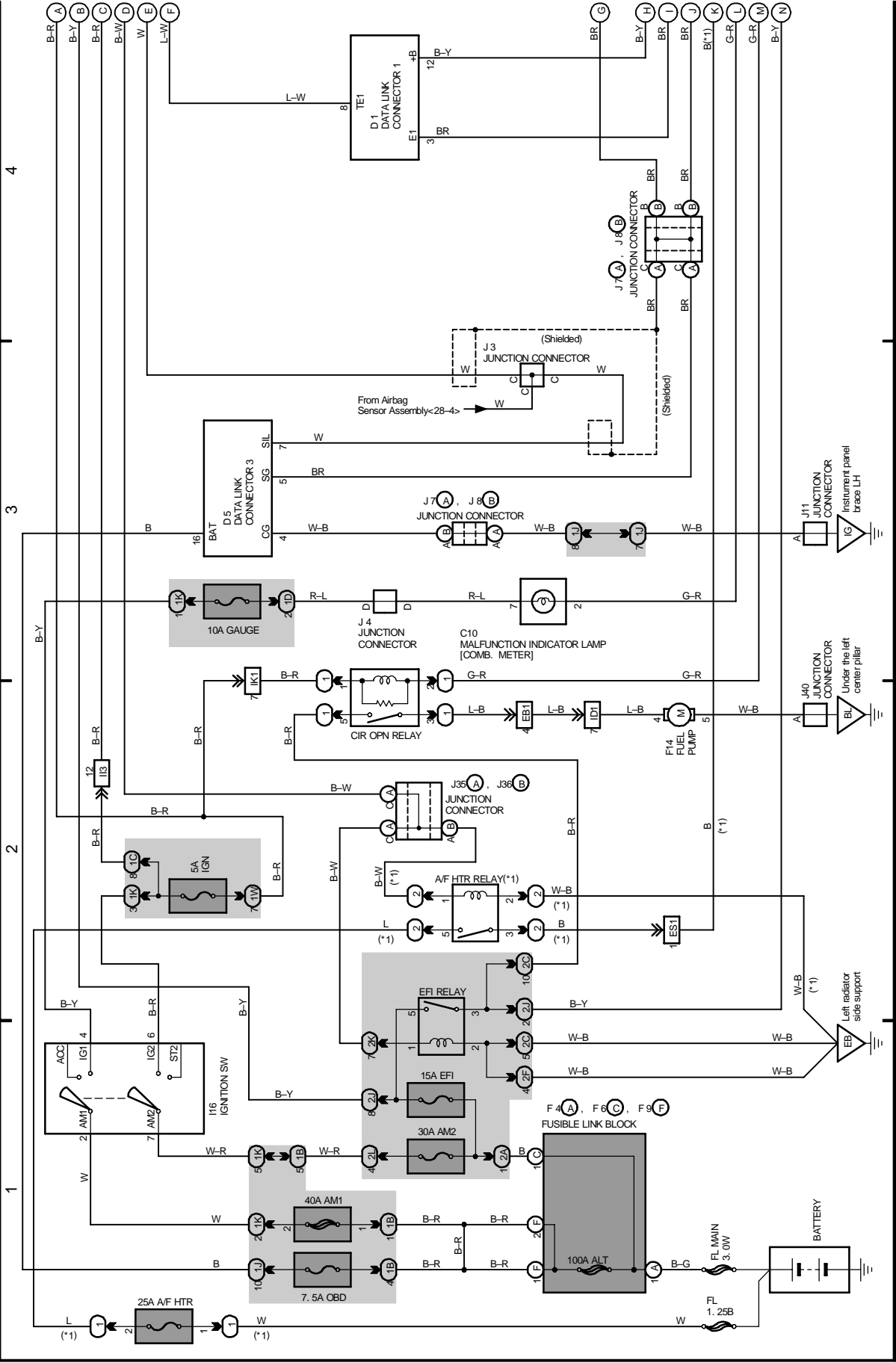

Engine Control and Engine Immobiliser System (1MZ-FE)

- * 1 : California
- * 2 : Except California
- * 3 : w/ Engine Immobiliser System

- * 4 : TMC Made
- * 5 : TMMK Made
- * 6 : Automatic A/C

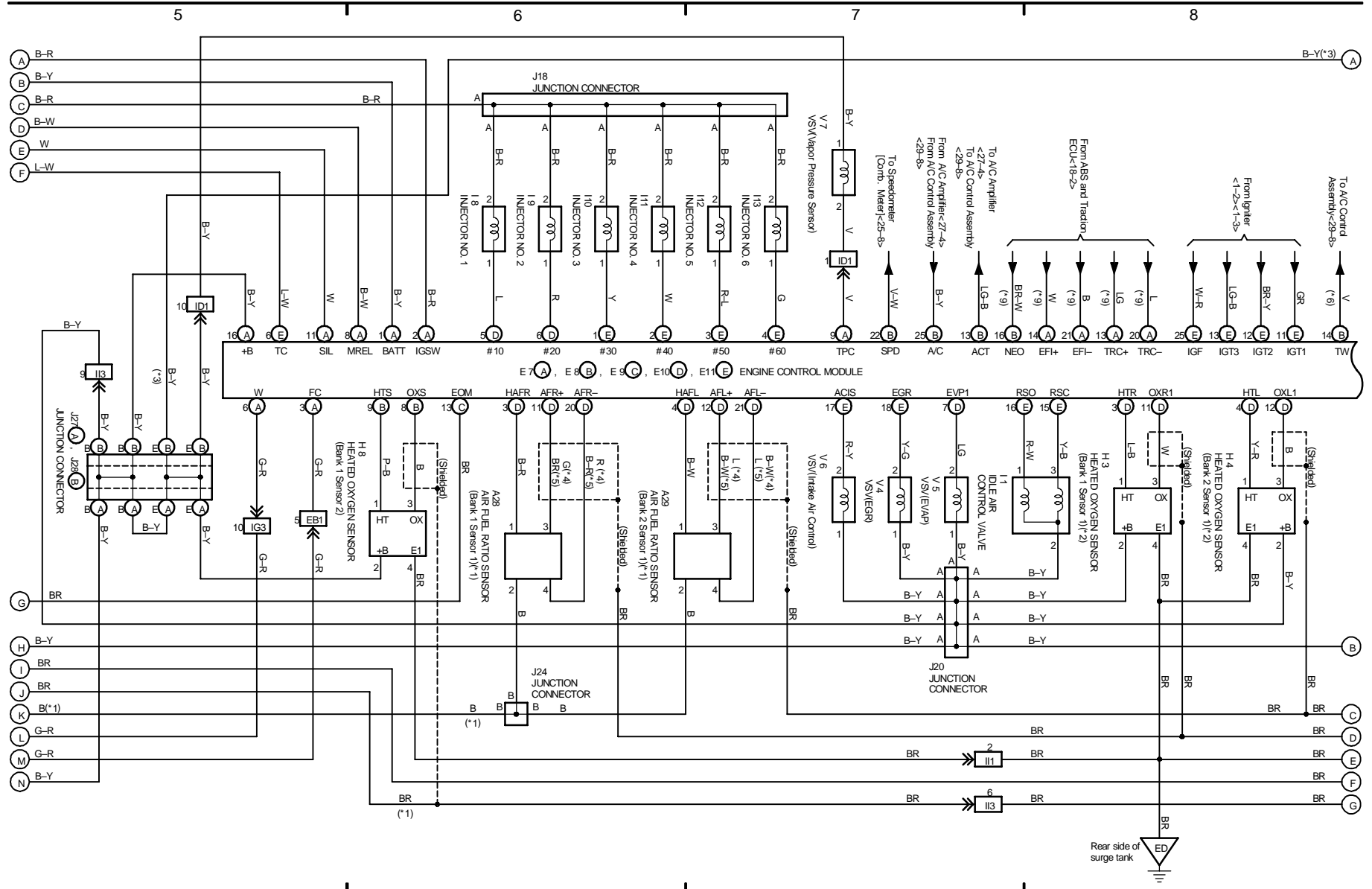

J OVERALL ELECTRICAL WIRING DIAGRAM

2 CAMRY (Cont'd)

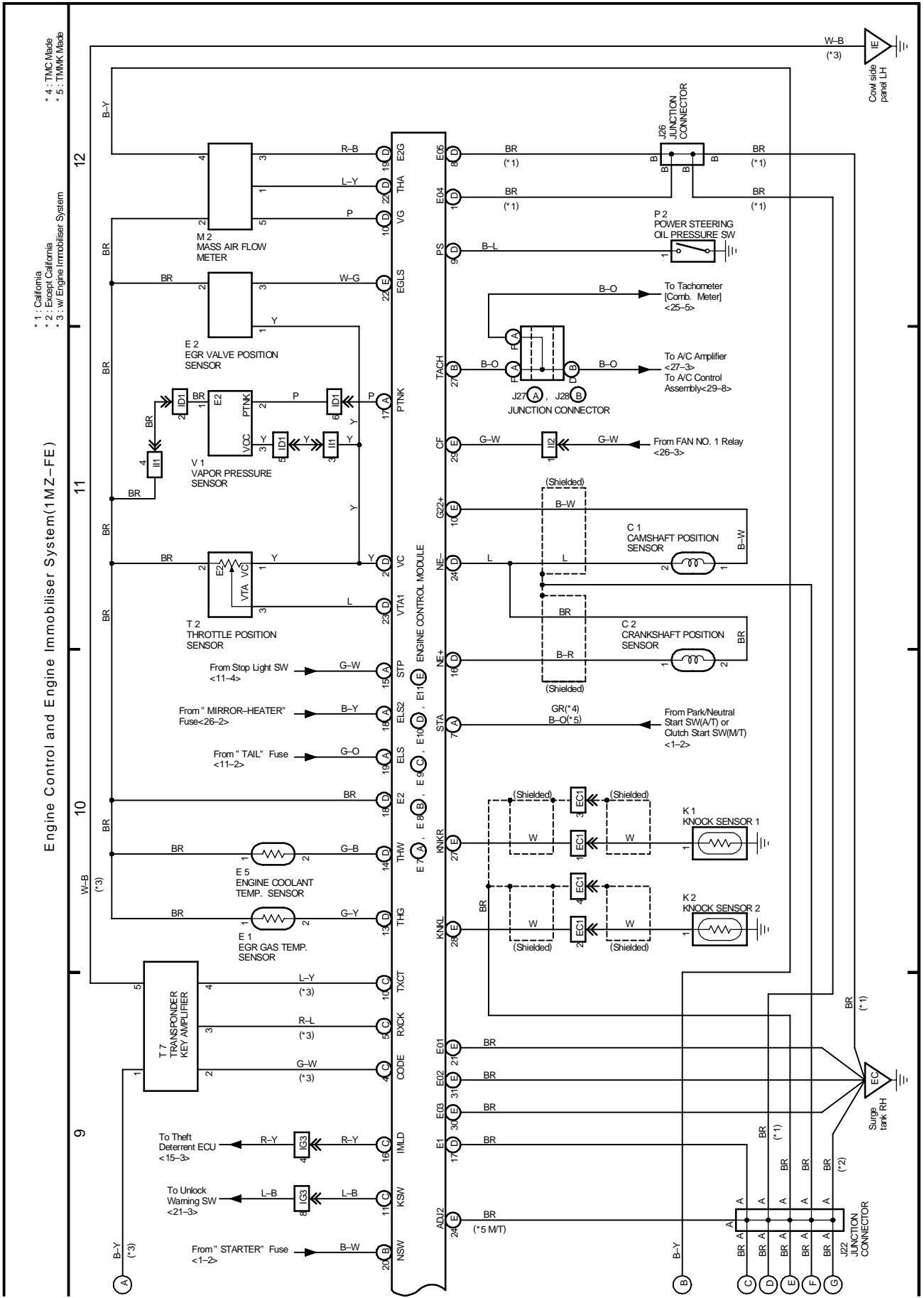

Engine Control and Engine Immobiliser System (5S-FE)

* 1 : w/ Engine Immobiliser System
 * 2 : w/o Engine Immobiliser System

* 3 : California
 * 4 : Except California

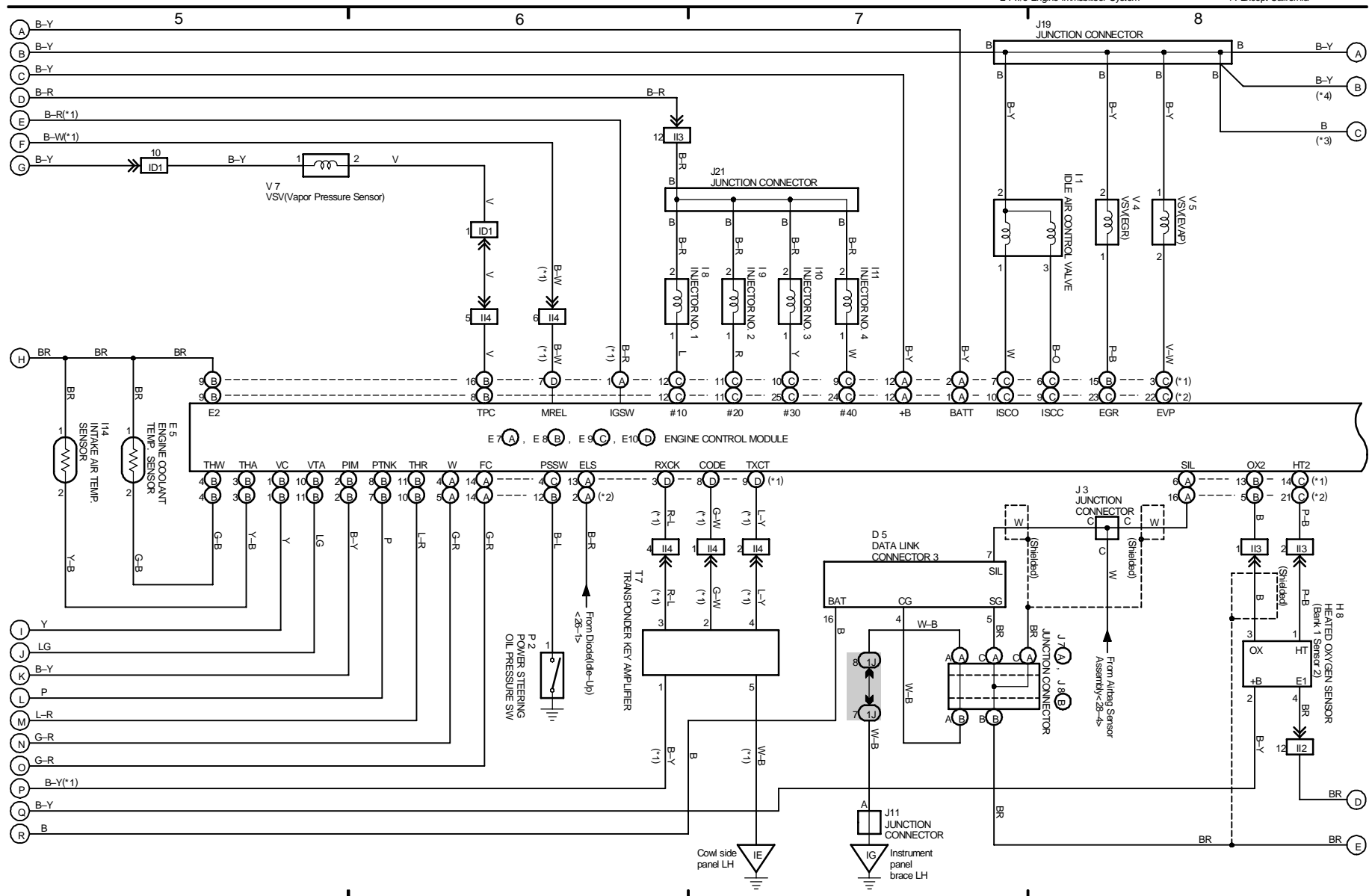

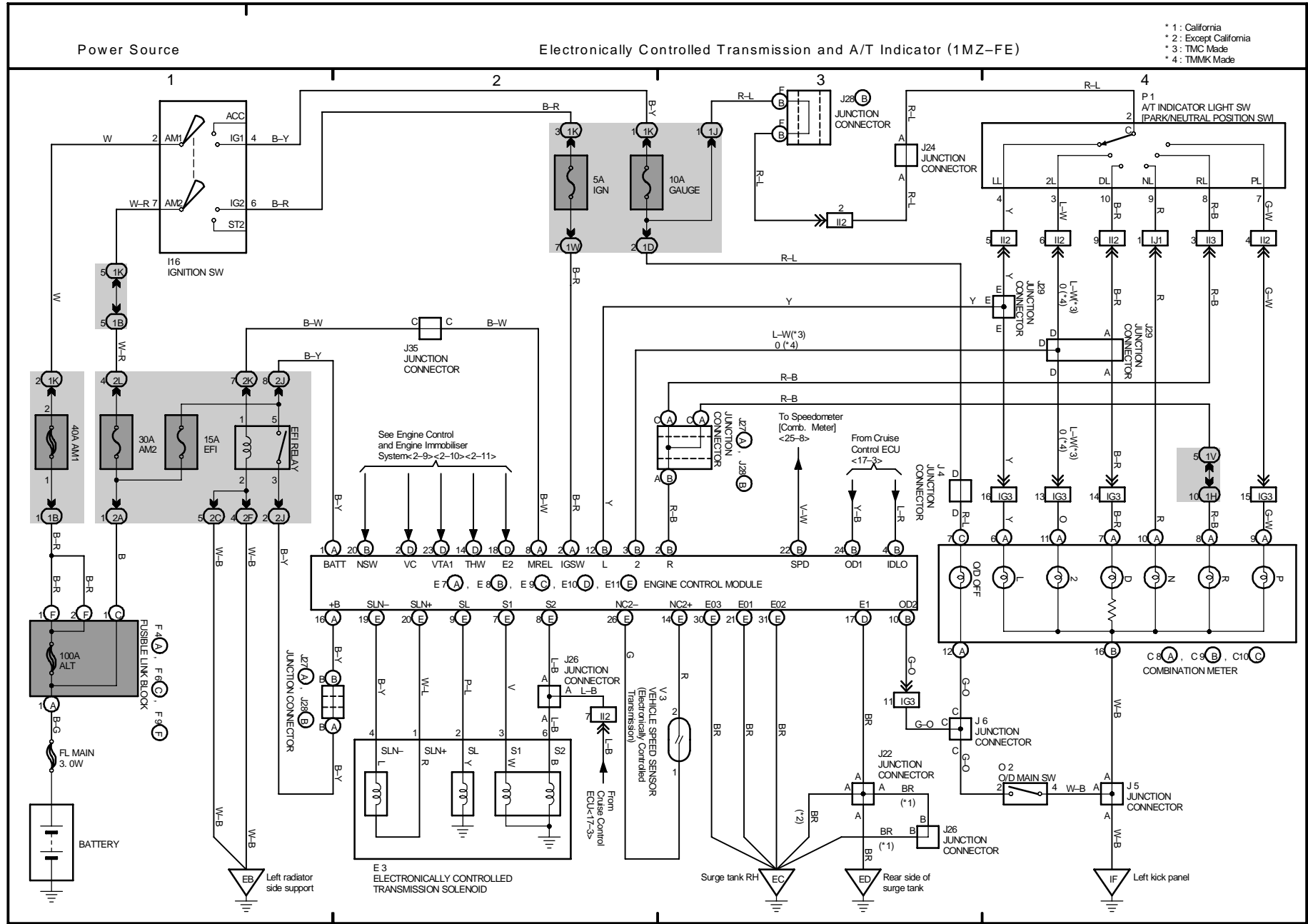

6 CAMRY

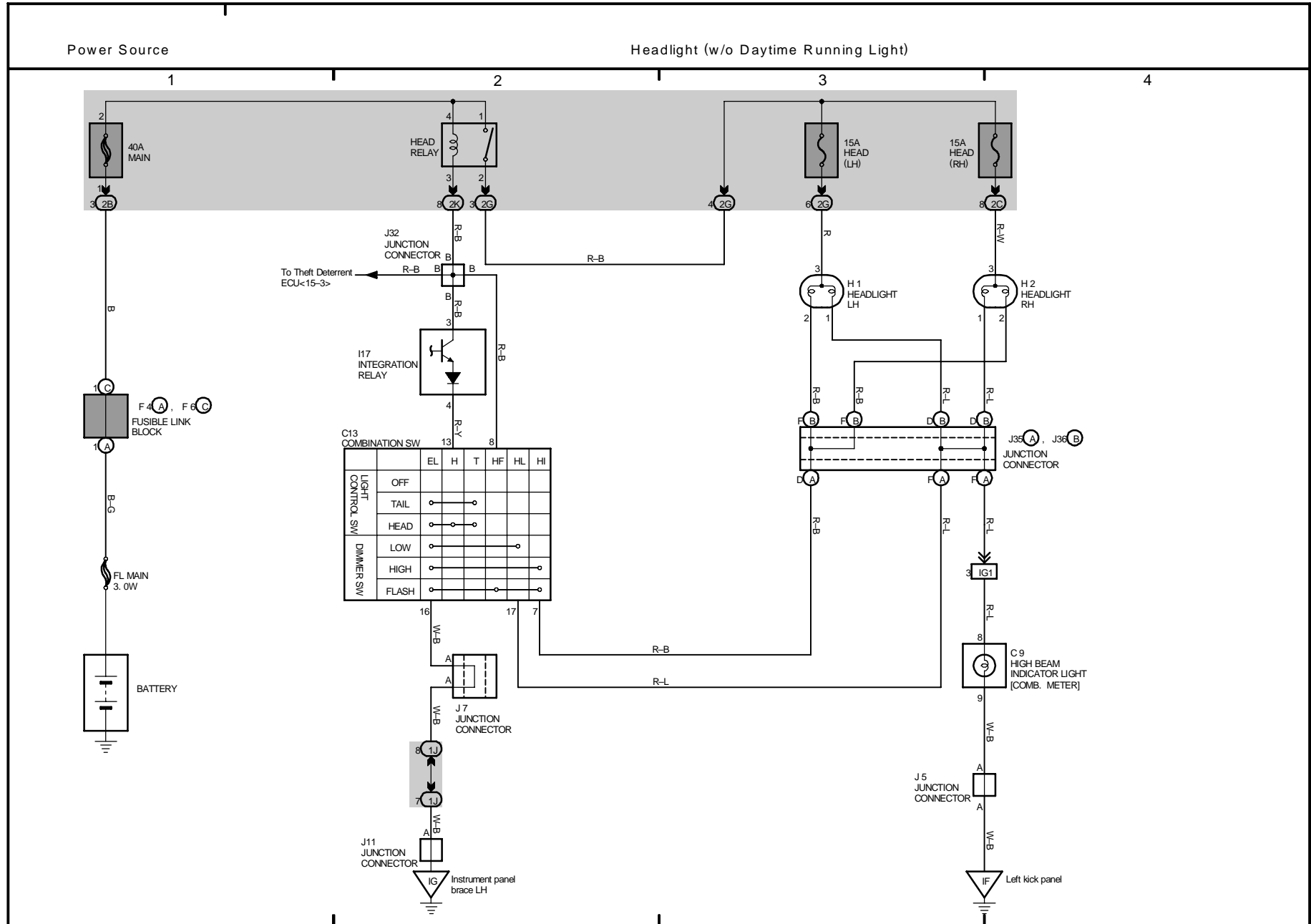

J OVERALL ELECTRICAL WIRING DIAGRAM

7 CAMRY

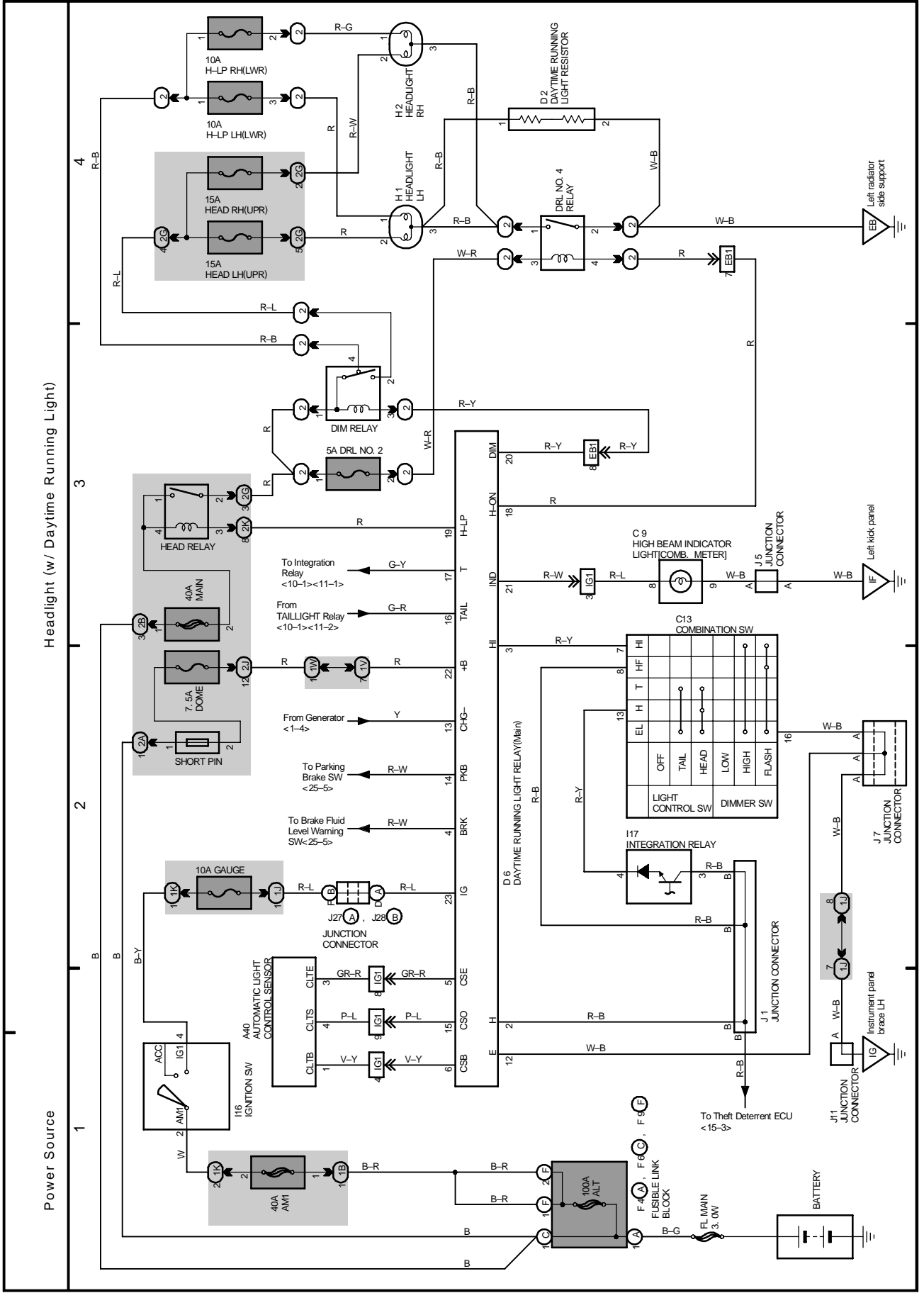

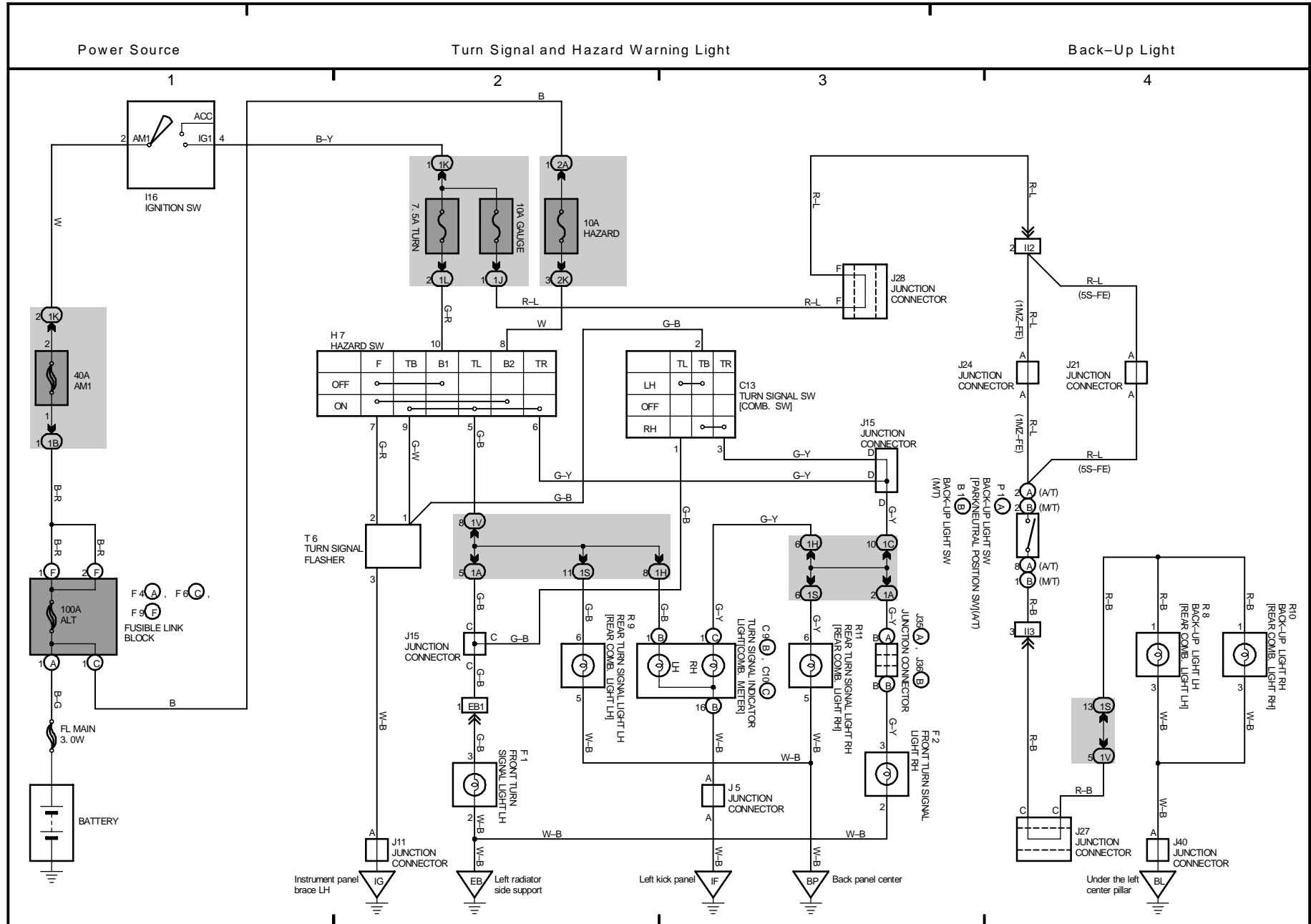

J OVERALL ELECTRICAL WIRING DIAGRAM

9 CAMRY

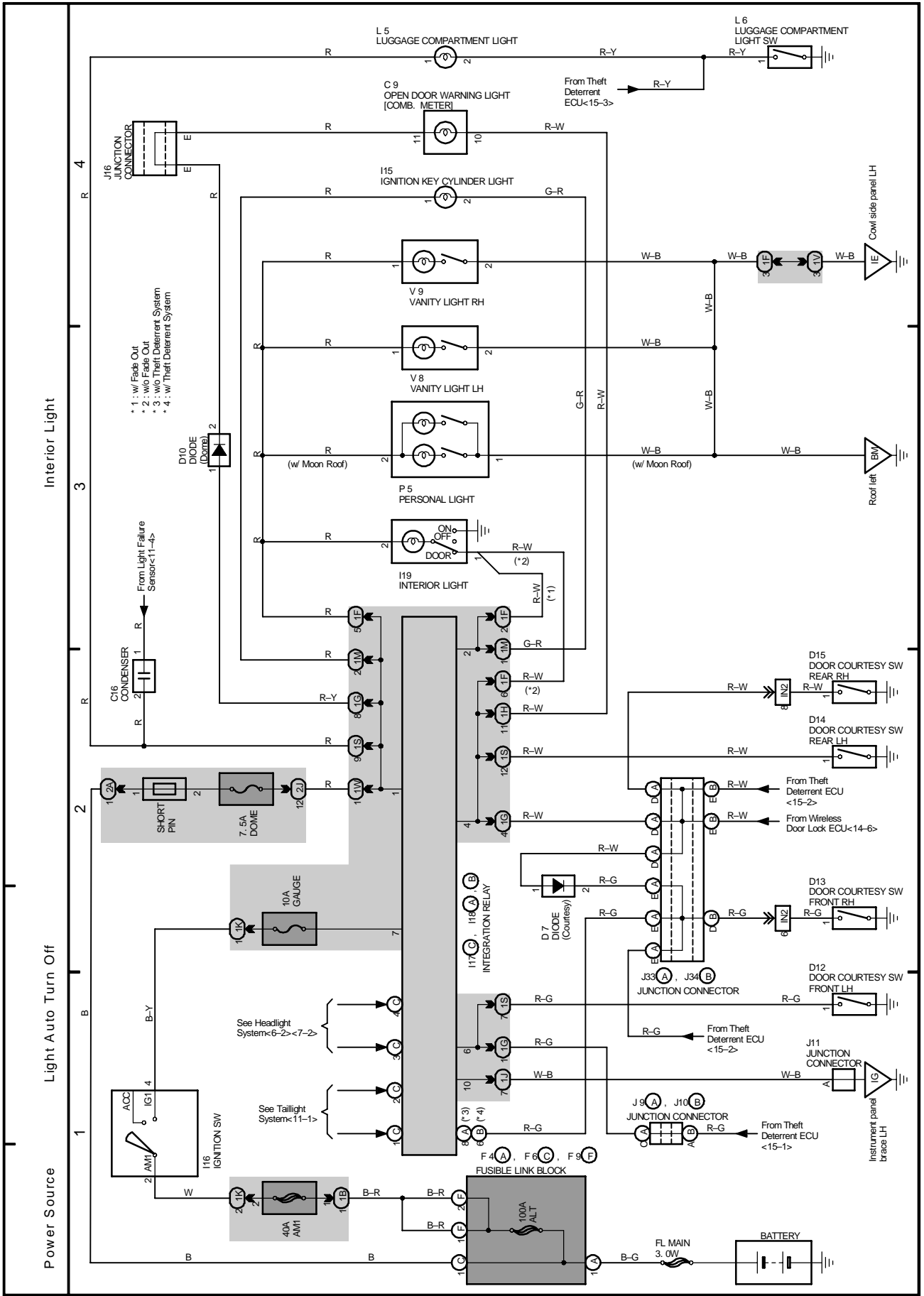

- * 1 : w/ Fade Out
- * 2 : w/o Fade Out
- * 3 : w/ Theft Deterrent System
- * 4 : w/ Theft Deterrent System

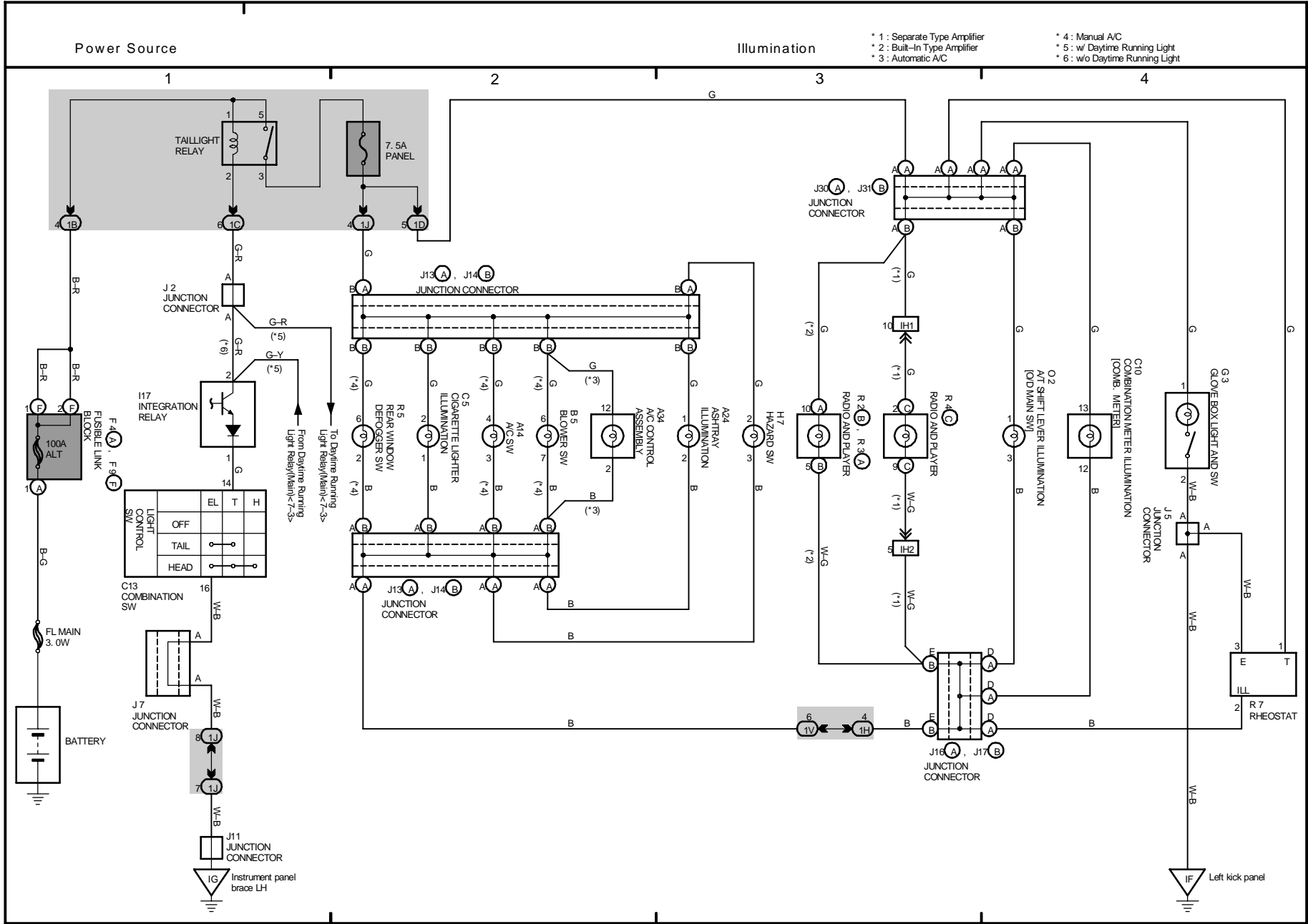

J OVERALL ELECTRICAL WIRING DIAGRAM

11 CAMRY

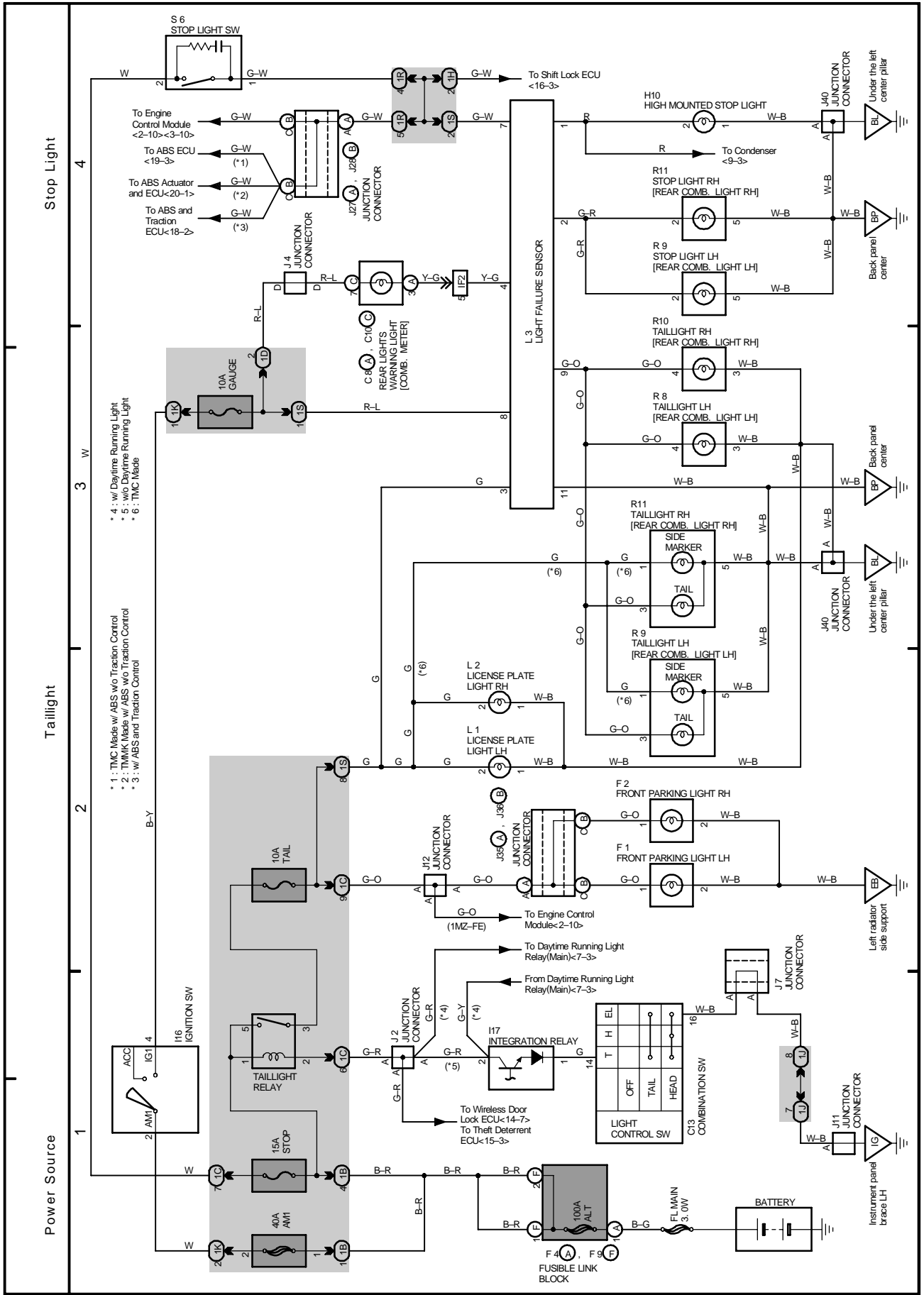

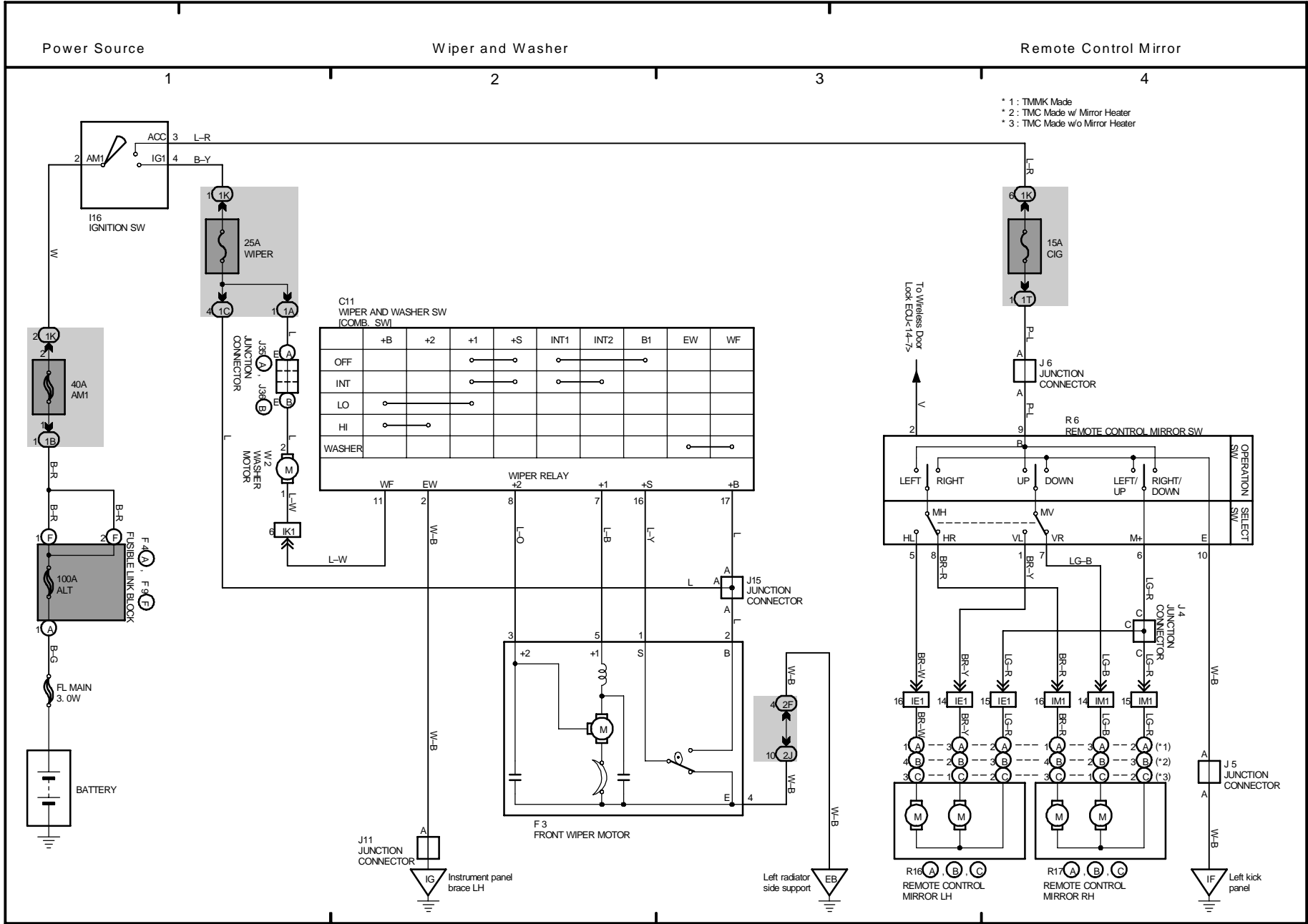

J OVERALL ELECTRICAL WIRING DIAGRAM

13 CAMRY

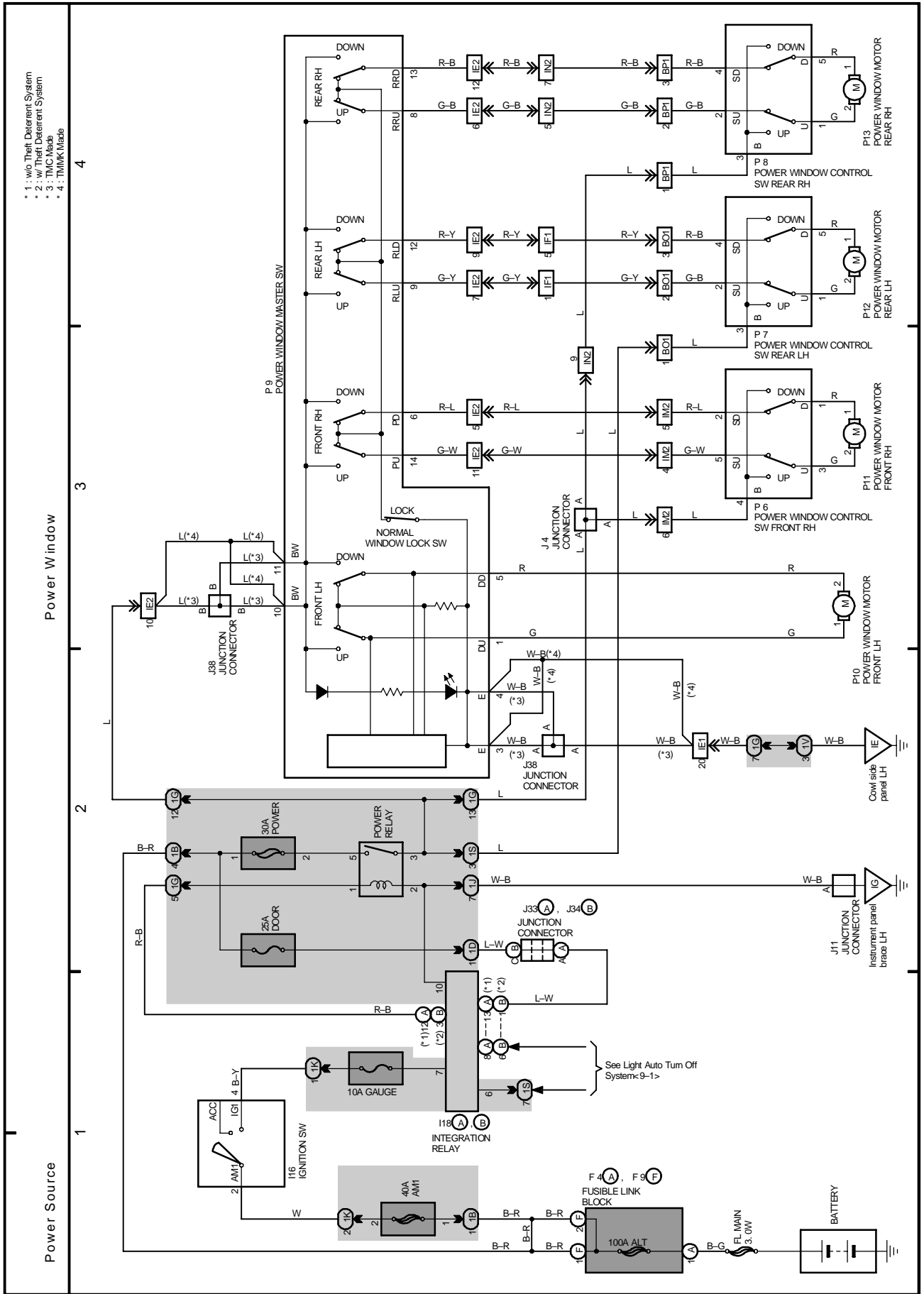

J OVERALL ELECTRICAL WIRING DIAGRAM

14 CAMRY

(Cont. next page)

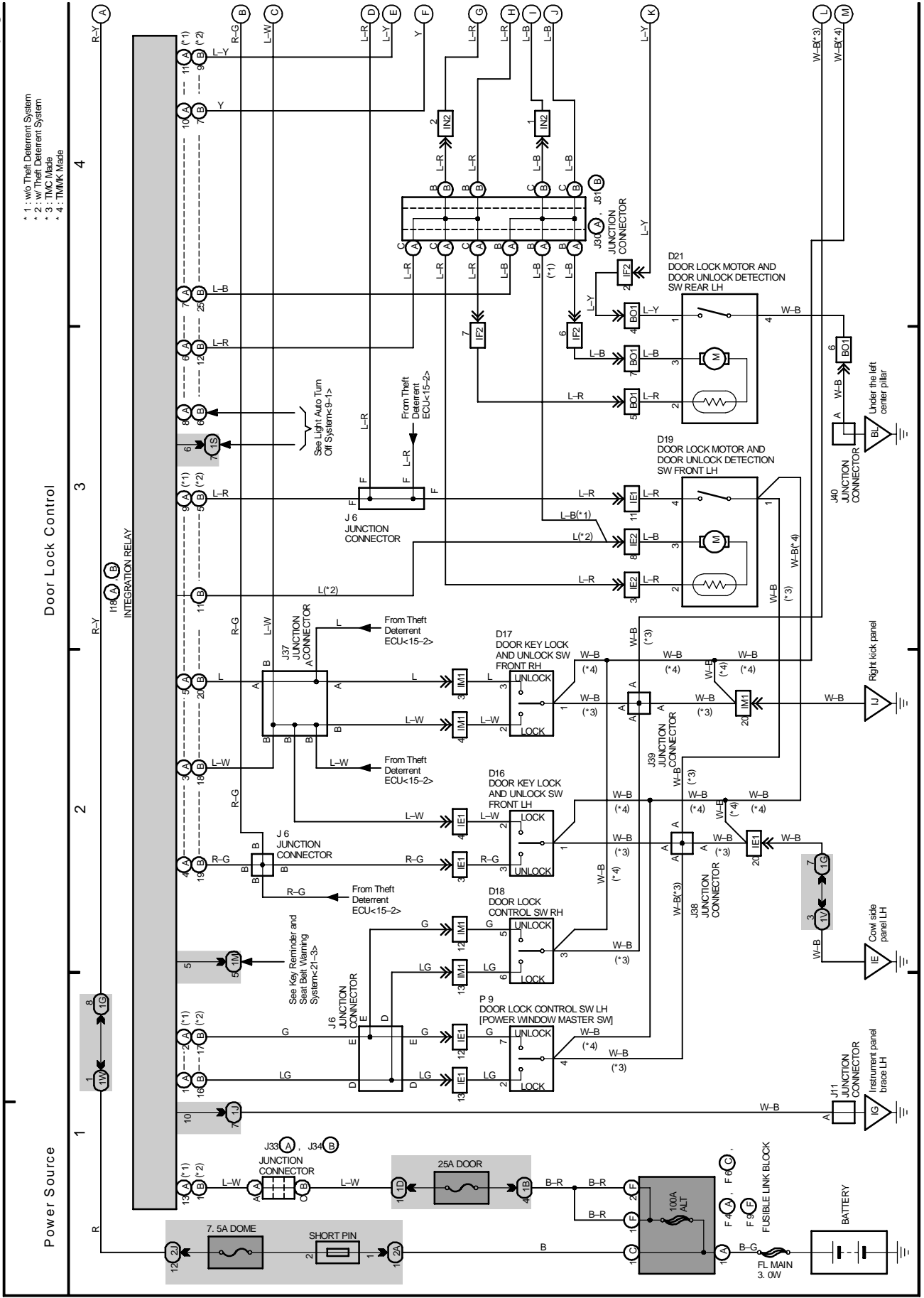

- * 1 : w/o Theft Deterrent System
- * 2 : w/ Theft Deterrent System
- * 3 : TMC Made
- * 4 : TMMK Made

Wireless Door Lock Control

* 3 : TMC Made
 * 4 : TMWK Made

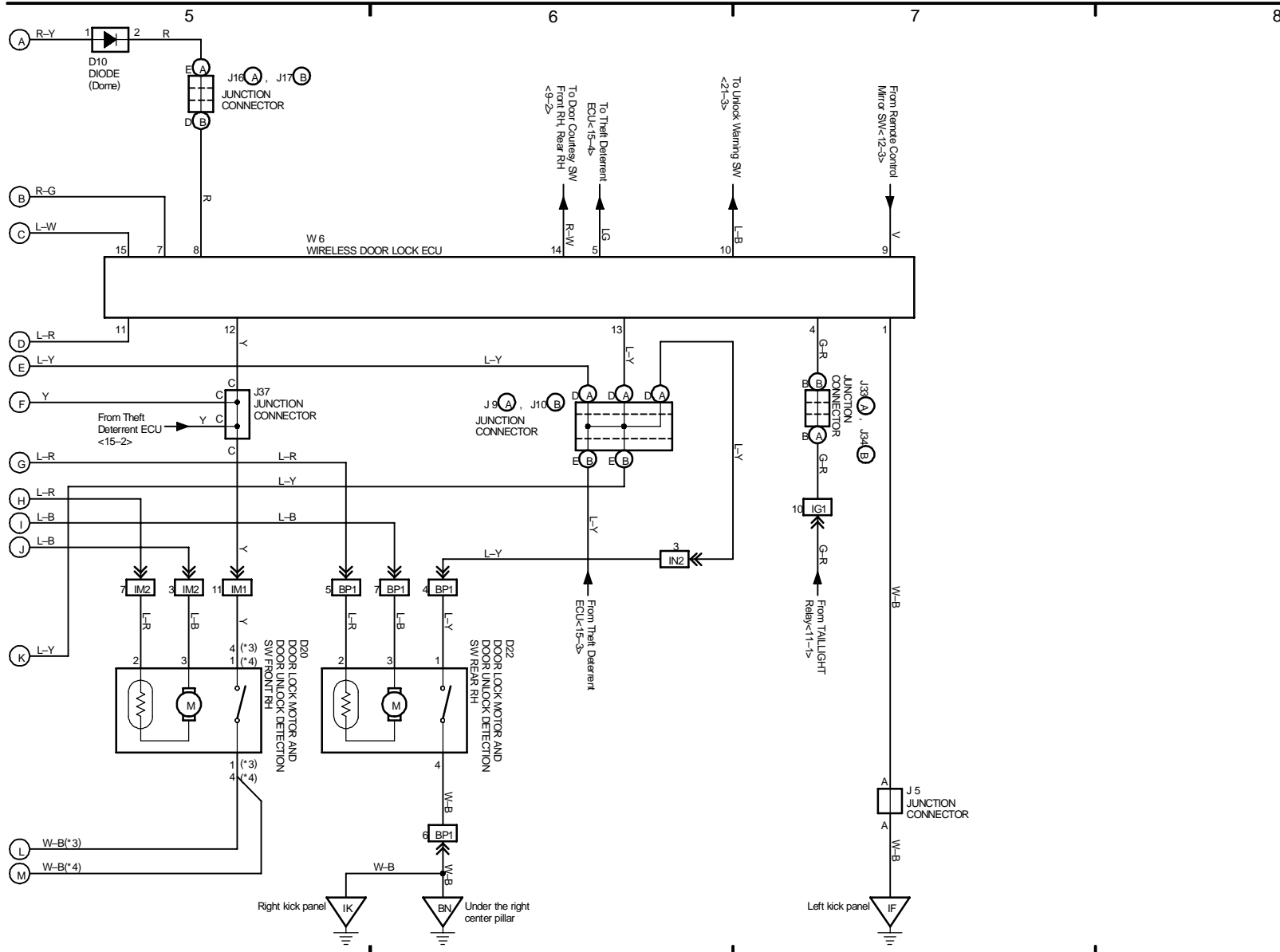

J OVERALL ELECTRICAL WIRING DIAGRAM

15 CAMRY

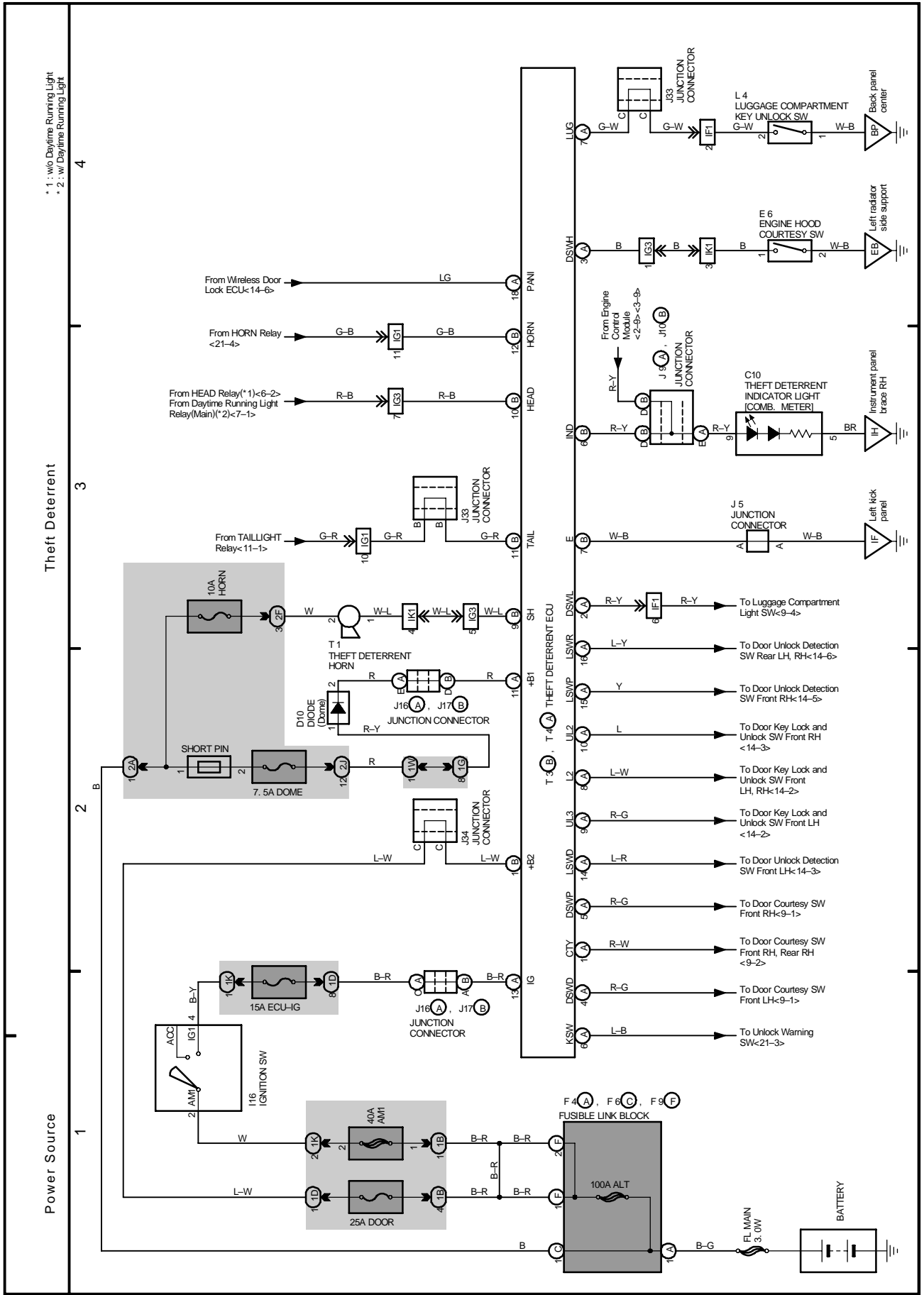

* 1 : w/o Daytime Running Light
* 2 : w/ Daytime Running Light

Thief Deterrent

Power Source

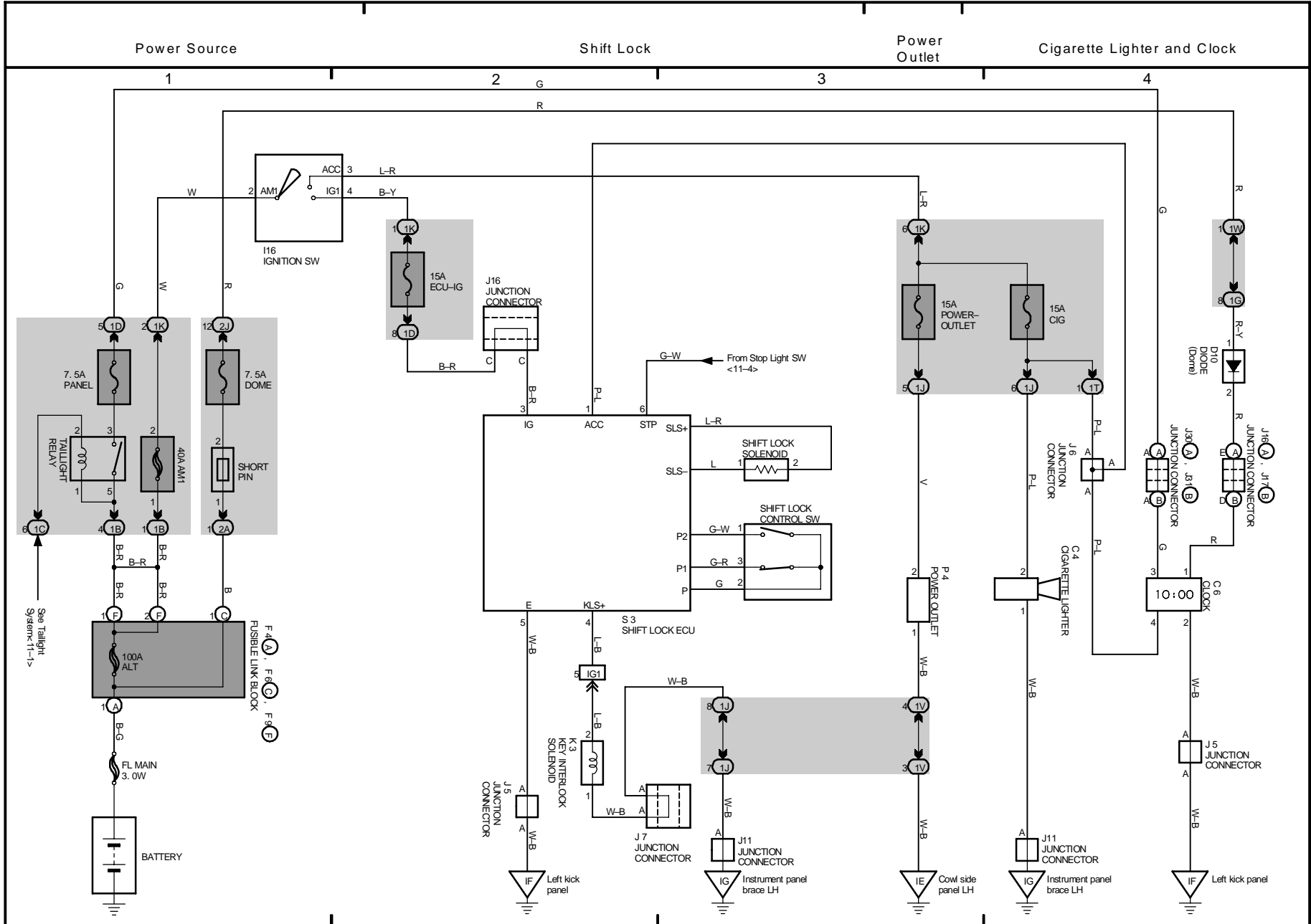

J OVERALL ELECTRICAL WIRING DIAGRAM

17 CAMRY

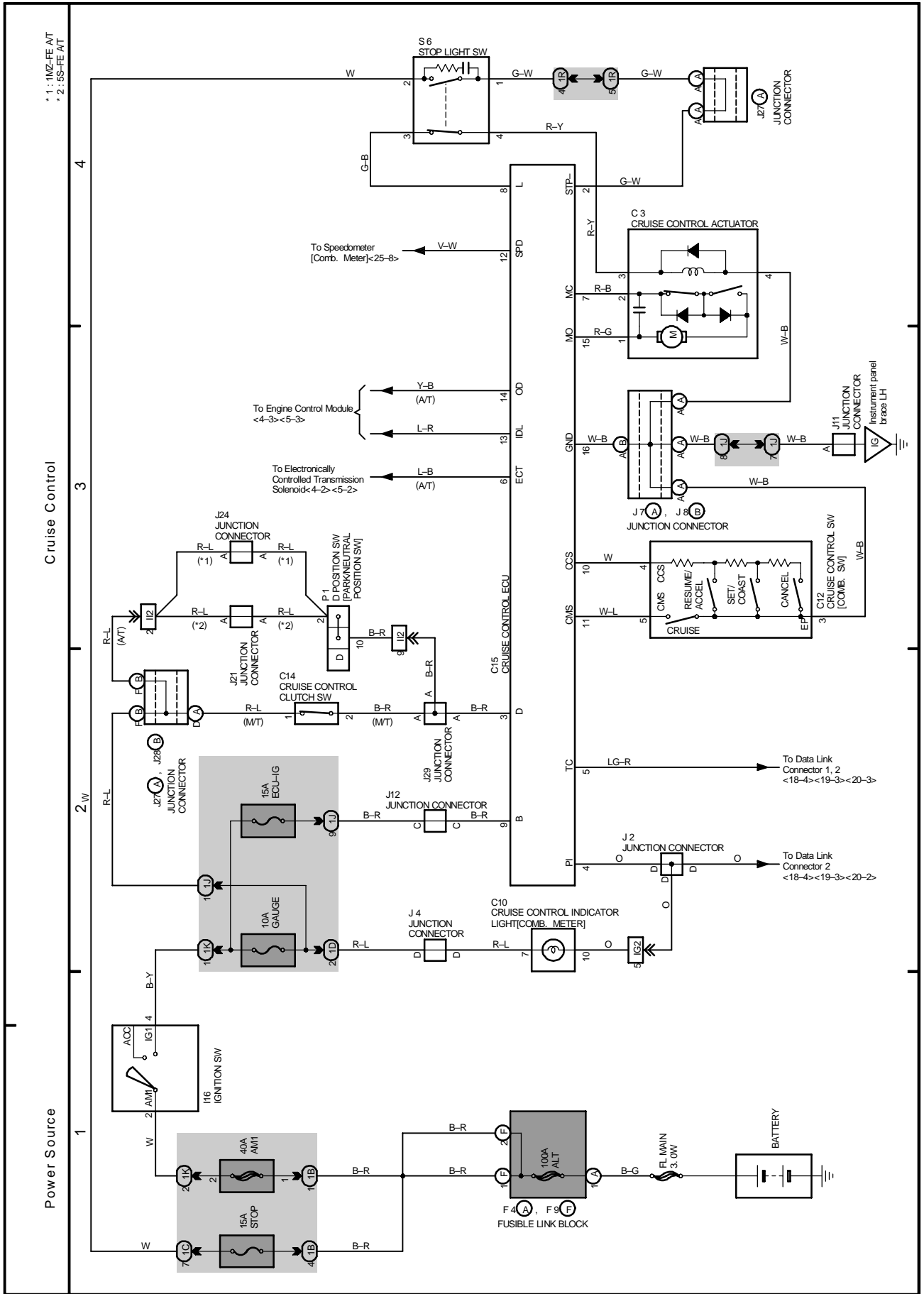

J OVERALL ELECTRICAL WIRING DIAGRAM

19 CAMRY

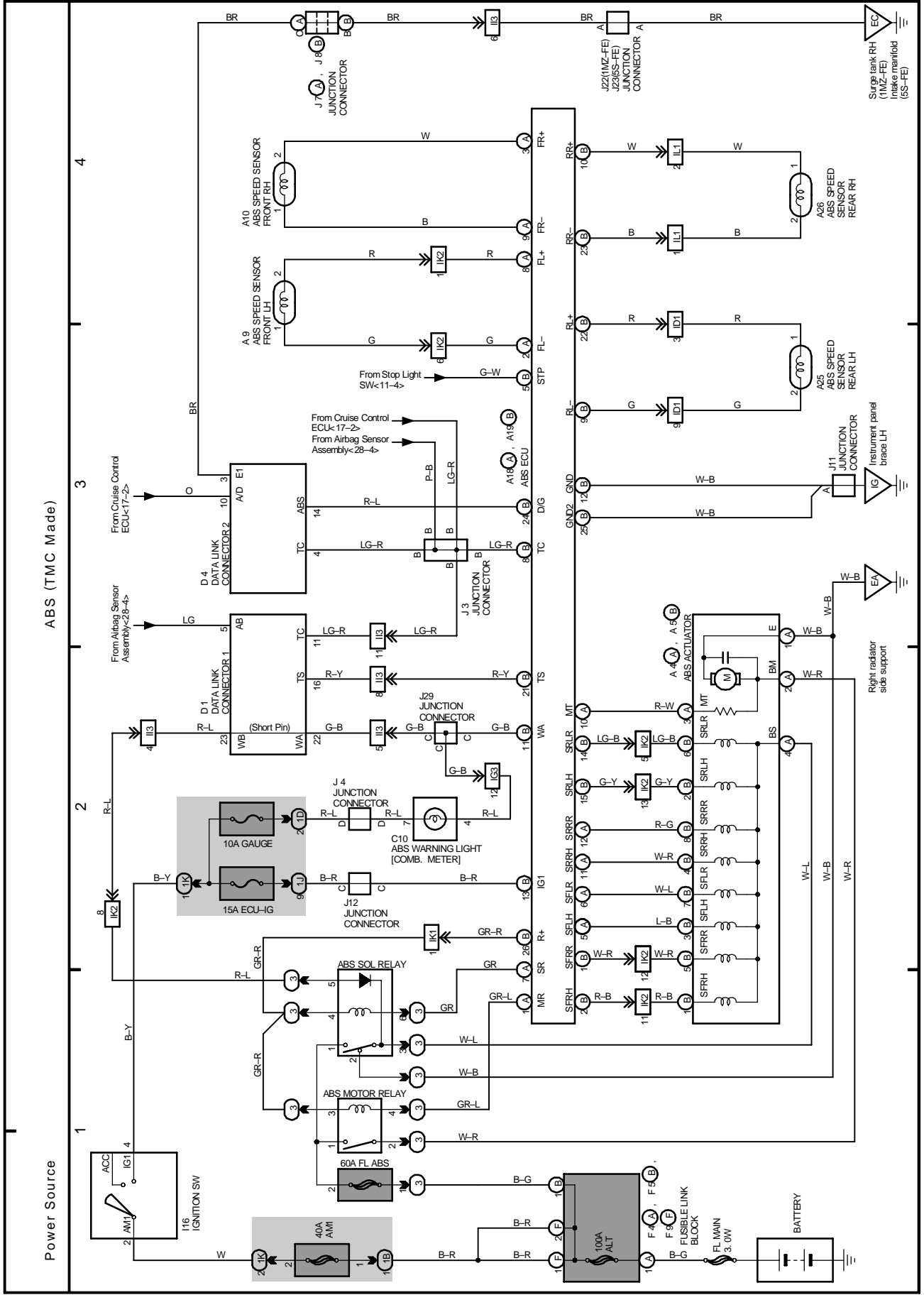

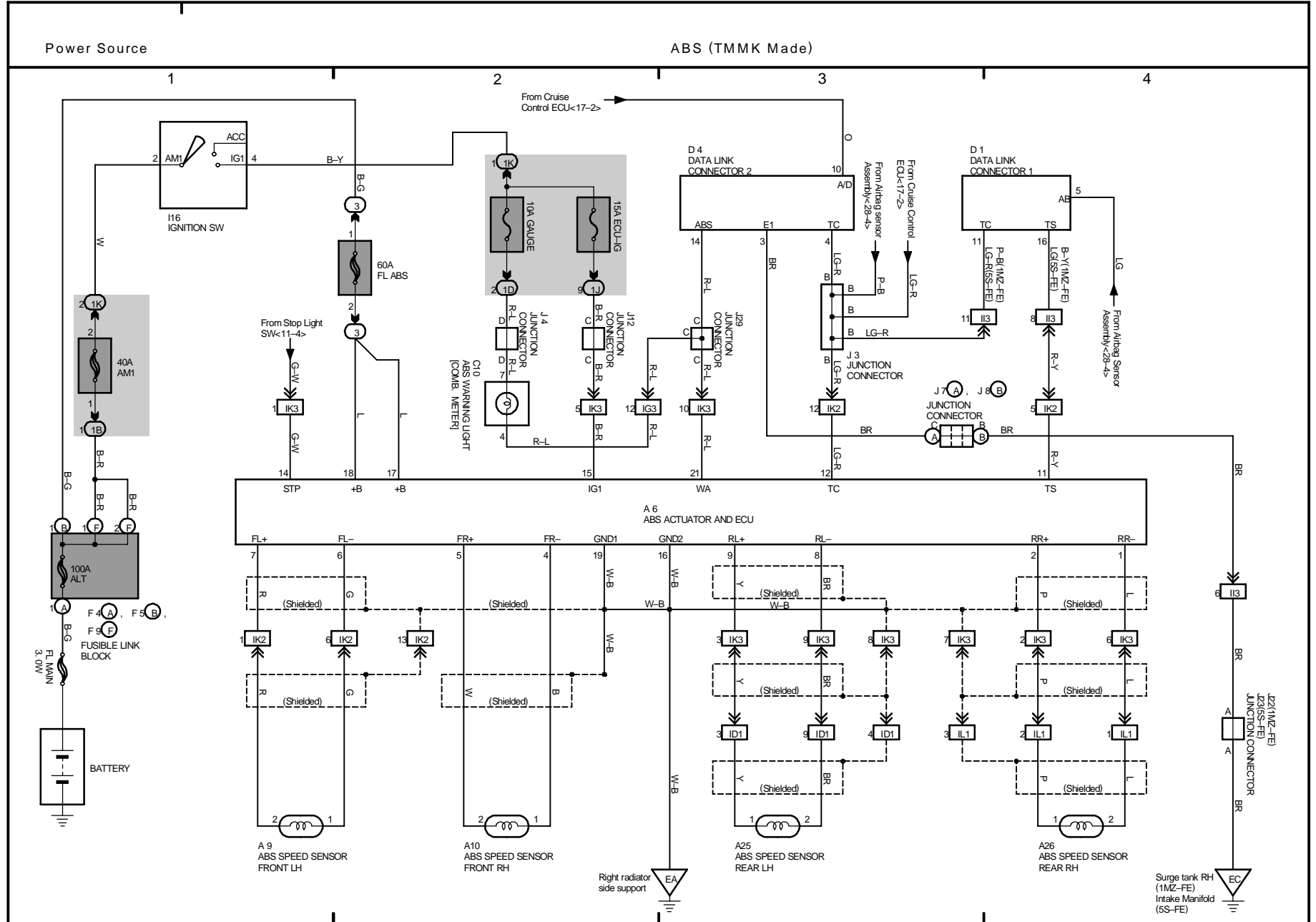

J OVERALL ELECTRICAL WIRING DIAGRAM

21 CAMRY

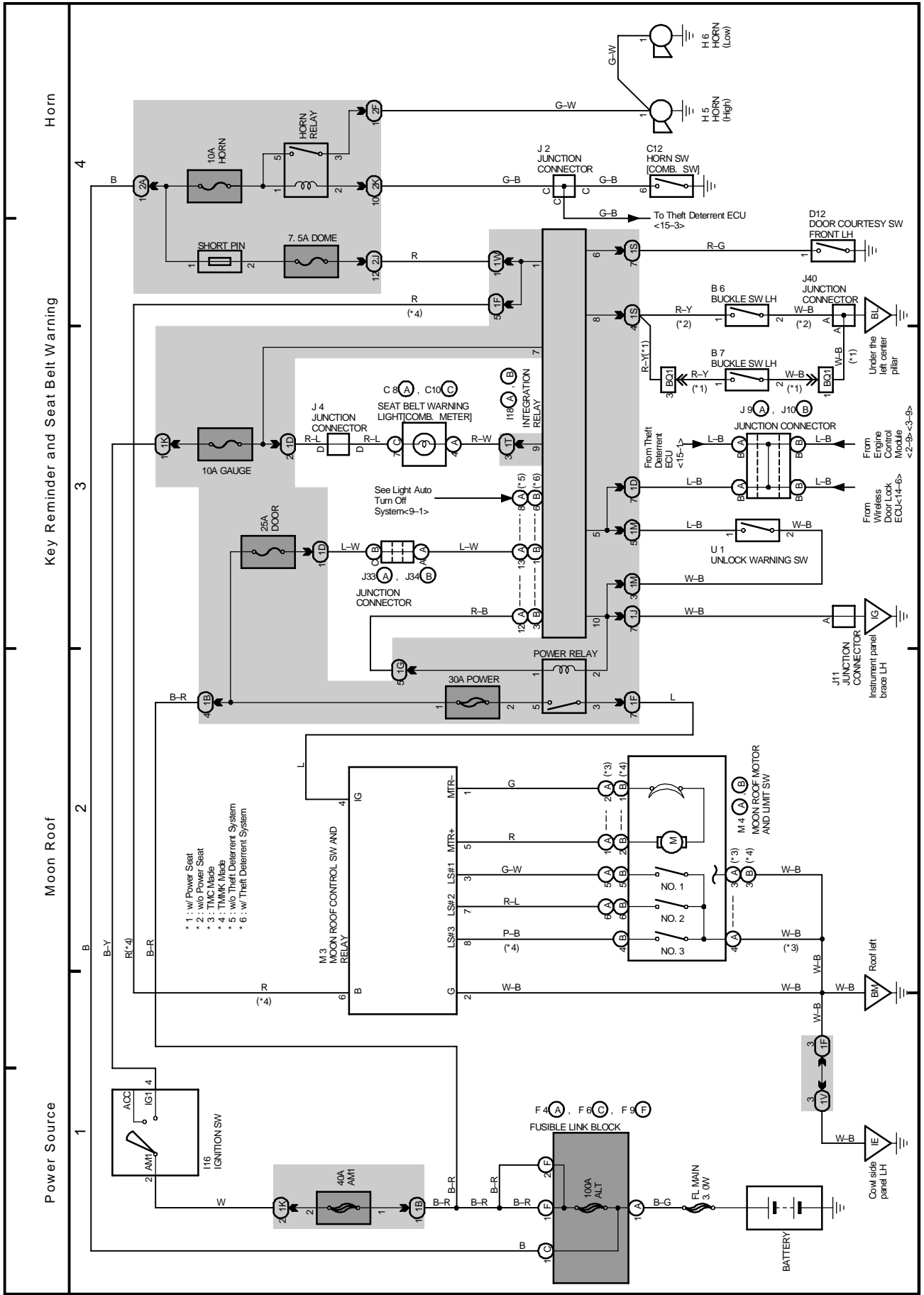

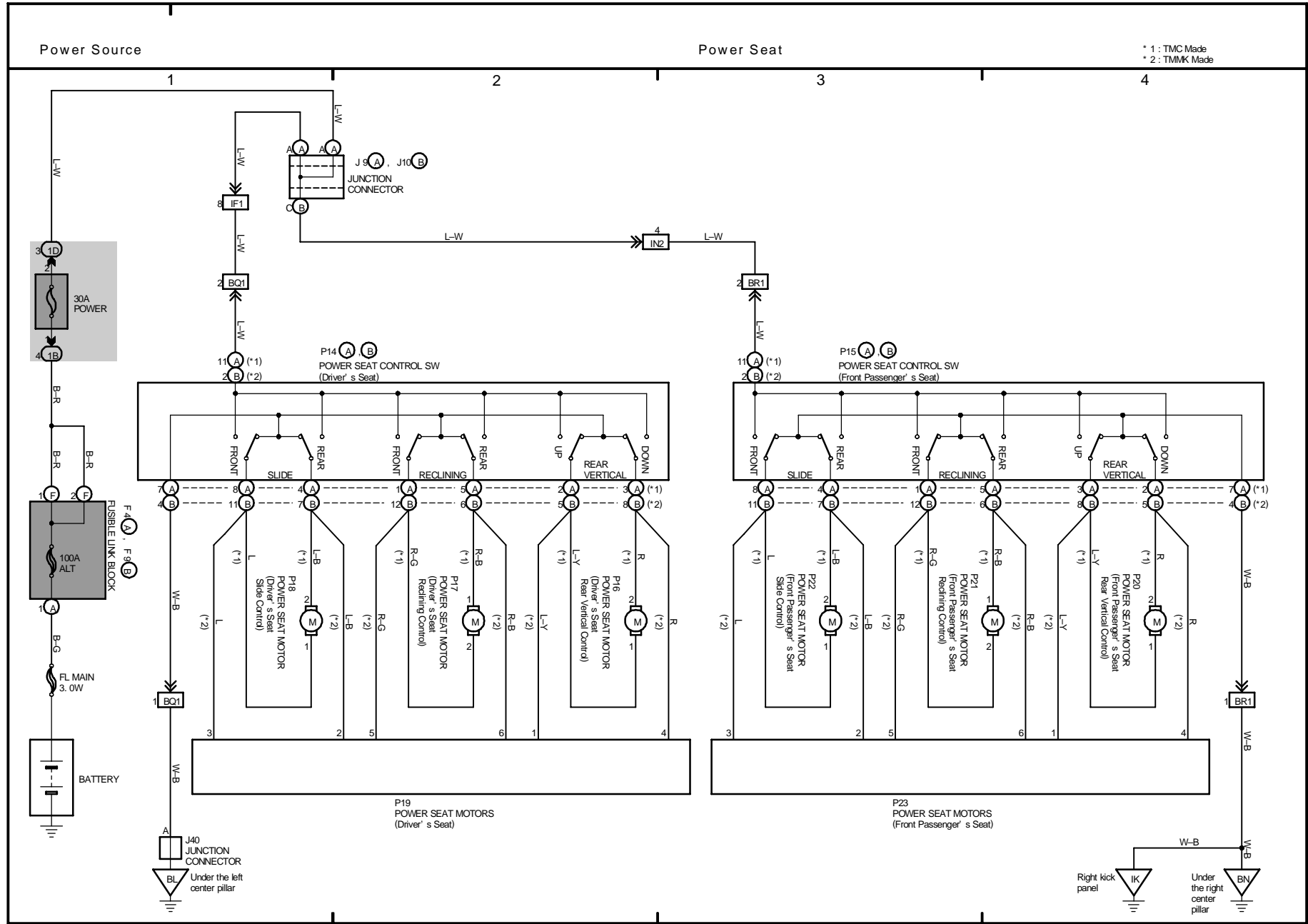

J OVERALL ELECTRICAL WIRING DIAGRAM

23 CAMRY

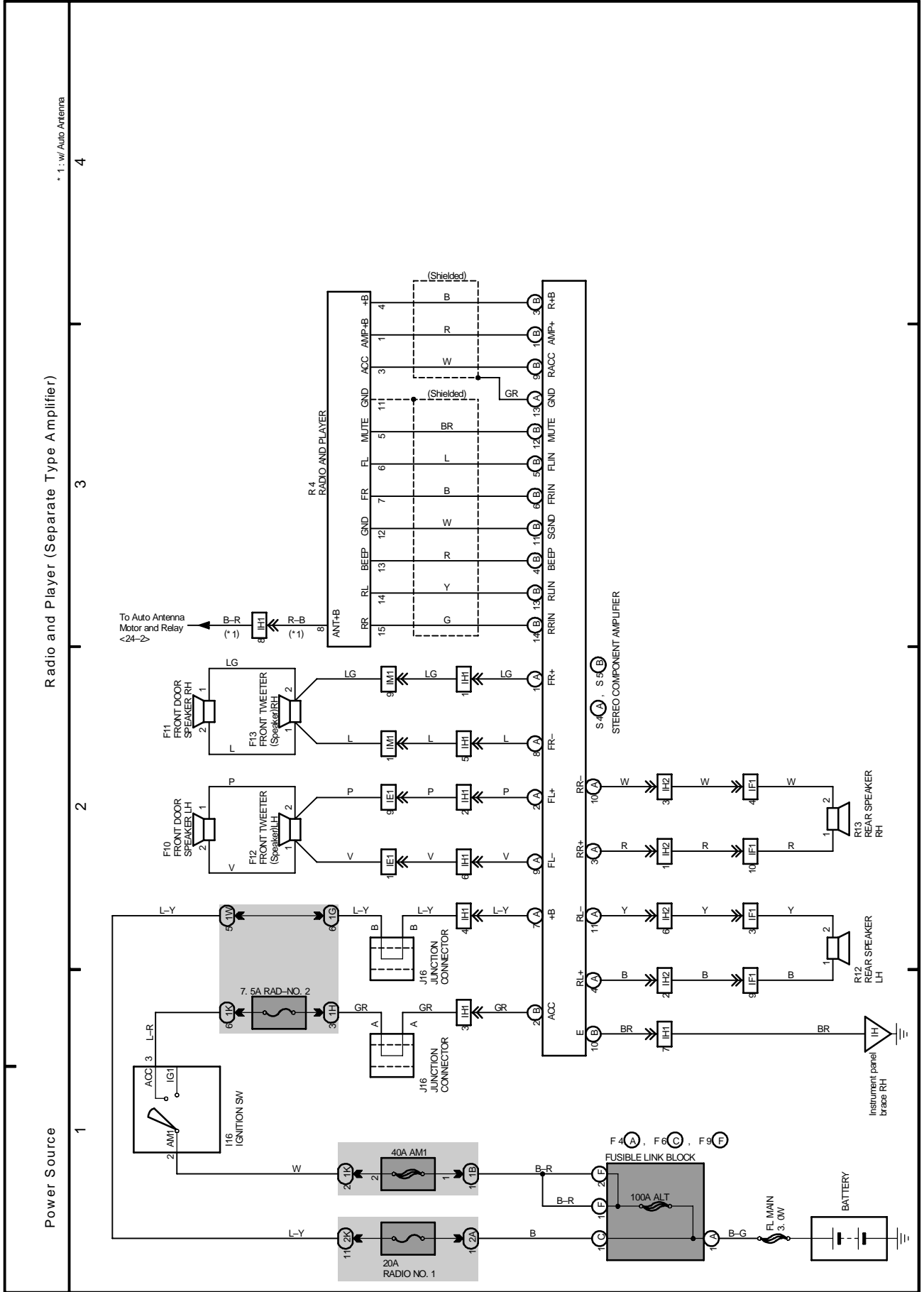

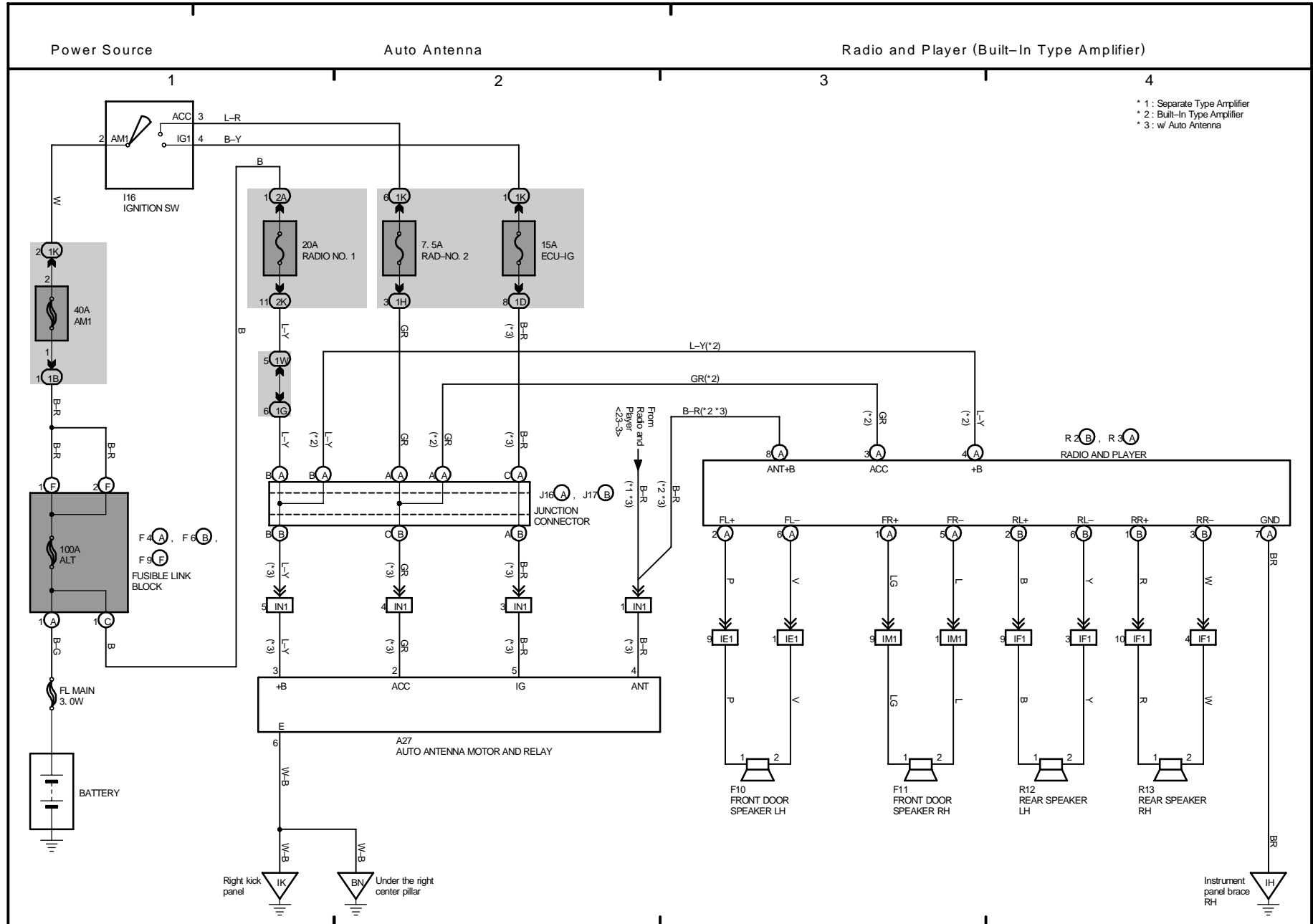

J OVERALL ELECTRICAL WIRING DIAGRAM

25 CAMRY

(Cont. next page)

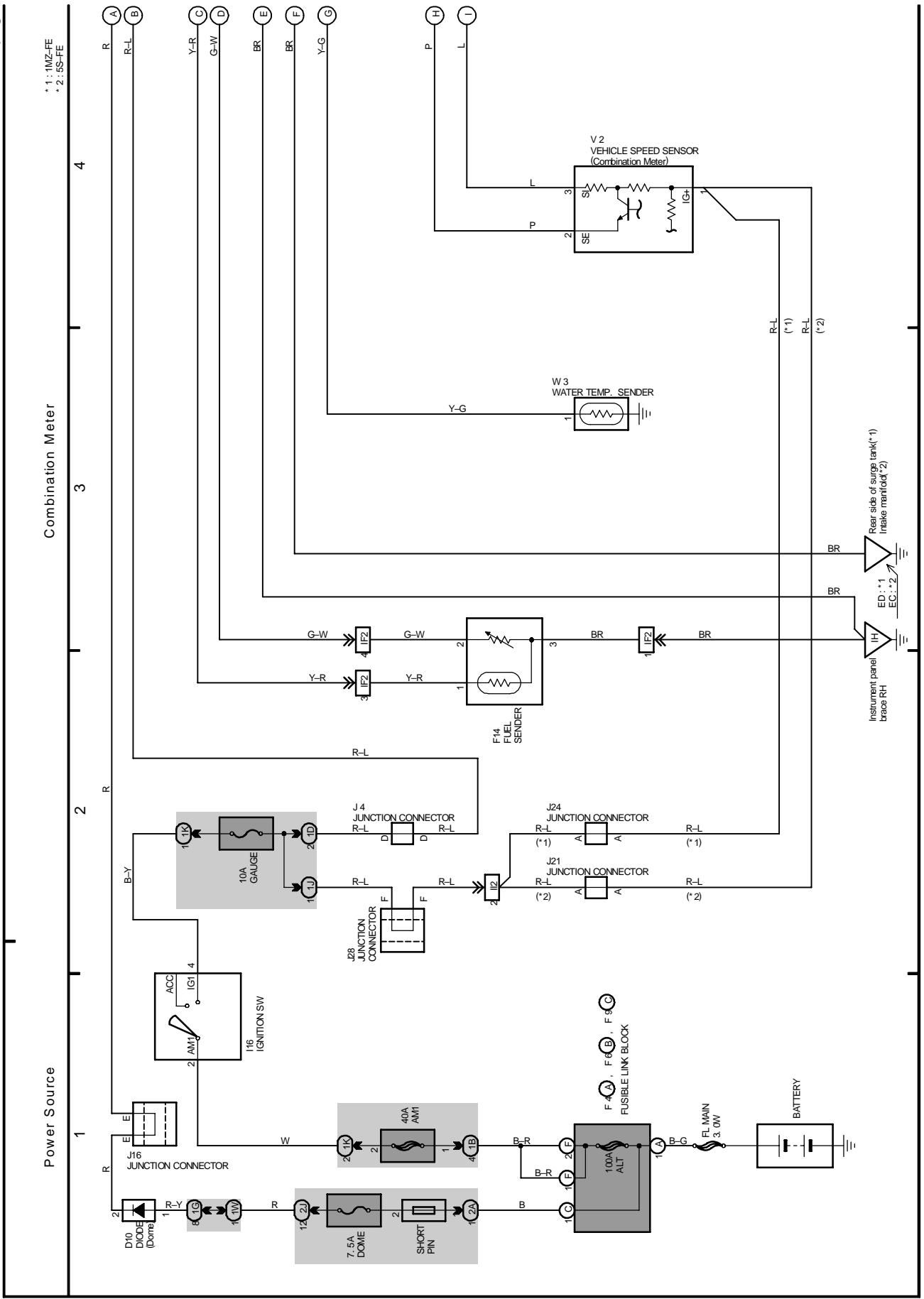

Combination Meter

* 3: Except *4
 * 4: TMMK Made, TMC Made USA w/ Traction Control
 * 5: Speedometer

* 6: w/ Daytime Running Light
 * 7: w/o Daytime Running Light

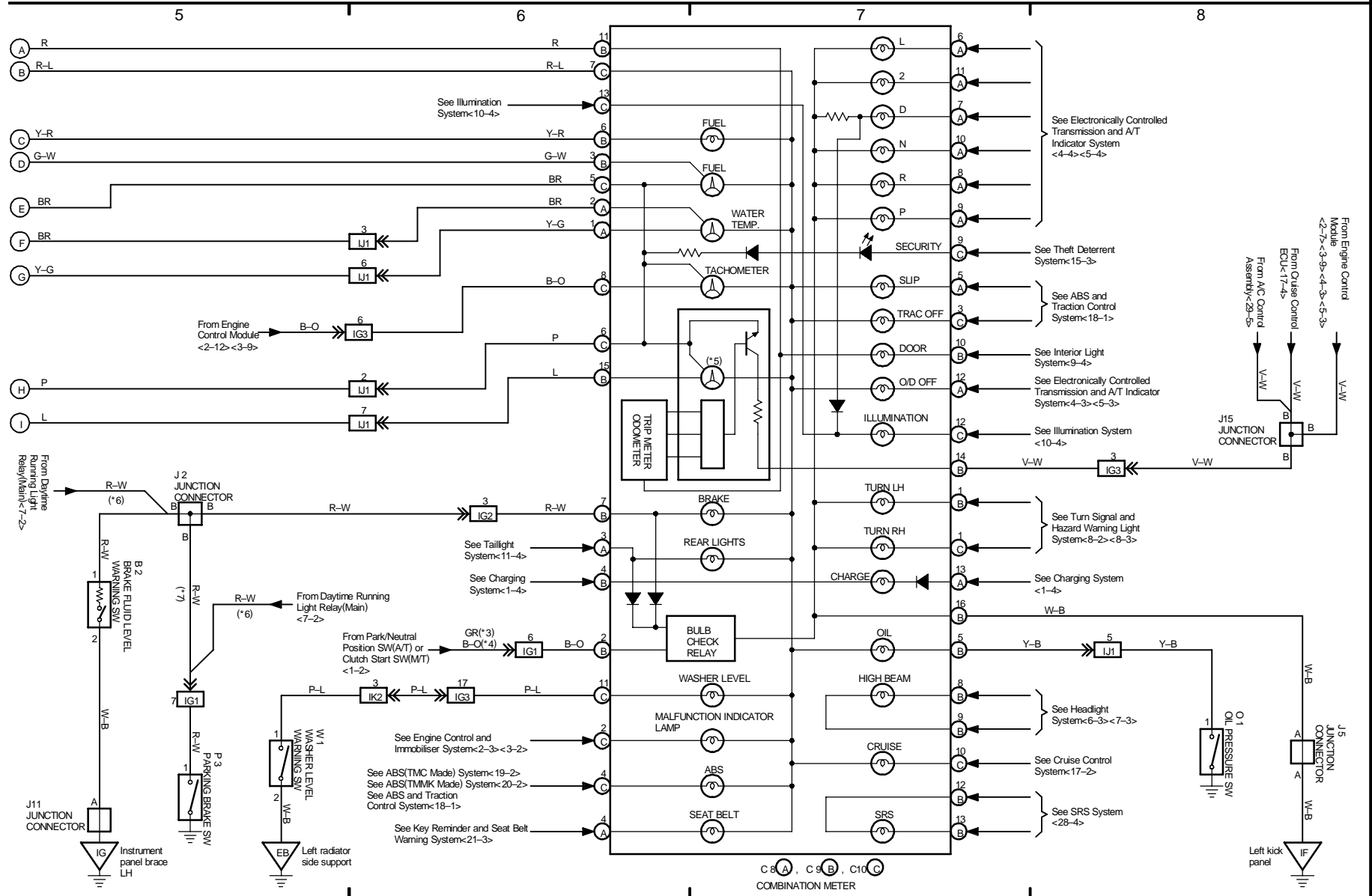

J OVERALL ELECTRICAL WIRING DIAGRAM

26 CAMRY

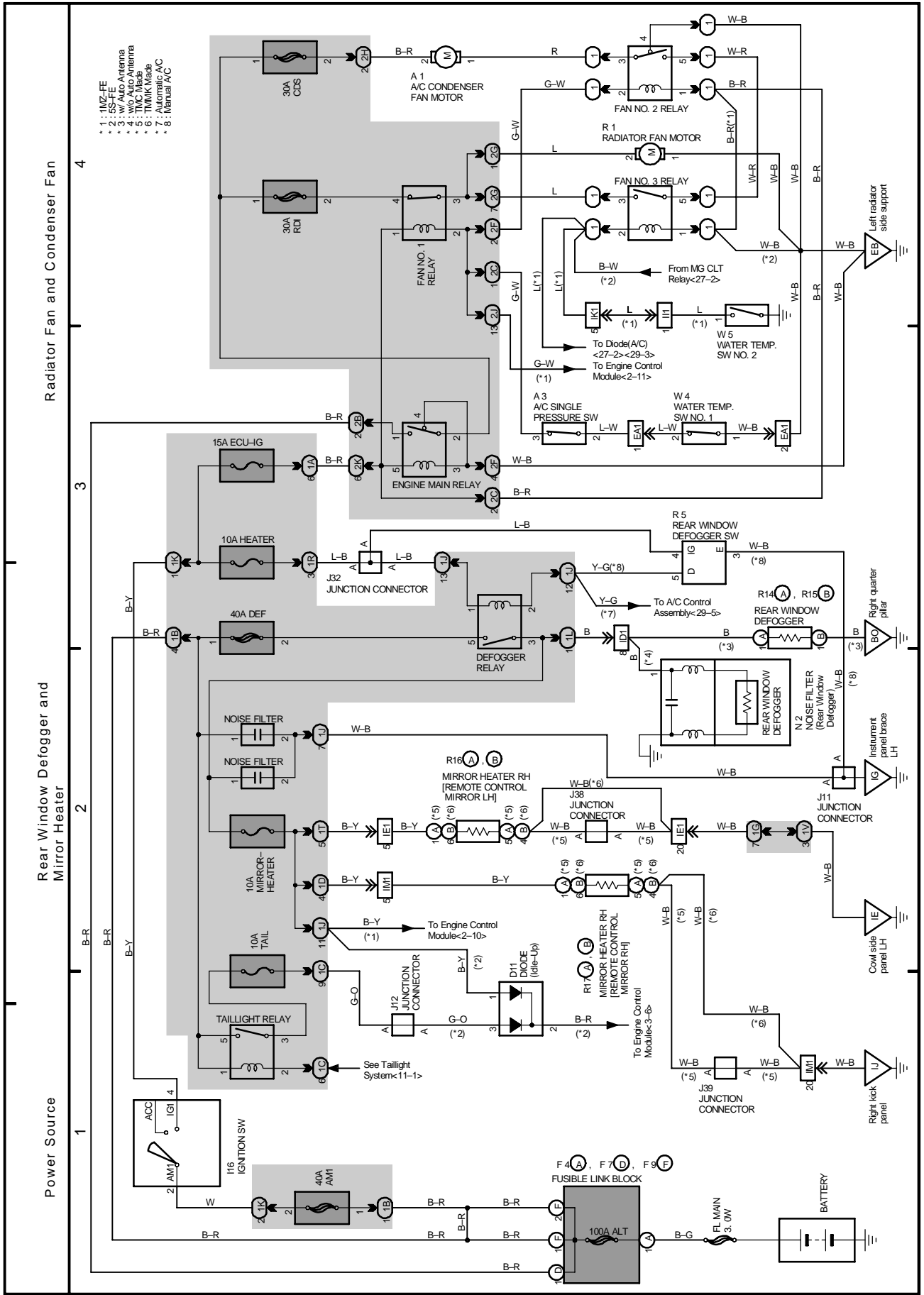

Air Conditioning (Automatic A/C)

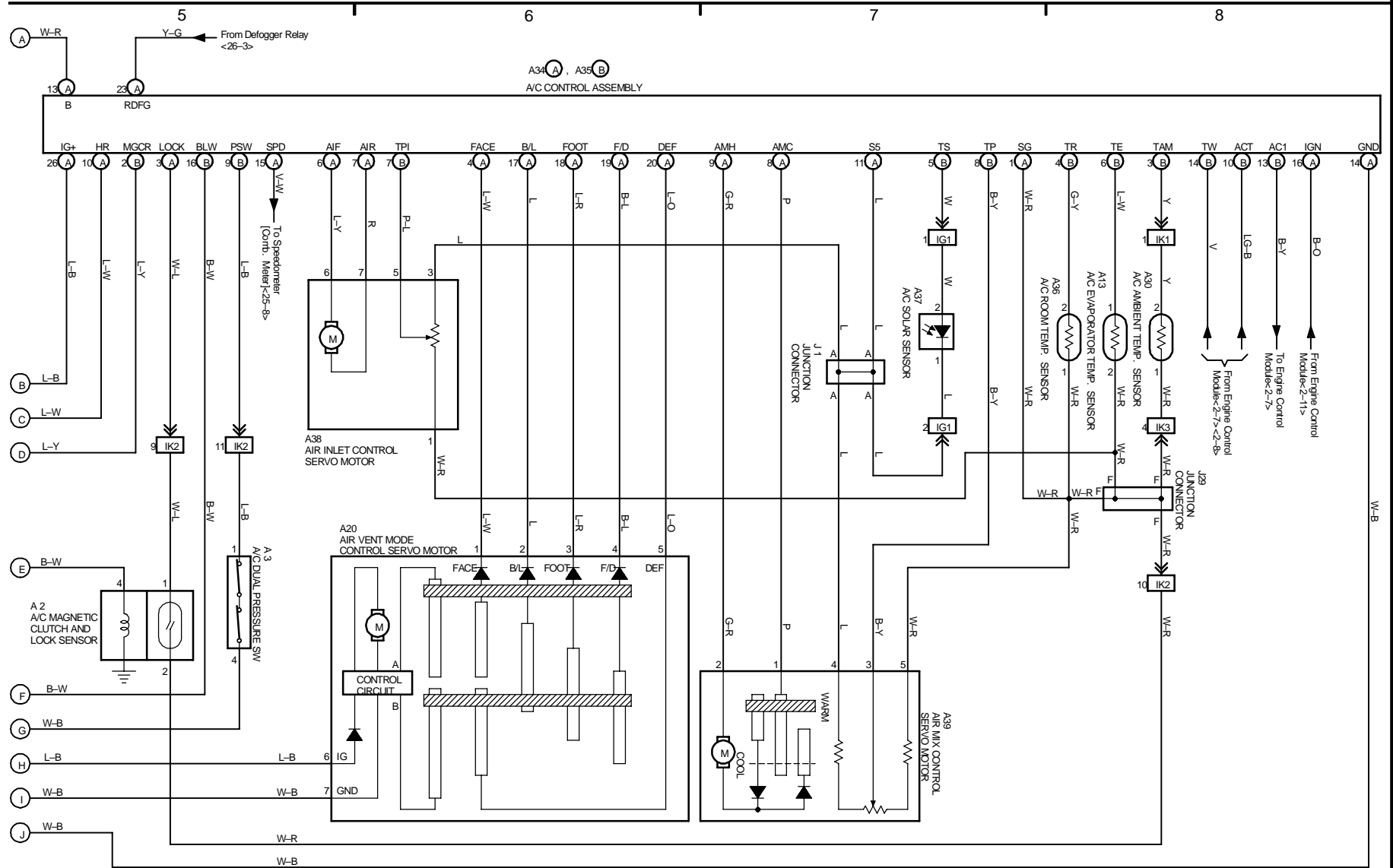

K POWER SOURCE (Current Flow Chart)

The chart below shows the route by which current flows from the battery to each electrical source (Fusible Link, Circuit Breaker, Fuse, etc.) and other Parts.

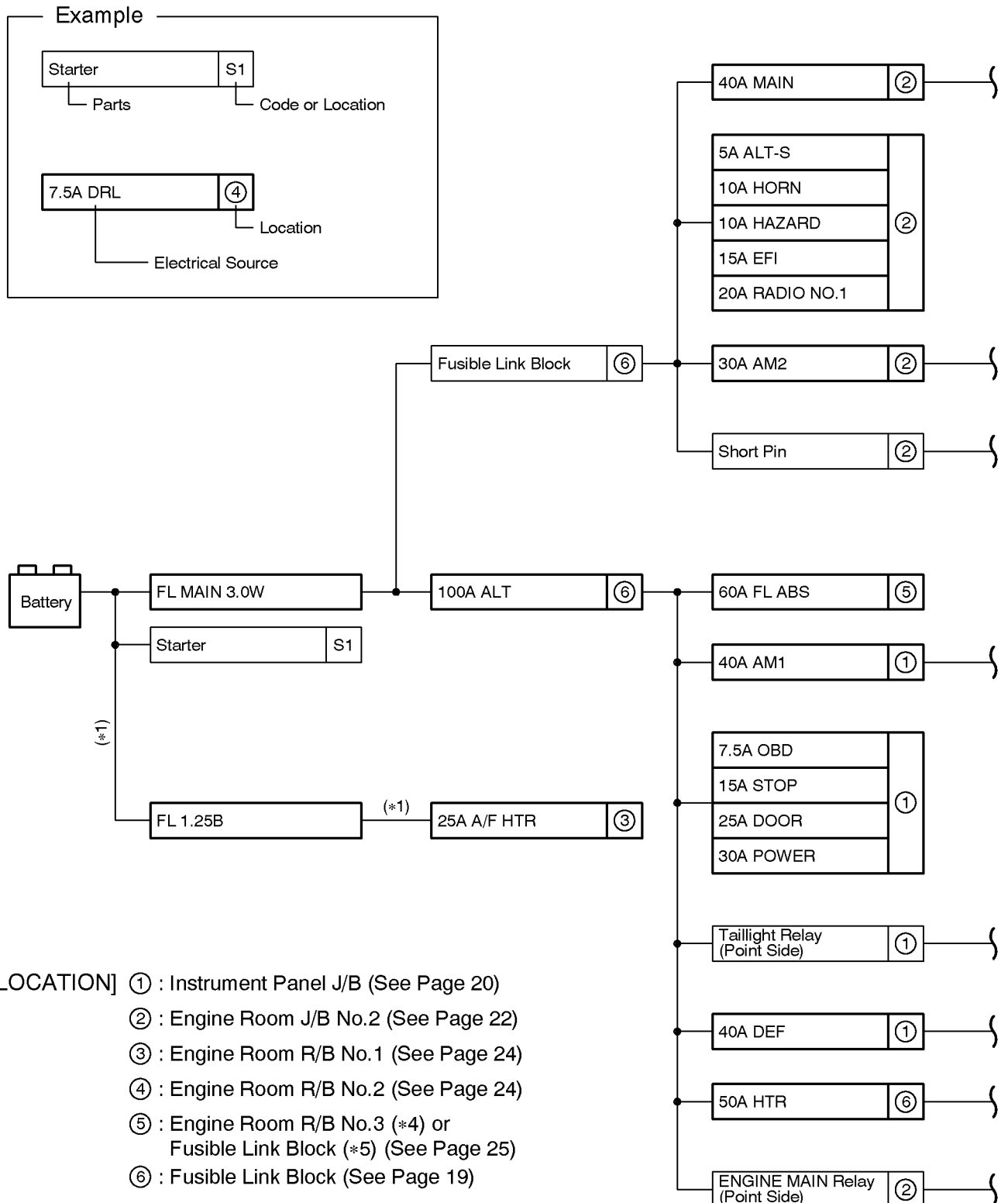

- *1 : California
- *2 : w/ Daytime Running Light
- *3 : w/o Daytime Running Light
- *4 : TMMK Made w/ ABS and Tracction Control, TMC Made w/ ABS, w/ ABS and Tracction Control
- *5 : TMMK Made w/ ABS w/o Tracction Control

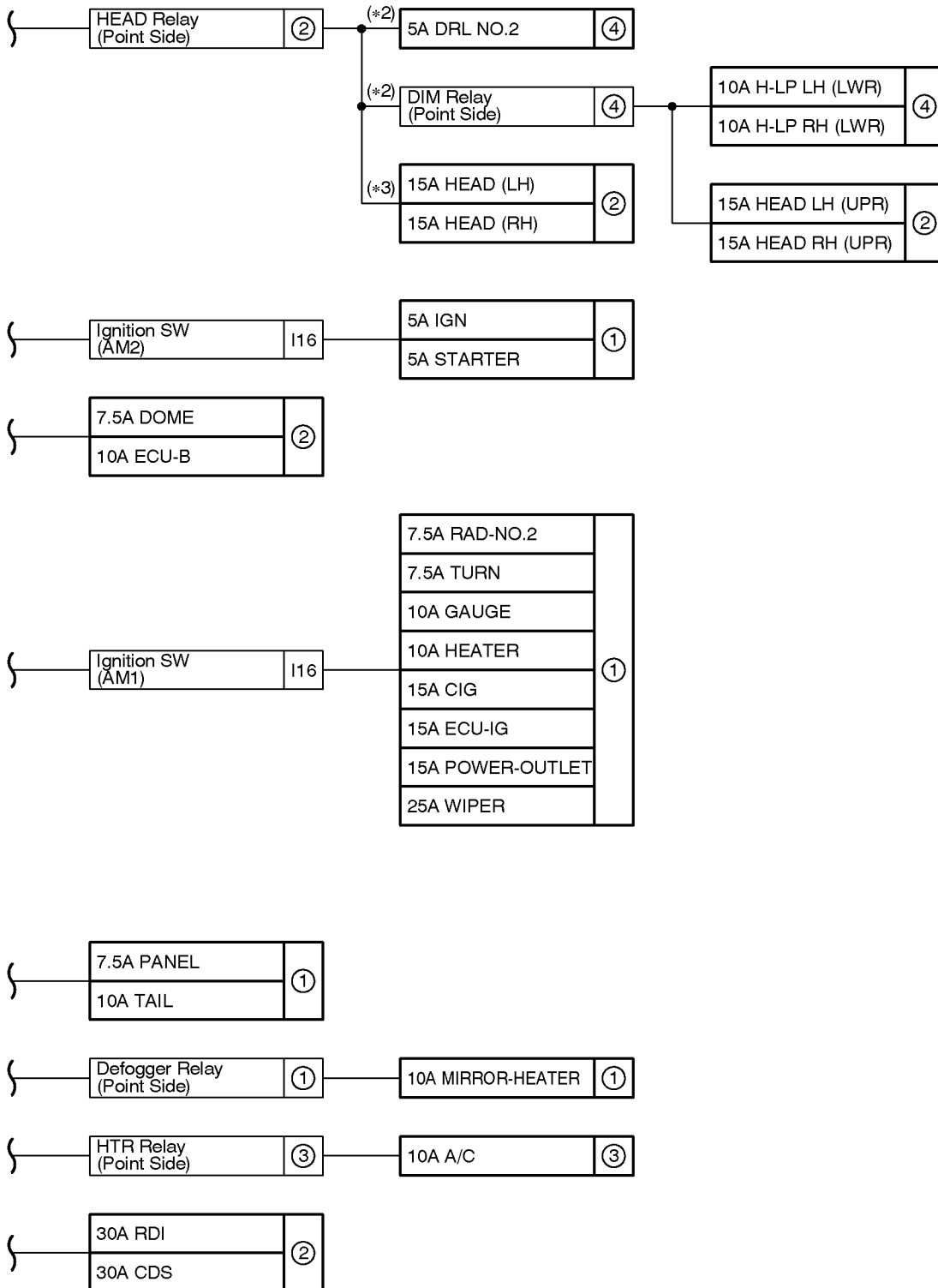

K POWER SOURCE (Current Flow Chart)

Fusible Link Block (See Page 19)

Fuse		System	Page
50A	HTR	Air Conditioning (Automatic A/C)	292
		Air Conditioning (Manual A/C)	300
100A	ALT	Charging	62
		Headlight (w/ Daytime Running Light)	100
		Illumination	126
		Light Auto Turn Off	110
		Radiator Fan and Condenser Fan	288
		Taillight	132
		Theft Deterrent (TMC Made)	182
		Theft Deterrent (TMMK Made)	188
		Wireless Door Lock Control (TMC Made)	162
Wireless Door Lock Control (TMMK Made)	172		

Instrument Panel J/B (See Page 20)

Fuse		System	Page
5A	IGN	Charging	62
		Combination Meter	280
		Electronically Controlled Transmission and A/T Indicator (1MZ-FE)	202
		Electronically Controlled Transmission and A/T Indicator (5S-FE)	210
		Engine Control (1MZ-FE)	66
		Engine Control (5S-FE)	82
		SRS	245
5A	STARTER	Combination Meter	280
		Electronically Controlled Transmission and A/T Indicator (1MZ-FE)	202
		Electronically Controlled Transmission and A/T Indicator (5S-FE)	210
		Engine Control (1MZ-FE)	66
		Engine Control (5S-FE)	82
		Starting and Ignition (1MZ-FE)	54
Starting and Ignition (5S-FE)	58		
7.5A	OBD	Engine Control (1MZ-FE)	66
		Engine Control (5S-FE)	82
7.5A	PANEL	Cigarette Lighter and Clock	258
		Combination Meter	280
		Illumination	126
7.5A	RAD-NO.2	Auto Antenna	272
		Radio and Player (Built-In Type Amplifier)	278
		Radio and Player (Separate Type Amplifier)	274
7.5A	TURN	Turn Signal and Hazard Warning Light	114
10A	GAUGE	ABS (TMC Made)	234
		ABS (TMMK Made)	240
		ABS and Traction Control	226
		Back-Up Light	138
		Charging	62

* These are the page numbers of the first page on which the related system is shown.

Fuse		System	Page
10A	GAUGE	Combination Meter	280
		Cruise Control	218
		Door Lock Control (TMC Made)	150
		Door Lock Control (TMMK Made)	156
		Electronically Controlled Transmission and A/T Indicator (1MZ-FE)	202
		Electronically Controlled Transmission and A/T Indicator (5S-FE)	210
		Engine Control (1MZ-FE)	66
		Engine Control (5S-FE)	82
		Headlight (w/ Daytime Running Light)	100
		Key Reminder and Seat Belt Warning	260
		Light Auto Turn Off	110
		Moon Roof	194
		Power Window	144
		Stop Light	118
Taillight	132		
10A	HEATER	Air Conditioning (Automatic A/C)	292
		Air Conditioning (Manual A/C)	300
		Rear Window Defogger and Mirror Heater	268
10A	MIRROR-HEATER	Engine Control (1MZ-FE)	66
		Engine Control (5S-FE)	82
		Rear Window Defogger and Mirror Heater	268
10A	TAIL	Engine Control (1MZ-FE)	66
		Engine Control (5S-FE)	82
		Taillight	132
		Wireless Door Lock Control (TMC Made)	162
		Wireless Door Lock Control (TMMK Made)	172
15A	CIG	Cigarette Lighter and Clock	258
		Remote Control Mirror	266
		Shift Lock	252
		SRS	245
15A	ECU-IG	ABS (TMC Made)	234
		ABS (TMMK Made)	240
		ABS and Traction Control	226
		Auto Antenna	272
		Cruise Control	218
		Radiator Fan and Condenser Fan	288
		Shift Lock	252
		Theft Deterrent (TMC Made)	182
		Theft Deterrent (TMMK Made)	188
		Wireless Door Lock Control (TMC Made)	162
		Wireless Door Lock Control (TMMK Made)	172
15A	POWER-OUTLET	Power Outlet	264

* These are the page numbers of the first page on which the related system is shown.

K POWER SOURCE (Current Flow Chart)

Fuse		System	Page
15A	STOP	ABS (TMC Made)	234
		ABS (TMMK Made)	240
		ABS and Traction Control	226
		Cruise Control	218
		Electronically Controlled Transmission and A/T Indicator (1MZ-FE)	202
		Electronically Controlled Transmission and A/T Indicator (5S-FE)	210
		Engine Control (1MZ-FE)	66
		Engine Control (5S-FE)	82
		Shift Lock	252
		Stop Light	118
25A	WIPER	Wiper and Washer	140
25A	DOOR	Door Lock Control (TMC Made)	150
		Door Lock Control (TMMK Made)	156
		Moon Roof	194
		Power Window	144
		Theft Deterrent (TMC Made)	182
		Theft Deterrent (TMMK Made)	188
		Wireless Door Lock Control (TMC Made)	162
		Wireless Door Lock Control (TMMK Made)	172
30A	POWER	Door Lock Control (TMC Made)	150
		Door Lock Control (TMMK Made)	156
		Moon Roof	194
		Power Seat	198
		Power Window	144
40A	AM1	Charging	62
		Radiator Fan and Condenser Fan	288
40A	DEF	Rear Window Defogger and Mirror Heater	268

Engine Room J/B No.2 (See Page 22)

Fuse		System	Page
5A	ALT-S	Charging	62
7.5A	DOME	Cigarette Lighter and Clock	258
		Combination Meter	280
		Headlight (w/ Daytime Running Light)	100
		Interior Light	122
		Key Reminder and Seat Belt Warning	260
		Light Auto Turn Off	110
		Moon Roof	194
		Theft Deterrent (TMC Made)	182
		Theft Deterrent (TMMK Made)	188
		Wireless Door Lock Control (TMC Made)	162
		Wireless Door Lock Control (TMMK Made)	172

* These are the page numbers of the first page on which the related system is shown.

Fuse		System	Page
10A	ECU-B	Air Conditioning (Automatic A/C)	292
		Combination Meter	280
		SRS	245
10A	HAZARD	Turn Signal and Hazard Warning Light	114
10A	HORN	Horn	256
		Theft Deterrent (TMC Made)	182
		Theft Deterrent (TMMK Made)	188
		Wireless Door Lock Control (TMC Made)	162
		Wireless Door Lock Control (TMMK Made)	172
15A	EFI	Electronically Controlled Transmission and A/T Indicator (1MZ-FE)	202
		Electronically Controlled Transmission and A/T Indicator (5S-FE)	210
		Engine Control (1MZ-FE)	66
		Engine Control (5S-FE)	82
		Engine Immobiliser System	94
15A	HEAD (LH)	Headlight (w/o Daytime Running Light)	96
15A	HEAD (RH)	Headlight (w/o Daytime Running Light)	96
15A	HEAD LH (UPR)	Headlight (w/ Daytime Running Light)	100
15A	HEAD RH (UPR)	Headlight (w/ Daytime Running Light)	100
20A	RADIO NO.1	Auto Antenna	272
		Radio and Player (Built-In Type Amplifier)	278
		Radio and Player (Separate Type Amplifier)	274
30A	AM2	Charging	62
		Engine Control (1MZ-FE)	66
		Engine Control (5S-FE)	82
		Starting and Ignition (1MZ-FE)	54
		Starting and Ignition (5S-FE)	58
30A	CDS	Radiator Fan and Condenser Fan	288
30A	RDI	Radiator Fan and Condenser Fan	288
40A	MAIN	Headlight (w/ Daytime Running Light)	100
		Headlight (w/o Daytime Running Light)	96
		Light Auto Turn Off	110
		Starting and Ignition (1MZ-FE)	54
		Starting and Ignition (5S-FE)	58
		Theft Deterrent (TMC Made)	182
		Theft Deterrent (TMMK Made)	188
		Wireless Door Lock Control (TMC Made)	162
		Wireless Door Lock Control (TMMK Made)	172

Engine Room R/B No.1 (See Page 24)

Fuse		System	Page
10A	A/C	Air Conditioning (Manual A/C)	300
25A	A/F HTR	Engine Control (1MZ-FE)	66

* These are the page numbers of the first page on which the related system is shown.

K POWER SOURCE (Current Flow Chart)

Engine Room R/B No.2 (See Page 24)

Fuse		System	Page
5A	DRL NO.2	Headlight (w/ Daytime Running Light)	100
10A	H-LP LH (LWR)	Headlight (w/ Daytime Running Light)	100
10A	H-LP RH (LWR)	Headlight (w/ Daytime Running Light)	100

Engine Room R/B No.3 (TMMK Made w/ ABS and Traction Control)

(TMC Made w/ ABS, w/ ABS and Traction Control) **OR**

Fusible Link Block (TMMK Made w/ ABS w/o Traction Control) (See Page 25)

Fuse		System	Page
60A	FL ABS	ABS (TMC Made)	234
		ABS (TMMK Made)	240
		ABS and Traction Control	226

* These are the page numbers of the first page on which the related system is shown.

L PART NUMBER OF CONNECTORS

Code	Part Name	Part Number	Code	Part Name	Part Number
A 1	A/C Condenser Fan Motor	90980-10928	B 4	Blower Resistor	90980-10976
A 2	A/C Magnetic Clutch and Lock Sensor	90980-10942	B 5	Blower SW	90980-10877
A 3	A/C Triple Pressure SW (A/C Dual and Single Pressure SW)	90980-10943	B 6	Buckle SW LH	90980-10825
A 4	ABS Actuator	90980-11413	B 7	Buckle SW LH	
A 5	ABS Actuator	90980-10891	B 8	Blower Resistor (Low Speed)	90980-10976
A 6	ABS Actuator and ECU	90080-98070	C 1	Camshaft Position Sensor	90980-10947
A 7	ABS and Traction Actuator	90980-11698	C 2	Crankshaft Position Sensor	
A 8	ABS and Traction Actuator	90980-11413	C 3	Cruise Control Actuator	90980-11150
A 9	ABS Speed Sensor Front LH	90980-11075	C 4	Cigarette Lighter	90980-10760
A10	ABS Speed Sensor Front RH				
A11	Air Fuel Ratio Sensor	90980-11178	C 5	Cigarette Lighter Illumination	90980-11148
A12	A/C Amplifier	90980-10807	C 6	Clock	90980-11013
A13	A/C Evaporator Temp. Sensor	90980-10825	C 7	Clutch Start SW	90980-10825
A14	A/C SW	90980-10631	C 8	Combination Meter (TMC Made)	90980-11114
A15	ABS and Traction ECU	90980-11390		Combination Meter (TMMK Made)	90980-98048
A16	ABS and Traction ECU	90980-11391	C 9	Combination Meter (TMC Made)	90980-11113
A17	ABS and Traction ECU	90980-11424		Combination Meter (TMMK Made)	90980-98046
A18	ABS ECU		C10	Combination Meter (TMC Made)	90980-11115
A19	ABS ECU	90980-11390		Combination Meter (TMMK Made)	90980-98047
A20	Air Vent Mode Control Servo Motor	90980-11165	C11	Combination SW	90980-11594
A22	Airbag Squib (Front Passenger Airbag Assembly)	90980-11884	C12	Combination SW	90980-11616
A23	Airbag Squib (Steering Wheel Pad)	90980-10850	C13	Combination SW	90980-11672
A24	Ashtray Illumination	81945-33010	C14	Cruise Control Clutch SW	90980-10906
A25	ABS Speed Sensor Rear LH	90980-11060	C15	Cruise Control ECU	90980-11391
A26	ABS Speed Sensor Rear RH				
A27	Auto Antenna Motor and Relay	90980-11697	C16	Condenser	90980-10860
A28	Air Fuel Ratio Sensor (Bank 1 Sensor 1)	90980-11178	C17	Center Airbag Sensor Assembly	90980-11869
A29	Air Fuel Ratio Sensor (Bank 2 Sensor 1)				
A30	A/C Ambient Temp. Sensor	90980-11070	C18	Center Airbag Sensor Assembly	90980-11872
A31	Airbag Sensor Front LH	90980-11856	C19	Center Airbag Sensor Assembly	90980-11867
A32	Airbag Sensor Front RH				
A33	A/C Blower Motor Linear Controller	90980-11676	D 1	Data Link Connector 1 (1MZ-FE)	90980-11195
A34	A/C Control Assembly	90980-11390		Data Link Connector 1 (5S-FE)	90980-11323
A35	A/C Control Assembly	90980-11391	D 2	Daytime Running Light Resistor	90980-10928
A36	A/C Room Temp. Sensor	90980-10825	D 3	Diode (A/C)	90980-11071
A37	A/C Solar Sensor	90980-11918	D 4	Data Link Connector 2	90980-11417
A38	Air Inlet Control Servo Motor	90980-11165	D 5	Data Link Connector 3	90980-11665
A39	Air Mix Control Servo Motor	90980-11319	D 6	Daytime Running Light Relay (Main)	90980-11058
A40	Automatic Light Control Sensor	90980-11107	D 7	Diode (Courtesy)	90980-10962
B 1	Back-Up Light SW	90980-11250	D10	Diode (Dome)	
B 2	Brake Fluid Level Warning SW	90980-11207	D11	Diode (Idle-Up)	90980-11071
B 3	Blower Motor	90980-10903	D12	Door Courtesy SW Front LH	90980-10871
			D13	Door Courtesy SW Front RH	
			D14	Door Courtesy SW Rear LH	
			D15	Door Courtesy SW Rear RH	
			D16	Door Key Lock and Unlock SW Front LH	90980-11490
			D17	Door Key Lock and Unlock SW Front RH	

Note: Not all of the above part numbers of the connector are established for the supply. In case of ordering a connector or terminal with wire, please confirm in advance if there is supply for it using "Parts Catalog News" (published by Parts Engineering Administration Dept.).

Code	Part Name	Part Number	Code	Part Name	Part Number
D18	Door Lock Control SW RH (TMC Made)	90980-11326	H 1	Headlight LH	90980-11314
	Door Lock Control SW RH (TMMK Made)	90980-10797	H 2	Headlight RH	
D19	Door Lock Motor and Door Unlock Detection SW Front LH	90980-11150	H 3	Heated Oxygen Sensor (Bank 1 Sensor 1)	90980-11028
D20	Door Lock Motor and Door Unlock Detection SW Front RH		H 4	Heated Oxygen Sensor (Bank 2 Sensor 1)	
D21	Door Lock Motor and Door Unlock Detection SW Rear LH		H 5	Horn (High)	90980-10619
D22	Door Lock Motor and Door Unlock Detection SW Rear RH		H 6	Horn (Low)	
E 1	EGR Gas Temp. Sensor		90980-10899	H 7	Hazard SW
E 2	EGR Valve Position Sensor	90980-11143	H 8	Heated Oxygen Sensor (Bank 1 Sensor 2)	90980-11028
E 3	Electronically Controlled Transmission Solenoid (1MZ-FE)	90980-10854	H 9	Heater Control SW	90980-10799
	Electronically Controlled Transmission Solenoid (5S-FE)	90980-11156	H10	High Mounted Stop Light	90980-11148
E 4	Electronically Controlled Transmission Solenoid	90980-11143	I 1	Idle Air Control Valve	90980-11145
E 5	Engine Coolant Temp. Sensor	90980-10737	I 2	Igniter	90980-11653
E 6	Engine Hood Courtesy SW	90980-11189	I 3	Ignition Coil and Igniter No.1	90980-11150
E 7	Engine Control Module (1MZ-FE)	90980-11638	I 4	Ignition Coil and Igniter No.2	
	Engine Control Module (5S-FE)	90980-11392	I 5	Ignition Coil No.1	90980-11246
E 8	Engine Control Module (1MZ-FE)	90980-11637	I 6	Ignition Coil No.2	
	Engine Control Module (5S-FE)	90980-11391	I 7	Ignition Coil No.3	
E 9	Engine Control Module (1MZ-FE)	90980-11586	I 8	Injector No.1	90980-11153
	Engine Control Module (5S-FE)	90980-11390	I 9	Injector No.2	
E 10	Engine Control Module (1MZ-FE)	90980-11476	I10	Injector No.3	
	Engine Control Module (5S-FE)	90980-11408	I11	Injector No.4	
E 11	Engine Control Module	90980-11421	I12	Injector No.5	
			I13	Injector No.6	
F 1	Front Turn Signal Light and Parking Light LH	90980-11020	I14	Intake Air Temp. Sensor	90980-11163
F 2	Front Turn Signal Light and Parking Light RH		I15	Ignition Key Cylinder Light	90980-10906
F 3	Front Wiper Motor	90980-11599	I16	Ignition SW	90980-11615
F 4	Fusible Link Block	-	I17	Integration Relay	90980-11107
F 5	Fusible Link Block		I18	Integration Relay (w/ Theft Deterrent)	90980-11058
F 6	Fusible Link Block			Integration Relay (w/o Theft Deterrent)	90980-11542
F 7	Fusible Link Block		I19	Interior Light	90980-10121
F 8	Fusible Link Block		J 1	Junction Connector	90980-11542
F 9	Fusible Link Block	90980-11579	J 2	Junction Connector	90980-10803
F10	Front Door Speaker LH	90980-10825	J 3	Junction Connector	90980-11542
F11	Front Door Speaker RH		J 4	Junction Connector	90980-10803
F12	Front Tweeter (Speaker) LH	90980-10916	J 5	Junction Connector	90980-11542
F13	Front Tweeter (Speaker) RH		J 6	Junction Connector	90980-11502
F14	Fuel Pump and Sender	90980-11077	J 7	Junction Connector	90980-11661
G 1	Generator	90980-09213	J 8	Junction Connector	
G 2	Generator	90980-11349	J 9	Junction Connector	
G 3	Glove Box Light and SW	90980-11098	J10	Junction Connector	90980-10976
			J12	Junction Connector	90980-10803
			J13	Junction Connector	90980-11661
			J14	Junction Connector	

L PART NUMBER OF CONNECTORS

Code	Part Name	Part Number	Code	Part Name	Part Number
J15	Junction Connector	90980-10803	P 1	Park/Neutral Position SW,A/T Indicator Light SW and Back-Up Light SW	90980-11332
J16	Junction Connector	90980-11661	P 2	Power Steering Oil Pressure SW	90980-11428
J17	Junction Connector		P 3	Parking Brake SW	90980-10871
J18	Junction Connector	90980-11542	P 4	Power Outlet	90980-10760
J19	Junction Connector		P 5	Personal Light	90980-10825
J20	Junction Connector	90980-11539	P 6	Power Window Control SW Front RH	90980-10789
J21	Junction Connector	90980-11542	P 7	Power Window Control SW Rear LH	90980-10631
J22	Junction Connector	90980-11539	P 8	Power Window Control SW Rear RH	
J23	Junction Connector		90980-11529	P 9	Power Window Master SW and Door Lock Control SW LH
J24	Junction Connector	P10		Power Window Motor Front LH	90980-10860
J25	Junction Connector	P11		Power Window Motor Front RH	
J26	Junction Connector	P12	Power Window Motor Rear LH		
J27	Junction Connector	90980-11661	P13	Power Window Motor Rear RH	
J28	Junction Connector		P14	Power Seat Control SW (Driver's Seat)	90980-10803
J29	Junction Connector	90980-11502	P15	Power Seat Control SW (Front Passenger's Seat)	
J30	Junction Connector	90980-11661	P16	Power Seat Motor (Driver's Seat Rear Vertical Control)	90980-10825
J31	Junction Connector		P17	Power Seat Motor (Driver's Seat Reclining Control)	
J32	Junction Connector	90980-10803	P18	Power Seat Motor (Driver's Seat Slide Control)	
J33	Junction Connector	90980-11661	P19	Power Seat Motors (Driver's Seat)	90980-11001
J34	Junction Connector		P20	Power Seat Motor (Front Passenger's Seat Rear Vertical Control)	90980-10825
J35	Junction Connector		P21	Power Seat Motor (Front Passenger's Seat Reclining Control)	
J36	Junction Connector		P22	Power Seat Motor (Front Passenger's Seat Slide Control)	
J37	Junction Connector	90980-11542	P23	Power Seat Motors (Front Passenger's Seat)	90980-11001
J38	Junction Connector	90980-10803	P24	Pretensioner LH	90980-11862
J39	Junction Connector		P25	Pretensioner RH	
J40	Junction Connector	90980-10976	R 1	Radiator Fan Motor	90980-10928
K 1	Knock Sensor 1	90980-11166	R 2	Radio and Player	90980-10996
K 2	Knock Sensor 2		R 3	Radio and Player	90980-10997
K 3	Key Interlock Solenoid	90980-10825	R 4	Radio and Player	90980-11264
L 1	License Plate Light LH	90980-11148	R 5	Rear Window Defogger SW	90980-11280
L 2	License Plate Light RH		R 6	Remote Control Mirror SW	90980-11450
L 3	Light Failure Sensor	90980-10803	R 7	Rheostat	90980-10908
L 4	Luggage Compartment Key Unlock SW	90980-11212	R 8	Rear Combination Light LH	90980-10795
L 5	Luggage Compartment Light	90980-11148	R 9	Rear Combination Light LH	90980-11001
L 6	Luggage Compartment Light SW	90980-11097	R10	Rear Combination Light RH	90980-10795
M 1	Manifold Absolute Pressure Sensor	90980-10845	R11	Rear Combination Light RH	90980-11001
M 2	Mass Air Flow Meter	90980-11317			
M 3	Moon Roof Control SW and Relay	90980-10799			
M 4	Moon Roof Motor and Limit SW	90980-11011			
N 1	Noise Filter (Ignition)	90980-10843			
N 2	Noise Filter (Rear Window Defogger)	90980-11259			
O 1	Oil Pressure SW	90980-11363			
O 2	O/D Main SW and A/T Shift Lever Illumination	90980-10795			

Note: Not all of the above part numbers of the connector are established for the supply. In case of ordering a connector or terminal with wire, please confirm in advance if there is supply for it using "Parts Catalog News" (published by Parts Engineering Administration Dept.).

Code	Part Name	Part Number	Code	Part Name	Part Number
R12	Rear Speaker LH	90980-10860	T 1	Theft Deterrent Horn	90980-11235
R13	Rear Speaker RH		T 2	Throttle Position Sensor	90980-11261
R14	Rear Window Defogger	90980-10792	T 3	Theft Deterrent ECU	90980-11424
R15	Rear Window Defogger		T 4	Theft Deterrent ECU	90980-11392
R16	Remote Control Mirror LH (TMC Made w/ Mirror Heater)	90980-10558	T 5	Traction Off SW	90980-11013
	Remote Control Mirror LH (TMC Made w/o Mirror Heater)	90980-10395	T 6	Turn Signal Flasher	82751-50010
	Remote Control Mirror LH (TMMK Made w/ Mirror Heater)	90980-11487	T 7	Transponder Key Amplifier	90980-10789
	Remote Control Mirror LH (TMMK Made w/o Mirror Heater)	90980-11489	U 1	Unlock Warning SW	90980-10860
R17	Remote Control Mirror RH (TMC Made w/ Mirror Heater)	90980-10558	V 1	Vapor Pressure Sensor	90980-11860
	Remote Control Mirror RH (TMC Made w/o Mirror Heater)	90980-10395	V 2	Vehicle Speed Sensor (Combination Meter)	90980-11143
	Remote Control Mirror RH (TMMK Made w/ Mirror Heater)	90980-11487	V 3	Vehicle Speed Sensor (Electronically Controlled Transmission)	90980-11156
	Remote Control Mirror RH (TMMK Made w/o Mirror Heater)	90980-11489	V 4	VSV (EGR)(1MZ-FE)	90980-11149
S 1	Starter	90980-09689		VSV (EGR)(5S-FE)	90980-11156
S 2	Starter	90980-11400	V 5	VSV (EVAP)	
S 3	Shift Lock ECU	90980-11488	V 6	VSV (Intake Air Control)	90980-11149
S 4	Stereo Component Amplifier	90980-10848	V 7	VSV (Vapor Pressure Sensor)	90980-11859
S 5	Stereo Component Amplifier	90980-10807	V 8	Vanity Light LH	90980-10621
S 6	Stop Light SW	90980-11118	V 9	Vanity Light RH	
S 7	Side Airbag Sensor LH	90980-11857	W 1	Washer Level Warning SW	90980-11068
S 8	Side Airbag Sensor RH		W 2	Washer Motor	90980-10981
S 9	Side Airbag Squib LH	90980-11864	W 3	Water Temp. Sender	90980-11428
S10	Side Airbag Squib RH		W 4	Water Temp. SW No.1	90980-11235
			W 5	Water Temp. SW No.2	90980-11243
			W 6	Wireless Door Lock ECU	90980-11264