

Foreword

This supplement contains explanations and instructions for correctly operating the following systems.

- Audio and Visual System
- Handsfree System
- APPS

If your vehicle contains one of the systems above, be sure to check the contents of this supplement carefully.

If you transfer the ownership of the vehicle to another person, make sure that this supplement is provided with the Owner's Manual inside the vehicle.

The information, specifications and illustrations in this supplement are valid at the time of publication. SUBARU CORPORATION reserves the right to change the specifications and design without prior notice, with no obligation to perform the same or equivalent changes to vehicles sold in the past.

This Owner's Manual supplement applies to all models, and describes all devices, including manufacturer-installed options. This means that information may be included about devices that are not installed in your vehicle.



Subaru STARLINK is the “in-car connectivity system” available on select Subaru vehicles.

SUBARU CORPORATION, TOKYO, JAPAN

“SUBARU” and the six-star cluster design are registered trademarks of SUBARU CORPORATION.

© Copyright 2017 SUBARU CORPORATION

Table of contents

Antenna system	2	Registering/connecting Bluetooth® device	64
FM reception	2	Setting Bluetooth details	67
Installation of accessories	2	Hands-free phone system	69
Audio set	2	Control screen	70
Audio set	4	Registering/connecting a Bluetooth phone	71
Tips for operating the audio/visual system	5	Using the phone	71
Basic information before use	13	How to change the hands-free phone system	72
Basic operation	16	Making a call	72
Unit settings	17	Receiving a call	76
SUBARU STARLINK (if equipped)	24	Talking on the phone	76
AM/FM radio	26	Phone settings	77
SiriusXM Satellite Radio (if equipped)	35	Voice command system	80
aha™ by HARMAN	42	Using the voice command system	80
Pandora® (if equipped)	48	Voice command system operation	81
CD	51	Command list	83
USB memory	53	What to do if	87
iPod	54	Troubleshooting	87
Bluetooth audio	56	Appendix	91
AUX	59	Certification	91
Remote controller on steering wheel	61	Certification for the Hands-free system	91
Bluetooth® settings	64	Certification for Mexico models	92
Regulatory information	64		

Antenna system

■ FM reception

Although FM is normally static free, reception can be affected by the surrounding area, atmospheric conditions, station strength and transmitter distance. Buildings or other obstructions may cause momentary static, flutter or station interference. If reception continues to be unsatisfactory, switch to a stronger station.

Installation of accessories

Always consult your SUBARU dealer before installing a citizen band radio or other transmitting device in your vehicle. Such devices may cause the electronic control system to malfunction if they are incorrectly installed or if they are not suited for the vehicle.

Audio set

Your vehicle may be equipped with one of the following audio sets. Refer to the pages indicated in this section for operating details.



CAUTION

- **Always consult your SUBARU dealer before installing a citizen band radio or other transmitting device in your vehicle. Such devices may cause the electronic control system to malfunction if they are incorrectly installed or if they are not suited for the vehicle.**
- **To prevent the battery from being discharged, do not leave the audio/visual system on when the engine is not running.**

NOTE

- If a cell phone is placed near the audio set, it may cause the audio set to emit noise when the phone receives calls. This noise does not indicate an audio set malfunction. Note that a cell phone should not be placed near the audio set.
- Some functions may not be available depending on the market and specifications of your vehicle.
- The images shown in this Owner's Manual are sample images. The actual images may vary depending on the market and specifications of your vehicle.

■ Audio set

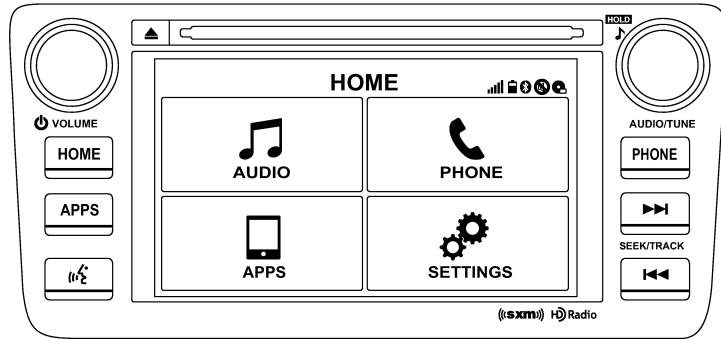

The audio set will operate only when the ignition switch is in the "ACC" or "ON" position.

NOTE

HD Radio Technology should be included as feature.

■ Tips for operating the audio/visual system



CAUTION

To avoid damage to the audio/visual system:

- Be careful not to spill beverages over the audio/visual system.
- Do not put anything other than an appropriate disc into the disc slot.

NOTE

The use of a cell phone inside or near the vehicle may cause a noise from the speakers of the audio/visual system which you are listening to. However, this does not indicate a malfunction.

▼ Radio

Usually, a problem with radio reception does not mean there is a problem with the radio — it is just the normal result of conditions outside the vehicle.

For example, nearby buildings and terrain can interfere with FM reception. Power lines or phone wires can interfere with AM signals. And of course, radio signals have a limited range. The farther the vehicle is

from a station, the weaker its signal will be. In addition, reception conditions change constantly as the vehicle moves.

Here, some common reception problems that probably do not indicate a problem with the radio are described.

▼ FM

Fading and drifting stations: Generally, the effective range of FM is about 25 miles (40 km). Once outside this range, you may notice fading and drifting, which increase with the distance from the radio transmitter. They are often accompanied by distortion.

Multi-path: FM signals are reflective, making it possible for 2 signals to reach the vehicle's antenna at the same time. If this happens, the signals will cancel each other out, causing a momentary flutter or loss of reception.

Static and fluttering: These occur when signals are blocked by buildings, trees or other large objects. Increasing the bass level may reduce static and fluttering.

Station swapping: If the FM signal being listened to is interrupted or weakened, and there is another strong station nearby on the FM band, the radio may tune in the second station until the original signal can be picked up again.

▼ AM

Fading: AM broadcasts are reflected by the upper atmosphere — especially at night. These reflected signals can interfere with those received directly from the radio station, causing the radio station to sound alternately strong and weak.

Station interference: When a reflected signal and a signal received directly from a radio station are very nearly the same frequency, they can interfere with each other, making it difficult to hear the broadcast.

Static: AM is easily affected by external sources of electrical noise, such as high tension power lines, lightning or electrical motors. This results in static.

▼ SiriusXM (if equipped)

- Cargo loaded on the roof luggage carrier, especially metal objects, may adversely affect the reception of SiriusXM Satellite Radio.
- Alteration or modifications carried out without appropriate authorization may invalidate the user's right to operate the equipment.

▼ CD player and disc

- This CD player is intended for use with 4.7 in. (12 cm) discs only.
- Extremely high temperatures can keep the CD player from working. On hot days, use the air conditioning system to cool the inside of the vehicle before using the player.
- Bumpy roads or other vibrations may make the CD player skip.
- If moisture gets into the CD player, the discs may not be able to be played. Remove the discs from the player and wait until it dries.



WARNING

CD players use an invisible laser beam which could cause hazardous radiation exposure if directed outside the unit. Be sure to operate the player correctly.

Audio CDs		

- Use only discs marked as shown above. The following products may not be playable on your player:
 - SACD
 - dts CD
 - Copy-protected CD
 - Video CD

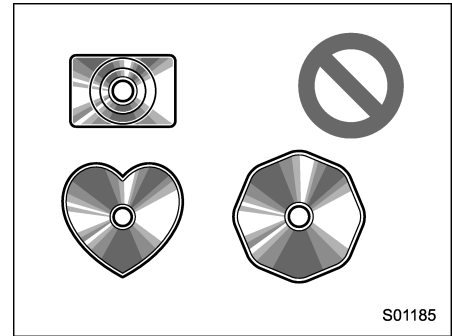

S01185

Special shaped discs

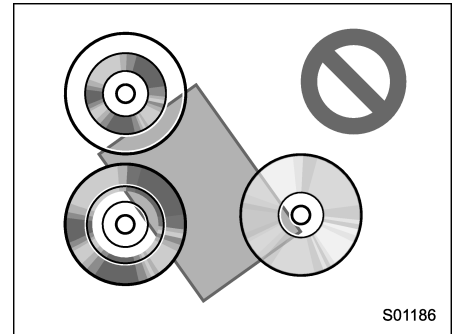

S01186

Transparent/translucent discs

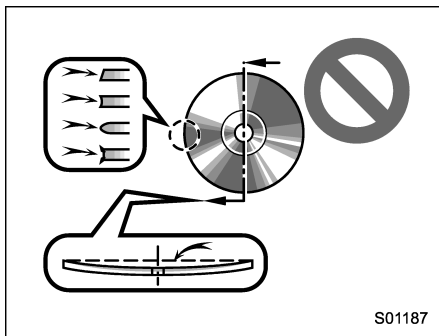

Low quality discs

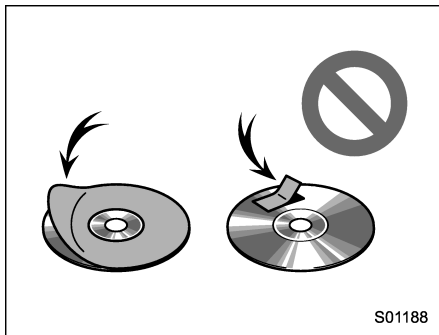

Labeled discs

CAUTION

- Do not use special shaped, transparent/translucent, low quality or labeled discs such as those shown in the illustrations. The use of such discs may damage the player, or it may be impossible to eject the disc.
- This system is not designed for use of Dual Discs. Do not use Dual Discs because they may cause damage to the player.
- Do not use discs with a protection ring. The use of such discs may damage the player, or it may be impossible to eject the disc.
- Do not use printable discs. The use of such discs may damage the player, or it may be impossible to eject the disc.

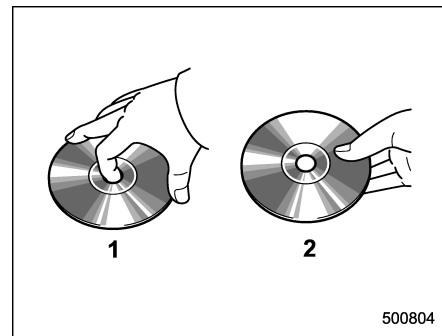

- 1) Correct
- 2) Wrong

- Handle discs carefully, especially when inserting them. Hold them on the edge and do not bend them. Avoid getting fingerprints on them, particularly on the shiny side.
- Dirt, scratches, warping, pin holes or other disc damage could cause the player to skip or to repeat a section of a track. (To see a pin hole, hold the disc up to the light.)
- Remove discs from the players when not in use. Store them in their plastic cases away from moisture, heat and direct sunlight.

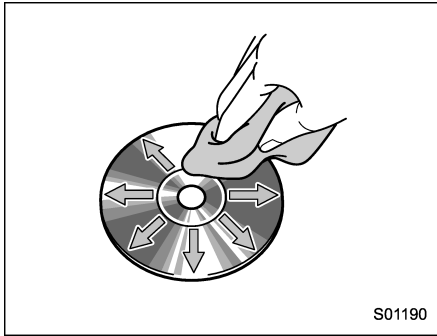

To clean a disc: Wipe it with a soft, lint-free cloth that has been dampened with water. Wipe in a straight line from the center to the edge of the disc (not in circles). Dry it with another soft, lint-free cloth. Do not use a conventional record cleaner or anti-static device.

▽ CD-R/RW discs

- CD-R/CD-RW discs that have not been subject to the “finalizing process” (a process that allows discs to be played on a conventional CD player) cannot be played.
- It may not be possible to play CD-R/CD-RW discs recorded on a music CD recorder or a personal computer because of disc characteristics, scratches or dirt on the disc, or dirt, condensation, etc. on the

lens of the unit.

- It may not be possible to play discs recorded on a personal computer depending on the application settings and the environment. Record with the correct format. (For details, contact the appropriate application manufacturers of the applications.)
- CD-R/CD-RW discs may be damaged by direct exposure to sunlight, high temperatures or other storage conditions. The unit may be unable to play some damaged discs.
- If you insert a CD-RW disc into the player, playback will begin more slowly than with a conventional CD or CD-R disc.
- Recordings on CD-R/CD-RW cannot be played using the DDCD (Double Density CD) system.

▼ USB memory device

- USB communication formats: USB 1.1/2.0 HS (480 Mbps) and FS (12 Mbps)
- File formats: FAT 16/32
- Correspondence class: Mass storage class

▼ iPod

The following iPod, iPod nano, iPod classic, iPod touch and iPhone devices can be used with this system.

Made for

- iPod touch (5th generation)*
- iPod touch (4th generation)
- iPod touch (3rd generation)
- iPod touch (2nd generation)
- iPod touch (1st generation)
- iPod classic
- iPod nano (7th generation)*
- iPod nano (6th generation)*
- iPod nano (5th generation)
- iPod nano (4th generation)
- iPod nano (3rd generation)
- iPod nano (2nd generation)*
- iPod nano (1st generation)*
- iPhone 5s*
- iPhone 5c*
- iPhone 5*
- iPhone 4s
- iPhone 4
- iPhone 3GS
- iPhone 3G
- iPhone

*: iPod video not supported

Depending on differences between models or software versions etc., some models might be incompatible with this system.

▼ File information

Compatible compressed files (Audio)

Item	USB	DISC
Compatible file format	MP3/WMA/AAC	
Folders in the device	Maximum 512	Maximum 255
Files in the device	Maximum 8000	Maximum 512
Files per folder	Maximum 255	—

Corresponding sampling frequency (Audio)

File type	Frequency (kHz)
MP3 files: MPEG 1 LAYER 3	32/44.1/48
MP3 files: MPEG 2 LSF LAYER 3	16/22.05/24
WMA files: Ver. 7, 8, 9 (9.1/9.2)	32/48/64/80/96/128/ 160/192
AAC files: MPEG4/AAC-LC	48/44.1/32/24/22.05/ 16/12/11.025/8

Corresponding bit rates (Audio)

File type	Bit rate (kbps)
MP3 files: MPEG 1 LAYER 3	32 - 320
MP3 files: MPEG 2 LSF LAYER 3	8 - 160
WMA files: Ver. 7, 8	CBR 48 - 192
WMA files: Ver. 9 (9.1/9.2)	CBR 32 - 192
AAC files: MPEG4/AAC-LC	16 - 320

(Variable Bit Rate (VBR) compatible)

- MP3 (MPEG Audio Layer 3), WMA (Windows Media Audio) and AAC (Advanced Audio Coding) are audio compression standards.
- This system can play MP3/WMA/AAC files on CD-R, CD-RW discs, USB memory, and Bluetooth device.
- This system can play disc recordings compatible with ISO 9660 level 1 and level 2 and with the Romeo and Joliet file system.
- When naming an MP3/WMA/AAC file, add an appropriate file extension (.mp3/.wma/.m4a).
- This system plays back files with .mp3/.wma/.m4a file extensions as MP3/WMA/AAC files respectively. To prevent noise

and playback errors, use the appropriate file extension.

- This system can play only the first session when using multi-session compatible CDs.
- MP3 files are compatible with the ID3 Tag Ver. 1.0, Ver. 1.1, Ver. 2.2 and Ver. 2.3 formats. This system cannot display disc title, track title and artist name in other formats.
- WMA/AAC files can contain a WMA/AAC tag that is used in the same way as an ID3 tag. WMA/AAC tags carry information such as track title and artist name.
- The emphasis function is available only when playing MP3/WMA files recorded at 32, 44.1 and 48 kHz.
- This system can play back AAC files encoded by iTunes.
- The sound quality of MP3/WMA files generally improves with higher bit rates. In order to achieve a reasonable level of sound quality, discs recorded with a bit rate of at least 128 kbps are recommended.
- The MP3/WMA player does not play back MP3/WMA files from discs recorded using packet write data transfer (UDF format). Discs should be recorded using “pre-mastering” software rather than packetwrite software.

- M3u playlists are not compatible with the audio device.
- MP3i (MP3 interactive) and MP3PRO formats are not compatible with the audio device.
- The player is compatible with VBR (Variable Bit Rate).
- When playing back files recorded as VBR (Variable Bit Rate) files, the play time will not be correctly displayed if the fast forward or reverse operations are used.
- It is not possible to check folders that do not include MP3/WMA/AAC files.
- MP3/WMA/AAC files in folders up to 8 levels deep can be played. However, the start of playback may be delayed when using discs containing numerous levels of folders. For this reason, we recommend creating discs with no more than 2 levels of folders.

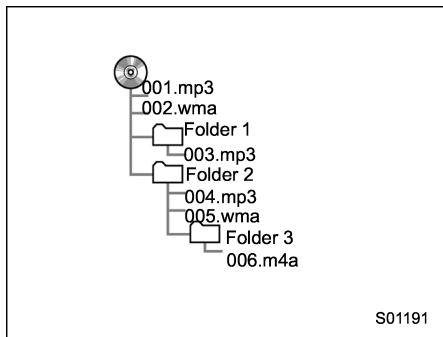

- The play order of the compact disc with the structure shown above is as follows:

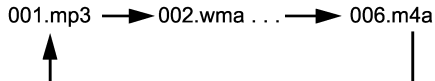

- The order changes depending on the personal computer and MP3/WMA/AAC encoding software you use.

▼ Terms

▽ Packet write

- This is a general term that describes the process of writing data on-demand to CD-R, etc., in the same way that data is written to floppy or hard discs.

▽ ID3 tag

- This is a method of embedding track-related information in an MP3 file. This embedded information can include the track number, track title, the artist's name, the album title, the music genre, the year of production, comments, cover art and other data. The contents can be freely edited using software with ID3 tag editing functions. Although the tags are restricted to a number of characters, the information can be viewed when the track is played back.

▽ WMA tag

- WMA files can contain a WMA tag that is used in the same way as an ID3 tag. WMA tags carry information such as track title and artist name.

▽ ISO 9660 format

- This is the international standard for the formatting of CD-ROM folders and files. For the ISO 9660 format, there are 2 levels of regulations.
 - Level 1: The file name is in 8.3 format (8 character file names, with a 3 character file extension. File names must be composed of one-byte capital letters and numbers. The “_” symbol may also be included.)

- Level 2: The file name can have up to 31 characters (including the separation mark “.” and file extension). Each folder must contain fewer than 8 hierarchies.

▽ MP3

- MP3 is an audio compression standard determined by a working group (MPEG) of the ISO (International Standard Organization). MP3 compresses audio data to about 1/10 the size of that on conventional discs.

▽ WMA

- WMA (Windows Media Audio) is an audio compression format developed by Microsoft®. It compresses files into a size smaller than that of MP3 files. The decoding formats for WMA files are Ver. 7, 8 and 9.
- This product is protected by certain intellectual property rights of Microsoft Corporation and third parties. Use or distribution of such technology outside of this product is prohibited without a license from Microsoft or an authorized Microsoft subsidiary and third parties.

▽ AAC

- AAC is short for Advanced Audio Coding and refers to an audio compression technology standard used with MPEG2 and MPEG4.

▼ Error messages

Mode	Message	Explanation
CD	"Disc read error."	<ul style="list-style-type: none"> This indicates that no MP3/WMA/AAC files are included in the disc. This indicates that the disc is dirty, damaged, or it was inserted upside down. Clean the disc or insert it correctly. It indicates a disc which is not playable is inserted.
	"Please eject disc."	There is a trouble inside the system. Eject the disc.
USB	"Media not connected. Press AUDIO/TUNE knob to exit."	This indicates a problem in the USB memory or its connection. Refer to "Connecting and disconnecting a USB memory/portable device"  15.
	"No audio file."	This indicates that no MP3/WMA/AAC files are included in the USB memory.
	"Unplayable file"	This indicates that the accessed file cannot play back.
iPod	"Media not connected"	This indicates that a USB device/iPod is not connected to the system.
	"No audio file"	This indicates that there is no audio file in the connected iPod.
	"Unplayable file"	This indicates that the accessed file cannot play back.

NOTE

If the malfunction is not rectified: Take your vehicle to your SUBARU dealer.

Basic information before use



WARNING

When the vehicle is stopped with the engine running, always apply the parking brake for safety. Failure to do so may result in loss of control of your vehicle and cause an accident or serious injury.



CAUTION

- To prevent damaging the screen, touch the screen keys with your finger lightly.
- Wipe off fingerprints using a glass cleaning cloth. Do not use chemical cleaners to clean the screen, as they may damage the touch screen.

Touch screen gestures

Operations are performed by touching the touch screen directly with your finger.

Operation method	Outline	Main use
	Touch Quickly touch and release once.	Changing and selecting various settings
	Drag* Touch the screen with your finger, and move the screen to the desired position.	Scrolling the lists
	Flick* Quickly move the screen by flicking with your finger.	Scrolling the main screen page

*: The above operations may not be performed on all screens.

NOTE

There may be a delayed response to flick operation that are performed at high altitudes.

▼ Touch screen operation

This system is operated mainly by the keys on the screen.

When a screen key is touched, a beep sounds. You can set the beep sound. Refer to “Unit settings” 17.

NOTE

- If the system does not respond to touching a screen key, move your finger away from the screen and touch it again.
- Grayed-out screen keys cannot be operated.
- The displayed image may become darker and moving images may be slightly distorted when the screen is cold.
- In extremely cold conditions, the screen may not be displayed correctly. Also, the screen keys may be less responsive than usual when pressed.
- When you look at the screen through polarized material such as polarized sunglasses, the screen may be dark and difficult to see. If so, look at the screen from different angles, adjust the screen settings or take off your sunglasses. Refer to “Unit settings” 17.

▼ Entering letters and numbers/list screen operation

▽ Entering letters and numbers

When entering the Bluetooth device name or PIN-code, or the phone number, letters and numbers can be entered via the screen.

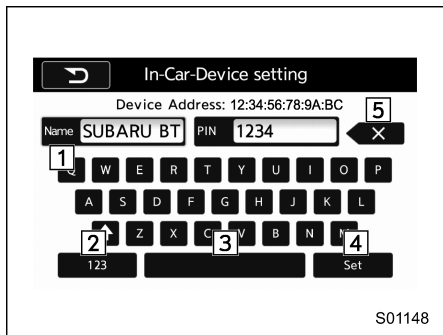

Enter letters (example: In-Car-Device setting)

No.	Function
1	Enter the desired characters (alphabet key mode).
2	Switch to the screen for characters.
3	Enter a space.
4	Confirm the characters/numbers entered into the window.

No.	Function
5	Delete a character/number entered into the window.

▽ List screen



Multimedia playlists (example: iPod playlist)

No.	Function
1	Select a category that wants to play back.
2	Return to the playback display of each mode.
3	Select to skip to the next or previous page.

▼ Initial screen

When the ignition switch is in the “ACC” or “ON” position, the initial screen will be displayed and the system will begin operating.



- When using the SUBARU STARLINK function (if equipped), the display screen may be different from the screen above.
- After a few seconds, the caution screen will be displayed.
- After about 5 seconds, the caution screen automatically switches to the next screen.

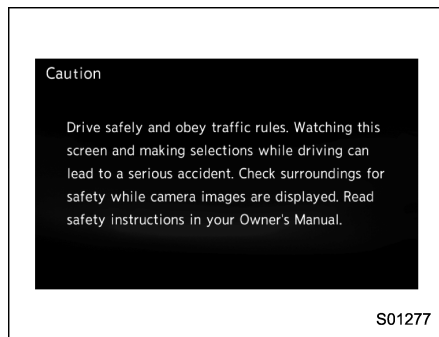

▼ Connecting and disconnecting a USB memory/portable device

The USB port and the AUX jack are located as shown in the following illustration.

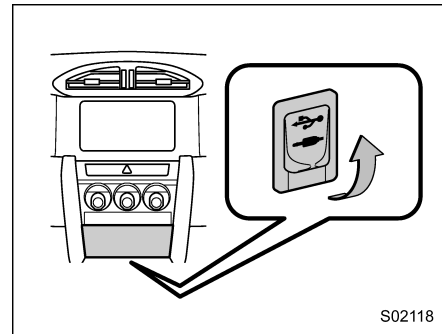

NOTE

- This unit does not support commercially available USB hubs.
- Turn on the power of the device when it is not turned on.
- This device has a USB port for USB memory/portable device.
- For compatible USB memory devices, refer to “USB memory device” 8.
- For compatible iPod models, refer to “iPod” 8.
- Even if a USB hub is used to connect more than two USB devices,

only the first two connected devices will be recognized.

Basic operation

This section describes some of the basic features of the audio/visual system. Some information may not pertain to your system.

Your audio/visual system works when the ignition switch is turned to the “ACC” or “ON” position.



CAUTION

To prevent the battery from being discharged, do not leave the audio/visual system on longer than necessary when the engine is not running.

NOTE

Some functions can also be operated by using the voice command system. For details, refer to “Voice command system” 80.

Turning the system on and off

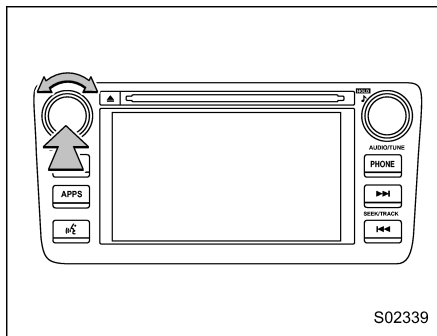

Press the power/VOLUME knob to turn the audio/visual system on and off. When the system turns on, the mode that was in use the last time the system was turned off will be displayed. Press and hold the knob to turn the display off.

Turn this knob to adjust the volume.

Selecting an audio source

1. Press the AUDIO/TUNE knob.

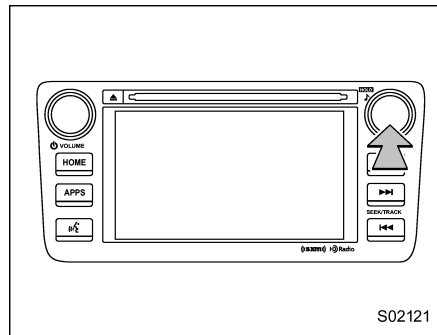

2. Select the desired source.

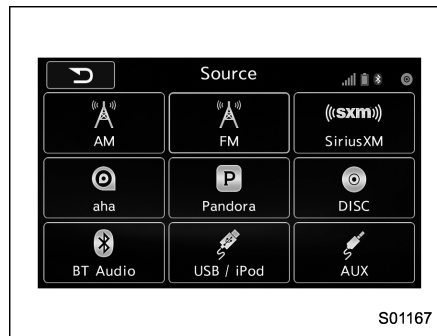

Example: Source select screen

NOTE

- If the audio control screen appears, select the “Source” key on the audio screen or press the AUDIO/TUNE knob again.
- When you push the AUDIO/TUNE knob while any screen other than the audio control screen is displayed, the display will return to the audio control screen.
- When the AUDIO/TUNE knob is pushed and held, the graphic equalizer screen will be displayed. Refer to “Graphic Equalizer” 21.

▼ Selecting a function menu

Press the HOME button to display home screen.

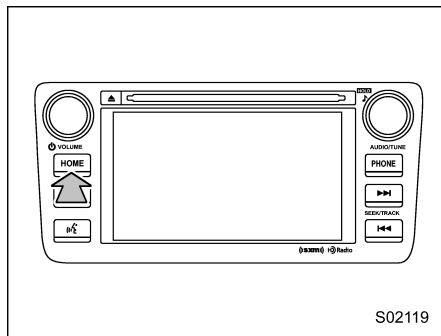

Item	Function
AUDIO	Select to display the main screen of the audio source that was selected previously.
PHONE	Select to display the hands-free function using your cell phone. Refer to “Hands-free phone system” 69.
APPS	Select to display the functions linked with a smartphone. Refer to “SUBARU STARLINK” 24.
SETTINGS	Select to display the functions for performing various settings. Refer to “Unit settings” 17.

■ Unit settings

Sound quality adjustment, screen adjustment, and information of the audio unit are displayed.

1. Press the HOME button on the audio panel.
2. Touch the “SETTINGS” key.
3. Select the items to be set.

Available setting:

- General settings: Select the tab to check the system software update information. Refer to “General settings” 18.
- Bluetooth settings: Select the tab to set the Bluetooth settings. Refer to “Bluetooth settings” 18.
- Sound settings: Select the tab to set

the sound quality settings. Refer to “Sound settings” 18.

- Display settings: Select the tab to set the screen settings. Refer to “Display settings” 23.
- SUBARU STARLINK settings (if equipped): Select to the tab set the SUBARU STARLINK settings. Refer to “SUBARU STARLINK settings” 24.

▼ General settings

Touch the  tab for the audio unit basic settings.

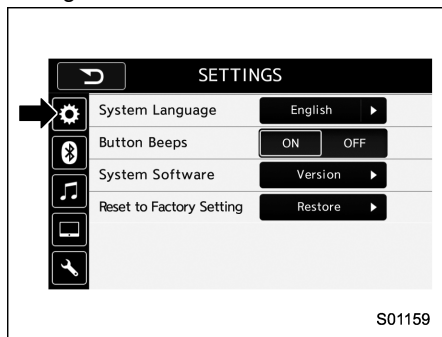

Item	Function
System Language	Select to change the language.
Button Beeps	Select to set the sound beeps on/off.
System Software	Select to update software versions. This menu is not used in usual operation.
Reset to Factory Setting	Select to reset the device to factory settings. This menu is not used in usual operation. After resetting to factory settings, turn ignition off and on again.

▼ Bluetooth settings

Touch the  tab to set Bluetooth.

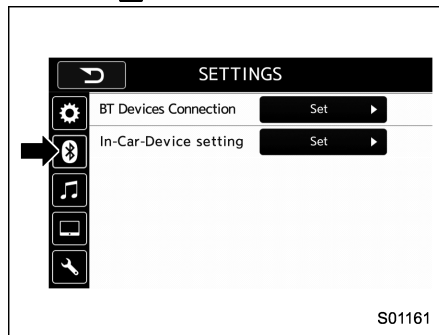

Item	Function
BT Devices Connection	Select to pair/connect the Bluetooth devices.
In-Car-Device setting	Select to enter the Bluetooth device name or PIN-code.

For details, refer to “Bluetooth® settings”  64.

▼ Sound settings

Touch the  tab to set the sound quality.

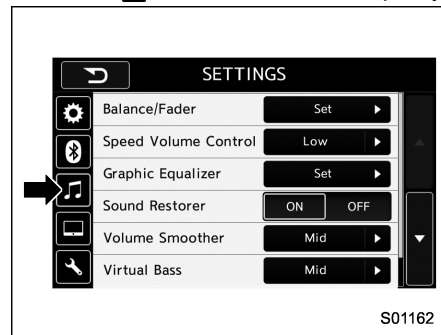

Item	Function
Balance/Fader	Select to adjust speaker volume balance (right/left and front/rear).
Speed Volume Control	Select to adjust speaker volume coupled to vehicle speed.
Graphic Equalizer	Select to adjust sound quality in each frequency band.
Sound Restorer	Select to add high-pitched tone to the compressed audio file.
Volume Smoother	Select to adjust volume difference between audio sources.
Virtual Bass	Select to add harmonic tone so that low-pitched tone is strengthened.

Item	Function
Vocal Image Control	Select to pick-up vocal sound signal from the sound data, and adjust it to right/left or front/rear.

Refer to the following table for the adjustment range of each audio setting item and default value.

Item		Step	Default
Balance/ Fader	Volume Balance Control	Balance	L9-R9
		Fader	F9-R9
	Vocal Image Control	Balance	L9-R9
		Fader	F9-R9
Speed Volume Control		OFF, Low, High	Low
Graphic Equalizer		-6-+6	0 (Flat)
Sound Restorer		ON, OFF	ON
Volume Smoother		OFF, Low, Mid, High	Mid
Virtual Bass		OFF, Low, Mid, High	Mid

▽ “Balance/Fader”

A good balance of the left and right stereo channels and of the front and rear sound levels is important for good quality audio program listening.

Keep in mind that when listening to a stereo recording or broadcast, changing the right/left balance will increase the volume of 1 group of sounds while decreasing the volume of another.

Touch the “Set” key of the “Balance/Fader” key. The “Balance/Fader” screen will appear.

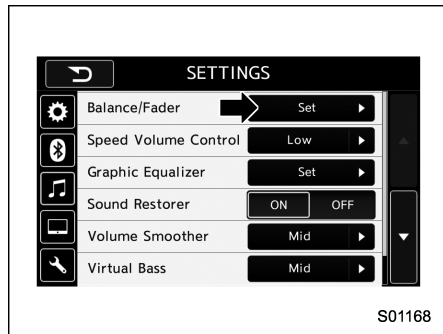

- Volume Balance setting
1. Select the “Volume Balance Control” key.

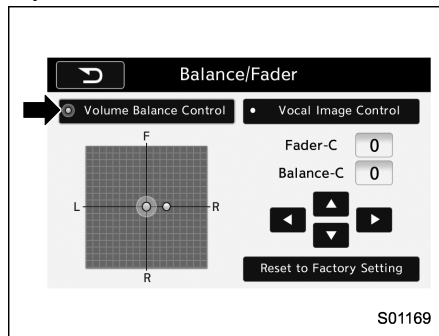

2. Adjust the balance by pressing “◀” or “▶” key.
3. Adjust the fader by pressing “▲” or “▼” key.

- Vocal image setting
1. Select the “Vocal Image Control” key.

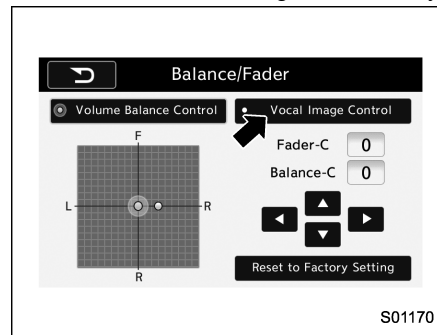

2. Adjust the balance by pressing “◀” or “▶” key.
3. Adjust the fader by pressing “▲” or “▼” key.

▽ “Speed Volume Control”

The system adjusts to the optimum volume and tone quality according to vehicle speed to compensate for increased vehicle noise.

1. Touch the right side key of the “Speed Volume Control” key.
2. Select the desired item. The “High” key comes to have a bigger effect. When the “OFF” key is selected, speed volume control function is cancelled.

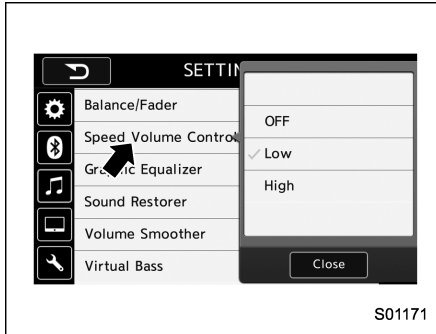

▽ “Graphic Equalizer”

You can adjust the sound quality by increasing/decreasing the gain for each frequency range.

1. Touch the “Set” key of the “Graphic Equalizer” key.

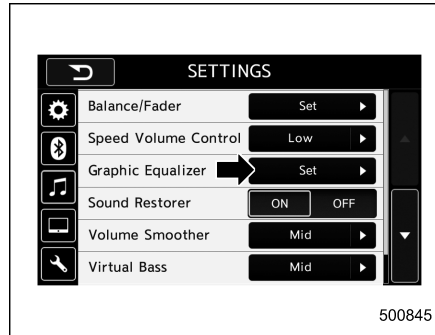

2. In this mode, 6 preset equalizer patterns (the “Bass”, “Treble”, “Acoustic”, “Impact”, “Smooth” and “Flat” key) and 3 customized patterns (the “SET 1” - “SET 3” key) are available.

3. When customizing the equalizer pattern, touch among “SET 1”, “SET 2” or “SET 3” and then touch the “Adjust” key.

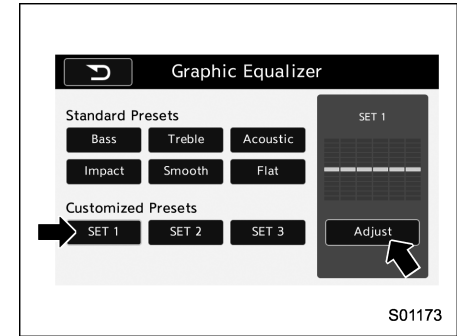

4. Adjust the level of each frequency band by touching “▲” or “▼” key.

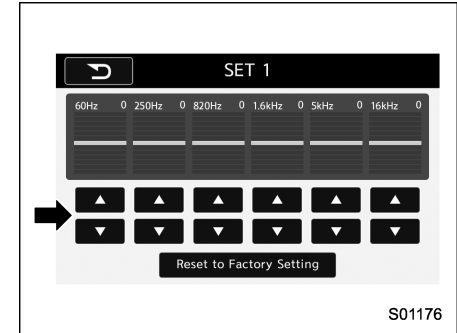

▽ “Sound Restorer”

You can play compressed audio data with a sound quality that is close to the original sound.

Select the “ON” or “OFF” key by the right side key of the “Sound Restorer” key.

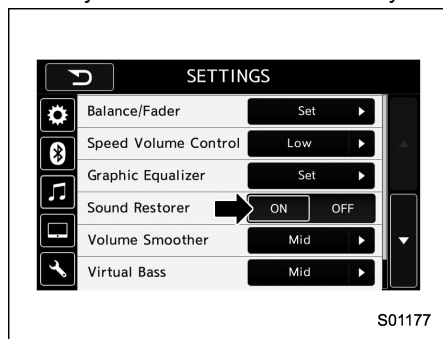

▽ “Volume Smoother”

This function reduces the difference in volume among the sound sources to be played.

1. Touch the right side key of the “Volume Smoother” key.
2. Select the “OFF”, “Low”, “Mid” or “High” key. The “High” key comes to have a bigger effect. When the “OFF” key is selected, the volume smoother function is cancelled.

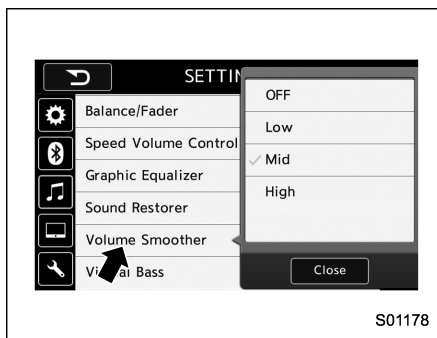

▽ “Virtual Bass”

This function enables you to adjust the bass tone.

1. Touch the right side key of the “Virtual Bass” key.
2. Select the “OFF”, “Low”, “Mid” or “High” key. The “High” key comes to have a bigger effect. When the “OFF” key is selected, the virtual bass function is cancelled.

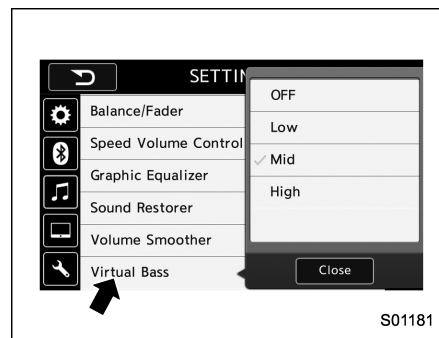

▽ “Vocal Image Control”

Refer to ““Balance/Fader”” 20.

▼ Display settings

Touch the  tab to set display.

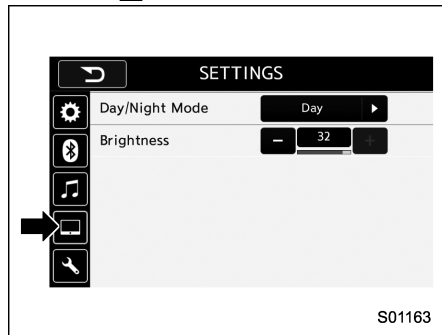

Item	Function
Day/Night Mode	The "Auto", "Day" or "Night" key can be selected on the pop-up screen. When the "Auto" key is selected, the screen changes to day or night mode depending on the position of the headlight switch.
Brightness	Touch "+" or "-" to adjust the brightness.

NOTE

- When the screen is viewed through polarized sunglasses, a rainbow pattern may appear on the screen due to optical characteristics of the screen. If this is disruptive, please operate the screen without polarized sunglasses.
- If the screen is set to "Day" mode with the headlight switch turned on, this condition is memorized even with the engine turned off.

▽ How to adjust the rear view image

In the camera display, the brightness, tint, color and black level of the screen can be adjusted.

1. Depress the brake pedal fully and stop the vehicle.
2. While the vehicle is stopped, set the shift lever (MT models) or select lever (CVT models) in the "R" position, and then touch the display.
3. Touch the "Display Adjustment" key.
4. Touch the items to adjust the rear camera screen.

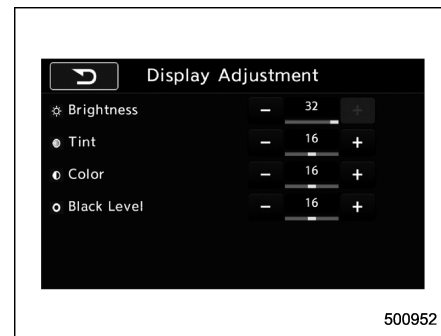

Camera display



WARNING

When adjusting camera display screen, make sure to depress the brake pedal fully to avoid the vehicle from moving. Failure to do so may lead to a serious accident.

NOTE

The camera display can be accessed when the rear camera monitor is displayed.

▼ SUBARU STARLINK settings (if equipped)

Touch the  tab to change the SUBARU STARLINK settings.

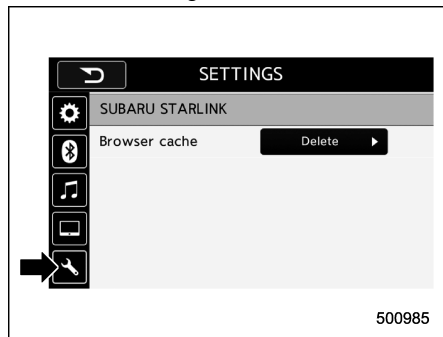

Item	Function
Browser cache	Select to initialize cache files that the browser stores. If the confirmation screen appears and the "OK" key is selected, the cache files will be deleted.

■ SUBARU STARLINK (if equipped)

The SUBARU STARLINK function allows the system to link with a smartphone using Bluetooth.

▼ How to use SUBARU STARLINK

1. Connect to the audio system. Use a USB port for an iPhone or iPod touch and Bluetooth for Android devices.

- For details about connecting an iPhone/iPod touch: Refer to "Connecting and disconnecting a USB memory/portable device" 6-15.
- For details about registering or connecting an Android device: Refer to "Registering/connecting Bluetooth® device" 6-64.

2. Press the HOME button, and then touch the "APPS" key, or press the APPS button on the audio panel. The APPS screen is displayed.

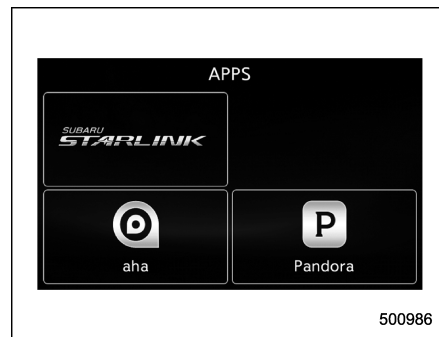

3. Touch the "SUBARU STARLINK" key on the APPS screen. The disclaimer screen or the error screen is displayed.

4. Touch the "Check" key on the disclaimer screen and then the APPS main screen will appear. If you touch the "Cancel" key, the disclaimer screen disappears and the previous screen will be displayed again.

NOTE

- The SUBARU STARLINK connection error screen will be displayed due to one of the following possible reasons.
 - Your smartphone and the system has not been connected via USB (for iPhone) or Bluetooth (for Android).
 - SUBARU STARLINK APPS has

not been activated.

- You can also switch to aha or Pandora (if equipped) from the APPS screen.

▼ APPS main screen

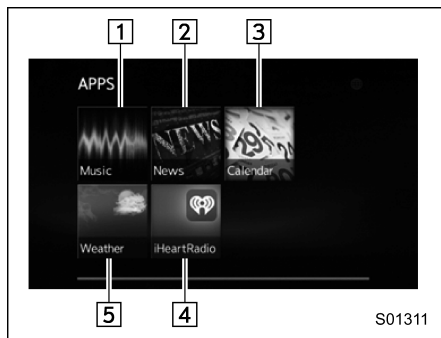

No.	Function
1	Select to go to the Music APPS screen.
2	Select to go to the News APPS screen.
3	Select to go to the Calendar APPS screen.
4	Select to go to the iHeartRadio APPS screen.
5	Select to go to the Weather APPS screen.

NOTE

- The error screen will be displayed while using SUBARU STARLINK due to one of the following possible reasons.
 - When your smartphone has no service or the Bluetooth communication is not possible.
 - When your smartphone is turned off.
 - When the SUBARU STARLINK APPS is quit.
 - When connection to the SUBARU STARLINK server is not possible.
 - When a problem occurs other than a server error.
- When using the SUBARU STARLINK function, a disclaimer screen will be displayed. Be sure to fully read the contents before using the function.
- Supported devices
 - iPhone: iPhone 4/iPhone 4s/iPhone 5 (iOS Ver. 5.1 or later)/iPhone 5c/iPhone 5s
 - Android: (OS Ver. 4.0 or later)

■ AM/FM radio

▼ Control screen and audio panel

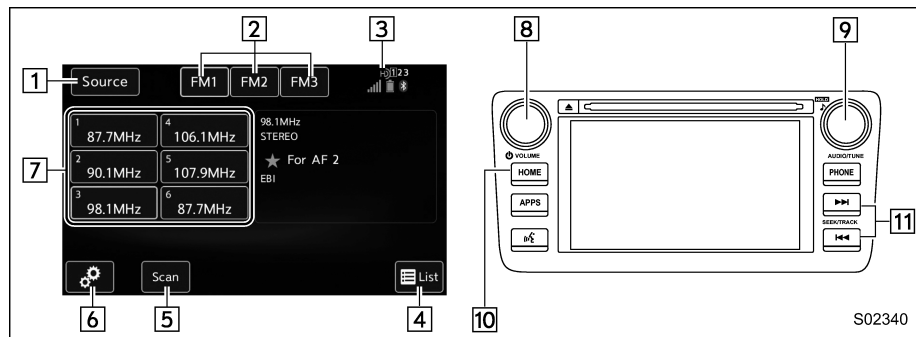

No.	Function
1	Select to display the audio source selection screen.
2	Select to change the band.
3	The HD Radio indicator on the top right of the screen changes according to the reception condition of HD Radio (if equipped).
4	Select to display a station list (if equipped). Refer to "Selecting a station from the list" 27.

No.	Function
5	Select to scan radio channels. This function enables searching for receivable stations automatically, and tunes in to a frequency for 5 seconds if a station is found. When the 5-second period has elapsed, the system searches for the next receivable station again, and tunes in to the frequency for 5 seconds.
6	Select to open the "Option" screen. Refer to "Radio settings" 28.
7	When you touch a key, the system tunes to the stored frequency. When you touch and hold a key, the system stores the frequency to the selected preset channel. Refer to "Presetting a station" 27.

No.	Function
8	Turn to adjust volume. Press to turn the audio system on/off.
9	Turn to step up/down frequencies. Turn to move up/down the list. Also, the knob can be used to enter selections on the list screens by pressing. Press to select an audio mode. For details, refer to "Selecting an audio source" 16.
10	Press to display the sound setting screen. Refer to "Unit settings" 17.
11	Press to seek for a station/channel. Press and hold for continuous seek.

NOTE

- Although FM is normally static free, reception can be affected by the surrounding area, atmospheric conditions, station strength and transmitter distance. Buildings or other obstructions may cause momentary static, flutter or station interference. If reception continues to be unsatisfactory, switch to a stronger station.
- The radio automatically changes to stereo reception when a stereo broadcast is received.

- The radio automatically blends to an HD Radio signal (if equipped) in AM or FM where available.

▼ How to change the source

Select the “AM” or “FM” key on the source select screen. Refer to “Selecting an audio source” 16.

▼ Presetting a station

In total 18 stations can be set for the FM band (6 each for FM1, FM2 and FM3) and 12 stations can be set for the AM band (6 each for AM1 and AM2).

1. Tune in the desired station.
2. If you touch and hold a key, the system stores the frequency to the selected preset channel.

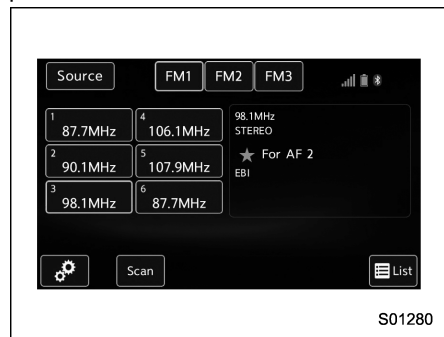

▼ Selecting a station from the list (if equipped)

A station list can be displayed.

1. Touch the List tab.

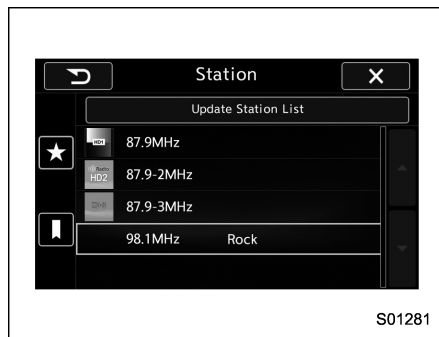

2. Touch the ★ tab and the station list will appear.
3. Select the desired station.

▼ Update the station list

Touch the “Update Station List” key on the station list screen and the following screen will be displayed.



Item	Function
OK	Select to execute the manual update.
Cancel	Select to cancel the manual update.

NOTE

- The audio system sound is muted during refresh operation.
- In some situations, it may take some time to update the station list.

▼ Bookmark the list

You can store and call up the received data (images, song titles, artist names, etc.). The stored data is displayed as a list.

1. Touch the tab on the station list screen and the following screen will be

displayed.

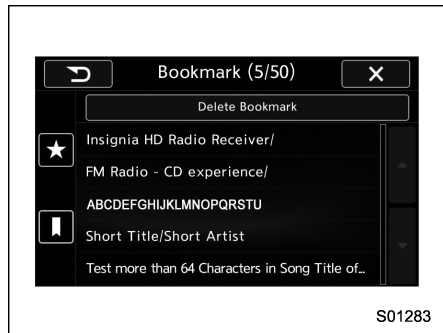

2. Select an item from the bookmark list, the following image will be displayed.

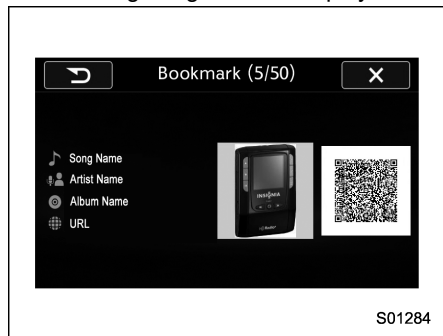

3. When you call up bookmark information, a QR code converted from the bookmark information will be displayed

on the screen. You can access a URL by reading the QR code using a smartphone, etc.

▼ Delete bookmark from the list

1. Touch the “Delete Bookmark” key on the station list screen and the following screen will be displayed.

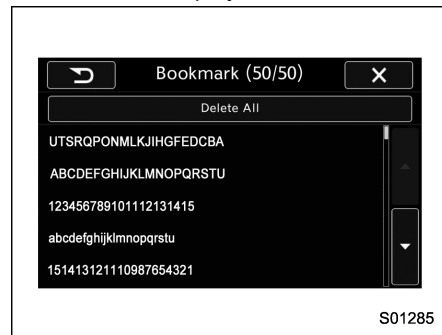

2. If you select an item from the bookmark list, the item will be deleted from the bookmark list.

3. Touch the “Delete All” key. If the confirmation screen appears and the “OK” key is selected, all bookmark items in the list will be deleted.

▼ Radio settings

You can perform various radio settings.

1. Touch the tab.
2. Select the desired item from the following table.

Item	Function
HD (if equipped)	Select to turn HD radio on/off.
PTY Select (if equipped)	Select to set the PTY group.
Auto Store	Select to detect 6 radio stations with strong frequencies automatically and to store them in the order of frequency.

▼ About HD Radio™ technology (if equipped)

HD Radio™ Technology is the digital evolution of analog AM/FM radio. Your radio product has a special receiver which allows it to receive digital broadcasts (where available) in addition to the analog broadcasts it already receives. Digital broadcasts have better sound quality than analog broadcasts as digital broadcasts provide free, crystal clear audio with no static or distortion. For more information, and a guide to available radio stations and programming, refer to <https://hdradio.com>.

Digital Sound

AM and FM broadcast sound quality is now crystal clear, with AM sound quality that virtually matches FM quality of the past, and FM broadcasts that have near CD-level sound quality.

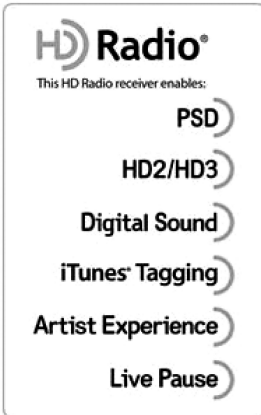

HD Radio Technology manufactured under license from iBiquity Digital Corporation. U.S. and Foreign Patents. For patents see <http://dts.com/patents>. HD Radio and the HD, HD Radio, and "ARC" logos are registered trademarks or trademarks of iBiquity Digital Corporation in the United

States and/or other countries.

HD2/HD3

FM stations can provide additional digital-only audio programming on HD2/HD3 Channels.

▼ Available HD Radio™ technology (if equipped)

▽ Multicast

On the FM radio frequency most digital stations have "multiple" or supplemental programs on one FM station.

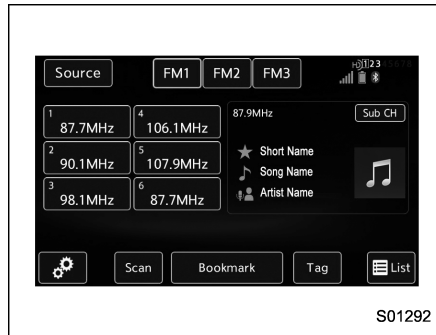

1. Touch the "Sub CH" key on the control screen and the following screen will be displayed.

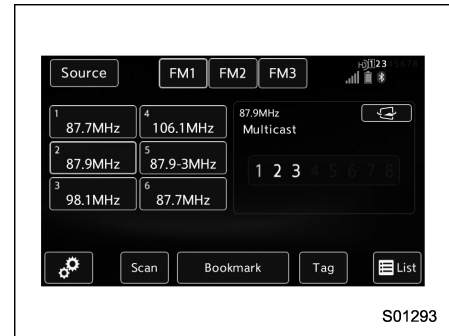

2. The indication that shows whether the current broadcast is digital or analog is displayed on the top right of the control screen.

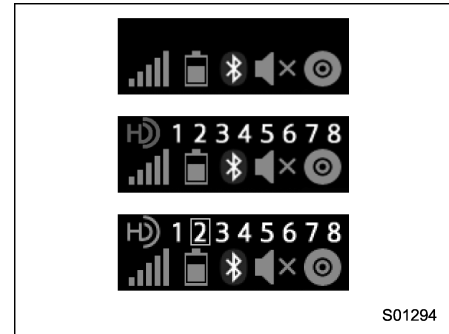

3. Select the desired channel. Turning the AUDIO/TUNE knob can also

select the desired multicast channel.

NOTE

- HD Radio™ stations can be preset.
- An orange  will be displayed on the screen when in digital. The  will first appear in a gray color indicating the station is indeed (an analog and) a digital station. Once the digital signal is acquired, the logo will change to a bright orange color.
- The song title and artist name will appear on the screen when available by the radio station. The radio station can send album pictures when available.
- As a user works through the analog radio stations, (where applicable) the radio receiver will automatically tune from an analog signal to a digital signal within 5 seconds.

▽ Preserving a music information

Tag information in the music broadcasting is preserved in the system and transmits to an iPod.

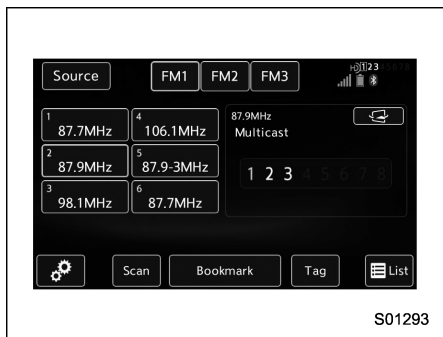

1. Touch the “Tag” key in the control screen while receiving HD Radio, the tag setting screen will be displayed.

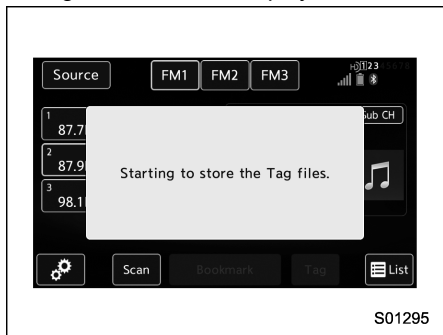

2. Connect an iPod. Refer to “Connecting and disconnecting a USB memory/portable device”  15.

- Turn on the power of the iPod if it is not turned on.
- Once an iPod is connected, the music tag moves from the radio into the iPod.
- When the iPod is connected to iTunes, the tagged information of the songs which were tagged while listening to the radio can be viewed. Then a user may decide to purchase the song or CD/Album which had been listened to on their radio.

In addition, the following messages appear.

Display Message	Contents
"Tag storage full"	If there is not enough memory in the digital audio
"Already Stored"	If the same information is stored in the digital audio
"Storing Failed"	If the store process in the digital audio failed
"iPod full Tags cannot be stored"	If there is not enough memory in the iPod
"Starting to transfer the Tag files."	If the system starts to transmit music information to an iPod
"Transferring Failed"	If the transmitting process of music information to an iPod failed
"X Tag(s) Sent" (X = number of transmitted information) will be displayed.	If the transmitting process of music information to an iPod is successful

NOTE

- The tag information can not be preserved while scanning or caching the radio station.
- If tagging the music information fails, "Saving the HD Radio tag was unsuccessful. (Saving the HD Radio tag was unsuccessful.)" will be displayed on the screen. If this occurs, tag the information again.



- Program Service Data: Presents song name, artist, station IDs, and other relevant data streams.



- iTunes Tagging provides you the opportunity to discover a wide range of content and the means to "tag" that content for later review and purchase from the iTunes Store. Also refer to the Apple Automotive specifications for implementing iTunes Tagging.

Artist Experience)

- Visual information related to content being played on your HD Radio receiver, such as Album Art, historical photographs, still art from live broadcasts, among other related content.

▽ Troubleshooting guide

Experience	Cause	Action
Mismatch of time alignment - a user may hear a short period of programming replayed or an echo, stutter or skip.	The radio stations analog and digital volume is not properly aligned or the station is in ballgame mode.	None, radio broadcast issue. A user can contact the radio station.
Sound fades, blending in and out.	Radio is shifting between analog and digital audio.	Reception issue. May clear-up as the vehicle continues to be driven. Turning the indicator of the HD Radio™ off will change the radio mode to analog audio.
Audio mute condition when an HD2/HD3 multicast channel had been playing.	The radio does not have access to digital signals at the moment.	This is normal behavior, wait until the digital signal returns. If out of the coverage area, seek a new station.
Audio mute delay when selecting an HD2/HD3 multicast channel preset.	The digital multicast content is not available until HD Radio™ broadcast can be decoded and make the audio available. This takes up to 7 seconds.	This is normal behavior, wait for the audio to become available.
Text information does not match the present song audio.	Data service issue by the radio broadcaster.	Broadcaster should be notified. Complete the form; www.ibiquity.com/automotive/report_radio_station_experiences .
No text information shown for the present selected frequency.	Data service issue by the radio broadcaster.	Broadcaster should be notified. Complete the form; www.ibiquity.com/automotive/report_radio_station_experiences .
The “Acquiring” caution message appears when the system attempts to acquire digital transmission.	When acquiring digital data while receiving a digital broadcast and SPS station.	<ul style="list-style-type: none"> • When the reception in digital of the SPS station is confirmed. • When the system determined that the SPS station could not be received. • When the SPS broadcast is ended (stopped) by the radio station while receiving SPS.

Experience	Cause	Action
The "HD Channel is unavailable" caution message appears when digital reception is not possible.	<ul style="list-style-type: none">• When the system determined that the SPS station could not be received while receiving a digital broadcast and SPS station.• When the SPS broadcast is ended (stopped) by the radio station while receiving SPS.	<ul style="list-style-type: none">• When the status is changed to acquiring digital data because the reception condition of SPS station has improved.• When the received station is changed.

■ SiriusXM Satellite Radio (if equipped)

▼ SiriusXM Data Service

Data service information, which is comprised of traffic information and weather information, can be received via the SiriusXM Radio.

To receive the data service information in the vehicle, a subscription to the SiriusXM Satellite Radio service is necessary.

Content set to use the SiriusXM data service is reset when personal information is initialized.

▼ Control screen and audio panel

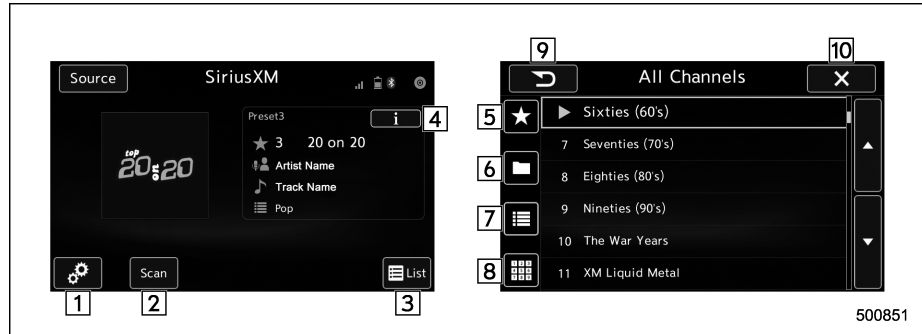

Control screen

No.	Function
1	Perform the SXM setting. See below. Refer to "SXM setting" 41.
2	Search for a channel which the direction of higher frequency from current frequency. Reproduce the channel that can receive by 5 seconds.

No.	Function
3	A list is displayed. There are three types of lists ("Presets", "Categories" or "All Channels") available. <ul style="list-style-type: none"> • "Presets": Preset channels are displayed in a list. • "Categories": The channels of the selected category are displayed in a list. • "All Channels": All selectable channels are displayed in a list.
4	Display the contents information of a channel receiving.
5	Presets list (30 channels max.) is displayed. Refer to "Presetting a channel" 39.

No.	Function
6	Categories list is displayed. Refer to "Selecting a channel from the list" 39.
7	All channels list is displayed. The available received channels are displayed, and you can select a channel.
8	Change to the Direct Tune display. Refer to "Direct Tune" 40.
9	Return to the previous display.
10	Return to the playback display.

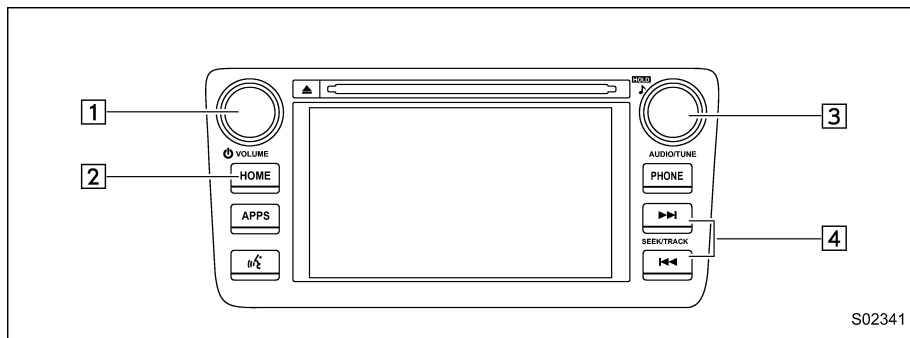

Audio panel

No.	Function
1	Turn to adjust volume. Press to turn the audio system on/off.
2	Press to display the sound setting screen. Refer to "Unit settings" 17.
3	Turn right to step up channels and turn left to step down channels. Press to select an audio source. Refer to "Selecting an audio source" 16.
4	Press to step up/down channels. Press and hold to step up/down channels fast.

▼ How to subscribe to SiriusXM Satellite Radio

To listen to a satellite radio broadcast in the vehicle, a subscription to the SiriusXM Satellite Radio service is necessary.

A SiriusXM Satellite Radio is a tuner designed exclusively to receive broadcasts provided under a separate subscription.

▽ How to subscribe

It is necessary to enter into a separate service agreement with SiriusXM Satellite Radio in order to receive satellite broadcast programming in the vehicle. Additional activation and service subscription fees apply that are not included in the purchase price of the vehicle and digital satellite tuner.

For complete information on subscription rates and terms, or to subscribe to SiriusXM Satellite Radio:

- U.S. customers:

Refer to www.siriusxm.com or call 1-866-635-2349

- Canadian customers:

Refer to www.siriusxm.ca or call 1-888-539-7474



WARNING

- **SiriusXM Satellite Radio Services — Legal Disclaimers and Warnings**
 - **Fees and Taxes — Subscription fee, taxes, one time activation fee, and other fees may apply. Subscription fee is consumer only. All fees and programming subject to change. Subscriptions subject to Customer Agreement available at www.siriusxm.com (U.S.) or www.siriusxm.ca (Canada). SiriusXM U.S. satellite and data services are available only in the contiguous USA and DC. SiriusXM satellite service is also available in Canada: see www.siriusxm.ca.**
- **Explicit Language Notice — Channels with frequent explicit language are indicated with an “XL” preceding the channel name. Channel blocking is available for SiriusXM Satellite Radio receivers by notifying SiriusXM at:**

- **U.S. customers:**

Visit www.siriusxm.com or call 1-866-635-2349

- **Canadian customers:**

Visit www.siriusxm.ca or call 1-888-539-7474



CAUTION

- **It is prohibited to copy, decompile, disassemble, reverse engineer, hack, manipulate or otherwise make available any technology or software incorporated in receivers compatible with the SiriusXM Satellite Radio System or that support the XM website, the Online Service or any of its content. Furthermore, the AMBE® voice compression software included in this product is protected by intellectual property rights including patent rights, copyrights, and trade secrets of Digital Voice Systems, Inc.**
- **Note: this applies to SiriusXM Satellite Radio receivers only and not XM Ready devices.**

NOTE

- **SiriusXM Satellite Services — Descriptions**

- Only SiriusXM Satellite Radio® brings you more of what you love, all in one place. Get over 175 channels, including commercial-free music, plus the best sports, news, talk, comedy and entertainment. Welcome to the world of satellite radio. More information about SiriusXM Satellite Radio is available online at www.siriusxm.com (U.S.) and www.siriusxm.ca (Canada).

- **SiriusXM Satellite Services — Subscription Instructions**

- For SiriusXM Services requiring a subscription (such as SiriusXM Satellite Radio, and some Infotainment & data services), the following paragraph shall be included.

Required SiriusXM Satellite Radio and some Infotainment & data services monthly subscriptions sold separately after trial period. Subscription fee is consumer only. All fees and programming subject to change. Subscriptions are subject to the Customer Agreement available at www.siriusxm.com (U.S.) or www.siriusxm.ca (Canada). Sirius,

XM and all related marks and logos are trademarks of Sirius XM Radio Inc. All other marks, channel names and logos are the property of their respective owners.

For more information, program schedules, and to subscribe or extend subscription after complimentary trial period; more information is available at:

- **U.S. customers:**

Visit www.siriusxm.com or call 1-866-635-2349

- **Canadian customers:**

Visit www.siriusxm.ca or call 1-888-539-7474

- SiriusXM Satellite Radio is solely responsible for the quality, availability and content of the satellite radio services provided, which are subject to the terms and conditions of the SiriusXM Satellite Radio customer service agreement.



- Customers should have their radio ID ready; the radio ID can be found by tuning to “Ch 000” on the radio. For details, see “DISPLAYING THE RADIO ID” below.

- All fees and programming are the responsibility of SiriusXM Satellite Radio and are subject to change.

- ▼ **How to change the source**

Select the “Sirius XM” key on the source select screen. Refer to “Selecting an audio source”  16.

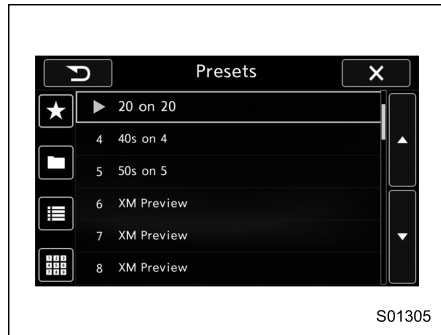

▼ Presetting a channel

- The presets list is displayed via either of the following procedures.
 - When you touch the  List tab in the SiriusXM main screen (if the list that was displayed the last time is Presets).
 - When you select the  tab in each list screen.
- The current channel is stored if you touch and hold the preset list key. You can store up to 30 channels (A beep sounds when a channel stored).



The playing icon is displayed for the currently selected channel.

▼ Selecting a channel from the list

- The categories list is displayed via either of the following procedures.
 - When you touch the  List tab in the SiriusXM main screen (if the list that was displayed the last time is Categories).
 - When you select the  tab in each list screen.
- Each channel list is displayed when you select each category item.

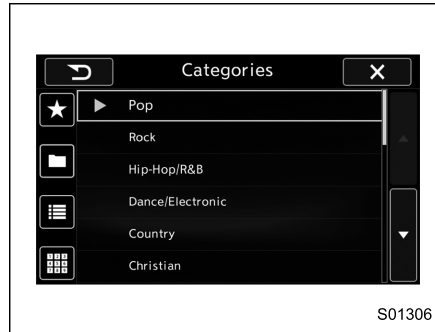

In addition, the following messages appear.

Display Message	Contents
"Subscription Update" "Press OK to Continue"	An update to your SiriusXM subscription has been received by the SiriusXM tuner. Touch any key to continue.
"Channel XXX Not Available" ("XXX" refers to the selected channel number.)	This channel is not a valid SiriusXM channel. The channel number has been entered incorrectly, or the channel was removed from the SiriusXM channel lineup.
"Channel XXX Not Subscribed Call." "Call SiriusXM to Subscribed." ("XXX" refers to the selected channel number.)	This channel is not included in your SiriusXM subscription plan.
"Ch Locked" "Lock Code?"	The selected channel has been locked by the parental controls. A prompt to enter the unlock code will appear.
"Check Antenna"	Ensure the SiriusXM antenna cable is connected to the SiriusXM tuner correctly. Check the SiriusXM antenna wire for breaks or sharp bends. Replace the antenna if necessary.
"No Signal"	The vehicle must be outside, and the antenna must have a clear view of the southern sky.

NOTE

Contact SiriusXM

- **Listener Care Center (U.S. customers):**
1-866-635-2349
- **Listener Care Centre (Canadian customers):**
1-888-539-7474

▼ Direct Tune

1. A channel input screen is displayed when you touch the  tab.

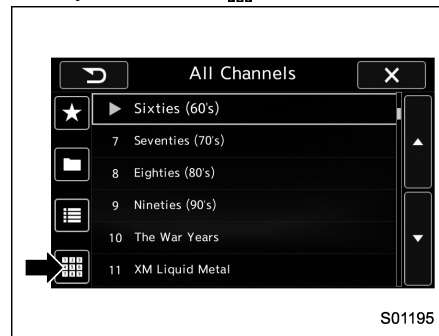

2. Input any number and touch the "OK" key, receive the channel which input.

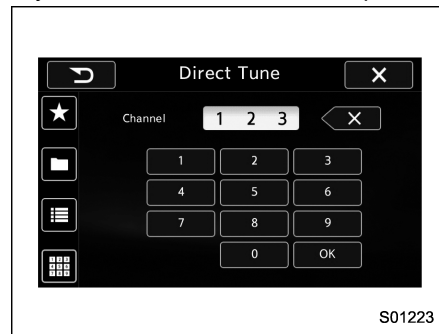

▼ SXM setting

1. An option menu screen is displayed when you touch the  tab on the lower left side of the screen. The “Options” screen will appear.

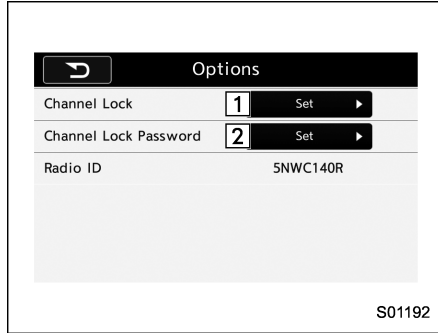

Option menu screen

No.	Function
1	Set the lock function of each channel. Input the password is necessary for operation.
2	Set the password of the lock function.

2. A password input screen is displayed when you touch the “Set” of the Channel Lock function.

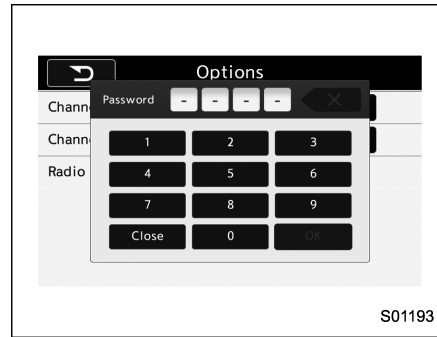

Password input screen

3. When the input password is approved, change to the lock channel selection screen.

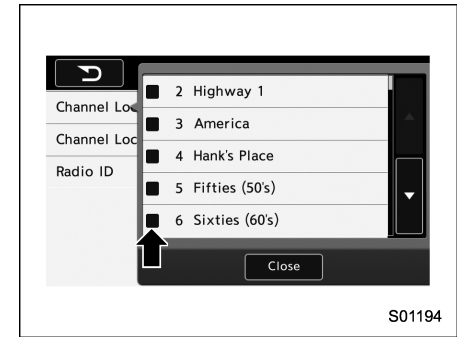

Lock channel selection screen

4. In the channel list, touch the channel that should be locked.

▼ Displaying the Radio ID

Each SiriusXM tuner is identified with a unique radio ID. The “Radio ID” is required when activating an SiriusXM Satellite Services or when reporting a problem.

- If “Ch 000” is selected using the AUDIO/TUNE knob, the ID code will be displayed.
- Touch the  key. The Radio ID will be displayed on the “Options” screen.

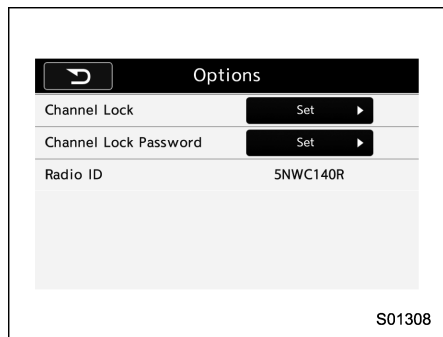

■ aha™ by HARMAN

aha is a cloud-based application that connects to the system and gives you access to your favorite web content safely and easily. There are over 30,000 stations spanning internet radio, personalized music, audiobooks, Facebook, Twitter, restaurant and hotel searches, weather and more. For more about aha, go to the aha site (<http://www.aharadio.com>).

When connecting iPhone and iPod touch or Android devices with the aha application installed, you can control, view, and hear aha content through the system.

In order to connect to this system, use a USB port for an iPhone or iPod touch and Bluetooth for Android devices.

In this chapter, iPhone and iPod touch or Android devices will be referred to as a smartphone.



WARNING

Do not connect or operate the smartphone while driving. Doing so may result in loss of control of your vehicle and cause an accident or serious injury.



CAUTION

- **Do not leave your smartphone in the car. In particular, high temperatures inside the vehicle may damage the smartphone.**
- **Do not push down on or apply unnecessary pressure to the smartphone while it is connected as this may damage the smartphone or its terminal.**
- **Do not insert foreign objects into the port as this may damage the smartphone or its terminal.**

▼ Control screen and panel

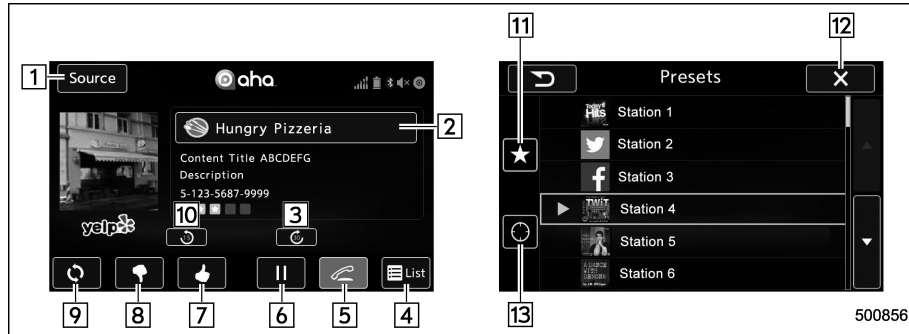

Control screen (main screen and station screen)

No.	Function
1	Select to display the audio source selection screen.
2	Select to open the station list. Refer to "Using aha application" 47.
3	Select to fast forward the current content item by 30 seconds.
4	Select to display the contents list of the selected station.
5	Select to make a phone call to the current content item. A phone number is distributed depending on content items. This feature is available only in these cases.

No.	Function
6	The track pauses when pressed during playback and plays back when touched during pause.
7	Select to set thumbs up.
8	Select to set thumbs down.
9	Select to start the playback from the beginning of the content in the target station.
10	Select to rewind the current content item by 15 seconds.
11	Select to display the preset list.
12	Return to the control screen.

No.	Function
13	Select to display the nearby list.

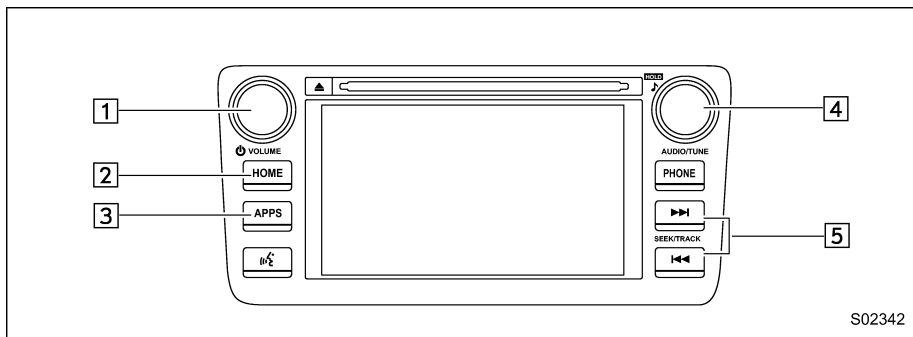

Audio panel

No.	Function
1	Turn to adjust volume. Press to turn the audio system on/off.
2	Press to display the sound setting screen. Refer to "Unit settings" 17.
3	Press to display the station operation screen. Press to select an audio mode.
4	Turn to display the next/previous content item. Press to select an audio source. Refer to "Selecting an audio source" 16.
5	Press to display the next/previous content item.

NOTE

- For safety reasons, certain functions are not available while your vehicle is in motion.
- In order to maximize signal reception, performance and precision of the smartphone, please ensure the smartphone is placed as close to the system as possible, while ensuring it is stowed and secure while driving.
- When the ignition switch is in the "ACC" or "ON" position, the battery of the connected iPhone/iPod touch is charged.
- iPhone/iPod touch may not be recognized when the ignition switch is in the "ACC" or "ON" position. In this case, remove the iPhone/iPod touch and reconnect it.
- The accuracy of the displayed information or the signal reception performance depends on the smartphone or the connected device, and it's wireless connection.
- Since the aha application uses signals from GPS satellites and wireless communication lines, it may not work properly in the following locations.
 - In a tunnel
 - In underground parking lots

- Outside wireless communication range, such as some countryside areas
- Where the wireless communication network is congested, or where communications are restricted
- Depending on the circumstances and environment, the signal may be weak or not be received. In such cases, an error may occur.
- Top 35 entries in the preset station list on the smartphone are displayed. When there are more than 35 entries in the preset station list, change the order of the entries in the list on the smartphone. You can change the priority of your preset stations within the aha application (after disconnected from this system) to modify the station list shown on the screen. Please see your smartphone aha application “Edit Presets (in Main menu)” to modify this list.
- For operating the smartphone, see the instruction manual that comes with it.
- If there are multiple music files stored on your iPhone or iPod touch, it may take some time until playback starts.
- Playback may be intermittent when you switch to streaming Bluetooth audio from aha on your smartphone

device.

- When connecting the device via Bluetooth, the communication speed may become slower than via USB.

▼ Before using aha application

In order to use the aha application on this system, the application must be installed on the smartphone.

▽ Settings required to use aha application

- Search and download the aha application from your smartphone app store.
 - iPhone and iPod touch: Apple App Store via iTunes
 - Android device: Google Play Store
- Create an account and login to the aha application on the smartphone.

NOTE

Please use the latest version of the aha application.

▽ About app-based connected content

Requirements for using the connected content services of the aha application on this system.

- Latest version of the system is compatible with connected content application(s) for the smartphone, available from aha,

downloaded to your smartphone.

- A current account with a wireless content service provider.
- A smartphone data plan: If the data plan for your smartphone does not provide for unlimited data usage, additional charges from your carrier may apply for accessing app-based connected content via 3G, 4G, Wi-Fi or 4G LTE wireless networks.
- Connection to the internet via 3G, 4G, Wi-Fi or 4G LTE networks.

NOTE

- Changes to product specifications may result in differences between the content of the manual and features of the product.
- Be careful not to exceed the data usage limits for your smartphone. Doing so will result in additional data usage charges from your phone carrier.
- Access to app-based connected content will depend on the availability of wireless cell and/or Wi-Fi network coverage for the purpose of allowing your smartphone to connect to the internet.
- Service availability may be geographically limited by region. Consult the wireless connected content service

provider for additional information.

- Ability of this product to access connected content is subject to change without notice and could be affected by any of the following: compatibility issues with future firmware versions of the smartphone; compatibility issues with future versions of the connected content application(s) for the smartphone; changes to or discontinuation of the connected content application(s) or service by its provider.

- Communication and phone call charges for smartphones should be paid by the wireless subscriber.

- If you lose the data in a smartphone or other device while using it with the system, no compensation will be given for the lost data.

- SUBARU CORPORATION makes no guarantee regarding the content provided by aha.

- aha may not work due to factors on smartphones, smartphone applications or stations. SUBARU CORPORATION is not responsible for it.

▽ About the supported devices

This system supports the following devices.

- For iPhone/iPod touch users

Type	Generation	Firmware version or OS
iPhone	iPhone 3G	iOS 4.2.x
	iPhone 3GS	iOS 6.1.x
	iPhone 4	iOS 7.0.x
	iPhone 4s	iOS 7.0.x
	iPhone 5	iOS 7.0.x
	iPhone 5c	iOS 7.0.x
	iPhone 5s	iOS 7.0.x
iPod touch	iPod touch	iOS 3.1.x
	iPod touch 2	iOS 4.2.x
	iPod touch 3	iOS 5.1.x
	iPod touch 4	iOS 6.1.x
	iPod touch 5	iOS 7.0.x

NOTE

Note that the warranty does not apply if an unsupported iPhone/iPod touch is connected.

- For Android device users

Android OS	Specification	Profile
Android Ver. 2.2 or Ver. 2.3	Bluetooth Specification Ver. 1.1 or higher (Ver. 2.0 + EDR or higher is recommended)	<ul style="list-style-type: none"> ● aha Connect Binary API over SPP ● Digital audio by A2DP

NOTE

The available functions may vary depending on the type of Android device.

▼ Connecting a smartphone

If you connect a smartphone to this system after starting a supported aha application on the smartphone, you can display and operate the aha application displayed on the smartphone on the system screen.

1. Run the aha application on your smartphone.
2. Connect the iPhone/iPod touch to the USB port or connect the Android device by utilizing the Bluetooth connection (SPP and A2DP profile).

- For details about connecting an iPhone/iPod touch: Refer to “Connecting and disconnecting a USB memory/portable device” 15.
- For details about registering or con-

necting an Android device: Refer to “Registering/connecting Bluetooth® device” 64.

NOTE

When iPhone/iPod touch and Android devices are connected at the same time, iPhone/iPod touch is prioritized.

▼ How to change the source

- Select the “aha” key on the source select screen. Refer to “Basic operation” 16.
- Select the “aha” key on the APPS screen. Refer to “SUBARU STARLINK” 24.

NOTE

When starting-up “aha”, there are some smartphone models for which “aha” application does not start up automatically.

▼ Using aha application

1. When the top screen is displayed, touch the station key.



Example of the main screen

2. Select the desired station from the list. The selected station is displayed.

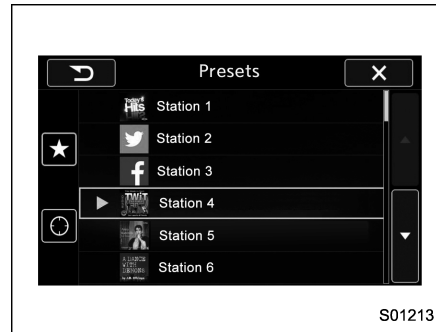

NOTE

- The following operations are not available on this system. Perform these operations on the smartphone.
 - Add/Reorder/Delete stations
 - Login to Facebook/Twitter
- For the aha function, the following touch screen gestures are not available.
 - Multi-touch operation
 - Double-tap
- For details on the services or the operations, check the aha site (<http://www.aharadio.com>) on the internet.
- The button display will vary depending on each station or content item.

■ Pandora® (if equipped)

Pandora is an application for a smartphone. This can automatically select and play recommended tracks.

By rating the track currently playing, tracks that better match your preference will be recommended.

In order to connect to this system, use a USB port for an iPhone or iPod touch and Bluetooth for Android devices.

Depending on differences between models or software version etc., some models might be incompatible with this system.

This function is not available if the Pandora application has not been installed on the smartphone.



WARNING

Do not operate the player's controls or connect the smartphone while driving. Doing so may result in loss of control of your vehicle and cause an accident or serious injury.



CAUTION

- **Do not leave your smartphone in the car. In particular, high temperatures inside the vehicle may damage the smartphone.**
- **Do not push down on or apply unnecessary pressure to the smartphone while it is connected as this may damage the smartphone or its terminal.**
- **Do not insert foreign objects into the port as this may damage the smartphone or its terminal.**

NOTE

Follow the specific operation procedures for the smartphone application.

▼ Control screen and audio panel

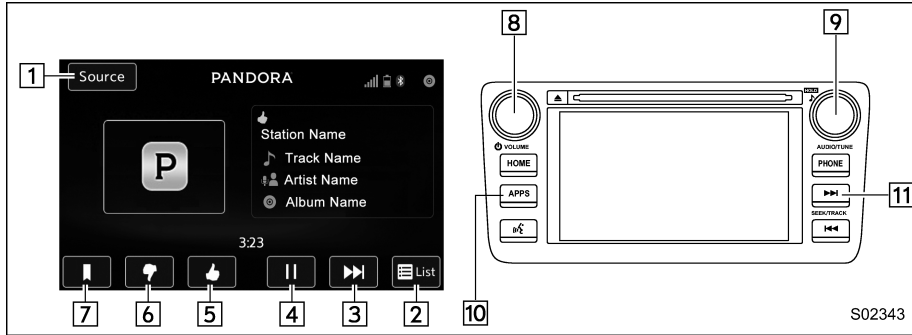

No.	Function
1	Select to display the audio source selection screen.
2	Select to open the station list. Refer to "Station list" 450.
3	Select to skip the current track.
4	The track pauses when touched during playback and plays when touched during pause.
5	Select to set thumbs up. This gives a high rating to the current song. All other similar songs will be played back more frequently.

No.	Function
6	Select to set thumbs down. This gives a low rating to the current song. All other similar songs will be played back less frequently. When you select thumbs down, the current track is skipped.
7	During playback of a station, you can use this key to bookmark a song or artist. Refer to "Registering Bookmarks" 450.
8	Turn to adjust volume. Press to turn the audio system on/off.
9	Turn clockwise to skip to the next track. Press to select an audio source. Refer to "Selecting an audio source" 416.
10	Press to display the sound setting screen. Refer to "Unit settings" 417.

No.	Function
11	Press to skip to the next track/cover art.

▼ Connecting a smartphone

Connect the iPhone/iPod touch to the USB port or connect the Android device by using Bluetooth connection (SPP and A2DP profile).

- For details about connecting an iPhone/iPod touch: Refer to "Connecting and disconnecting a USB memory/portable device" 415.
- For details about registering or connecting an Android device: Refer to "Registering/connecting Bluetooth® device" 464.

▼ How to change the source

The Pandora operation screen can be reached by the following methods:

- Connecting a Pandora device. Refer to "Connecting a Bluetooth device" 467 or "Connecting and disconnecting a USB memory/portable device" 415.
- Select the "Pandora" key on the source select screen. Refer to "Selecting an audio source" 416.
- Select the "Pandora" key on the APPS screen. Refer to "SUBARU STARLINK" 424.

NOTE

When starting-up Pandora, there are some smartphone models for which Pandora application does not start up automatically.

▼ Registering Bookmarks

You can register the music and artist now being played in Bookmark.

1. Touch the  tab.
2. Select the desired key. The following items are appeared on the screen.

Item	Function
Track	When selected after the Bookmark key is pressed, the current track is bookmarked.
Artist	When selected after the Bookmark key is pressed, the current artist is bookmarked.
Cancel	Select to cancel the bookmark operation.

▼ Station list

You can select, add or delete a station. When the  List tab is touched on the main screen, a station list will be displayed.

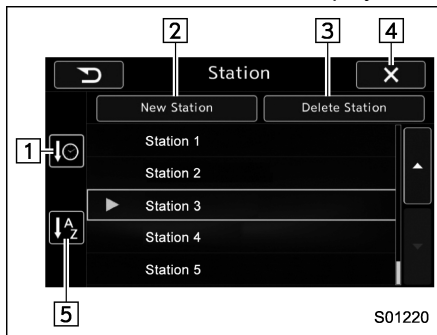

No.	Function
1	Select to sort the list in the chronological order of when the Station List was created.
2	Select to create a station. The station can be created using track names or artist names.
3	Select to delete a station.
4	Return to the control screen.
5	Select to sort the list based on the alphabetical order of the station names.

▼ Store the station

You can register a station.

1. Touch the  List tab on the Pandora main screen.
2. Touch the “New Station” key, and then select the desired key.

Item	Function
From Track	Select to create a station using a track name.
From Artist	Select to create a station using an artist name.
Cancel	Select to cancel the operation to add a station.

▼ Delete the station

You can delete a station.

1. Touch the  List tab on the Pandora top screen.
2. Touch the “Delete Station” key, and then the station list is appeared.
3. Select the item to delete the station. If the confirmation screen appears and the “OK” key is selected, the selected station will be deleted from station list.

■ CD

▼ Control screen and audio panel

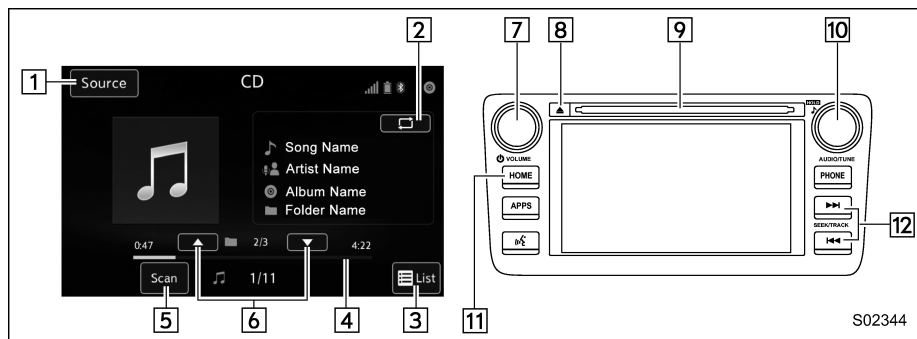

No.	Function
1	Select to display the audio source selection screen.
2	Select to display the play mode currently selected. Refer to "Select play mode" 52.
3	Audio CD: Select to display a track list. MP3/WMA/AAC disc: Select to display a folder list.
4	Shows progress.
5	The tracks in the disc are played back for 10 seconds each from the beginning of the track.

No.	Function
6	MP3/WMA/AAC disc: Select to choose a folder.
7	Turn to adjust volume. Press to turn the audio system on/off.
8	Press to eject a disc.
9	Disc slot
10	Turn to select a track/file. Press to select an audio source. Refer to "Selecting an audio source" 16.
11	Press to display the sound setting screen. Refer to "Unit settings" 17.

No.	Function
12	Press to select a track/file. Press and hold to fast forward/rewind.

NOTE

- Depending on the compression data format of the inserted CD, some keys may not be displayed on the screen.
- If a disc contains CD-DA files and MP3/WMA/AAC files, only the CD-DA files can be played back.
- If a CD-TEXT disc is inserted, the title of the disc and track will be displayed. Up to 32 characters can be displayed.
- If the disc contains no CD-TEXT, only the track number would be displayed on the screen.
- If you press the mute button on the steering wheel during playback, the track pauses. If you press the mute button once again, the playback resumes.

▼ Loading a disc

CAUTION

Never try to disassemble the audio kit or lubricate any part of the CD player. Do not insert anything other than a disc into the slot.

Insert a disc into the disc slot. After insertion, the disc is automatically loaded.

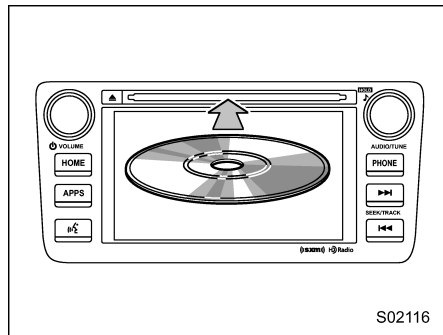

NOTE

When inserting a disc, gently insert it with the label facing up.

▼ Unloading a disc

Press the eject button to remove the disc.

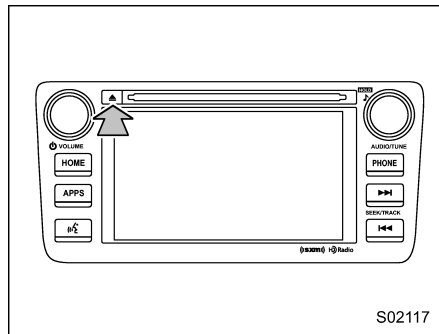

▼ How to change the source

The CD operation screen can be reached by the following methods:

- Insert a disc. Refer to “Loading a disc” 52.
- Select the “DISC” key on the source select screen. Refer to “Selecting an audio source” 16.

▼ Select play mode

The play mode settings display will appear when play mode key is touched. Select the preferred play mode from the following items.

Icon	Function
	Touch to start 1 track repeat.
	Touch to start repeat all.
	Touch to start folder repeat.
	Touch to start shuffle all.
	Touch to start shuffle folder.
	Return to the control screen.

NOTE

Depending on the compression data formant of the inserted CD, the displayed play mode may differ from the illustration shown here.

■ USB memory

Audio files on the USB memory can be played.



WARNING

Do not operate the player's controls or connect the USB memory while driving. Doing so may result in losing control of your vehicle and cause an accident or serious injury.



CAUTION

- Do not leave your USB memory in the car. In particular, high temperatures inside the vehicle may damage the USB memory.
- Do not push down on or apply unnecessary pressure to the USB memory while it is connected as this may damage the USB memory or its terminal.
- Do not insert foreign objects into the port as this may damage the USB memory or its terminal.

▼ Control screen and audio panel

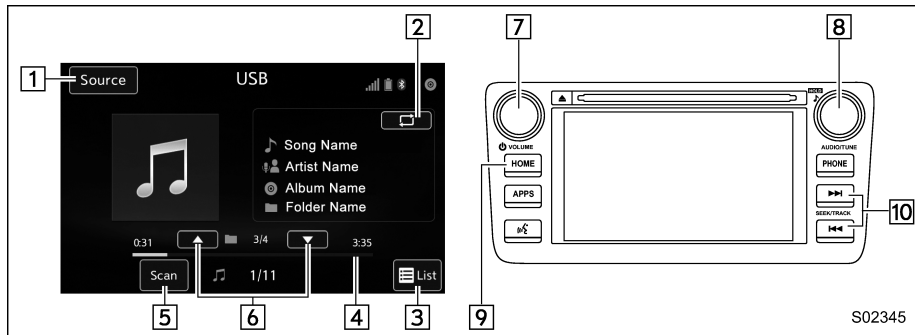

No.	Function
1	Select to display the audio source selection screen.
2	Select to display the play mode currently selected. Refer to "Select play mode" 54.
3	Select to display folder list.
4	Shows progress.
5	The tracks in the folder are played back 10 seconds each from the beginning of the track.
6	Select to choose a folder.
7	Turn to adjust volume. Press to turn the audio system on/off.

No.	Function
8	Turn to select a file/track. Press to select an audio source. Refer to "Selecting an audio source" 16.
9	Press to display the sound setting screen. Refer to "Unit settings" 17.
10	Press to select a file/track. Press and hold to fast forward/rewind.

NOTE

If you press the mute button on the steering wheel during playback, the track pauses. If you press the mute button once again, the playback resumes.

▼ Connecting a USB device

You can connect a USB device to the vehicle USB port. Refer to “Connecting and disconnecting a USB memory/portable device” 15.







▼ How to change the source

The USB Audio playback screen can be reached by the following methods:

- Connect a USB memory. Refer to “Connecting and disconnecting a USB memory/portable device” 15.
- Select the “USB/iPod” key on the source select screen. Refer to “Selecting an audio source” 16.

▼ Select play mode

The play mode settings display will appear when play mode key is touched. Select the preferred play mode from the following items.

Icon	Function
	Touch to start 1 track repeat.
	Touch to start repeat all.
	Touch to start folder repeat.
	Touch to start shuffle all.
	Touch to start shuffle folder.
	Return to the control screen.

■ iPod

Audio files on the iPod can be played.

**WARNING**

Do not operate the player's controls or connect the iPod while driving. Doing so may result in loss of control of your vehicle and cause an accident or serious injury.

**CAUTION**

- **Do not leave your portable player in the car. In particular, high temperatures inside the vehicle may damage the portable player.**
- **Do not push down on or apply unnecessary pressure to the portable player while it is connected as this may damage the portable player or its terminal.**
- **Do not insert foreign objects into the port as this may damage the portable player or its terminal.**

▼ Control screen and audio panel

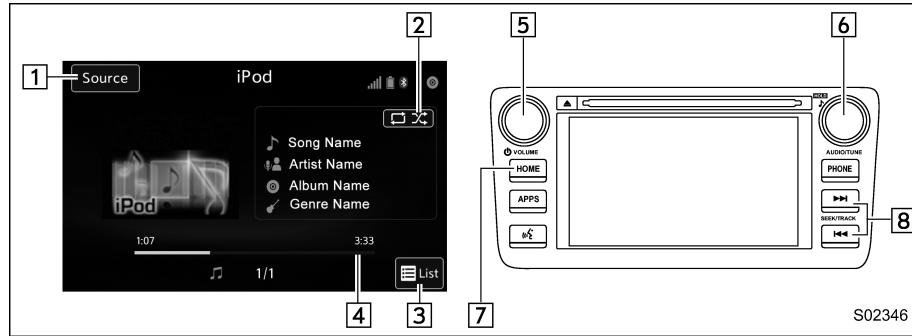

No.	Function
1	Select to display the audio source selection screen.
2	Select to display the play mode currently selected. Refer to "Select play mode" 56.
3	Select to display iPod List. Refer to "iPod settings" 56.
4	Shows progress.
5	Turn to adjust volume. Press to turn the audio system on/off.
6	Turn to select a track/file. Press to select an audio source. Refer to "Selecting an audio source" 16.
7	Press to display the sound setting screen. Refer to "Unit settings" 17.

No.	Function
8	Press to select a track/file. Press and hold to fast forward/rewind.

NOTE

- When an iPod is connected using a genuine USB cable, the iPod starts charging its battery.
- When an iPod is connected and the audio source is changed to iPod mode, the iPod will resume playing from the same point it was last used.
- Depending on the iPod that is connected to the system, certain functions may not be available.
- Files/tracks selected by operating a connected iPod may not be recognized or displayed properly.
- If you press the mute button on the steering wheel during playback, the track pauses. If you press the mute button once again, the playback resumes.

▼ Connecting the iPod

You can connect an iPod to the vehicle USB port using the USB cable. Refer to "Connecting and disconnecting a USB memory/portable device" 15.







▼ How to change the source

The iPod operation screen can be reached by the following methods:

- Connect an iPod. Refer to “Connecting and disconnecting a USB memory/portable device” 15.
- Select the “USB/iPod” key on the source select screen. Refer to “Selecting an audio source” 16.









▼ Select play mode

The play mode settings display will appear when play mode key is touched. Select the preferred play mode from the following items.

Icon	Function
	Touch to start 1 track repeat.
	Touch to start repeat all.
	Touch to start shuffle all.
	Touch to turn off shuffle.
	Touch to start shuffle album.
	Return to the control screen.

▼ iPod settings

You can choose the following items from the list screen after touching the  List tab on the screen.

Icon	Function
	Select to display the play list.
	Select to display tracks list.
	Select to display artists list.
	Select to display albums list.
	Select to open other list (“Genres”, “Composers”, “Audiobooks” and “Podcast”).
	Select to open “Genres” list.
	Select to open “Composers” list.
	Select to open “Audiobooks” list.
	Select to open “Podcasts” list.

■ Bluetooth audio

The Bluetooth audio system enables users to enjoy listening to music that is played on a portable player on the vehicle speakers via wireless communication.

This audio system supports Bluetooth, a wireless data system capable of playing portable audio music without cables. If your device does not support Bluetooth, the Bluetooth audio system will not function.



WARNING

- **Do not operate the player’s controls or connect to the Bluetooth audio system while driving. Doing so may result in loss of control of your vehicle and cause an accident or serious injury.**
- **Your audio unit is fitted with Bluetooth antennas. People with implantable cardiac pacemakers, cardiac resynchronization therapy-pacemakers or implantable cardioverter defibrillators should maintain a reasonable distance between themselves and the Bluetooth antennas. The radio waves may affect the operation of such devices.**

- Before using Bluetooth devices, users of any electrical medical device other than implantable cardiac pacemakers, cardiac re-synchronization therapy-pacemakers or implantable cardioverter defibrillators should consult the manufacturer of the device for information about its operation under the influence of radio waves. Radio waves could have unexpected effects on the operation of such medical devices.

CAUTION

Do not leave your portable player in the vehicle. In particular, high temperatures inside the vehicle may damage the portable player.

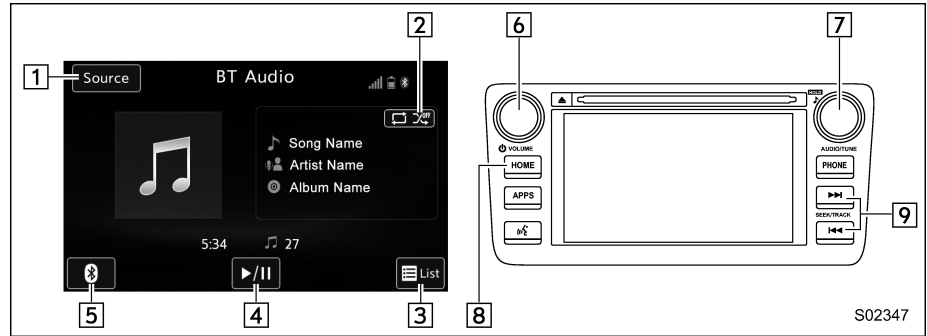

▼ Control screen and audio panel



No.	Function
1	Select to display the audio source selection screen.
2	Select to display the play mode currently selected. Refer to "Select play mode" 59.
3	Select to display as a list (for the models with AVRCP Ver. 1.4 or higher).
4	The track pauses when touched during playback and plays when touched during pause.
5	Select to open Bluetooth Settings. Refer to "Setting Bluetooth details" 67.
6	Turn to adjust volume. Press to turn the audio system on/off.

No.	Function
7	Turn to select a track. Press to select an audio source. Refer to "Selecting an audio source" 16.
8	Select to display the sound setting screen. Refer to "Unit settings" 17.
9	Press to select a track. Press and hold to fast forward/rewind.



NOTE

- Depending on the Bluetooth device that is connected to the system, the music may start playing when selecting the  key while it is paused. Conversely, the music may pause when selecting the  key while it is playing.
- In the following conditions, the system may not function:
 - The Bluetooth device is turned off.
 - The Bluetooth device is not connected.
 - The Bluetooth device has a low battery.
- It may take time to connect the phone when Bluetooth audio is being played.
- For operating the portable player, see the instruction manual that comes with it.
- If the Bluetooth device is disconnected due to poor reception from the Bluetooth network when the ignition switch is in the “ACC” or “ON” position, the system will automatically reconnect to the portable player.
- If the Bluetooth device is disconnected on purpose, such as it was turned off, this does not happen. Reconnect the portable player manually.

- Bluetooth device information is registered when the Bluetooth device is connected to the Bluetooth audio system. When selling or disposing of the vehicle, remove the Bluetooth audio information from the system. Refer to “Bluetooth® settings”  64.

▼ Connecting a Bluetooth device

To use the Bluetooth audio system, it is necessary to register a Bluetooth device with the system.

- Registering an additional device
 1. Select the “Add” key on the Bluetooth devices connection screen.
 2. For more information: Refer to “Registering/connecting Bluetooth® device”  64.
- Selecting a registered device
 1. Select the “Select” key on the Bluetooth devices connection screen.
 2. For more information: Refer to “BT Devices Connection screen”  67.

▼ How to change the source







Select the “BT Audio” key on the source select screen. Refer to “Selecting an audio source”  16.

NOTE

Depending on the type of portable player connected, some functions may not be available and/or the screen may look differently than shown in this manual.

▼ Select play mode

The play mode settings display will appear when play mode key is touched. Select the preferred play mode from the following items.

Icon	Function
	Touch to start 1 track repeat.
	Touch to start repeat all.
	Touch to repeat the tracks in the group.
	Touch to start shuffle all.
	Touch to play tracks in the order in which they are registered in the audio device.
	Touch to start shuffle group.
	Return to the control screen.

NOTE

If the connected device does not support the group repeat mode, the group functions are not available.

■ AUX



WARNING

Do not operate the player's controls or connect the portable audio device while driving. Doing so may result in loss of control of your vehicle and cause an accident or serious injury.



CAUTION

- Do not leave portable audio device in the vehicle. The temperature inside the vehicle may become high, resulting in damage to the player.
- Do not push down on or apply unnecessary pressure to the portable audio device while it is connected as this may damage the portable audio device or its terminal.
- Do not insert foreign objects into the port as this may damage the portable audio device or its terminal.

▼ Control screen and audio panel

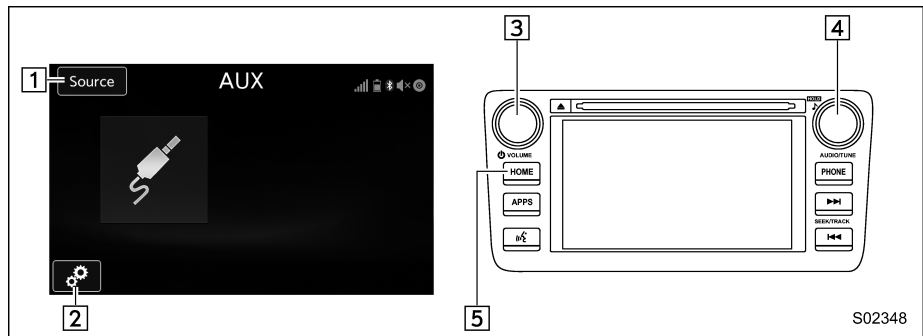

No.	Function
1	Select to display the audio source selection screen.
2	Select to adjust the audio gain level. Refer to “Audio level settings” 60.
3	Turn to adjust volume. Press to turn the audio system on/off.
4	Press to select an audio source. Refer to “Selecting an audio source” 16.
5	Press to display the sound setting screen. Refer to “Unit settings” 17.

▼ Connecting a portable audio device

You can connect a portable audio device to the vehicle AUX jack. Refer to “Connecting and disconnecting a USB memory/portable device” 15.

▼ How to change the source

The AUX operation screen can be reached by the following methods:

- Connect a portable audio device. Refer to “Connecting and disconnecting a USB memory/portable device” 15.
- Select the “AUX” key on the source select screen. Refer to “Selecting an audio source” 16.

▼ Audio level settings

You can set the audio gain level.

1. Select the gear icon tab on the screen, and then touch the right side key of the “Audio Level” key.
2. Select the audio level from the following items.
 - Low
 - Mid
 - High

Remote controller on steering wheel

Some parts of the audio/visual system can be operated by using the remote controller on the steering wheel.

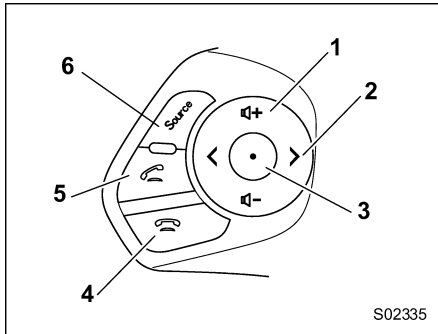

- 1) + - button
- 2) ◀▶ button
- 3) Mute/Enter button
- 4) On hook button
- 5) Off hook button
- 6) Source button

- +/- button

Mode	Operation	Function
Except list screen	Press	Volume up/down
	Press and hold	Volume up/down continuously
List screen	Press	Move cursor up/down
Pandora main screen (if equipped)	Press and hold	"+" button is thumb up/"-" button is thumb down

- ◀▶ button

Mode	Operation	Function
AM/FM Radio, SiriusXM (if equipped)	Press	Preset channel up/down
	Press and hold	Seek up/down continuously while the button is being pressed
aha	Press	Content up/down
	Press and hold	Reverse the current content item for 15 seconds/Fast forward the current content item for 30 seconds
Audio CD, MP3/WMA/AAC disc, USB, iPod, BT audio	Press	Select a track/file
	Press and hold	Fast forward/rewind
Pandora (if equipped)	Press and hold	Thumbs up
List screen	Press	Move cursor left/right

- Mute/Enter button

Mode	Operation	Function
List screen	Press	Select cursor entry
CD, USB, iPod, BT audio, Pandora (if equipped), aha	Press	Pause or play back
AM/FM radio, AUX, SiriusXM (if equipped)	Press	Mute or cancel mute

- On hook/Off hook button

Mode	Operation	Function
All	Press	Use or cancel the hands-free system

- Source button

Mode	Operation	Function
All	Press	Change audio modes

NOTE

In the aha, Pandora (if equipped) and SUBARU STARLINK (if equipped) mode, some operation may be done on the screen depend on the selected APPS.

Bluetooth® settings

⚠ WARNING

Be sure to park the vehicle in a safe location before connecting or operating a Bluetooth phone or audio device. Failure to do so may result in loss of control of your vehicle and cause an accident or serious injury.

■ Regulatory information



The Bluetooth® word mark and logos are registered trademarks owned by Bluetooth SIG, Inc.

■ Registering/ connecting Bluetooth® device

You can register up to five devices, regardless of whether they are Bluetooth phones or audio devices.

NOTE

- Once the phone has been registered, it is possible to use the hands-free system or Bluetooth audio.

- Devices cannot be registered during driving.

▼ Registering a Bluetooth phone for the first time

To use the hands-free system, it is necessary to register a Bluetooth phone with the system.

For details about registering a Bluetooth device: Refer to “Registering a Bluetooth Audio device for the first time” 65.

- Turn the Bluetooth connection setting of your cell phone on.
 - This function is not available when Bluetooth connection setting of your cell phone is set to off.
- Press the HOME button and select the “SETTINGS” key.

- Touch the tab and then the “SETTINGS” screen will appear.

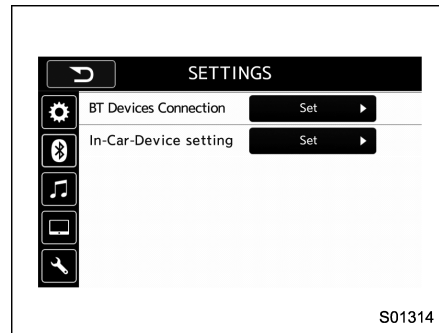

Settings (When the tab is selected)

- Operations up to this point can also be performed by pressing the button (audio unit) or button (steering wheel).
- To register a device, touch the “Set” key on “BT Devices Connection”.

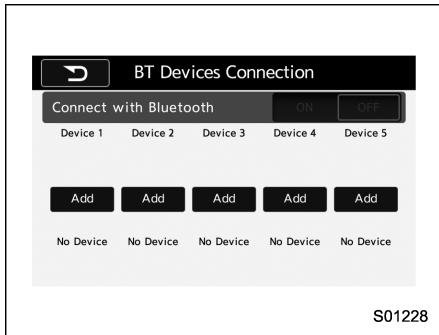

“BT Devices Connection” screen (At the initial startup and when no device is registered).

5. Touch the “Add” key.

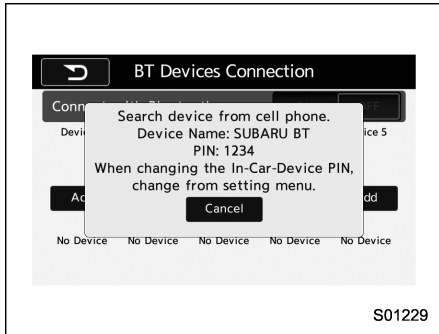

When the “Add” key is selected (Waiting for the connection request from a device).

- For details about operating the Bluetooth device, see the manual that comes with it.
 - To cancel the registration, touch the “Cancel” key.
6. Register the Bluetooth device using your Bluetooth device.
- A PIN-code is not required for SSP (Secure Simple Pairing) compatible Bluetooth devices. Depending on the type of Bluetooth device being connected, a message confirming registration may be displayed on the Bluetooth device’s screen. Respond and operate the Bluetooth device according to the confirmation message.
7. Check that the screen is displayed when registration is complete.
- The system waits for connection requests coming from the registered device.
 - At this stage, the Bluetooth functions are not yet available.

▼ Registering a Bluetooth Audio device for the first time

To use the Bluetooth Audio, it is necessary to register an audio device with the system.

The device registration procedure is the same for both the hands-free system and

Bluetooth audio.

1. Display the “BT Devices Connection” screen. Refer to “Registering a Bluetooth phone for the first time” 64.

2. Select the “Add” key.

The “Add” key is not displayed when five devices are already registered.

To add another device, you need to delete one of the registered devices.

Press the  key for the device to be deleted, and then select the “OK” key.

3. Register the Bluetooth device using your Bluetooth device.

- A PIN-code is not required for SSP (Secure Simple Pairing) compatible Bluetooth devices. Depending on the type of Bluetooth device being connected, a message confirming registration may be displayed on the Bluetooth device’s screen. Respond and operate the Bluetooth device according to the confirmation message.

4. Check that the screen is displayed when registration is complete.

- The system waits for connection requests coming from the registered device.

- At this stage, the Bluetooth functions are not yet available.

▼ Profiles

This system supports the following services.

Bluetooth Device	Spec.	Function	Requirements	Recommendations
Bluetooth Phone/Bluetooth Audio Device	Bluetooth Specification	Registering a Bluetooth device	Ver. 1.1	Ver. 2.1 + EDR

Bluetooth Device	Profile	Function	Requirements	Recommendations
Bluetooth Phone	HFP (Hands-Free Profile)	Hands-free system	Ver. 1.0	Ver. 1.5
	OPP (Object Push Profile)	Transferring the contacts	Ver. 1.1	Ver. 1.1
	PBAP (Phone Book Access profile)		Ver. 1.0	Ver. 1.0
	MAP (Message Access Profile)	Bluetooth phone message	—	Ver. 1.0
	SPP (Serial Port Profile)	Connecting a Bluetooth phone	—	Ver. 1.1
Bluetooth Audio Device	A2DP (Advanced Audio Distribution Profile)	Bluetooth audio system	Ver. 1.0	Ver. 1.2
	AVRCP (Audio/Video Remote Control Profile)		Ver. 1.0	Ver. 1.4

NOTE

- If your cell phone does not support HFP, registering the Bluetooth phone or using OPP, PBAP, MAP or SPP profiles individually will not be possible.
- If the connected Bluetooth device version is older than recommended or incompatible, the Bluetooth device function may not work properly.
- For USA customers, please visit www.subaru.com for details. Outside of the USA customers, contact your local dealer to arrange a demonstration in order to confirm whether or not the device can be paired with the vehicle.



■ Setting Bluetooth details

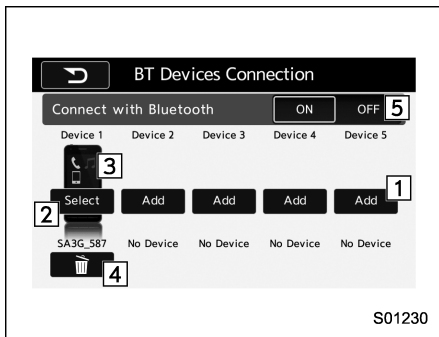

▼ BT Devices Connection screen

1. Press the HOME button.
2. Touch the “SETTINGS” key and then touch the  tab.
3. Touch the “BT Devices Connection” key and then select the desired device to register.



“BT Devices Connection” screen (One device is registered.)



No.	Function
	Register the device. Refer to “Registering/connecting Bluetooth® device” ☞64 .
	Make the connection to the registered device.

No.	Function
	This shows the status of the device connection profile. (The icon illuminates while connected.)
	Delete the registered device. Refer to “Deleting a Bluetooth device” ☞68 .
	Switch to connect/disconnect Bluetooth communication. Refer to “Bluetooth ON/OFF” ☞67 .

▼ Connecting a Bluetooth device

Up to 5 Bluetooth devices (phones and audio devices) can be registered.

If more than 1 Bluetooth device has been registered, select which device to connect to.

1. Display the “BT Devices Connection” screen. Refer to “BT Devices Connection screen” [☞67](#).
2. Select the device to be connected.
 - Supported profile icons will be displayed.
 -  : Phone
 -  : Audio device
 -  : Smartphone Application
 - Supported profile icons for currently connected devices will illuminate.
 - The audio icon illuminates only when in the Bluetooth audio mode.
 - All icons are dimmed when Blue-

tooth is set to off or when the connection cannot be made with the device.

NOTE

- It may take time if the device connection is carried out during Bluetooth audio playback.
- Depending on the type of Bluetooth device being connected, it may be necessary to perform additional steps on the device.
- It is not possible to establish a Bluetooth connection with iOS devices currently connected with a USB cable.
- Supported profile icons of the unselected devices are not displayed if several Bluetooth devices have been registered.

▼ Bluetooth ON/OFF

1. Display the “BT Devices Connection” screen. Refer to “BT Devices Connection screen” [☞67](#).
2. Select the “ON” or “OFF” key by the right side of the “Connect with Bluetooth” key. The “ON” key establishes a connection, and the “OFF” key disconnects the connection.

NOTE

The setting is fixed as the “OFF” key when no device is registered.

▽ Deleting a Bluetooth device

1. Display the “BT Devices Connection” screen. Refer to “BT Devices Connection screen” 67.
2. Select the desired device.
3. Touch the  key for the device to be deleted, and then select the “OK” key.

NOTE

When deleting a Bluetooth phone, the contact data will be deleted at the same time.

▼ “In-Car-Device setting” screen

The Bluetooth settings can be confirmed and changed.

1. Display the “SETTINGS” screen. Refer to “Registering a Bluetooth phone for the first time” 64.
2. On the “SETTINGS” screen for “In-Car-Device setting”, select the “Set” key.

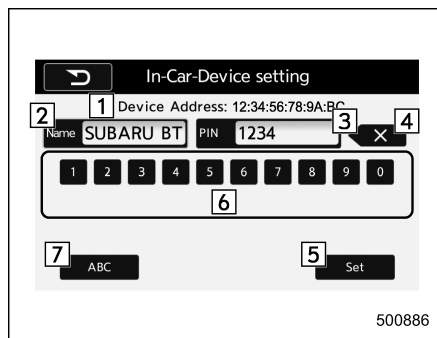

No.	Function
1	Display the Bluetooth device address of the in-vehicle equipment.
2	Display the Bluetooth device name of the in-vehicle equipment. The default name is “SUBARU BT”, which can be changed by selecting it and entering alphanumeric characters.
3	Display the PIN code of the in-vehicle equipment. The default code is “1234”, which can be changed by selecting it and entering numbers.
4	Delete one character from the currently selected item (BT device name or the PIN code).
5	Save the current BT device name and PIN code.
6	Numeric input keys.

No.	Function
7	Switch the screen to input characters.

▽ Editing the Bluetooth device name

- The device name can be set or changed.
1. Touch the “Name” key.
 2. Enter a name and then select the “Set” key.

▽ Editing the PIN-Code

The PIN-code can be set or changed.

1. Select the “PIN” Key.
2. Enter a PIN-code and then select the “Set” key.

NOTE

If the “PIN” key is already selected, the “ABC” key is cross-hatched and disabled.

Hands-free phone system

The hands-free system enables calls to be made and received without having to take your hands off the steering wheel.

This system supports Bluetooth. Bluetooth is a wireless data system that enables cell phones to be used without being connected by a cable or placed in a cradle.

The operating procedure of the phone is explained here.



WARNING

- While driving, do not use a cell phone or connect the Bluetooth phone. Doing so may result in loss of control of your vehicle and cause an accident or serious injury.
- Your audio unit is fitted with Bluetooth antennas. People with implantable cardiac pacemakers, cardiac resynchronization therapy-pacemakers or implantable cardioverter defibrillators should maintain a reasonable distance between themselves and the Bluetooth antennas. The radio waves may affect the operation of such devices.

- Before using Bluetooth devices, users of any electrical medical device other than implantable cardiac pacemakers, cardiac resynchronization therapy-pacemakers or implantable cardioverter defibrillators should consult the manufacturer of the device for information about its operation under the influence of radio waves. Radio waves could have unexpected effects on the operation of such medical devices.



CAUTION

Do not leave your cell phone in the vehicle. The temperature inside may rise to a level that could damage the phone.

NOTE

- If your cell phone does not support Bluetooth, this system cannot function.
- In the following conditions, the system may not function:
 - The cell phone is turned off.
 - The current position is outside the communication area.
 - The cell phone is not connected.
 - The cell phone has a low battery.

- When using the hands free function and other Bluetooth functions at the same time, the following problems may occur:
 - The Bluetooth connection may be cut.
 - Noise may be heard when playing back voice with the Bluetooth function.
- The other party's voice will be heard from the front speakers. The audio/visual system will be muted during phone calls or when hands-free voice commands are used.
- Talk alternately with the other party on the phone. If both parties speak at the same time, the other party may not hear what has been said. (This is not a malfunction.)
- Keep call volume down. Otherwise, the other party's voice may be audible outside the vehicle and voice echo may increase. When talking on the phone, speak clearly towards the microphone.
- The other party may not hear you clearly when:
 - Driving on an unpaved road. (Making excessive traffic noise.)
 - Driving at high speeds.
 - The moonroof or windows are open.
 - The air conditioning vents are

pointed towards the microphone.

- The sound of the air conditioning fan is loud.
- There is a negative effect on sound quality due to the phone and/or network being used.
- When another phone is connected, the following registered data cannot be read:
 - Contact data
 - Call history data
 - All phone settings
- When selling or disposing of the vehicle, initialize the data. Refer to “Unit settings” 7-17.
- Once initialized, the data and settings will be erased. Take extra caution when initializing the data.
- The voice command system supports phone commands, so dialing a phone number using your voice is possible. Refer to “Voice command system” 7-80.
- The images shown in this Owner’s Manual are sample images. The actual images may vary depending on the market and specifications of your vehicle.

■ Control screen

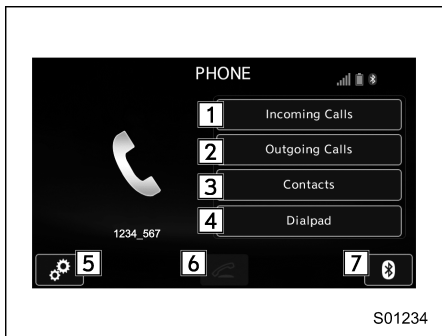

PHONE (Menu) screen

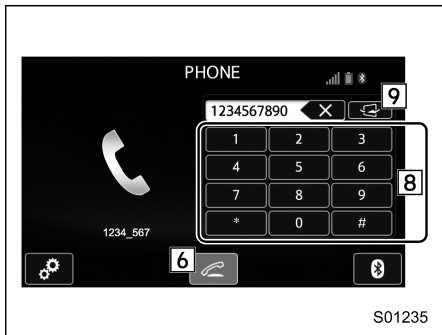

PHONE (Dialpad) screen

No.	Function
1	Open the “Incoming Calls” screen. Refer to “By incoming calls” 7-72.
2	Open the “Outgoing Calls” screen. Refer to “By outgoing calls” 7-73.
3	Open the “Contacts” screen. Refer to “By contacts list” 7-74.
4	Open the dialpad screen. Refer to “By Dialpad” 7-75.
5	Open the phone volume settings screen. Refer to “Phone volume settings” 7-78.
6	Use to make a phone call. You cannot press this key until you open the dialpad screen and enter a phone number.
7	Open the “BT Devices Connection” screen. Refer to “Setting Bluetooth details” 7-67.
8	Enter the phone number that you want to call.
9	Switch the screen to the phone (menu) screen.

NOTE

When the cell phone is not registered and the Bluetooth setting is off, a message is displayed instead of menu items.

■ Registering/connecting a Bluetooth phone

To use the hands-free system for cell phones, it is necessary to register a cell phone with the system. Refer to “Registering/connecting Bluetooth® device” 64.

▼ Bluetooth phone condition display



The condition of the Bluetooth phone appears on the upper right side of the screen.

■ Using the phone

- Audio unit

By pressing the **PHONE** button, a call can be received or ended.

- Steering wheel

By pressing  / , a call can be received or ended without taking your hands off the steering wheel.

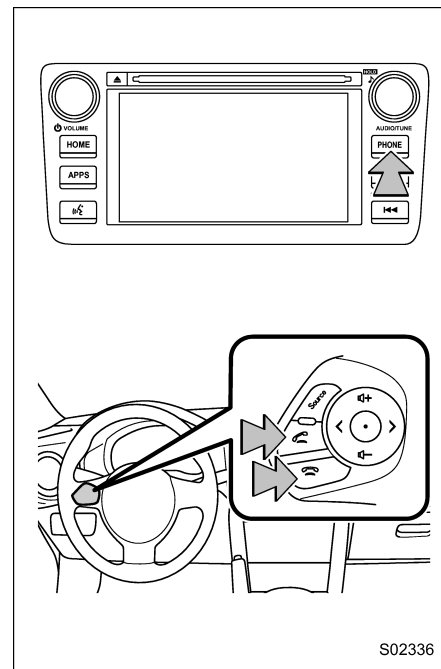

S02336

- Microphone

The microphone is used when talking on the phone.

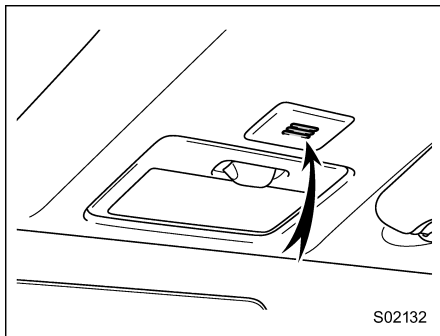

■ How to change the hands-free phone system

The phone (menu) screen can be used to make a phone call. To display the hands-free operation screen, press the HOME button and then select the "PHONE" key, or press the **PHONE** button (audio unit) or button (steering wheel).

■ Making a call

There are several methods by which a call can be made, as described below.

1. Press the HOME button on the audio panel.
2. Touch the "PHONE" key.
3. Select the desired key to make a call from the list.

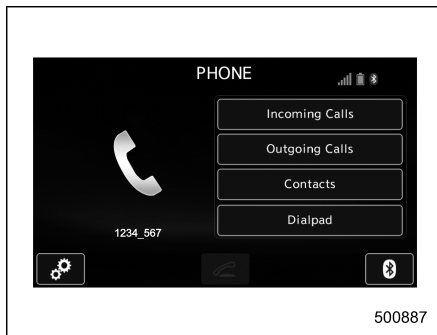

Item	Function
Incoming Calls	Display the history of incoming calls. Refer to "By incoming calls" 72.
Outgoing Calls	Display the history of outgoing calls. Refer to "By outgoing calls" 73.
Contacts	Display the phonebook. Refer to "By contacts list" 74.

Item	Function
Dialpad	Dial a phone number. Refer to "By Dialpad" 75.

NOTE

You can also make a call by using the following functions.

- Make a call using the **PHONE** button (audio unit) or button (steering wheel). Refer to "By off hook button" 75.
- Make a call using voice operation. Refer to "Voice command system" 80.

▼ By incoming calls

On the phone (menu) screen, select the "Incoming Calls" key to open the "Incoming Calls" screen.

You can make a call by selecting an item in the incoming call history list.

If there is no incoming call history, a message appears to indicate that there is no incoming call history data.

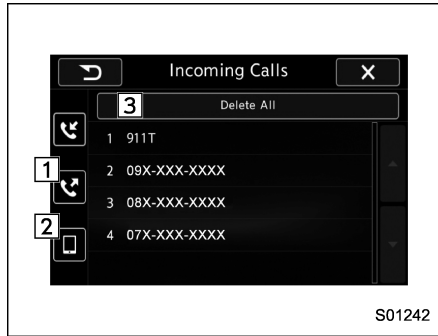

Incoming Calls screen

No.	Function
1	Open the "Outgoing Calls" screen.
2	Open the "Contacts" screen.
3	Delete all incoming call history data. The "Delete All" key is disabled when there is no incoming call history.

When you select an item in the history list on the "Incoming Calls" screen, the outgoing call screen opens.

NOTE

- Up to 10 items in the incoming call history are listed. Scroll the screen to see items that are not on the screen.
- When making a call to the same number continuously, only the most recent call is listed in call history.
- When a phone number registered in the contact list is received, the name is displayed.
- Number-withheld calls are also memorized in the system.
- International phone calls may not be made depending on the type of cell phone you have.
- The list should group together consecutive entries with the same phone number and same call type.

▼ By outgoing calls

On the phone (menu) screen, select the "Outgoing Calls" key to open the "Outgoing Calls" screen. You can make a call by selecting an item in the outgoing call history list.

If there is no outgoing call history, a message appears to indicate that there is no outgoing call history data.

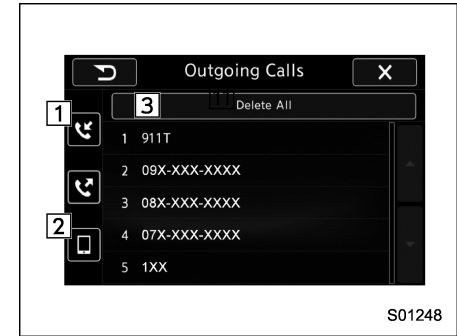

Outgoing Calls screen

No.	Function
1	Open the "Incoming Calls" screen.
2	Open the "Contacts" screen.
3	Delete all outgoing call history data. The "Delete All" key is disabled when there is no outgoing call history.

When you select an item in the history list on the "Outgoing Calls" screen, the outgoing call screen opens.

NOTE

- Up to 10 items in the outgoing call history are listed. Scroll the screen to see items that are not on the screen.
- When making a call to the same number continuously, only the most recent call is listed in call history.
- When a phone number registered in the contact list is received, the name is displayed.
- Number-withheld calls are also memorized in the system.
- International phone calls may not be made depending on the type of cell phone you have.
- The list should group together consecutive entries with the same phone number and same call type.

▼ By contacts list

On the phone (menu) screen, select the “Contacts” key to open the phone number list screen.

You can make a call by selecting an item in the list (up to five phone numbers are listed).

If there is no contact data, a message is displayed to indicate that there is no contact data.

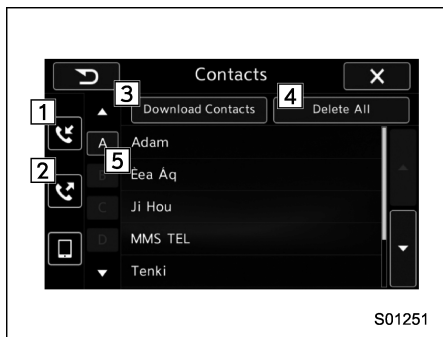

Contacts screen

No.	Function
1	Open the “Incoming Calls” screen.
2	Open the “Outgoing Calls” screen.
3	Open a pop-up screen for starting the download of contact data. Refer to “Update contacts from phone” 78.
4	Delete all contact data. The “Delete All” key is disabled when there is no contact data. Refer to “Deleting the contact data” 79.

No.	Function
5	Open a list of contacts that starts with the selected character. This key is cross-hatched and cannot be selected if there is no contact data that starts with the selected character.

Select the up/down arrow key to scroll the list of contacts.

When you select a phone number on the screen, the outgoing call screen opens.

NOTE

Up to 1000 items in the contact data are listed. Scroll the screen to see items that are not on the screen.

▽ When the contact is empty

For PBAP incompatible but OPP compatible Bluetooth phones

On the “Contacts” screen, select the “Download Contacts” key. A screen where you can select how to download contacts opens.

You can select to download all items or download one item. For details, refer to “Update contacts from phone” 78.

▼ Delete contacts

When the “Delete All” key is selected, all contact data downloaded into the in-vehicle equipment will be deleted.

Refer to “Deleting the contact data” 79.

▼ By Dialpad

Input the phone number manually using the keypad displayed on the screen.



Phone (Dialpad) screen

No.	Function
1	Allow you to enter numbers from 0 to 9 and *, #, and +. To enter “+”, press and hold the “0” key.
2	Delete one character from the entered characters.
3	Switch the screen to the phone (menu) screen.

No.	Function
4	Open the “Outgoing Calls” screen and dials the entered phone number. This is the same as pressing the PHONE button (audio unit) or PHONE button (steering wheel). This key is cross-hatched and cannot be selected until the phone number is entered.
5	Open the “Options” screen. Refer to “Phone volume settings” 78.
6	Open the “BT Devices Connection” screen. Refer to “Setting Bluetooth details” 67.

When you enter a phone number on the screen and select the **PHONE** key, the “Outgoing Call” screen opens.

▼ By off hook button

Calls can be made using the latest call history item.

1. Press the **PHONE** button (audio unit) or **PHONE** button (steering wheel) to display the phone (menu) screen.
2. Check that the call screen is displayed.

▼ Outgoing screen

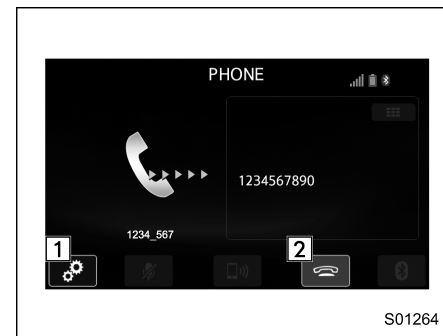

Outgoing call screen

No.	Function
1	Open the “Options” screen. Refer to “Phone volume settings” 78.
2	Abort the call. The screen returns to the phone (menu) screen. This is the same as pressing the PHONE button (audio unit) or PHONE button (steering wheel).

NOTE

- Depending on the type of Bluetooth phone being connected, it may be necessary to perform additional steps on the phone.
- When you are on the outgoing call screen, the screen changes to the call screen when the other party answers

the call.

- The , , and  keys are disabled on the outgoing call screen.

■ Receiving a call

▼ Incoming calls







When a call is received, the incoming call screen is displayed with a sound.

When you receive a phone call while the cell phone is connected, the screen changes to the incoming call screen.



Incoming call screen





No.	Function
1	Open the "Options" screen. Refer to "Phone volume settings" 78.

No.	Function
2	Put the incoming call on hold. This function may not work on some cell phone models. This function is the same as pressing the  button (audio unit) or  button (steering wheel) for a short period of time.
3	Open the call screen. This function is the same as pressing the  button (audio unit) or  button (steering wheel).
4	Reject the incoming call. This function is the same as pressing and holding the  button (audio unit) or  button (steering wheel).

NOTE

- During international phone calls, the other party's name or number may not be displayed correctly depending on the type of cell phone you have.
- The ringtone that has been set in the phone setting screen sounds when there is an incoming call. Depending on the type of Bluetooth phone, both the system and Bluetooth phone may sound simultaneously when there is an incoming call. Refer to "Phone volume settings" 78.

▼ By off/on hook button



When you receive a call, you can also answer it by pressing the  button (audio unit) or  button (steering wheel). To end a call, press the  button (audio unit) or  button (steering wheel).

■ Talking on the phone

The call screen opens when you perform the following operations.

- When you accept a call on the incoming call screen (by selecting the  key), the call screen opens.
- When you are on the outgoing call screen, the screen changes to the call screen when the other party answers the call.

While talking on the phone, this screen is displayed. The operations outlined below can be performed on this screen.

- When the incoming call screen is displayed and you accept the call, the screen changes to the call screen. The screen stays on the incoming call screen if you reject the call.
- The  and  keys are disabled on the incoming call screen.

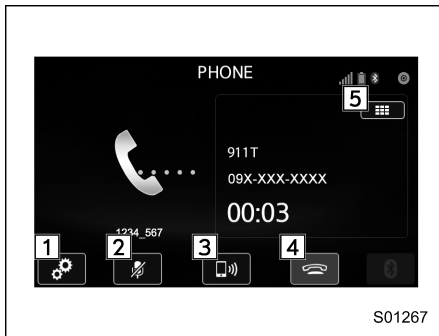

Call screen



Call (Dialpad) screen (DTMF)

No.	Function
1	Open the "Options" screen. Refer to "Phone volume settings" ¶78.
2	Mute your voice to the other party. Touch this key again to deactivate the Mute mode. This key is disabled in the private mode.
3	Change the mode to private mode. The other party's voice emits from the cell phone. Touch this key again to deactivate the private mode.
4	End the call. This will return you to the phone (menu) screen when ending outgoing calls and the previous screen when ending incoming calls. This function is the same as pressing the PHONE button (audio unit) or PHONE button (steering wheel).
5	Open the call (dialpad) screen. For details about how to use the function, refer to "By Dialpad" ¶75.
6	Switch the screen to the phone (menu) screen.
7	Allow you to make DTMF (Dual Tone Multi Frequency) calls. The numbers you enter are sent as tone signals.

NOTE

- When cell phone call is changed to hands-free call, the hands-free screen is displayed and its functions can be operated on the screen.
- Changing between cell phone call and hands-free call can be performed

by operating the cell phone directly.

- Transferring methods and operations will be different depending on the type of cell phone you have.
- For the operation of the cell phone, see the manual that comes with it.
- The sound quality of the voice heard from the other party's speaker may be negatively impacted.

■ Phone settings

You can transfer the phonebook information and adjust the volume of your phone using the Bluetooth phone system.

NOTE

- The ringer volume for outgoing and incoming calls, as well as the volume while on hold or during a call are controlled independently from the volume of the audio source. The volume setting in the phone setting is applied.
- When making a call, receiving a call or while talking on the phone, you can adjust the volume by using the power/Volume knob on the audio panel or the volume control button on the steering wheel.

▼ Phone volume settings

The call and ringtone volume can be adjusted. A ringtone can be selected.

1. Display the “PHONE” screen. Refer to “How to change the hands-free phone system” 72.
2. Touch the  key.
3. Select the desired item to be set.

- On the “PHONE” screen, the screen changes to the “Options” screen when you select the  key.

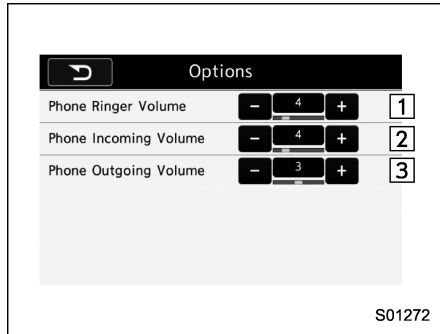

Options (volume settings) screen

No.	Function
1	Adjust the ringtone volume. The “-” key lowers the volume, and the “+” key increases the volume. (Default volume: 4 out of a total of 16 volume levels)
2	Adjust the receive volume. The “-” key lowers the volume, and the “+” key increases the volume. (Default volume: 4 out of a total of 16 volume levels)
3	Adjust the transmit volume. The “-” key lowers the volume, and the “+” key increases the volume. (Default volume: 3 out of a total of 5 volume levels)

NOTE

- Depending on the type of phone, certain functions may not be available.
- Contact data is managed independently for every registered phone. When one phone is connected, another phone’s registered data cannot be read.

▼ Update contacts from phone

Operation methods differ between PBAP (Phone Book Access Profile) compatible and PBAP incompatible but OPP (Object Push Profile) compatible Bluetooth phones.

1. Display the “PHONE” screen. Refer to “How to change the hands-free phone

system” 72.

2. Touch the “Contacts” key, and then select the “Download Contacts” key.

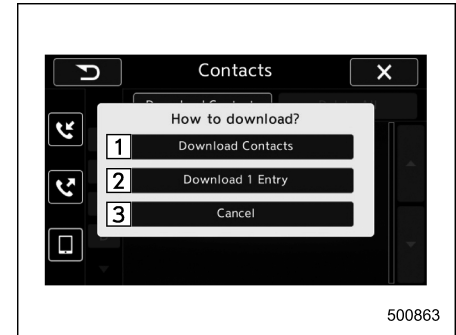

Contacts screen (Download selection)

No.	Function
1	Open the download confirmation screen. Confirm whether or not to download. If the downloaded contact (s) already exist(s), confirm whether or not to overwrite the existing data.
2	Download one set of contact data. To download the data, you need to operate from the connected device.
3	Cancel the download. The screen returns to the “Contacts” screen.

NOTE

- If your cell phone is neither PBAP nor OPP compatible, the contacts cannot be transferred.
- When you are transferring the contacts data, you may have to operate the cell phone, depending on the type of cell phone.
- Depending on the type of cell phone, some functions may not be supported.

▽ For PBAP compatible Bluetooth phones

1. Select the “Download Contacts” or “Download 1 Entry” key. Contacts are transferred automatically.
2. Check that a confirmation screen is displayed when the operation is complete.
 - This operation may be unnecessary depending on the type of cell phone.
 - If another Bluetooth device is connected when transferring contact data, depending on the phone, the connected Bluetooth device may need to be disconnected.

▽ For PBAP incompatible but OPP compatible Bluetooth phones

1. Select the “Download 1 Entry” key.
2. Transfer the contact data to the system using a Bluetooth phone.
 - This operation may be unnecessary depending on the type of cell phone.
 - To cancel this function, select the “Cancel” key.
3. Check that a confirmation screen is displayed when the operation is complete.

NOTE

To download all items, you may need to change the settings in your cell phone beforehand.

▼ Deleting the contact data

You can delete the phonebook data stored in the audio set.

1. Display the “PHONE” screen. Refer to “How to change the hands-free phone system” [72](#).
2. Touch the “Contacts” key, and then select the “Delete All” key.
3. Select the “OK” key when the confirmation screen appears.

NOTE

- Manual transfer operation cannot be performed while driving.
- If your cell phone is neither PBAP nor OPP compatible, the contacts cannot be transferred.
- Depending on the type of Bluetooth phone:
 - It may be necessary to perform additional steps on the phone when transferring contact data.

Voice command system

The voice command system enables the audio, hands-free phone system, etc. to be operated using voice commands.

Refer to the “Command list” 83 for samples of voice commands.

Voice commands can be used even when you set the system to another language.

For details about setting language, refer to “General settings” 18.

■ Using the voice command system

▼ Talk button

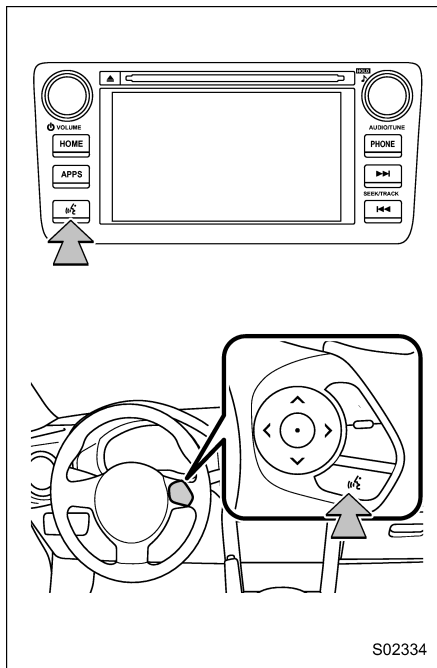

Action	Function
Press	Start the voice command system.
Press and hold	Cancel voice recognition.

▼ Microphone

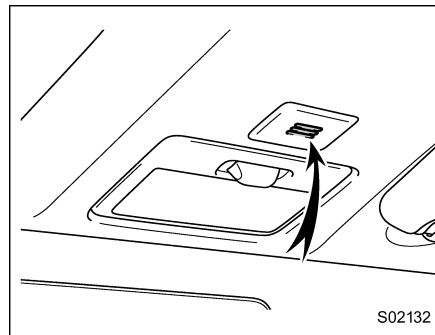

It is unnecessary to speak directly into the microphone when giving a command.

NOTE

- Wait for the confirmation beep before speaking a command.
- Voice commands may not be recognized if:
 - Spoken too quickly.
 - Spoken at a low or high volume.
 - The moonroof or windows are

open.

– Passengers are talking while voice commands are spoken.

– The air conditioning speed is set high.

– The air conditioning vents are turned towards the microphone.

● In the following conditions, the system may not recognize the command properly and using voice commands may not be possible:

- The command is incorrect or unclear. Note that certain words, accents or speech patterns may be difficult for the system to recognize.
- There is excessive background noise, such as wind noise.

■ Voice command system operation

1. Press the talk button.

After the voice command top screen has been displayed, speech guidance will commence.



NOTE

When the voice command mode is audio mode, voice guidance for the voice command system can be skipped by pressing the talk button.

2. Say the command.

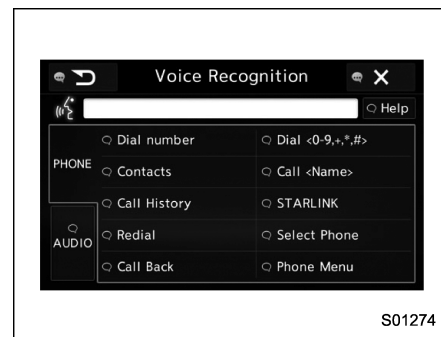

Example (Say “PHONE”)

NOTE

- Commands related with each function are displayed on the screen of the each function tab. Some commonly used commands are displayed on the screen of the main tab. Even if any tab is selected, all commands can be operated.
- Saying “*Help*” prompts guidance to offer examples of commands and operation methods.
- To cancel voice recognition, select “×”, or press and hold the talk button.
- If the system does not respond or the confirmation screen does not disappear, press the talk button and try again.

- The notations used in the commands are as follows.

- < >: Numbers, titles or names to be spoken

▼ Voice command example: Call name

1. Press the talk button.
2. Say *“Call <contacts>”*.
 - A confirmation screen will be displayed showing the recognition results. If multiple matching items are found, a selection screen will be displayed. Say *“<number>”* or select the number.

NOTE

- In the same manner as it is displayed on the screen, *“Call <contacts>”*, after saying *“Call a contact”* say the name of a contact. For example: *“Call a contact”, “John Smith”* or *“Call a contact”, “Mary Davis”*
- Short or abbreviated names in the contacts list may not be recognized. Change names in the contacts list to full names.
- Sometimes a voice recognition result confirmation screen will be displayed. After confirming the result, say *“Yes”* or *“No”*.
- When the system recognizes multi-

ple names from the contacts list, a name candidate list will be displayed on the screen. If the desired name is not displayed on the top of the screen, say or select the number of the name from the candidate list (number 1, number 2, etc.) to select a name from the candidate list.

- When a contact has multiple phone numbers registered in the contacts list, a candidate list will be displayed. If the desired phone number is not displayed on the top of the screen, say or select the number of the desired phone number from the candidate list (number 1, number 2, etc.) to select a phone number from the candidate list.



▼ Voice command example: Dial number

1. Press the talk button.
2. Say *“Dial number”*.
3. Say *“Dial <number>”*.



For example, if the phone number is 2345678:

Say *“two three four five six seven eight”*

Do not say *“twenty three forty five sixty seven eight”*

4. Say *“Dial”* or press the  button (audio unit) or  button (steering wheel).

NOTE

- When the system recognizes multiple phone numbers, a phone number candidate list will be displayed on the screen. Pressing the  button (audio unit) or  button (steering wheel) makes a call to the top entry on the list. If the desired phone number is not displayed on the top of the screen, say the number of the desired phone number from the candidate list to select a phone number from the candidate list.
- Calling to the following phone numbers
 - 3 digit numbers (911, 411, 611)
 - 7 digit numbers (Local phone numbers)
 - 10 digit numbers (Area code + Local phone number)
 - 11 digit phone numbers (1 + Area code + Local phone number)
- As the system cannot recognize additional numbers, say the complete number without stopping.

▼ Casual speech recognition

Due to natural language speech recognition technology, this system enables recognition of a command when spoken naturally. However, the system cannot recognize every variation of each command. In some situations, it is possible to omit the command for the procedure and directly state the desired operation. Not all voice commands are displayed in the function menu.

NOTE

If the command cannot be recognized completely, the command input screen will be displayed. (Search results will be shown based on the part of the command that was recognized.)

▽ Expression examples for each function

Command	Expression examples
"Dial <phone number>"	<i>Phone <phone number>.</i>

■ Command list

Recognizable voice commands and their actions are shown below.

NOTE

- **Some voice commands may not be available depending on the market, vehicle specifications or the device connection status.**
- **Frequently used commands are listed in the following tables.**
- **For devices that are not installed in the vehicle, the related commands will not be displayed on the screen. Also, according to conditions, other commands may not be displayed on the screen.**
- **The functions available may vary according to the system installed.**
- **Voice recognition language can be changed. Refer to "Unit settings" 17.**
- **The notations used in the commands are as follows.**
 - **<OOO>**: Numbers, titles or names to be spoken
 - **(OOO)**: There is no need to speak the command, the voice command system will recognize the content.

▼ Basic command

Voice command	Function
Back	Go back one hierarchy or cancel the voice recognition (voice command top screen)
Help	Ask for help with the current task
Cancel, Close	Cancel the current task
Yes	
No	
Display OFF	Turns the display off
Audio ON	Turns the audio system on
Audio OFF	Turns the audio system off
STARLINK	Switch to APPS mode

▼ Commands for changing the audio mode

Voice command	Function
Change to AM	Switch to AM mode
Change to AM1	Switch to AM mode band 1
Change to AM2	Switch to AM mode band 2
Change to FM	Switch to FM mode
Change to FM1	Switch to FM mode band 1
Change to FM2	Switch to FM mode band 2
Change to FM3	Switch to FM mode band 3
Change to SiriusXM	Switch to XM mode
Change to BT Audio	Switch to Bluetooth Audio mode
Change to CD	Switch to CD mode
Change to USB	Switch to USB mode
Change to iPod	Switch to iPod mode
Change to aha	Switch to aha radio mode
Change to Pandora	Switch to Pandora mode
Change to AUX	Switch to AUX mode

▼ Commands for hands-free phone

Voice command	Function
Dial Number → <0-9, +, *, #> → Change number, Dial	Places a call to the said phone number
Dial <0-9, +, *, #> → Change number, Dial	
Contacts, Phonebook → <Name> → <1-5> → Dial	Make a call by using the phonebook
Call <Name> → <1-5> → Dial	Make a call by using the call history
Call History → Incoming call → Next (page), Previous (page) → <1-5> → Dial	
Incoming Calls	Display the call history screen
Outgoing Calls	Display the call history screen
Redial	Places a call to the phone number of the latest outgoing call
Callback	Places a call to the phone number of the latest incoming call
Select Phone → <1-5>	Display the phone select screen
Phone Menu	Display the hands free top screen

▼ Commands for Pandora

Voice command	Function
Like	Mark "Like" flag
Dislike	Mark "Dislike" flag
Skip, Next	Skip to the next song

▼ Commands for aha

Voice command	Function
Thumbs Up, Heart, Like	Mark "Like" flag
Thumbs Down, Ban, Dislike	Mark "Dislike" flag
Refresh, update	Refresh the selected station to get the latest information
Content Up	Playback next Content
Content Down	Playback previous Content

▼ Commands for AM/FM control

Voice command	Function
Seek Up	Tunes in the higher frequency direction
Seek Down	Tunes in the lower frequency direction
Scan	Switch to the scan mode
Tune to <Frequency>	Designate the frequency to switch to a specific radio station
Preset <preset number>	Designate the preset channel to switch to specific radio station
Tag	iTunes Tagging for HD Radio

▼ Commands for SiriusXM radio control

Voice command	Function
Preset <preset number>	Designate the preset channel to switch to specific radio station
Scan	Switch to the scan mode
Channel <Channel number>	Designate the channel to switch to specific radio station
Category → Next (page), Previous (page), <1-5> → Next (page), Previous (page), <1-5>	Displays the category list screen

▼ Commands for CD control

Voice command	Function
Track Up	Select the next track
Track Down	Select the current track
Scan	Switch to the scan mode
Repeat → 1 Track Repeat, Repeat All	Select a repeat mode
1 Track Repeat	Repeat single track
Repeat All	Repeat all tracks
Shuffle	Plays randomly

▼ Commands for MP3/WMA/AAC, USB control

Voice command	Function
Track Up	Select the next track
Track Down	Select the current track
Folder Up	Plays from the start of the next folder
Folder Down	Plays from the start of the previous folder
Scan	Switch to the scan mode
Repeat → 1 Track Repeat, Repeat Folder, Repeat All	Select a repeat mode
1 Track Repeat	Repeat single track
Repeat Folder	Repeat of the folder
Repeat All	Repeat all tracks
Shuffle → Shuffle Folder, Shuffle All	Select a random play mode
Shuffle Folder	Plays randomly of the folder
Shuffle All	Plays randomly

▼ Commands for iPod Control

Voice command	Function
Track Up	Select the next track
Track Down	Select the current track
Repeat → Repeat One, Repeat All	Select a repeat mode
Repeat One	Repeat single track
Repeat All	Repeat all tracks
Shuffle → Shuffle Track, Shuffle Album, Shuffle OFF	Select a random play mode
Shuffle Track	Shuffle all tracks
Shuffle Album	Shuffle all tracks
Shuffle OFF	Turn off shuffle

▼ Commands for Bluetooth audio control

Voice command	Function
Pause	Pause play
Track Up	Select the next track
Track Down	Select the current track
Repeat → 1 track Repeat, Repeat All, Group Repeat	Select a repeat mode
1 Track Repeat	Repeat single track
Repeat All	Repeat all tracks
Group Repeat	Repeat tracks on group
Shuffle → Shuffle All, Group Shuffle, Shuffle OFF	Select a random play mode
Shuffle All	Shuffle all tracks
Group Shuffle	Shuffle tracks on group
Shuffle OFF	Turn off shuffle

What to do if...

■ Troubleshooting

If there is a problem with the hands-free system or a Bluetooth device, first check the table below.

When using the hands-free system with a Bluetooth device

Symptom	Likely cause	Solution	Page	
			Cell phone	This system
The hands-free system or Bluetooth device does not work.	The connected device may not be a compatible Bluetooth cell phone.	For USA customers, please visit www.subaru.com for details. Outside of the USA customers, contact your local dealer to arrange a demonstration in order to confirm whether or not the device can be paired with the vehicle.	*	—
	The Bluetooth version of the connected cell phone may be older than the specified version.	Use a cell phone with Bluetooth version 1.1 or higher (recommended: Ver. 2.1 + EDR or higher).	*	66

*: For details, refer to the owner's manual that came with the cell phone.

When registering/connecting a cell phone

Symptom	Likely cause	Solution	Page	
			Cell phone	This system
A cell phone cannot be registered.	An incorrect passcode was entered on the cell phone.	Enter the correct passcode on the cell phone.	*	—
	The registration operation has not been completed on the cell phone side.	Complete the registration operation on the cell phone (approve registration on the phone).	*	—
	Old registration information remains on either this system or the cell phone.	Delete the existing registration information from both this system and the cell phone, then register the cell phone you wish to connect to this system.	*	67
A Bluetooth connection cannot be made.	Another Bluetooth device is already connected.	Manually connect the cell phone you wish to use to this system.	—	67
	Bluetooth function is not enabled on the cell phone.	Enable the Bluetooth function on the cell phone.	*	—
	Automatic Bluetooth connection on this system is set to off.	Set automatic Bluetooth connection on this system to on when the ignition switch is turned to the "ACC" or "ON" position.	—	67

*: For details, refer to the owner's manual that came with the cell phone.

When using the phonebook

Symptom	Likely cause	Solution	Page	
			Cell phone	This system
Phonebook data cannot be transferred manually.	The profile version of the connected cell phone may not be compatible with transferring phonebook data.	For USA customers, please visit www.subaru.com for details. Outside of the USA customers, contact your local dealer to arrange a demonstration in order to confirm whether or not the device can be paired with the vehicle.	*	—
	Transfer operation on the cell phone has not completed.	Complete transfer operation on the cell phone (approve transfer operation on the phone).	*	—
Phonebook data cannot be edited.	Editing function is not available on this system.	—	—	77

*: For details, refer to the owner's manual that came with the cell phone.

In other situations

Symptom	Likely cause	Solution	Page	
			Cell phone	This system
Even though all conceivable measures have been taken, the symptom status does not change.	The cell phone is not close enough to this system.	Bring the cell phone closer to this system.	—	—
	The cell phone is the most likely cause of the symptom.	Turn the cell phone off, remove and reinstall the battery pack, and then restart the cell phone.	*	—
		Enable the cell phone's Bluetooth connection.	*	—
		Stop the cell phone's security software and close all applications.	*	—
		Before using an application installed on the cell phone, carefully check its source and how its operation might affect this system.	*	—

*: For details, refer to the owner's manual that came with the cell phone.

Appendix

■ Certification

● Bluetooth

The Bluetooth word mark and logo are registered trademarks of Bluetooth SIG, Inc. and any use of such marks by Clarion Co., Ltd. is under license.



● SiriusXM Satellite Radio (if equipped)

SiriusXM™ and all related marks and logos are trademarks of SiriusXM Radio Inc. All rights reserved.



● Pandora (if equipped)

Pandora, the Pandora logo, and other Pandora marks are trademarks or registered trademarks of Pandora Media, Inc., or its subsidiaries worldwide.

If you have any issues with the Pandora application on your mobile phone, please direct them to pandora-support@pandora.com.

P

● iPod

“Made for iPod” and “Made for iPhone” mean that an electronic accessory has been designed to connect specifically to iPod or iPhone respectively, and has been certified by the developer to meet Apple performance standards. Apple is not responsible for the operation of this device or its compliance with safety and regulatory standards. Please note that the use of this accessory with iPod or iPhone may affect wireless performance.

iPhone, iPod, iPod classic, iPod nano, iPod touch, and iTunes are trademarks of Apple Inc., registered in the U.S. and other countries.



● How to get the source code using the open source

This system implements software using the open source. For customers who would like to get the source code of the software, it is available by downloading it from the web site of Clarion Co., Ltd.

For details, refer to the following web site.

<http://www.clarion.com/us/en/support/index.html>

■ Certification for the Hands-free system

This device complies with Part 15 of FCC Rules and Industry Canada licence-exempt RSS standard(s). Operation is subject to the following two conditions: (1) This device may not cause harmful interference, and (2) this device must accept any interference received, including interference that may cause undesired operation.

Le présent appareil est conforme à la partie 15 des règles de la FCC et CNR d'Industrie Canada applicables aux appareils radio exempts de licence. L'exploitation est autorisée aux deux conditions suivantes : (1) l'appareil ne doit pas produire de brouillage, et (2) l'utilisateur de l'appareil doit accepter tout brouillage radioélectrique subi, même si le brouillage est susceptible d'en compromettre le fonctionnement.

This equipment complies with FCC/IC radiation exposure limits set forth for an uncontrolled environment and meets the FCC radio frequency (RF) Exposure Guidelines in Supplement C to OET65 and RSS-102 of the IC radio frequency

(RF) Exposure rules. This equipment has very low levels of RF energy that it deemed to comply without maximum permissive exposure evaluation (MPE).

Cet équipement est conforme aux limites d'exposition aux rayonnements énoncées pour un environnement non contrôlé et respecte les lignes directrices d'exposition aux fréquences radioélectriques de la FCC dans le Supplément C à OET65 et d'exposition aux fréquences radioélectriques (RF) CNR-102 de l'IC. Cet équipement émet une énergie RF très faible qui est considérée conforme sans évaluation de l'exposition maximale autorisée.

FCC CAUTION

Changes or modifications not expressly approved by the party responsible for compliance could void the user's authority to operate the equipment.

This transmitter must not be co-located or operated in conjunction with any other antenna or transmitter.

■ Certification for Mexico models

IFETEL RCPCLPF14-0253-A5

Clarion PF-3764

La operación de este equipo está sujeta a las siguientes dos condiciones:
(1) es posible que este equipo o dispositivo no cause interferencia perjudicial y
(2) este equipo o dispositivo debe aceptar cualquier interferencia, incluyendo la que pueda causar su operación no deseada.



S01731