

1973 EXT

Model No. 0250-022 (340)
Model No. 0250-024 (440)
Model No. 0250-026 (650)

**OPERATOR'S
MANUAL**



TABLE OF CONTENTS

| | Page | | Page |
|---|---------|---|---------|
| Safety Tips | 1 | Brake | 16 |
| Registration | 2 | Drive Pulley | 16 |
| Supplemental Parts | 2 | Driven Pulley | 17 |
| 340 Specifications | 4 | Drive/Driven Pulley Offset | 17 |
| 440 Specifications | 5 | Drive/Driven Pulley Center Distance | 17 - 18 |
| 650 Specifications | 6 | Drive Chain | 18 - 19 |
| Fuel Mixing | 7 | Drive Belt | 19 |
| Pre-Operating Safety Checks | 8 | Suspension | 19 - 20 |
| Break-In Procedure | 8 | Track Tension | 20 |
| Starting Instructions | 8 - 9 | Track Alignment | 20 - 21 |
| Auxiliary Rope Starting | 9 | Ski Alignment | 21 |
| Maintenance and Adjustments | 10 - 22 | Fuel Filter | 21 - 22 |
| Check Before Each Race | 10 | Spark Plug | 22 |
| Carb., Throttle and Synchronization | 10 - 11 | Trouble Shooting | 23 |
| Carburetion (Fine Tuning) | 11 - 14 | EXT Identification | 24 |
| Carburetor Specifications | 14 | Maintenance Log | 24 |
| Lubrication | 15 - 16 | | |

SAFETY TIPS

1. Before the engine is started the operator should, for safety purposes, wear the prescribed safety clothing and equipment.
2. Before the engine is started, check and insure that the throttle lever is operating properly. A frozen throttle could cause serious bodily injury and/or damage to the snowmobile.
3. After the engine has been started, insure that the emergency shut-off switch located ahead of the right handgrip will operate properly.
4. Never use a match or cigarette lighter to check the fuel level. Do not smoke while refueling.
5. Gasoline is highly flammable. Never mix or add fuel to the fuel tank near any open flame.
6. Forbid inexperienced drivers to operate the machine. To acquaint a new driver with the operation of the machine, reading this manual should be a prerequisite.
7. Mentally prepare yourself for each race. In the event of an emergency, proper reactions should be somewhat automatic.
8. Keep feet, hands, and clothing away from moving parts of the engine and drive train. Keep both feet on the running boards.

REGISTRATION

The EXT carries absolutely no warranty either expressed or implied due to the abnormal usage of the machine.

To assist all EXT owners in the performance area of racing, Arctic Enterprises, Inc. will periodically send Racing News to all EXT owners; an Illustrated Parts Manual will also be sent. To qualify for the factory racing news, the Arctic Cat EXT Registration Card must be completely filled out and sent to the factory for a mailing list. Therefore, at the time of sale, your dealer should complete the Registration Card and insure all information is correct. If you should change your address, please notify the factory as soon as possible.

The engines are manufactured for optimum performance, and therefore, no modification is required.

Racing News will provide each owner with any factory modification, change in specification and other items of general reference that will increase performance levels. If the factory modifies a component, the information will be sent to each registered EXT owner, which will enable the modification to be performed correctly and efficiently.

SUPPLEMENTAL PARTS INCLUDED

| Description | 340 & 440 Quantity | 650 Quantity |
|----------------------|-----------------------|-----------------|
| Cylinder | 2 | 3 |
| Cylinder Gasket | 2 | 3 |
| Cylinder Head | 2 | 3 |
| Cylinder Head Gasket | 2 | 3 |
| Piston Set w/Rings | 2 | 3 |
| Piston Pin Set | 2 | 3 |
| Carburetor Gasket | 2 | 3 |
| Drive Belt | 1 | 1 |
| Spring (Orange) | 1 | 1 |

1973 EXT

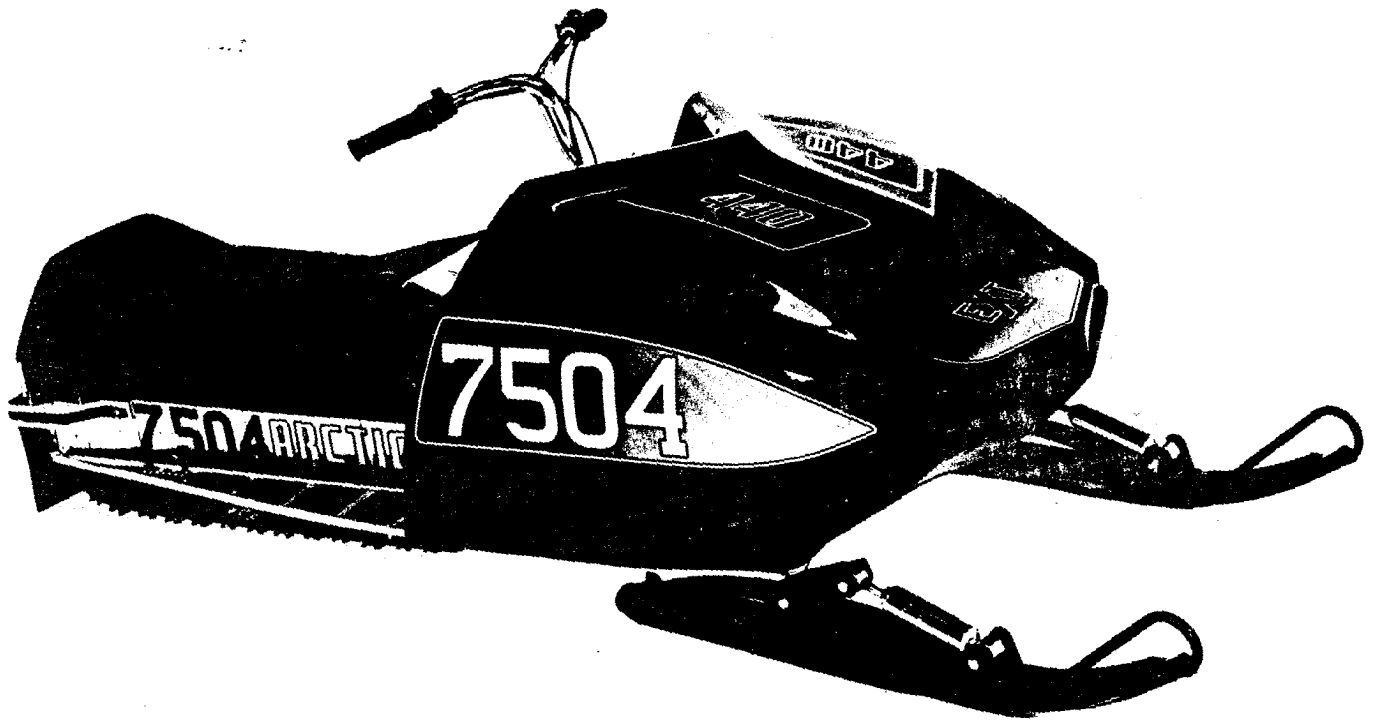

ARCTIC CAT 340 EXT SPECIFICATIONS

ENGINE:

| | |
|---|--------------------------|
| Model | T7A340RX-1 |
| Cylinders | 2 |
| Displacement | 339 cc |
| Bore | 60 mm |
| Stroke | 60 mm |
| Horsepower | 60 + |
| Compression Ratio | 7.5:1 Effective |
| Peak HP R.P.M. | 9500 |
| Piston Clearance | 0.0045 Inch Max. |
| Ring End Gap | 0.006 - 0.012 Inch |
| Timing | Timing Mark on Crankcase |
| Ignition Type | CD |
| Lighting Coil Voltage/Wattage | 12 Volt/100 Watt |
| Spark Plug | NGK B10EV |
| Plug Gap | 0.012 - 0.016 Inch |
| Carburetor | Mikuni VM-36 |
| Fuel Mixture Ratio | 20:1 |
| Cylinder Head Torque | 16 Ft. Lbs. |
| Crankcase Torque | 16 Ft. Lbs. |
| Flywheel Torque | 60 Ft. Lbs. |
| Maximum Engine Operating Temp. | 425 Degrees |

DRIVE PULLEY:

| | |
|--|----------------------------------|
| Model | Kawasaki & Arctic |
| Kawasaki Spring Tension | 45 Lbs. Per Inch |
| Arctic Spring Tension (Green) | 64 Lbs. Per Inch |
| Engagement Speed | 6500 R.P.M. With Gear Reduction |
| Drive Belt Width | 1-1/4 Inch |
| Outside Drive Belt Circumference | 46-7/8 Inches (\pm 3/16 Inch) |

DRIVEN PULLEY:

| | |
|------------------------|-------|
| Model | Comet |
| Spring Color | Red |

DRIVE/DRIVEN PULLEY:

| | |
|-------------------------------------|---------------|
| Center to Center Distance | 11-3/8 Inches |
| Offset | .320 Inch |

GEARING:

| | |
|--------------------------------------|----------|
| With Arctic Drive Pulley | 20T/35T |
| With Kawasaki Drive Pulley | 39T/20T |
| Chain | 70 Pitch |

CHASSIS:

| | |
|----------------------------------|---------------|
| Chassis Material | Aluminum |
| Belly Pan Material | Fiberglass |
| Hood Material | Fiberglass |
| Length W/Skis | 94 Inches |
| Height | 33 Inches |
| Overall Width | 33-1/2 Inches |
| Track Width | 15 Inches |
| Track Length on Ground | 30 Inches |
| Fuel Capacity | 4-1/2 Gallons |
| Chaincase Capacity | 8 Ounces |
| Weight | 285 Pounds |

ARCTIC CAT 440 EXT SPECIFICATIONS

ENGINE:

| | |
|---|--------------------------|
| Model | T7A440RX-1 |
| Cylinders | 2 |
| Displacement | 436 cc |
| Bore | 68 mm |
| Stroke | 60 mm |
| Horsepower | 70 + |
| Compression Ratio | 7.5:1 Effective |
| Peak HP R.P.M. | 8500 |
| Piston Clearance | 0.0048 Inch Max. |
| Ring End Gap | 0.008 - 0.014 Inch |
| Timing | Timing Mark on Crankcase |
| Ignition Type | CD |
| Lighting Coil Voltage/Wattage | 12 Volt/100 Watt |
| Spark Plug | NGK B10EV |
| Plug Gap | 0.012 - 0.016 Inch |
| Carburetor | Mikuni VM-40 |
| Fuel Mixture Ratio | 20:1 |
| Cylinder Head Torque | 16 Ft. Lbs. |
| Crankcase Torque | 16 Ft. Lbs. |
| Flywheel Torque | 60 Ft. Lbs. |
| Maximum Engine Operating Temp. | 425 Degrees |

DRIVE PULLEY:

| | |
|--|---------------------------------|
| Model | Kawasaki & Arctic |
| Kawasaki Spring Tension | 45 Lbs. Per Inch |
| Arctic Spring Tension | 64 Lbs. Per Inch |
| Engagement Speed | 6500 R.P.M. With Gear Reduction |
| Drive Belt Width | 1-1/4 Inch |
| Outside Drive Belt Circumference | 46-7/8 Inches (±3/16 Inch) |

DRIVEN PULLEY:

| | |
|------------------------|-------|
| Model | Comet |
| Spring Color | Red |

DRIVE/DRIVEN PULLEY:

| | |
|-------------------------------------|---------------|
| Center to Center Distance | 11-3/8 Inches |
| Offset | .320 Inch |

GEARING:

| | |
|--------------------------------------|----------|
| With Arctic Drive Pulley | 22T/35T |
| With Kawasaki Drive Pulley | 35T/20T |
| Chain | 60 Pitch |

CHASSIS:

| | |
|----------------------------------|---------------|
| Chassis Material | Aluminum |
| Belly Pan Material | Fiberglass |
| Hood Material | Fiberglass |
| Length W/Skis | 94 Inches |
| Height | 33 Inches |
| Overall Width | 33-1/2 Inches |
| Track Width | 15 Inches |
| Track Length on Ground | 30 Inches |
| Fuel Capacity | 4-1/2 Gallons |
| Chaincase Capacity | 8 Ounces |
| Weight | 285 Pounds |

ARCTIC CAT 650 EXT SPECIFICATIONS

ENGINE:

| | |
|---|--------------------------|
| Model | T8A650RX-1 |
| Cylinders | 3 |
| Displacement | 644 cc |
| Bore | 67.5 mm |
| Stroke | 60 mm |
| Horsepower | 100 + |
| Compression Ratio | 7.4:1 Effective |
| Peak HP R.P.M. | 8500 |
| Piston Clearance | 0.0048 Inch Max. |
| Ring End Gap | 0.008 - 0.014 Inch |
| Timing | Timing Mark on Crankcase |
| Ignition Type | CD |
| Lighting Coil Voltage/Wattage | 12 Volt/35 Watt |
| Spark Plug | NGK B10EV |
| Plug Gap | 0.012 - 0.016 Inch |
| Carburetor | Mikuni VM-40 |
| Fuel Mixture Ratio | 20:1 |
| Cylinder Head Torque | 16 Ft. Lbs. |
| Crankcase Torque | 16 Ft. Lbs. |
| Flywheel Torque | 60 Ft. Lbs. |
| Maximum Engine Operating Temp. | 425 Degrees |

DRIVE PULLEY:

| | |
|--|----------------------------------|
| Model | Kawasaki & Arctic |
| Kawasaki Spring Tension | 45 Lbs. Per Inch |
| Arctic Spring Tension | 64 Lbs. Per Inch |
| Engagement Speed | 5500 R.P.M. |
| Drive Belt Width | 1-1/4 Inch |
| Outside Drive Belt Circumference | 46-7/8 Inches (\pm 3/16 Inch) |

DRIVEN PULLEY:

| | |
|------------------------|-------|
| Model | Comet |
| Spring Color | Red |

DRIVE/DRIVEN PULLEY:

| | |
|-------------------------------------|---------------|
| Center to Center Distance | 11-3/8 Inches |
| Offset | .320 Inch |

GEARING:

| | |
|--------------------------------------|----------|
| With Arctic Drive Pulley | 22T/35T |
| With Kawasaki Drive Pulley | 35T/20T |
| Chain | 68 Pitch |

CHASSIS:

| | |
|----------------------------------|---------------|
| Chassis Material | Aluminum |
| Belly Pan Material | Fiberglass |
| Hood Material | Fiberglass |
| Length W/Skis | 94 Inches |
| Height | 33 Inches |
| Overall Width | 33-1/2 Inches |
| Track Width | 15 Inches |
| Track Length on Ground | 30 Inches |
| Fuel Capacity | 4-1/2 Gallons |
| Chaincase Capacity | 8 Ounces |
| Weight | 315 Pounds |

FUEL MIXING

The correct engine lubricant and fuel mixture is very critical to the performance of the Arctic Cat engine.

A 100% synthetic lubricant developed especially for racing is Arctic Cat Chemilube; it possesses no petroleum oil whatsoever. Because of its superior lubricating characteristics, the bearings, cylinders, pistons and rings are exceptionally well protected. Plug fouling and "load up" on the line are substantially minimized.

Mixing Ratio

▲ WARNING ▲
When mixing gas/oil or when filling the snowmobile fuel tank, do not smoke.

The engine that powers the EXT snowmobile is of the two stroke principle, which requires the lubricating oil to be mixed with the gasoline for lubricating purposes and internal engine cooling.

The correct fuel mixture is five (5) gallons of premium gasoline (97 octane minimum) plus one (1) quart of Arctic Cat Chemilube.

■ Note: The correct fuel mixture ratio is 20:1. Mix twenty (20) parts of a good grade premium gasoline (97 octane minimum) with one (1) part of two cycle air cooled engine oil (Arctic Cat Chemilube). This is equivalent to one (1) quart of lubricant mixed with five (5) gallons of gasoline (97 octane minimum).

CAUTION

The recommended fuel mixture ratio must always be strictly adhered to. A mixture containing an excessive amount of oil will cause extensive carbon formations on the piston, spark plugs, ports and in the exhaust system; resultants are loss of power and pre-ignition. A fuel mixture containing too little oil will cause overheating; resultants may be piston seizure and possible rod and bearing failure.

Mixing Procedure

■ Note: Gasoline and oil will not mix well in extremely cold temperatures, therefore, it is recommended that the oil be at room temperature (70°) when mixing.

1. Add 2-1/2 gallons of gasoline to a clean gasoline container.
2. Add the recommended amount of oil (1 quart) and shake the mixture well.
3. Add an additional 2-1/2 gallons of gasoline and again, shake the mixture well.

When filling the EXT fuel tank, use a funnel with a fine mesh screen to prevent the entry of dirt or other foreign particles into the fuel system.

■ Note: When using a gas/oil mixture that has been setting for some time (settling of oil may have occurred), shake the mixture before filling the fuel tank.

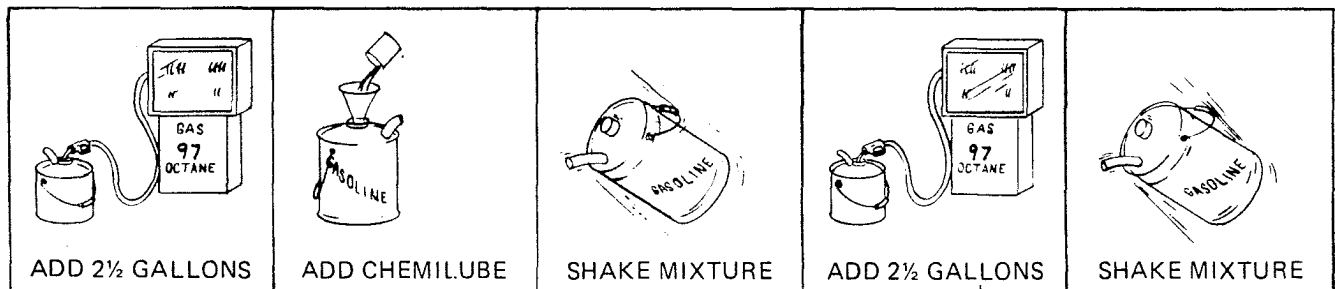

PRE-OPERATING SAFETY CHECKS

1. Check the cooling system. Insure the cooling fins are clean and free from obstructions.
2. Insure the exhaust system and carburetors are securely fastened.
3. Check the operation of the throttle control. The throttle control should depress without excessive effort and return freely to the idle position. Insure the emergency shut-off switch is operating properly.
4. Check the brake control. The brake should fully engage when the brake lever is depressed approximately 3/4" and disengage freely when released. If more than 3/4" of brake lever travel is necessary to engage the brake, or if the brake lever bottoms on the handle control, an adjustment is necessary.
5. Check the steering to insure the skis turn freely. If difficulty is encountered in turning the skis, remove ice or snow from around the steering mechanism.
6. Check the machine fuel supply. Carry just enough fuel to complete a race, but always have a minimum of one (1) gallon remain in the tank after completion of race. Excess fuel will add weight, and consequently, retard the performance of the machine during a race.
7. Insure that all nuts and bolts are properly torqued. A loose nut or bolt may cause bodily injury or serious damage to the machine.
8. When the machine is operated in extremely cold weather or under slushy conditions, prop the back end of the machine up on a quick-jack and open the throttle slightly, allowing the track to turn several revolutions. This rotation will allow the track to clear itself, and provide the bearings, track and drive belt proper "warm-up" before subjecting them to full load under race conditions.

WARNING

Do not allow anyone to stand to the front or to the rear of the machine or hold up the rear of the machine when either "warming up" or "clearing" the track.

BREAK-IN PROCEDURE

Strict adherence to the following break-in procedure will contribute to the optimum life of the engine.

Note: Do not alter the gas/oil mixture during the break-in period (5 operating hours).

For the first five (5) operating hours (approximately one tank of fuel), the engine should not be

subjected to heavy lugging or prolonged full throttle operation. During break-in, a maximum of three-fourths throttle is recommended. Vary the operating speeds but DO NOT subject the engine to constant speed operation for a prolonged time.

After the break-in, check the entire machine for proper operation.

STARTING INSTRUCTIONS

TO START:

WARNING

Never allow anyone to stand in front of the machine when starting or when the engine is running.

1. Insure all Pre-Operating Safety Checks have been satisfactorily carried out.
2. Position the emergency shut-off switch (A) in the ON position.

STARTING INSTRUCTIONS

3. Make sure the tether pin (B) is inserted in the tether switch.

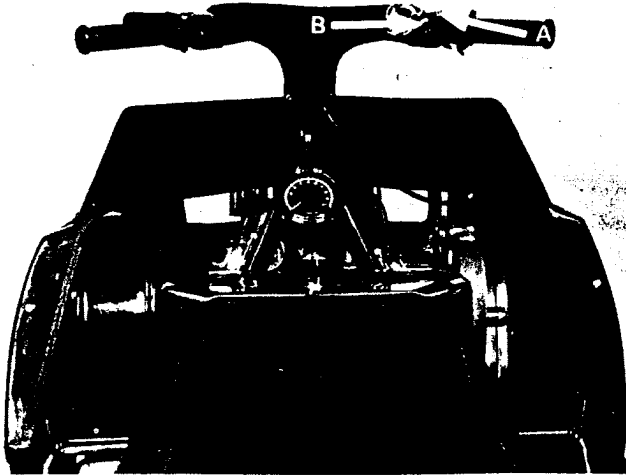

4. Pull the starter plunger (C) on both carburetors fully upward. DO NOT HOLD THROTTLE OPEN WHEN STARTING.



Note: The engine will not start if the throttle is held slightly open when the starter plunger is actuated (upward position). If the throttle is opened, the carburetors starting systems will be bypassed and an insufficient amount of fuel will not allow the engine to start.

5. Grasp recoil starter handle (D) and pull slowly until recoil mechanism engages. Upon engagement, give a short, quick pull.

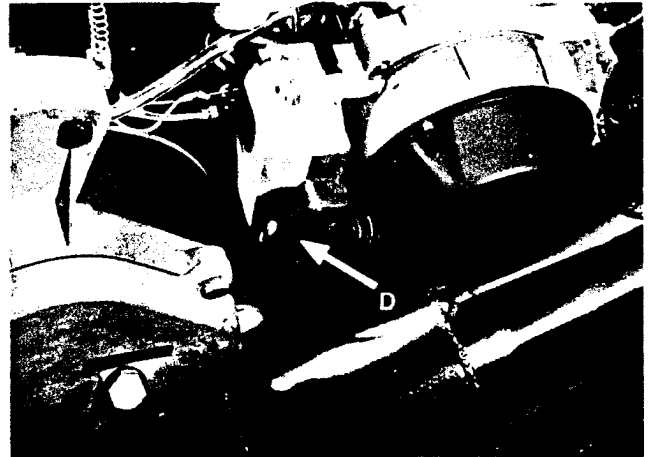

CAUTION

To avoid damaging the recoil starter mechanism, **DO NOT** pull the recoil rope to its limit or release rope from an extended position.

6. When the engine starts, immediately compress the throttle and rev the engine to a fast idle (approximately 3000 RPM) for "warm-up".
7. Allow a cold engine to idle ("warm-up") for approximately thirty (30) seconds before operating the machine. Push both starter plungers fully downward after the "warm-up".

CAUTION

Idling of a warm engine for more than thirty (30) seconds may cause excessive carbon formations, plug fouling and flooding. Placing a cold engine under heavy load conditions (high RPM) may cause damage to the pistons and cylinders.

AUXILIARY ROPE STARTING

The Arctic Cat engine used in the EXT is equipped with an auxiliary starting pulley, accessible by removing the recoil starter should a failure occur. The starting rope is located in the tool pouch; keep the rope with the machine at all times.

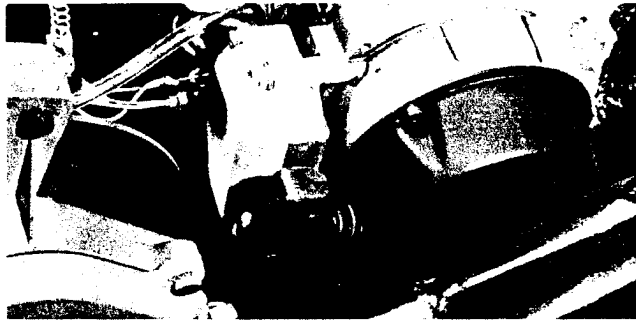

MAINTENANCE AND ADJUSTMENTS

Check Before Each Race

Improper maintenance may lead to costly repairs, or a major breakdown. The following items should be checked or serviced before each race: A) Drive Belt; B) Drive/Driven Pulley Offset; C) Drive/Driven Pulley Center to Center Distance; D) Track; E) Suspension; F) Brake; G) Electrical Connections; H) Carburetion; I) Oil Level in Gear Reduction Case and J) Proper Nut and Bolt Torque.

Carburetor, Throttle and Synchronization Adjustment

The engine used in the EXT employs Mikuni carburetors for precise fuel/air mixture metering. The Mikuni carburetor is built with a fixed main jet, and therefore, no high speed adjustment is necessary. To insure optimum engine performance, both carburetors must be equally adjusted (SYNCHRONIZED).

1. Open the hood.
2. Rotate the idle adjusting screws (A) counterclockwise until the idle adjusting screw tip is flush with the side of the carburetor bore.
3. Loosen the jam nuts (B) on both throttle cables and rotate the swivel adapter until the throttle slide fully seats in the recess of the carburetor bore. Lock the jam nuts and swivel adapter into position.

Rotate both idle adjusting screws (A) clockwise until the screws contact the throttle slide. At that instant, the throttle slide will begin to rise.

5. Rotate the idle adjusting screws (A) an additional two (2) turns clockwise.

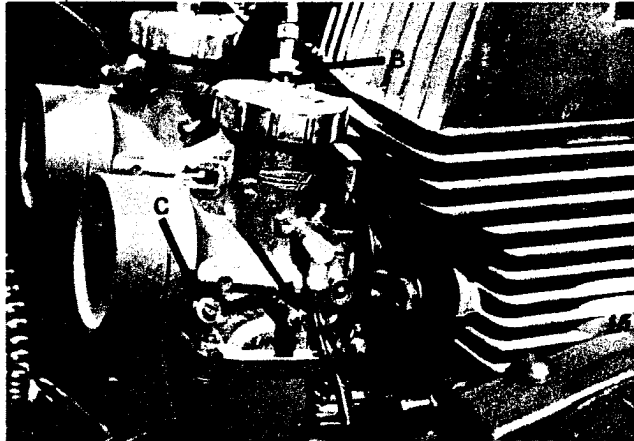

6. Loosen the jam nuts (B) on both throttle cables and rotate the swivel adapter counterclockwise until all slack has been removed from the throttle cable. Lock the jam nuts and swivel adapter into position.
7. Look into the throat of all carburetors and slowly compress the handlebar-mounted throttle lever. All throttle slides must begin to rise at precisely the same instant. If throttle slide movement does not occur as specified, repeat steps 2 - 6.
8. Carefully rotate both pilot air screws (C) clockwise until a slight seating resistance is felt.
9. Rotate both pilot air screws (C) one (1) revolution counterclockwise.

MAINTENANCE AND ADJUSTMENTS

10. The idle speed may not be suitable for normal operation, even though the carburetors are synchronized. To check the engine for proper idle, proceed as follows:

- A. Run the engine until normal engine operating temperature is achieved.
- B. If the engine will not idle or if a higher idle RPM is desired, rotate the idle adjusting screws (A) clockwise until the desired idle is obtained.

Note: Set both idle adjusting screws (A) equally. If the idle adjusting screws are not adjusted equally, it will be necessary to repeat steps 2 - 8.

11. Close the hood.

Carburetion (Fine Tuning)

1. CHECK FLOAT LEVEL — The fuel level in the float chamber is governed by the projection of the two float arms. If there is dirt between the needle valve and seat preventing the valve from closing, if there is wear or damage in the needle valve area or if the float(s) is punctured, fuel overflow may occur. Conversely, if the needle sticks to the seat, a very limited amount of fuel will flow into the float chamber.

- A. Remove the float chamber body and gasket from the main body of the carburetor and invert the carburetor.
- B. Measure the distance (D) from the gasket surface to the top edge of the float arm. For the Mikuni VM-36 carburetor, the distance should be .693 inch or 17.8mm; for a VM-40 carburetor, the distance should be .693 inch or 17.8mm. When an adjustment of the float arm is necessary, bend only the float arm actuating tab.

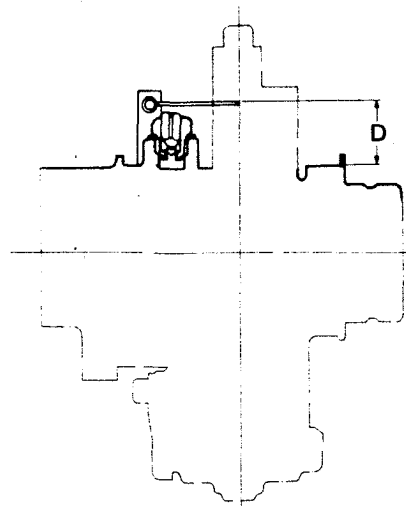

2. SELECT MAIN JET — Main jets for the EXT will have an approximate graduated range from 370 to 390. In this graduated range, main jet sizes are increased in steps of ten: 370, 380 and 390. The larger the number, the greater diameter of the jet orifice and as a result, a richer fuel/air mixture.

- A. Run the machine on a flat hard-packed area at full throttle. If the engine drags, or labors at full throttle, the main jet orifice (size) is too large. To remedy, install the next smaller size jet and repeat full throttle operation on a flat hard-packed area. Continue changing jets until the engine runs efficiently at full throttle as explained previously. Check the condition of the spark plug (see Spark Plug, page 22).
- B. If the engine runs efficiently at full throttle to begin with, the jet should still be checked for proper size; the jet may be contributing to a lean condition. If this condition does exist, install a main jet which is two sizes larger. Run the machine on a flat hard-packed area; when the engine drags, use the next lower sized main jet. Engine should now operate efficiently. Check the condition of the spark plug (see Spark Plug, page 22).

MAINTENANCE AND ADJUSTMENTS

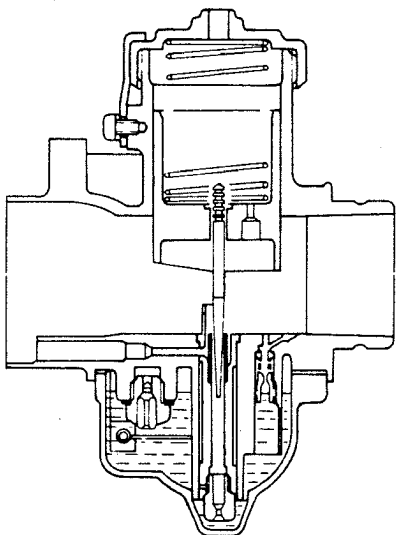

3. **ADJUST PILOT AIR SCREW (A)** – Throttle slide must be resting against the idle speed adjusting screw before any adjustment is initiated. Observe this condition by looking into the bore of the carburetor.

- A. Prop the back end of the machine up on a Quick Jac and start the engine.
- B. Slowly rotate the idle speed adjusting screw (B) in until the engine begins to idle faster.
- C. Slowly back the idle speed adjusting screw (B) out until the engine begins to die out.
- D. Rotate the pilot air screw (A) in or out until the engine runs smoothly.

■ **Note:** Rotating the pilot air screw in will richen the fuel/air mixture and rotating out will lean the fuel/air mixture.

- E. Perform steps C, D and E until the proper engine idle speed is attained.



F. Shut the engine off.

G. When the desired idle speed has been attained, cautiously rotate the pilot air screw in and at the same time, count the number of turns required to seat the screw.



DO NOT force the pilot air screw; doing so may cause damage to the screw or seat.

H. The pilot air screw adjustment should range from 1 to 2-1/2 turns out from the full seated position.

I. If it takes 1 turn or less, the pilot jet is too small and must be replaced by a larger pilot jet. If it takes 2-1/2 turns or more, the pilot jet is too large and must be replaced by a smaller pilot jet.

■ **Note:** Pilot jets will have an approximate graduated range from 30 to 35. In this graduated range, pilot jet sizes are increased in steps of five: 25, 30 and 35. The larger the number, the greater diameter of the jet orifice and as a result, a richer fuel/air mixture.

J. The engine may idle smoothly without the pilot air screw in the 1 to 2-1/2 turn range but smooth acceleration will not be evident during mid-range operation.

4. **THROTTLE SLIDE CUT - AWAY** – The amount of throttle slide cut-away affects the fuel/air mixture from 0 to 1/4 throttle slide movement. Throttle slides are stamped with a number (1.5, 2.0, 2.5, 3.0, 3.5, etc.); these numbers reflect the degree of cut-away. The larger the number, the greater portion of throttle slide cut-away, which results in a leaner initial fuel-air mixture.

MAINTENANCE AND ADJUSTMENTS

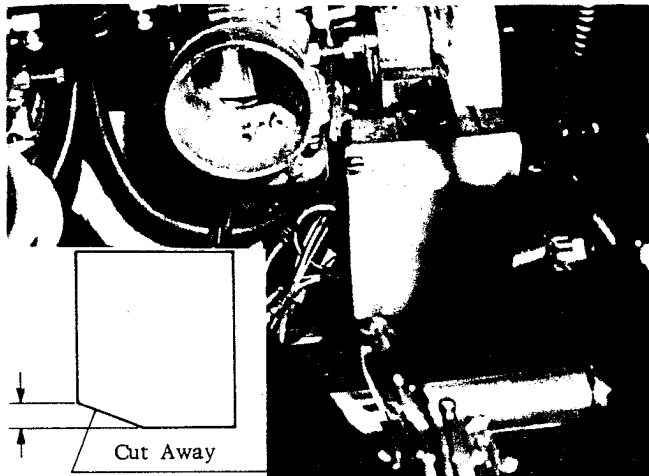

- A. Start the engine. From an idle, accelerate to 1/4 throttle. If the engine hesitates or if "spit back" occurs, a lean condition exists (throttle slide cut-away too large).
- B. Conversely, if the engine drags or four-cycles while accelerating to 1/4 throttle, a rich condition exists (throttle slide cut-away too small). When this condition exists, rotate the pilot air screw 1 turn (maximum) out. If this adjustment does not correct the condition, the next larger numbered throttle slide should be installed.

5. **NEEDLE SELECTION** — The needle can be set in one of five different positions by moving the needle clip to a different groove. For fine tuning purposes, number the grooves from 1 - 5, starting from the top groove down. The number 1 groove gives the leanest setting, whereas the number 5 groove gives the richest setting.

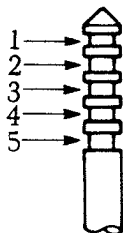

The needle is stamped with a number and letter series for a certain specific measurement such as 4GL3.

- A. **FIRST NUMBER** — Designates the total length of the needle. The larger the number, the longer the needle. The four stands for 40mm long but not to exceed 50mm.
- B. **LETTERS** — The amount of taper and degree of richness is depicted by the two letters. The needle is tapered in graduated steps. The first letter indicates the upper taper angle and the second letter indicates the lower taper angle. As an example, the letter "A" equals $0^{\circ}15'$; each successive letter is a greater angle by $15'$. "G"= $1^{\circ}45'$ and "L"= $3^{\circ}00'$.

A "G" needle will have more taper than an "F" needle, and therefore provides a richer fuel/air mixture through mid-range operation.

- C. **SECOND NUMBER** — Indicates the manufacturer lot number and will vary with different needles.
6. **NEEDLE JET** — The needle jet comes in various sizes and works in direct relation with the needle. The needle jet orifice diameter remains constant through the entire length of the jet, and therefore, changing the needle jet will have a greater affect on mid-range operation than a groove change on the needle.

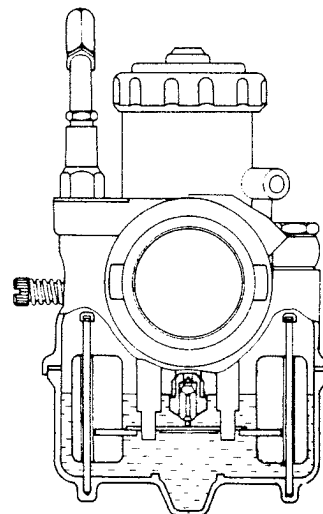

MAINTENANCE AND ADJUSTMENTS

The needle jets have a stamped letter followed by a number, such as N3 or O2. Each letter is graduated in increments of ten digits. i.e. N0, N1, N2, N3, N4, N5, N6, N7, N8, N9, O0, O1, O2, O3 and O4 etc.

- A. LETTER — Designates the orifice size, which means that an "O" needle jet provides a richer fuel/air mixture than a "N" needle jet.
- B. NUMBER — Relates the specific diameter of the needle jet. For example, N2 means the inside diameter of the needle jet is 2.560mm.

- 7. MID-RANGE TUNING — Fine tuning the mid-range is similar to tuning the main jet. For example, use a rich needle position and a rich needle jet until four-cycling is evident. When the four-cycling affect exists, install the next leaner needle or needle jet to assure the proper fuel/air mixture is obtained.

Note: All the adjustments mentioned previously will overlap into the next graduated range, which is necessary to provide smooth acceleration. A main jet change will affect the mid-range operation by approximately 10%. If a one groove needle change is made, it will affect the main jet by approximately 10%.

| | 0 | 1 | 2 | 3 | 9 |
|---|-------|-------|-------|-------|-------|
| N | 2.550 | 2.555 | 2.560 | 2.565 | 2.595 |
| O | 2.600 | 2.605 | 2.610 | 2.615 | 2.645 |
| P | 2.650 | 2.655 | 2.660 | 2.665 | 2.695 |

CARBURETOR SPECIFICATIONS

(Factory Equipped)

| Engine Model | 340 | 440 | 650 |
|--------------------|--------|--------|--------|
| 1. Carburetor Type | VM36 | VM40 | VM40 |
| 2. Main Jet | 380 | 380 | 380 |
| 3. Air Jet | 2.0 | — | — |
| 4. Jet Needle | 6DH4-3 | 7DH2-3 | 7DH2-3 |
| 5. Needle Jet | Q-5 | AA-5 | AA-5 |
| 6. Slide | 2.0 | 1.5 | 1.5 |
| 7. Pilot Jet | 35 | 30 | 30 |
| 8. Bypass Hole | 1.4 | 1.4 | 1.4 |
| 9. Pilot Outlet | 0.6 | 0.8 | 0.8 |
| 10. Air Screw | 1.0 | 1.0 | 1.0 |
| 11. Inlet Seat | 1.5 | 1.5 | 1.5 |
| 12. Starter Jet | 1.5 | 1.5 | 1.5 |
| 13. Fuel Level | 33.0 | 37.0 | 37.0 |
| 14. Bypass Pitch | 3.8 | 4.5 | 4.5 |
| 15. Pump | DF52 | DF52 | DF52 |

MAINTENANCE AND ADJUSTMENTS

Lubrication

The oil bath chaincase, gear reduction case, driven pulley and rear suspension arms must be properly lubricated to insure efficient operation.

▲ WARNING ▲

Engine must not be running when performing the following maintenance on the machine.

1. Oil Bath Chaincase — The lubricating oil should be checked at the check plug (A) before every day of racing. The lubricant level should be at the point of overflowing in the check plug hole. If lubricant is low, add Arctic Chainlube through the filler hole (B). When lubricant is at the point of overflowing in the check plug hole (A), install both plugs.

Note: If oil deposits are observed in the belly pan, check the chaincase gasket for deterioration. If chaincase gasket is suitable, check the sealing capacity of the driven shaft bearing and "O" ring. Replace components as conditions dictate.

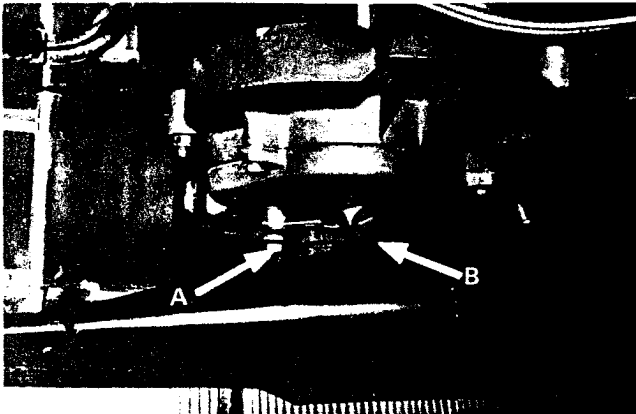

2. Gear Reduction Case — The lubricant in the gear reduction case should be checked at the filler plug (C) prior to every day of racing. The lubricant level should be at the point of overflowing in the filler plug hole. If the lubricant is low, add Hypoid No. 90 low temperature lubricant. The lubricant in the gear reduction case should be changed after every five (5) operating hours. A drain plug is located at the bottom of the gear reduction case for drainage purposes.

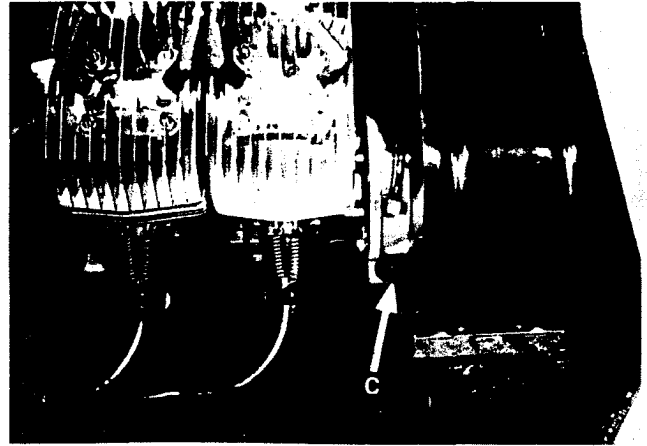

3. Driven Pulley — Lubricate the driven pulley assembly each month by using the following procedure.

- A. Remove the drive belt (see Drive Belt, To Remove, page 19).
- B. Open the pulley by pushing and rotating the movable face toward the inside of the machine.

Note: It will be necessary to insert an object between the fixed and movable face to insure the faces remain open.

- C. Apply a thin coat of low-temperature grease (Texaco 2346EP or equivalent) on the pulley hub (D). Work the movable face open and closed several times to distribute the lubricant over the entire pulley hub. Lubricate the bearing fitting (E) with the same low-temperature grease.

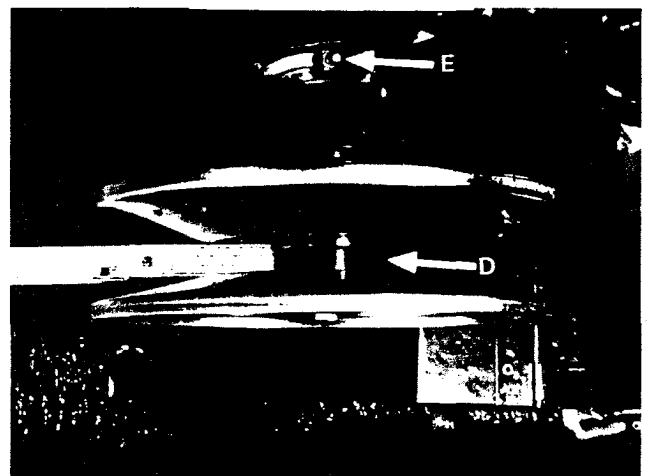

MAINTENANCE AND ADJUSTMENTS

- D. Using a clean rag, wipe off any excess lubricant from the hub, fixed face, movable face, and the grease fitting.

Note: Excessive lubricant on the pulley hub will be thrown onto the drive belt by centrifugal force, causing belt slippage and deterioration.

- E. Replace the drive belt (see Drive Belt, To Install, page 19).

4. Rear Suspension Arms — Lubricate the rear suspension arms (A) before each day of racing with low-temperature grease (Texaco 2346EP or equivalent).

Note: Due to the position of the suspension arm grease fitting it is recommended that a flexible hose grease gun be used for this lubricating purpose.

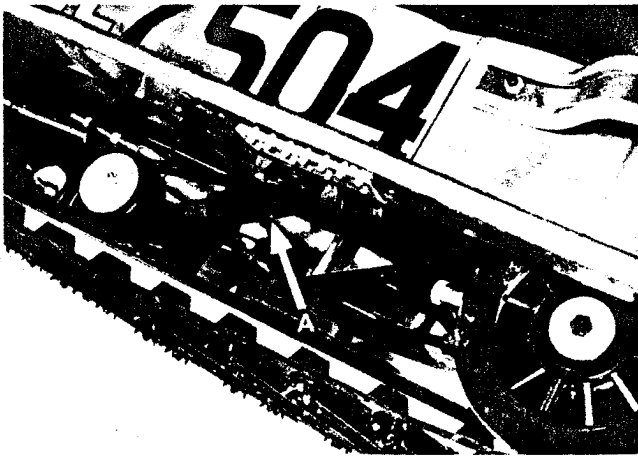

Brake

The brake used on the 1973 EXT is a non-assisted disc brake mounted on the driven shaft, which is actuated by compressing the lever mounted on the left handlegrip. This brake provides excellent braking capabilities for the machine during racing situations. Prior to each day of racing, the brake should be checked. The brake is properly adjusted when the brake lever has approximately 3/4 inch free travel from the end of the lever to the handlegrip.

TO ADJUST:

1. Remove the cotter pin (B).
2. Rotate the locknut (C) until proper adjustment is obtained.

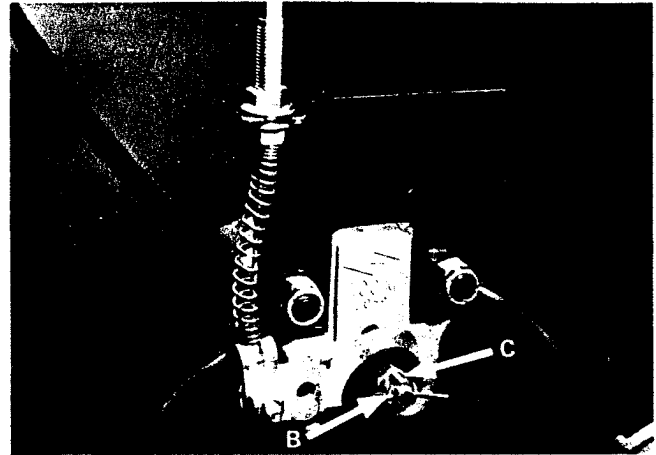

Drive Pulley (Arctic)

The drive pulley is a torque sensing, RPM type drive mechanism designed to transfer peak horsepower from the engine to the track. The spring and weights inside the drive pulley react with each other to overcome the centrifugal force applied to it by the engine RPM's. The primary function of the spring is to resist the force of the weights for engagement purposes.

Operating Characteristics

1. If the weights are too light the drive pulley will generally engage fairly well . . . Immediate high RPM will be obtained but the belt will not ride to the top of the pulley, and therefore, optimum power transfer will not be accomplished soon enough. A flat spot during acceleration will be evident.
2. If the weights are too heavy, the drive pulley will engage properly but a high ratio will be obtained because the engine RPM's are low. The RPM's will gradually increase to peak power transfer. The condition will be evident by a flat spot during acceleration.
3. When the weights and springs are properly matched, the drive pulley will engage properly and accelerate smoothly. Top speed should be reached at the end of an oval track, whereupon deceleration occurs resulting in a lower drive ratio. After the corner has been negotiated, smooth acceleration again should take place until the end of the next straight-away.

MAINTENANCE AND ADJUSTMENTS

Driven Pulley

The driven pulley is relatively maintenance free. The driven pulley should be visually inspected each week for damage, cracks and belt build-up on the driven pulley hub. The driven pulley is adjustable by means of a tension spring attached to a movable plate. Increasing the spring tension will retard shifting to a higher ratio. Decreasing the spring tension will facilitate shifting into a higher ratio.

TO ADJUST:

1. Place the end of a snug fitting punch in one of the movable plate holes.
2. While exerting pressure on the punch, place a screwdriver behind the movable plate and carefully pry it toward the driven pulley until the plate becomes disengaged. Keep movable plate in the disengaged position.

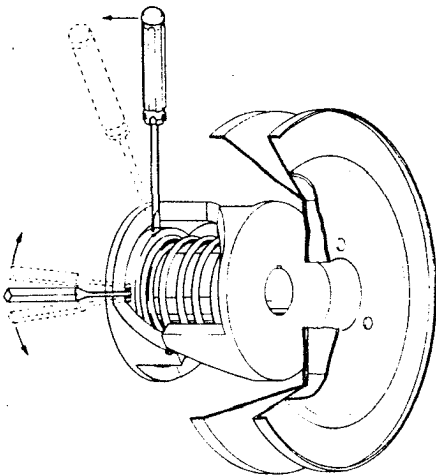

CAUTION

Constant pressure must be exerted on the punch to prevent a sudden uncoiling of the spring. Failure to comply may cause damage to various components.

3. By exerting pressure on the punch, rotate the movable plate clockwise to increase spring tension. Rotate counterclockwise to decrease spring tension.
4. Slowly remove the screwdriver and allow the movable plate to securely seat itself. Release pressure on the punch.

Drive/Driven Pulley Offset

To assure optimum power transfer, the offset must be .320 inch. The offset is changed by moving the flatwashers located to the inside of the driven pulley movable face.

Note: If a flatwasher is removed from the inside of the driven pulley, it must be installed on the outside (fixed face) of the driven pulley. This procedure must be followed to maintain proper driven shaft end-play.

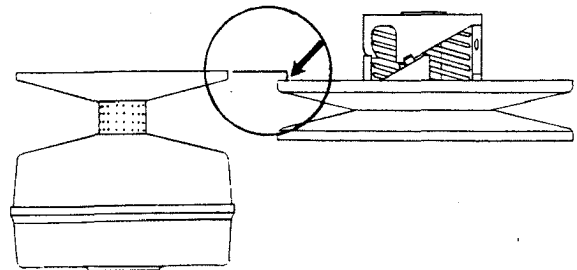

1. Remove the capscrew and flatwasher(s) that secure the driven pulley to the driven shaft.
2. Move the required number of flatwashers to the proper end of the driven pulley to obtain the recommended offset (.320 inch).
3. Secure the driven pulley to the driven shaft with the capscrew and flatwasher(s).

Note: Check the offset before each day of racing or when a new drive belt is installed.

Drive/Driven Pulley Center Distance

The correct center to center distance between the drive and driven pulley is 11-3/8 inches. The measurement should be taken from the center of the drive pulley bolt to the center of the driven pulley bolt. The motor plate is slotted to accurately obtain the specified center to center distance.

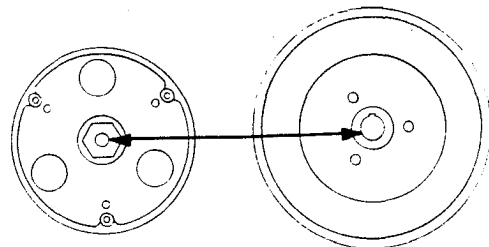

MAINTENANCE AND ADJUSTMENTS

TO ADJUST:

1. Loosen the nuts securing the engine and engine plate to the rubber engine mounts.
2. Slide the engine and engine plate in the proper direction to obtain the specified center to center distance (11-3/8 inches).

Note: When the adjustment is being performed, always keep the crankshaft parallel with the driven shaft. Doing so will insure proper alignment.

3. Secure the engine and engine plate in position by tightening the engine mount nuts.

Note: Check the center to center distance before each day of racing or when a new drive belt is installed.

Drive Chain

The drive chain must always be immersed in oil to provide proper lubricating qualities; check this condition before each day of racing. The oil level in the oil bath chaincase must always be at the point of overflowing in the check plug hole (see Lubrication, Oil Bath Chaincase, page 15). To eliminate constant adjustments the drive chain is controlled by an automatic chain tensioner.

TO CHECK CHAIN TENSION:

Check the drive chain tension prior to each day of racing.

1. Rotate the brake disc toward the rear of the machine until all free play has been removed.
2. Mark the top surface of the brake disc directly below the center of the brake bracket casting mount.
3. Rotate the brake disc forward until the free play has been eliminated.
4. Distance (A) from the mark on the top surface of the brake disc to the brake bracket casting mount should be from 1/8 to 1/4 inch.
5. If tension is not as specified, see To Adjust Chain Tension, page 18.

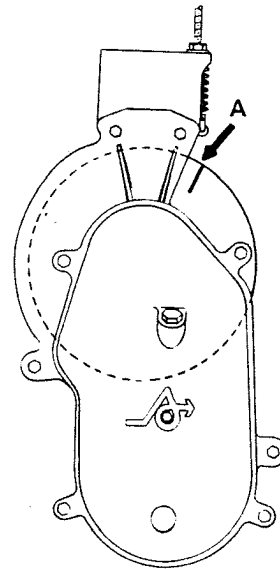

TO ADJUST CHAIN TENSION:

Proper chain tension is conducive to both chain and sprocket durability. If the drive chain rattles in the chaincase, if chain slippage is evident or if abnormal vibration occurs, an inspection of the drive chain tensioners is necessary.

1. Place rags in the belly pan, just below the chaincase.
2. Remove the capscrews and star washers securing the chaincase cover to the chaincase. Remove the chaincase cover and allow the chaincase lubricant to flow into the rags in the belly pan.

Note: Do not damage the chaincase gasket when removing the chaincase cover.

3. Examine the chain tensioner shoes and spring for wear, deterioration and breakage. Replace these components as conditions dictate.

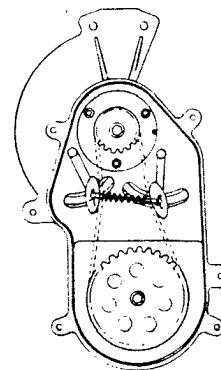

MAINTENANCE AND ADJUSTMENTS

4. Install the chaincase cover to the chaincase and secure in place with the capscrews and star washers.

Note: Insure a good seal is obtained between the chaincase cover, gasket and chaincase.

5. Remove the chaincase filler plug and the check plug. Slowly pour Arctic Chainlube through the upper filler hole until the level is at the point of overflowing in the check plug hole.
6. Replace the check plug and the filler plug.

Drive Belt

Before each race or heat, examine the condition of the drive belt. The drive belt should always be in excellent condition. The drive belt width is 1-1/4 inch as supplied from the factory. The outside circumference of the drive belt should measure 46-7/8 inches with a tolerance of $\pm 3/16$ inch. When the width has decreased to approximately 1-1/8 inch, if the belt has stretched, if otherwise damaged or if slippage occurs, the drive belt should be replaced.

Note: To insure optimum power transfer, drive belt must be kept free of dirt, oil, grease, gasoline and moisture, whether being used or while in storage.

TO REMOVE:

1. Open the hood.
2. Disengage the pulley guard and pivot the guard toward the front of the machine to provide access to the drive/driven pulley and the drive belt.
3. Rotate and pull the movable face of the driven pulley toward the inside of the machine. Grasp the drive belt, pull upward and rotate the drive belt over the top of the driven pulley fixed face. Carefully release the movable face.



4. When the drive belt is free of the driven pulley, slide the drive belt off the drive pulley.

WARNING

DO NOT attempt to start or run the engine with the drive belt removed. Damage to engine and drive pulley may result. Drive pulley may "blow", resulting in various components being forcefully thrown causing bodily injury if somebody is hit.

TO INSTALL:

1. Position the drive belt in the drive pulley.
2. Rotate and pull the movable face of the driven pulley toward the inside of the machine. Grasp the drive belt and position it on the bottom surface of the driven pulley fixed face. Pull the drive belt to the inside of the driven pulley and continue to rotate the belt forward and over the fixed face.
3. Slowly release the fixed face.

Suspension

The machine is equipped with a slide rail type suspension system. The suspension should be adjusted for the weight of the operator and the condition of the racing track surface. Always adjust the front and rear spring to cope with existing conditions. The front and rear springs serve two distinct purposes and possess certain operating characteristics when adjusted differently. Rear Springs — should be adjusted to support

MAINTENANCE AND ADJUSTMENTS

the rider without bottoming but soft enough to give a good ride. Front Springs — should be adjusted for the racing track conditions (hard-pack or soft snow). Hard Pack Track Condition — The adjusting bolts should be tightened to maintain maximum machine track surface on the racing track. Soft Snow Track Condition — The adjusting bolts should be loosened to allow the track to propel itself and remain on top of the snow.

Note: Always adjust the front and rear adjusting bolts equally.

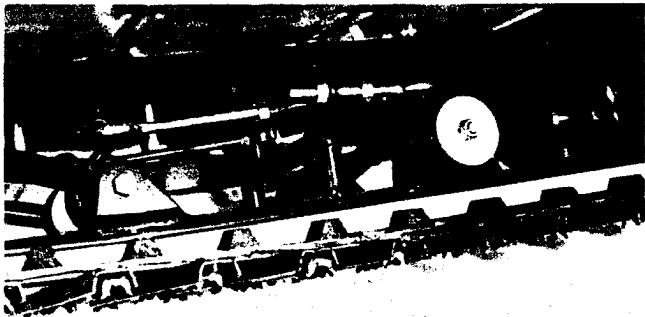

Track Tension

Proper track tension is essential to winning races. If the track is too loose it could possibly scrape the inside top of the body tunnel causing damage to both the chassis and cleated track. If the track is too tight, increased pressure will be exerted on the slide rail hi-fax strips, resulting in a substantial performance loss. Desired distance between the track and the bottom of the slide rail should be from 1 - 1-1/4 inch at mid-span.

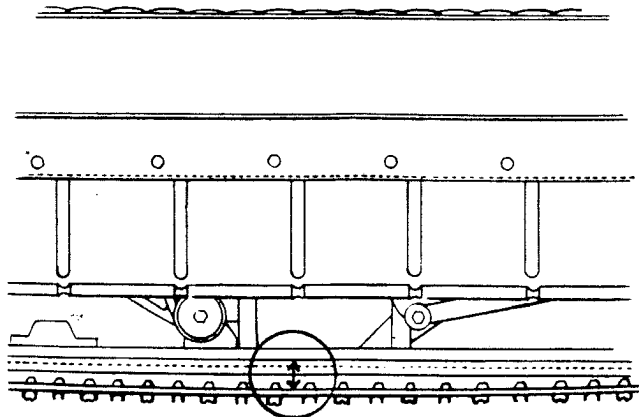

TO ADJUST:

1. Support the rear of the machine off the ground and make sure the entire track is free to turn.
2. Measure the distance between the track and the bottom of the slide rail.
3. Rotate track tension adjusting bolts clockwise to tighten the track tension and counterclockwise to relax the track tension.



4. Whenever the track tension is adjusted the track alignment must be checked (see Track Alignment, page 20). Track tension and track alignment adjustment have a direct affect on each other.

Track Alignment

The track is a molded full-length aluminum cleat design. The total weight is considerably lower with this type of track. Track alignment should be checked prior to each race. The track should be centered between the sides of the body tunnel.

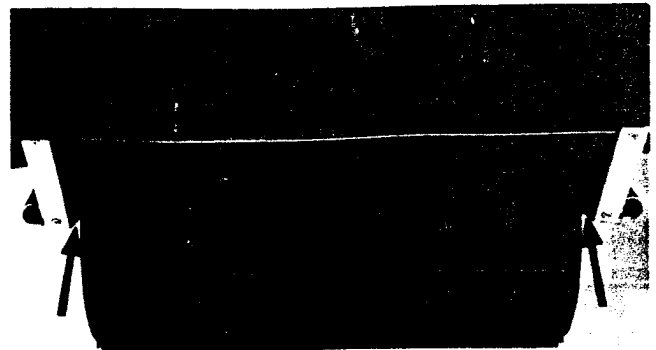

MAINTENANCE AND ADJUSTMENTS

TO ADJUST:

1. Support the rear of the machine with a Quik Jac and insure the entire track is off the ground and free to turn.
2. Start the engine, accelerate slightly to turn the track several revolutions and SHUT ENGINE OFF. Allow the track to stop rotating by itself; do not actuate the brake.
3. Note whether the track has moved to either side.
4. If the track runs to the left or right, tighten the appropriate track tension bolt until the track is centered between the rear of the body tunnel.



5. Whenever the track alignment is adjusted, the track tension must be checked (see Track Tension, page 20). Track alignment and track tension adjustment have a direct effect on each other.

Ski Alignment

The machine is equipped with carbide skags which enhance the high speed handling characteristics that are necessary during a race. Proper alignment of the skis is essential to winning a race and also for the safety of the operator. Proper ski-alignment is when the skis are PARALLEL. Absolutely no "toe-in" or "toe-out" should be evident.

TO ADJUST SKIS:

1. Measure the distance between the skis at the front and rear spring mounts.

2. Loosen the locknuts on both ends of the tie rods.
3. Pull both ski tips outward and rotate the tie rods until a parallel alignment is obtained.

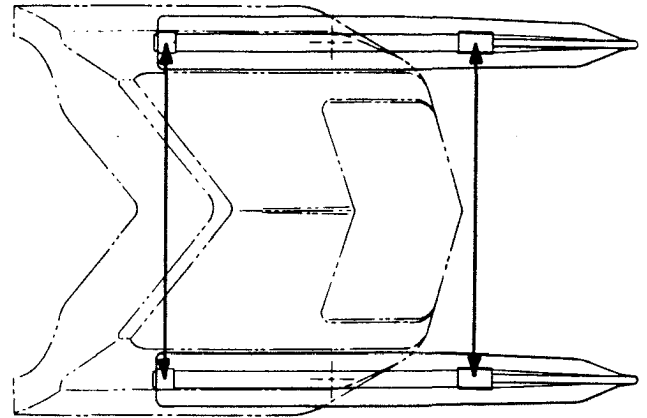

4. Secure the locknuts in place

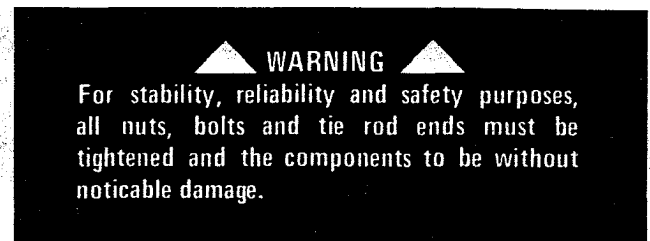

Fuel Filter

The 1973 EXT snowmobile is equipped with a brass screen fuel filter located inside the fuel tank. To examine the condition of the fuel filter, proceed as follows:

1. Form a hook on the end of a piece of stiff wire.
2. Remove the gas cap, insert hook through the filler hole, and hook the gas tank hose.
3. Carefully pull the hose and filter assembly up through the filler hole.
4. If filter is dirty, remove it from the hose and wash in a container of clean gasoline. Install filter.

Note: Do not clean fuel filter by scraping with a wire brush or similar tool, as this may

MAINTENANCE AND ADJUSTMENTS

damage the screen, allowing foreign particles to enter the gas line. Always replace a damaged fuel filter.

Spark Plug

Heat Range — In some cases it may be necessary to change the heat range when using specific plugs. For recommended spark plug type, see Engine Specifications, pages 4, 5 and 6.

A cracked, fouled or dirty plug should be replaced. DO NOT clean and re-use old spark plugs; grit may be released into the cylinder, causing severe damage.

Tan or Light Brown Insulator Tip — Indicates correct type, proper heat range, and correct carburetor setting.

Light Gray or White Insulator Tip — Indicates overheating caused by a lean carburetor setting, overloading, or incorrect (hot) spark plug. If the carburetor is properly adjusted, replace the plug with one of a colder heat range.

Black Insulator Tip — Indicates fouling caused by excessive oil, a rich carburetor setting, or incorrect (cold) spark plug. If gas/oil mixture and carburetor adjustment is correct, replace spark plug with one of a hotter heat range.

Gap Setting — The spark plug gap should be set at .012 - .016".

Note: When heat gauge sending units are installed, spark plug gaskets must be removed. If sending units are removed, the spark plug gaskets must be installed.

TROUBLE SHOOTING

| Problem | Condition | Cause |
|-----------------------|------------------------------|---|
| Engine Fails to Start | (Weak or No Spark) | Emergency Switch OFF Ignition Switch OFF Wet or Fouled Plug(s) Incorrect Spark Plug Gap Faulty Wiring Faulty Ignition Switch Faulty Ignition Coil(s) |
| Engine Fails to Start | (Incorrect Fuel/Air Mixture) | Throttle Lever Opened Carburetor Misadjusted Faulty Carburetor Intake Manifold Leaking Air |
| Engine Fails to Start | (No Fuel) | Fuel Tank Empty Fuel Line Disconnected Fuel Line Pinched or Kinked Fuel Filter Dirty Impulse Line Disconnected Impulse Line Kinked Gas Cap Vent Hole Obstructed |
| Engine Fails to Start | (Poor Compression) | Cylinder Head Loose Spark Plug(s) Loose "Blown" Head Gasket Ring(s), Piston(s), or Cylinder(s) Damaged |
| Running Failure | (Engine Lacks Power) | Carburetor Misadjusted Faulty Carburetor Air Leak Around Carburetor Poor Compression Improper Ignition Timing Exhaust Port Plugged |
| Running Failure | (Engine Backfires) | Carburetor Misadjusted Faulty Carburetor Incorrect Spark Plug(s) Air Leaks at Carburetor Incorrect Ignition Timing |
| Running Failure | (Engine "Four-Cycles") | Carburetor Misadjusted Faulty Carburetor Exhaust Port Plugged |
| Running Failure | (Engine Pings [Detonation]) | Incorrect Spark Plug(s) Carburetor Misadjusted Improper Ignition Timing Excessive Carbon on Head(s) or Piston(s) Poor Grade of Gasoline |
| Running Failure | (Engine Idles Poorly) | Carburetor Misadjusted Faulty Carburetor Faulty Spark Plug(s) Incorrect Spark Plug(s) Incorrect Ignition Timing |

EXT IDENTIFICATION

The 1973 EXT snowmobile has three identifying numbers. Please make a record of them and keep it in a safe place.

The chassis model and serial number plate is located on the right side of the body tunnel just below the gas tank. All records are kept numerically by the chassis serial number.

The body serial number is stamped into the body tunnel just below the chassis serial number plate. It is important because it can be used to identify your machine in case of theft.

The engine model is located on the engine name plate and the serial number is stamped in the magneto cover.

Always provide the snowmobile name, engine model, and serial numbers when contacting your authorized Arctic Cat dealer concerning parts or service.

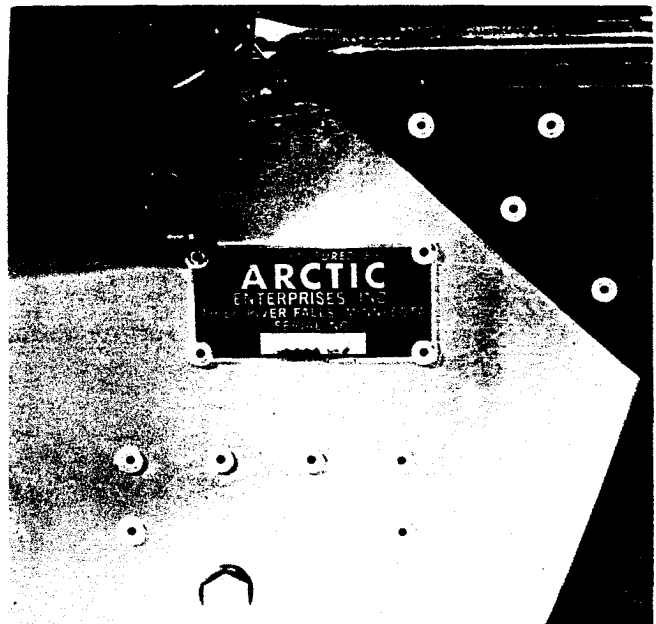

MAINTENANCE LOG

| Date | Hours Used | Lubri-cation | Chain Case | Gear Reduction | Suspension Arms | Driven Pulley | Drive Pulley | Offset | Center to Center | Carbu-retor | Track | Spark Plug |
|------|------------|--------------|------------|----------------|-----------------|---------------|--------------|--------|------------------|-------------|-------|------------|
| | | | | | | | | | | | | |
| | | | | | | | | | | | | |
| | | | | | | | | | | | | |
| | | | | | | | | | | | | |
| | | | | | | | | | | | | |
| | | | | | | | | | | | | |
| | | | | | | | | | | | | |
| | | | | | | | | | | | | |
| | | | | | | | | | | | | |
| | | | | | | | | | | | | |
| | | | | | | | | | | | | |
| | | | | | | | | | | | | |
| | | | | | | | | | | | | |
| | | | | | | | | | | | | |
| | | | | | | | | | | | | |
| | | | | | | | | | | | | |
| | | | | | | | | | | | | |
| | | | | | | | | | | | | |
| | | | | | | | | | | | | |
| | | | | | | | | | | | | |
| | | | | | | | | | | | | |
| | | | | | | | | | | | | |