

For many years, DIG Corporation has been providing homeowners, landscapers and growers with innovative, high quality low volume irrigation products.

Whether your garden is large or small, you can depend on DIG for the

- a) answers
- b) right products, all the time
- c) finest in low volume irrigation

We thank you very much for your business, and welcome your questions and comments.

For questions about your DIG Drip System Design, you can contact us at **800-344-2281** or by email at [dig@digcorp.com](mailto:dig@digcorp.com)



## Do-it-yourself!

Wise watering for beautiful landscape with DIG's drip and microsprinkler products

♻️ PRINTED ON RECYCLED PAPER  
 We at DIG strongly believe in conservation. Please recycle whenever you can. 50% recycled 10% post-consumer.

Version 83 040305

DIG Corporation  
 1210 Activity Drive • Vista, CA 92081  
<http://www.digcorp.com>



## Introduction

**A** Brief History: Drip irrigation has its roots in agriculture. In many parts of the world it is one of the few options available for the irrigation of crops and vegetables in harsh climates with a limited water supply. Its development depended on advancements in polyethylene tubing, and its growth was most rapid in arid and drought-plagued regions. Beginning in the late 1960's farmers discovered that by using drip irrigation they could increase yields while lowering water use. The 80's saw drip irrigation making the transition into commercial landscape and home gardens with mixed success. In today's market, drip irrigation is well trusted and used extensively in agriculture, commercial landscapes and residential gardens. Drip irrigation's popularity is mainly because it provides a solution to many water conservation problems.

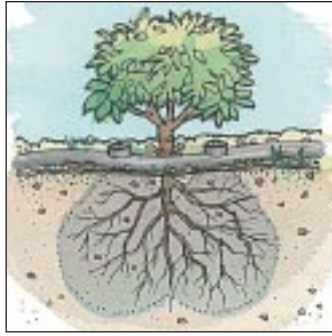

Drip irrigation is the most efficient method of irrigation today. Drip irrigation (sometimes referred to as micro irrigation, low-flow irrigation, or trickle irrigation) is the slow and precise delivery of water directly to the plant roots. Drip irrigation is controlled either by hand or automatic timer. Because drip irrigation is applied at the root zone, it maintains an optimum moisture level in the soil at all times resulting in less water lost to evaporation and wind. The plant roots are consistently maintained in an ideal moisture level, combining the proper balance of water and air for better growth while minimizing weed germination and growth.

Microsprinklers have many of the same benefits as a drip system, such as low flow and low operating pressure. Unlike drip irrigation, microsprinklers/sprayers, distribute water over a wide area where low volume overhead irrigation is desired. Microsprinklers are used in areas where drip irrigation would not be practical such as large areas of groundcover, flowerbeds or oddly shaped areas. Like all low volume irrigation systems, they require a pressure regulator and filter, and are available in a variety of flow rates and diameters.

## Advantages and Benefits

**WATER EFFICIENCY:** Drip irrigation applies water only when and where it is needed, with less runoff and evaporation from leaves and soil. Drip irrigation systems can conserve great amounts of water when compared to sprinkler systems.

**EASE OF INSTALLATION:** Installation is a very simple process, no special tools or glue are needed.

**REDUCED PEST PROBLEMS AND WEED GROWTH:** Watering only the roots of plants with drip irrigation reduces the amount of water-borne pests and fungal diseases that spread by water movement. It also inhibits germination of weeds in the area between plants.

**VERSATILITY:** Low volume irrigation systems are designed for placement in both new and existing landscapes. They are also ideal for installation on difficult terrain such as on slopes, in oddly shaped areas, and sites with high winds.

**ROOT ZONE:** One of the most important aspects of installing a new drip irrigation system is that a totally new and more favorable root zone environment is created, which maintains a relatively constant soil moisture level. This creates stress free plants that actively grow and resist disease.

**ECONOMY:** Investing in a low volume irrigation system can save you money by significantly lowering your garden water use, in turn lowering your water utility bill.

**LONG LIFE:** All DIG products are designed to withstand the harshest conditions in both home and commercial installations. They are manufactured from high quality, durable plastics and contain added quantities of the compound Carbon Black, making them resistant to the damaging effects of ultraviolet rays.

**F**rom product information to planning, installation and maintenance, DIG provides all you need to know about drip irrigation. Follow our easy, step-by-step instructions to design and problem solve your drip system.

Getting started .....	1
Planning and designing your system .....	1
About the soil .....	2
Determine soil types .....	2
Sketch your property or area .....	3-4
Select the methods to start a system .....	5-6
Product classifications .....	6-8
Determine and calculate water flow requirements .....	8-9
Watering schedules: drip and microsprinklers .....	9
Helpful tips .....	9
Spacing charts: drippers and microsprinklers (charts A through A1) .....	10
Product descriptions: GPH, PSI, wetting diameter, patterns (chart B) .....	11
Drip spacing, distance and head loss (charts C thru E) .....	12
Maximum length and spacing for microsprinklers (chart F) .....	13
Review the products .....	13-26
AC controller .....	13
Battery operated controllers .....	13
Hose end and in-line .....	14
Anti-siphon .....	14
Starter kits: drip microsprinklers and drip tape .....	14-16
4-outlet, 6-outlet PC drippers and Maverick™ 12-outlet retrofit drip kits .....	16
Head assembly: components of a drip zone .....	17-18
Polytube and microtube .....	18-19
1/2" and 1/4" fittings .....	19
PC, button, flags and adjustable drippers .....	19-20
Earthline Brown PC™ dripline .....	20
Drip soaker tape, laser drilled soaker hose and accessories .....	21
Microsprinklers, sprayers and foggers .....	21-24
Retrofit heads and accessories .....	24-25
Accessories .....	25-26
Parts List .....	26-30
Installation Instructions .....	30-42
Head assembly .....	30-31
Lateral layout .....	32-33
Drip emitter .....	34
Installation example drawings .....	35-36
Earth Growth PC™ dripline .....	37
Microsprayers / microsprinklers and foggers .....	37-39
Retrofit Products .....	40-41
Initial system start-up .....	41
Problems: potential causes and solutions .....	42-43
Glossary .....	43
Maintenance .....	44

## Getting Started

Compared to conventional sprinkler systems, drip irrigation systems are simple to design, inexpensive, and easy to install. In addition, drip irrigation can reduce disease problems associated with moisture on the leaves of plants. Traditional high volume, high pressure sprinkler systems require careful planning, extensive trenching, and special tools and glues. Drip irrigation systems can be easily installed above or below ground, without special tools and glue or extensive technical knowledge. These efficient systems deliver water measured in Gallons Per Hour (GPH), and apply water only where it is needed. This can improve plant health, conserve water, and reduce the growth of weeds all at the same time.

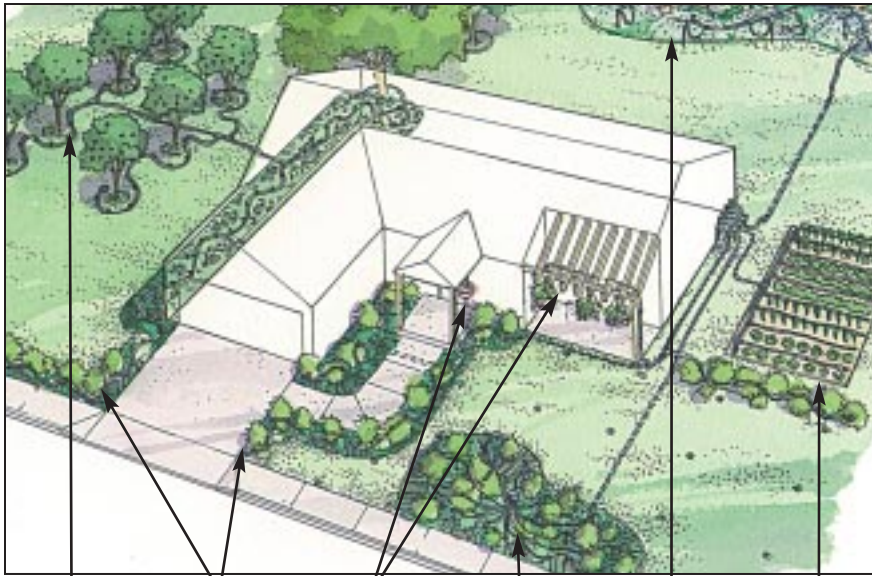

- Adjustable drippers or microsprinklers
- PC button drippers to shrubs
- Drippers or misting sprayers for hanging plants
- Maverick™ 4- or 6-outlets to retrofit 1/2" riser
- Microsprayers for flowerbeds
- Brown PC Dripline or drip soaker tape for a vegetable garden

## Planning and Designing Your System

When designing an irrigation system we recommend considering the various areas and plants to be watered. We recommend using drip irrigation on trees, shrubs, vines, vegetables, flowerbeds, containers, pots, boxes, house foundations, on any individual plant, and narrow planting areas. Microsprinklers are best used on ground cover, flowerbeds, groups of plants, hillsides and on very sandy soil. In sandy soil water will percolate downward when using drip before it can spread far enough horizontally; microsprinklers will solve this problem because of the wide spray diameters. Avoid using microsprinklers in windy areas. High winds will disturb the microsprinkler spray pattern.

### CREATE A PLANT LIST (See plan graph on page 3)

First, note and list the locations of your small and large trees, shrubs, groundcover, flowerbeds, containers and vegetable gardens. Then divide the plants into groups with similar watering needs, and plants that are in full sun or in a shaded area. Next, take into consideration the soil type, and concentration of plants. Use this information to select the water emission devices and to estimate the total flow rate (see view of design layout example).

## Design Layout Example

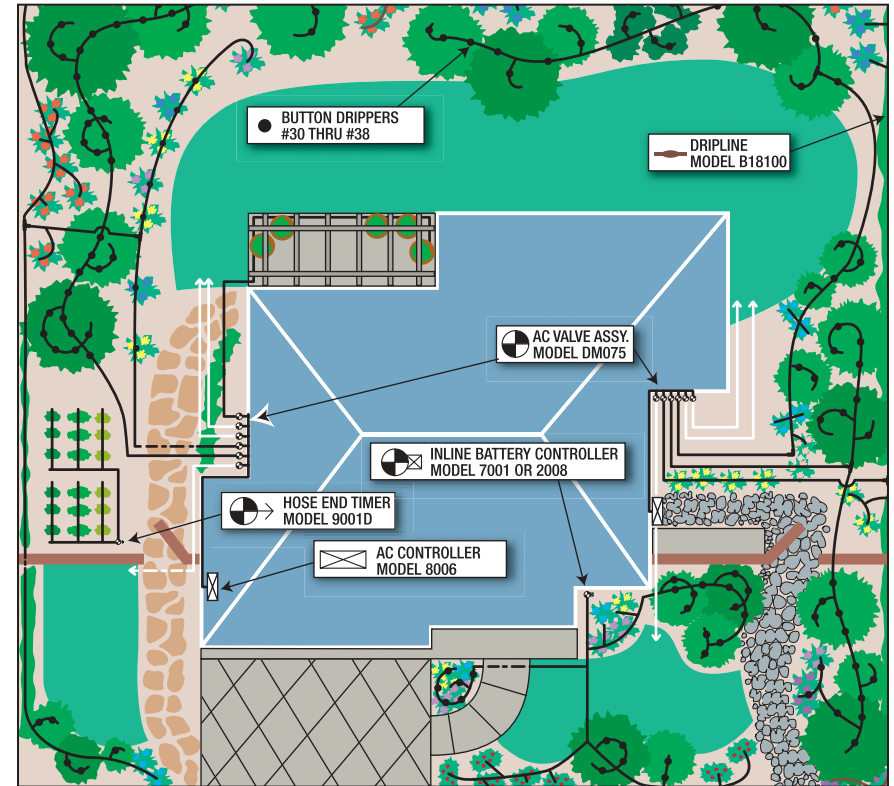

Sandy Loamy Dry

## About the Soil

Soil is like a storage room for plant nutrients. It is the medium through which water and nutrients move. It anchors plants and is a reservoir of water for plant growth. There are various types of soil with different characteristics which determine what types of dripper or microsprinkler should be used. In sandy soil, where water will tend to go straight down, use closely spaced 2 GPH drippers, 10" to 12" apart, or microsprinklers in a wider spacing. In loamy soil, the water will move slowly and will spread evenly, so use 1 GPH drippers with 16" to 18" spacing. In clay soil, where water will be absorbed very slowly, use .5 GPH or 1 GPH drippers at a wider spacing (18" to 24" apart) or microsprinklers and sprayers with adequate spacing.



## Determine Soil Types

With a drip system, water is applied slowly to the root zone at a single point. The water is acted upon by the forces of gravity (downwards) and capillary action (outwards), producing a wetting pattern characteristic of the soil type and the water application rate. To determine which type of soil you have in a given area, take a handful of dry soil, grip tightly and release. Sandy (coarse) soil will crumble and fall apart, loam (medium) soil will hold together but then easily break apart, and clay will mold without breaking. For more precise information, consider having a soil test conducted. Many universities offer this service through their extension offices and master gardener programs.

## Sketch Your Property or Area

**S**tart by making an accurate top view sketch of the areas that need to be watered (see Design Layout Example on page 2). Be sure to add details such as the outline of your home, any retaining walls, sidewalks, paved areas, all the plants, and the water source locations accurately and to scale.

This will require measuring the area. We recommend using graph paper with small squares. This will make drawing to scale easier. Each small square on this manual graph could represent one foot of your property; this scale is usually appropriate for residential landscapes, or you can use 1" graph = 10' of your area.

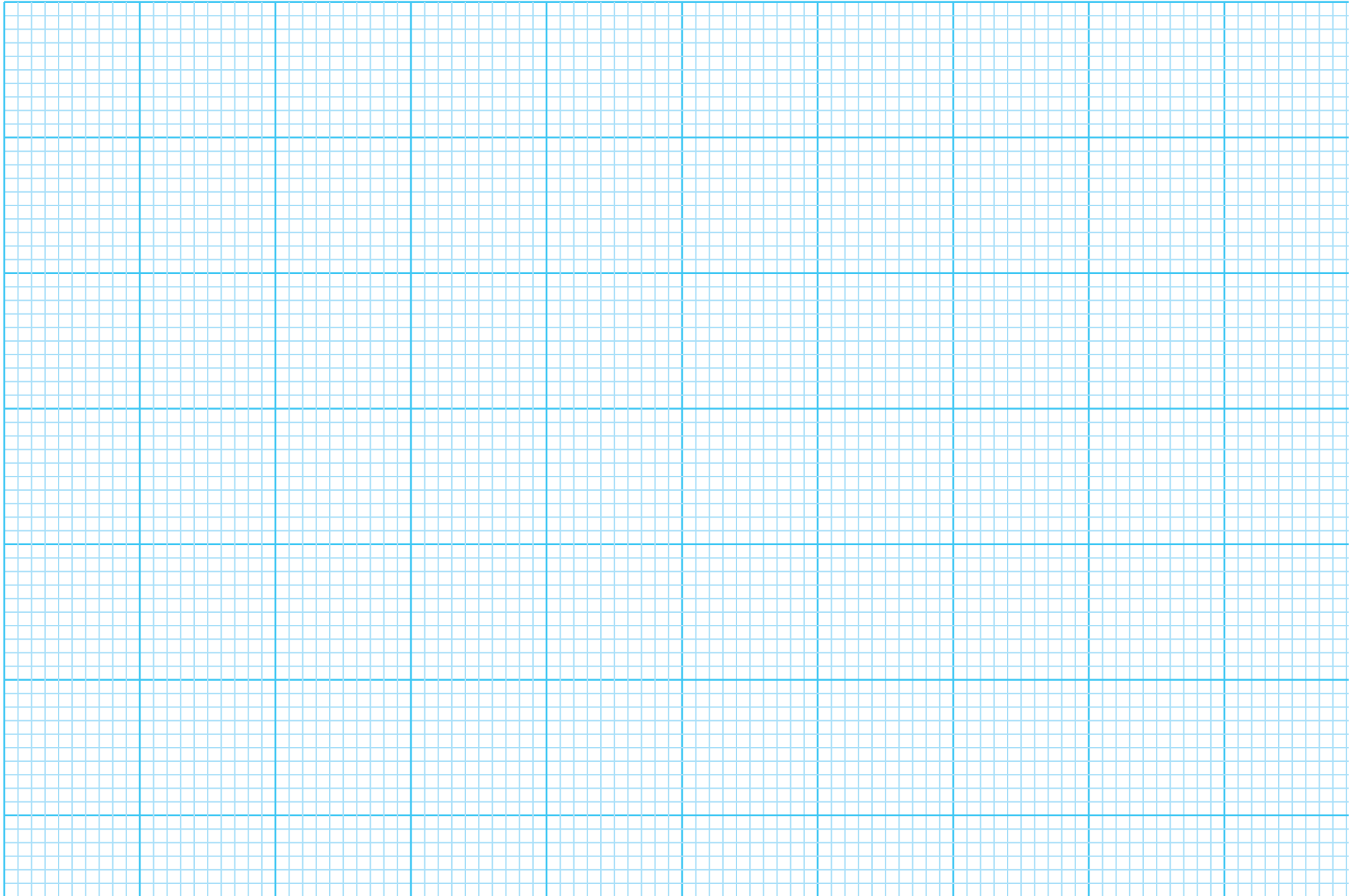

## Select the Methods to Start a System

**D**etermining how to start a system, and what products to select are important decisions that should be made carefully. The correct choice will depend on the size of the area, the availability of water outlets, the garden design/layout, and the type of plant material to be irrigated. Of the following five methods, choose the option(s) that is most feasible and appropriate for your particular use:

1. Starting from a faucet, above ground installation using 1/2" polytube
2. Above ground installation starting with an anti-siphon valve
3. Below grade installation using an AC or DC in-line valve
4. Retrofitting an existing sprinkler system with multi-outlet drip heads
5. Retrofitting an existing riser with a conversion elbow

The typical home garden may require one or more watering zones. For each situation, DIG provides a convenient and efficient irrigation solution.

**METHOD 1:** Above ground layout starting from a faucet using only the 1/2" black polytube as the main lateral. This is the simplest way to install a drip system. It can be easily automated by adding DIG's model 7001 or 9001D controller.

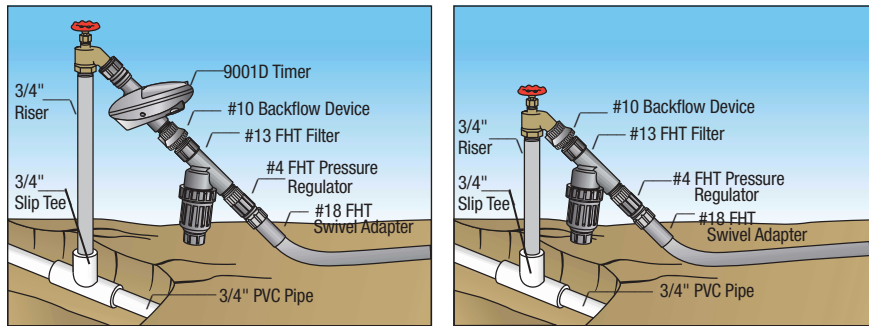

**METHOD 2:** Above the ground layout starting from an anti-siphon valve and using a 3/4" PVC pipe or 1/2" polytube as the main lateral. All anti-siphon valves must be installed at least 6" above the highest head.

\*Remove cover and screen prior to installation.

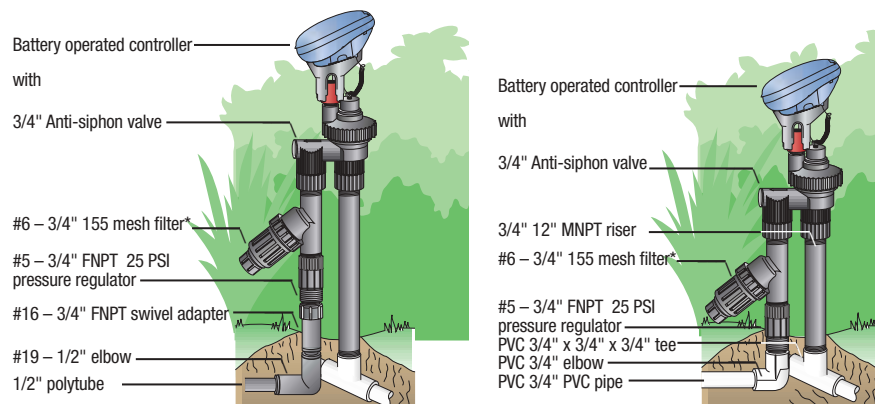

**METHOD 3:** Below grade layout starting from an in-line valve or in-line battery operated controller using buried 3/4" PVC pipe as the main lateral line, and 1/2" dripline as the sublateral.

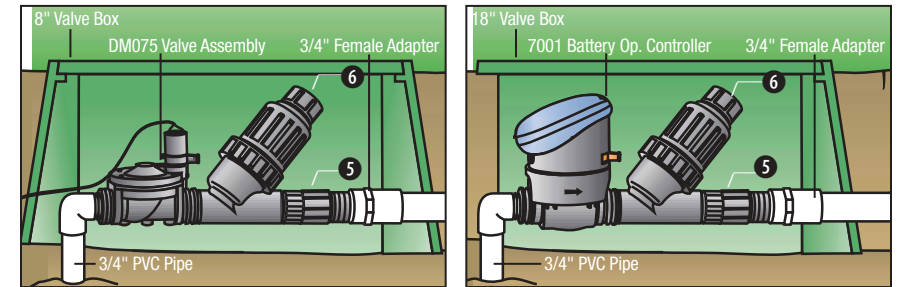

**METHOD 4:** Retrofit a sprinkler system or retrofit a 1/2" riser by removing the sprinkler heads and attaching a single, 4-, 6-, or 12-outlet drip head. From the drip head, extend microtube to the plants and secure with a #57 or #67 stake, if needed.

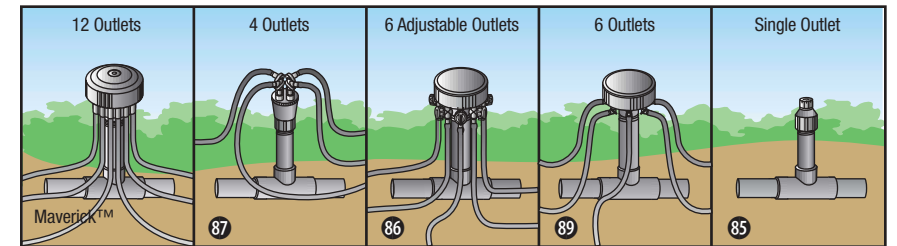

**METHOD 5:** Retrofit a 1/2" riser using conversion elbow, pressure regulator and swivel adapter. Use the polytube above or below the ground as the main laterals.

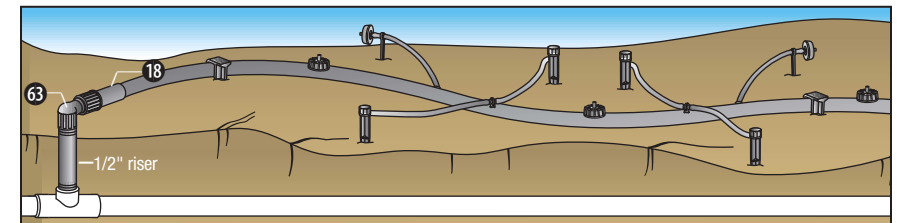

## Product Classifications and Watering Method

(continued through page 8)

Most residential landscapes are quite diverse and usually consist of up to four basic plant groups:

1. Individual foundation trees and shrubs
2. Densely planted flowerbeds, perennial beds and/or groundcover areas
3. Container plants, hanging baskets, window boxes
4. Vegetable gardens and row crops

DIG provides different emission devices specifically designed to effectively and efficiently irrigate each plant group. To choose the correct emission device, please refer to the following guidelines:

**CATEGORY 1—Trees and Shrubs:** Pressure Compensating (PC), button, adjustable and flag drippers are suited for virtually any layout with plants such as shrubs, trees, vines, roses. They are most efficient when plants are spaced few feet apart (See chart A1, B, and F on pages 10-13 for recommended number of drippers, dripper spacing per plant or area and maximum length to run the 1/2" polytube and 1/4" microtube). Model G77 is an excellent starter kit for this type of installation.

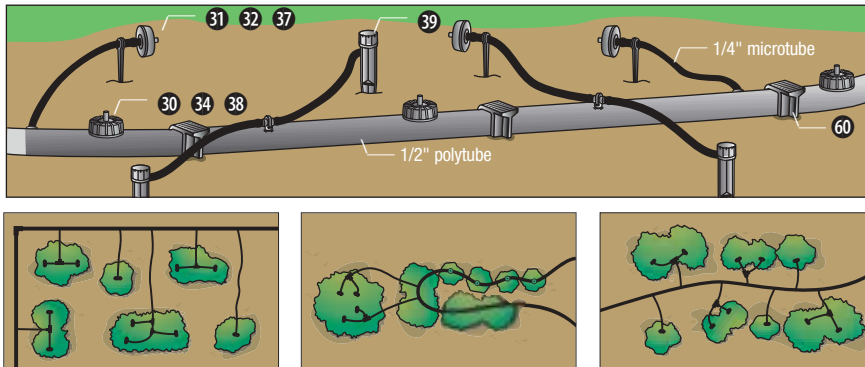

**CATEGORY 2—Flowerbeds and Groundcover:** Microsprinklers and microsprayers are best suited for densely planted flowerbeds, annuals, groundcovers, groups or clusters of plants, small slopes, and on sites with very sandy soil. In sandy soil water will percolate downward before it can spread far enough horizontally (see charts A1, B and F, on pages 10-13 for recommended spacing, flow rates, diameter, pattern, and maximum length to run 1/2" polytube). Avoid microsprinklers in areas where it is windy; high winds will disturb the microsprinkler spray pattern. Model EF55 and GE200 are excellent for this type of installation.

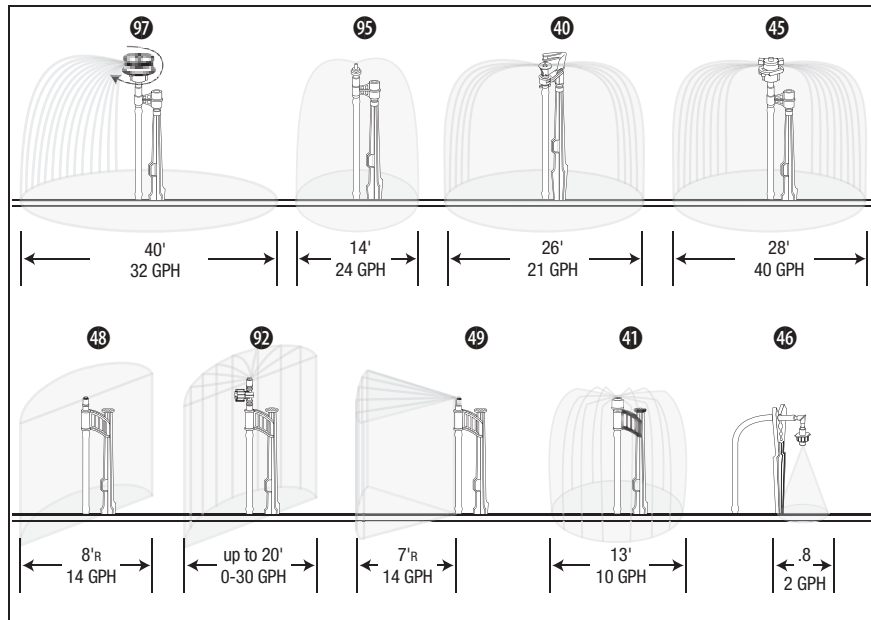

**CATEGORY 3—Container Plants, Hanging Baskets, and Window Boxes:** For containers, potted plants, and hanging baskets, use #46 pot and basket misters or #37 – .5 GPH button dripper. The #46 mister is most appropriate for hanging plants and plants that benefit from moist foliage. Potting soils are very porous and misters prevent drainage problems by dispersing the water over a larger area of the soil surface. The #46 pot and basket mister is an ideal choice for all sizes and shapes of containers. Larger containers may require more than one mister. (See chart A, A1, B, C, and C1 on pages 10 and 12 for recommended spacing, flow rates, wetting diameter and pattern). Model MD50 is an excellent starter kit for this type of installation.

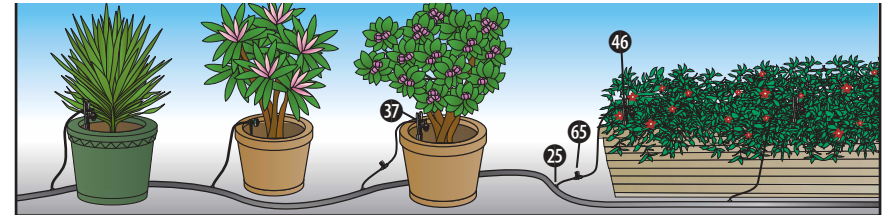

**CATEGORY 4—Vegetable Gardens and Row Crops:** Earthline Brown PC™ dripline, drip soaker tape, and 1/4" laser drilled soaker line are ideal for vegetable gardens, row crops, seed beds, planters, and narrow planting areas (See chart D on page 12 for maximum length to run). These products will saturate the soil under the entire length of the dripline or drip tape. An excellent starter kit is the ST100 or Earthline Brown PC™ dripline with a 1 GPH dripper every 18".

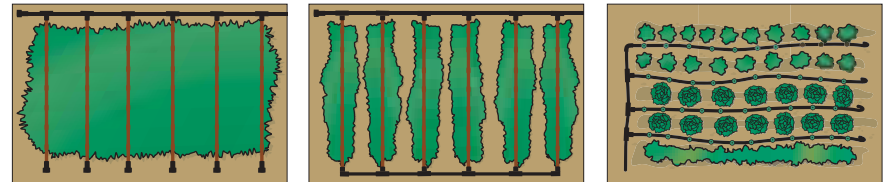

## Determine and Calculate Water Flow Requirements

To determine the total flow within a drip system section or zone, add up the total number of drippers and their flow rates. The same method should be used for microsprinklers and microsprayers.

Example: You have designed a system using 40 drippers, consisting of 20 – 1 GPH and 20 – 2 GPH drippers, plus 2 microsprinklers at 14 GPH each.

Calculate total flow rates:

20 – 1 GPH drippers = 20 gallons per hour

20 – 2 GPH drippers = 40 gallons per hour

2 – 14 GPH microsprinklers = 28 gallons per hour

Total flow rate = 88 Gallons Per Hour (GPH), or (dividing by 60) = 1.46 Gallons Per Minute (GPM)

**TIP: The maximum recommended flow rate for a single line of 1/2" polytube is 220 GPH (3.6 GPM). If you exceed the recommended flow rate, add another line of 1/2" polytube to your zone or section.**

If the flow rate from a single valve or a zone using a 3/4" pipe exceeds 9 GPM (540 GPH), another valve or zone should be added. This can be done by dividing the area to be irrigated in half and build a valve manifold for each new zone. Another option is to consider using a valve or a zone for each type of application. For example, one valve can be used with your drip layout and one valve with a microsprinkler layout.

**TIP: The recommended flow rate for any section or a zone using 3/4" valve is 540 GPH or 9 GPM. If using with a Model 9001 controller the maximum flow rate is 312 GPH or 5.2 GPM.**

If in doubt about the capacity of your water source, make sure that no water is being used in the house, and then time how long it takes to fill a measured bucket from one of the outside faucets. For example: turn on the faucet slowly until it is fully open and measure water capacity. If it takes 20 seconds to fill a 3 gallon bucket, then the maximum flow rate available per hour is 3 gallons x 3 times a minute = 9 Gallons Per 1 Minute (GPM) x 60 minutes = 540 Gallons per Hour (GPH); 540 divided by 60 = 9 GPM, so you have 9 GPH available from your single water source. Should the system require higher flow rates, divide the system in two by adding another valve.

**PLANNING FOR THE FUTURE:** In any design that you create, make sure to plan for the future. When plants mature, they may require more water. Watering times can be lengthened to meet those needs, but generally, more drippers should be added to supply the maturing plant. Also, new plants may be added to the landscape, so leave some room in the overall design by having about 20%-30% more water capacity available. 3/4" faucets and 3/4" anti-siphon valves will almost always provide more than enough water for most home landscapes and garden sites.

### DRIPPER WATERING SCHEDULE

TYPE OF PLANT	LENGTH OF WATERING	WATERING FREQUENCY		
		HOT	WARM	COOL
Flowers, vegetables	30 min – 1 hr	1-2 days	3 days	3-4 days
Small trees, shrubs	1-2 hours	1-2 days	2-3 days	3-4 days
Vines	3-6 hours	1-2 days	2-3 days	3-4 days
Medium trees, shrubs	5-7 hours	2-3 days	2-3 days	4-5 days
Large trees, shrubs	6-8 hours	1-2 days	2-3 days	5-6 days
Pots to 15"	3-5 minutes	1-2 days	2-3 days	4-5 days
Pots over 15"	5-10 minutes	1-2 days	2-3 days	4-5 days

### MICROSPRINKLER WATERING SCHEDULE

Flowerbeds, groundcover	30 min – 1 hr	1-2 days	3 days	4-6 days
Small trees	1-2 hours	2-3 days	4-5 days	5-6 days
Medium trees	2-3 hours	2-3 days	4-5 days	6-7 days
Large Trees	2-5 hours	2-3 days	4-5 days	5-7 days
Greenhouses, hothouses	5-10 minutes	2-4 times/day	2 times/2 days	1 time/2 days

## Helpful Tips

If this is the first time you are installing a drip or microsprinkler system, we recommend trying one of our starter kits. Each kit contains everything you need to install a basic system, with the exception of a pressure regulator which may be required if your pressure is over 25 PSI. All of the parts are available separately to add on later.

- Minimum working pressure (PSI) for a drip or microsprinkler system is 15 PSI, maximum working pressure is 25 PSI. If your system's pressure is higher than this, install a pressure regulator (#4, #5, #8) after the filter.
- If you are using pressure compensating drippers, you can achieve runs longer than 400'. Please refer to chart C1 on page 25 to see just how far you can go.
- You should not exceed 220 GPH on a single 1/2" line, 35 GPH on a single 1/4" line, or 5 GPH on a single 1/8" line.
- Allowing the 1/2" polytube to sit in the sun will warm and soften the plastic, making it easier to work with.
- If you are having difficulty inserting your 1/4" barbs into 1/4" microtube, dipping the microtube into warm water will make it more pliable.
- Water in the early morning hours for the best results.

**CHART A AND CHART A1:** Determine the number of drippers, microsprinklers and the flow rates recommended.

### Chart A: Spacing Chart Drippers

#### RECOMMENDED NUMBER OF DRIPPERS PER PLANT

Type of plants	Number of drippers and spacing
Flowers	One dripper (.5 GPH) in clay soil, spaced every 18" - 24". One dripper (1 GPH) in loamy & sandy soil spaced every 12" to 18".
Vegetables	One dripper (.5 GPH) in clay soil, spaced every 18". One dripper (1 GPH) in loamy & sandy soil spaced every 12" to 18", Earthline Brown PC™ dripline or soaker tape.
Small shrubs and roses (up to 2' high)	One dripper (1 GPH) per plant in clay soil. One to two (1 GPH) drippers in loamy & sandy soil, spaced every 12" to 18".
Medium shrubs and small trees (2' to 4' high)	Two drippers (1 GPH) per plant in clay soil spaced 10" from center. Two drippers (2 GPH) spaced 9"-12" from center or 3 (1 GPH) drippers in loamy & sandy soil, spaced 12" to 18" apart.
Medium shrubs and small trees (4' to 6' high)	Six drippers (.5 GPH) in clay soil spaced 18"-24" apart in a loop. Two to three drippers (2 GPH) in loamy soil spaced 16"-18" apart in a loop or 4 (1 GPH) drippers in sandy soil, spaced 12" to 18" apart in a loop around the tree.

### Chart A1: Spacing Chart Microsprinklers

#### RECOMMENDED NUMBER OF DRIPPERS OR MICROSPRINKLERS PER PLANT

	Number of drippers, microsprinklers and spacing
Large trees (6' and up )	Five drippers (2 GPH ) per plant in clay soil spaced 18" to 24" apart around the tree. Five drippers (2 GPH) in loamy & sandy soil, spaced 12" to 18" apart around the tree or one minisprinkler model 8809-1B (#94) near the base.
Groundcover	Select microsprinklers or microsprayers depending on the area you wish to cover (see chart B and E on pages 11 and 12 for diameter and distance). For narrow areas up to 2' wide, space drippers (1 GPH) in clay soil 18" to 24" apart or use Earthline Brown PC™ dripline. In loamy & sandy soil, space drippers (2 GPH) 12" to 24" apart.
Greenhouses (germination & propagation)	Use minisprinkler #95 spaced every 5'-6', microsprinkler #40 every 10' to 12' or #43 every 3' to 5'. Also, mister #43 can be used every 3', and placed 8" above the plants in a rectangular pattern.
Greenhouses and nurseries (cooling)	Use mister #43, or fogger #98 or #99 spaced 3' to 5' apart, 6' to 8' feet above the ground.
Hanging baskets and boxes (1 gallon to 25 gallons)	One dripper (.5 GPH) for up to 7 gallon plants. One sprayer #46 installed upside down or mounted on a spike for 5 to 25 gallon sized plants.

**TIP: We recommend spacing drippers no closer than 12" apart.**

### CHART B: Product Descriptions: GPH, PSI, Wetting Diameter, Patterns

Should you choose to use foggers, microsprinklers or misters, **CHART B** illustrates the various coverages and flow rate available for each model.

Locator #	Flow Rates (GPH)	Working Pressure (PSI)	Description	Diam. (ft.)	Pattern/degrees
40	16-21	25	Microsprinkler with heads for different patterns, 26 on spike assembly	360/180	/90/strip
41	7-10	25	Jet sprayer on 10/32 threaded barb	5	90/180/360
41	7-10	25	Jet sprayer preassembled on spike assembly	13	360
42	12-14	25	Jet sprayer with microtube and barb	18	strip
43	6-7	25	Fogger/mister on 10/32 threaded barb	5	360
44	11-14	25	Microsprinkler preassembled on spike assembly or 10/32 thread	25	360
45	39-40	25	Mini-compact microsprinkler on spike assembly	28	360
46	1.2 - 2	25	Sprayer on barb with mini stake	.8	360
47	12-14	25	Jet sprayer with 10/32 thread or on spike assembly	12	360
48	12-14	25	Jet sprayer with 10/32 thread or on spike assembly	8 <sub>R</sub>	180
49	12-14	25	Jet sprayer with 10/32 thread or on spike assembly	7 <sub>R</sub>	90
47	12-14	25	Jet sprayer on 12" pop-up	12	360
48	12-14	25	Jet sprayer on 12" pop-up	8 <sub>R</sub>	180
49	12-14	25	Jet sprayer on 12" pop-up	7 <sub>R</sub>	90
91	0-30	25	Adjustable flow jet sprayer on spike assembly	25	360
92	0-30	25	Adjustable flow jet sprayer on spike assembly	10 <sub>R</sub>	180
93	0-30	25	Adjustable flow jet sprayer on spike assembly	9 <sub>R</sub>	90
94	8-10	25	Minisprinkler preassembled on spike assembly	10	360
95	22-24	25	Minisprinkler preassembled on spike assembly	14	360
96	29-32	35	Adjustable one jet stream microsprinkler on spike assembly	42	30-330
97	29-32	25-35	One jet stream microsprinkler preassembled on spike assembly	40	360
98	.8	40-80	Fine droplet fogger for cooling on 10/32 thread	1-2	360
99	.8	40-80	Fine droplet fogger for cooling on 1/4" barb	1-2	360
100	7	25	Flow regulated microsprinkler assembly	15	360
101	0-20	25	Adjustable sprayer on a spike	1-12	360

One of the advantages of using a drip system and microsprinklers is the area that can be covered. Because these devices require low water flow, they allow you to cover a large area using a single 1/2" polytube. **CHARTS C, C1, D, E AND F** will assist you in determining how far you can run your polytube, and how many drippers or microsprinklers can be used depending on the spacing and flow rates.

### CHART C: MAXIMUM RUN OF 1/4" MICROTUBE OR 1/2" DRIP TUBING WITH PC DRIPPERS

Dripper Flow Rate			Dripper spacing in feet on 1/4" microtube					Dripper spacing in feet on 1/2" polytube				
Dripper	Locator #	Flow	1'	2'	3'	4'	5'	1'	2'	3'	4'	5'
PC	30/81	1 GPH	35	50	72	88	105	320	530	670	820	970
PC	38	2 GPH	25	36	45	56	65	190	310	420	510	610
PC	34	4 GPH	14	22	30	36	40	120	200	250	320	450

### CHART C1: MAXIMUM LENGTH RUN OF 1/4" MICROTUBE AND 1/2" DRIP TUBING WITH BUTTON AND FLAG DRIPPERS

Dripper Flow Rate			Dripper spacing in feet on 1/4" microtube					Dripper spacing in feet on 1/2" polytube				
Dripper	Locator #	Flow	1'	2'	3'	4'	5'	1'	2'	3'	4'	5'
Button	31	1 GPH	17	26	36	24	45	140	230	310	350	400
Button	37	.5 GPH	26	40	50	64	70	195	320	430	525	610
Button	32	2 GPH	10	16	21	24	30	80	145	175	230	270
Flag	35	1 GPH	17	26	36	40	45	125	220	300	330	370
Adjustable	39	1 to 10 GPH	Depends on flow rates									

### CHART D: DISTANCE YOU CAN RUN 1/2" DRIP SOAKER TAPE LINE, 1/4" LASER DRILLED SOAKER HOSE AND EARTHLINE BROWN PC™ DRIPLINE

Model #	Description	Flow rates (GPH)	Spacing	25 PSI	45 PSI
ST100/500	Drip soaker tape line	.6	12"	280'	N/R
SH50	1/4" Laser drilled soaker hose	.5	12"	30'	N/R
B18100	1/2" Earthline Brown PC™ dripline	1	18"	330'	

### CHART E: HEAD LOSS FOR 1/2" AND 1/4" POLYTUBE

Polyethylene (PE) tubing head loss						Distribution tubing head loss					
1/2" (.600 ID x .700 OD)						1/8" Vinyl			1/4" Vinyl		
GPM	Vel. F.P.S.	P.S.I. Loss				GPM	GPH	Vel. F.P.S.	P.S.I. Loss	Vel. F.P.S.	P.S.I. Loss
0.25	0.28	0.04				0.05	3.0	1.3	4.77	0.8	1.62
0.50	0.57	0.16				0.10	6.0	2.6	17.20	1.6	5.86
0.75	0.85	0.34				0.15	9.0	3.9	36.45	2.5	12.40
1.00	1.13	0.58				0.20	12.0	5.2	62.06	3.3	21.12
1.25	1.42	0.88				0.25	15.0	6.5	93.77	4.1	31.91
1.50	1.70	1.23				shaded area is not recommended					
1.75	1.98	1.64									
2.00	2.27	2.10									
2.25	2.55	2.61									
2.50	2.83	3.17									
2.75	3.22	3.78									
3.00	3.40	4.44									
3.25	3.68	5.15									



### CHART F: MAXIMUM LENGTH AND SPACING WITH MICROSPRINKLERS, SPRAYERS OR FOGGERS ON 1/2" POLYTUBE

Product	Locator. #	Nominal Flow Rates	Microsprinkler, sprayer and mister spacing in feet						
			3'	6'	9'	12'	15'	18'	20'
Microsprinkler	40	21 GPH	N/R	N/R	N/R	104	131	145	161
Microsprinkler	40	21 GPH	N/R	N/R	N/R	104	131	145	161
Ray jet sprayer	41	10 GPH	N/R	177	207	260	320	367	402
Jet sprayer	42	14 GPH	N/R	NR	114	141	162	191	202
Mister	43	7 GPH	N/R	135	175	201	237	249	263
Microsprinkler	44	14 GPH	N/R	N/R	114	141	162	191	202
Insect proof microsprinkler	45	40 GPH	N/R	N/R	N/R	N/R	73	103	113
Pot and basket mister	46	2 GPH	167	230	304	N/R	N/R	N/R	N/R
Spray jet	47/48/49	14 GPH	N/R	87	114	141	162	191	202
Spray jet on spike	47/48/49	14 GPH	N/R	87	114	141	162	191	202
Spray jet 12" pop-up	47/48/49	14 GPH	N/R	87	114	141	162	191	202
Minisprinkler	94	10 GPH	N/R	136	207	252	315	360	399
Minisprinkler	95	24 GPH	N/R	N/R	86	113	138	168	190
Compact microsprinkler	96/97	32 GPH	N/R	N/R	N/R	N/R	N/R	128	138
Flow regulated microsprinkler	100	7 GPH	N/R						

NR: Not Recommended

## Review of Our Products

**DIG** provides an extensive line of microirrigation products and accessories from controllers, starter kits, drip emitters, dripline, microsprinklers, foggers, tubing, fittings, and accessories to complete new and existing systems.

## AC Controllers

A controller should be selected with care. This is especially true if the irrigation system is watering a combined drip and sprinkler system with different settings for each valve or zone. DIG models 8004 four station and 8006 six station controllers are very simple to program. Both allow for each valve in the system to be programmed independently, from 1 minute to 12 hours in one minute increments. They both have four start times for each valve allowing for mixed irrigation applications for drip and sprinkler systems.



## Battery Operated Controllers

Battery operated controllers and timers are ideal for any watering system that needs a solution for automation without connecting wire to an AC source. These controllers have a wide range of features and use one 9-volt battery, with a battery life of up to two years.

## Battery Operated Controllers: Hose End and In-line

Our hose end battery operated controllers are available with either hose or pipe thread, low flow or high flow, with LCD display or without, and are covered by a 3-year limited warranty.

### IN-LINE CONTROLLER

• **MODEL 7001:** High flow with up to 28 GPM or 1680 GPH, has hose and pipe threads and LCD display.

### HOSE END TIMER

• **MODEL 9001 OR 9001DB:** Low flow with up to 5.2 GPM or 312 GPH, has hose thread only, and LCD display for programming. (If you install a system using this controller, make sure not to exceed the recommended flow rate).

• **MODEL 9001EZ:** Low flow with up to 5.2 GPM or 312 GPH, has hose thread only and uses two dials and one button for programming. (If you install a system using this controller, make sure not to exceed the recommended flow rate).



## Battery Operated Controllers: Anti-siphon

Our anti-siphon battery operated controllers are used for above ground installation and are available with either a 3/4" anti-siphon valve or with a retrofit actuator to convert most 3/4" or 1" manual anti-siphon valves on the market to automatic operation.

**MODEL 2008-I:** 3/4" anti-siphon valve and controller with LCD display. Maximum flow rate: 10 GPM.

**MODEL 2006-I:** Converts manual anti-siphon valves to automatic operation; includes controller with LCD display, actuator and all the parts needed to connect to an existing 3/4" or 1" manual anti-siphon valve.



## Starter Kits

**DIG** provides a variety of starter kits to help start a drip, microsprinkler, or retrofit system. DIG kits are the perfect way to familiarize yourself with the advantages and benefits of low volume irrigation. Our kits utilize many different products from our line to provide you a starting point. They are all in one package.

## Microsprinkler, Microsprayer, Drip and Drip Soaker Tape Kits

**MODEL EF55 AND EF55AS (WITH BACKFLOW DEVICE) MICROSPRINKLER WATERING KITS:** The microsprinkler kit can be used for watering groundcovers and flowerbeds. This kit can water up to 250 sq. ft. with the option to expand. It contains five large-diameter #40 microsprinklers on spikes, each with 21 GPH, and each watering a full circle up to 26' in diameter. It also includes inserts for

watering up to a 6' diameter in partial circles of 90° and 180°, and in a strip pattern of up to 12'. In addition, it has two small-diameter sprayers with 10 GPH #41 each on 10/32 thread. These sprayers also water a full 360° and include tips for 90° and 180° which can be inserted directly into the 1/2" polytube. The kit includes 50' of 1/2" polytube, swivel adapters, a tee, a coupling, a punch, hose ends and plugs. (If pressure in your system exceeds 30 PSI, add a #4, pressure regulator.)



EF55

**MODEL FM01 AND FM01AS (WITH BACKFLOW DEVICE)**

**PATIO WATERING KIT:** This mini drip kit is designed for watering container plants, pots, and planter boxes, indoors or outdoors. The kit can cover up to 10 plants and has the option to expand up to 35 plants using 1 GPH drippers. It contains ten #30, 1 GPH PC drippers. The kit also includes 60' of 1/4" microtube, adapters, tees, barbs, stakes, mounting clips, and 1/4" valves. (If pressure in your system exceeds 30 PSI, add a #4, pressure regulator.)



FM01

**MODEL G77 AND G77AS (WITH BACKFLOW DEVICE)**

**DRIP WATERING KIT:** This drip kit is designed to water landscape areas with shrubs, trees, vines, and flowerbeds. It can cover up to 150 sq. ft. using our 1 and 4 GPH PC drippers with option to expand. It contains twenty #30, 1 GPH and two #34, 4 GPH PC drippers. The kit also contains 50' of 1/2" polytube, 50' of 1/4" microtube, swivel adapters, 1/2" and 1/4" tees, coupling, barbs, 1/2" and 1/4" stakes, hose ends, punch, 1/4" shut off valve, and plugs. (If pressure in your system exceeds 30 PSI, add a #4, pressure regulator.)



G77

**MODEL GE200 DRIP AND MICROSPRAYER KIT:**

This drip and microsprayer kit is a complete system that can be used for watering groundcovers, flowerbeds, trees, vines, and shrubs. This kit can water up to 700 sq. ft. with the option to expand. It contains four #47, 90° microsprayers with 14 GPH each, four #48, 180° microsprayers with 14 GPH each, three #49, 360° microsprayers with 14 GPH each, and twenty #30, 1 GPH PC drippers. The kit also includes 200' of 1/2" polytube, 50' 1/4" microtube, eleven 13" clip stakes with 24" microtube and barb, backflow device, pressure regulator, swivel adapters, 1/2" and 1/4" tees, elbows, coupling, punch, barbs, 1/2" and 1/4" stakes, hose end, and plugs.



GE200

**MODEL MD50 MIST AND DRIP RETROFIT WATERING**

**KITS:** This drip and mist kit is designed to retrofit a 1/2" riser sprinklers to water large planters, containers, and boxes. The kit can cover up to six planters or boxes. It contains four #39, 0-20 GPH adjustable drippers on spikes and two #46, 2 GPH foggers. The kit also contains 50' of 1/4" microtube, 1/2" adapter with 1/4" barb outlet, 1/4" tees, stakes, and plugs.



MD50

**MODEL ST100 AND AT100AS (WITH BACKFLOW DEVICE) DRIP & SOAKER VEGETABLE WATERING KIT:**

This kit is the perfect way to water a vegetable garden! This kit can cover up to five beds, each 20' long, using our drip soaker tape. The kit contains 100' of drip soaker tape with .8 GPH drippers sonically welded inside the tape every 12". The kit also contains 5' 1/2" polytube, swivel adapters, drip tape coupling, drip tape ends, drip tape reducers, hose ends, drip tape to drip hose connector, punch, plugs, installation instructions and a booklet on how to plan and prepare a vegetable garden. (If pressure in your system exceeds 30 PSI, add a #4, pressure regulator.)



ST100

**MODEL R750 ADJUSTABLE MICROSPRAYER KIT:**

This adjustable microsprayer kit is a complete system that can be used for watering under the canopy of groundcovers, flowerbeds and shrubs. It can water up to 160 sq. ft. or it can water a narrow border, with the option to expand up to 320 sq. ft. It contains two #47, 90° microsprayers, four #48, 180° microsprayers on adjustable flow stake risers and two #101, 360° adjustable sprayers. The kit also contains 50' of 1/2" polytube, seven 2' pieces of 1/4" microtube with 1/4" barb, backflow device, pressure regulator, swivel adapters, 1/2" tee, punch, 1/4" barbs, two 3-1/2" holder stakes, hose end and plugs.



R750

**4-outlet, 6-outlet, and Maverick™ 12-outlet Retrofit Drip Kits**

**MODEL A450 RETROFIT 4-OUTLET PC DRIP HEAD AND ACCESSORIES KIT:**

The 4-outlet drip head is designed to retrofit an existing 1/2" riser to a low flow, water efficient drip system without disturbing the sprinkler system flow rate. It is ideal for individual plants or plants that the sprinkler system cannot reach. The 4-outlet drip head has four PC outlets which can each be connected to 1/4" microtube, and covers up to four plants. The kit also contains 50' of 1/4" microtube and four 1/4" stakes.



A450

**MODEL A650 RETROFIT 6-OUTLET PC DRIP HEAD AND ACCESSORIES KIT:**

The drip head is designed to retrofit an existing 1/2" riser to a low flow, water efficient drip system affecting plants that a sprinkler cannot reach. The 6-outlet drip head has six individual PC outlets which can be connected to 1/4" microtube, and covers up to six plants. It also can be used with 1/4" soaker hose, or with individual drippers. Additionally the kit has 50' of 1/4" microtube and 1/4" stakes.

**MODEL PC12100 MAVERICK™ 12-OUTLET DRIP KIT:**

The Maverick™ 12-outlet drip head is designed to retrofit any 1/2" riser above or below the ground to a low flow, water efficient drip system. It may be used alone, providing 2 GPH per outlet at an operating pressure from 8-80 PSI. Unused outlets may be plugged so that a minimum of four of the outlets, to a maximum of twelve, are in use at once. The drip head has twelve individual outlets that can each be connected to 1/8" microtube (included) or 1/4" microtube using the included converter barbs. Additionally the kit includes 100' of 1/8" microtube, 12 converter barbs, 12 stakes, 8 caps and 8 bug plugs to close the end of the 1/8" microtube and to prevent bugs from entering the system.



PC12100  
2 GPH/zone

### MODEL PC14100 MAVERICK™ 12-OUTLET HIGH FLOW DRIP KIT:

The Maverick™ high flow 12-outlet drip head is designed to retrofit any 1/2" riser above or below the ground to a low flow, water efficient drip system. It may be used alone, providing 4 GPH per outlet at an operating pressure from 8-80 PSI. Unused outlets may be plugged, so that a minimum of four of the outlets to a maximum of twelve are in use at once. The drip head has twelve individual pressure compensating (PC) outlets that can each be connected to 1/8" microtube (included), or 1/4" microtube using the included converter barb. Additionally, the kit includes 100' of 1/8" microtube, 12 converter barbs, 12 stakes, 8 caps and 8 bug plugs to close the end of the 1/8" microtube and to prevent bugs from entering the system.



## Head Assembly: Components for a Drip Zone

When installing a low volume irrigation system, using a filter and a pressure regulator will ensure that your system remains trouble free for years to come. Please remember: drip systems and microsprinklers require clean water and operate at lower pressures than conventional sprinkler systems.

**DRIP ZONE HEAD ASSEMBLY:** Everything you need to start a drip system in one package. This kit consists of a 3/4" electric valve, 155 mesh screen filter, preset 25 PSI pressure regulator and a 3/4" swivel adapter. Completely assembled, the DM075 electric valve assembly is ready to install with your drip irrigation system. It can be connected to a DIG 8006, 8004 or any other 24-volt AC controller via 16 to 18 gauge electric wire. DM075 can be installed below grade in a 12" irrigation box or above grade. The recommended flow rate is 8 to 9 GPM or 480 to 540 GPH.



**BACKFLOW PREVENTER:** (#10 required by city code in many areas) A backflow preventer keeps contaminated water from re-entering your household water system, and should always be used when applying fertilizer. A backflow preventer, when used, is the first item in your line after your faucet or hose bib (hose thread). If used with a battery operated controller, install the backflow preventer after the controller to prevent stress on the backflow device. For faucet installation only. Do not install on main line.



**FILTERS:** (#6 – 3/4" MNPT, #3 – 1" MNPT and #13 – 3/4" FHT) All drip systems require a filter at the beginning of the system to prevent the small orifices of the drippers and microsprinklers from clogging. Choose the correct thread (hose or pipe thread) and size for your system, and remember to periodically remove and rinse the screen to keep the filter clean. All DIG filters come with a 155-mesh screen.



**FILTER/FERTILIZER APPLICATOR:** (#12) Apply fertilizer directly through your system, the DIG filter/fertilizer applicator may be used with either hose or pipe thread and must be used with the backflow device included in the package. It will keep incoming water clean, and can apply water-soluble fertilizer. It will accommodate up to four spoonfuls of any water-soluble fertilizer at one time (see instructions on fertilizer package for the amount of fertilizer to apply). The only maintenance required is to remove and rinse the screen with fresh water after each use to keep the filter/fertilizer applicator clean.



DIG filters should never be installed on a main line where they are under constant pressure. When installing on the main line, place the filter after the valve, eliminating pressure when the system is off.

**PRESSURE REGULATORS:** (#4, preset 25 PSI hose thread, #5, preset 25 PSI pipe thread and #8, adjustable with pipe thread. The #8, adjustable pressure regulator can be adjusted by removing red cap and dialing up "+" and down "-", to a maximum of 60 PSI and minimum of 28 PSI).



Pressure regulators control and reduce the pressure entering your system to the recommended operating pressure of the drip or microsprinkler system. The pressure regulator will reduce the pressure only when water is discharged from the system.



DIG pressure regulators are only designed for use in your irrigation systems and should be installed after your filter. Choose the correct thread (hose or pipe). DIG pressure regulators should never be installed on a mainline where they are under constant pressure. In this situation, they need to be installed after the valve



**CONVERSION ELBOW:** (#63, 1/2" FNPT x 3/4" MHT) Use this item to start your system from a 1/2" underground riser, then add a #4 pressure regulator and either a #18 swivel adapter for 1/2" polytube or a #21, adapter for 1/4" microtube.

**TIP:** When connecting your components, please make sure you are using the correct thread. Do not mix hose and pipe threads, as they will leak.

## Polytube and Microtube

There are three sizes of drip tubing that we use: 1/2" polytube, and 1/4" and 1/8" microtube. The 1/2" polytube serves as the lateral or as main line, into which you can insert drippers, microsprinklers, or 1/4" barbs to connect the 1/4" microtube. The 1/4" serves as the distribution line into which you can insert the drippers or microsprinklers, and the 1/8" is used only with the Maverick™. DIG polytube and microtube is made of the highest quality polyethylene resin or vinyl, with 5%+ carbon black added for extra resistance to the damaging effects of the sun's ultraviolet rays. Both the 1/2" polyethylene tube (polytube) and the 1/4" vinyl microtube may be installed above or below ground and are designed to meet the all the needs of both commercial and residential low volume irrigation users.

**1/2" POLYTUBE:** Made of polyethylene and used for main lines and laterals. Unlike PVC pipe, it comes in coils for easy handling and storage, and weighs about 4 pounds per 100'. Maximum working pressure for the polytube is 60 PSI and maximum flow rate is 220 GPH (3.6 GPH). The polytube coils are available in lengths of 50', 100', 200', 500', and 1000'.



*Note: The actual inside and outside diameter of DIG premium 1/2" polytube is .600" ID\* x .700" OD\*\* which is universally accepted as the standard size. This tube dimension varies with other manufacturers – some larger, some smaller. To ensure problem-free installation and use, we recommend using only DIG premium 1/2" polytube. In the event that you have an odd size of tubing, DIG offers various adapters and universal fittings to complete your project.*

\* ID = Inside Diameter \*\* OD = Outside Diameter



**1/4" FLEXIBLE MICROTUBE:** Made of vinyl or polyethylene, it is the primary feeder line from the 1/2" polytube to the plants. It may also be used as the basis for a complete system for containers and patio plants. Maximum working pressure for the microtube is 60 PSI, and maximum flow rate is



35 GPH. The vinyl microtube coils are available in lengths of 50' in black, 100' in brown or black, and 500' in black. The polyethylene microtube coils are available in 50', 100', and 500' in black only. DIG 1/4" vinyl microtube is .156 ID and .245 OD, and the 1/4" polyethylene microtube is .170 ID and .250 OD.

**1/8" FLEXIBLE MICROTUBE:** Made of vinyl and designed to be used exclusively with the DIG Maverick™ 12-outlet Drip Head as a feeder line from the Maverick™ to the plant. The 1/8" vinyl microtube is .118 ID and .187 OD.



## 1/2" and 1/4" Fittings Product Review

**D**rip fittings are divided into three categories: compression, barb, and Universal Nut Lock™. The compression fittings are available in various configurations and connect to the 1/2" polytube. By using a simple wrist action, the tubing is "walked" into the fittings for a very tight fit. No tools, glue, or clamps are required. DIG's compression fittings with black inserts are used with our 1/2" polytube that is .700 OD. The 1/4" fittings are available in straight barbs, elbows, and tees, and they can be inserted into the 1/2" polytube or into the 1/4" microtube. The microtube is pushed over the barb to ensure a leak proof fit.

DIG also has specialty fittings, such as the 1/2" PVC to polyethylene connectors, and a complete line of 1/2" compression fittings with blue inserts that can be used with TORO Blue Stripe™ drip hose that is .710 OD.

DIG provides reducing couplings to convert from our 1/2" polytube to the following brands: To connect DIG polytube to Blue Stripe™ (.710 OD) use #14 and to Raindrip® driphose (.620 OD), use #15, with green insert.

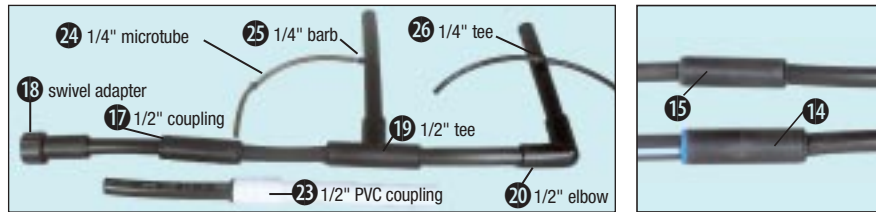

**1/2" UNIVERSAL NUT LOCK™ FITTINGS:** In addition to our compression and barb fittings you may want to try our Universal Nut Lock fittings that use a combination of barb and compression to connect different sizes of polytube. DIG universal fittings are designed to connect any size of tubing between .620 OD to .710 OD. DIG Universal Nut Lock fittings are available in three configurations: #73, coupling, #74, tee, and #75, elbow. These fittings provide an additional way to connect polytube and can be easily disconnected and re-used if necessary.

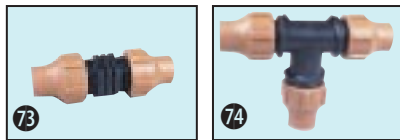

## Pressure Compensating (PC) Buttons, Flags and Adjustable Drip Emitters

**D**rippers are the heart of any drip irrigation system. DIG drippers deliver a precise amount of water directly to the plant's root zone. They are reliable, accurate, inexpensive, and easy to install. They may be inserted directly into 1/2" polytube or extended to the plants using a 1/4" microtube. DIG drippers incorporate four different characteristics: PC, turbulent flow, laminar flow, and adjustable drippers.

**PRESSURE COMPENSATING (PC) DRIPPERS:** #30 -1 GPH, #38 -2 GPH and #34 - 4 GPH are DIG's most advanced drippers. Our PC drippers allow longer runs with equal flow from each dripper at any pressure between 10 and 55 PSI. They are self-cleaning, utilizing a silicone diaphragm which presses against the water passage as pressure and flow fluctuate to provide preset flow rates; when the pressure is below 10 PSI, the diaphragm is completely open, allowing particles to be washed through. PC drippers are very durable and can withstand harsh conditions. The drippers have a 1/4" barb inlet and are available in all our drip kits, as well as in packs of 10 and 20.



**BUTTON DRIPPERS:** #31-1 GPH, #32 -2 GPH, #37- .5 GPH are button drippers with turbulent flow, which slows the velocity of the water to provide a predetermined flow rate at a preset pressure. Turbulent flow drippers regulate water flow by dissipating energy in friction against the walls of the labyrinth like water passage. Button drippers will provide the suggested flow rate at the recommended pressure of 25 PSI, and as the pressure increases so will the flow. The drippers have a 1/4" barb inlet and are available in packs of 5, 10, 25, 50, and 100.



**FLAG DRIPPERS:** #35 - 1 GPH, #36 - 2 GPH are low flow drippers which allow water to flow smoothly, without turbulence, as the water slows in velocity. The drippers may be twisted open for cleaning. The drippers provide the suggested flow rate at a pressure no higher than 25 PSI. The drippers have a 1/4" barb inlet and outlet. Available in packs of 5, 10, 25, and 100.



**ADJUSTABLE DRIPPERS:** #39, with adjustable flow from 0 to 10 GPH. When the cap is rotated the flow from this dripper and the radius of the wetted area can be adjusted from a gentle stream pattern, to drip, to off. This allows you to adjust the flow to each individual plant. Twisting the dial on the dripper towards the "+" or the "-" signs will allow you to increase or decrease the flow. Available with 1/4" barb in packs of 2, 5, 10, and 25, or with 5" spike and 1/4" side inlet in packs of 3 and 10.



## Earthline Brown PC™ Dripline

**E**arthline Brown PC™ Dripline is a drip hose that contains pressure compensating (PC) drippers inserted into the extruded interior wall of the tubing at 18" intervals. Each of the drippers consists of a cylinder with a labyrinthine water passage, filter and diaphragm. The diaphragm inside our PC in-line dripper continuously adjusts to varying water pressure, ensuring a constant flow rate. It also allows particles to pass through the dripper without harming it, providing reliable performance and a longer life. This dripper design, with a wider flow path, allows the dripper to operate at optimal flow rates under extreme conditions.



Both the tubing and the drippers are manufactured from quality resins using hi-tech equipment to form a product that withstands the various chemicals and fertilizers used in agriculture and landscaping.

The working pressure range for the Earthline Brown PC™ Dripline is from 10 to 50 PSI but it should always be used with a 25 PSI pressure regulator.

Earthline Brown PC™ Dripline has a flow rate of 1 GPH and comes in 100' roll. It can be used with our compression fittings. Earthline Brown PC™ Dripline can be used below or above the ground or mulch and is suitable for most types of plants.

## Drip Soaker Tape, Laser Drilled Soaker Hose & Accessories

**D**rip soaker tape and laser-drilled soaker hose are another method of providing drip irrigation to vegetable gardens, window boxes, or where total saturation is desired along a straight, narrow path. The drip soaker tape is a flat drip tape with drippers pre-inserted every 12". The laser drilled soaker hose is a 1/4" microtube with laser drilled holes every 12". The drip soaker tape can be used above or below the ground and the laser drilled soaker hose above the ground only. Maximum working pressure is 25 PSI, and we highly recommend installing a 25 PSI preset pressure regulator and a filter at the beginning of the lines.

**DRIP SOAKER TAPE** is a flat drip tape with .8 GPH drippers welded to the inside diameter of the tape every 12". When filled with water the tape expands and disperses the water through the pre-inserted drippers. You can run the drip soaker tape to a maximum of 280 feet. The best layout for this product is to use 1/2" polytube as the main lateral and a #29, reducer to branch off to the drip soaker tape. Available in a complete kit: Model ST100 with 100' drip soaker tape or in rolls: ST100R – 100', ST500 – 500'.



**Tip: When installing drip soaker tape, make sure that it is installed in straight lines only.**

**DRIP SOAKER TAPE FITTINGS:** The drip soaker hose requires special drip soaker tape fittings (#27, 28, 29, 76, 77) that are different in design from those used with 1/2" polytube, in that they work with a twisting lock device rather than with compression.

Available in various configurations to connect drip soaker tape to the faucet, to couple two pieces of drip soaker tape, to connect drip soaker tape to 1/2" polytube, and to close the end of the drip soaker tape.

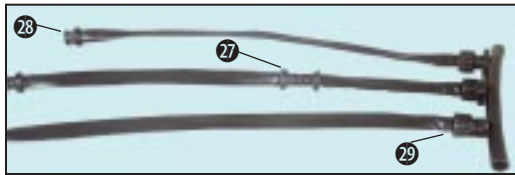

**LASER DRILLED SOAKER HOSE** is 1/4" microtube with pre-cut holes every 12", the holes are created by a laser in a predetermined angle to provide the correct flow rate. The laser drilled soaker hose is designed for short runs up to a maximum length of 30'. The laser drilled soaker hose has a flow rate of .5 GPH per foot, and an arrow printed on the soaker hose shows the water direction. It may be extended from 1/2" polytube, 1/4" microtube, 6-outlet adjustable head, or the Maverick™ 12-outlet drip head. Do not bury 1/4" soaker hose or connect it in a loop.



## Microsprinklers, Microsprayers & Foggers

**M**icrosprinklers, sprayers, and foggers are available in a variety of styles and configurations. Like drip emitters, microsprinklers, sprayers, and foggers operate at low-pressure. Microsprinklers, sprayers, and foggers are designed for areas where drippers may not be as practical, such as for groundcover, flowerbeds, large boxes, and oddly shaped areas. Microsprinklers and sprayers are rated by flow rate, wetting diameter or radius, and the spray method (moving parts versus non moving parts). Like sprinklers, microsprinklers and sprayers are available in 360° full circle pattern, 360° jet pattern, 180° half circle pattern, 90° quarter circle pattern, and strip patterns, which aim left and right like a bow tie. DIG's microsprinklers, sprayers, and foggers are available in a variety of flow rates and diameters, from low flow 2 GPH up to 42 GPH, with diameter from 1' to 42'. Microsprinklers, sprayers, and foggers have small sized droplets and provide a low precipitation rate, allowing longer watering time with less runoff.

**MICROSPRINKLER ON SPIKE:** #40, spinner type microsprinkler with green nozzle provides medium size droplets and is assembled with spike and microtube. Microsprinkler flow rate is 21 GPH and coverage is up to a 26' full circle. Use #40, microsprinkler to irrigate flowerbeds, groundcover, and large trees. Prepackaged microsprinklers come with heads for 360° assembled. Also enclosed in the package are a 180° insert with up to a 12' diameter, a 90° insert with up to a 6' diameter and a strip insert which will spray up to 12' left and right. Ideal spacing for the full circle pattern is 12' to 16' between the sprinklers, and 14' to 16' between the laterals. Available in packs of 1 and 5.



**JET SPRAYER ON THREADED BARB OR SPIKE ASSEMBLY:** #41, spray jet gives a flow rate of 10 GPH and coverage of up to a 5' full circle when installed directly into 1/2" polytube, or up to 13' full circle when installed on a spike assembly (spike is 8" to 10" above the ground). Use for flowerbeds, groundcover, and small trees. Prepackaged jet sprayers come with additional heads for 90° and 180° with up to a 4' radius. The additional heads can be snapped to the top of the jet. Ideal spacing for the sprayers is 3' to 5' apart. Available in packs of 1 on spike assembly and packs of 3 with thread.



**FOGGER/MISTER:** #43, is a fine spray mister with a flow rate of 7 GPH and coverage of up to a 5' full circle when installed directly into 1/2" polytube, or up to a 7' full circle when installed on a spike assembly with microtube (spike is 8" to 10" above the ground). Ideal use of the mister is in a small flowerbeds. Available in packs of 5.



**MICROSPRINKLER ON SPIKE:** #44, spinner type microsprinkler with blue nozzle has medium size droplets, and is assembled with spike and microtube. Microsprinkler flow rate is up to 14 GPH and coverage is up to a 25' full circle. Use #40 microsprinkler to irrigate flowerbeds, groundcover, trees, and hillsides. Ideal spacing for this model is 8' to 12' between the sprinklers, and 10' to 15' between the laterals. Available in packs of 1.



**INSECT PROOF MICROSPRINKLER ON SPIKE:** #45, spinner type microsprinkler with brown nozzle has medium size droplets and is assembled with spike and microtube. Microsprinkler flow rate is 40 GPH and coverage is up to a 28' full circle. Use #45 microsprinkler for groundcover, flowerbeds, and large trees. The anti-insect spinner will close when the irrigation cycle is complete. Ideal spacing for this model: 15' - 19' between the sprinklers, and 15' to 20' between the laterals. Available in packs of 1.



**POT AND BASKET MISTER ON SPIKE OR BARBED ELBOW:** #46, mister has a very fine spray with a flow rate of 2 GPH and coverage of up to 8" full circle when used with the stabilizer stake and barbed elbow. Ideal use of the mister is on 8" to 24" diameter pots, and baskets with the mister hung upside down 4" to 5" above the plant using the 6" stabilizer. For larger baskets hang the mister from a 1/4" drip microtube 8" to 12" above the basket for up to 2' in diameter. Available in packs of 2 and 5.



**SPRAY JET ON THREADED BARB, SPIKE OR ADJUSTABLE SPIKE:** #42 sprays a strip pattern (bow tie) with coverage of up to 18', #47 sprays 12 jets in a 360° pattern with coverage of up to a 12' full circle, #48 sprays 180° with coverage of up to an 8' radius, and #49 sprays 90° with coverage of up to a 7' radius with a flow rate of up to 14 GPH. Ideal use for these models is for groundcover, flowerbeds, and shrubs. The



10/32 thread models can be installed on the 1/2" polytube, using #58, semi-rigid riser with barb, or raised above the ground with a #68, spike assembly. #48 – 180° and #49 – 90° are spikes with adjustable flow rates from 0 to 14 GPH. Ideal spacing for the four models: 4' to 6' between the sprayers. Available in packs of 1 on spike assembly, packs of 1 on adjustable spike, and packs of 10 with thread.

**12" POP-UP SPRAY JET WITH MICROTUBE ASSEMBLY:** #47 sprays 12 jets in a 360° pattern with coverage of up to a 12' full circle, #48 sprays 180° with coverage of up to an 8' diameter, and #49 sprays 90° with coverage of up to a 7' diameter with a flow rate of up to 14 GPH. Ideal use for these models is high groundcover, flowerbeds, and shrubs. The Pop-up can be installed to the 1/2" polytube by connecting the barb and it should be raised 4" to 8" above the ground. Ideal spacing for the four models: 4' to 6' between the Pop-up sprayers. Available in packs of 1.



**ADJUSTABLE SPRAY JETS ON THREAD OR SPIKE:** #91 sprays 360° with coverage of up to 25', #92 sprays 180° with coverage of up to an 10' radius, and #93 sprays 90° with coverage of up to a 9' radius. The 10/32 thread models can be installed on the 1/2" polytube, using #58, semi-rigid riser with barb, or raised above the ground with a #68, spike assembly. All models have adjustable flow rates from 0 to 30 GPH. The ideal spacing for the 90° and 180° models are 5' to 8' between the spray jets. Available in packs of 1 on spike assembly and in packs of 2 on 10/32 thread.



**MINISPRINKLER ON SPIKE:** #94 provides coverage of up to 10' full circle and #95 will cover up to a 14' full circle. These are spinner type minisprinklers with blue nozzle using up to 10 GPH, or green nozzle using up to 24 GPH. #94 and #95, minisprinklers have small droplets, with low precipitation rates for use on any soil type. Use to irrigate seedling beds, flowerbeds, and groundcover with ideal spacing of 5' to 8' between the sprinklers, and 5' to 10' between the laterals. Available in packs of 1 on spike assembly.



**LARGE DIAMETER MICROSPRINKLER ON SPIKE:** #96 will cover up to an 18' full circle and #97 will cover up to a 40' full circle. #96 and #97 have a red nozzle with flow rates of up to 32 GPH and water using a turbine mechanism for a single stream. #96, microsprinkler may be adjusted to cover between 30° and 330°. A maximum of seven large diameter microsprinklers (spaced 20' apart) may be installed on the 1/2" polytube. Ideal spacing is 16' to 20' between the sprinklers. Available in packs of 1 on spike assembly.



**MISTING NOZZLES ON 10/32 THREAD OR BARB:** #98 on 10/32 thread and #99 on a barb are full circle foggers that can operate in a wide pressure range of 40 to 80 PSI with flow rates of .7 to .8 GPH. The foggers can create a cooling effect; often up to a 20° drop in temperature is achieved with this system, depending on the surrounding humidity. Use this system for the cooling of animals, people, and plants. We recommend installing the misting nozzles 8' to 10' above the ground with 3' to 4' spacing for maximum cooling effect. Available in packs of 5.



**FLOW REGULATED MICROSPRINKLER ON SPIKE:** #100, full circle spinner type microsprinklers on spike assembly with medium size droplets. This microsprinkler has a flow rate of 7 GPH, and up to 15' diameter regardless of pressure fluctuation along the line. The microsprinkler can achieve a consistent flow rate in a system with



pressure fluctuations from 20 to 60 PSI or in an area with difficult topography. Available in packs of 1 with spike assembly.

**ADJUSTABLE SPRAYER ON A SPIKE:** #101, with adjustable flow from 0 to 20 GPH. When the cap is rotated, the flow from this sprayer and the radius of the wetted area can be adjusted from a small diameter up to 12', including the ability to be turned off. This allows adjustment of flow to each individual plant. Twisting the dial on the dripper towards the "+" or the "-" signs will allow you to increase or decrease the flow. Available with 5" spike and 1/4" side inlet in packs of 2 and 10.



## Retrofit Drip Heads and Accessories

**DIG**'s retrofit heads are designed to adapt any 1/2" riser above the ground. They may be incorporated into a new system, or used to convert an existing sprinkler to a 4, 6, or 12-outlet drip system without disturbing the flow of the other sprinklers on the line.

Retrofitting conventional sprinkler systems to low flow water saving drip systems requires a few simple steps:

First, evaluate the areas to be watered. While large areas such as lawns are best watered by sprinklers, other areas, such as shrubs, trees, roses, or individual plants, can be irrigated more efficiently by using the retrofit drip heads. Second, remove the sprinkler head from the riser, flush the line and screw the Maverick™ 12-outlet, 6-outlet, or 4-outlet drip heads onto the riser. Third, extend microtube from the drip head to the plants and secure microtube with a 1/4" stake.

Additionally, DIG provides several items to help convert or divert a riser to a drip system; these include a 1/4" adaptor with a 1/4" barb outlet to be used with microtube under the sprinkler head, 1/4" adaptor with 10/32 thread to be used with our microsprayers, and 1/4" MNPT with PE riser extension to raise microsprayer above the plants.

**MAVERICK™:** The Maverick utilizes our extremely accurate pressure compensating (PC) nozzles ensuring equal flow over a wide pressure range. The Maverick may be used with a minimum of four to a maximum of twelve outlets, and it can be used with 1/8" or 1/4" microtube.

Maverick™ 12-outlet drip heads with 1/2" FNPT available models: Model PC1201 – 1 GPH per outlet; Model PC1202 – 2 GPH per outlet; Model PC1204 – 4 GPH per outlet

**Tip: When installing your Maverick™ as part of your existing sprinkler system, we recommend using the 4 GPH Maverick. When converting an entire sprinkler system, use the 1 GPH or 2 GPH Maverick.**

**1/2" MNPT ADAPTER WITH 8" LONG PE RISER:** #84, adaptor allows you to extend microsprayers or jets above the plants. Thread the any sprayer or jet with 10/32 thread directly to the PE riser, and thread base to any 1/2" FNPT base.



**ADJUSTABLE DRIPPER ON 1/2" FNPT:** #85, adjustable flow from 0 to 10 GPH. When the cap is rotated the flow and the radius of the wetted area can be adjusted from a gentle stream pattern, to drip, to off, allowing the changing of flow for each individual plant. Twisting the dial on the dripper toward the "+" or the "-" signs will allow you to increase or decrease the flow in a 360° pattern.



**ADJUSTABLE 6-OUTLET PC DRIP HEAD:** #86, with adjustable flow from 0 to 20 GPH from each outlet. The 6-outlet head can be used to convert an existing 1/4" sprinkler riser above the ground to a 6-outlet drip zone. Each outlet may be adjusted by turning the knob under the drip head to increase or decrease the flow. Extend 1/4" microtube from the drip head to plants and secure the microtube with a 1/4" stake. It may be used with other drippers or with 1/4" laser drilled soaker hose.



**4-OUTLET PC DRIP HEAD:** #87, 6 GPH per outlet at any pressure between 10 and 50 PSI. The 4-outlet head can be used to convert an existing 1/4" sprinkler riser above the ground to a 4-outlet drip zone. Extend 1/4" microtube from the head to the plants and secure the microtube with a 1/4" stake. The 4-outlet drip zone can be combined with 1/4" laser drilled soaker hose to a maximum length of 6' per zone.



**1/2" FNPT ADAPTER WITH 10/32 THREAD:** #88, adaptor allows you to thread in a 10/32 threaded microsprinkler or spray jets to a 1/2" riser.



**6-OUTLET PC DRIP HEAD:** #89, 6 GPH per outlet at any pressure between 15 and 50 PSI. The 6-outlet head can be used to convert an existing 1/4" sprinkler riser above the ground to a 6-outlet drip zone. Extend 1/4" microtube from the head to the plants and secure the microtube with a 1/4" stake. The 6-outlet drip head can be combined with 1/4" laser drilled soaker hose to a maximum length of 6' per zone.



**1/2" FNPT RISER ADAPTER X MNPT WITH 1/4" BARB:** #90, adaptor allows you to attach a 1/4" microtube in between a sprinkler head and the riser. Extend the 1/4" microtube from the adaptor to the plants and insert dripper or sprayers, and add additional tees for more components.



**1/2" FNPT X 3/4" MHT CONVERSION ELBOW:** #63, conversion elbow allows an existing 1/2" riser to serve as the point of connection for 1/2" polytube or 1/4" microtube. After unscrewing the existing sprinkler head, attach the #63, conversion elbow into the top of the riser, followed by the #4, pressure regulator, and then screw on the appropriate tubing adaptor (#18 for 1/2" polytube or #21 for 1/4" microtube).



**TIP: #39, adjustable dripper on stake works well with this configuration.**

## Accessories

Drip systems use many different types of accessories, which we have separated into two categories: basic and customizing. Some are necessary for the installation of your drip system, such as a goof plugs and hose ends. Others, such as in-line valves, drip inserts and "C" clamps, are for customizing the system to specific watering needs.

## CATEGORY 1

**NECESSARY PARTS:** #51 and #52 – Punches are used to punch holes in the polytube to insert drippers and microsprinklers. #55, hose end is used to close the end of 1/2" polytube. #56, goof plugs are used to plug off unwanted holes. #57 and #67, tubing stake holders are used to secure the position of the drippers to the microtube near the plants. #60, tubing holder stakes are used to hold 1/2" polytube in place on the ground. #66, ray spike or #68, universal spike assemblies are used to hold microsprinklers or sprayers above the ground.



## CATEGORY 2



**CUSTOMIZING PARTS:** Other drip accessories may help you meet the specific needs of your system. For example, the #64, 1/2" ball valve and #65, 1/4" ball valve provides you with the option of turning an individual 1/2" polytube or 1/4" microtube ON or OFF without affecting the other lines on the system. #53 and #54, "C" clamps can secure 1/2" polytube and 1/4" microtube to a structure, and #69, adjustable spike assembly to raise microsprayers with 10/32" thread above the ground.













## HEAD ASSEMBLY

Locator #	Description
8006	Six station AC controller with 4 start times and durations up to 12 hrs in 1 minute increments.
2008	Single Station Programmable Battery Powered Controller on 3/4" Anti-Siphon Valve. Use to automate sprinkler or drip systems. 10-100 PSI
7001	Battery Operated Controller with 3/4" FHT or 3/4" FNPT. Ideal for drip and sprinkler system. (High flow up to 28 GPM)
9001	Battery Operated Timer with
9001DC	3/4" FHT (Low flow up to
9001EZ	5 GPH)

	DM075 3/4" Head Assembly, 24 VAC valve with filter, pressure regulator and polytube connector.
	#3, 1" and #6, 3/4" Screen Filters with 155 mesh flow rate 800-1200 GPH
	Pressure Regulator with Hose Thread preset at 25 PSI
	Pressure Regulator with Pipe Thread preset at 25 PSI
	Threaded Swivel Adapter 3/4" FHT x 3/4" MNPT, converts hose to pipe thread
	Adjustable Pressure Regulator adjusts between 28 and 60 PSI. FNPT inlet and outlet
	3/4" MNPT x 3/4" MHT Coupling connects 3/4" hose thread to 3/4" pipe thread

-  10 Backflow Preventer. Prevents dirt or fertilizer from re-entering the water system
-  12 Filter/Fertilizer Applicator. Applies any water soluble tablet or granular fertilizer
-  13 3/4" FHT x 3/4" MHT Screen Filter with 155 mesh. Flow rate 800-1200 GPH.















### TUBING AND MICROTUBE











-  B34 50' 1/8" Microtube use with Maverick™ 12-outlet Drip Heads
-  B35 50' 1/2" Polytube .600 ID x .700 OD
-  B36 100' 1/2" Polytube .600 ID x .700 OD
-  B39 200' 1/2" Polytube .600 ID x .700 OD
-  B37 500' 1/2" Polytube .600 ID x .700 OD
-  B40 500' 3/4" Polytube .830 ID x .940 OD
-  B43 1000' 1/2" Polytube .600 ID x .700 OD
-  B38 50' 1/4" Microtube .156 ID x .245 OD
-  B38100 100' 1/4" Microtube .156 ID x .245 OD
-  B38500 500' 1/4" Microtube .156 ID x .245 OD
-  B38P 50' 1/4" Poly/Microtube .170 ID x .250 OD

### LASER, DRIP TAPE AND DRIPLINE





-  SH50 50' Laser Drilled Soaker Hose
-  ST100R100' Drip Soaker Tape  
ST500 500' Drip Soaker Tape
-  B18100 Earthline Brown PC™ Dripline with PC dripper every 18"

### FITTINGS













-  14 Reducing Coupling - Connect Blue Stripe™ to DIG Drip Hose (blue x black)
-  15 Reducing Couplings connect two different sizes of 1/2" polytube (green x black)
-  16 3/4 FNPT Adapter with Screen connects .700 OD 1/2" polytube to 3/4" water source.
-  17,17a Hose Connector connects 2 pieces of 1/2" polytube with .700 or .710 OD
-  18,18a 3/4" FHT Swivel Adapter with Screen Filter connects .700 or .710 OD 1/2" polytube to any 3/4" water source.
-  19,19a Tee 1/2" x 1/2" x 1/2" to achieve a three-way layout of 1/2" polytube .700 or .710 OD
-  20,20a Elbow 1/2" x 1/2" to create a 90° turn with 1/2" polytube with .700 or .710 OD
-  21 3/4" x 1/4" FHT Adapter with Screen Filter. Connects 1/4" microtube to any 3/4" water source.
-  22 3/4" FHT Swivel Tee with Screen Filter. Connects to any 3/4" water source with two directions of 1/2" polytube.
-  23 PVC x Poly Coupling connects 1/2" PVC to 1/2" polytube
-  24 1/4" Elbows create a 90° turn with 1/4" microtube
-  25 1/4" Barb Connector to extend drippers or microsprinklers from 1/2" polytube or connect 2 pieces of 1/4" microtube
-  26 1/4" Tees for a 3-way layout of 1/4" microtube
-  27 Line Connector couples two pieces of Drip Soaker Line
-  28 Line End closes the end of Drip Soaker Line

-  29 Reducer used to connect Drip Soaker Line into 1/2" polytube supply line
-  71 End Cap closes the end of 1/2" polytube
-  73 To connect two different sizes of tubing with any diameter from .600 OD to .710 OD (grey, black or blue)
-  74 To connect two different sizes of tubing with any diameter from .600 OD to .710 OD (green, black or blue)
-  75 To connect two different sizes of tubing with any diameter from .600 OD to .710 OD (grey, black or blue)
-  76 Tape Swivel Adapter connects Drip Soaker Tape to any 3/4" water source
-  77 Tape Connector to 1/2" Hose. Use to connect Drip Soaker Tape to the end of a 1/2" polytube line
-  78 1/2" Barbed Connector. Use to connect two pieces of 1/2" polytube with .600 ID
-  79 1/2" Barbed Tee. Use to connect three pieces of 1/2" polytube with .600 ID
-  80 1/2" Barbed Elbow. Use to achieve a 90° turn with 1/2" polytube with .600 ID

### DRIPPERS

-  30,34,38 PC Dripper 10-55 PSI. #30 Black 1 GPH, #38 Green 2 GPH, #34 Red 4 GPH
-  31,32,37 Button Dripper working pressure 15-25 PSI. #37 Brown 1/2 GPH, #31 Black 1 GPH, #32 Green 2 GPH
-  35,36 Flag Drippers 1 GPH (#35) and 2 GPH (#36) are easy to clean
-  39,39a Adjustable Dripper 1-10 GPH with 1/4" barb or stake

### MICROSPRINKLERS AND FOGGERS

-  40,40a,40b Microsprinkler on spike, with heads for 360°, 180°, 90° or strip spray. Max. flow 21 GPH, max. diameter 26'
-  41 Jet Sprayer on Threaded Barb 360° with snap on heads for 180° or 90°. Flow 7-10 GPH, diameter 3' or 5'
-  41a Jet Sprayer on Spike Assembly 360° with up to 13' diameter up to 10 GPH
-  42 Strip Sprayer on Spike assembly - up to 18' with 14 GPH
-  43 Fogger/Mister on Threaded Barb, up to 7 GPH, up to 5' diameter
-  44 Microsprinkler on Spike. Flow rate 14 GPH. 360° diameter up to 25' full circle
-  45 Full Circle Insect Proof Microsprinkler completely assembled with microtube and spike. Flow rate up to 40 GPH, diameter up to 29'.
-  46,46a Pot and Basket Mister on Spike #46, or #46a with barbed elbow. Flow rate up to 2 GPH, diameter up to 8"
-  47,48,49 Sprayer on Threaded Barb, 14 GPH; #47, 360°; #48, 180° and #49, 90° up to 12' diameter
-  47a,48a,49a Sprayer on Spike Assembly, 14 GPH; #47a, 360°; #48a, 180° and #49a, 90° up to 12' diameter
-  47b,48b,49b Sprayer on Pop-up Assembly, 14 GPH; #47b, 360°; #48b, 180° and #49b, 90° up to 12' diameter
-  48c,49c Sprayer on Adjustable Spike Assembly, 14 GPH; #48c, 180° and #49c, 90° up to 12' diameter



- 91,91a 360° Adjustable Flow Jet Sprayer on Spike Assembly or Thread. Flow rate 0-30 GPH, 18'-26' diameter
- 92,92a 180° Adjustable Flow Jet Sprayer on Spike Assembly or Thread. Flow rate 0-30 GPH, 6'-10' radius
- 93,93a 90° Adjustable Flow Jet Sprayer on Spike Assembly or Thread. Flow rate 0-30 GPH, 6'-9' radius
- 94, 95 Full Circle Insect Proof Minisprinklers on Spike Assembly. #94 flow rate: up to 10 GPH, diameter up to 10'; #95 flow rate up to 24 GPH, diameter up to 14'
- 96 Microsprinkler on Spike Assembly. Adjustable from 30° to 330°. 32 GPH. 20' radius.
- 97 Microsprinkler on Spike for large diameter. Full circle. 32 GPH. 42' diameter.
- 98,99 Misting Nozzles, #99 with 1/4" barb or #98 on thread, .8 GPH, reduce the air temperature around people, animals or plants. Working pres. 40-80 PSI
- 100 Flow Regulated Microsprinkler, completely assembled with microtube and barb. Full circle with coverage up to 15' diameter. Flow rate 7 GPH
- 101 360° Adjustable Sprayer on 5" Spike. Flow rate from 0-20 GPH. Twist cap to adjust from 0-12' diameter.

### ACCESSORIES

- 50 PCV Inserts will adapt PVC fitting to 1/2" polytube .700 OD
- 51 Deluxe Punch for easy installation of drippers, microsprinklers, and any barbed end.
- 52 Punch
- 53,54 #54, 1/2" and #53, 1/4" "C" Clamps secure 1/2" polytube and 1/4" microtube to structure
- 55 Figure "8" Hose End closes the end of 1/2" polytube

- 56 Goof Plugs close holes in 1/2" polytube or seals the end of 1/4" microtube
- 57 Tubing Holder Stake holds 1/4" or 1/8" microtube in place
- 58 6" Riser with 1/4" Barb to extend any microsprinkler above ground
- 59 3/4" Shut Off Valve with 3/4" FNPT x 1/2" Barb
- 60 1/2" Tubing Holder keeps 1/2" polytube in position
- 63 Conversion Elbow converts 1/2" pipe thread to 3/4" hose thread
- 64 1/2" In-line Shut Off Valve with Barb Inlet and Outlet
- 65 1/4" In-line Shut Off Valve with Barb Inlet and Outlet
- 66 Ray Spike to raise microsprinklers and microsprayers above the ground
- 67 6" Stabilizer Stake to hold different sizes of microtube in place
- 68 Universal Spike Assembly with MICROTUBE and Barb
- 69 Adjustable Flow Spike Assembly. Combine with 8" PE riser to raise microsprinkler or jet above the ground

### RETROFIT

- 84 Adjustable Flow spike Assembly. Combine with 8" PE riser to raise microsprinkler or jet above the ground
- 85 Adjustable Drifter on 1/2" FNPT. Flow from 0-10 GPH when cap is rotated. Wetted area can be adjusted from gentle stream pattern, to drip, to off
- 86 6-outlet PC Adjustable Drifter has 6 individual outlets. Each outlet may be adjusted to flow between 1 and 20 GPH
- 87 4-outlet PC Drip Head retrofits a 1/2" riser, 6 GPH per outlet at any pressure between 10 and 80 PSI

- 88 Shrub Riser Adapter with 10/32 Thread. Adapt microsprinklers or jet sprayers to 1/2" riser
- 89 6-outlet PC High Flow Drip Head. Retrofits 1/2" riser to drip system. Combine with 1/4" microtube and/or 1/4" laser drilled soaker hose.

- 90 1/2" Riser Adapter with 1/4" Barb, place between sprinkler and riser to incorporate 1/4" microtube
- PC1201 Maverick™ 12-outlet 1 GPH
- PC1202 Maverick™ 12-outlet 2 GPH
- PC1204 Maverick™ 12-outlet 4 GPH

## Installation Instructions

### Head Assembly Installation

When installing your system, you may select from various start-up options, layouts and configurations. Choose the option that best suits your needs.

**SYSTEM START-UP: INSTALLING THE HEAD ASSEMBLY.** All properly designed drip systems begin with what is called the "head assembly", which consists of three vital components: a control valve (manual or automatic), a filter, and a pressure regulator. This assembly can be attached to a faucet, anti-siphon valve, in-line valve, or sprinkler riser.

**OPTION 1: BEGIN THE INSTALLATION BY CONNECTING TO AN OUTDOOR FAUCET.** First attach the #10 backflow device (if your faucet already has a brass backflow attached, #10 is not required). Then attach the #13 filter (or #12 fertilizer applicator with backflow device included), a #4 pressure regulator followed by the #18-3/4" swivel adapter (see figure 2). If you are planning to use a battery operated timer (model 9001 and 9001EZ), install the backflow device after the timer (see figure 2a). All these fittings have "hose" type threads and are sealed by a washer so they should be turned clockwise until they are "hand tight" only. Tightening with a wrench is not recommended and should not be necessary.

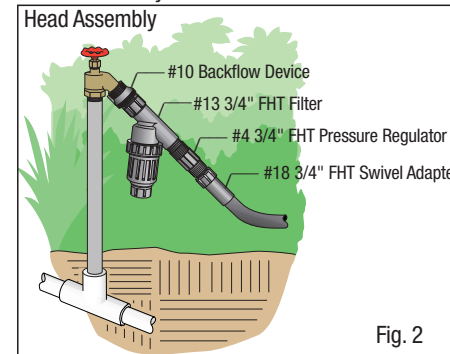

Fig. 2

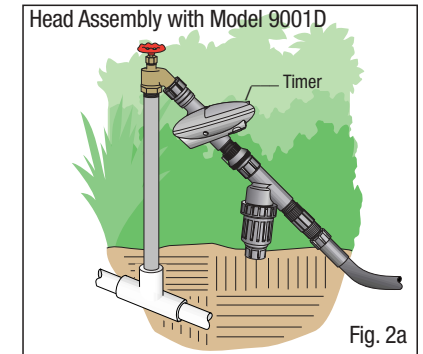

Fig. 2a

**OPTION 2: BEGIN THE INSTALLATION CONNECTING TO AN EXISTING MAIN LINE.** (Note: This method requires basic plumbing skills – inexperienced installers should contact a plumber or irrigation contractor for this connection).

**First, tap into the water service line.** This can be done at a faucet or by cutting into your service line before the faucet. You can avoid cutting the service line by removing the faucet and installing a brass threaded "tee" (line size) just up stream of the faucet (see figure 3). Shut off the water supply and unscrew the faucet from the brass fitting or, if necessary, cut the copper pipe before the faucet. Install the tee with the side outlet facing down and screw the faucet back into the end of the tee. Next, below the tee install a manual shut-off valve (for emergency shut-off), then 3/4" PVC male adapter, then connect 3/4" PVC pipe and run it out to the location of the drip system control valve(s). (Copper should be used in areas that freeze).

Select which type of control valve to install (Fig. 3). DIG provides several different types of automatic control valves; each one is designed for the low-flow hydraulic needs of drip systems. If your irrigation design calls for more than one control valve, use the same type for each zone. This may involve building a manifold with a series of tees branching off to each valve. Always end the manifold with a PVC cap to make future valve additions easier. Choose either in-line battery operated valves (#7001), in-line AC (electric) valves (#DM075), battery operated anti-siphon valves (2008-I), or manual anti-siphon valves. Please note that AC valve installations will involve running underground control wires back to an electric controller.

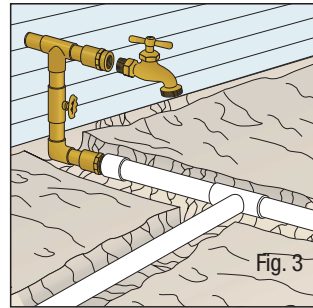
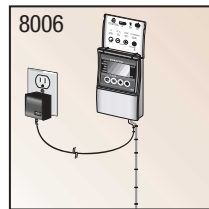

Fig. 3

**a. Underground installation using in-line battery operated controller (Fig. 4a):** Use model 7001 and complete the head assembly by attaching #6, MNPT filter and #5, pressure regulator. Use 3/4" #72, swivel adapter if the polytube is connected to the assembly. If connecting to a PVC pipe, use a 3/4" PVC female adapter.

**b. Underground installation using in-line AC valve (Fig. 4):** Use DIG model DM075 valve assembly, which is a complete drip zone head assembly; includes 3/4" electric valve, #6, filter, #5, pressure regulator and #72, swivel adapter. Or build your own system using the same parts individually. This assembly can be connected via electric wire to any available station on your irrigation controller or to DIG model #8006, AC controller with an independent program for each valve.



Note: Valve and head assembly should be installed into one standard rectangular valve box.

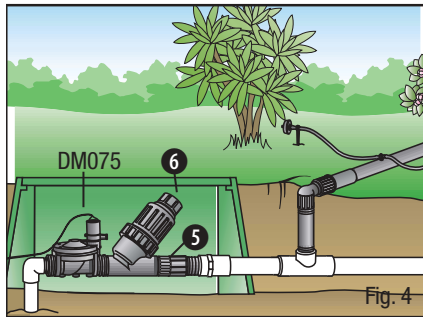

Fig. 4

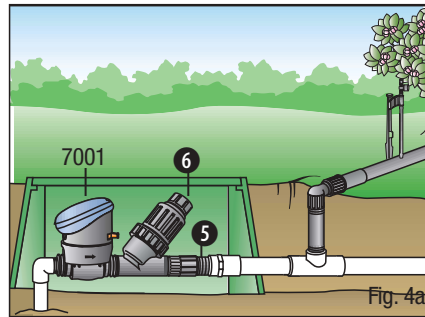

Fig. 4a

**c. Above the ground installation using a battery operated controller with anti-siphon valve (Fig. 5):** Use DIG model 2008-I and install it on a 10" to 12" 3/4" riser so it is at least 6" to 8" above the highest dripper or sprayer. Complete the head assembly by attaching a 3/4" #3, MNPT filter, a #5, pressure regulator to the downstream outlet. Finally attach a #16, 3/4" swivel adapter if using polytube, or 3/4" PVC female adapter if using PVC pipe.

**d. Above ground installation using a manual anti-siphon valve:** Use any 3/4" manual anti-siphon valve and install it 8" to 12" above grade. Again the downstream will consist of the #3, filter, #5, pressure regulator, and the #72, swivel adapter if using polytube, or a 3/4" PVC female adapter if using PVC pipe. These valves can be easily converted to automatic operation by installing the DIG model #2006-I, battery operated controller. Note: Backflow device (#10) is not required on systems controlled by anti-siphon valves.

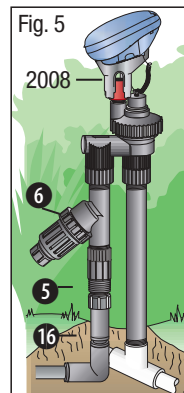

Fig. 5

**OPTION 3: BEGIN THE INSTALLATION BY RETROFITTING AN EXISTING 1/2" RISER (Fig. 6):** Install a drip system on an existing 1/2" riser by first unscrewing the sprinkler head from the riser and then screw #63, conversion elbow. Next attach a #4, pressure regulator (hose thread) and finally the #18, 3/4" swivel adapter. Now connect either 1/2" polytube or Earthline Brown PC™ dripline and secure the tubing or the dripline using #60, tubing holder stake. When combining drip irrigation with an existing sprinkler system, be sure to use high flow #34, 4 GPH drippers or #39, adjustable drippers with 0 to 20 GPH. After installing the drippers, open the valve and flush out the line. Then close off the end with a #71 end cap or #55, figure 8.

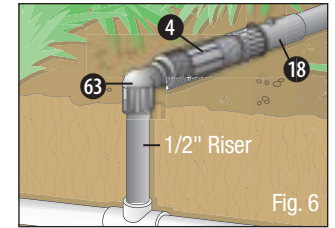

Fig. 6

If used with 1/4" microtube, after the pressure regulator, add a #21, adapter, connect the 1/4" microtube, and add #26, 1/4" tee as needed, and use with 4 GPH #34, drippers to a maximum flow rate of 35 GPH.

## Choosing Lateral Layout Installation

**INSTALLATION METHOD USING POLYTUBE AS THE MAIN LATERAL:** Install the 1/2" polytube above or below grade from the hose end, in-line controller, or in-line valve to the area to be watered. Use 1/2" #19, tee, 1/2" #20, elbow where needed, and from the tee or elbow extend additional polytube to the plant area. Secure all 1/2" polytube to the ground using #60, holder stakes. Use 1/4" microtube as the feeder line and add drippers as needed.

**INSTALLATION METHOD USING A PVC PIPE AS THE MAIN LATERAL:** Install a 3/4" PVC pipe below grade from the controller or in-line valve to the area to be watered. Connect the PVC pipe to the in-line valve or to the battery operated controller. In each area to be watered add a 3/4" PVC tee (3/4" slip x 1/2" FNPT), and to the tee add a 6" or 8" 1/2" riser. To the riser add a #63 conversion elbow, and then a #18, swivel adapter or #22, swivel tee. Attach the 1/2" polytube or Earthline Brown PC™ Dripline, and secure all 1/2" polytube and dripline to the ground using #60, holder stakes. Add drippers or microsprinklers as needed to the 1/2" polytube or use the 1/4" microtube as the feeder line to the plants and add the drippers at the end of the microtube.

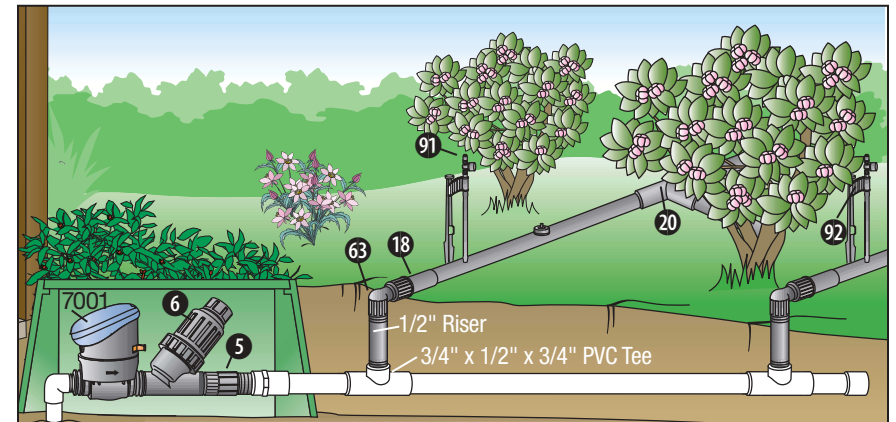

**1/2" POLYTUBE AND 1/4" MICROTUBE INSTALLATION:** Unroll the 1/2" polytube and lay it out in direct sunlight to warm it up and make it easier to work with. Use #60, stakes to secure the polytube to the ground. If the polytube is installed below grade, dig trenches 6" to 8" deep to keep the polytube a safe distance from cultivation practices. Leave the end of the polytube above the surface for periodic flushing.

If the installation requires crossing under a concrete walk or driveway, first dig two holes on opposite sides of the walkway. Next, connect a 3' to 5'-3/4" PVC pipe to a garden hose, using #7, hose to pipe thread adapter and a 3/4" PVC female thread x slip. Then turn on the water and begin forcing it through the soil. Be careful to avoid damage to the concrete walk or driveway. When the end of the pipe reaches the other side, turn off the water and cut the pipe so the hose and fittings can be removed. Now use the 3' to 5' PVC pipe as a sleeve and push the polytube through the pipe until it appears on the other side.

Once the 1/2" polytube has been installed, then the 1/4" microtube can be connected. First attach the microtube to the 1/4" barb or 1/4" tee, then use the punch (#52) to make a hole in the 1/2" polytube and then insert the barb or tee into the hole. Install a dripper or microsprayer at the end of the microtube and use it as a feeder line to reach remote plants or clusters of plants that are away from the main 1/2" polytube.

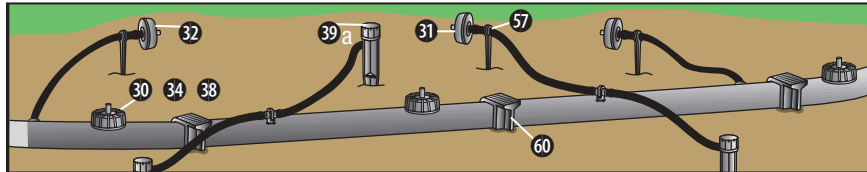

**COMPRESSION FITTING INSTALLATION:** To connect polytube use the compression fitting, cut the polytube with a hand pruner, being careful to keep dirt from entering the polytube. Hold the fitting in one hand and the tubing in the other and force the tubing into the fitting while moving from side to side. "Walk" the tubing into the fitting until about 1/2" to 3/4" of tubing is inside the fitting.

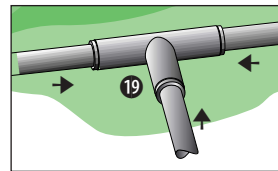
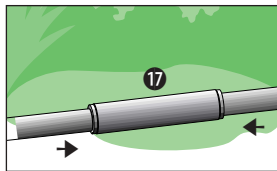
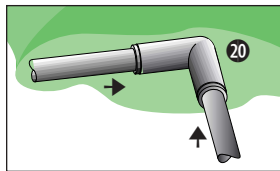

For TORO BLUE STRIPE™ tubing use our fittings with the blue insert: To connect various sizes of 1/2" polytube with different ODs, use our reducer coupling #14 for BLUE STRIPE™ and #15 for RAINDRIP™ or use our nut-lock fittings #73, coupling, #74, tee and #75, elbow for any size. Removing the nut and insert it over the polytube (any brand name). Insert the barb side of the nut lock into the ID side of the polytube, and insert the other side of the barb into the nut lock housing. Then thread the nut lock to secure.

**BARB FITTING INSTALLATION:** Barb fittings can be used to connect 1/4" to 1/2" or to connect two ends of 1/4" microtube. Insert the barb into the end of the 1/4" microtube by forcing the microtube over the 1/4" barb. To connect 1/2" polytube to 1/4" micro-tubing, punch a hole in the 1/2" polytube and insert one side of the 1/4" barb or tee. Then insert the other side of the barb or tee into the end of the 1/4" micro-tubing by forcing the microtube over the 1/4" barb.

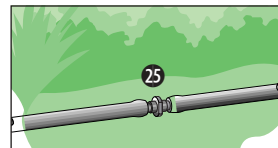
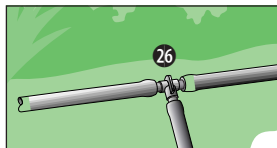
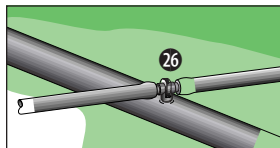
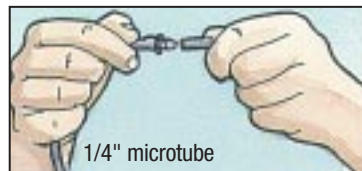

**USING THE PUNCH TOOLS:** DIG offers two different punches to use with your drip installation system. Both are easy to use. For a small number of drip emitters use our low cost punch. For a large number of emitters or for ease of operation, use the larger deluxe punch.

To use the small punch, hold the polytube in one hand. Using your free hand, apply just enough pressure on the punch while at the same time rotating the punch back and forth to create a hole in the polytube. To use the large deluxe punch, insert the polytube to the punch, and press the handle to punch a hole.

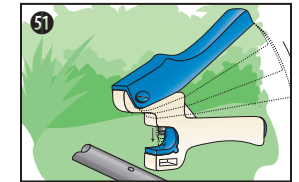
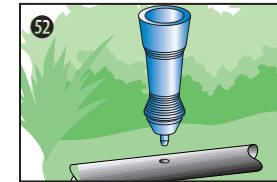
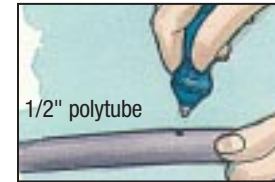

## Drip Emitter Installation

The drip emitters can be installed, using either one of the two methods, and in any installation both methods can be used.

The first method is for plants that are close to the 1/2" polytube. Punch a hole in the 1/2" polytube and snap the barb side of the dripper into the polytube. Make sure that the minimum spacing between the drippers is not less than 10".

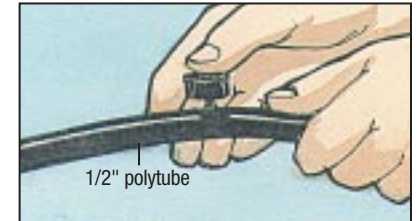

The second method is used for individual plants, and plants that are far away from the 1/2" polytube. Punch a hole in the 1/2" polytube, and insert a 1/4" #25, barb or a 1/4" #26, tee into the 1/2" polytube. Unroll, and attach the 1/4" microtube to the 1/4" barb or 1/4" tee, and then lay the microtube out to the individual plant or group of plants. Push the dripper into the end of the microtube and secure the dripper using a #57 or #67, microtube holder stake.

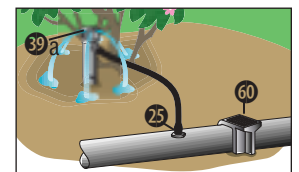
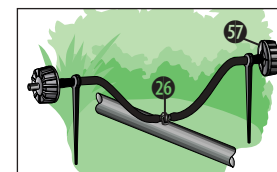
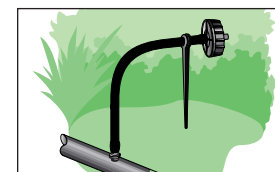
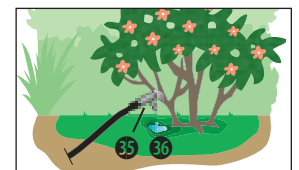
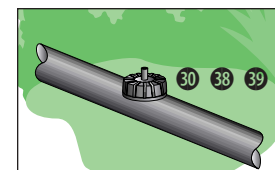
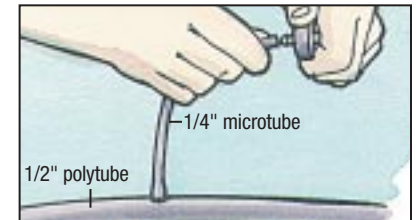

## Installation Example Drawings

### Drip Installation in Landscape

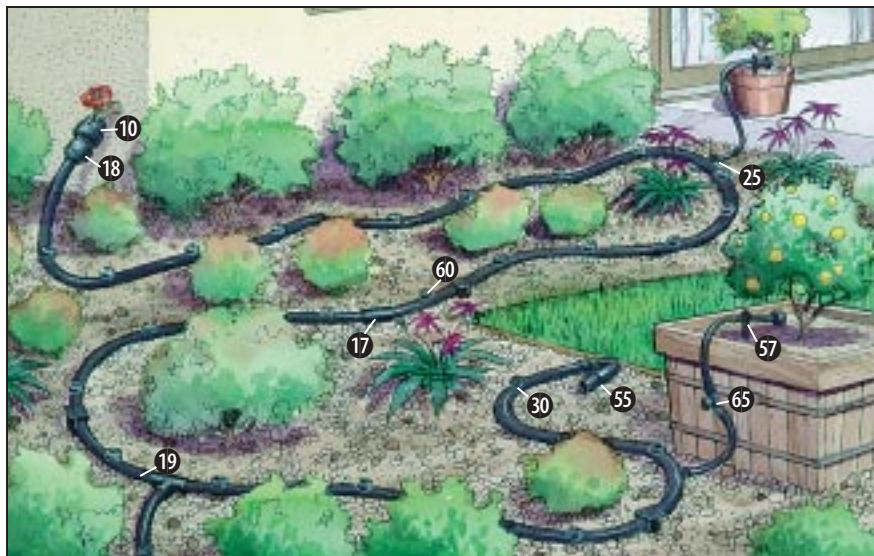

### Drip Installation in Vegetable Gardens

**W**hen installing drip irrigation in a vegetable garden with rows more than 2' apart, run one line for each row. If your rows are less than 2' apart, run one line between every two rows, and insert a 1/2 or 1 GPH dripper every 12". It is helpful to stagger the emitters between rows for more complete saturation.

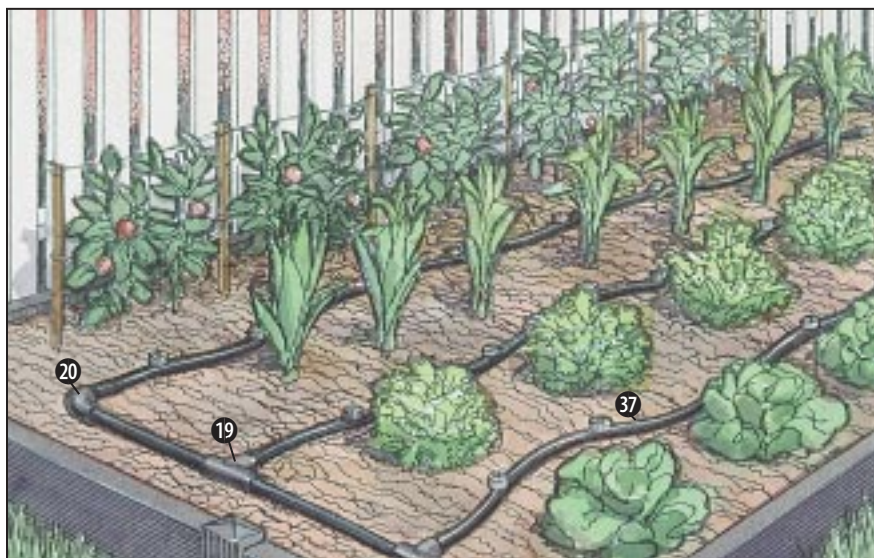

### Drip Installation in Patios

**F**or patios, your system may be run entirely from 1/4" microtube by using a combination of drippers and misters and 1/4" tees, elbows and barbs. Do not exceed 35 GPH on any single 1/4" microtube system.

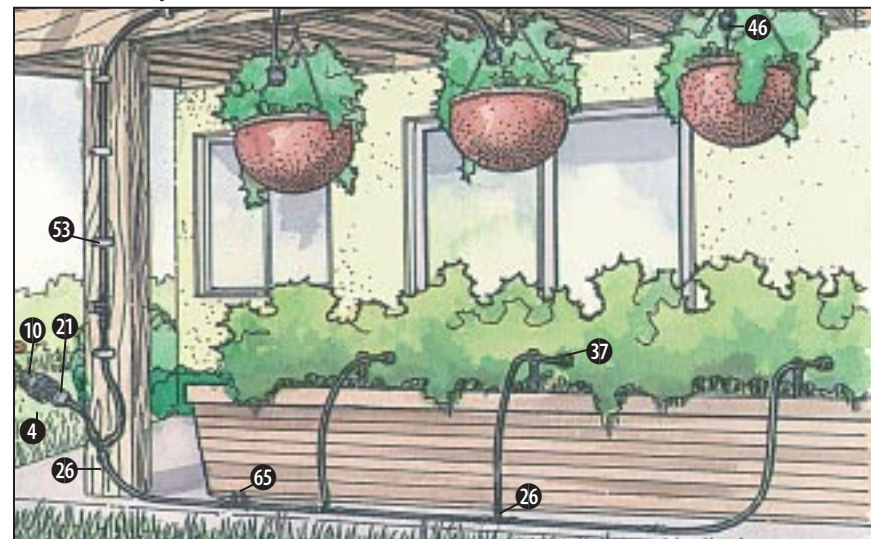

### Drip Soaker Tape Installation

**INSTALLING DRIP SOAKER TAPE LINE:** Drip Soaker Tape can be installed easily either above or below the ground. It is designed mainly for use in vegetable gardens or a long narrow row of vegetation. We recommend using 1/2" polytube as a main line, running perpendicular to the garden rows. Connect the drip soaker tape to the #29, reducer. Punch a hole in the 1/2" polytube at the connection point of each row, and insert the barbed end of #29, reducer. After running the polytube down the row, use #28, end to close the end. For vegetable rows more than 2' apart, run one line of drip soaker tape per row. If your rows are less than 2' apart, place the drip soaker tape between every two rows. We highly recommend the use of a 25 PSI pressure regulator with this system.

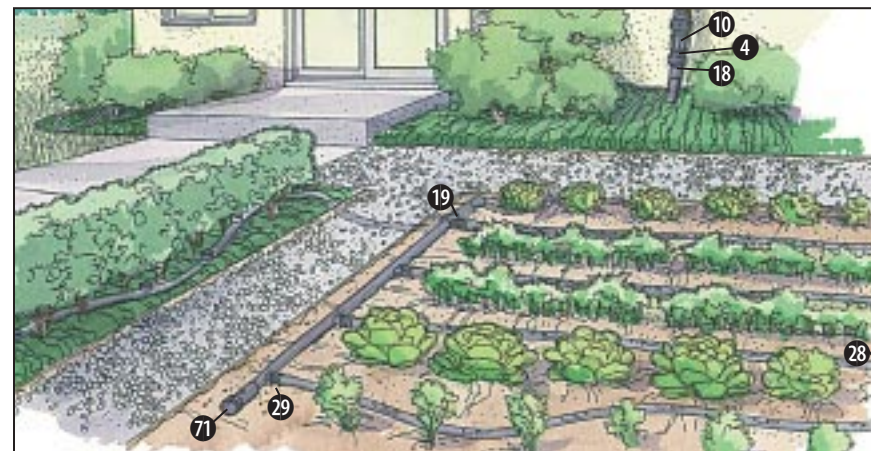

## Earthline Brown PC™ Dripline Installation

**EARTHLINE BROWN PC™ DRIPLINE INSTALLATION:** The dripline can be installed below or above the ground and if used above the ground it can be covered with mulch to blend it with the landscape. Earthline Brown PC™ Dripline can be used for installation in planters, islands, or landscape areas. To connect the dripline to the polytube, use compression fittings #19, tee, or #20, elbow and close the end of the line using #71, end cap or #55, figure "8". To start Earthline Brown PC™ from a 1/2" PVC riser, first screw #63, conversion elbow, then attach a #4 pressure regulator. To the pressure regulator, attach a #18, 3/4" swivel adapter. Connect the dripline to the swivel adapter, and lay the dripline in any configuration using #19, tee and #20, elbow. We recommend using Earthline Brown PC™ Dripline in 12" to 16" spacing between the lines on sandy soil, and 18" to 24" between the lines on loamy soil for the best coverage.

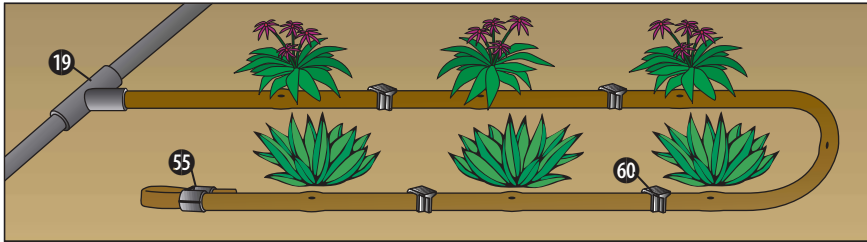

## Microsprinkler, Fogger and Sprayer Installation

DIG has a large selection of microsprinklers, microsprayers, and foggers with a wide range of patterns and flow rates. They are available with a take assembly or threaded barb. (See chart A1, B, and F on page 10 to 13 for details on spacing, coverage and flow rates).

**MINISPRINKLERS AND MICROSPRINKLERS:** Minisprinklers and microsprinklers are available in 360° patterns, and pre-assembled with 13" spike, 24" microtube and barb for maximum installation flexibility. They have a good uniformity of coverage with a range of 10' to 40' in diameter. To install, punch a hole in the 1/2" polytube and snap the 1/4" barb into the polytube. The microsprinklers should be raised a minimum of 8" above the ground for good uniformity and coverage.

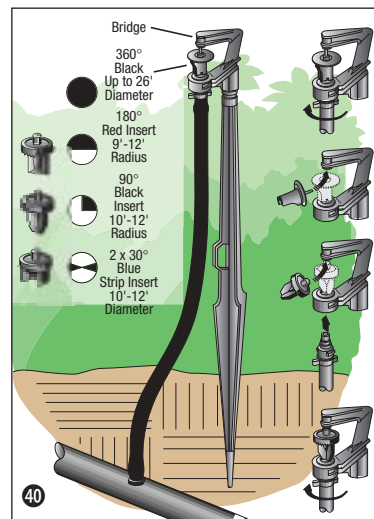
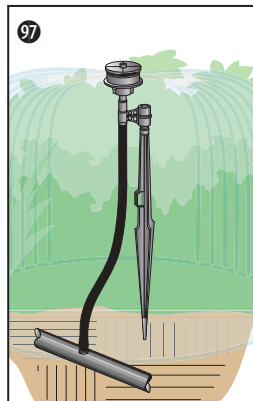
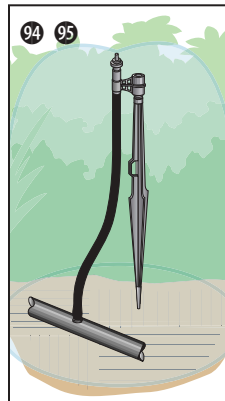

**MICROSPRAYERS AND MISTERS:** Microsprayers are available with strip, 90°, 180° and 360° in jets or spray pattern, with a range of 3' to 13' in diameter. They can be installed on the 1/2" polytube using the spike assembly or some of our accessories such as model #58, PE riser assembly with 1/4" barb, #68, universal spike assembly with microtube and barb, or #69, adjustable stake assembly. To install either one, punch a hole in the 1/2" polytube and snap the 1/4" barb into the polytube. The microsprayers should be raised a minimum of 4" to 8" above the ground for a good uniformity and coverage.

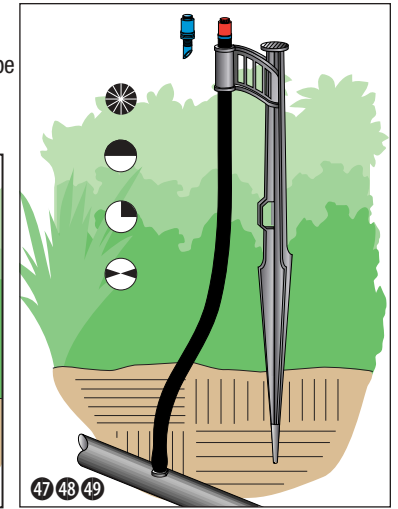
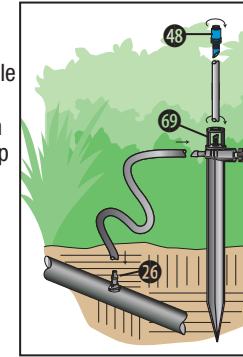

**ADJUSTABLE SPRAY JETS:** Adjustable microsprayers are available in 90°, 180° and 360° spray patterns with an adjustable flow range of 0 to 20 GPH, and with up to 20' in diameter. Consider using them along the perimeter or pathways of flowerbeds, or on closely spaced annuals and groundcovers. They can be installed into the 1/2" polytube using the spike assembly or some of our accessories such as model #58, PE riser assembly with 1/4" barb, or #68, universal spike assembly with microtube and barb. To install, punch a hole in the 1/2" polytube and snap the 1/4" barb of the assembly into the polytube. The adjustable microsprayers should be raised a minimum of 4" to 8" above the ground for a good uniformity and coverage.

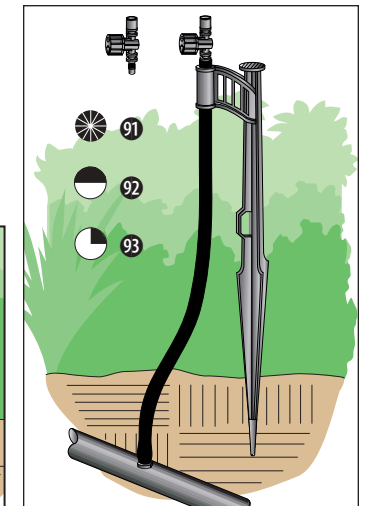
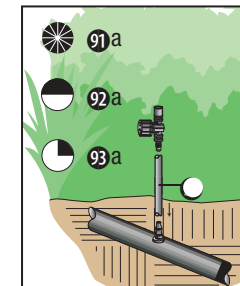

**FOGGERS:** Foggers are available with a barb, thread or with a small spike assembly in a low flow rate of .8 to 2 GPH. Suggested use is for small containers, baskets or for cooling. To install using the 1/2" polytube as the main line, punch a hole in the 1/2" polytube and insert a 1/4" barb, connect a 1/4" microtube to the barb, and run a length of 1/4" microtube to the basket. Attach the fogger and secure with #67, stake. To install using the 1/4" microtube as the main line, run the 1/4" microtube above the plant, secure the 1/4" microtube using #53, 1/4" C-clamp. Cut the microtube and connect #26, 1/4" tee to. Add a short length of microtube to the tee and attach the fogger.

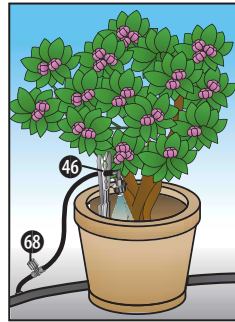
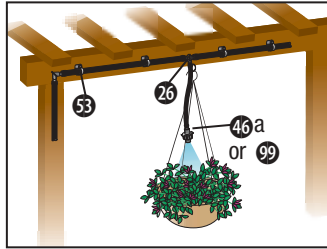

**POP-UP MICROSPRAYERS:** DIG's 12" Pop-up microsprayers are an excellent choice to install when the vegetation is higher than the microsprayer heads, or where they may adversely affected by heavy foot traffic, curious children, or landscape maintenance activities.

Many residential landscapes contain locations where the plant material is best irrigated with microsprinklers or microsprayers. Although DIG microsprayers on stakes are not easily seen there may be situations where it would be preferable if the sprayers were concealed, or less visible to the human eye. Consider installing Pop-up microsprayers on the perimeter of any flowerbed or small slope that contains closely spaced annuals, perennials or groundcovers. The heads will pop-up 12" and begin spraying only when the system is running.

The Pop-up microsprayers are available in 90°, 180°, and 360° pattern. They are easy to install, and connect to the 1/2" polytube via the barb.

First, dig a hole about 10" deep at the head location(s), then lay out a length of 1/2" polytube nearby. Punch a hole in the side of the polytube, and insert the barbed end of the Pop-up microtube into the hole. To complete the installation, set the head in the hole about 2" to 4" above finish grade and backfill. Remove the nozzle and flush the heads thoroughly before operation.

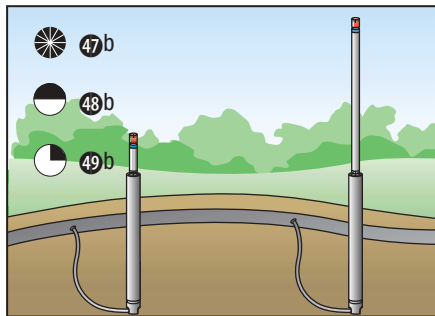

## Retrofit Products

Conserve water and reduce weeds at the same time! DIG's retrofit dripheads make it easy to convert a 1/2" sprinkler riser to an efficient drip irrigation system. Many residential gardens have existing high flow shrub sprinkler risers in place. Our single and multi outlet drip heads are designed to screw onto these risers and to simplify the connection of 1/4" microtube, drip emitters, and soaker hose. Choose from the #85, single outlet, #87, 4-outlet, #89, 6-outlet, #86, (adjustable), or Maverick™ 12-outlet drip head. Select the product according to the number of plants needing irrigation, and their water requirements.

**INSTALLATION:** Remove the existing sprinkler head and open the system valve momentarily to flush out the riser. Screw the drip head onto the riser. Measure the distance from the head to each plant and cut the microtube to the correct length for each plant (do not exceed 20' with any single length of microtube). Push the end of each microtube onto the barbed outlets of the drip head. Secure the

end of the each microtube near the perimeter of the plant with a #67, stabilizer stake. The microtubes may be buried or covered with mulch, but the ends should be left open.

**NOTES:** If the entire sprinkler system is not converted, use high flow drippers. Maverick™ and A4 heads are pressure compensating, pressure regulator is not required.

## Maverick™ 12-outlet, and Retrofit Installation

If you choose to retrofit a sprinkler riser, depending on the number of plants you wish to water, select either a 1-, 4-, 6- or 12-outlet drip head. Each retrofit head provides you with a number of features and with specific flow rates to cover all of your watering needs. (See pages 8 and 9 for detailed information).

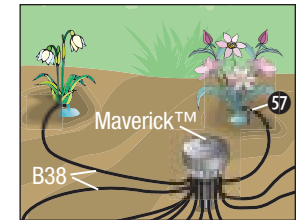
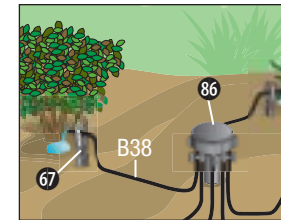
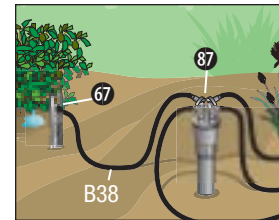

**MAVERICK™ 12-OUTLET DRIP SYSTEMS** convert an existing sprinkler riser into a 12-outlet drip system without disturbing the other sprinkler heads along the line. The Maverick™ is designed to operate with either 1/4" or 1/8" microtube, and has the option of closing off any zones that are not in use. DIG offers Maverick™ heads in a choice of three different flow rates. If combining Mavericks™ into an existing sprinkler line, use the Hi-Flow 4 GPH model. If you are replacing all of the sprinkler heads in a line, use the 1 or 2 GPH models. We recommend flushing the line before installation.

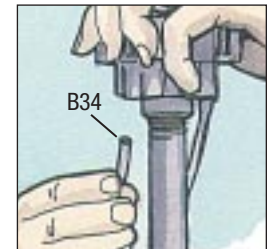

## 4- and 6-outlet Drip Heads Installation

Adjustable drip heads may also be installed directly on 1/2" sprinkler risers. With the 6-outlet #86, each outlet is adjustable between 1 and 20 GPH, and the four outlet #87 is preset at 6 GPH per zone. They allow you to use any combination of laser drilled soaker hose, drippers of various flow rates, or with a 1/4" microtube only. We recommend flushing the line before installation.

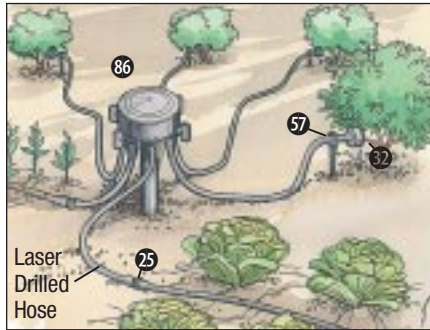

## 1/2" Riser Adapter (#90)

This popular retrofit fitting provides a simple connection using a single 1/4" microtube to a 1/2" shrub riser. Its perfect for container plants, groundcover or shrubs that are not covered by a nearby spray head. Any plant that needs supplemental irrigation will benefit from this system. The existing spray or Pop-up nozzle can be reconnected to the 1/2" male pipe threads on top, without affecting the system performance.

**INSTALLATION:** Unscrew spray nozzle from top of riser and momentarily open system valve to flush out the line. Connect #90, riser adapter to the top of the riser by turning clockwise until hand tight. Reattach the spray head to the top of the riser adapter or replace with a 1/2" FPT cap. Lay out the 1/4" microtube from the riser to the plant(s) and cut to the desired length. Push the end of the microtube onto the outlet barb. At the end of the microtube, install the appropriate emission device. Use #37, for small pots or baskets. Use #34, high flow drippers or #39, adjustable drippers if all of the heads are not capped. Open the system valve and check for leaks.

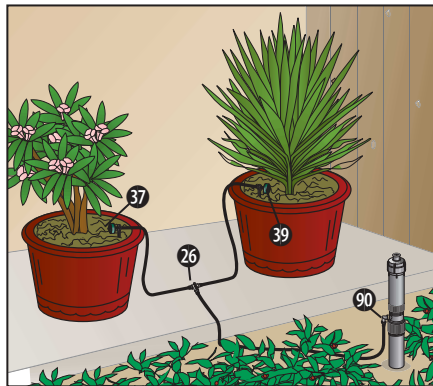

## Initial System Start-Up

Before turning the system on for the first time, leave all 1/2" polytube ends open and turn the water on and allow it to run freely for a few minutes. This will flush out any dirt that may be in the system. Close the end of the line by using either #55, hose end or #71, end cap. Check to see that the drippers and microsprinklers are operating correctly and that there are no leaks in the system. If leakage occurs on 1/2" polytube at the base of a dripper or microsprinkler, remove that dripper/microsprinkler, and insert a goof plug #56 to close the hole and reinsert the dripper or microsprinkler in a another area.

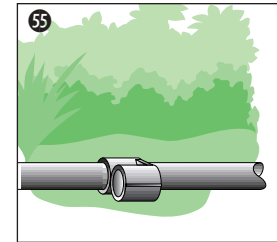
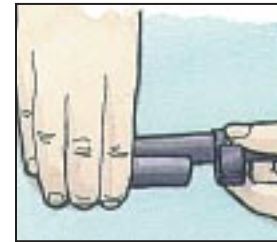

Step 1

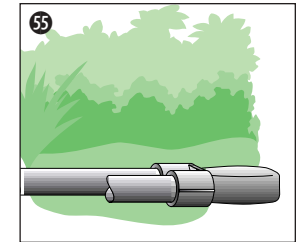

Step 2

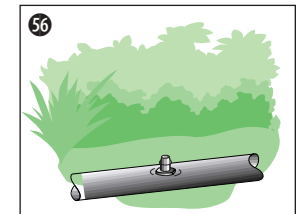

## Problems; Potential Causes and Solutions

- **AC VALVE DOES NOT OPERATE PROPERLY:**  
 WRONG VALVE SIZE, FLOW TOO LOW: replace with correct size valve  
 DIAPHRAGM ORIFICE IS PLUGGED: clean or replace diaphragm  
 SOLENOID FAULTY: check wiring or replace solenoid
- **BATTERY OPERATED CONTROLLER DOES NOT OPERATE PROPERLY:**  
 CHECK THE BATTERY, make sure the 9-volt controller battery is good, replace battery
- **BATTERY OPERATED CONTROLLER DOES NOT CLOSE:**  
 PUPPET IS MISSING, "O" ring #2 is missing, lever is in the open position: Call 1-800-322-9146  
 SOLENOID PLUNGER is missing or upside down  
 VALVE is installed backwards
- **NO WATER FLOW FROM DRIPPERS OR MICROSPRINKLERS:**  
 THE USE OF A PROPER FILTER SHOULD AVOID CLOGGING PROBLEMS. If you do find clogged drippers, here is a step to try: Clean the screen in the swivel adapter or open the filter and clean the screen by washing with water  
 END OF LINE IS OPEN
- **PRESSURE REGULATOR LEAKING:**  
 DIRT INSIDE THE PRESSURE REGULATOR: remove from line, remove the washer and clean  
 REGULATOR IS INSTALLED ON MAIN LINE. Move to downstream side of control valve.
- **DRIPPERS OR MICROSPRINKLERS HAVE UNEVEN OR NO FLOW:**  
 LINE BROKEN, FILTER CLOGGED, DRIPPER CLOGGED OR FAULTY, OR PRESSURE TOO LOW: check dripline, clean or replace screen filter, replace or clean dripper or nozzle of microsprinkler, check pressure regulator
- **DRIPPERS OR MICROSPRINKLERS HAVE UNEVEN OR NO FLOW AT THE END OF THE DRIPLINE:**  
 TOO MANY DRIPPERS ON THE DRIPLINE: make sure that you did not exceed the total maximum recommended flow rates of 220 GPH

■ **BACKFLOW PREVENTER LEAKS OR VIBRATES:**

Make sure it is installed downstream of timer and not on a main line

■ **FITTINGS SEPARATING FROM 1/2" POLYTUBE:**

FITTINGS IMPROPERLY INSTALLED: tubing is not far enough inside the compression fitting  
WRONG FITTINGS USED WITH DIG POLYTUBE WITH .700 OD: cut the 1/2" polytube and make sure you use .700 OD fitting with color code black insert

■ **DRIPPERS OR MICROSPRINKLERS POPPING OUT OF POLYTUBE:**

PRESSURE REGULATOR IS DEFECTIVE: replace or clean pressure regulator  
PRESSURE IS TOO HIGH: install pressure regulator or replace  
DRIPPERS OR microsprinklers ARE INSTALLED IMPROPERLY: faulty or worn punch, check or replace drippers or microsprinklers, plug hole with #56 goof plug, replace or clean punch.

■ **CLOGGED DRIPPERS:**

THE USE OF A PROPER FILTER SHOULD AVOID CLOGGING PROBLEMS. if you do find clogged drippers, here is a step to try: while the water is on, hold your finger over the dripper outlet for a few seconds. This "back flushing" will usually work.

■ **A LOT OF CLOGGED DRIPPERS:**

IF MANY DRIPPERS ARE CLOGGED: chances are there is a break in the line – check your 1/2" polytube

■ **NO WATER FLOW FROM MICROSPRINKLERS MODEL 8855-XX:**

PROBLEM OCCURS IN A MICROSPRINKLER MODEL 8855, 8855-1 ON A SPIKE OR 8855-5 ON A SPIKE: remove "C" shaped head from base, remove nozzle from "C" shaped head and rinse nozzle thoroughly under water (see page 28 for details)

■ **THREADED FITTINGS ARE LEAKING:**

CHECK THREAD TYPE (hose or pipe) and do not combine hose thread with pipe thread fittings.

■ **DRIPPERS OR MICROSPRINKLERS HAVE CALCIUM DEPOSITS (WHITE COLOR BUILDUP):**

HARD WATER: you can remove the drippers or microsprinklers from the line and soak for one hour in a weak chlorine solution

■ **PLANTS APPEAR STRESSED:**

DRIPPERS NEAR THE PLANTS ARE PLUGGED: replace drippers, check filter and clean  
BREAK IN THE POLYTUBE: repair break using #17 connector or #56 goof plug  
RUN TIME IS INADEQUATE FOR PLANTS: add more time to the controller station

## Glossary

- **ANTI-SIPHON VALVE** – A valve, usually plastic or brass, used to control the flow of water in one direction. It will prevent a backflow of water into the potable water supply.
- **AVB** – Atmospheric Vacuum Breaker (backflow preventer)
- **DRIP SOAKER TAPE LINE**– A thin walled dripline with drippers preinserted into the line at preset spacings.
- **EARTHLINE DRIPLINE** – 1/2" polytube with PC drippers preinserted
- **FHT** – Female Hose Thread
- **FNPT** – Female National Pipe Thread
- **GPH** – Gallons Per Hour. Used to measure the flow rate of low volume irrigation.

- **GPM** – Gallons per minute. Used to measure the flow rate of sprinkler heads.

- **LASER DRILLED SOAKER HOSE** – A 1/4" microtube with laser cut holes at preset spacings.

- **MHT** – Male Hose Thread

- **MICROTUBE** – 1/4" and 1/8" vinyl or polyethylene tubing

- **MNPT** – Male National Pipe Thread

- **PC** – Pressure Compensating

- **PE** – Polyethylene tube (polytube)

- **PSI** – Pounds per square inch in static water pressure. Used to measure pressure. For example, the recommended operating pressure of a drip irrigation system is 25 PSI.

- **PVC** – Rigid plastic pipe

## Maintenance

- Inspect drippers, microsprinklers and microtube periodically to ensure that the drippers have not clogged and the microtube has not moved.
- Filter screens should be flushed and cleaned at least once a month, depending on water quality. A check of the filter one week after installation should give you an idea on how often to schedule cleaning.
- Tubing lines should also be flushed periodically, again, water quality will determine the frequency of flushing.
- *During freezing weather, we recommend draining your polytube or rolling it up and storing it.*
- Remove end caps and open hose ends to flush the line once a year.
- As your landscape matures, you may need to add, change or remove drippers or microsprinklers. Consult Chart A on page 15 for recommendations.