



Standards Assessments

Geometry

FSA Mathematics

Practice Test Answer Key

The purpose of these practice test materials is to orient teachers and students to the types of questions on paper-based FSA tests. By using these materials, students will become familiar with the types of items and response formats they may see on a paper-based test. The practice questions and answers are not intended to demonstrate the length of the actual test, nor should student responses be used as an indicator of student performance on the actual test. The practice test is not intended to guide classroom instruction.

All trademarks and trade names found in this publication are the property of their respective owners and are not associated with the publishers of this publication.





Session 1



Session 1

FSA Mathematics Practice Test Answer Key

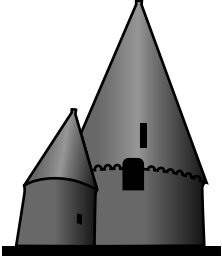
1. Match each building with the geometric shapes that can be used to model it.

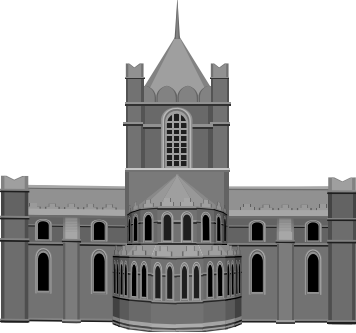
	Cone	Cylinder	Pyramid	Rectangular Prism
	●	●	Ⓒ	Ⓓ
	Ⓔ	●	Ⓖ	●
	●	●	●	●

2. In the diagram shown, chords AB and CD intersect at E . The measure of \widehat{AC} is 120° , the measure of \widehat{DB} is $(2x)^\circ$, and the measure of $\angle AEC$ is $(4x)^\circ$.

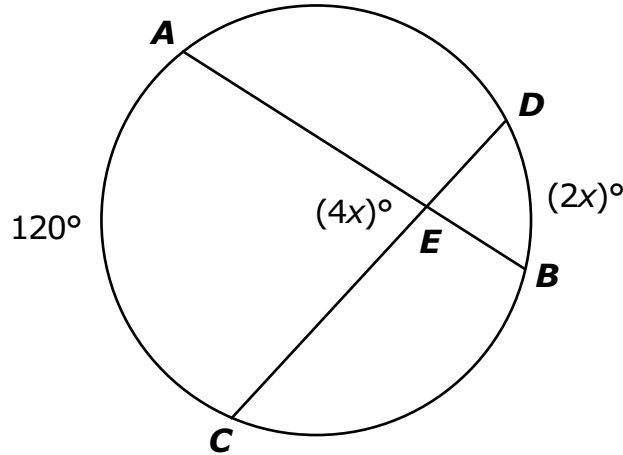

What is the degree measure of $\angle AED$?

				1	0	0
-	-	-	-	-	-	-
/	/	/	/	/	/	/
.
0	0	0	0	0	●	●
1	1	1	1	●	1	1
2	2	2	2	2	2	2
3	3	3	3	3	3	3
4	4	4	4	4	4	4
5	5	5	5	5	5	5
6	6	6	6	6	6	6
7	7	7	7	7	7	7
8	8	8	8	8	8	8
9	9	9	9	9	9	9

3. Triangle SRT is shown.

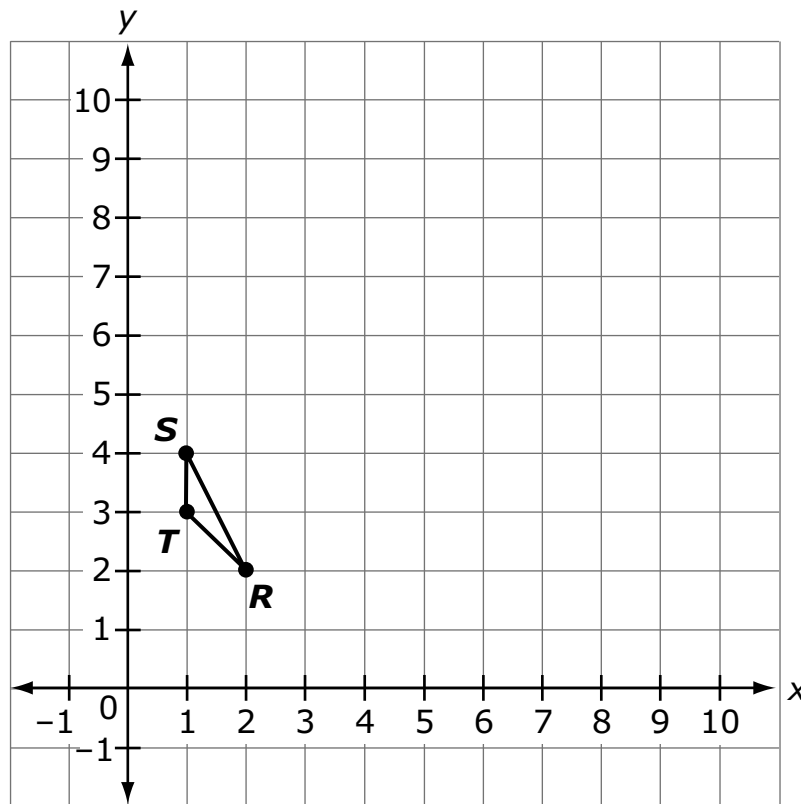

Choose the correct equation or word to fill in each blank in the paragraph. For each blank, fill in the circle **before** the equation or word that is correct.

The vertices of $\triangle SRT$ are $S(1, 4)$, $R(2, 2)$ and $T(1, 3)$. A reflection across the line _____ [A $x = 4$ B $x = 6$ C $y = -x + 5$ D $y = -x + 6$] and then across the line _____ [A $y = 6$ B $y = 8$ C $y = -x + 10$ D $y = -x + 12$] is the same as a translation of 4 units to the right and 4 units up because the lines are _____ [A congruent B parallel C perpendicular D similar].

4. Johnny wants to find the equation of a circle with center $(3, -4)$ and a radius of 7. He uses the argument shown.

Choose the correct word or phrase to fill in each blank in the argument. For each blank, fill in the circle **before** the word or phrase that is correct.

Johnny's Argument

Let (x, y) be any point on the circle. Then, the horizontal distance from (x, y) to the center is _____.

- $|x - 3|$
- $|x + 3|$
- $|x - 4|$
- $|x + 4|$

The vertical distance from (x, y) to the center is _____.

- $|y - 3|$
- $|y + 3|$
- $|y - 4|$
- $|y + 4|$

The total distance from (x, y) to the center is the radius of the circle, 7. The _____ can now be used to create an equation that shows the relationship between the horizontal, vertical, and total distance of (x, y) to the center of the circle.

- perimeter formula
- Pythagorean Theorem
- quadratic formula

5. Regular pentagon $EFGHI$ with center K is shown.

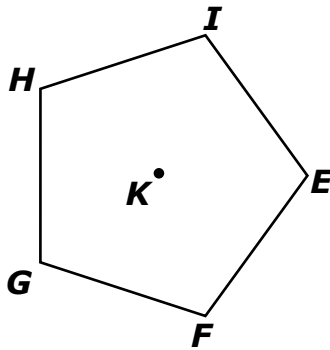

Select all the transformations that carry pentagon $EFGHI$ onto itself.

- a reflection across line EK , a 180° counterclockwise rotation about point K , and a reflection across a vertical line through point K
- a 90° counterclockwise rotation about point E , a reflection across line FG , and a vertical translation
- a reflection across line FI , a reflection across line GH , and a 180° clockwise rotation about point K
- a reflection across a vertical line through point K , a 180° clockwise rotation about point K , and a reflection across line EK
- a 180° clockwise rotation about point E , a reflection across a vertical line through point E , and a reflection across a horizontal line through point E

6. Alejandro cut a circle with circumference C and radius r into 8 congruent sectors and used them to make the figure shown.

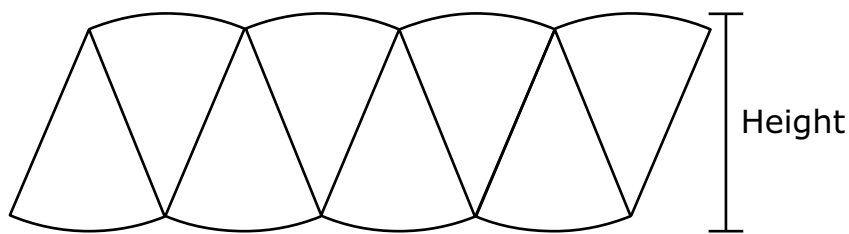

Alejandro noticed that the figure was very close to the shape of a parallelogram.

Select all the statements that apply to the figure.

- (A) The height of the parallelogram is approximately equal to the circle's diameter.
- The area of the parallelogram is approximately $\frac{1}{2} Cr$.
- (C) The length of the parallelogram is approximately equal to the circle's circumference.
- The radius of the circle is approximately equal to the height of the parallelogram.
- The area of the parallelogram is approximately $8\left(\frac{45}{360}\pi r^2\right)$.

7. Evelyn is designing a pattern for a quilt using polygon $EQFRGSHP$ shown.

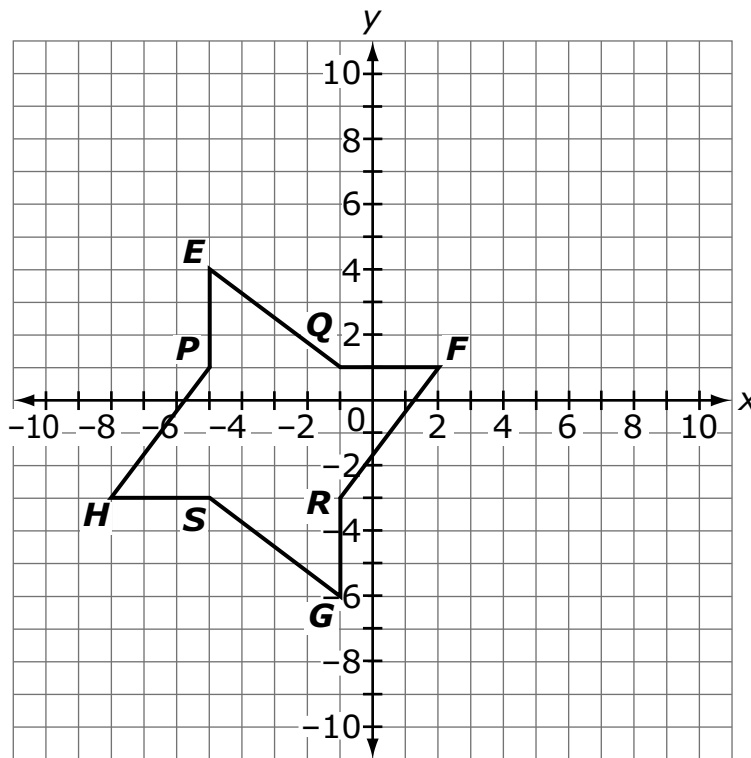

Evelyn transforms $EQFRGSHP$ so that the image of E is at $(2, 0)$ and the image of R is at $(6, -7)$.

Which transformation could Evelyn have used to show $EQFRGSHP$ and its image are congruent?

- (A) $EQFRGSHP$ was reflected over the line $y = x + 2$.
- (B) $EQFRGSHP$ was translated right 7 units and down 4 units.
- (C) $EQFRGSHP$ was rotated 135 degrees clockwise about the point Q .
- (D) $EQFRGSHP$ was rotated 90 degrees clockwise about the point $(-3, -1)$.

8. Katherine uses $\triangle ABC$, where $\overline{DE} \parallel \overline{AC}$ to prove that a line parallel to one side of a triangle divides the other two sides proportionally. A part of her proof is shown.

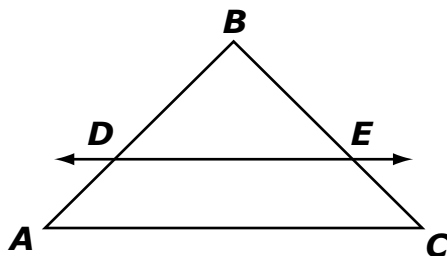

Statements	Reasons
1. $\overline{DE} \parallel \overline{AC}$	1. Given
2. $\angle BDE \cong \angle BAC$ and $\angle BED \cong \angle BCA$	2.
3. $\triangle BAC \sim \triangle BDE$	3.
4. $\frac{BA}{BD} = \frac{BC}{BE}$	4.
5. $BA = BD + DA$; $BC = BE + EC$	5. Segment addition postulate
6.	6.
7.	7.
8.	8. Subtraction property of equality

Which statement completes step 8 of the proof?

- (A) $BA - BD = DA$ and $BC - BE = EC$
- (B) $AD = BD$ and $CE = BE$
- (C) $\frac{BA}{BC} = \frac{DA}{EC}$
- $\frac{DA}{BD} = \frac{EC}{BE}$

9. A rectangle and a horizontal line segment are shown.

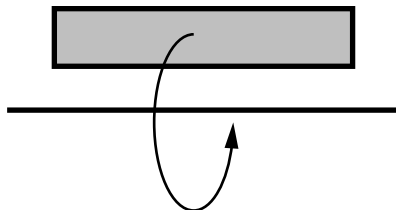

What is the resulting object when the rectangle is rotated around the horizontal line segment?

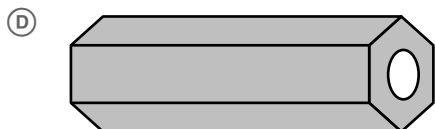
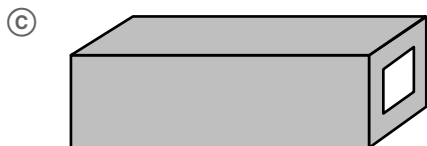
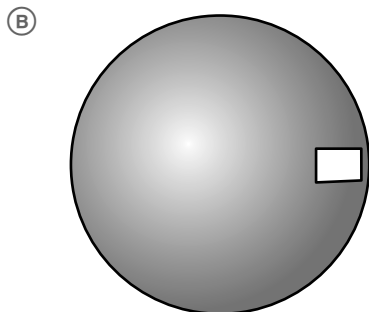

10. Triangle RTV is shown on the graph.

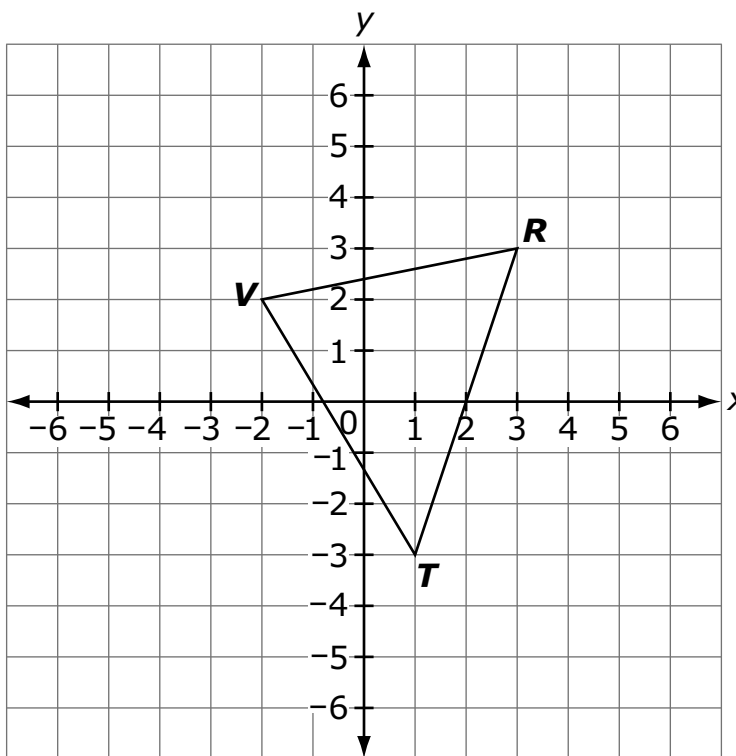

Triangle $R'T'V'$ is formed using the transformation $(0.2x, 0.2y)$ centered at $(0, 0)$.

Select the three equations that show the correct relationship between the two triangles based on the transformation.

- $RV = 5R'V'$
- $\frac{R'V'}{RV} = \frac{\sqrt{26}}{0.2\sqrt{26}}$
- $0.2\sqrt{10}RT = \sqrt{10}R'T'$
- $RT = 0.2R'T'$
- $0.2T'V' = TV$
- $\frac{TV}{T'V'} = \frac{\sqrt{34}}{0.2\sqrt{34}}$



This is the end of Session 1.





Session 2



12. Quadrilateral $MATH$ is shown.

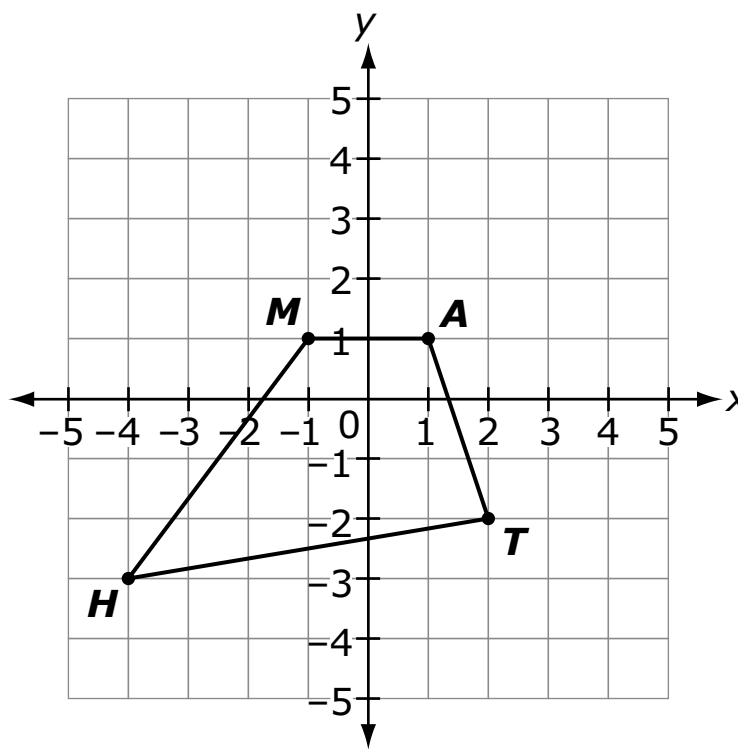

Quadrilateral $MATH$ is dilated by a scale factor of 2.5 centered at $(1, 1)$ to create quadrilateral $M'A'T'H'$.

Select all the statements that are true about the dilation.

- Ⓐ $\overline{MA} \cong \overline{M'A'}$
- Ⓑ $\overline{A'T'}$ will overlap \overline{AT} .
- Ⓒ $\overline{M'A'}$ will overlap \overline{MA} .
- Ⓓ The slope of \overline{HT} is equal to the slope of $\overline{H'T'}$.
- Ⓔ The area of $M'A'T'H'$ is equal to 2.5 times the area of $MATH$.

13. One diagonal of square $EFGH$ is shown on the coordinate grid.

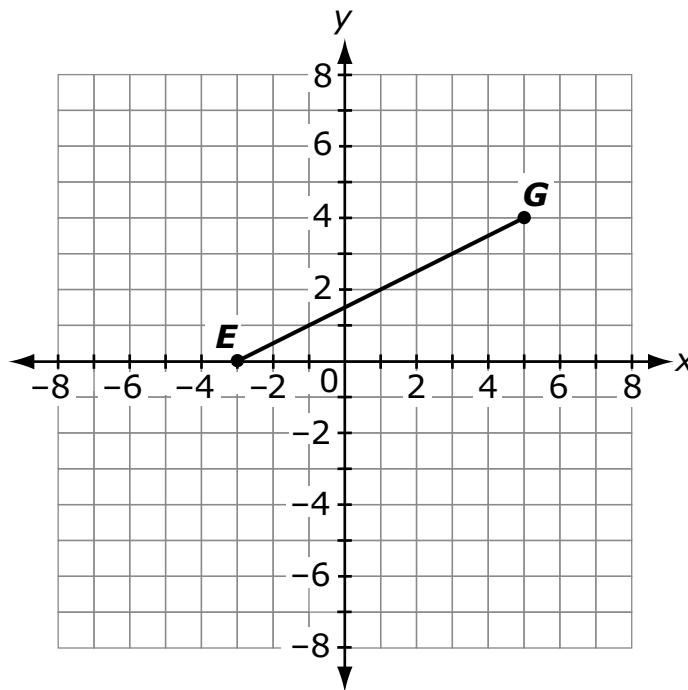

Choose the correct option to fill in each blank below. For each blank, fill in the circle **before** the option that is correct.

The location of point F could be _____ [(A) $(-3, 4)$ $(-1, 6)$ (C) $(1, -8)$] because diagonals of a square are congruent and _____ [(A) have the same slope (B) bisect each other are perpendicular].

14. Polygon $ABCDE$ is shown on the coordinate grid.

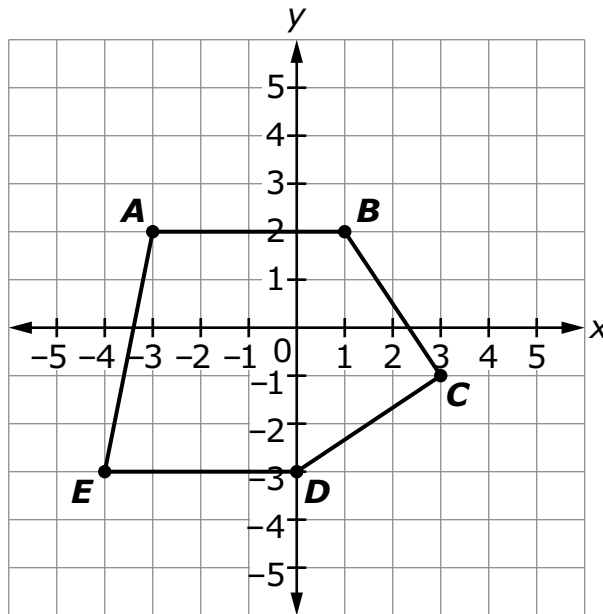

What is the perimeter, to the nearest hundredth of a unit, of polygon $ABCDE$?

		2	0	.	3	1
<input type="radio"/>	<input type="radio"/>	<input type="radio"/>	<input type="radio"/>	<input type="radio"/>	<input type="radio"/>	<input type="radio"/>
<input type="radio"/>	<input type="radio"/>	<input type="radio"/>	<input type="radio"/>	<input type="radio"/>	<input type="radio"/>	<input type="radio"/>
<input type="radio"/>	<input type="radio"/>	<input type="radio"/>	<input type="radio"/>	<input checked="" type="radio"/>	<input type="radio"/>	<input type="radio"/>
<input type="radio"/>	<input type="radio"/>	<input type="radio"/>	<input checked="" type="radio"/>	<input type="radio"/>	<input type="radio"/>	<input type="radio"/>
<input type="radio"/>	<input type="radio"/>	<input type="radio"/>	<input type="radio"/>	<input type="radio"/>	<input checked="" type="radio"/>	<input type="radio"/>
<input type="radio"/>	<input type="radio"/>	<input type="radio"/>	<input type="radio"/>	<input type="radio"/>	<input type="radio"/>	<input type="radio"/>
<input type="radio"/>	<input type="radio"/>	<input type="radio"/>	<input type="radio"/>	<input type="radio"/>	<input type="radio"/>	<input type="radio"/>
<input type="radio"/>	<input type="radio"/>	<input type="radio"/>	<input type="radio"/>	<input type="radio"/>	<input type="radio"/>	<input type="radio"/>
<input type="radio"/>	<input type="radio"/>	<input type="radio"/>	<input type="radio"/>	<input type="radio"/>	<input type="radio"/>	<input type="radio"/>
<input type="radio"/>	<input type="radio"/>	<input type="radio"/>	<input type="radio"/>	<input type="radio"/>	<input type="radio"/>	<input type="radio"/>
<input type="radio"/>	<input type="radio"/>	<input type="radio"/>	<input type="radio"/>	<input type="radio"/>	<input type="radio"/>	<input type="radio"/>
<input type="radio"/>	<input type="radio"/>	<input type="radio"/>	<input type="radio"/>	<input type="radio"/>	<input type="radio"/>	<input type="radio"/>
<input type="radio"/>	<input type="radio"/>	<input type="radio"/>	<input type="radio"/>	<input type="radio"/>	<input type="radio"/>	<input type="radio"/>

15. Ruben carries out a construction using $\triangle ABC$. A sequence of diagrams shows a part of his construction.

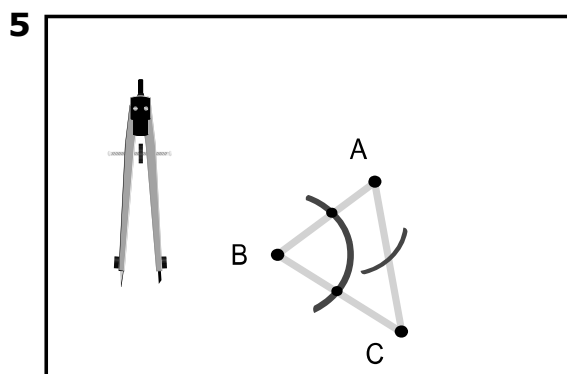
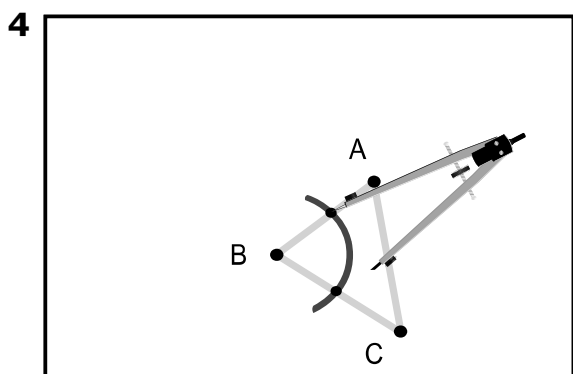
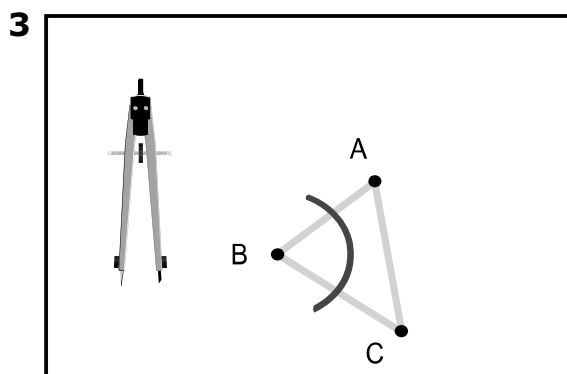
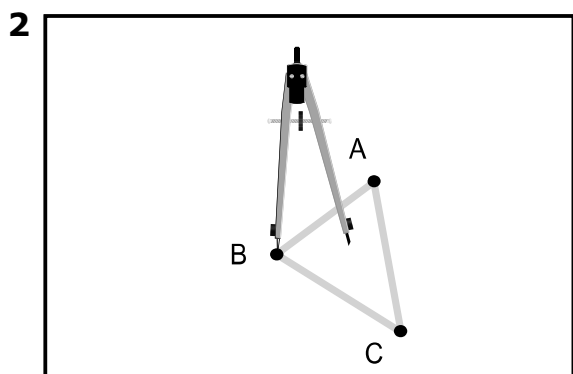
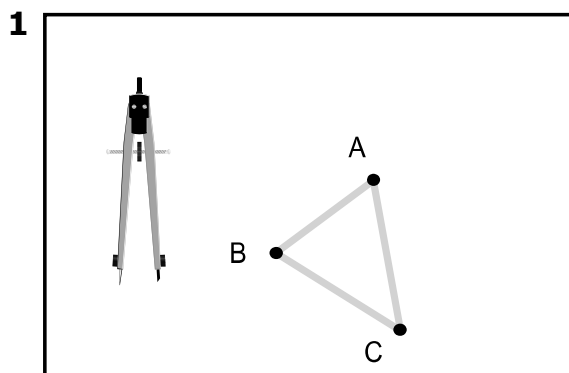

What will be the result of Ruben's construction?

- Ⓐ Ruben constructs a segment perpendicular to \overline{AC} .
- Ⓑ Ruben constructs the bisector of \overline{AC} .
- Ⓒ Ruben constructs an angle congruent to $\angle B$.
- Ruben constructs the bisector of $\angle B$.

16. As phosphate is mined, it moves along a conveyor belt, falling off of the end of the belt into the shape of a right circular cone, as shown.

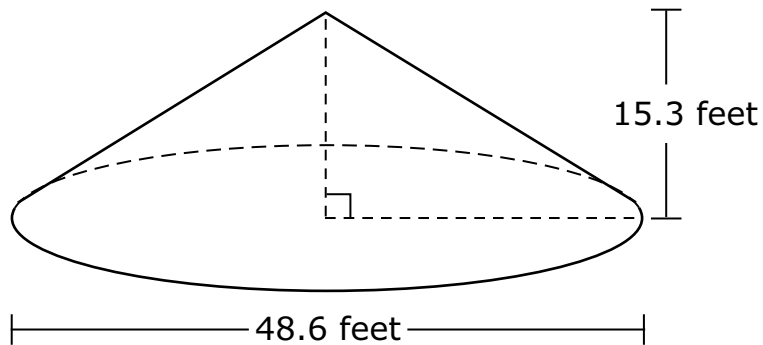

A shorter conveyor belt also has phosphate falling off of the end into the shape of a right circular cone. The height of the second pile of phosphate is 3.6 feet shorter than the height of the first. The volume of both piles is the same.

To the nearest tenth of a foot, what is the diameter of the second pile of phosphate?

			5	5	.	6
-	-	-	-	-	-	-
/	/	/	/	/	/	/
•	•	•	•	•	•	•
0	0	0	0	0	0	0
1	1	1	1	1	1	1
2	2	2	2	2	2	2
3	3	3	3	3	3	3
4	4	4	4	4	4	4
5	5	5	•	•	5	5
6	6	6	6	6	6	•
7	7	7	7	7	7	7
8	8	8	8	8	8	8
9	9	9	9	9	9	9

17. Gabriel wrote a partial narrative proof to prove $\overline{FD} \cong \overline{BD}$.

Given: \overline{AD} bisects $\angle EAC$
 $\angle FDA \cong \angle BDA$

Prove: $\overline{FD} \cong \overline{BD}$

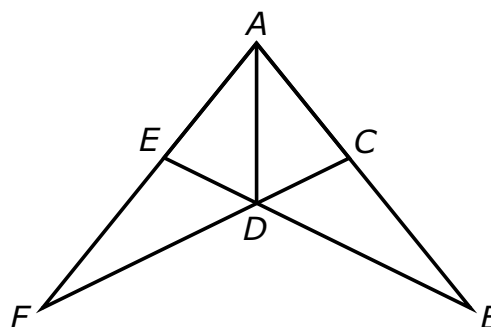

There are three blanks in the proof below. Choose the correct option to fill in each blank. For each blank, fill in the circle **before** the option that is correct.

It is given that \overline{AD} bisects $\angle EAC$, and $\angle FDA \cong \angle BDA$. Since \overline{AD} bisects $\angle EAC$, then $\angle DAE \cong \angle DAC$ from the definition of angle bisector. $\overline{AD} \cong \overline{AD}$ by the reflexive property.

Δ _____ [A DAE B DAC C DEF D CDF E DAF F DAB] is congruent to Δ _____ [A DAE B DAC C DEF D CDF E DAF F DAB] because of _____ [A SSS B SAS C AAS D ASA].

Therefore, $\overline{FD} \cong \overline{BD}$ because corresponding parts of congruent triangles are congruent.

Other correct responses: option F, DAB; then option E, DAF; then option D, ASA

18. The population of Florida in 2010 was 18,801,310 and the land area was 53,625 square miles. The population increased 5.8% by 2014.

A. To the nearest whole number, what is the population density, in people per square mile, for Florida in 2014?

				3	7	1
-	-	-	-	-	-	-
/	/	/	/	/	/	/
.
0	0	0	0	0	0	0
1	1	1	1	1	1	●
2	2	2	2	2	2	2
3	3	3	3	●	3	3
4	4	4	4	4	4	4
5	5	5	5	5	5	5
6	6	6	6	6	6	6
7	7	7	7	7	●	7
8	8	8	8	8	8	8
9	9	9	9	9	9	9

B. To the nearest whole number, how much did the population density, in people per square mile, increase from 2010 to 2014?

				2	0
-	-	-	-	-	-
/	/	/	/	/	/
.
0	0	0	0	0	●
1	1	1	1	1	1
2	2	2	2	2	●
3	3	3	3	3	3
4	4	4	4	4	4
5	5	5	5	5	5
6	6	6	6	6	6
7	7	7	7	7	7
8	8	8	8	8	8
9	9	9	9	9	9

19. The Leaning Tower of Pisa is 56.84 meters (m) long.

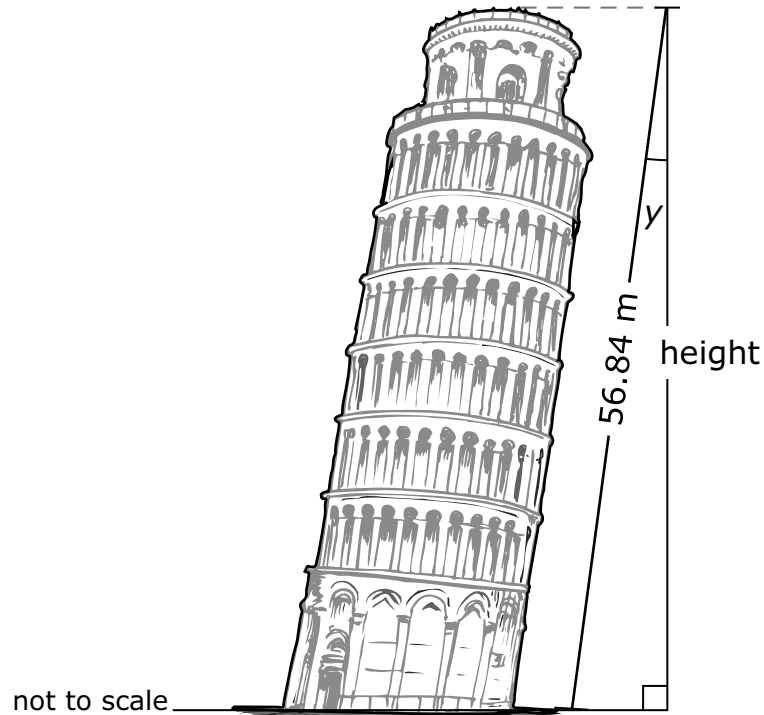

In the 1990s, engineers restored the building so that angle y changed from 5.5° to 3.99° .

To the nearest hundredth of a meter, how much did the restoration change the height of the Leaning Tower of Pisa?

			0	.	1	2
-	-	-	-	-	-	-
/	/	/	/	/	/	/
•	•	•	•	•	•	•
0	0	0	0	0	0	0
1	1	1	1	1	1	1
2	2	2	2	2	2	2
3	3	3	3	3	3	3
4	4	4	4	4	4	4
5	5	5	5	5	5	5
6	6	6	6	6	6	6
7	7	7	7	7	7	7
8	8	8	8	8	8	8
9	9	9	9	9	9	9



This is the end of Session 2.



BLANK PAGE



Office of Assessment
Florida Department of Education, Tallahassee, Florida
Copyright © 2015 State of Florida, Department of State