

FUEL SYSTEM AND THROTTLE BODY

CONTENTS

FUEL SYSTEM	5- 2
FUEL DELIVERY SYSTEM.....	5- 2
FUEL PUMP	5- 3
FUEL PRESSURE REGULATOR.....	5- 4
FUEL INJECTOR	5- 4
FUEL PUMP CONTROL SYSTEM.....	5- 5
FUEL TANK LIFT-UP.....	5- 6
FUEL TANK REMOVAL.....	5- 6
FUEL TANK INSTALLATION	5- 7
FUEL PRESSURE INSPECTION.....	5- 8
FUEL PUMP INSPECTION	5- 9
FUEL PUMP RELAY INSPECTION.....	5-10
FUEL PUMP AND FUEL FILTER REMOVAL	5-10
FUEL MESH FILTER INSPECTION AND CLEANING	5-12
FUEL PUMP CASE BUSHING INSPECTION.....	5-12
FUEL LEVEL SWITCH.....	5-12
FUEL PUMP AND FUEL MESH FILTER INSTALLATION.....	5-13
THROTTLE BODY AND STV ACTUATOR.....	5-15
CONSTRUCTION.....	5-15
AIR CLEANER AND THROTTLE BODY REMOVAL	5-16
THROTTLE BODY DISASSEMBLY	5-19
THROTTLE BODY CLEANING.....	5-23
THROTTLE BODY INSPECTION	5-24
THROTTLE BODY REASSEMBLY	5-24
STV SYNCHRONIZATION.....	5-28
THROTTLE BODY INSTALLATION.....	5-29
STP SENSOR ADJUSTMENT	5-29
AIR CLEANER BOX INSTALLATION	5-30
TP SENSOR ADJUSTMENT.....	5-30
FAST IDLE INSPECTION	5-31
FAST IDLE ADJUSTMENT.....	5-32
THROTTLE VALVE SYNCHRONIZATION.....	5-33

FUEL SYSTEM

FUEL DELIVERY SYSTEM

The fuel delivery system consists of the fuel tank, fuel pump, fuel filters, fuel feed hose, fuel delivery pipe (including fuel injectors) and fuel pressure regulator. There is no fuel return hose. The fuel in the fuel tank is pumped up by the fuel pump and pressurized fuel flows into the injector installed in the fuel delivery pipe. Fuel pressure is regulated by the fuel pressure regulator. As the fuel pressure applied to the fuel injector (the fuel pressure in the fuel delivery pipe) is always kept at absolute fuel pressure of 300 kPa (3.0 kgf/cm², 43 psi), the fuel is injected into the throttle body in conic dispersion when the injector opens according to the injection signal from the ECM.

The fuel relieved by the fuel pressure regulator flows back to the fuel tank.

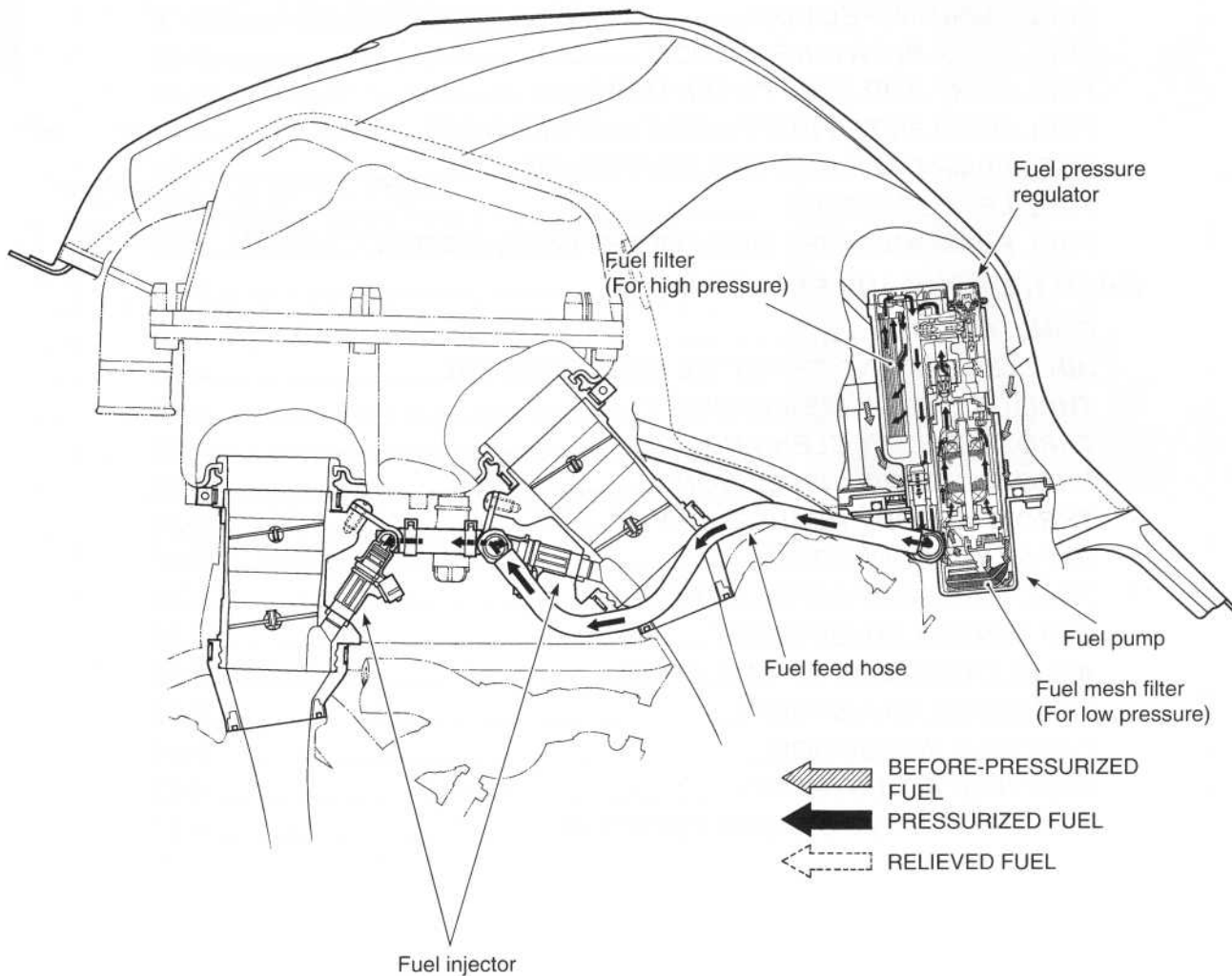

FUEL PUMP

The electric fuel pump is mounted at the bottom of the fuel tank, which consists of the armature, magnet, impeller, brush, check valve and relief valve. The ECM controls its ON/OFF operation as controlled under the FUEL PUMP CONTROL SYSTEM.

When electrical energy is supplied to the fuel pump, the motor in the pump runs and together with the impeller. This causes a pressure difference to occur on both sides of the impeller as there are many grooves around it. Then the fuel is drawn through the inlet port, and with its pressure increased, it is discharged through the outlet port. The fuel pump has a check valve to keep some pressure in the fuel feed hose even when the fuel pump is stopped. Also, the relief valve is equipped in the fuel pump, which releases pressurized fuel to the fuel tank when the outlet of the fuel pressure has increased up to 450 – 600 kPa (4.5 – 6.0 kgf/cm², 64 – 85 psi).

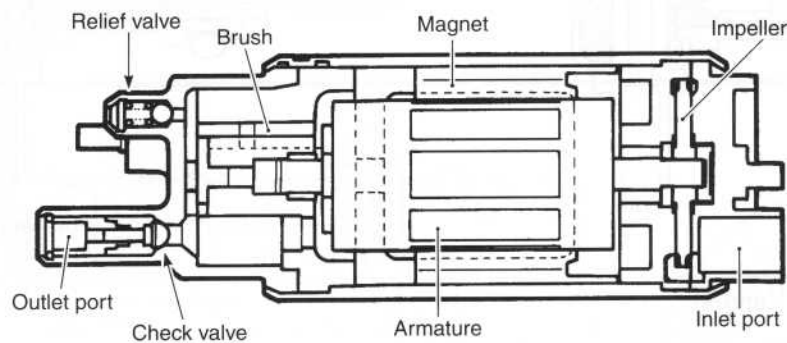

When the impeller is driven by the motor, pressure differential occurs between the front part and the rear part of the blade groove as viewed in angular direction due to fluid friction. This process continuously takes place causing fuel pressure to be built up. The pressurized fuel is then let out from the pump chamber and discharged through the motor section and the check valve.

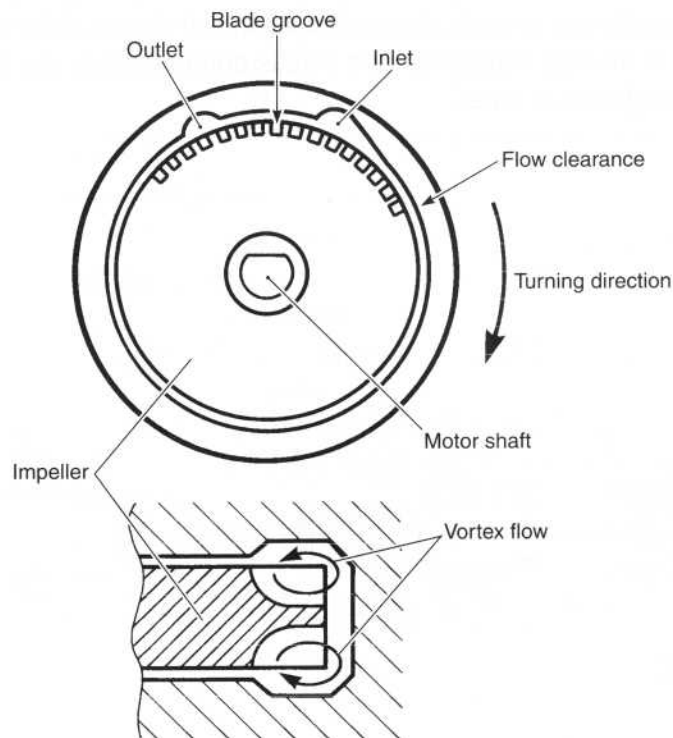

FUEL PRESSURE REGULATOR

The fuel pressure regulator consists of the spring and valve. It keeps absolute fuel pressure of 300 kPa (3.0 kgf/cm², 43 psi) to be applied to the injector at all times.

When the fuel pressure rises more than 300 kPa (3.0 kgf/cm², 43 psi), the fuel pushes the valve in the regulator open and excess fuel returns to the fuel tank.

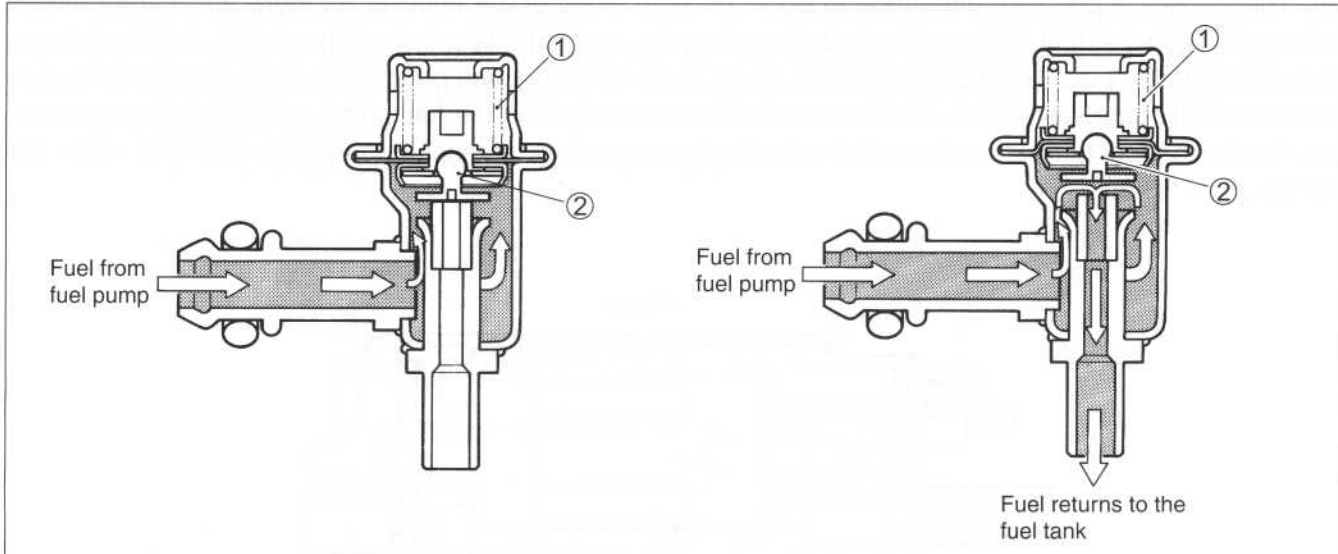

① Spring

② Valve

FUEL INJECTOR

The fuel injector consists of the solenoid coil, plunger, needle valve and filter.

It is an electromagnetic type injection nozzle which injects fuel in the throttle body according to the signal from the ECM.

When the solenoid coil of the injector is energized by the ECM, it becomes an electromagnet and attracts the plunger. At the same time, the needle valve incorporated with the plunger opens and the injector which is under the fuel pressure injects fuel in conic dispersion. As the lift stroke of the needle valve of the injector is set constant, the volume of the fuel injected at one time is determined by the length of time during which the solenoid coil is energized (injection time).

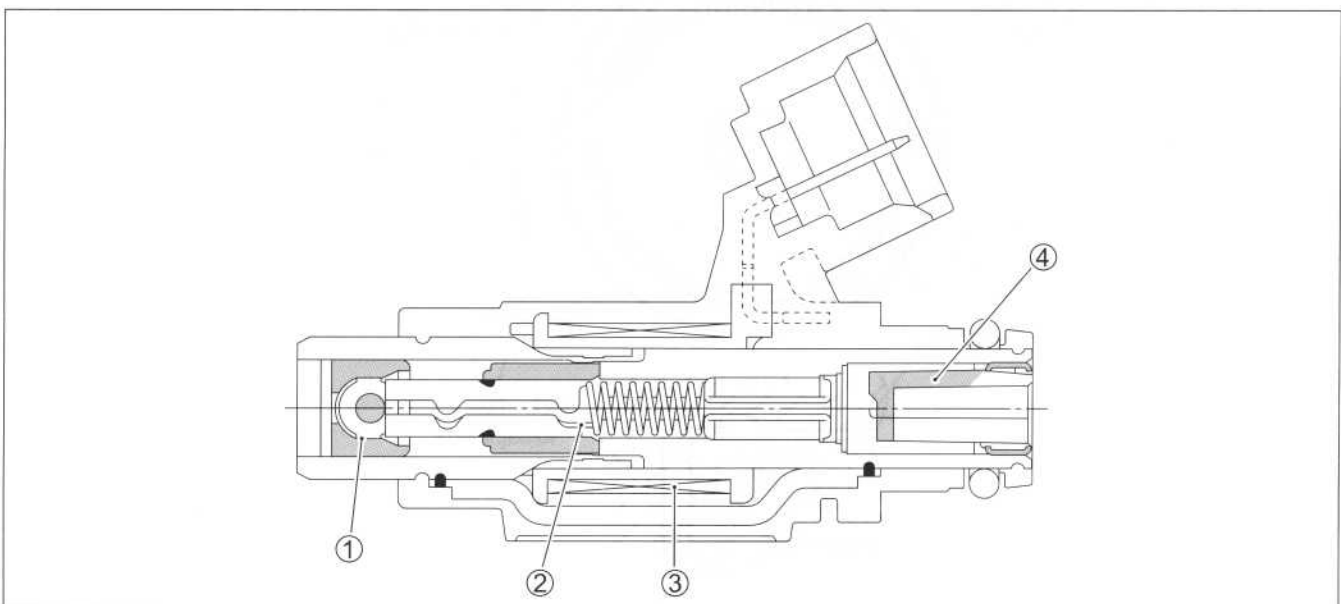

① Needle valve

② Plunger

③ solenoid coil

④ Filter

FUEL PUMP CONTROL SYSTEM

When the ignition switch is turned on, current from the battery flows to the fuel pump motor through the side-stand relay and the fuel pump relay causing the motor to turn.

Since the ECM has a timer function, the fuel pump motor stops turning in three seconds after the switch has been turned on.

Thereafter, when the crankshaft is turned by the starter motor or the engine has been started, the engine revolving signal is input to the ECM. Then, current flows to the fuel pump motor from the battery through the side-stand relay and the fuel pump relay so that the pump continues to function.

A tip over sensor is provided in the fuel pump control circuit. By this provision, anytime the motorcycle tips over, the tip over sensor sends a signal to the ECM to turn off power to the fuel pump relay, causing the fuel pump motor to stop. At the same time, current to the fuel injectors as well as the ignition coil is interrupted, which then stops the engine.

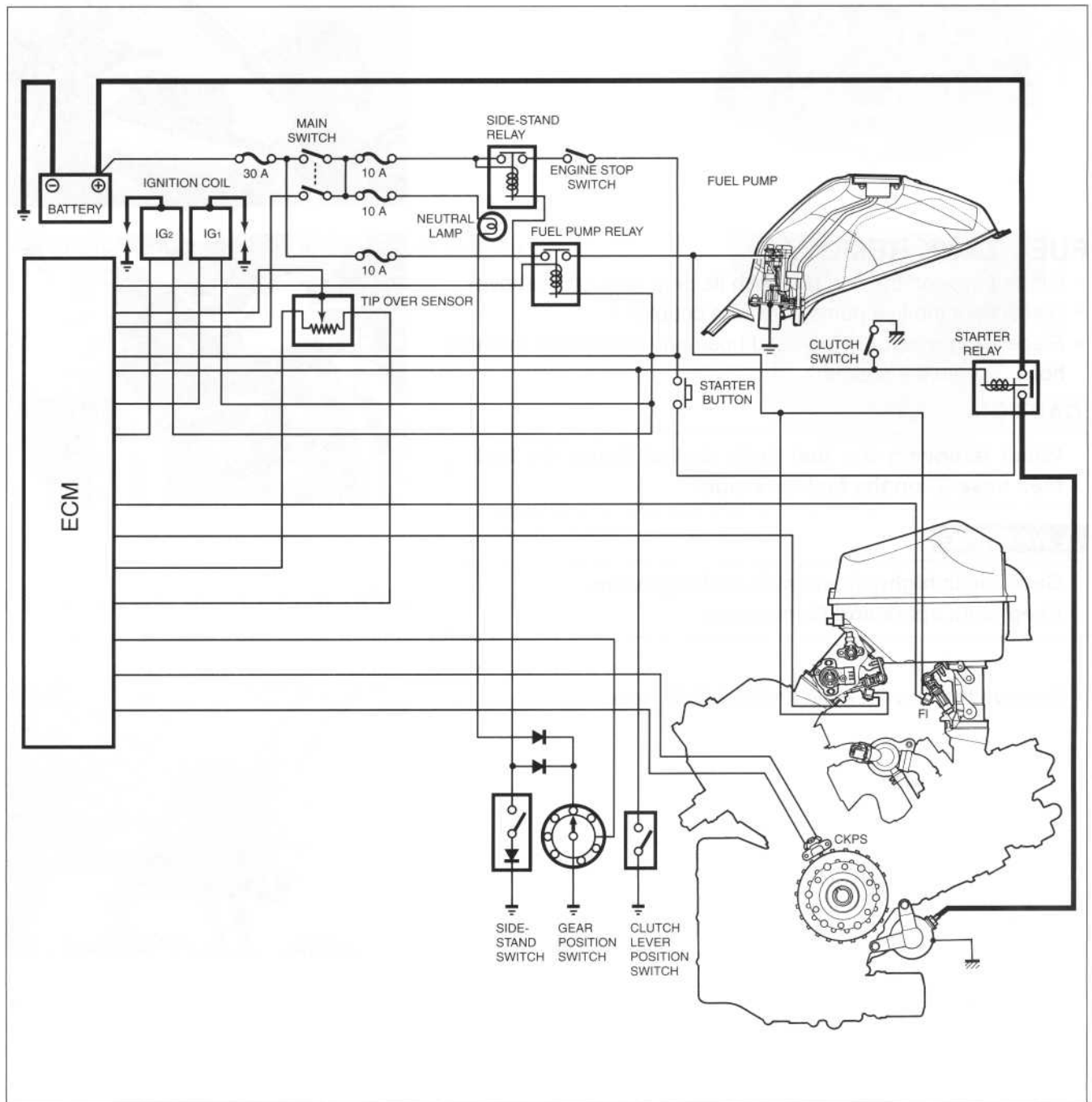

FUEL TANK LIFT-UP

- Remove the front seat. (☞ 7-4)
- Remove the fuel tank mounting bolts.

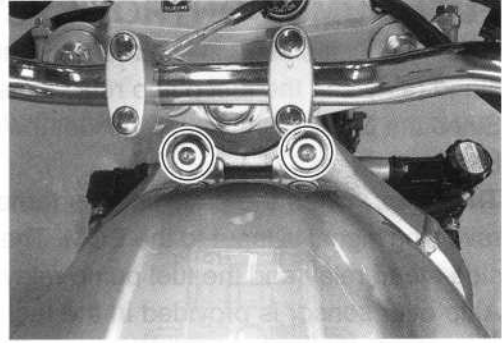

- Lift and support the fuel tank with its prop stay.



FUEL TANK REMOVAL

- Lift and support the fuel tank with its prop stay. (☞ above)
- Disconnect the fuel pump lead wire coupler ①.
- Place a rag under the fuel feed hose and disconnect the feed hose ② from the fuel tank.

CAUTION

When removing the fuel tank, do not leave the fuel feed hose ② on the fuel tank side.

⚠ WARNING

Gasoline is highly flammable and explosive.
Keep heat, spark and flame away.

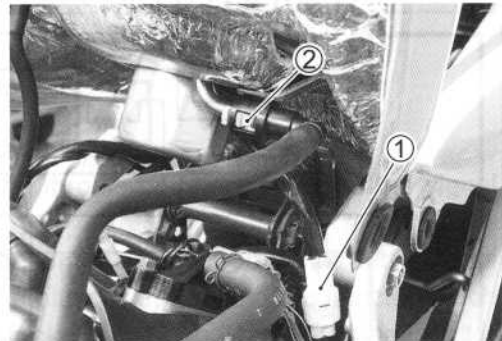

- Remove the air vent hose and fuel drain hose.

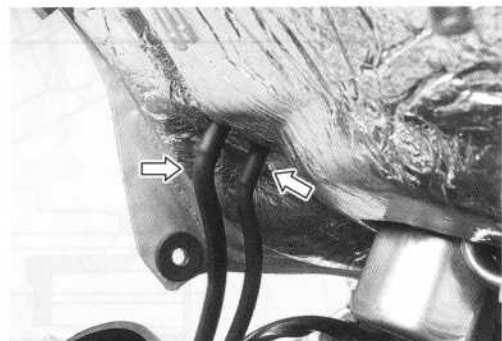

- Remove the fuel tank mounting bolt.
- Remove the fuel tank.

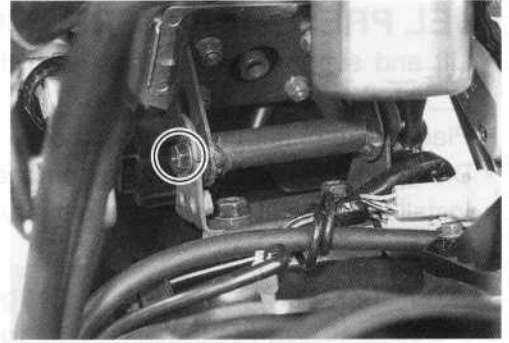

- Remove the fuel tank bracket.

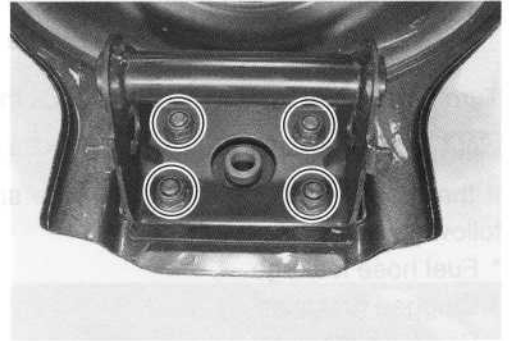

- Remove the fuel tank stay and its rubber cushion.

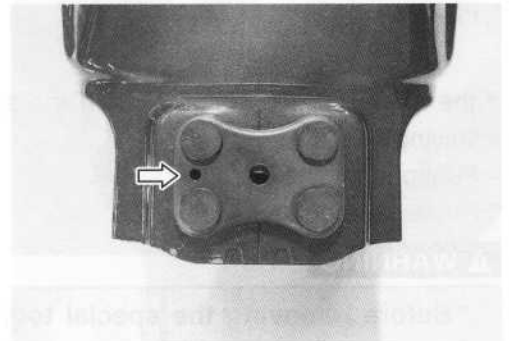

FUEL TANK INSTALLATION

- Installation is in the reverse order of removal.

FUEL PRESSURE INSPECTION

- Lift and support the fuel tank with the fuel tank prop stay. (7-4)
- Place a rag under the fuel feed hose.
- Disconnect the fuel feed hose from the fuel delivery pipe.
- Install the special tools between the fuel tank and fuel delivery pipe.

- TOOL** 09940-40211: Fuel pressure gauge adaptor
 09940-40220: Fuel pressure gauge hose attachment
 09915-77331: Oil pressure gauge
 09915-74521: Oil pressure gauge hose

Turn the ignition switch ON and check the fuel pressure.

DATA Fuel pressure: Approx. 300 kPa (3.0 kgf/cm², 43 psi)

If the fuel pressure is lower than the specification, inspect the following items:

- * Fuel hose leakage
- * Clogged fuel filter
- * Pressure regulator
- * Fuel pump

If the fuel pressure is higher than the specification, inspect the following items:

- * Fuel pump check valve
- * Pressure regulator

▲ WARNING

- * Before removing the special tools, turn the ignition switch to OFF position and release the fuel pressure slowly.
- * Gasoline is highly flammable and explosive. Keep heat, sparks and flame away.

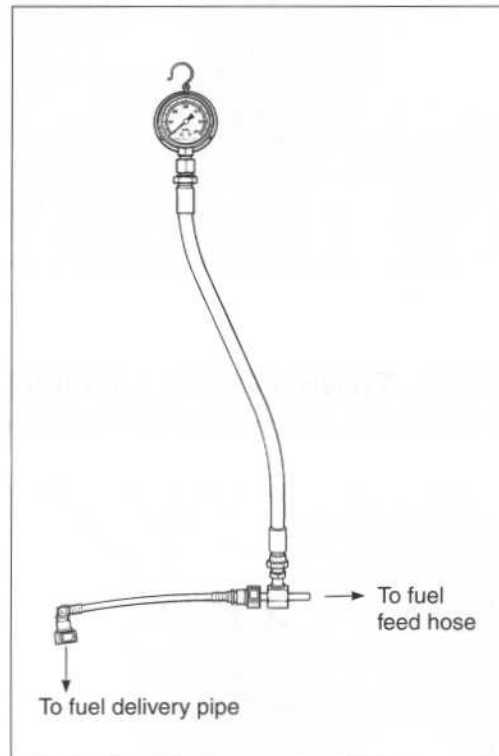
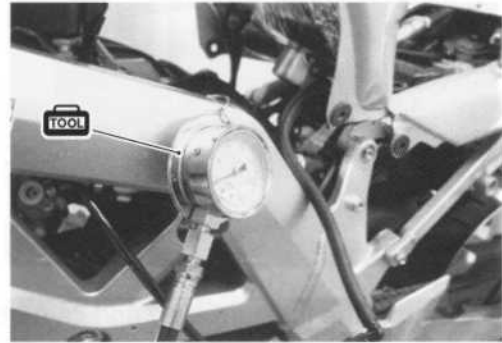
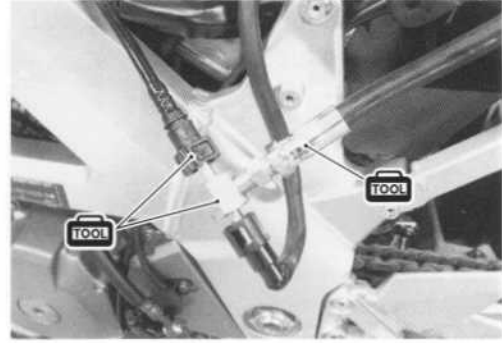

FUEL PUMP INSPECTION

Turn the ignition switch ON and check that the fuel pump operates for few seconds.

If the fuel pump motor does not make operating sound, replace the fuel pump assembly or inspect the fuel pump relay and tip over sensor.

FUEL DISCHARGE AMOUNT INSPECTION

▲ WARNING

**Gasoline is highly flammable and explosive.
Keep heat, spark and flame away.**

- Lift and support the fuel tank with the fuel tank prop stay. (7-4)
- Disconnect the fuel feed hose from the fuel delivery pipe.
- Place the measuring cylinder and insert the fuel feed hose end into the measuring cylinder.
- Disconnect the ECM lead wire coupler.
- Push the lock (A) to pull out the power source lead wire (Yellow with black tracer).

- Apply 12 volts to the fuel pump for 10 seconds and measure the amount of fuel discharged.

Battery (+) terminal — Power source lead wire ①
(Yellow with black tracer)

If the pump does not discharge the amount specified, it means that the fuel pump is defective or that the fuel filter is clogged.

DATA Fuel discharge amount: MIN. 168 ml/10 sec.
(5.7/5.9 US/Imp oz)

NOTE:

The battery must be in fully charged condition.

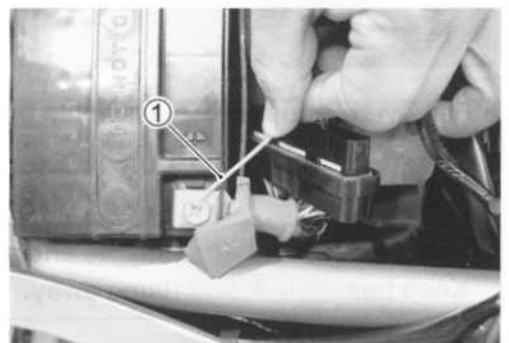
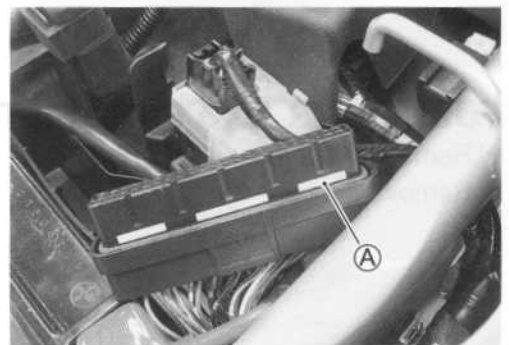

FUEL PUMP RELAY INSPECTION

Fuel pump relay is located behind the ECM.

- Remove the seat.
- Remove the fuel pump relay.

First, check the insulation between (1) and (2) terminals with pocket tester. Then apply 12 volts to (3) and (4) terminals, + to (3) and \ominus to (4), and check the continuity between (1) and (2). If there is no continuity, replace it with a new one.

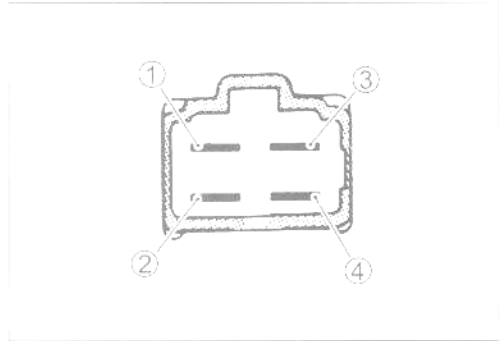

FUEL PUMP AND FUEL FILTER REMOVAL

- Remove the fuel tank. (☞ 5-6)
- Remove the heat shield.



- Remove the fuel pump assembly by removing its mounting bolts diagonally.

⚠ WARNING

Gasoline is highly flammable and explosive.
Keep heat, spark and flame away.

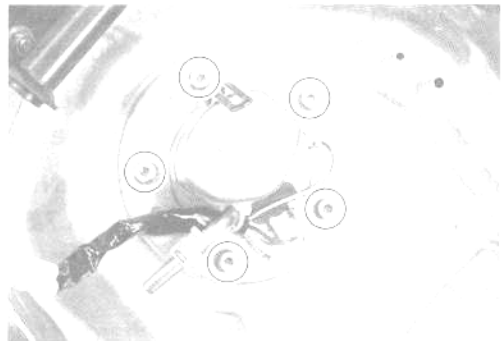

- Disconnect the lead wires.



- Remove the screws and fuel level switch.

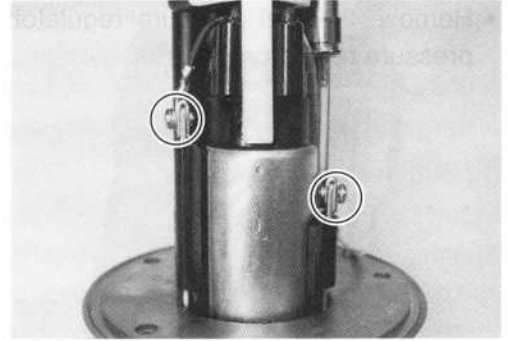

- Remove the fuel pump assembly from the fuel pump plate.

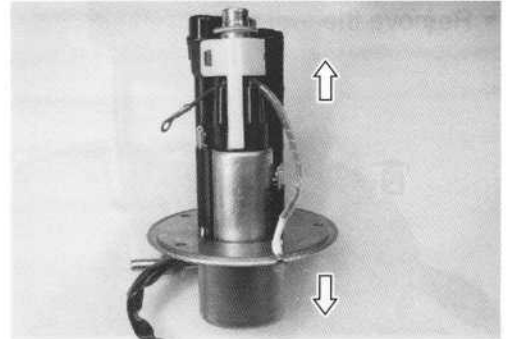

- Remove the fuel pump holder ①.

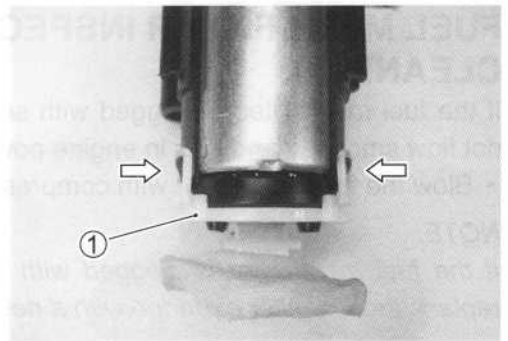

- Remove the rubber cap ②.

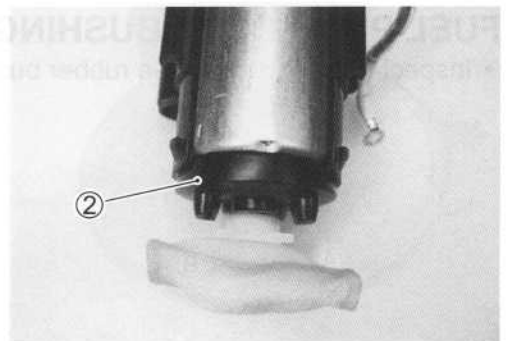

- Remove the fuel mesh filter ③.

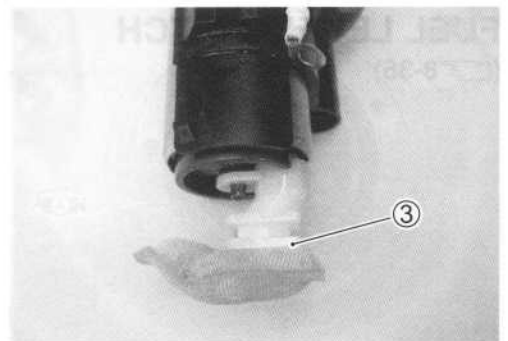

- Remove the fuel pressure regulator holder ④ and the fuel pressure regulator ⑤.

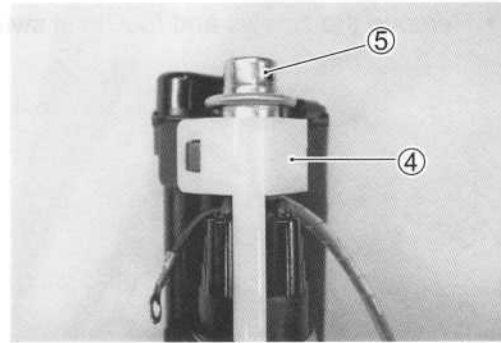

- Remove the fuel pump.

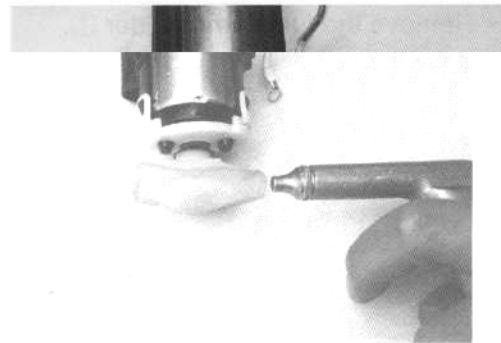
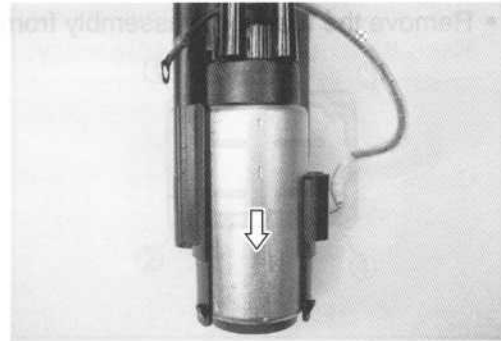

FUEL MESH FILTER INSPECTION AND CLEANING

If the fuel mesh filter is clogged with sediment or rust, fuel will not flow smoothly and loss in engine power may result.

- Blow the fuel mesh filter with compressed air.

NOTE:

If the fuel mesh filter is clogged with many sediment or rust, replace the fuel filter cartridge with a new one.

FUEL PUMP CASE BUSHING INSPECTION

- Inspect the fuel pump case rubber bushing for damage.



FUEL LEVEL SWITCH

( 8-35)

FUEL PUMP AND FUEL MESH FILTER INSTALLATION

Install the fuel pump and fuel mesh filter in the reverse order of removal, and pay attention to the following points:

- Install the new O-rings to the fuel pressure regulator and fuel pipe.
- Apply thin coat of the engine oil to the O-rings.

CAUTION

Use the new O-rings to prevent fuel leakage.

- Tighten the screws together with the lead wire terminals and fuel level switch.

- Connect the lead wires as below.
 - Ⓐ..... ⊕ terminal for fuel pump
 - Ⓑ..... Fuel level switch

- Install the new O-ring and apply grease to it.

⚠ WARNING

The O-ring must be replaced with a new one to prevent fuel leakage.

-  99000-25030: SUZUKI SUPER GREASE "A" (USA)
 99000-25010: SUZUKI SUPER GREASE "A" (Others)

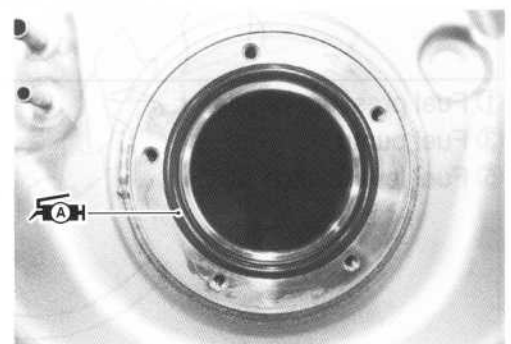
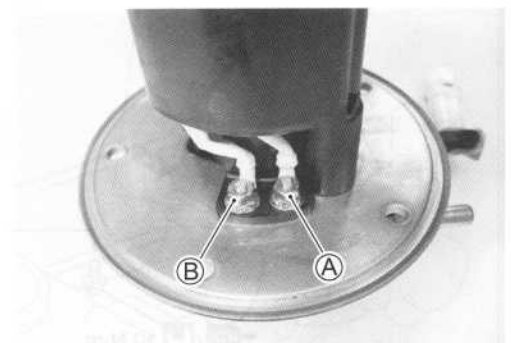
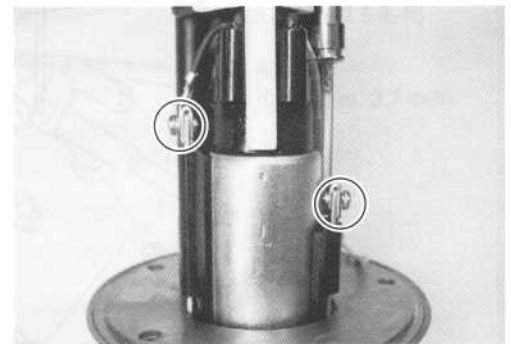
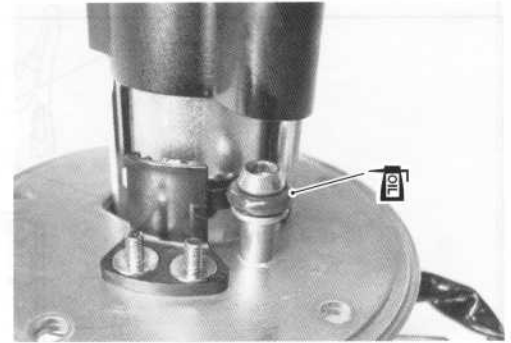
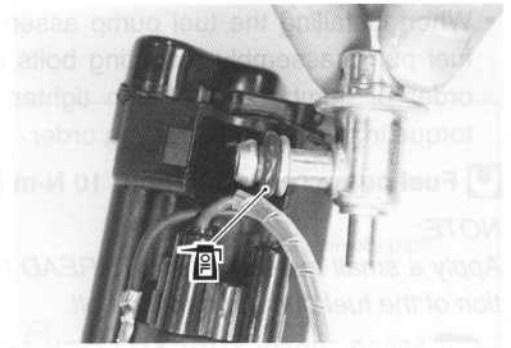

- When installing the fuel pump assembly, first tighten all the fuel pump assembly mounting bolts lightly in the ascending order of numbers, and then tighten them to the specified torque in the above tightening order

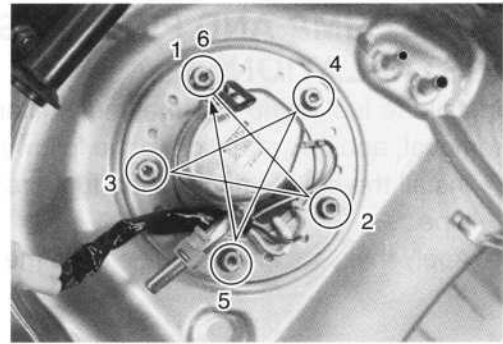

Fuel pump mounting bolt: 10 N·m (1.0 kgf·m, 7.0 lb-ft)

NOTE:

Apply a small quantity of the *THREAD LOCK* to the thread portion of the fuel pump mounting bolt.

1342 99000-32050: THREAD LOCK "1342"

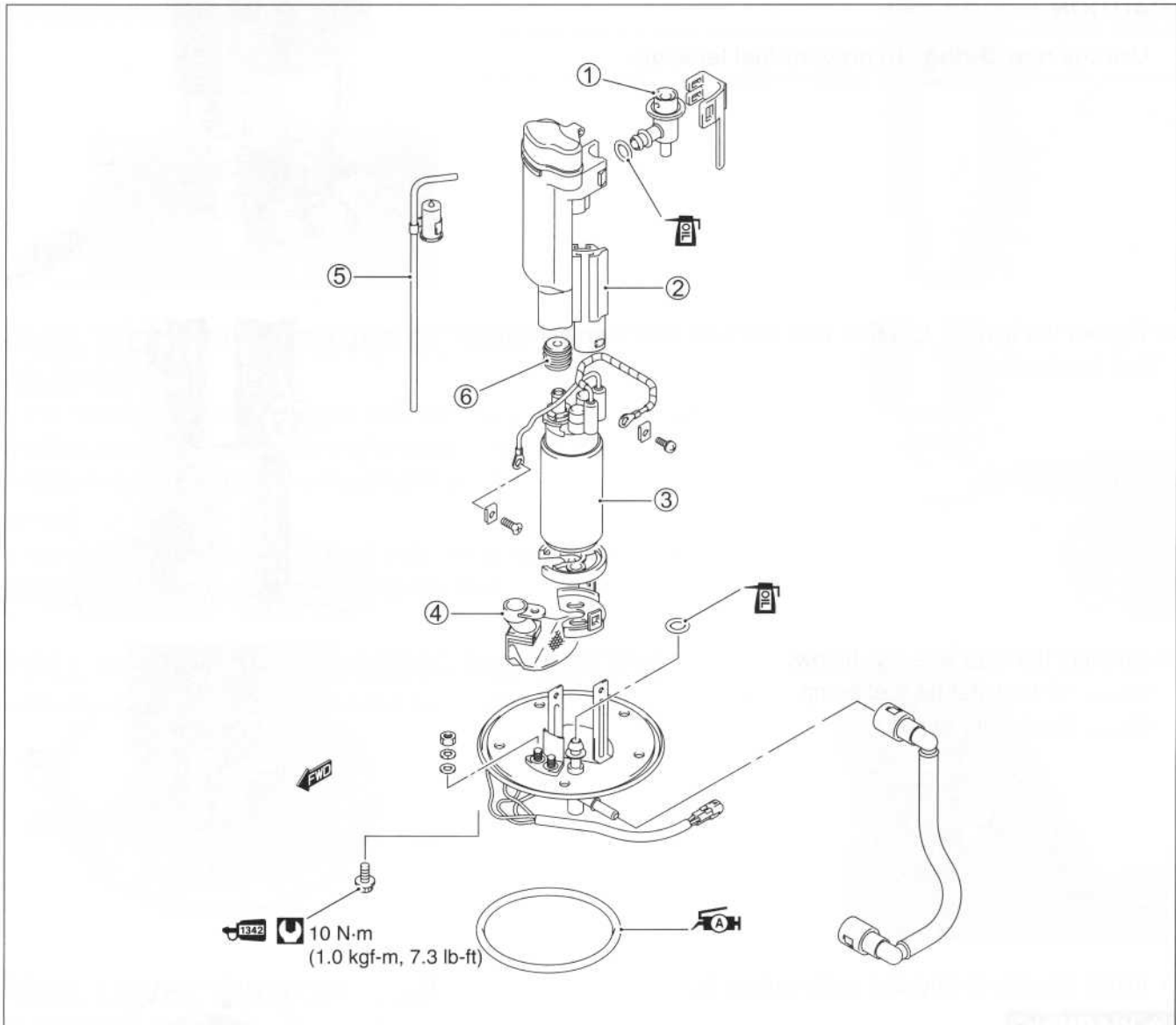

- | | |
|---------------------------|--|
| ① Fuel pressure regulator | ② Fuel pump case/Fuel filter cartridge (For high pressure) |
| ③ Fuel pump | ④ Fuel mesh filter (For low pressure) |
| ⑤ Fuel level switch | ⑥ Bushing |

THROTTLE BODY AND STV ACTUATOR CONSTRUCTION

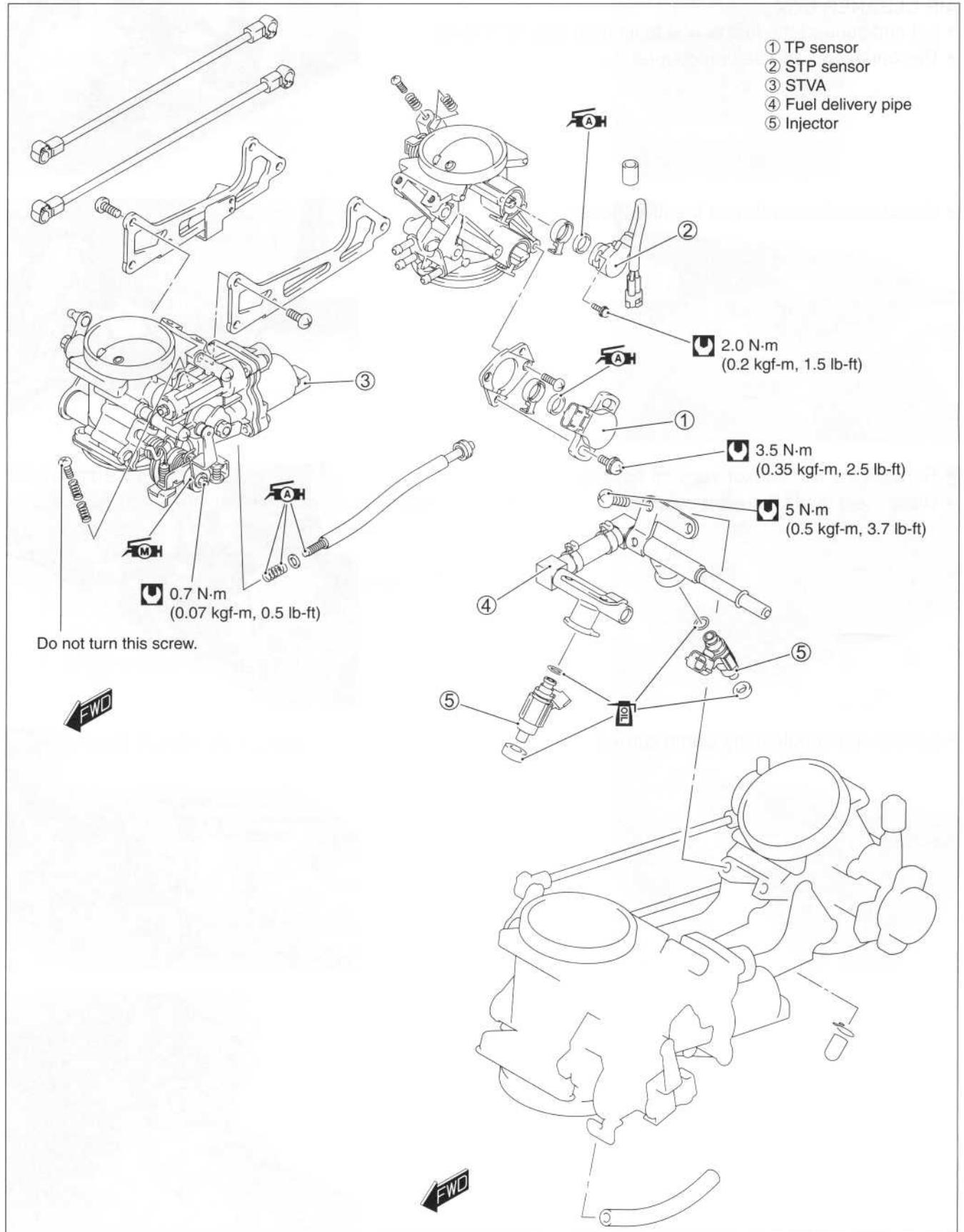

AIR CLEANER AND THROTTLE BODY REMOVAL

AIR CLEANER BOX

- Lift and support the fuel tank with its prop stay. (☞ 5-6)
- Disconnect the IAT sensor coupler ①.

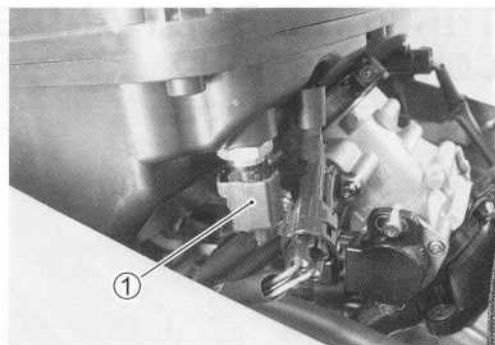

- Disconnect the crankcase breather hoses.

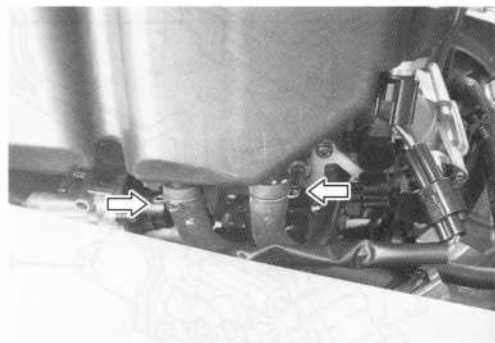

- Remove the IAP sensor vacuum hose ②.
- Disconnect the IAP sensor coupler.

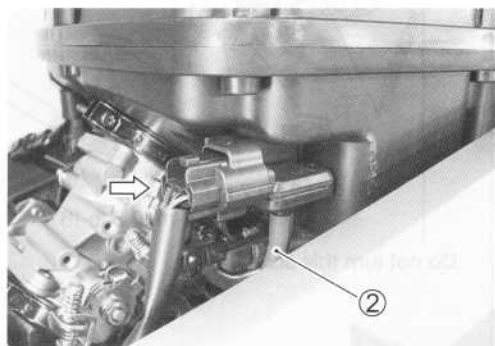

- Loosen the throttle body clamp screws.



- Disconnect the PAIR hose.

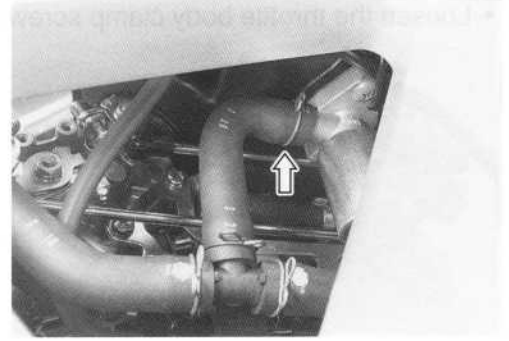

- Disconnect the PAIR coupler.
- Remove the air cleaner box.

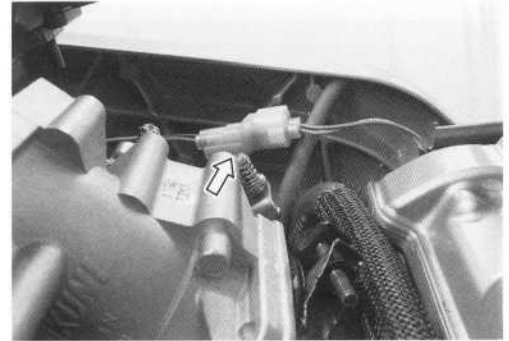

THROTTLE BODY

- Lift and support the fuel tank with its prop stay. (☞ 5-6)
- Remove the air cleaner box. (☞ 5-16)
- Disconnect the fuel feed hose ①.
- Disconnect the various lead wire couplers.
 - ② TP sensor.
 - ③ STP sensor.
 - ④ STVA motor/injector coupler.

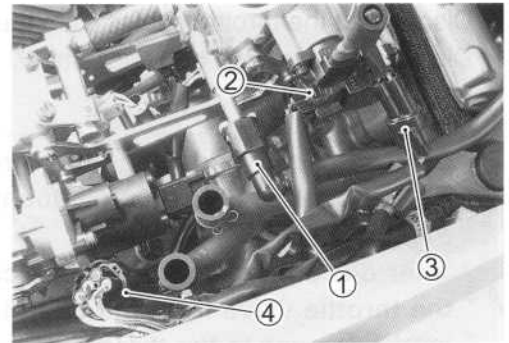

- Disconnect the idle stop screw.

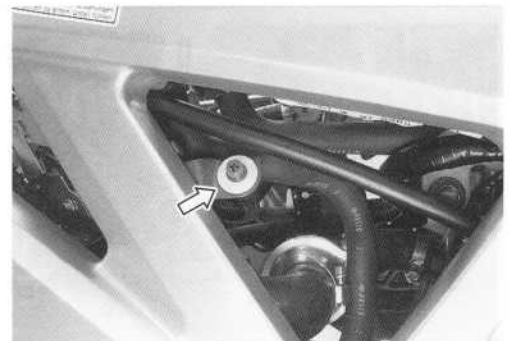

- Loosen the throttle body clamp screws.

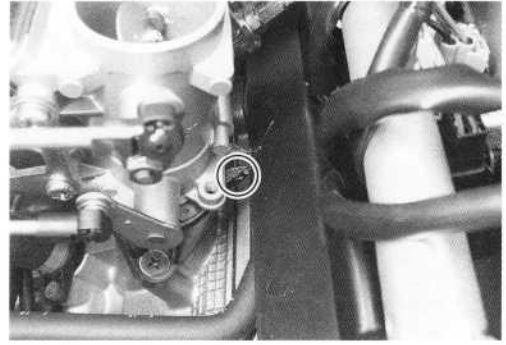

- Disconnect the throttle cables from their drum.
- Dismount the throttle body assembly.

CAUTION

- * Be careful not to damage the throttle cable bracket and fast idle lever when dismounting or remounting the throttle body assembly.
- * After disconnecting the throttle cables, do not snap the throttle valve from full open to full close. It may cause damage to the throttle valve and throttle body.

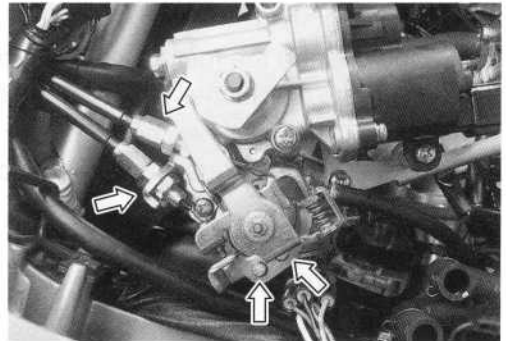

THROTTLE BODY DISASSEMBLY

CAUTION

- * Be careful not to damage the throttle lever when disassembling the throttle body.
- * The throttle body is assembled precisely in factory. Do not disassemble it other than shown in this manual.

- Remove the IAP sensor vacuum damper and its hose.
- Disconnect the STVA and injector couplers.

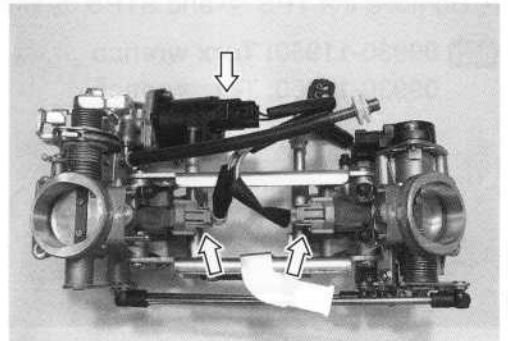
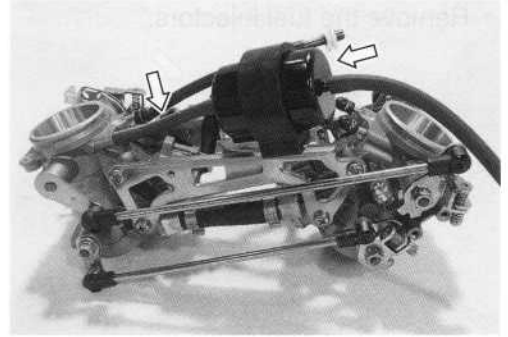

- Remove the throttle link rod ① and secondary throttle link rod ②.

NOTE:

The throttle link rod ① is longer than the secondary throttle link rod ②.

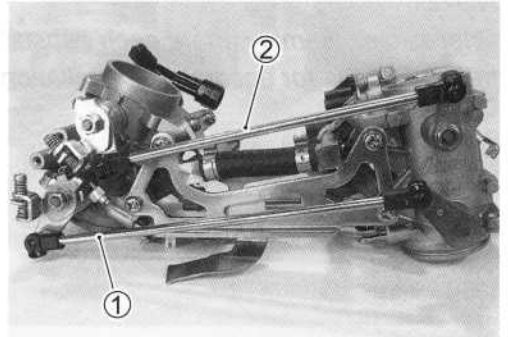

- Remove the fuel delivery pipe ③.

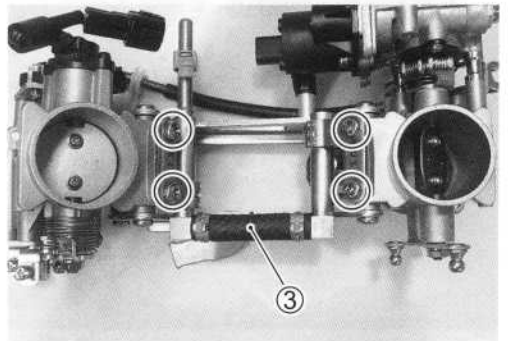

- Remove the fuel injectors.

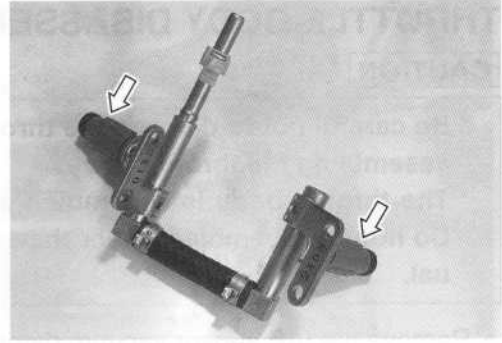

- Remove the TPS ④ and STPS ⑤ with the special tool.

TOOL 09930-11950: Torx wrench
09930-11960: Torx wrench

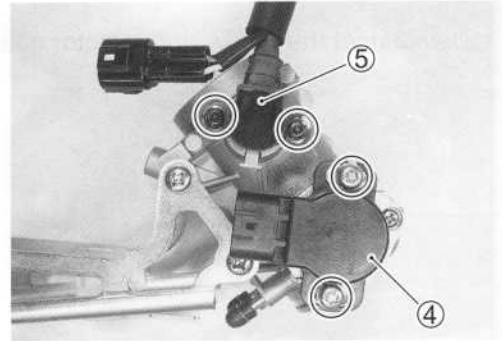

NOTE:

Prior to disassembly, mark each sensor's original position with a paint or scribe for accurate reinstallation.

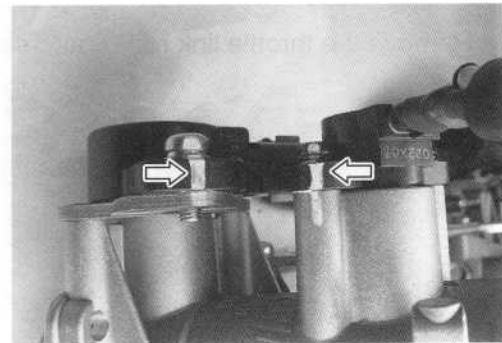

- Remove the seal ⑥.

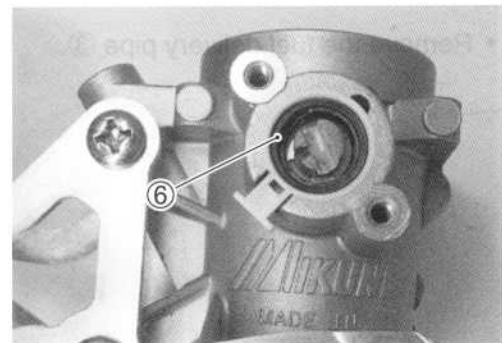

CAUTION

Do not turn the screw ⑦.

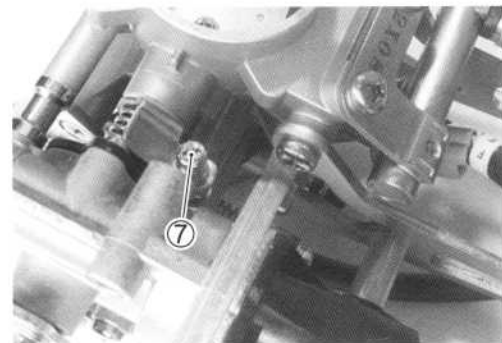

CAUTION

Never remove the STVA.

- Remove the throttle stop screw ⑧.

NOTE:

Measure the length ① for accurate reinstallation.

CAUTION

Never loosen the throttle stop screw ⑨ on the No.2 throttle body.

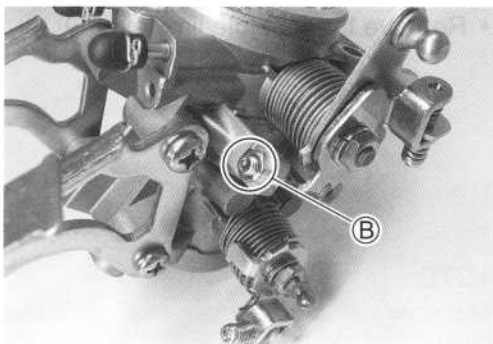
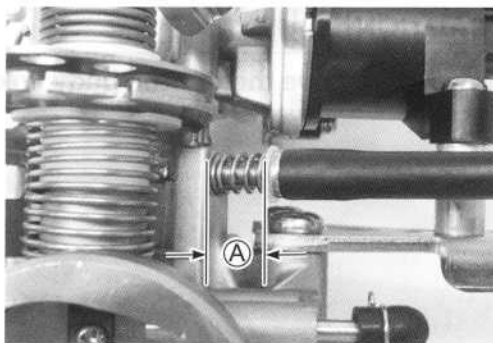
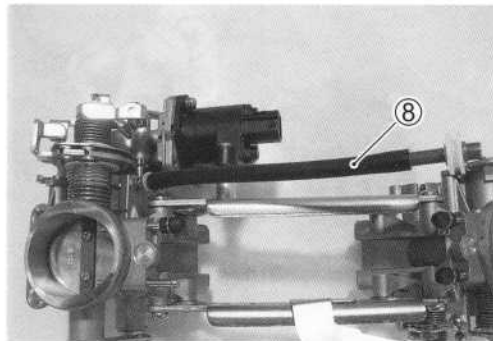
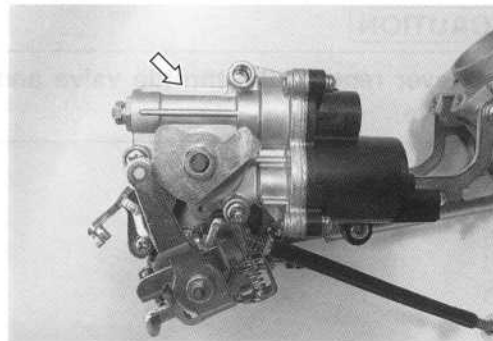

CAUTION

Never remove the throttle valve and secondary throttle valve.

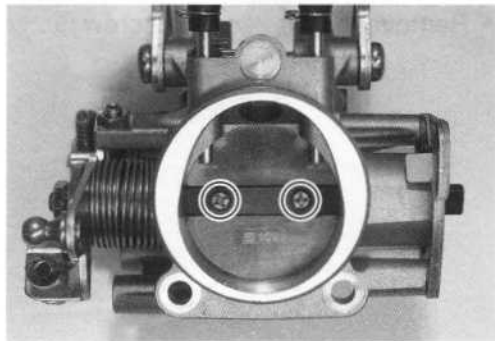
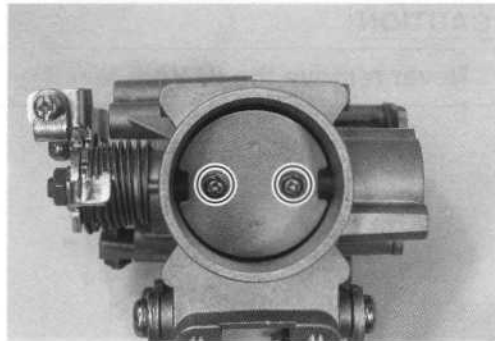

CAUTION

Never remove the throttle body link plates.

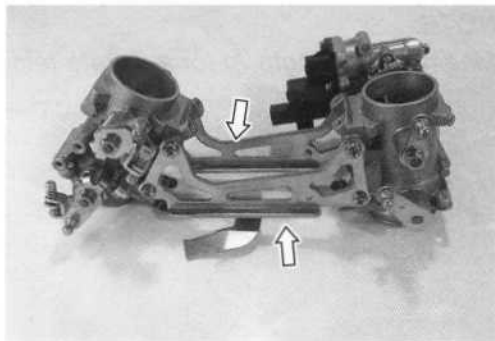

- Remove the fast idle link lever ⑨.

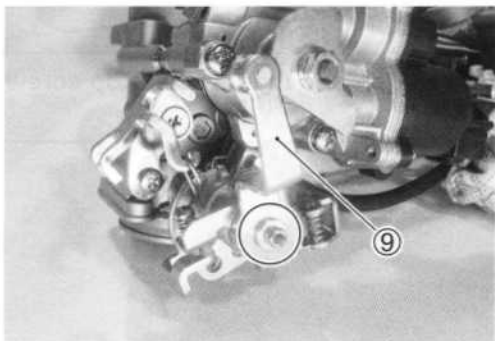

- Remove the spring ⑩.

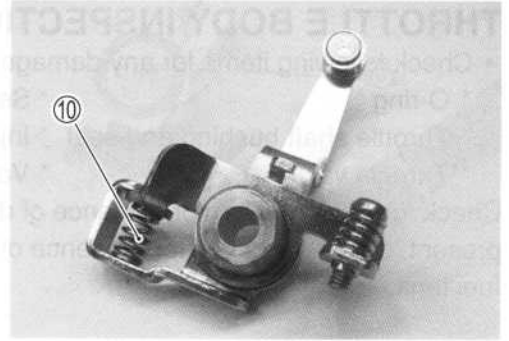

- Remove the bushing ⑪ and plastic washer ⑫.

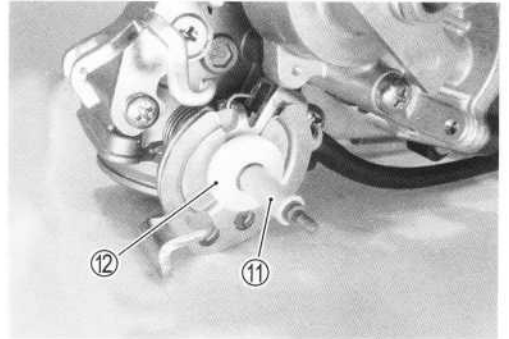

THROTTLE BODY CLEANING

⚠ WARNING

Some carburetor cleaning chemicals, especially dip-type soaking solutions, are very corrosive and must be handled carefully. Always follow the chemical manufacturer's instructions on proper use, handling and storage.

- Clean all passageways with a spray type carburetor cleaner and blow dry with compressed air.

CAUTION

Do not use wire to clean passageways. Wire can damage passageways. If the components cannot be cleaned with a spray cleaner it may be necessary to use a dip-type cleaning solution and allow them to soak. Always follow the chemical manufacturer's instructions for proper use and cleaning of the throttle body components. Do not apply carburetor cleaning chemicals to the rubber and plastic materials.

THROTTLE BODY INSPECTION

- Check following items for any damage or clogging.
 - * O-ring
 - * Throttle shaft bushing and seal
 - * Throttle valve
 - * Secondary throttle valve
 - * Injector cushion seal
 - * Vacuum hose

Check fuel injector filter for evidence of dirt and contamination. If present, clean and check for presence of dirt in the fuel lines and fuel tank.

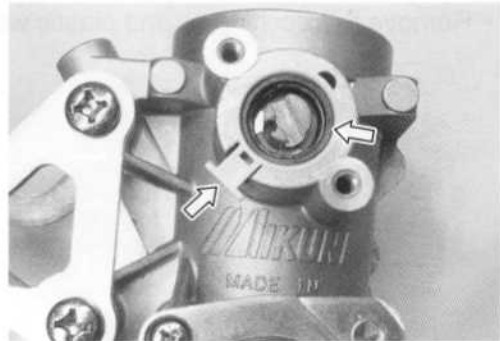
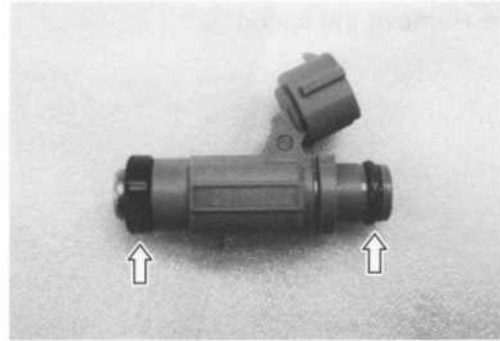

THROTTLE BODY REASSEMBLY

Reassemble the throttle body in the reverse order of disassembly.

Pay attention to the following points:

- Apply SUZUKI SUPER GREASE to the throttle stop screw tip and the both ends of a spring.

 99000-25030: SUZUKI SUPER GREASE "A" (USA)
 99000-25010: SUZUKI SUPER GREASE "A" (Others)

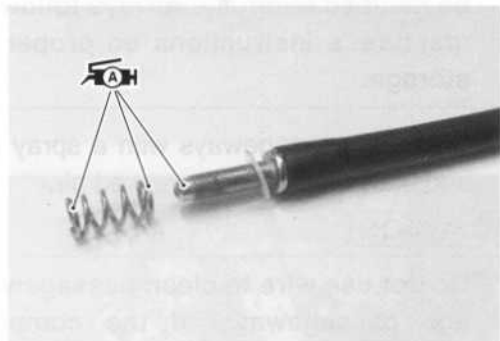

- Install the plastic washer ① and bushing ②.

NOTE:

The concave of a bushing is faced outside.

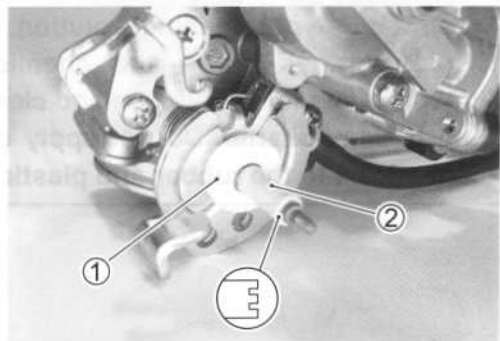

- Apply SUZUKI MOLY PASTE to the fast idle link lever.

 99000-25140: SUZUKI MOLY PASTE

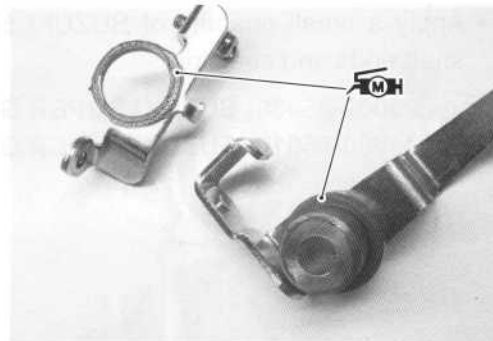

- Install the spring ③.

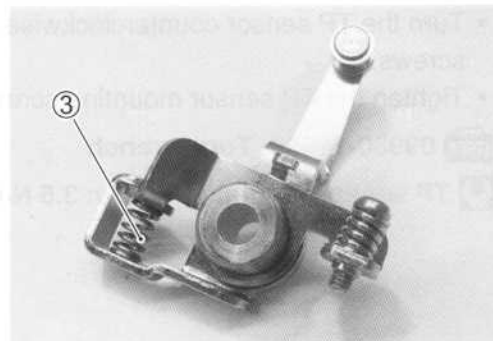

- Install the spring ④ and fast idle link lever ⑤.

NOTE:

Make sure that the spring ends are hooked correctly.

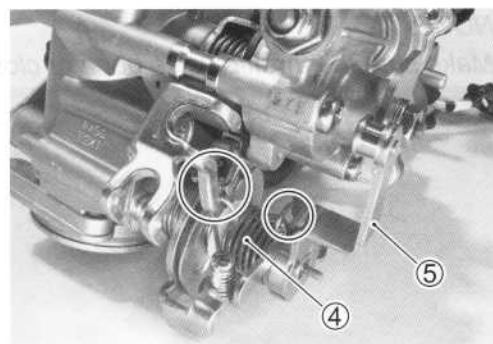

- Install the washers ⑤, ⑥, spring washer ⑦ and nut ⑧.

NOTE:

The washer ⑤ is inserting in the axis certainly.

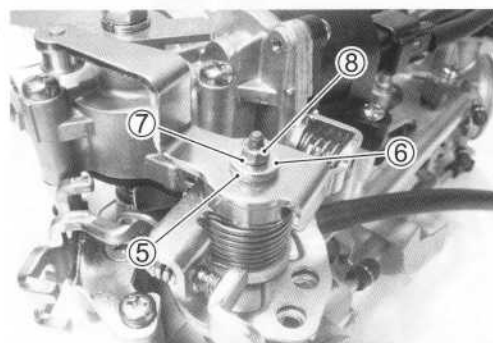

- Apply SUZUKI SUPER GREASE to the seal lips.

 99000-25030: SUZUKI SUPER GREASE "A" (USA)
99000-25010: SUZUKI SUPER GREASE "A" (Others)

- Install the seal ⑨.

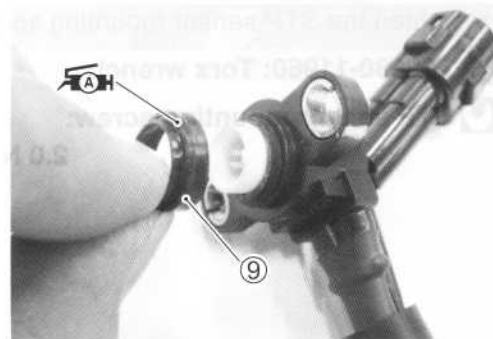

- Apply a small quantity of SUZUKI SUPER GREASE to the shaft ends and seal lips.

 **99000-25030: SUZUKI SUPER GREASE "A" (USA)**
99000-25010: SUZUKI SUPER GREASE "A" (Others)

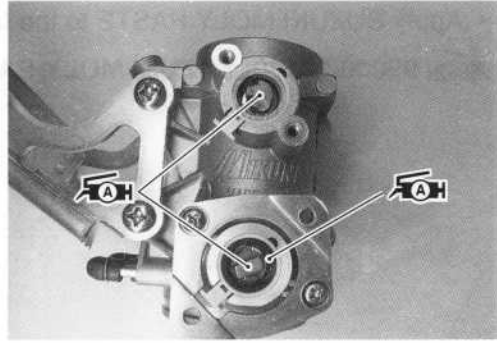

- Turn the TP sensor counterclockwise and install the mounting screws.
- Tighten the TP sensor mounting screws.

 **09930-11950: Torx wrench**

 **TP sensor mounting screw: 3.5 N·m (0.35 kgf·m, 2.5 lb·ft)**

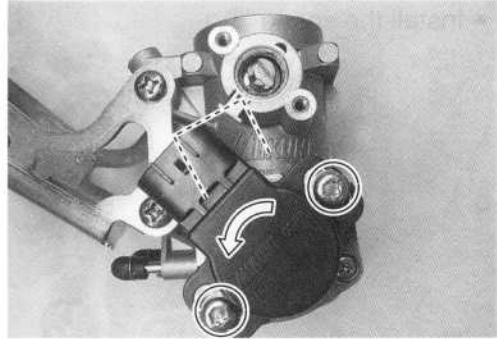

NOTE:

Make sure the throttle valve open or close smoothly.

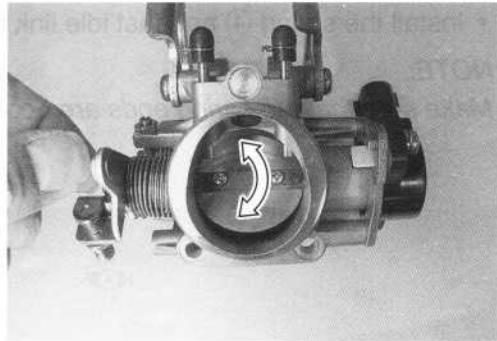

- Align the boss (A) of the STP sensor with the groove (B) of the ST valve shaft.
- Install the STP sensor.

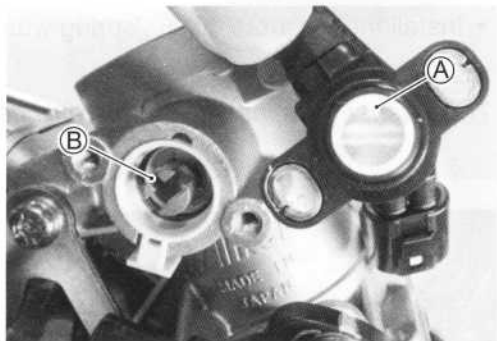

- Tighten the STP sensor mounting screws.

 **09930-11960: Torx wrench**

 **STP sensor mounting screw:**
2.0 N·m (0.2 kgf·m, 1.5 lb·ft)

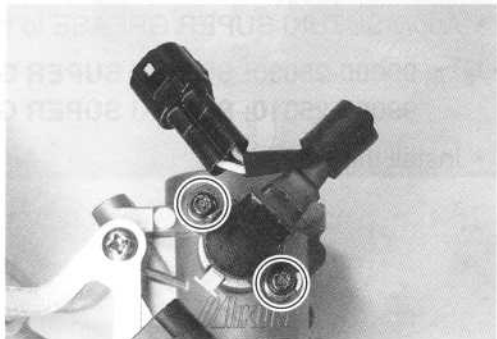

NOTE:

Make sure the ST valve open or close smoothly.

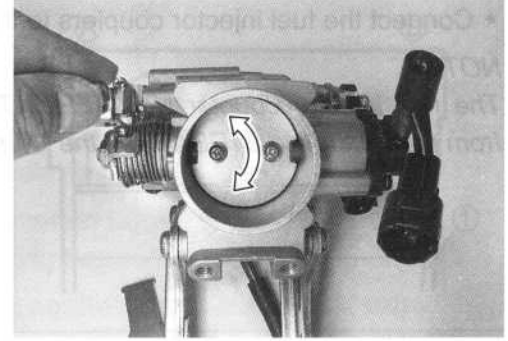

- Apply thin coat of the engine oil to the new fuel injector cushion seal ⑩, and install it to the fuel injector.

CAUTION

Replace the cushion seal and O-ring with a new one.

- Install the O-ring ⑪ to the fuel injector.
- Apply thin coat of the engine oil to the new O-ring ⑪.

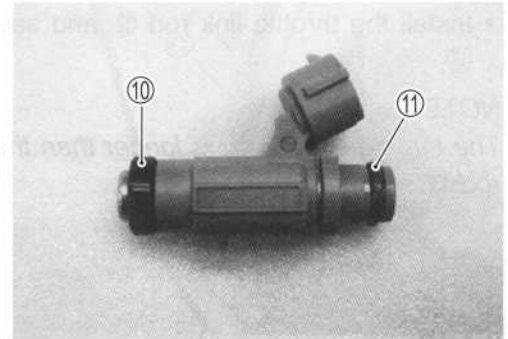

- Install the fuel injectors by pushing them straight to each throttle body.

CAUTION

Never turn the injector while pushing it.

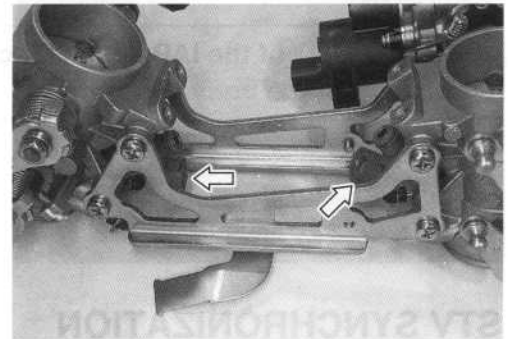

- Install the fuel delivery pipe assembly to the throttle body assembly.

CAUTION

Never turn the fuel injectors while installing them.

- Tighten the fuel delivery pipe mounting screws.



Fuel delivery pipe mounting screw:

5 N-m (0.5 kgf-m, 3.7 lb-ft)

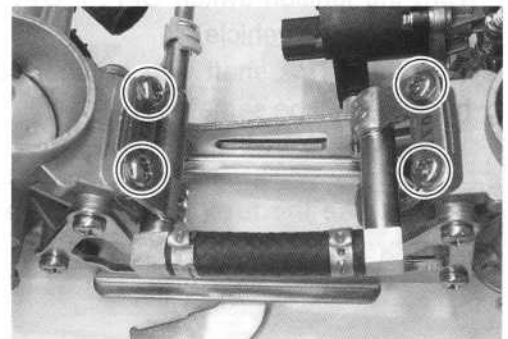

- Connect the fuel injector couplers to the fuel injectors.

NOTE:

The fuel injector coupler No.1 (FRONT) can be distinguished from that of the No.2 (REAR) by the "F" mark ①.

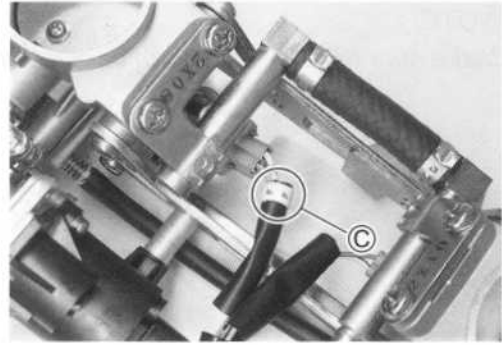

- Install the throttle link rod ⑫ and secondary throttle link rod ⑬.

NOTE:

The throttle link rod ⑫ is longer than the secondary throttle link rod ⑬.

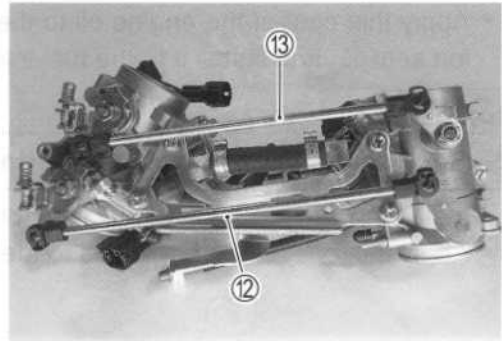

- Install the IAP sensor vacuum damper and hose.

CAUTION

The stamp ① of the IAP sensor vacuum damper faces into the throttle body side.

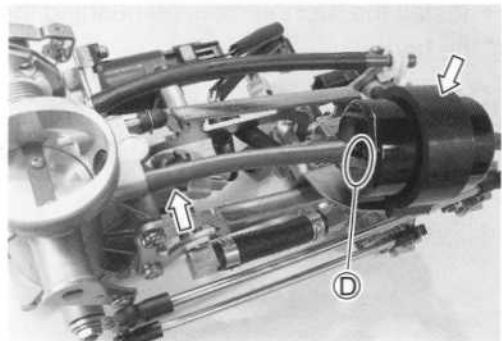

STV SYNCHRONIZATION

- Turn the ignition switch OFF, if STV synchronization is performed on the vehicle.
- Turn the STVA shaft with a finger so that the throttle valve height ① will be same as ②.

CAUTION

Do not use the tool for turning the STVA shaft to prevent breakdown.

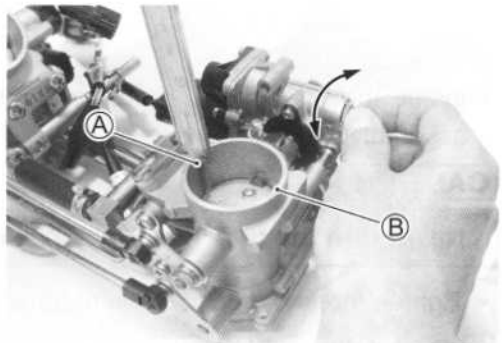

NOTE:

Measure the throttle valve height (A), (B) from top of the throttle body (1) to the throttle valve (2).

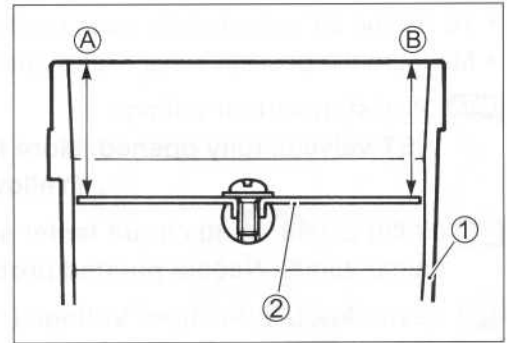

- While holding above No.1 STV position, turn the adjust screw (3) so that the throttle valve height (C) will be same as (D).

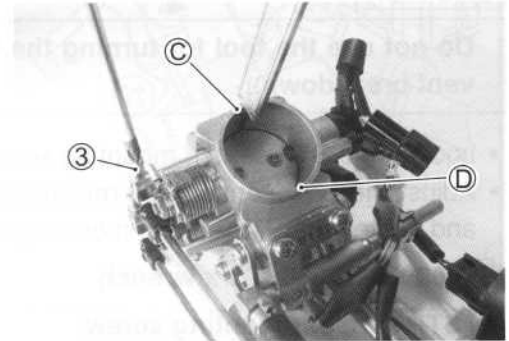
**THROTTLE BODY INSTALLATION**

Installation is in the reverse order of removal. Pay attention to the following points:

- Connect the throttle pulling cable and throttle returning cable to the throttle cable drum.
- Adjust the throttle cable play with the cable adjusters. Refer to page 2-16 for details.

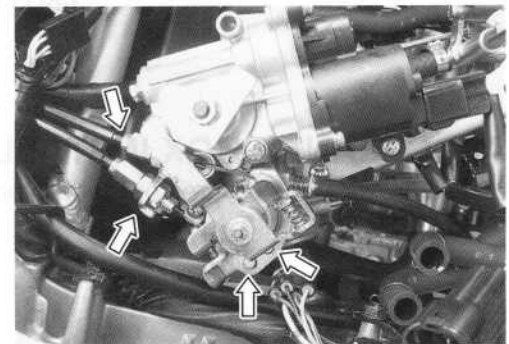
**STP SENSOR ADJUSTMENT**

If the STP sensor adjustment is necessary, measure the sensor resistance and adjust the STP sensor positioning as follows:

- Disconnect the STVA coupler and turn the ignition switch ON.

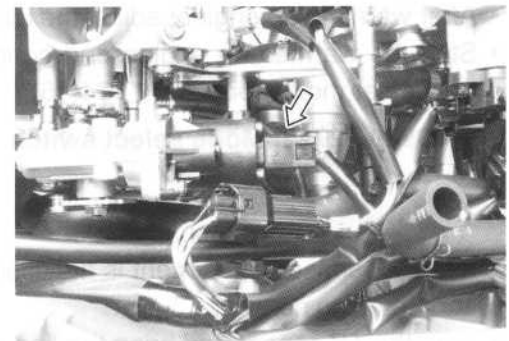

- To set the ST valve to fully open position.
- Measure the position sensor resistance at fully open position.

DATA Position sensor voltage

ST valve is fully opened: More than Approx. 4.38 V
(Yellow – Black)

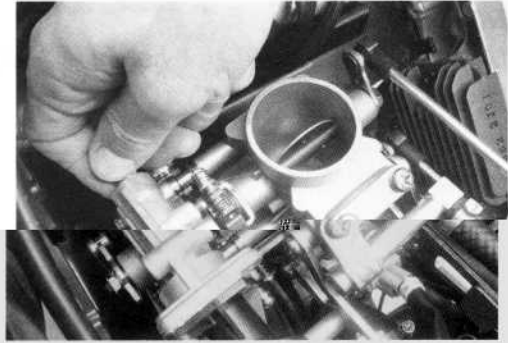

TOOL 09930-25009: Multi-circuit tester set
09900-25009: Needle pointed probe set

Tester knob indication: Voltage (---)

CAUTION

Do not use the tool for turning the STVA shaft to prevent breakdown.

- Loosen the STP sensor mounting screws.
- Adjust the STP sensor until resistance is within specification and tighten the STP sensor mounting screws.

TOOL 09930-11960: Torx wrench

STP sensor mounting screw: 2.0 N·m (0.2 kgf·m, 1.5 lb-ft)

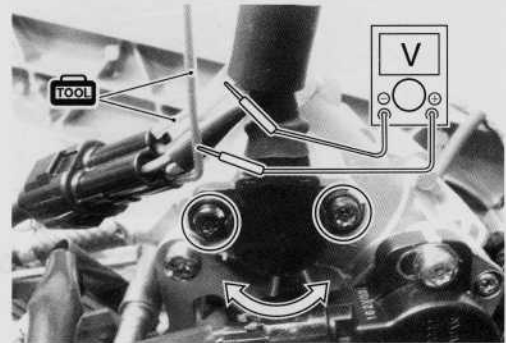

AIR CLEANER BOX INSTALLATION

Installation is in the reverse order of removal.

TP SENSOR ADJUSTMENT

After checking or adjusting the throttle valve synchronization, adjust the TP sensor positioning as follows:

- After warming up engine, adjust the idling speed to 1 300 rpm.
- Stop the warmed-up engine and connect the special tool to the dealer mode coupler. (☞ 4-15)

TOOL 09930-82720: Mode select switch



- If the TP sensor adjustment is necessary, loosen the TP sensor mounting screws.
- Turn the TP sensor and bring the line to middle.
- Tighten the TP sensor mounting screws.

TOOL 09930-11950: Torx wrench

TP sensor mounting screw: 3.5 N·m (0.35 kgf·m, 2.5 lb-ft)

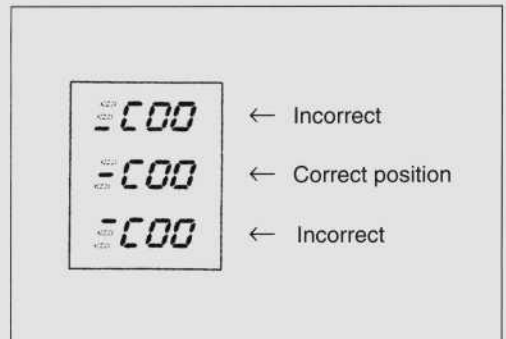

FAST IDLE INSPECTION

The fast idle system is automatic type.

When the fast idle cam is turned by the secondary throttle valve actuator, the cam pushes the lever on the throttle valve shaft causing the throttle valve to open and raise the engine speed. When the engine has warmed up, depending on the water temperature and ambient temperature as shown in the following table, the fast idle is cancelled allowing the engine to resume idle speed.

- ① Fast idle link lever
- ② Fast idle cam
- ③ STVA

NOTE:

The fast idle link lever opens throttle valve a little to increase the engine speed.

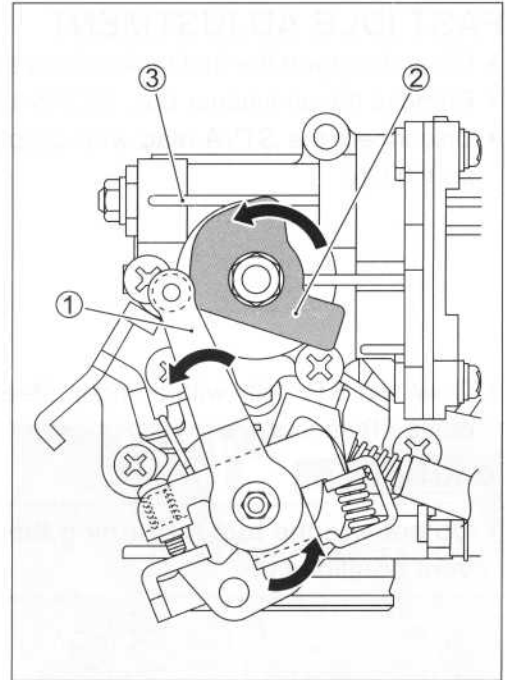

DATA

Ambient Temp.	Fast idle rpm	Fast idle cancelling Water Temp.
-5 °C (23 °F)	2 000 – 2 600 rpm	40 – 50 °C (104 – 122 °F)
15 °C (59 °F)	1 900 – 2 500 rpm	
25 °C (77 °F)	1 800 – 2 400 rpm	

If, under the above conditions, the fast idle cannot be cancelled, the cause may possibly be short-circuit in the engine coolant temperature sensor or wiring connections or maladjusted fast idle.

FAST IDLE ADJUSTMENT

- Lift and support the fuel tank with its prop stay. (☞ 5-6)
- Remove the air cleaner box. (☞ 5-16)
- Disconnect the STVA lead wire coupler and turn the ignition switch ON.

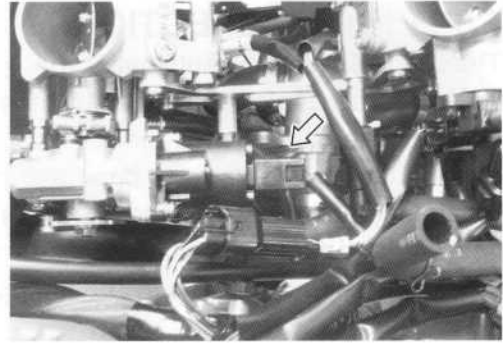

- Open the STV fully with a finger. Measure the output voltage of the TP sensor.

CAUTION

Do not use the tool for turning the STVA shaft to prevent breakdown.

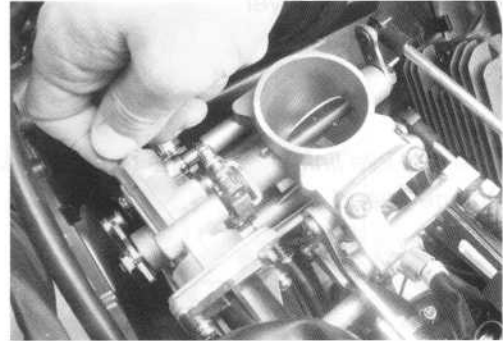

- If the TP sensor output voltage is out of specification, turn the fast idle adjusting screw ① and adjust the output voltage to specification.

DATA TP sensor output voltage: 1.21 V

TOOL 09900-25008: Multi circuit tester set
09900-25009: Needle pointed probe set

TESTER Tester knob indication: Voltage (V)

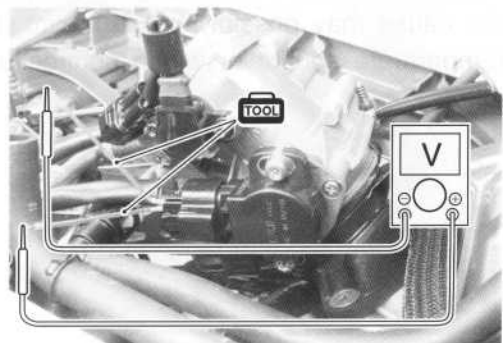
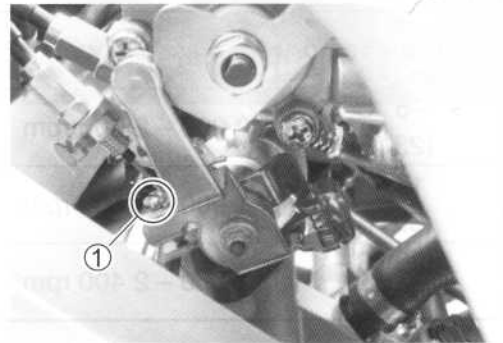

- After adjusting the fast idle speed, set the idle speed to 1 300 rpm by turning the throttle stop screw ②.



THROTTLE VALVE SYNCHRONIZATION

Check and adjust the throttle valve synchronization between two cylinders.

CALIBRATING EACH GAUGE (For vacuum balancer gauge)

- Lift and support the fuel tank. (☞ 5-6)
- Start up the engine and run it in idling condition for warming up.
- Stop the warmed-up engine.
- Remove the air cleaner box. (☞ 5-16)
- Connect the IAT and PAIR control valve sensor couplers.
- Connect the IAP sensor coupler and vacuum hose.
- Remove the rubber cap ① from the No.1 throttle body.

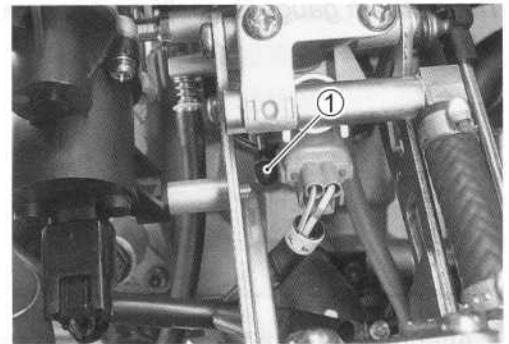

- Connect one of the four rubber hoses of the vacuum balancer gauge to the nipple on the No.1 throttle body.

TOOL 09913-13121: Vacuum balancer gauge

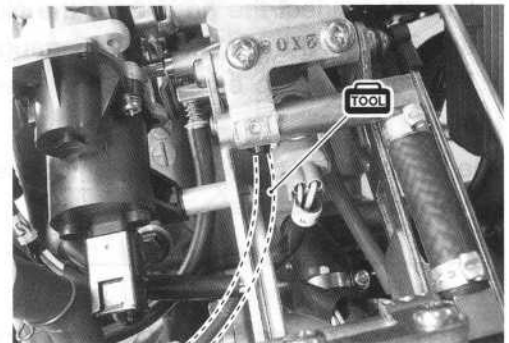

- Start up the engine and keep it running at 1 300 rpm by turning throttle stop screw ③.

CAUTION

Avoid drawing dirt into the throttle body while running the engine without air cleaner box. Dirt drawn into the engine will damage the internal engine parts.

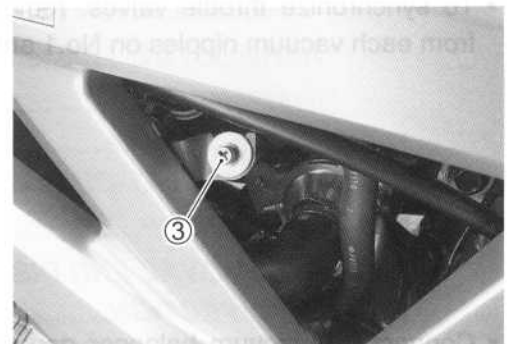

- Turn the air screw ④ of the gauge so that the vacuum acting on the tube of that hose will bring the steel ball ⑤ in the tube to the center line ⑥.

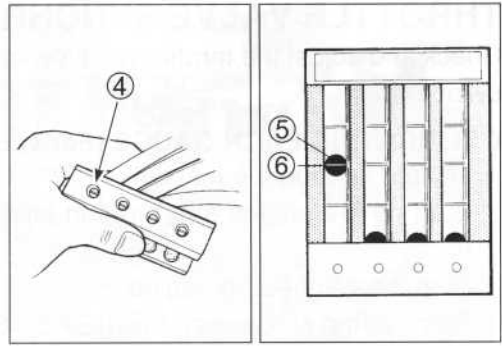

NOTE:

The vacuum gauge is positioned approx. 30 ° from the horizontal level.

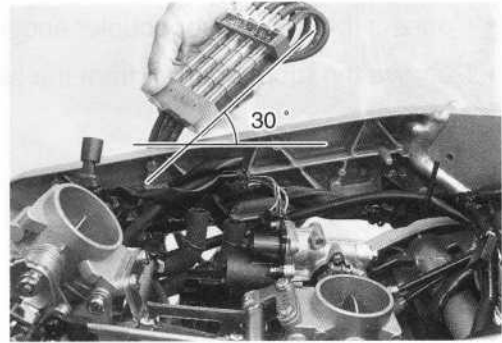

- After making sure that the steel ball stays steady at the center line, disconnect the hose from the No.1 throttle body nipple and connect the next hose of the gauge to this nipple.
- Turn air screw to bring the other steel ball ⑦ to the center line.

The balancer gauge is now ready for use in balancing the throttle valves.

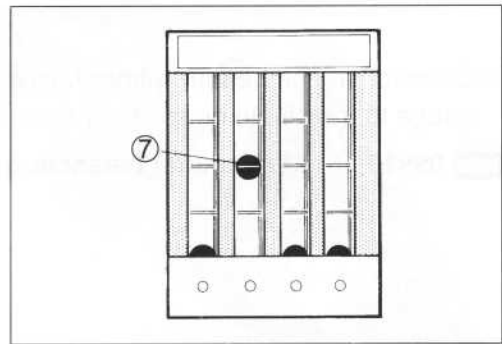

THROTTLE VALVE SYNCHRONIZATION

- To synchronize throttle valves, remove the rubber caps ① from each vacuum nipples on No.1 and No.2 throttle body.

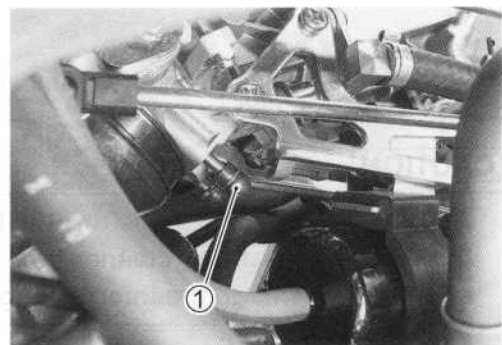

- Connect the vacuum balancer gauge hoses to the vacuum nipples ② respectively.



 09913-13121: Vacuum balancer gauge

- Connect a tachometer and start up the engine.
- Bring the engine rpm to 1 300 rpm by the throttle stop screw.
- Check the vacuum of the two cylinders and balance the two throttle valves with the synchronizing screw ③ on the No.2 throttle body.

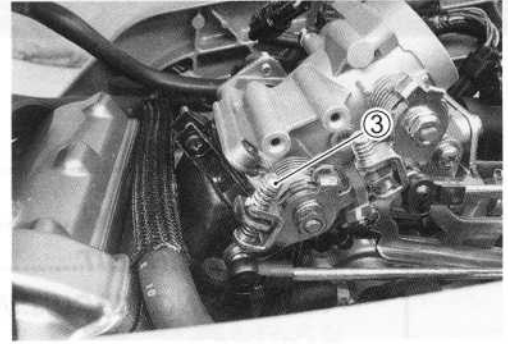

NOTE:

- * During balancing the throttle valves, always set the engine rpm at 1 300 rpm, using throttle stop screw.
- * After balancing the two valves, set the idle rpm to 1 300 rpm.

CAUTION

Avoid drawing dirt into the throttle body while running the engine without the air cleaner box. Dirt drawn into the engine will damage the internal engine parts.

NOTE:

Make sure that the throttle lever should have a gap ① (between the throttle lever and throttle lever stopper screw) during synchronization.

DATA Throttle lever gap ①: 0.17 mm (0.007 in)

