

FUJITSU Server PRIMERGY TX2550 M5

Operating Manual

Comments... Suggestions... Corrections...

The User Documentation Department would like to know your opinion of this manual. Your feedback helps us optimize our documentation to suit your individual needs.

Feel free to send us your comments by e-mail to manuals@ts.fujitsu.com.

Documentation creation according to DIN EN ISO 9001:2015

To ensure a consistently high quality standard and user-friendliness, this documentation was created to meet the regulations of a quality management system which complies with the requirements of the standard DIN EN ISO 9001:2015.

cognitas. Gesellschaft für Technik-Dokumentation mbH
www.cognitas.de

Copyright and Trademarks

Copyright 2019 FUJITSU LIMITED

All rights reserved.

Delivery subject to availability; right of technical modifications reserved.

All hardware and software names used are trademarks of their respective manufacturers.

- The contents of this manual may be revised without prior notice.
- Fujitsu assumes no liability for damages to third party copyrights or other rights arising from the use of any information in this manual.
- No part of this manual may be reproduced in any without the prior written permission of Fujitsu.

Microsoft, Windows, Windows Server, and Hyper-V are trademarks or registered trademarks of Microsoft Corporation in the USA and other countries.

Intel and Xeon are trademarks or registered trademarks of Intel Corporation or its subsidiaries in the USA and other countries.

Before reading this manual

For your safety

This manual contains important information for safely and correctly using this product.

Carefully read the manual before using this product. Pay particular attention to the accompanying manual "Safety Notes and Regulations" and ensure that these safety notes are understood before using the product. Keep this manual and the "Safety Notes and Regulations" manual in a safe place for easy reference while using this product.

Radio interference

This product is a "Class A" ITE (Information Technology Equipment). In a domestic environment this product may cause radio interference, in which case the user may be required to take appropriate measures. VCCI-A

Aluminum electrolytic capacitors

The aluminum electrolytic capacitors used in the printed circuit board assemblies of the product and in the mouse and keyboard are limited-life components. Use of these components beyond their operating life may result in electrolyte leakage or depletion, potentially causing emission of foul odor or smoke.

As a guideline, in a normal office environment (25°C) operating life is not expected to be reached within the maintenance support period (5 years). However, operating life may be reached more quickly if, for example, the product is used in a hot environment. The customer shall bear the cost of replacing replaceable components which have exceeded their operating life. Note that these are only guidelines, and do not constitute a guarantee of trouble-free operation during the maintenance support period.

High safety use

This product has been designed and manufactured to be used in commercial and/or industrial areas as a server.

When used as visual display workplace, it must not be placed in the direct field of view to avoid incommoding reflections (applies only to TX server systems).

The device has not been designed or manufactured for uses which demand an extremely high level of safety and carry a direct and serious risk of life or body if such safety cannot be assured.

These uses include control of nuclear reactions in nuclear power plants, automatic airplane flight control, air traffic control, traffic control in mass transport systems, medical devices for life support, and missile guidance control in weapons systems (hereafter, "high safety use"). Customers should not use this product for high safety use unless measures are in place for ensuring the level of safety demanded of such use. Please consult the sales staff of Fujitsu if intending to use this product for high safety use.

Measures against momentary voltage drop

This product may be affected by a momentary voltage drop in the power supply caused by lightning. To prevent a momentary voltage drop, the use of an uninterruptible power supply is recommended.

(This notice follows the guidelines of Voltage Dip Immunity of Personal Computer issued by JEITA, the Japan Electronics and Information Technology Industries Association.)

Technology controlled by the Foreign Exchange and Foreign Trade Control Law of Japan

Documents produced by Fujitsu may contain technology controlled by the Foreign Exchange and Foreign Trade Control Law of Japan. Documents which contain such technology should not be exported from Japan or transferred to non-residents of Japan without first obtaining authorization in accordance with the above law.

Harmonic Current Standards

This product conforms to harmonic current standard JIS C 61000-3-2.

Only for Japan:
About SATA HDDs

The SATA version of this server supports HDDs with SATA/BC-SATA storage interfaces. Please note that the usage and operation conditions differ depending on the type of HDD used.

For more information on the usage and operation conditions of each available type of HDD, see the following internet address:

<http://jp.fujitsu.com/platform/server/primergy/harddisk/>



Content

1	Introduction	11
1.1	Notational conventions	11
2	Before you start	13
2.1	Documentation overview	13
3	Product description	17
3.1	Overview of the server	17
3.1.1	Server front	17
3.2	Features	20
3.3	Connectors, controls and indicators	27
3.3.1	Connectors on the server	27
3.3.1.1	Server front	27
3.3.1.2	Server rear	28
3.3.2	Controls and indicators on the server front	29
3.3.2.1	Controls on the front panel	29
3.3.2.2	Indicators on the front panel	30
3.3.2.3	Indicator on the ODD	34
3.3.2.4	Indicators on the hot-plug HDD/SSD module	35
3.3.3	Indicators on the server rear	36
3.3.3.1	Indicators on the I/O panel	36
3.3.3.2	Indicator on hot-plug PSU	41
4	Important information	43
4.1	Safety instructions	43
4.2	ENERGY STAR	51
4.3	CE conformity	52
4.4	FCC Class A Compliance Statement	53
4.5	Environmental protection	54

Content

5	Starting up	57
5.1	Installation steps, overview	58
5.2	Unpacking the server	60
5.3	Setting up the floorstand model	61
5.4	Installing the server in the rack	62
5.4.1	Installing the server in the rack	64
5.5	Connecting cables	67
5.5.1	Notes on connecting/disconnecting cables	67
5.5.2	Connecting devices to the server	68
5.5.3	Connecting the power cord	69
5.5.3.1	Connecting the power cord (AC PSU)	69
5.5.3.2	Using the cable clamp (AC PSU)	70
5.6	Switching on the server for the first time	71
5.7	Configuring the server with ServerView Installation Manager	72
5.7.1	Configuring the server and installing the operating system	72
5.7.1.1	Configuring the controllers	73
5.7.1.2	Installing the operating system	73
5.8	Configuring the server without ServerView Installation Manager	74
5.8.1	Configuring the server and installing the operating system	74
5.8.1.1	Configuring the onboard SAS/SATA controller	74
5.8.1.2	Installing the operating system	74
5.9	Notes on configuring controllers	75
5.9.1	Notes on onboard SATA controllers	75
5.9.2	Notes on SAS/SATA RAID controllers	75
5.10	Note on operating system	76
6	Operation	77
6.1	Switching the server on and off	77
6.2	Access to the drives (floorstand model)	80
6.2.1	Removing the drive covers	80
6.2.2	Removing the HDD bay cover	81

6.3	Installing HDD/SSD modules	82
6.3.1	Installing 3.5-inch HDD modules	82
6.3.1.1	Removing a 3.5-inch HDD dummy module	82
6.3.1.2	Installing a 3.5-inch HDD module	83
6.3.2	Installing 2.5-inch HDD/SSD modules	84
6.3.2.1	Removing a 2.5-inch HDD/SSD dummy module	84
6.3.2.2	Installing a 2.5-inch HDD/SSD module	84
6.4	Installing a second PSU	86
6.4.1	Removing the dummy cover	86
6.4.2	Installing a PSU	86
6.5	Cleaning the server	88
7	Troubleshooting and tips	89
<hr/>		
8	Technical data	97
<hr/>		
9	Warranty and service	105
<hr/>		

1 Introduction



This operating manual describes how to install, set up and operate your server.

This operating manual is intended for those responsible for installing the hardware and ensuring that the system runs smoothly. It contains all the information you need to put your PRIMERGY TX2550 M5 into operation.

To understand the various expansion options, you will need to be familiar with the fields of hardware and data transmission and you will require a basic knowledge of the underlying operating system.

1.1 Notational conventions

The following notational conventions are used in this manual:

Text in bold	Indicates references to names of interface elements.
Text in monospace	Indicates commands.
"Quotation marks"	Indicate names of chapters and terms that are being emphasized.
▶	Describes activities that must be performed in the order shown.
 CAUTION!	Pay particular attention to texts marked with this symbol. Failure to observe this warning may endanger your life, destroy the system or lead to the loss of data.
	Indicates additional information, notes and tips.

2 Before you start

Before you start to install, set up and operate your server, please proceed as follows:

- ▶ Carefully read the safety instructions in chapter "[Important information](#)" on page 43.

2.1 Documentation overview

To get an overview on all documents for your server, see the following table.



All documentation on PRIMERGY hardware and ServerView software is available online from the Fujitsu manuals server at:

<http://manuals.ts.fujitsu.com>

For Japan:

<http://www.fujitsu.com/jp/products/computing/servers/primergy/manual/>

The complete PRIMERGY documentation set can also be downloaded as a DVD ISO image at:

<ftp://ftp.ts.fujitsu.com/images/serverview/manuals>

For Japan:

<http://www.fujitsu.com/jp/products/computing/servers/primergy/downloads/>

Document	Description
"Safety Notes and Regulations" manual "安全上のご注意" for Japan	Important safety information, available online, or as a printed copy
"FUJITSU Server PRIMERGY TX2550 M5 Operating Manual"	Information how to install, set up and operate your server, available online
"FUJITSU Server PRIMERGY TX2550 M5 Upgrade and Maintenance Manual"	Instructions for upgrading the server configuration or replacing defective hardware, available online
"D3386 BIOS Setup Utility for FUJITSU Server PRIMERGY TX2550 M5 Reference Manual"	Information on configurable BIOS options and parameters, available online

Table 1: Documentation overview

Before you start

Document	Description
System foil	Label inside the top cover outlining connectors, indicators and jumper
ID card	Various system information, such as the product name, serial number, order number, MAC addresses and DNS name (for Japan, only the product name and the serial number) The location of the ID card can be found in the overview of the server.
Software documentation	<ul style="list-style-type: none">– "ServerView Suite Local Service Concept (LSC)" user guide– "ServerView Operations Manager - Server Management" user guide– "iRMC S5 - Concepts and Interfaces" user guide– "iRMC S5 - Configuration and Maintenance" user guide– "iRMC S5 - Web Interface" user guide– "ServerView embedded Lifecycle Management (eLCM)" user guide
Illustrated Spares catalog	Spare parts identification and information system (not valid for Japan), available for online use or download (Windows OS) at http://manuals.ts.fujitsu.com/illustrated_spares or from the CSS component view of the ServerView Operations Manager
Glossary	Contains abbreviations and explanations, available online
"Warranty" manual " 保証書 " for Japan	Important information on warranty regulations, recycling and service, available online, or as a printed copy

Table 1: Documentation overview

Document	Description
"Returning used devices" manual	Recycling and contact information, available online at http://ts.fujitsu.com/recycling , or as a printed copy
"Service Desk" leaflet "サポート & サービス" for Japan	Not applicable in Japan and other countries that have different regulations for recycling
Additional documentation	RAID documentation, available online at http://manuals.ts.fujitsu.com under x86 Servers - Expansion Cards - Storage Adapters "NVMe User Guide", available online at http://manuals.ts.fujitsu.com under x86 Servers - Expansion Cards - PCIe SSD Devices - SSD PCIe3 Main 2.5" H-P EP For Japan: http://www.fujitsu.com/jp/products/computing/servers/primergy/manual/
Third party documentation	<ul style="list-style-type: none"> – Operating system documentation, online help – Peripherals documentation

Table 1: Documentation overview

3 Product description

This section provides an overview of the server and information on the features of the PRIMERGY TX2550 M5 server.

The PRIMERGY TX2550 M5 server is available as a floorstand model and a rack model.

The floorstand model can be converted to a rack model using an optional conversion kit.

3.1 Overview of the server

3.1.1 Server front

Product description

2.5-inch HDD/SSD model

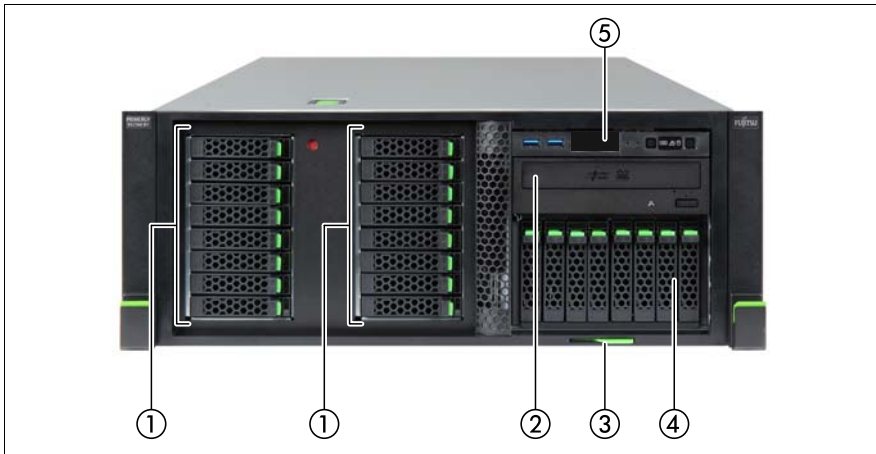

Figure 1: Server front 2.5-inch HDD/SSD model - example TX2550 M5 (rack model)

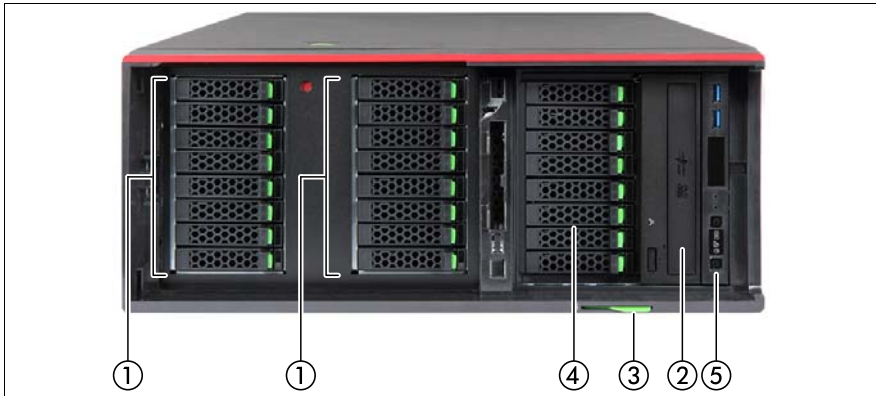

Figure 2: Server front 2.5-inch HDD/SSD model - example TX2550 M5 (floorstand model)

Pos.	Component
1	2.5-inch HDDs / SSDs / dummy modules
2	ODD / 5.25-inch dummy module
3	ID card
4	8x 2.5-inch HDD extension box / 8x 2.5-inch PCIe SSD extension box
5	Front panel module

3.5-inch HDD model

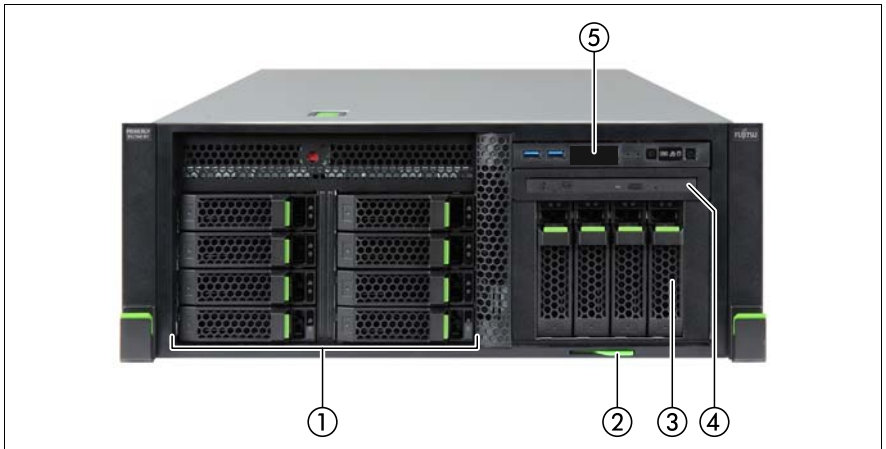

Figure 3: Server front 3.5-inch HDD model - example TX2550 M5 (rack model)

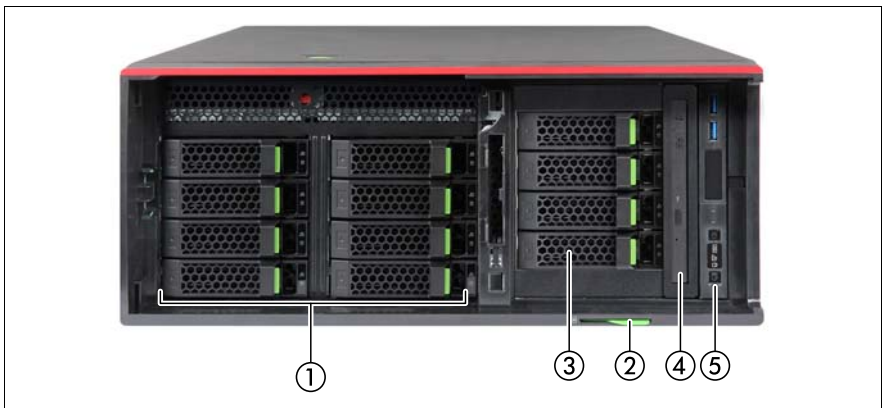

Figure 4: Server front 3.5-inch HDD model - example TX2550 M5 (floorstand model)

Pos.	Component
1	3.5-inch HDDs / dummy modules
2	ID card
3	4x 3.5-inch HDD extension box
4	ODD
5	Front panel module

3.2 Features

Customer Self Service (CSS)

The PRIMERGY Customer Self Service (CSS) concept enables you to identify and replace the affected component yourself in the case of certain error scenarios.

In the CSS concept, you can replace the following components yourself in the event of an error:

- Hot-plug HDD/SSD modules
- Hot-plug PSUs
- Memory modules (not allowed in Japan)
- System fans
- Expansion cards (not allowed in Japan)

For more information on replacing these components, see the "FUJITSU Server PRIMERGY TX2550 M5 Upgrade and Maintenance Manual".

CSS indicators on the front panel and I/O panel of the PRIMERGY server provide you with information if a CSS event arises.

In addition, CSS errors are displayed in the ServerView Operations Manager, the server management software from Fujitsu.

In the event of errors, the ServerView Operations Manager refers you directly to the affected component and its order information in the Illustrated Spares catalog of the server in question. (This feature is not available for Japan.)



More information on the CSS concept is provided in the "PRIMERGY ServerView Suite Local Service Concept - LSC" manual on the Fujitsu manuals server.

For the latest information on optional products provided for the TX2550 M5, see the configurator tool of the server:

http://ts.fujitsu.com/products/standard_servers/index.html

For Japan:

<http://www.fujitsu.com/jp/products/computing/servers/primergy/>

System board

The features of the system board are described in the "FUJITSU Server PRIMERGY TX2550 M5 Upgrade and Maintenance Manual". The setup possibilities are described in the "D3386 BIOS Setup Utility for FUJITSU Server PRIMERGY TX2550 M5 Reference Manual".

Trusted Platform Module (TPM)

A TPM for safer storage of keys can be implemented as an option. This module enables programs from third party manufacturers to store key information (e.g. drive encryption using Windows Bitlocker Drive Encryption).

The TPM is activated via the BIOS (for more information, see the "D3386 BIOS Setup Utility for FUJITSU Server PRIMERGY TX2550 M5 Reference Manual").



CAUTION!

- When using the TPM, note the program descriptions provided by the third party manufacturers.
- You must also create a backup of the TPM content. To do this, follow the third party manufacturer instructions. Without this backup, if the TPM or the system board is faulty, you will not be able to access your data.
- If a failure occurs, please inform your service about the TPM activation before it takes any action, and be prepared to provide them with your backup copies of the TPM content.

Product description

Power supply unit (PSU)

The server can be equipped with:

- with up to two AC PSUs

In its basic configuration, the server has one PSU that adjusts automatically to any power voltage in the range from 100 V to 240 V (Platinum) or 200 V to 240 V (Titanium). Besides the PSU, a second PSU can be installed optionally to serve as a redundant power supply. If one PSU fails, the second PSU in the redundant configuration ensures operation can continue uninterrupted and the defective PSU can be replaced during operation (hot-plug).

Advanced Thermal Design (ATD)

The ATD option allows you to operate the system with a wider temperature range either of 5 °C to 40 °C or 5 °C to 45 °C, depending on your system and configuration.



This option can only be ordered from the manufacturer and is indicated by the respective logo on the identification rating plate.



CAUTION

In a system that is configured with ATD, only certain components which support the respectively increased higher operating temperature range may be installed and used. For applicable restrictions, see the official configurator tool.

High level of availability and data security

When memory data is accessed, 1-bit errors are identified in the main memory and automatically corrected with the Error Correcting Code (ECC) method.

Automatic Server Reconfiguration and Restart (ASR&R) restarts the system in the event of an error and automatically "hides" the defective system components.

The Prefailure Detection and Analysis (PDA) technology from Fujitsu analyzes and monitors all components that are critical for system reliability.

A RAID controller supports different RAID levels and increase the availability and data security of the system.

The HDD/SSD modules provide additional availability.

iRMC S5 with integrated management LAN connector

The iRMC S5 (integrated **R**emote **M**anagement **C**ontroller) is a Baseboard Management Controller (BMC) with integrated management LAN connector and expanded functionality that was previously only available with additional plug-in cards. In this way, the iRMC S5 enables complete control of PRIMERGY servers, regardless of system status, and thus particularly the control of PRIMERGY servers that are in the "out-of-band" system status.

Major functions supported by the iRMC S5 include the following:

- Browser access via the own Web server of the iRMC S5
- Secure communication (SSH, SSL)
- Power Management for the managed server (depending on its system status)
- Power Consumption Management
- Connecting virtual drives as remote storage
- Text-based and graphic console bypass (Advanced Video Redirection)
- Remote Storage
- Command Line Interface (CLI)
- Simple, interactive or script-based iRMC S5 configuration
- Customer Self Service (CSS)
- User management of the iRMC S5
- Multi-computer, global iRMC S5 user administration using an LDAP Directory Service
- Automatic network configuration via DNS / DHCP
- Power supply of the iRMC S5 via the system standby supply
- Full-coverage alarm management
- System Event Log (SEL) reading and processing
- IPMI support

Product description

- CIM / WS-MAN support
- Internal Event Log for user login / logout auditing

More information about the iRMC S5 can be found in the iRMC S5 user guides (on the Fujitsu manuals server under **x86 Servers - Software - ServerView Suite - Out-Of-Band Management**).

Server management

Server management is implemented using the ServerView Operations Manager supplied and the PDA technology from Fujitsu. PDA reports the threat of a system error or overload at an early stage, allowing preventive measures to be taken.

The ServerView Operations Manager enables the management of all PRIMERGY servers in the network via a central console. The ServerView Operations Manager supports the following functions:

- Round-the-clock monitoring, regardless of server status
- High-performance, graphical console bypass (AVR) protected by HTTPS/SSL (128 bit)
- Remote storage via USB
- Remote power on
- Intrusion detection in the floorstand model
- Temperature monitoring of the CPU and the surrounding area
- Detailed status and error reports for CPUs and main memory
- Watchdog timer for Automatic Server Reconfiguration and Restart (ASR&R) in the event that memory modules or CPUs fail
- Power monitoring
- End-of-life monitoring of fans with prompt notification before failure
- Watchdog timer for monitoring the operating system with ASR&R

More information on the ServerView Operations Manager is provided in the associated documentation.

ServerView Installation Manager

You can configure the PRIMERGY server quickly and precisely with the ServerView Installation Manager software provided. User-guided menus are available for installing the server operating system (for more information, see section "[Notes on configuring controllers](#)" on page 75).

Service and support

PRIMERGY servers are easy to maintain and modular, thus enables quick and simple maintenance.

The handles and locks (touch points) used to exchange components are colored green to ensure simple and immediate recognition.

In order to prevent the components from being damaged by incorrect handling when they are being installed and removed, the areas of all components that can be touched without damaging them are also marked green.

PRIMERGY diagnostic LEDs fitted on the system board indicate which component (memory module, CPU, fan or expansion card) is not functioning properly.

The Flash EPROM program supplied with the Fujitsu utilities supports a fast BIOS update.

With the iRMC on the system board, the server can also be maintained and serviced remotely. This enables remote diagnosis for system analysis, remote configuration and remote restart should the operating system or hardware fail.

ServerView Remote Management

ServerView Remote Management is the remote management solution from Fujitsu for PRIMERGY servers. ServerView Remote Management and the relevant hardware components integrated on the system board allow remote monitoring and maintenance as well as fast restoration of operation in the event of errors.

Remote monitoring and maintenance avoids time-consuming and costly on-site repairs and reduces service costs. This leads to a reduction in the total cost of ownership and an excellent return on investment for the remote management solution.

Product description

The administrator can access all system information and information from the sensors such as fan speeds or voltages via the iRMC web interface. You can also start the text-based or graphic console bypass (Advanced Video Redirection, AVR) and connect virtual drives as remote storage.



More information about the iRMC can be found in the iRMC user guides at <http://manuals.ts.fujitsu.com> under **x86 Servers - Software - ServerView Suite - Out-Of-Band Management**.

Property and data protection

The floorstand model is protected against unauthorized opening by a lock. Apart from this, the server is also fitted with two intrusion detection switches which enable the ServerView Operations Manager to detect and log any removal of the housing cover and the cover for the HDD/SSD modules.

To prevent that the server is being removed from its location, the floorstand model can be secured to a fixed object with a steel cable running through a clip on the back.

The rack model is protected against unauthorized access by a lockable rack door.

BIOS setup security functions

The **Security** menu in BIOS Setup offers various options for protecting your data from unauthorized access. By combining these options, you can also achieve optimum protection for your system.



A detailed description of the **Security** menu and how to assign passwords can be found in the "D3386 BIOS Setup Utility for FUJITSU Server PRIMERGY TX2550 M5 Reference Manual".

3.3 Connectors, controls and indicators

3.3.1 Connectors on the server

3.3.1.1 Server front



Figure 5: Connectors on the front panel

1	2x USB 3.0 connectors
---	-----------------------

Product description

3.3.1.2 Server rear

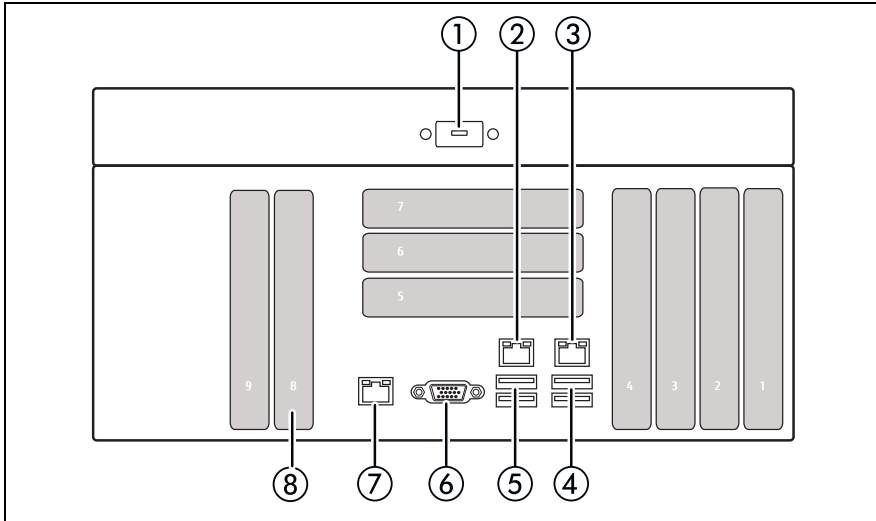

Figure 6: Connectors on the I/O panel

1*	Serial connector (optional)	5	2x USB connectors (USB 3.0)
2	Shared LAN connector	6	Video connector (VGA)
3	LAN connector	7	Management LAN connector (for iRMC server management function)
4	2x USB connectors (USB 3.0)	8	Dedicated slot for OCP modules

* The serial connector can be used as the standard interface or for communication with iRMC.

The corresponding indicators are explained in section "[Indicators on the server rear](#)" on page 36.



Depending on the BIOS settings, the shared LAN connector may also be used as a management LAN connector. For more information, see the corresponding BIOS Setup Utility reference manual.



Some of the devices connected require special software (e.g. drivers) (see documentation for the connected device).

Note for connectors on OCP modules



The LAN connectors on the OCP modules are numbered in ascending order from right to left beginning with “0”.

3.3.2 Controls and indicators on the server front



3.3.2.1 Controls on the front panel



Figure 7: Controls on the front panel module

Pos.	Label	Button	Function
1	RESET	Reset button	Reboots the system. Press the reset button with a straightened end of a paper clip.  CAUTION! Risk of data loss!
2	NMI	NMI button	Used to troubleshoot software and device driver errors. Press the NMI button with a straightened end of a paper clip.  CAUTION! Use this button only if directed to do so by qualified certified maintenance personnel!

Product description

Pos.	Label	Button	Function
3	ID	ID button	Highlights the ID indicator on the front panel and I/O panel for easy server identification.
4		On/Off button	Used to switch the server on or off.  If the system is running an ACPI-compliant operating system, pressing the On/Off button will perform a graceful shutdown.

3.3.2.2 Indicators on the front panel

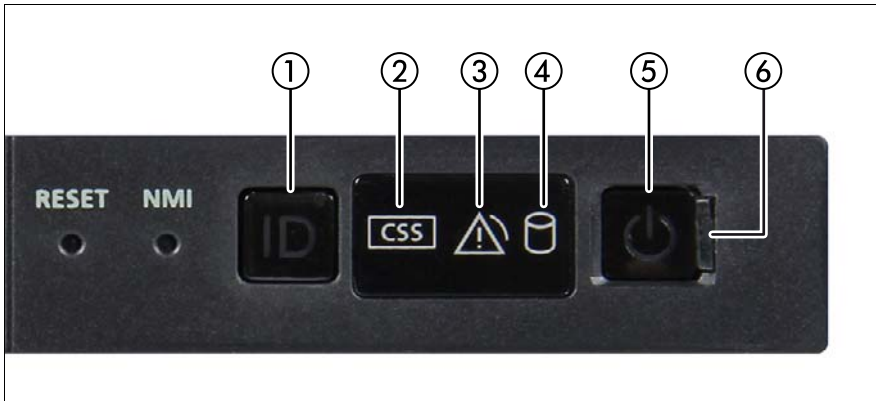







Figure 8: Indicators on the front panel module

Pos.	Label	Indicator	Status	Description
1	ID	ID indicator, see also "iRMC-related status signals" on page 38	blue on	The server has been highlighted using ServerView Operations Manager, iRMC web interface or the ID button on the front panel for easy identification.
			flashing blue	The server has been highlighted for easy identification using the iRMC with disabled local VGA output.

Pos.	Label	Indicator	Status	Description
2		CSS indicator	off	No critical event detected (CSS component).
			orange on	Prefailure event detected (CSS component). For HDDs/SSDs, see also "HDD/SSD prefailure detection" on page 33 .
			flashing orange	CSS component failure detected.
3		Global Error indicator, see also "iRMC-related status signals" on page 38	off	No critical event detected (non CSS component).
			orange on	Prefailure event detected (non CSS component).
			flashing orange	Non CSS component failure detected. Possible causes: <ul style="list-style-type: none"> – System is out of the specified temperature range – Defective sensor – CPU error – Error detected by server management software
4		HDD/SSD activity indicator	flashing green	Data access in progress.
5		Power-on indicator	off	The server is switched off.
			green on	<ul style="list-style-type: none"> – The server has been switched on but Power Cycle Delay settings delay it from turning on for a specified time. – The server is switched on and operating normally.
			flashing green slowly	The BMC firmware is starting up after the server has been connected to the mains.

Product description

Pos.	Label	Indicator	Status	Description
6		AC connected indicator	green on	<ul style="list-style-type: none"> – The server is switched off and connected to the mains (standby mode). – The server has been switched on but Power Cycle Delay settings delay it from turning on for a specified time. <p>i After connecting the server to the mains, it will take about 60 seconds until the server will enter standby mode and can be switched on.</p>
			off	<ul style="list-style-type: none"> – The server is switched off and not connected to the mains. – The server is switched on and operating normally.

iRMC-related status signals

ID indicator	Global error indicator	Description
flashing blue	off	A remote connection has been established. Local VGA output has been disabled during the remote session.
flashing blue	flashing orange	<p>An emergency flash of the iRMC firmware is in progress.</p> <p> For more information on the emergency flash of the iRMC firmware, see the "FUJITSU Server PRIMERGY TX2550 M5 Upgrade and Maintenance Manual".</p>

HDD/SSD prefailure detection

Depending on your hardware configuration HDD/SSD prefailure detection will be supported.

The requirements are:

- iRMC S5 Firmware 1.2 or later
- supported OOB RAID system

Product description

3.3.2.3 Indicator on the ODD



ODDs may have an indicator or not.

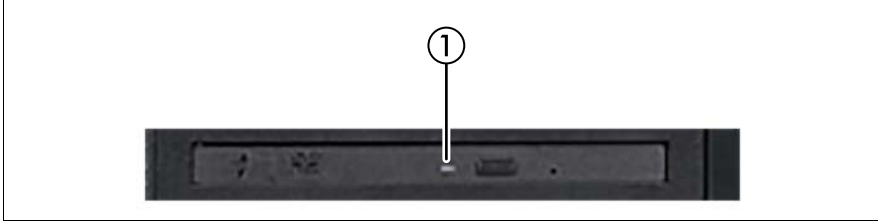

Figure 9: Example: Indicator on the ODD

Pos.	Indicator	Status	Description
1	Activity indicator	off	The ODD is inactive.
		green on	The storage medium is being accessed.

3.3.2.4 Indicators on the hot-plug HDD/SSD module

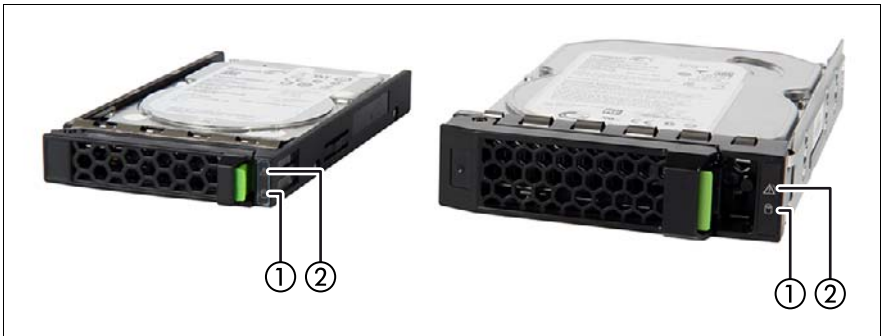



Figure 10: Indicators on the hot-plug HDD/SSD module

Pos.	Label	Indicator	Status	Description
1		Access indicator	off	The HDD/SSD is inactive.
			green on	The HDD/SSD being accessed
2		Error indicator	off	No HDD/SSD error detected.
			orange on	An HDD/SSD error has been detected. Possible causes: <ul style="list-style-type: none"> – The drive is defective and needs replacing. – A RAID rebuild process has failed. – The HDD/SSD module has not been inserted correctly.
			flashing orange slowly	HDD/SSD RAID rebuild is in progress. Data is being restored after replacing a drive that has been combined into a RAID array.



3.3.3 Indicators on the server rear

3.3.3.1 Indicators on the I/O panel

ID, CSS and Global Error indicators



Figure 11: ID, CSS and Global Error indicators

Pos.	Label	Indicator	Status	Description
1	ID	ID indicator, see also "iRMC-related status signals" on page 38	blue on	The server has been highlighted using ServerView Operations Manager, iRMC web interface or the ID button on the front panel for easy identification.
			flashing blue	The server has been highlighted for easy identification using the iRMC (AVR) with disabled local VGA output.
		CSS indicator	off	No critical event detected (CSS component).
			orange on	Prefailure event detected (CSS component).
			flashing orange	CSS component failure detected.
		Global Error indicator, see also "iRMC-related status signals" on page 38	off	No critical event detected (non CSS component).
			orange on	Prefailure event detected (non CSS component).
			flashing orange	Non CSS component failure detected. Possible causes: <ul style="list-style-type: none"> – System is out of the specified range – Defective sensor – CPU error – Error detected by server management software



Note on CSS and Global Error indicators on the I/O panel:

If CSS and Global Error indicators are located in the same place on the I/O panel of the server, also check the indicators on the front panel to determine if a CSS or Global Error event has been detected.



For more information on detected errors, see the System Event Log or use the ServerView Operations Manager or iRMC web interface.

Product description

iRMC-related status signals

ID indicator	Global error indicator	Description
flashing blue	off	A remote connection has been established. Local VGA output has been disabled during the remote session.
flashing blue	flashing orange	<p>An emergency flash of the iRMC firmware is in progress.</p> <p> For more information on the emergency flash of the iRMC firmware, see the "FUJITSU Server PRIMERGY TX2550 M5 Upgrade and Maintenance Manual".</p>

LAN indicators

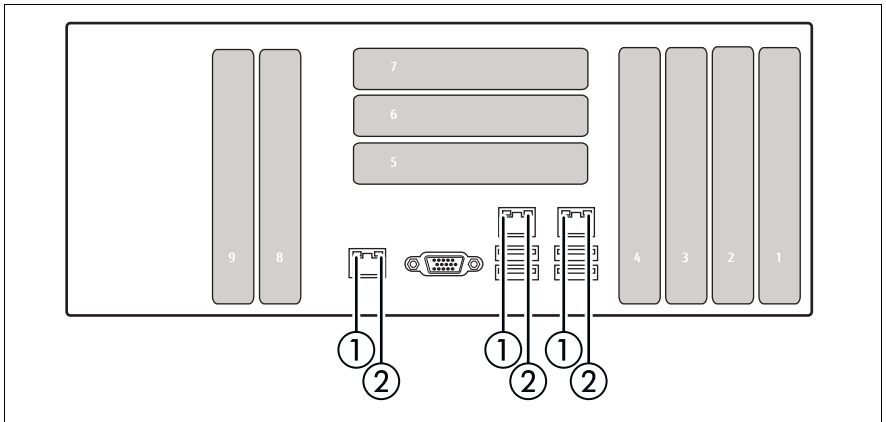

Figure 12: LAN Indicators

Pos.	Indicator	Status	Description
1	LAN link/transfer indicator	green on	A LAN connection has been established.
		off	LAN is not connected.
		flashing green	LAN data transfer is in progress.
2	LAN speed indicator	yellow on	Data traffic at a transfer rate of 1 Gbit/s.
		green on	Data traffic at a transfer rate of 100 Mbit/s.
		off	Data traffic at a transfer rate of 10 Mbit/s.

Indication of LAN connection supporting Energy Efficient Ethernet (EEE mode)

To configure the EEE mode, it is necessary that the on board LAN or an add in LAN card supports this mode and the connected switch supports this mode as well.

Pos.	Indicator	Status	Description
1	LAN link/transfer indicator	short flashing green 3x, then off	A LAN connection has been established (1 Gbit or 100 Mbit) and EEE mode is active
2	LAN speed indicator	short flashing yellow 1x, then 2 seconds off green off	Data traffic at a transfer rate of 1 Gbit/s.
		short flashing green 1x, then 2 seconds off yellow off	Data traffic at a transfer rate of 100 Mbit/s

Table 2: LAN indicators if EEE mode is active



Note on the onboard LAN controller

The system board is equipped with a Gigabit Ethernet Controller that supports transfer rates of 10 Mbit/s, 100 Mbit/s and 1 Gbit/s.

The separate management LAN connector is used as a management interface (iRMC S5) and is prepared for operation with the Remote Management. Optionally LAN connector 1 can also be used for iRMC S5 server management.

3.3.3.2 Indicator on hot-plug PSU

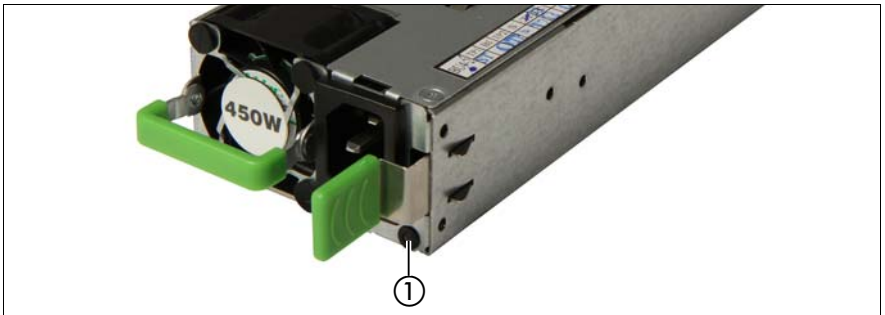

Figure 13: Indicator on hot-plug PSU

Pos.	Indicator	Status	Description
1	PSU status indicator	flashing green	The server is switched off, but mains voltage is present (standby mode).
		green on	The server is switched on and operating properly.
		flashing orange	An overload has been detected. The PSU is still running, but failure might be imminent.
		orange on	An PSU failure has been detected. Possible causes: <ul style="list-style-type: none"> – Over/under voltage – Overheating – Fan failure

4 Important information

In this chapter you will find essential information regarding safety when working on your server.



Depending on your server or the installed options some information is not valid for your server.



CAUTION!

Before installing and starting up a server, please observe the safety instructions listed in the following section. This will help you to avoid making serious errors that could impair your health, damage the server and endanger the data base.

4.1 Safety instructions



The following safety instructions are also provided in the manual "Safety Notes and Regulations" or "安全上のご注意".

This server meets the relevant safety regulations for IT equipment. If you have any questions about whether you can install the server in the intended environment, please contact your sales outlet or our customer service team.

- The actions described in this manual shall be performed by technical specialists. A technical specialist is a person who is trained to install the server including hardware and software.
- Repairs to the server that do not relate to CSS failures shall be performed by service personnel. Please note that unauthorized interference with the server will void the warranty and exempt the manufacturer from all liability.
- Any failure to observe the guidelines in this manual, and any improper repairs could expose the user to risks (electric shock, energy hazards, fire hazards) or damage the equipment.
- Only valid for non hot-plug components
Before installing/removing internal components to/from the server, turn off the server, all peripheral devices, and any other connected devices. Also unplug all power cords from the power outlet. Failure to do so can cause electric shock or damage.

Important information

Before starting up

- During installation and before operating the server, observe the instructions on environmental conditions for your server.
- If the server is brought in from a cold environment, condensation may form both inside and on the outside of the server.

Wait until the server has acclimatized to room temperature and is absolutely dry before starting it up. Material damage may be caused to the server if this requirement is not observed.

- Only transport the server in its original packaging or in packaging that protects it from impacts and jolts.
In Japan and APAC, transporting the server in its original packaging does not apply.

Installation and operation

- This server should not be operated in ambient temperatures above 35 °C. For servers with Advanced Thermal Design the ambient temperature can increase to 40 °C or 45 °C.
- If the server is integrated into an installation that draws power from an industrial power supply network with an IEC309 connector, the power supply's fuse protection must comply with the requirements for non-industrial power supply networks for type A connectors.
- The server automatically adjusts itself to a mains voltage, see the type label of your server. Ensure that the local mains voltage lies within these limits.
- This server must only be connected to properly grounded power outlets or connected to the grounded rack internal power distribution server with tested and approved power cords.
- Ensure that the server is connected to a properly grounded power outlet close to the server.
- Ensure that the power sockets on the server and the properly grounded power outlets are easily accessible.
- The On/Off button or the main power switch (if present) does not isolate the server from the mains power supply. In case of repair or servicing disconnect the server completely from the mains power supply, unplug all power plugs from the properly grounded power outlets.

- Always connect the server and the attached peripheral devices to the same power circuit. Otherwise you run the risk of losing data if, for example, the server is still running but a peripheral device (e.g. memory subsystem) fails during a power outage.

- The adequately shielded data cables must be used.

All data and signal cables must have sufficient shielding. The use of cable type S/FTP Cat5 or higher is recommended.

Use of unshielded or badly shielded cables may lead to increased emission of interference and/or reduced fault-tolerance of the device.

- Ethernet cabling has to comply with EN 50173 and EN 50174-1/2 standards or ISO/IEC 11801 standard respectively. The minimum requirement is a Category 5 shielded cable for 10/100 Ethernet, or a Category 5e cable for Gigabit Ethernet.
- Route the cables in such a way that they do not create a potential hazard (ensure that no-one can trip over them) and that they cannot be damaged. When connecting the server, see the relevant instructions in this manual.
- Never connect or disconnect data transmission lines during a storm (risk of lightning hazard).
- Ensure that no objects (e.g. jewelry, paperclips etc.) or liquids can get inside the server (risk of electric shock, short circuit).
- In emergencies (e.g. damaged casing, controls or cables, penetration of liquids or foreign bodies), contact the server administrator or your customer service team. Only disconnect the server from the mains power supply if there is no risk of harming yourself.
- Proper operation of the server (in accordance with IEC 60950-1 resp. EN 60950-1) is only ensured if the server is completely assembled and the rear covers for the installation slots have been fitted (electric shock, cooling, fire protection, interference suppression).
- Only install server expansions that satisfy the requirements and rules governing safety and electromagnetic compatibility and those relating to telecommunication terminals. If you install other expansions, they may damage the server or violate the safety regulations. Information on which server expansions are approved for installation can be obtained from our customer service center or your sales outlet.
- The components marked with a warning notice (e.g. lightning symbol) may only be opened, removed or exchanged by authorized, qualified personnel. Exception: CSS components can be replaced.

Important information

- The warranty is void if the server is damaged during installation or replacement of server expansions.
- Only set screen resolutions and refresh rates that are specified in the operating manual for the monitor. Otherwise, you may damage your monitor. If you are in any doubt, contact your sales outlet or customer service center.
- Only valid for non hot-plug components
Before installing/removing internal components to/from the server, turn off the server, all peripheral devices, and any other connected devices. Also unplug all power cords from the power outlet. Failure to do so can cause electric shock or damage.

Internal devices remain hot after shutdown. Wait for a while after shutdown before installing or removing internal options.

- Do not damage or modify internal cables or internal devices. Doing so may cause a server failure, fire, or electric shock and will void the warranty and exempt the manufacturer from all liability.
- The circuit boards and soldered parts of internal options are exposed and can be damaged by static electricity. To ensure reliable protection, you must wear an earthing band on your wrist when working with this type of module and connect it to an unpainted, conducting metal part of the server.
- Do not touch the circuitry on boards or soldered parts. Hold the metallic areas or the edges of the circuit boards.
- Install the screw removed during installation/detaching internal options in former position. To use a screw of the different kind can cause a breakdown of equipment.
- The procedure of installation on this notes might change depending on a configuration of option.

Batteries

- Incorrect replacement of batteries may lead to a risk of explosion. The batteries may only be replaced with identical batteries or with a type recommended by the manufacturer.
- Do not throw batteries into the trash can.

Batteries must be disposed of in accordance with local regulations concerning special waste.

- Ensure that you insert the battery the right way round.

- The battery used in this server may present a fire or chemical burn hazard if mistreated. Do not disassemble, heat about 100 °C (212F), or incinerate the battery.
- Replace the lithium battery on the system board in accordance with the instructions in the corresponding Upgrade and Maintenance Manual, chapter "System board and components" > "CMOS battery".
- All batteries containing pollutants are marked with a symbol (a crossed-out garbage can). In addition, the marking is provided with the chemical symbol of the heavy metal decisive for the classification as a pollutant:

Cd Cadmium

Hg Mercury

Pb Lead

Working with optical disk drives (ODDs) and media

When working with ODDs, these instructions must be followed.



CAUTION!

- Only use CDs/DVDs/BDs that are in perfect condition, in order to prevent data loss, equipment damage and injury.
- Check each CD/DVD/BD for damage, cracks, breakages etc. before inserting it in the drive.

Note that any additional labels applied may change the mechanical properties of a CD/DVD/BD and cause imbalance and vibrations.

Damaged and imbalanced CDs/DVDs/BDs can break at high drive speeds (data loss).

Under certain circumstances, sharp CD/DVD/BD fragments can pierce the cover of the ODD (equipment damage) and can fly out of the drive (danger of injury, particularly to uncovered body parts such as the face or neck).

- High humidity and airborne dust levels are to be avoided. Electric shocks and/or server failures may be caused by liquids such as water, or metallic items, such as paper clips, entering a drive.
- Shocks and vibrations are also to be avoided.
- Do not insert any objects other than the specified CDs/DVDs/BDs.

Important information

- Do not pull on, press hard, or otherwise handle the CD/DVD/BD tray roughly.
- Do not disassemble the ODD.
- Before use, clean the ODD tray using a soft, dry cloth.
- As a precaution, remove disks from the ODD when the drive is not to be used for a long time. Keep the ODD tray closed to prevent foreign matter, such as dust, from entering the ODD.
- Hold CDs/DVDs/BDs by their edges to avoid contact with the disk surface.
- Do not contaminate the CD/DVD/BD surface with fingerprints, oil, dust, etc. If dirty, clean with a soft, dry cloth, wiping from the center to the edge. Do not use benzene, thinners, water, record sprays, antistatic agents, or silicone-impregnated cloth.
- Be careful not to damage the CD/DVD/BD surface.
- Keep the CDs/DVDs/BDs away from heat sources.
- Do not bend or place heavy objects on CDs/DVDs/BDs.
- Do not write with ballpoint pen or pencil on the label (printed) side.
- Do not attach stickers or similar to the label side. Doing so may cause rotational eccentricity and abnormal vibrations.
- When a CD/DVD/BD is moved from a cold place to a warm place, moisture condensation on the CD/DVD/BD surface can cause data read errors. In this case, wipe the CD/DVD/BD with a soft, dry cloth then let it air dry. Do not dry the CD/DVD/BD using devices such as a hair dryer.
- To avoid dust, damage, and deformation, keep the CD/DVD/BD in its case whenever it is not in use.
- Do not store CDs/DVDs/BDs at high temperatures. Areas exposed to prolonged direct sunlight or near heating appliances are to be avoided.



You can prevent damage from the ODD and the CDs/DVDs/BDs, as well as premature wear of the disks, by observing the following suggestions:

- Only insert disks in the drive when needed and remove them after use.
- Store the disks in suitable sleeves.

- Protect the disks from exposure to heat and direct sunlight.

Laser information

The ODD complies with IEC 60825-1 laser class 1.



CAUTION!

The ODD contains a light-emitting diode (LED), which under certain circumstances produces a laser beam stronger than laser class 1. Looking directly at this beam is dangerous.

Never remove parts of the ODD casing!

Modules with Electrostatic-Sensitive Devices (ESD modules)

ESD modules are identified by the following sticker:

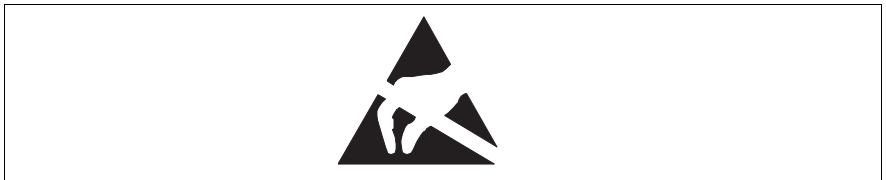

Figure 14: ESD label



The ESD label can be different.

When you handle ESD modules, you must always observe the following points:

- Switch off the server and remove the power plugs from the power outlets before installing or removing ESD modules.
- The circuit boards and soldered parts of internal options are exposed and can be damaged by static electricity. To ensure reliable protection, you must wear an earthing band on your wrist when working with ESD modules and connect it to an unpainted, conducting metal part of the server.
- Any devices or tools that are used must be free of electrostatic charge.
- Wear a suitable grounding cable that connects you to the external chassis of the server.
- Always hold ESD modules at the edges or at the points marked green (touch points).

Important information

- Do not touch any connectors or conduction paths on an ESD module.
- Place all the components on a pad which is free of electrostatic charge.



For a detailed description of how to handle ESD modules, see the relevant European or international standards (EN 61340-5-1, ANSI/ESD S20.20).

Transporting the server



CAUTION!

Only transport the server in its original packaging or in packaging that protects it from impacts and jolts.
In Japan and APAC, transporting the server in its original packaging does not apply.

Do not unpack the server until it is at its installation location.

If you need to lift or transport the server, ask other people to help you.

Never lift or carry the server by the handles or the Quick Release Levers (QRLs) on the front panel.

Notes on installing the server in the rack



CAUTION!

- For safety reasons, at least 2 people are required to install the server in the rack because of its weight and size.
(For Japan, see "安全上のご注意".)
- Never lift the server into the rack using the QRLs on the front panel.
- When connecting and disconnecting cables, observe the relevant instructions in the "Important Information" chapter of the technical manual for the corresponding rack. The technical manual is supplied with the corresponding rack.
- When installing the rack, ensure that the anti-tilt mechanism is correctly fitted.
- Do not extend more than one server out of the rack simultaneously even if the tilt protection is in place. If several servers are simultaneously extended from the rack, there is a risk that the rack could tip over. See the safety information of the rack and the warning label.

- If the server/rack is intended for permanent connection to the mains only an authorized specialist (electrician) is allowed to work. Please follow the regulation of each country.
- If the server is integrated into an installation that draws power from an industrial power supply network with an IEC309 type connector, the power supply's fuse protection must comply with the requirements for non-industrial power supply networks for the type A connector.

Other important information

- During cleaning, observe the instructions in the corresponding Operating Manual chapter "Starting up and operation" > "Cleaning the server".
- Keep all manuals close to the server. All documentation must be included if the equipment is passed on to a third party.

4.2 ENERGY STAR



Products that have been certified compliant with ENERGY STAR and labelled are in full compliance with the specification at shipping. Note that energy consumption can be affected by software that is installed or any changes that are made to the hardware configuration or BIOS or energy options subsequently. In such cases, the properties guaranteed by ENERGY STAR can no longer be assured.

The "ServerView Operations Manager" user guide contains instructions for reading out measurement values, including those relating to current energy consumption and air temperatures. Either the Performance Monitor or the Task Manager can be used to read out CPU utilization levels.

4.3 CE conformity



The system complies with the requirements of European Regulations. Find the CE declaration on certificate portal: <https://sp.ts.fujitsu.com/sites/certificates/default.aspx>

To open the CE declaration applicable for your system, proceed as follows:

- ▶ Select **Industry Standard Servers**.
- ▶ Select your model, e.g. **Rack server**.
- ▶ Select your system, e.g. **PRIMERGY RX2530 M1**.
- ▶ Select **CE Cert <your system>**.



CAUTION!

This is a Class A product. In a domestic environment this product may cause RF interference, in which case the user may be required to take adequate measures.

4.4 FCC Class A Compliance Statement

If there is an FCC statement on the device, it applies to the products covered in this manual, unless otherwise specified herein. The statement for other products will appear in the accompanying documentation.

NOTE:

This equipment has been tested and found to comply with the limits for a "Class A" digital device, pursuant to Part 15 of the FCC rules and meets all requirements of the Canadian Interference-Causing Equipment Standard ICES-003 for digital apparatus. These limits are designed to provide reasonable protection against harmful interference in a residential installation. This equipment generates, uses and can radiate radio frequency energy and, if not installed and used in strict accordance with the instructions, may cause harmful interference to radio communications. However, there is no warranty that interference will not occur in a particular installation. If this equipment does cause harmful interference to radio or television reception, which can be determined by turning the equipment off and on, the user is encouraged to try to correct the interference by one or more of the following measures:

- Reorient or relocate the receiving antenna.
- Increase the separation between equipment and the receiver.
- Connect the equipment into an outlet on a circuit different from that to which the receiver is connected.
- Consult the dealer or an experienced radio/TV technician for help.

Fujitsu is not responsible for any radio or television interference caused by unauthorized modifications of this equipment or the substitution or attachment of connecting cables and equipment other than those specified by Fujitsu. The correction of interferences caused by such unauthorized modification, substitution or attachment will be the responsibility of the user.

The use of shielded I/O cables is required when connecting this equipment to any and all optional peripheral or host devices. Failure to do so may violate FCC and ICES rules.

4.5 Environmental protection

Environmentally-friendly product design and development

This product has been designed in accordance with the Fujitsu standard for "environmentally friendly product design and development". This means that key factors such as durability, selection and labeling of materials, emissions, packaging, ease of dismantling and recycling have been taken into account. This saves resources and thus reduces the harm done to the environment.

More information can be found at:

http://ts.fujitsu.com/products/standard_servers/index.html

For Japan:

<http://jp.fujitsu.com/platform/server/primergy/concept/>

Energy-saving information

Devices that do not need to be constantly switched on should be switched off until they are needed as well as during long breaks and after completion of work.

Packaging information

This packaging information does not apply in Japan and APAC.

Do not throw away the packaging. You may need it later for transporting the server. If possible, the equipment should only be transported in its original packaging.

Information on handling consumables

Please dispose of printer consumables and batteries in accordance with the applicable national regulations.

In accordance with EU directives, batteries must not be disposed of with unsorted domestic waste. They can be returned free of charge to the manufacturer, dealer or an authorized agent for recycling or disposal.

All batteries containing pollutants are marked with a symbol (a crossed-out garbage can). They are also marked with the chemical symbol for the heavy metal that causes them to be categorized as containing pollutants:

Cd Cadmium

Hg Mercury

Pb Lead

Labels on plastic casing parts

Please avoid sticking your own labels on plastic parts wherever possible, since this makes it difficult to recycle them.

Returns, recycling and disposal

Please handle returns, recycling and disposal in accordance with local regulations.



The device must not be disposed of with domestic waste. This device is labeled in compliance with European directive 2012/19/EU on waste electrical and electronic equipment (WEEE).

This directive sets the framework for returning and recycling used equipment and is valid across the EU. When returning your used device, please use the return and collection systems available to you.

More information can be found at:

<http://ts.fujitsu.com/recycling>

Details regarding the return and recycling of devices and consumables within Europe can also be found in the "Returning used devices" manual, via your local Fujitsu branch, or at:

<http://ts.fujitsu.com/recycling>

5 Starting up



CAUTION!

- Follow the safety instructions in chapter "[Important information](#)" on [page 43](#).
- Do not expose the server to extreme environmental conditions (see "[Ambient conditions](#)" on [page 101](#)). Protect the server from dust, humidity and heat.
- Ensure that the server is acclimatized for the time indicated in this table before putting it into operation.

Temperature difference (°C)	Minimum acclimatization time (hours)
5	3
10	5
15	7
20	8
25	9
30	10

Table 3: Acclimatization time

In the [table "Acclimatization time"](#), the temperature difference refers to the difference between the operating environment temperature and the temperature to which the server was exposed previously (outside, transport or storage temperature).

5.1 Installation steps, overview

- ▶ First of all, carefully read the safety instructions in "[Important information](#)" on [page 43](#) and following.
- ▶ Transport the server to the place where you want to set it up.
- ▶ Unpack the system, check the contents of the package for visible transport damage and check whether the items delivered correspond to the details on the delivery note, see "[Unpacking the server](#)" on [page 60](#).
- ▶ Ensure that you have all necessary manuals, see "[Documentation overview](#)" on [page 13](#); print out the PDF files if required.
- ▶ Components that have been ordered additionally may be delivered loose with the server. For installing, see the original component documentation.
- ▶ Install the server in the rack, see section "[Installing the server in the rack](#)" on [page 62](#).
- ▶ Connect the devices to the server. To do this, see sections "[Notes on connecting/disconnecting cables](#)" on [page 67](#) and "[Connecting devices to the server](#)" on [page 68](#).
- ▶ Connect the server to the mains, see section "[Connecting the power cord](#)" on [page 69](#).
- ▶ If applicable, install the HDD/SSD modules, see "[Installing HDD/SSD modules](#)" on [page 82](#).
- ▶ If applicable, install a second PSU, see "[Installing a second PSU](#)" on [page 86](#).
- ▶ Familiarize yourself with the controls and indicators on the front and rear of the server, see section "[Connectors, controls and indicators](#)" on [page 27](#).

- ▶ Configure the server and install the desired operating system and applications. The following options are available:

Installation with ServerView Installation Manager

- Local configuration and installation, see section "[Configuring the server with ServerView Installation Manager](#)" on page 72.
- Remote installation, see section "[Configuring the server with ServerView Installation Manager](#)" on page 72.



For more information on installing the server (remote or local), see the "ServerView Installation Manager" user guide at <http://manuals.ts.fujitsu.com> under **x86 Servers - Software - ServerView Suite - Server Installation and Deployment**.

Installation without ServerView Installation Manager

- Local configuration and installation, see section "[Configuring the server without ServerView Installation Manager](#)" on page 74.

5.2 Unpacking the server



CAUTION!

Follow the safety instructions in ["Important information" on page 43](#).

The server must always be lifted or carried by at least two people.
(For Japan, see "安全上のご注意")

Do not unpack the server until it is at its installation location.

- ▶ Transport the server to the place where you want to set it up.
- ▶ Unpack all individual parts.

Keep the original packaging in case you want to transport the server again (does not apply to Japan).

- ▶ Check the delivery for any damage during transport.
- ▶ Check whether the items delivered match the details on the delivery note.

The product name and serial number of the product can be found on the ID card (see section ["Documentation overview" on page 13](#)).

- ▶ Notify your supplier immediately should you discover that the items delivered do not correspond to the delivery note.
- ▶ Remove all scratching protection foils from the front panel, HDD/SSD frames, Fujitsu and PRIMERGY logo, VGA dummy and ODD dummy in case they are still stucked to the server system.

5.3 Setting up the floorstand model



If you are not installing a PRIMERGY TX2550 M5 floorstand model, skip this section and continue reading at section "[Installing the server in the rack](#)" on page 62.



CAUTION!

Note the safety instructions in chapter "[Important information](#)" on page 43.

- ▶ Transport the server to the place where you want to set it up.
- ▶ Unpack the server (see section "[Unpacking the server](#)" on page 60).
- ▶ Set up the server.



CAUTION!

- The device must be protected from direct sunlight.
 - The required minimum distances for operation and maintenance areas must be adhered to.
 - The server must be accessible at the rear for connection to other devices (e.g. memory subsystem).
 - The mains plug must be accessible easily and safely.
 - There must be a clearance of at least 200 mm in front of and behind the server to ensure adequate ventilation of the subsystem.
- ▶ Connect the devices to the server, see section "[Connecting devices to the server](#)" on page 68 and section "[Notes on connecting/disconnecting cables](#)" on page 67.
 - ▶ Connect the server to the mains, see section "[Connecting the power cord](#)" on page 69.

5.4 Installing the server in the rack



CAUTION!

- Please observe the safety information and notes on rack mounting in chapter "[Important information](#)" on page 43 and section "[Notes on installing the server in the rack](#)" on page 50.
- At least two people are needed to install / remove the server in the rack. (For Japan, see "安全上のご注意".)
- Do not extend more than one unit out of the rack simultaneously even if the tilt protection is in place. If several units are simultaneously extended out of the rack, there is a risk that the rack could tip over.

Fujitsu rack systems

The rack systems from Fujitsu support the installation of PRIMERGY servers:

- PRIMECENTER rack
- PRIMECENTER M1 rack
- DataCenter rack
- 19-inch standard rack (for Japan)
- 19-inch slim rack (for Japan)



For information on mounting the server in the rack, see the "Mounting Instructions" provided with the Rack Mounting Kit. For more information, see the manual of your rack system.

For Japan, see also to the "Rack system structure guide".



Online documentation for rack installation can be found on: <http://manuals.ts.fujitsu.com/index.php?id=5406-5605-5606>

For Japan:

http://jp.fujitsu.com/platform/server/primergy/manual/peri_rack.html

To accommodate the ventilation concept and ensure proper ventilation, any unused areas in the rack must be sealed using dummy covers.

The power is supplied via the multiple socket outlets fitted in the rack (not valid for Japan).

The main features of Fujitsu rack systems are as follows:

- rail systems that can be mounted without tools
- support systems having a linear alignment feature to ensure that they can be adjusted to different rack depths

Asymmetrical PRIMECENTER rack and DataCenter rack provide an enhanced cable management in the lateral rack area.

3rd party racks



Installation in most current rack systems from other manufacturers (3rd party racks) is also supported. For details please contact your sales representative.

- Wire the server. Read the information in section "[Connecting devices to the server](#)" on page 68 and section "[Notes on connecting/disconnecting cables](#)" on page 67.
- Connect the system to the mains, see section "[Connecting the power cord](#)" on page 69.

5.4.1 Installing the server in the rack



CAUTION!

At least two people are needed to position the server on the rack rails.
(For Japan, see " 安全上のご注意 ".)



For configurations below 32 kg:

At least two people are needed to lift the server into the rack cabinet.



For configurations below 55 kg:

At least three people are needed to lift the server into the rack cabinet.



For configurations above 55 kg:

At least four people are needed to lift the server into the rack cabinet.

Additionally, a lifter is required in the following cases:

- The server weighs more than 50 kg.
- The server weighs more than 21 kg and is to be installed above the height of 25 U.

When using a lifter, this installation procedure needs to be carried out by maintenance personnel.

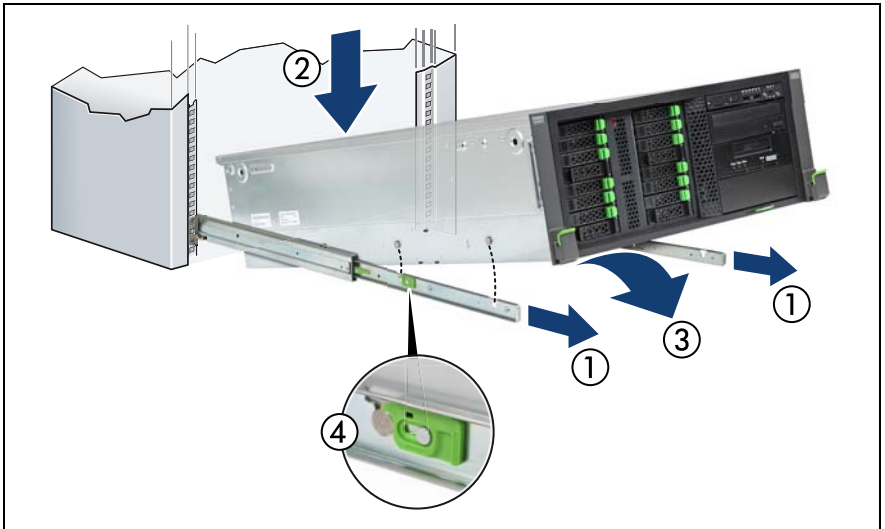

Figure 15: Inserting the server into the rack rails

- ▶ Fully extend the rack rails until they lock in place (1).



The rack rails must click into place so that they can no longer be moved.

- ▶ At a slight angle, lower the server onto the rear mounting point on the rack rails (2).
- ▶ Fold down the server (3). Ensure that all six rack mounting bolts are properly seated in the mounting points on the rack rails and that the locking bars engage (4).

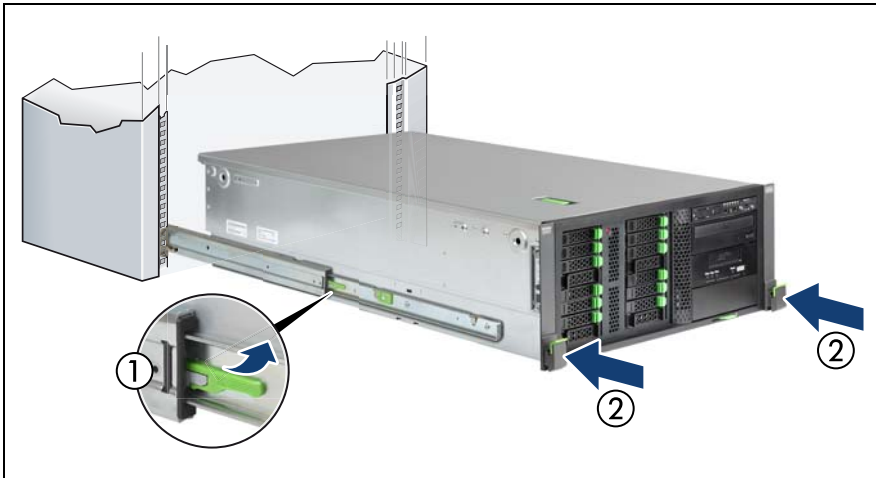

Figure 16: Sliding the server into the rack

- ▶ Release the locking mechanism of both rack rails (1).
- ▶ Push the server as far as it will go into the rack (2) until the quick-release levers engage (3).



CAUTION!

Be careful with your fingers. You can pinch them when the quick-release levers change to the release position.

- ▶ Connect all cables except the power cord to the server rear.

5.5 Connecting cables

5.5.1 Notes on connecting/disconnecting cables



CAUTION!

Always read the documentation supplied with the device you wish to connect.

Never connect, or disconnect cables during a thunderstorm.

Never pull on a cable when disconnecting it. Always take hold of the cable by the plug.

Follow the sequence described below to connect or disconnect external devices to or from the server:

Ensure that you wait for 10 seconds or more after shutdown before turning the server on.

Connecting cables

- ▶ Switch off the server and equipment switches.
- ▶ Disconnect all power cords from the properly grounded power outlets.
- ▶ Connect all cables to the server and peripherals.
- ▶ Connect all data communication cables into the utility sockets.
- ▶ Connect all power cords into the properly grounded power outlets.

Disconnecting cables

- ▶ Switch off the server and equipment switches.
- ▶ Disconnect all power cords from the properly grounded power outlets.
- ▶ Disconnect all data communication cables from the utility sockets.
- ▶ Disconnect the relevant cables from the server and all the peripherals.



For connecting or disconnecting LAN cables, the server does not need to be powered off. To avoid loss of data teaming function has to be enabled.

Information for ensuring electromagnetic compatibility

All data and signal cables must have sufficient shielding. The use of cable type S/FTP Cat5 or higher is recommended.

Use of unshielded or badly shielded cables may lead to increased emission of interference and/or reduced fault-tolerance of the device.

5.5.2 Connecting devices to the server

The connectors for external devices are on the front and rear of the server, see section ["Connectors on the server" on page 27](#).



For a remote installation using the ServerView Installation Manager a LAN connection is necessary.



Some of the devices that can be connected may require special software, e.g. drivers (see the documentation for the connected device).

Connecting the keyboard, mouse and monitor

- ▶ Connect the keyboard and mouse to the USB connectors of the server.
- ▶ Connect the monitor to one of the two video connectors at the front or rear.



The front video connector is designed for maintenance issues. If you connect a monitor to the video connector at the front, the video connector at the rear is deactivated. A monitor connected to the front must have at least the same resolution as the monitor connected to the rear. A console bypass is not possible via the video connector at the front.



If a separate graphics card is installed in a slot, the graphic controller on the system board is automatically deactivated. The corresponding video connector can not be used. Connect the video cable of the monitor to the video connector of the graphics card.

- ▶ Connect the power cord of the monitor to a power outlet of the rack socket strip.



The rated current for the monitor is indicated on the technical data label on the monitor or in the operating manual for the monitor.

5.5.3 Connecting the power cord

In its basic configuration level the server has one PSU.

A second PSU can be added to ensure a redundant power supply. If one PSU is defective, the other then guarantees unimpaired operation. Each PSU can be replaced during operation (see the "FUJITSU Server PRIMERGY TX2550 M5 Upgrade and Maintenance Manual").

5.5.3.1 Connecting the power cord (AC PSU)



CAUTION!

The AC PSU adjusts automatically to any power voltage in the range from 100 V - 240 V (AC PSU Platinum) or 200 V - 240 V (AC PSU Titanium). You may only operate the server if its rated voltage range corresponds to the local mains voltage.

- ▶ Connect the power cord to the PSU.
- ▶ Connect the main plug to an power outlet of the rack socket strip.
- ▶ Ensure that the status indicator on the PSU is lit green, see section ["Indicator on hot-plug PSU" on page 41](#).



It will take about 60 seconds until the server can be powered on.

5.5.3.2 Using the cable clamp (AC PSU)

You can secure the power cord with a cable clamp to ensure that the power cord cannot be disconnected from the server by mistake. The cable clamp is included in the accessories pack that is delivered together with the server.

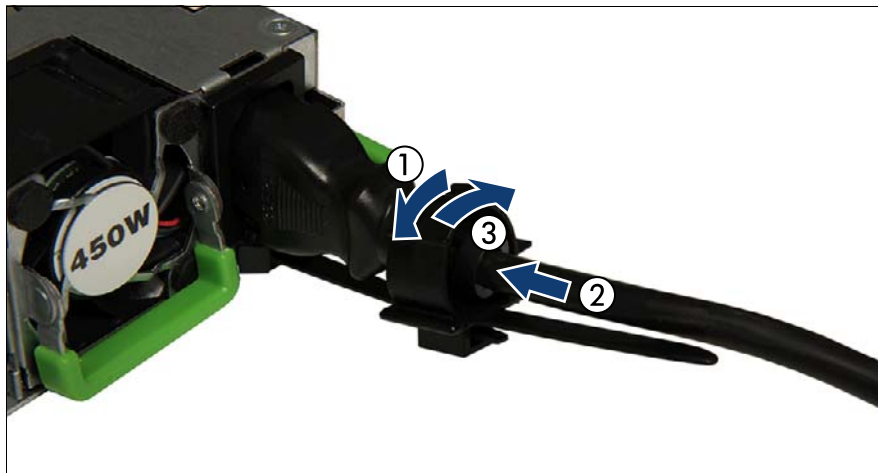

Figure 17: Using cable clamps

- ▶ Pull the cable clamp up (1).
- ▶ Thread the power cord through the cable clamp (2).
- ▶ Press the cable clamp down until it engages to secure the cable (3).

5.6 Switching on the server for the first time



CAUTION!

- If nothing appears on the screen but flickering stripes after switching on the server, switch off the server immediately (see chapter "[Troubleshooting and tips](#)" on page 89).
- The On/Off button does not disconnect the server from the mains. To completely disconnect it from the mains, remove the power cords from the PSUs.
- Do not move, strike, or shake the server when it is switched on. This can damage the HDD/SSD in the server and cause data loss.
- Switch the server on when the temperature is in the specified temperature range. For more information on the operating environment, see "[Ambient conditions](#)" on page 101. When operating the server out of the specified temperature range, the server may operate improperly and data loss may occur. Furthermore, Fujitsu cannot be held responsible for any related damage, malfunction, or loss of data, etc.
- Ensure that you wait for 10 seconds or more after power off before switching on the server again.
- After connecting all power cords, wait at least 10 seconds before pressing the On/Off button.

Switching the server on

The AC connected indicator lights up green (standby mode) when the server is connected to the mains.



It will take about 60 seconds until the server can be switched on.

– Starting up

For Japan, see "はじめにお読みください".

- ▶ Press the On/Off button.
- ▶ Configure your server and install the operating system, see section "[Configuring the server with ServerView Installation Manager](#)" on page 72.

5.7 Configuring the server with ServerView Installation Manager

i Ensure that the power saving functions are disabled in the Power menu of the BIOS setup during operation.

Advantages of the ServerView Installation Manager

- Wizard-assisted configuration of your server hardware and disk arrays.
- Wizard-assisted installation of all leading server operating systems.
- Wizard-assisted creation of configuration files for unattended installation of several PRIMERGY servers with identical hardware configurations.
- Installation of drivers and additional software.

i The software that can be installed depends on the hardware configuration of your server. This configuration is detected automatically.

5.7.1 Configuring the server and installing the operating system

i When using the ServerView Installation Manager you can configure the onboard controller either before or during installation.

i Descriptions of operating systems not covered in the RAID controller manual are provided in the corresponding readme files under:

<http://www.fujitsu.com/global/services/computing/server/ia/driver/index.html>

For Japan:

<http://www.fujitsu.com/jp/products/computing/servers/primergy/downloads/>

5.7.1.1 Configuring the controllers

- ▶ Configure the RAID controllers using the ServerView RAID Manager.
- ▶ If applicable, configure the onboard SATA controller, see "[Notes on configuring controllers](#)" on page 75.
- ▶ If applicable, configure the SAS/SATA RAID controller with MegaRAID functionality, see "[Notes on configuring controllers](#)" on page 75.

5.7.1.2 Installing the operating system



For more information on installing the server, see the "ServerView Installation Manager" user guide at <http://manuals.ts.fujitsu.com> under x86 Servers - Software - ServerView Suite - Server Installation and Deployment.

- ▶ Open this manual.
- ▶ For the remote or local installation, follow the instruction in this manual and on the screen.
- ▶ Configure the settings for the general system behavior of the server using the Server Configuration Manager.

5.8 Configuring the server without ServerView Installation Manager

5.8.1 Configuring the server and installing the operating system



5.8.1.1 Configuring the onboard SAS/SATA controller

- ▶ If applicable, configure the onboard SATA controller, see ["Notes on configuring controllers" on page 75](#).
- ▶ If applicable, configure the SAS/SATA RAID controller with MegaRAID functionality, see ["Notes on configuring controllers" on page 75](#).



5.8.1.2 Installing the operating system

- ▶ Insert the DVD for the operating system you want to install.
- ▶ Reboot the server.
- ▶ Follow the instructions on screen and in the manual for the operating system.

5.9 Notes on configuring controllers

-  Ensure that the power saving functions are disabled in the **Power** menu of the BIOS setup during operation.
-  Descriptions of operating systems not covered in the controller manual are provided in the corresponding readme under:
<http://www.fujitsu.com/global/services/computing/server/ia/driver/index.html>
For Japan:
<http://www.fmworld.net/cgi-bin/drviasearch/drviaindex.cgi>
<http://www.fujitsu.com/jp/products/computing/servers/primergy/downloads/>

5.9.1 Notes on onboard SATA controllers

-  The controller has its own configuration utility. For more information, see the "Embedded MegaRAID Software User's Guide" (on the Fujitsu manuals server under **x86 Servers - Expansion Cards - Storage Adapters - LSI Configuration Software**).
-  In the BIOS the onboard SATA controller can be configured as RAID (default) or non-RAID.

5.9.2 Notes on SAS/SATA RAID controllers

-  A separate utility is available to the controller for MegaRAID configuration. For more information, see the "SAS Software User's Guide" (on the Fujitsu manuals server under **x86 Servers - Expansion Cards - Storage Adapters - LSI Configuration Software**).
- More information on modular RAID controllers is provided in the "Modular RAID Controller Installation Guide" (on the Fujitsu manuals server under **x86 Servers - Expansion Cards - Storage Adapters - LSI SAS / SCSI RAID Controllers**).

5.10 Note on operating system

Open the Windows operating system / Restoring the preinstalled environment

For the procedure to open the Windows operation system or to restore the preinstalled environment, see the manuals on the Fujitsu manual download site (<http://www.fujitsu.com/jp/products/computing/servers/primergy/manual/>) or the attached manuals.

Linux operating system support

About the Fujitsu Support Pack for Linux (FJ-LSP)

The FJ-LSP can only be used from customers who have an contracted support as a tool to create an Fujitsu recommended Linux support environment.

The FJ-LSP can be downloaded from the Fujitsu SupportDesk subscriber site (SupportDesk web: <http://eservice.fujitsu.com/supportdesk/>).

The FJ-LSP have to be used with the application wizard of the ServerView Installation Manager.

6 Operation



CAUTION!

Follow the safety instructions in chapter "[Important information](#)" on [page 43](#).

6.1 Switching the server on and off



CAUTION!

- If nothing appears on the screen but flickering stripes after switching on the server, switch off the server immediately (see chapter "[Troubleshooting and tips](#)" on [page 89](#)).
- The On/Off button does not disconnect the server from the mains. To completely disconnect it from the mains, remove the power cords from the PSUs.
- Do not move, strike, or shake the server when it is switched on. This can damage the HDD/SSD in the server and cause data loss.
- Switch the server on when the temperature is in the specified temperature range. For more information on the operating environment, see "[Ambient conditions](#)" on [page 101](#). When operating the server out of the specified temperature range, the server may operate improperly and data loss may occur. Furthermore, Fujitsu cannot be held responsible for any related damage, malfunction, or loss of data, etc.
- Ensure that you wait for 10 seconds or more after power off before switching on the server again.
- After connecting all power cords, wait at least 10 seconds before pressing the On/Off button.

Switching the server on

The AC connected indicator lights up green (standby mode) when the server is connected to the mains.



It will take about 60 seconds until the server can be switched on.

- ▶ Press the On/Off button.
The server is switched on, performs a system test and boots the operating system.



In the case of configurations with a large memory size, the boot process may be prolonged and the screen may remain dark for several minutes.

Switching the server off

The power-on indicator lights up green.

- ▶ Shut down the operating system properly.

The server is switched off automatically and enters standby mode. The AC connected indicator lights up green.



If the operating system does not turn off the server automatically, press the On/Off button for at least four seconds and/or send a corresponding control signal for power button override.



CAUTION!

There is a risk that data may be lost.

Other On/Off options

Besides the On/Off button, the server can be switched on and off in the following ways:

– **Timer-controlled turn-on/off**

Using the ServerView Operations Manager or iRMC, you can configure that the server is turned on/off controlled by an internal timer.

– **Ring indicator**

The server is turned on by an internal or external modem.

- **Wake up On LAN (WOL)**

The server is turned on by a command via the LAN (Magic Packet™).

- **After power failure**

The server automatically reboots following a power failure (depending on the settings in the BIOS or in iRMC).

- **Power button override**

The system can be switched off (hard power off) by keeping the On/Off button (approximately 4 - 5 seconds).



CAUTION!

There is a risk that data may be lost.

- **iRMC**

iRMC offers various options for switching the server on and off, e.g. via the **System power button** on the Global icons of the iRMC web interface.



CAUTION when switching off the power!

The operation of the power switch can be specified as "Do Nothing", "Stand by", "Hibernate", and "Shutdown" depending on the OS settings. The default is "Shutdown".

On this server, functions corresponding to "Stand by" and "Hibernate" are supported as BIOS and hardware functions. However, some drivers and software installed in the server do not support these functions. For this reason, functions corresponding to "Stand by" and "Hibernate" are unavailable on this server. When the operating mode is set to "Stand by" or "Hibernate", the system may operate improperly or HDD/SSD data may be corrupted.

For more information about operating mode settings, see the manual supplied with the OS.

6.2 Access to the drives (floorstand model)

6.2.1 Removing the drive covers



Figure 18: Removing the accessible drive bay cover

- ▶ Turn the key clockwise (1) to unlock the accessible drive cover and remove the key.

i Depending on the setting of the green hook in the accessible drive bay cover, you can open the drive cover without turning the key or only with turning the key.

- ▶ Open the accessible drive bay cover carefully in the direction of the arrow (2) until the cover is released and remove it.



CAUTION!

Do not pull too hard to avoid damage to the locking mechanism.

- ▶ Place the accessible drive bay cover on the HDD bay cover (3).
- ▶ Push the accessible drive bay cover in the direction of the arrow (4).



When operating with tape drives:

If the system is programmed to eject the media automatically, the accessible drives must not be obstructed.

The drive cover is replaced and the server locked in the reverse order.

6.2.2 Removing the HDD bay cover



Figure 19: Removing the HDD bay cover

- ▶ Turn the key counterclockwise (1) to unlock the drive cover and remove the key.
- ▶ Open the HDD bay cover in the direction of the arrow and remove it (2).

The HDD bay cover is replaced and the server locked in the reverse order.

6.3 Installing HDD/SSD modules

6.3.1 Installing 3.5-inch HDD modules

6.3.1.1 Removing a 3.5-inch HDD dummy module

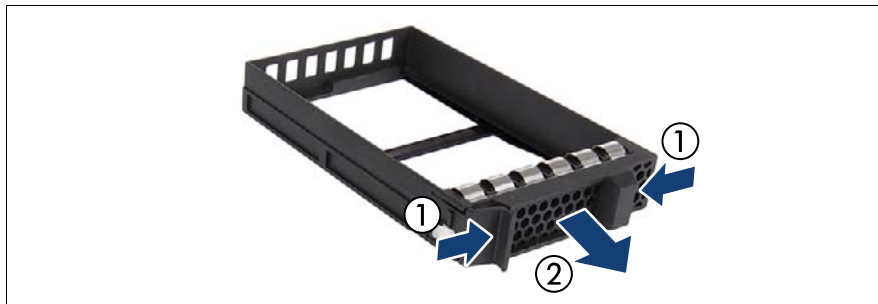

Figure 20: Removing a 3.5-inch dummy module

- ▶ Press both tabs together (1) and pull the dummy module out of its bay (2).



CAUTION!

Keep the dummy module for future use.

Always replace dummy modules into unused HDD bays to comply with applicable EMC regulations and satisfy cooling requirements.

6.3.1.2 Installing a 3.5-inch HDD module



Figure 21: Opening the 3.5-inch HDD module locking lever

- ▶ Pinch the green locking clip (1) and open the locking lever (2).



Figure 22: Installing the 3.5-inch HDD module

- ▶ Install the HDD module into a drive bay and carefully push back as far as it will go (1).
- ▶ Close the locking lever to lock the HDD module in place (2).
- ▶ When using a RAID array, add the additional HDD/SSD to the RAID array.

i Configuring the RAID array, see the documentation of the RAID controller, used in your configuration, see section "[Documentation overview](#)" on page 13.

6.3.2 Installing 2.5-inch HDD/SSD modules

6.3.2.1 Removing a 2.5-inch HDD/SSD dummy module

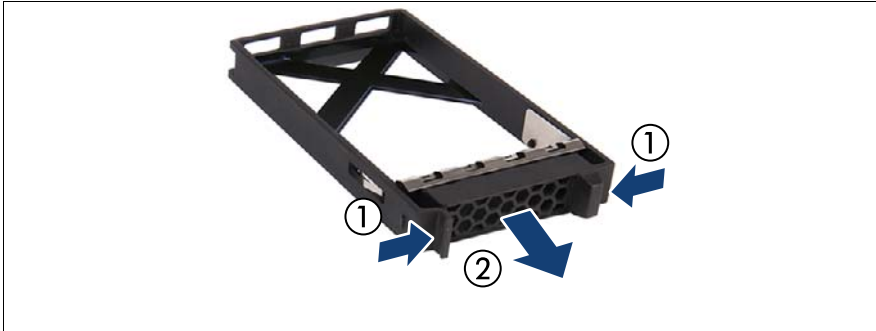

Figure 23: Removing a 2.5-inch HDD/SSD dummy module

- ▶ Press both tabs together (1) and pull the dummy module out of its bay (2).



CAUTION!

Keep the dummy module for future use.

Always replace dummy modules into unused HDD/SSD bays to comply with applicable EMC regulations and satisfy cooling requirements.

6.3.2.2 Installing a 2.5-inch HDD/SSD module



Figure 24: Opening the 2.5-inch HDD/SSD module locking lever

- ▶ Pinch the green locking clip (1) and open the locking lever (2).



Figure 25: Installing the 2.5-inch HDD/SSD module

- ▶ Insert the HDD/SSD module into a drive bay and carefully push back as far as it will go (1).
- ▶ Close the locking lever to lock the HDD/SSD module in place (2).
- ▶ When using a RAID array, add the additional HDD/SSD to the RAID array.



Configuring the RAID array, see the documentation of the RAID controller, used in your configuration, see section "[Documentation overview](#)" on page 13.

6.4 Installing a second PSU

6.4.1 Removing the dummy cover

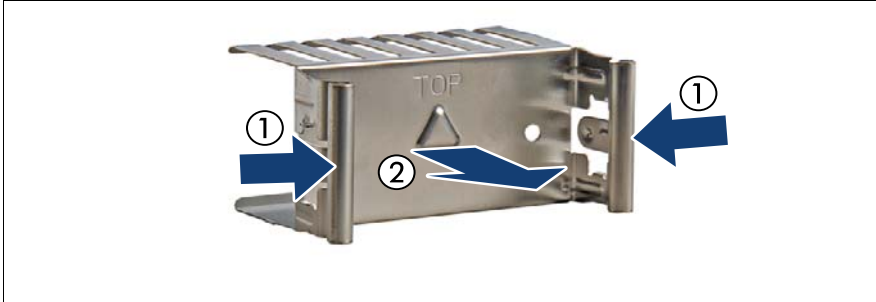

Figure 26: Removing the PSU dummy cover

- ▶ Press in on both release latches (1) and remove the dummy cover (2).



CAUTION!

Keep the dummy cover for future use. If a PSU is removed and not immediately replaced by a new one, a dummy cover must be installed in the bay again to comply with applicable EMC regulations and satisfy cooling requirements.

6.4.2 Installing a PSU

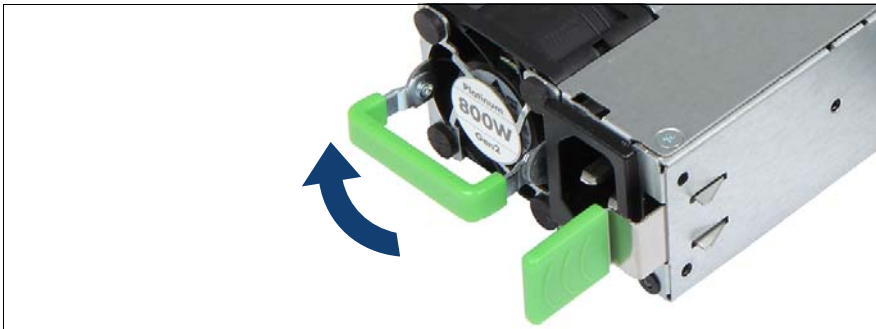

Figure 27: Folding up the handle

- ▶ Push the handle of the PSU halfway upward in the direction of the arrow.

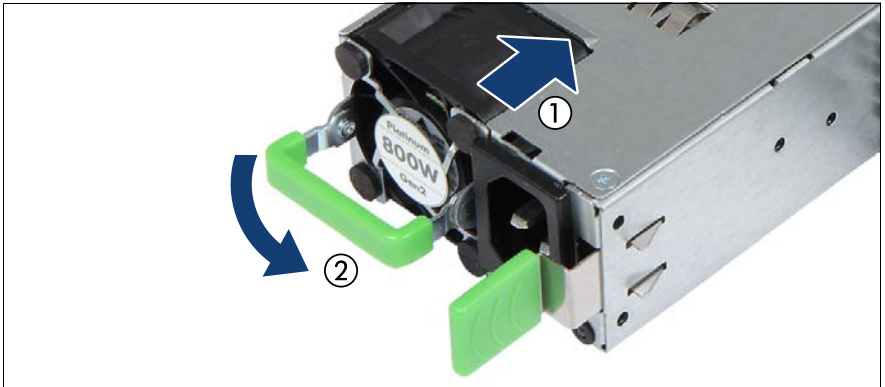

Figure 28: Installing a PSU

- ▶ Push the PSU into its bay (1) as far as it will go until the release latch snaps in place.
- ▶ Fold down the handle on the PSU (2).

i Ensure that the PSU engages correctly in the bay and is locked in position. This is the only way to prevent the PSU from sliding out of its bay and being damaged during transportation.

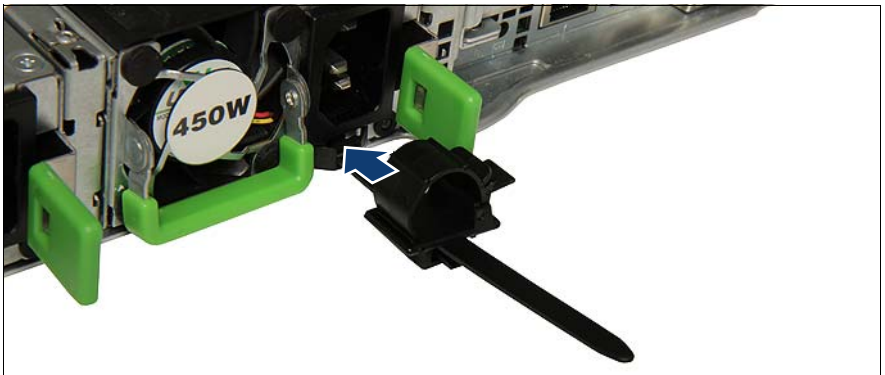

Figure 29: Installing the cable tie

- ▶ Push the cable clamp into the corresponding hole until it clicks in.
- ▶ Connect the power cord to the PSU, see section ["Connecting the power cord" on page 69](#).
- ▶ If applicable, configure the redundant power supply.

6.5 Cleaning the server



CAUTION!

Switch off the server and disconnect the power plugs from the properly grounded power outlets.

Do not clean any interior parts yourself; leave this job to a service technician.

Do not use any cleaning agents that contain abrasives or may corrode plastic.

Ensure that no liquid enters the system. Ensure that the ventilation areas of the server and the monitor are clear.

Do not use any cleaning sprays (including flammable types). It may cause a device failure or a fire.

Clean the keyboard and the mouse with a disinfecting cloth.

Wipe the server and monitor casing with a dry cloth. If particularly dirty, use a cloth that has been moistened in a mild domestic detergent and then carefully wrung out.

7 Troubleshooting and tips



CAUTION!

Follow the safety instructions in the "Safety Notes and Regulations" manual or "安全上のご注意" and in chapter "[Important information](#)" on [page 43](#).

If a fault occurs, attempt to resolve it using the measures described:

- in this chapter,
- in the documentation for the connected devices,
- in the help systems of the software used.

If you fail to correct the problem, proceed as follows:

- ▶ Make a list of the steps performed and the circumstances that led to the fault. Also make a list of any error messages that were displayed.
- ▶ Switch off the server.
- ▶ Contact our customer service team.



The meaning of the error message is explained in the documentation for the relevant components and programs, available online at <http://manuals.ts.fujitsu.com>.

Power-on indicator remains unlit after you have switched on your device

Cause	Troubleshooting
Power cable incorrectly connected	<ul style="list-style-type: none">▶ Ensure that the power cable(s) is/are correctly connected to the server and the grounded power outlet(s).
Power supply overloaded	<ul style="list-style-type: none">▶ Disconnect the server power plug(s) from the grounded power outlet(s).▶ Wait a few minutes before you plug it/them into the grounded power outlet(s) again.▶ Switch on your server.

Troubleshooting and tips

The system will not boot after installing a new HDD

Cause	Troubleshooting
SAS configuration incorrect	<ul style="list-style-type: none">▶ Check the settings for the HDDs (SAS Device Configuration) and the additional settings in the SAS configuration menu.

Screen remains blank

Cause	Troubleshooting
Monitor is switched off	<ul style="list-style-type: none">▶ Switch on your monitor.
Screen has gone blank	<ul style="list-style-type: none">▶ Press any key on the keyboard. or▶ Deactivate screen saver and enter the appropriate password.
Brightness control is set to dark	<ul style="list-style-type: none">▶ Set the brightness control on the monitor to light. For more information, see the operating manual supplied with your monitor.

No screen display or display drifts

Cause	Troubleshooting
Wrong horizontal frequency or resolution selected	<ul style="list-style-type: none">▶ Find out which horizontal frequency your monitor screen supports. You will find the horizontal frequency (also known as line frequency or horizontal deflection frequency) in the documentation for your monitor.▶ See the documentation for your operating system or the software for the screen controller for more information of how to set the correct horizontal frequency for your monitor, and follow the procedure accordingly.

Server switches itself off

Cause	Troubleshooting
Server Management has detected an error	<ul style="list-style-type: none"> ▶ Check the error list of System Event Log in ServerView Operations Manager or in the iRMC web interface, and attempt to eliminate the error.

No mouse pointer displayed on screen

Cause	Troubleshooting
Mouse driver not loaded	<ul style="list-style-type: none"> ▶ Check whether the mouse driver is properly installed and is activated when the application program is started. Detailed information can be found in the user manuals for the mouse, the operating system and the application program.

No effect of keyboard or mouse

Cause	Troubleshooting
Typing the keyboard does not display any characters, or the mouse cursor does not move	<ul style="list-style-type: none"> ▶ Check to see whether the keyboard and mouse are connected properly. If they are not connected or you replaced them yourself, then connect the cables to the server.

Time and/or date is incorrect

Cause	Troubleshooting
Time and date is incorrect	<ul style="list-style-type: none">▶ Set the correct time and date in the operating system.<p>or</p>▶ Set the correct time and date in the BIOS Main menu, using System Date and System Time respectively. <p> Note that the operating system may affect the system time. For example, the operating system time may deviate from the system time under Linux, and would overwrite the system time in the default setting on shutdown.</p>
The lithium battery is discharged	<ul style="list-style-type: none">▶ If the date and time are still wrong after the server has been switched off and back on again, replace the lithium battery (see the "FUJITSU Server PRIMERGY TX2550 M5 Upgrade and Maintenance Manual") or contact our customer service team.

Temperature warning

A temperature warning is output to the hardware event log and OS event log, or ServerView issues a notification of a temperature warning such as by a popup message.

This warning is issued by ServerView when the ambient temperature exceeds the upper limit of the temperature boundaries. The upper limit is 35°C for standard server and 40°C or 45°C with Advanced Thermal Design.

Cause	Troubleshooting
The ambient temperature exceeds the upper limit of the temperature boundaries	<ul style="list-style-type: none"> ▶ Although continued use within the temperature boundaries poses no problems within itself, reconsider the surrounding environment conditions if this log is output or if ServerView issues this notification.

Added drive reported as defective

Cause	Troubleshooting
RAID controller is not configured for this drive	<p>The drive was probably installed when the system was switched off.</p> <ul style="list-style-type: none"> ▶ Reconfigure the RAID controller for the drive using the corresponding utility. Information is provided in the documentation for the RAID controller. <p style="text-align: center;">or</p> <ul style="list-style-type: none"> ▶ Remove and reinstall the drive while the system is switched on. <p>If the HDD/SSD continues to be shown as defective, then replace it (see the "FUJITSU Server PRIMERGY TX2550 M5 Server Upgrade and Maintenance Manual").</p>

Troubleshooting and tips

Expansion cards or onboard devices not recognized

When an expansion card is added, other expansion cards or onboard devices might not be recognized.

Cause	Troubleshooting
Expansion cards or onboard devices not recognized	<ul style="list-style-type: none">▶ Reinstall the drivers for the expansion cards or onboard devices that are not recognized.

Expansion cards or onboard devices not recognized

Various HDD/SSD error messages may occur when the system is rebooted. These error messages are caused by modifications in the selected RAID configuration.

Cause	Troubleshooting
RAID controller configuration incorrect	<ul style="list-style-type: none">▶ Check and correct the settings for the drives using the RAID controller configuration program. <p> For more information, see the "Integrated RAID for SAS User's Guide" available online at http://manuals.ts.fujitsu.com under x86 Servers - Expansion Cards - Storage Adapters - LSI SAS / SCSI RAID Contollers or in the "Modular RAID Controller Installation Guide" available online at http://manuals.ts.fujitsu.com under x86 Servers - Expansion Cards - Storage Adapters - LSI SAS / SCSI RAID Contollers.</p>

ODD cannot read data

Cause	Troubleshooting
ODD cannot read data	<ul style="list-style-type: none"> <li data-bbox="437 277 1028 400">▶ Check to see whether the CD/DVD/BD is inserted properly. If the CD/DVD/BD is not inserted, correctly insert the disk so that the label is facing up. <li data-bbox="437 416 1028 507">▶ Check to see whether the CD/DVD/BD is not dirty. If the CD/DVD/BD is dirty, wipe it in a radial way with a soft, dry cloth. <li data-bbox="437 523 1028 614">▶ Check to see whether the CD/DVD/BD is not scratched or bent. If scratched or damaged, replace the CD/DVD/BD.

8 Technical data

This section explains the specifications for the server. The specifications for this server are liable to be updated without any notice. Please be forewarned.



The data sheets for this server contain more technical data. The data sheets are available online at:

<http://www.fujitsu.com/fts/products/computing/servers/primergy>

For more information, see the **Documents** tab under e.g. **Rack Servers**.

For Japan:

<http://www.fujitsu.com/jp/products/computing/servers/primergy>

System board

System board type	D3386
Chipset	Intel® C624 series
Processor (CPU)	
CPU quantity and type	1 or 2 Intel® Xeon® CPUs (Platinum, Gold, Silver, Bronze)

Memory modules configuration

Memory slots	12 (6 DIMMs per CPU, 1 DIMM per channel)
Memory types	RDIMM/LRDIMM (DDR4) NVM/LRDIMM
Memory capacity (min. - max.)	8 GB - 1536 GB
Memory protection	Memory Scrubbing; SDDC (only for registered DIMMs); Hot-spare memory support; Memory Mirroring support
Memory notes	RDIMM/LRDIMM: 2933 MHz memory modules with 8, 16, 32, or 64 GB NVM/LRDIMM: 2666 MHz memory modules with 128, 256, or 512 GB

Technical data

Interfaces

USB	Rear: 4x USB 3.0 Front: 2 x USB 3.0 Internal: 1x USB 2.0 (Backup), 1x USB 3.0 (Type A)
Graphics (15-pin)	1 x VGA
Serial 1 (9-pin)	1 x serial RS-232-C, usable for iRMC S5 or system or shared (optional)
LAN / Ethernet	OCP option: <ul style="list-style-type: none">– 2 x 10 GBit/s (RJ45)– 2 x 10 GBit/s (SFP+)
Management LAN (RJ45)	1 x dedicated management LAN port for iRMC (10/100/1000 Mbit/s). Management LAN traffic can be switched to shared onboard converged network adapter.

Onboard or integrated controllers

<p>RAID controller</p>	<p>PSAS CP400i with "Integrated RAID" (IR) RAID levels 0 and 1 are supported for internal HDD configurations.</p> <p>PRAID EP4x0 (based on LSI SAS3108) SAS/SATA HDD/SSD up to 12 Gbit/s SAS, 6 Gbit/s SATA, 8 ports internal/external RAID level: 0, 1, 1E, 10, 5, 50, 6, 60 1/2/4 GB cache, optional FBU</p> <p>PRAID EP520i (based on LSI SAS3508) SAS/SATA/PCIe HDD/SSD up to 12 Gbit/s SAS, 6 Gbit/s SATA, 8 Gbit/s PCIE, 8 ports internal RAID level: 0, 1, 1E, 10, 5, 50, 6, 60 2 GB cache, optional FBU</p> <p>PRAID EP5x0 (based on LSI SAS3516) SAS/SATA/PCIe HDD/SSD up to 12 Gbit/s SAS, 6 Gbit/s SATA, 8 Gbit/s PCIE, 16 ports internal / 8 ports external RAID level: 0, 1, 1E, 10, 5, 50, 6, 60 4/8 GB cache, optional FBU</p>
<p>SATA controller</p>	<p>1x SATA controller integrated on the system board; up to eight SATA HDDs/SSDs can be connected to the controller. The LSI Embedded MegaRAID software (Software RAID) supports RAID levels 0, 1, 10.</p> <p>1x single SATA3 connector for ODD</p> <p>2x M.2 connector with support for SATA and PCIe</p>
<p>LAN controller</p>	<p>OCP 10Gbit/s with 4/2 ports and BASE-T 10/1 Gbit/s with 2 ports</p> <p>PXE-Boot via LAN from PXE server, iSCSI boot (also diskless).</p>
<p>Remote Management Controller</p>	<p>Integrated Remote Management Controller with integrated video engine (iRMC S5); 512MB DDR3 DRAM; IPMI 2.0 compatible</p>
<p>Trusted Platform Module (TPM)</p>	<p>Infineon / separate module; TCG V2.0 compliant, SPI support (option)</p>

Technical data

Slots

Standard	
PCI-Express - Gen3 x16	3 x full height
PCI-Express - Gen3 x8	3 x full height
Expansion with riser module	
PCI-Express - Gen3 x8	5 x full height
PCI-Express - Gen3 x16	2 x full height
PCI 32-Bit/33MHz (5V)	1 x full height 270 mm max. length
Slot notes	Integrated RAID Controller occupies 1 x PCI Express (not available when expander is mounted)

Drive bays

Hard disk bay configuration	Up to 32x hot plug 2.5-inch, or up to 12x hot plug 3.5-inch Up to 8x PCIe SSD
Accessible drive bays	Up to 3x 1.6-inch drive bays for ODD or backup

Dimension/Weight

Floorstand (W x D x H)	177 mm x 777 mm x 456 mm
Rack (W x D x H)	482.6 mm (bezel) / 448 mm (body) x 736 mm x 177 mm
Height unit rack	4 U
Mounting depth rack	745 mm
19" rack mount	Yes
Weight	35 kg
Weight notes	Weight may vary depending on actual configuration
Rack mounting kit	Rack mounting kit as option

Ventilation clearance

There must be a clearance of at least 200 mm in front of and behind the server to ensure adequate ventilation of the subsystem.

Ambient conditions

All temperature ratings shown are valid for sea level. An altitude derating of 1°C per 300m to 3048 m is applicable.

Environment class 3K2	EN 60721 / IEC 721 Part 3-3
Environment class 2K2	EN 60721 / IEC 721 Part 3-2
Temperature:	
Operation (3K2)	5 °C ... 40 °C (with Fujitsu ATD 40°) 5 °C ... 45 °C (with Fujitsu ATD 45°) 10 °C... 35 °C (without Fujitsu ATD)
Transport (2K2)	-25 °C ... 60 °C
Humidity	10% ... 85% (non condensing)
Condensation during operation must be avoided!	

Noise level

The acoustic noise values are depending on the system configuration.

Standard configuration	
Sound power level L_{WAd} (ISO 9296)	4.2 B (standby) 4.8 B (operation)
Sound pressure level at adjacent workstation L_{pAm} (ISO 9296)	24 db(A) (standby) 30 db(A) (operation)

Electrical data: 450 W Platinum

Rated voltage range	100 V - 240 V
Frequency	50 Hz - 60 Hz
Max. rated current	5.0 A - 2.0 A

Technical data

Electrical data: 800 W Platinum

Rated voltage range	100 V - 240 V
Frequency	50 Hz - 60 Hz
Max. rated current	9.0 A - 3.5 A

Electrical data: 800 W Titanium

Rated voltage range	200 V - 240 V
Frequency	50 Hz - 60 Hz
Max. rated current	4.5 A

Electrical data: 1200 W Platinum

Rated voltage range	100 V - 120 V / 200 V - 240 V
Frequency	50 Hz - 60 Hz
Max. rated current	10.5 A - 5.0 A

Compliance with standards

Product safety and ergonomics	
International	IEC 60950-1 2nd Edition am 1 + am 2 IEC 62368-1:2014 (Second Edition)
Europe	
Safety	EN 60950-1 2nd Edition EN 62368-1:2014 EN 62479
Ergonomics	ISO 9241-3xx EN 9241-3xx EK1-ITB 2000:2018
USA / Canada	CSA-C22.2 No. 60950-1-07 2nd Edition am 1+ am 2 CAN/CSA-C22.2 No. 62368-1:2014 UL 60950-1 2ed. am1 + am2 UL 62368-1:2014
Australia / New Zealand	AS/NZS 62368.1 AS/NZS 60950.1
Taiwan	CNS 14336-1
China	GB 4943.1
India	IS 13252-1
Electromagnetic compatibility	
International	CISPR 32 CISPR 24
Europe	EN 55032 Class A EN 55024 EN 61000-3-2 EN 61000-3-3 EN 300386 (on demand)
USA / Canada	FCC 47CFR part 15 Class A / ICES-003
Australia / New Zealand	AS/NZS CISPR32 Class A
Taiwan	CNS 13438 Class A
China	GB 9245 / GB 17625
Japan	VCCI Class A / JEITA

Technical data

Korea	KN 32 / KN 35
CE marking to EU directives	
Europe	Low Voltage Directive 2014/35/EU Electromagnetic Compatibility 2004/30/EU
RoHS Compliance	
Europe	EN 50581
Taiwan	CNS 15663



CAUTION!

This device meets the requirements of Class A CISPR 22/32. This device can cause radio interference in residential areas.

9 Warranty and service

Warranty

The warranty regulations can be found online at:<http://manuals.ts.fujitsu.com>
under **x86 Servers - Safety / Eco / Warranty**

For Japan:

<http://www.fujitsu.com/jp/products/computing/servers/primergy/support/>

For the warranty regulations select "製品保証ご案内 (無償修理期間)"

Service

Telephone numbers of the local service partner can be found online at:

<http://ts.fujitsu.com/support/servicedesk.html>

