

# Fuller Heavy Duty Transmissions TRSM0880

October 2007



*Powering Business Worldwide*

BACKED BY

**Roadranger**

SUPPORT



# **TABLE OF CONTENTS**

---

**FOREWORD**

**MODEL DESIGNATION AND SPECIFICATIONS**

**LUBRICATION**

**OPERATION**

**POWER FLOW**

**TIMING**

**TORQUE RECOMMENDATIONS**

**TOOL REFERENCE**

**PREVENTIVE MAINTENANCE**

**PRECAUTIONS**

DISASSEMBLY

INSPECTION

REASSEMBLY

**CHANGING INPUT SHAFT**

**AIR SYSTEM**

RANGE SHIFT AIR SYSTEM

SPLITTER SHIFT AIR SYSTEM

**AIR SYSTEM SCHEMATICS**

**DISASSEMBLY SHIFTING CONTROLS**

**DISASSEMBLY GEAR SHIFT LEVER ASSEMBLY**

**REASSEMBLY GEAR SHIFT LEVER ASSEMBLY**

**DISASSEMBLY AND REASSEMBLY SHIFT BAR HOUSING**

**REMOVAL - OUTPUT YOKE, AUXILIARY SECTION, AND  
CLUTCH HOUSING**

**DISASSEMBLY - AUXILIARY SECTION**

**REASSEMBLY - AUXILIARY SECTION**

**DISASSEMBLY - FRONT SECTION**

**REASSEMBLY - FRONT SECTION**

**INSTALLATION - CLUTCH HOUSING, AUXILIARY SECTION  
AND OUTPUT YOKE**

**INSTALLATION - SHIFTING CONTROLS**

# FOREWORD

---

This manual is designed to provide detailed information necessary to service and repair the Fuller' Transmissions listed on the cover.

As outlined in the Table of Contents, the manual is divided into 3 main sections:

- a. Technical information and reference
- b. Removal, disassembly, reassembly and installation
- c. Options

The format of the manual is designed to be followed in its entirety if complete disassembly and reassembly of the transmission is necessary. But if only one component of the transmission needs to be repaired, refer to the Table of Contents for the page numbers showing that component. For example, if you need to work on the Shifting Controls, you will find instructions for removal, disassembly and reassembly on page 32. Instructions for installation are on

page 116. Service Manuals, Illustrated Parts Lists, Drivers Instructions, and other forms of product service information for these and other Fuller Transmissions are available upon request. A Technical Literature Order Form maybe found in the back of this manual. You may also obtain Service Bulletins, detailing information on product improvements, repair procedures and other service-related subjects by writing to the following address:

EATON CORPORATION  
TRANSMISSION DIVISION  
Technical Service Department  
P.O. Box 4013  
Kalamazoo, Michigan 49003  
(61 6) 342-3344

Every effort has been made to ensure the accuracy of all information in this brochure. **However, Eaton Transmission Division makes no expressed or implied warranty or representation based on the enclosed information.** Any errors or omissions may be reported to Training and Publications, Eaton Transmission Division, PO. Box 4013, Kalamazoo, MI 49003.

# MODEL DESIGNATIONS AND SPECIFICATIONS

## Nomenclature:

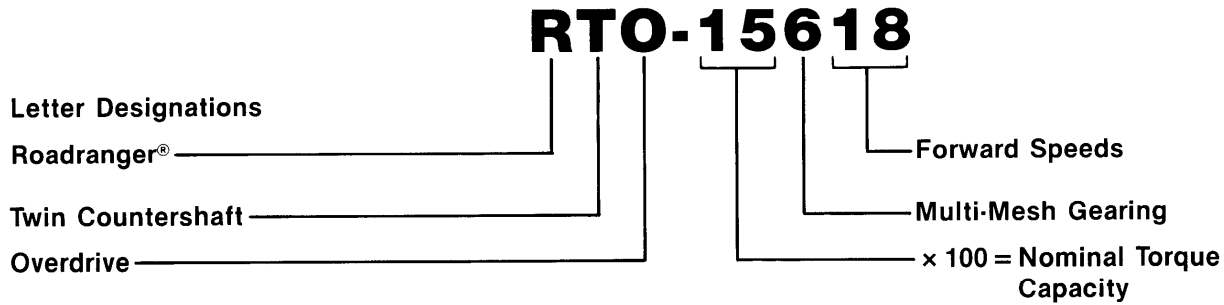

**IMPORTANT:** All Eaton Fuller Transmissions are identified by model and serial number. This information is stamped on the transmission identification tag and affixed to the case. **DO NOT REMOVE OR DESTROY THE TRANSMISSION IDENTIFICATION TAG.**

## 18-Speed Transmissions (On/Off-Highway):

Models	No. Spds.	Gear Ratios:											Relative Speed PTO Gear To Input R.P.M.		1 Length In. (mm)	2 Weight Lbs. (kg)	3 Oil Cap. Pints (Liters)
		LO	1st	2nd	3rd	4th	5th	6th	7th	8th	Reverse	Right	Bottom				
RTO-15618	18	DIR	14.71	10.20	7.34	5.26	3.78	2.70	1.94	1.39	1.00	3.89/14.71	.696	.696	32.4 (823.5)	748 (339.3)	28 (13.25)
		OD	12.45	8.62	6.21	4.45	3.20	2.28	1.64	1.18	.85	3.29/12.45					

### CHART NOTES:

- 1** Lengths measured from face of clutch housing to front bottoming surface of companion flange or yoke.
- 2 Weight** — Listed weights are *with* clutch housing\* and include standard controls, which consist of gear shift lever housing and gear shift lever. Weight of standard controls is approximately 10 lbs. (4.5 kg.). All weights are approximate.
- 3** Oil Capacities are approximate, depending on inclination of engine and transmission. Always fill transmission with proper grade and type of lubricant to level of filler opening. See LUBRICATION.

\*For information on available clutch housings refer to Publication FUL-140 - "Clutch Housing Chart".

# LUBRICATION

## Proper Lubrication . . . the Key to long transmission life

Proper lubrication procedures are the key to a good all-around maintenance program. If the oil is not doing its job, or if the oil level is ignored, all the maintenance procedures in the world are not going to keep the transmission running or assure long transmission life.

Eaton® Fuller® Transmissions are designed so that the internal parts operate in a bath of oil circulated by the motion of gears and shafts.

Thus, all parts will be amply lubricated if these procedures are closely followed:

1. **Maintain oil level. Inspect regularly.**
2. **Change oil regularly.**
3. **Use the correct grade and type of oil.**
4. **Buy from a reputable dealer.**

### Lubrication Change and Inspection

Eaton® Roadranger® CD50 Transmission Fluid	
<b>HIGHWAY USE—Heavy Duty and Mid-Range</b>	
First 3,000 to 5,000 miles (4827 to 8045 Km)	Factory fill Initial drain
Every 10,000 miles (16090 Km)	Check fluid level Check for leaks
<b>Heavy Duty Highway Change Interval</b>	
Every 250,000 miles (402336 Km)	Change transmission fluid,
<b>Mid-Range Highway Change Interval</b>	
Every 100,000 miles (160,000 Km) or every 3 years whichever occurs first	Change transmission fluid.
<b>OFF-HIGHWAY USE</b>	
First 30 hours	Factory fill Initial drain,
Every 40 hours	Inspect fluid level Check for leaks
Every 500 hours	Change transmission fluid where severe dirt conditions exist.
Every 1,000 hours	Change transmission fluid (Normal off-highway use),
<b>Heavy Duty Engine Lubricant or Mineral Gear Lubricant</b>	
<b>HIGHWAY USE</b>	
First 3,000 to 5,000 miles (4827 to 8045 Km)	Factory fill Initial drain.
Every 10,000 miles (16090 Km)	Inspect lubricant level, Check for leaks,
Every 50,000 miles (80450 Km)	Change transmission lubricant,
<b>OFF-HIGHWAY USE</b>	
First 30 hours	Change transmission lubricant on new units
Every 40 hours	Inspect lubricant level Check for leaks
Every 500 hours	Change transmission lubricant where severe dirt conditions exist.
Every 1,000 hours	Change transmission lubricant (Normal off-highway use),

**Change the oil filter when fluid or lubricant is changed.**

Recommended Lubricants		
Type	Grade (SAE)	Fahrenheit (Celsius) Ambient Temperature
Eaton® Roadranger® CD50 Transmission Fluid	50	All
Heavy Duty Engine Oil	50	Above 10°F(-12°C.)
MI L-L-2104B C or D or API-SF or API-CD	40	Above 10°F(-12°C.)
(Previous API designations acceptable)	30	Below 10°F(-12°C.)
Mineral Gear Oil with rust and oxidation Inhibitor	90 80W	Above 10°F(-12°C.) Below 10°F(-12°C.)
API-GL-1		

The use of mild EP gear oil or multi-purpose gear oil is not recommended, but if these gear oils are used, be sure to adhere to the following limitations:

Do not use mild EP gear oil or multi-purpose gear oil when operating temperatures are above 230°F (110°C). Many of these gear oils, particularly 85W140, break down above 230°F and coat seals, bearings and gears with deposits that may cause premature failures. If these deposits are observed (especially a coating on seal areas causing oil leakage), change to Eaton Roadranger CD50 transmission fluid, heavy duty engine oil or mineral gear oil to assure maximum component life and to maintain your warranty with Eaton. (Also see "Operating Temperatures".)

Additives and friction modifiers are not recommended for use in Eaton Fuller transmissions.

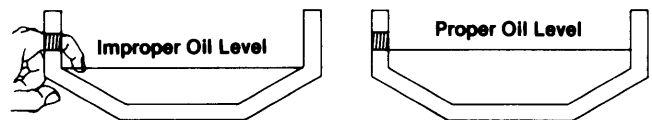

### Proper Oil Level

Make sure oil is level with filler opening. Because you can reach oil with your finger does not mean oil is at proper level. One inch of oil level is about one gallon of oil.

### Draining Oil

Drain transmission while oil is warm. To drain oil remove the drain plug at bottom of case. Clean the drain plug before re-installing.

### Refilling

Clean case around filler plug and remove plug from side of case. Fill transmission to the level of the filler opening. If transmission has two filler openings, fill to level of both openings.

The exact amount of oil will depend on the transmission inclination and model. Do not over fill—this will cause oil to be forced out of the transmission.

When adding oil, types and brands of oil should not be mixed because of possible incompatibility.

# LUBRICATION

## Operating Temperatures —With Eaton® Roadranger® CD50 Transmission Fluid Heavy Duty Engine Oil and Mineral Oil

The transmission should not be operated consistently at temperatures above 250°F (120°C). However, intermittent operating temperatures to 300°F (149°C) will not harm the transmission. Operating temperatures above 250°F increase the lubricant's rate of oxidation and shorten its effective life. When the average operating temperature is above 250°F, the transmission may require more frequent oil changes or external cooling.

The following conditions in any combination can cause operating temperatures of over 250°F: (1) operating consistently at slow speeds, (2) high ambient temperatures, (3) restricted air flow around transmission, (4) exhaust system too close to transmission, (5) high horsepower, overdrive operation.

External oil coolers are available to reduce operating temperatures when the above conditions are encountered.

Transmission Oil Coolers are:

### Recommended

- With engines of 350 H.P. and above with overdrive transmissions

### Required

- With engines 399 H.P. and above with overdrive transmissions and GCW'S over 90,000 lbs.
- With engines 399 H.P. and above and 1400 Lbs.-Ft. or greater torque
- With engines 450 H.P. and above

### — With EP or Multipurpose Gear Oil

Mild EP gear oil and multipurpose gear oil are not recommended when lubricant operating temperatures are above 230°F (110). In addition, transmission oil coolers are not recommended with these gear oils since the oil cooler materials may be attacked by these gear oils. The lower temperature limit and oil cooler restriction with these gear oils generally limit their success to milder applications.

## Proper Lubrication Levels as Related to Transmission Installation Angles

If the transmission operating angle is more than 12 degrees, improper lubrication can occur. The operating angle is the transmission mounting angle in the chassis plus the percent of upgrade (expressed in degrees).

The chart below illustrates the safe percent of upgrade on which the transmission can be used with various chassis mounting angles. For example: if you have a 4 degree transmission mounting angle, then 8 degrees (or 14 percent of grade) is equal to the limit of 12 degrees. If you have a 0 degree mounting angle, the transmission can be operated on a 12 degree (21 percent) grade.

Anytime the transmission operating angle of 12 degrees is exceeded for an extended period of time the transmission should be equipped with an oil pump or cooler kit to insure proper lubrication.

Note on the chart the effect low oil levels can have on safe operating angles. Allowing the oil level to fall 1/2" below the filler plug hole reduces the degree of grade by approximately 3 degrees (5.5 percent).

### Proper Lubrication Levels are Essential!

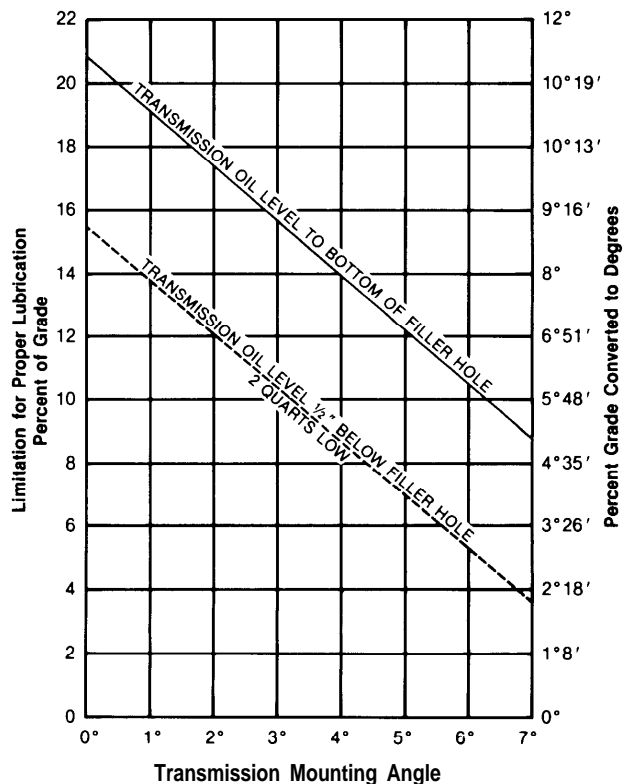

Dotted line showing "2 Quarts Low" is for reference only. Not recommended.

# OPERATION

## 18- Speed Transmission Shift Lever Patterns and Shifting Controls

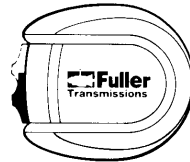
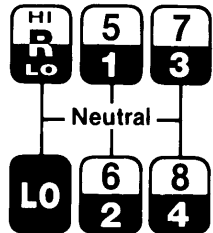

SHIFT LO-1 -2.3-4 IN  
LO RANGE.

RANGE SHIFT . . .  
AND SHIFT 5-6.7.8 IN  
HI RANGE.

### OVERDRIVE

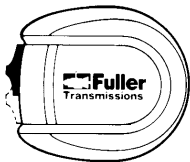
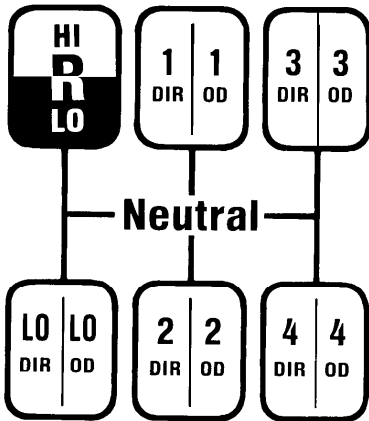

WHILE IN LO AND HI RANGE . . .  
Ratios can be split by  
moving the splitter  
Control Button to the  
forward position.

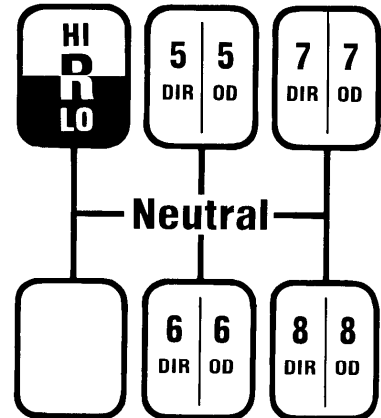

### ROAD RANGER VALVE (A-5013)

#### SPLITTER CONTROL BUTTON

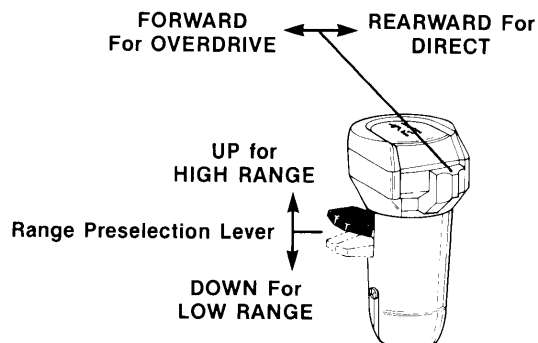



# POWER FLOW

The transmission must efficiently transfer the engine's power, in terms of torque, to the vehicle's rear wheels. Knowledge of what takes place in the transmission during torque transfer is essential when troubleshooting and making repairs.

## Front Section Power Flow (LO Range Direct)

1. Power (torque) from the vehicle's engine is transferred to the transmission's input shaft.
2. Splines of input shaft engage internal splines in hub of main drive gear.
3. Torque is split between the two countershaft drive gears.
4. Torque is delivered along both countershaft to mating countershaft gears of "engaged" mainshaft gear. The following cross section views illustrate a 1st/5th speed gear engagement.
5. Internal clutching teeth in hub of engaged mainshaft gear transfers torque to mainshaft through sliding clutch.
6. Mainshaft transfers torque directly to rear auxiliary drive gear.
7. The rear auxiliary drive gear splits torque between the two auxiliary countershaft drive gears.
8. Torque is delivered along both auxiliary countershaft to the "engaged" reduction gear on output shaft.
9. Torque is transferred to output shaft through sliding clutch.
10. Output shaft delivers torque to driveline.

### LO RANGE DIRECT

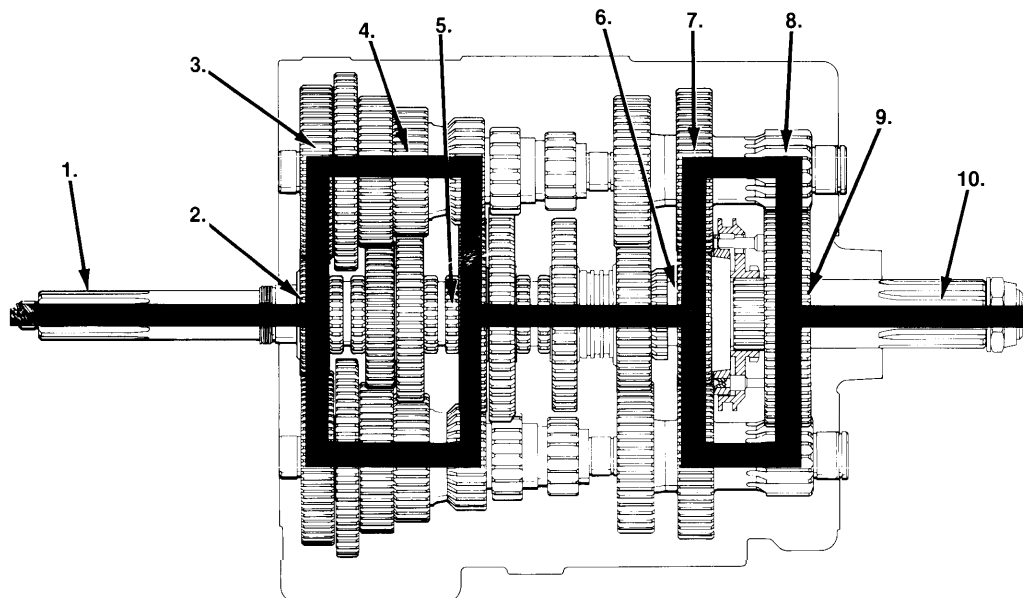

Cut 8006C-11 /87

# POWER FLOW

## Auxiliary Section Power Flow: LO RANGE OVERDRIVE

7. The front auxiliary drive gear splits torque between the two auxiliary countershaft drive gears.
8. Torque is delivered along both countershafts to "engaged" LO RANGE gear on range mainshaft or output shaft.
9. Torque is transferred to the output shaft through the sliding clutch.
10. Torque is delivered to driveline as LO RANGE 1st gear OVERDRIVE.

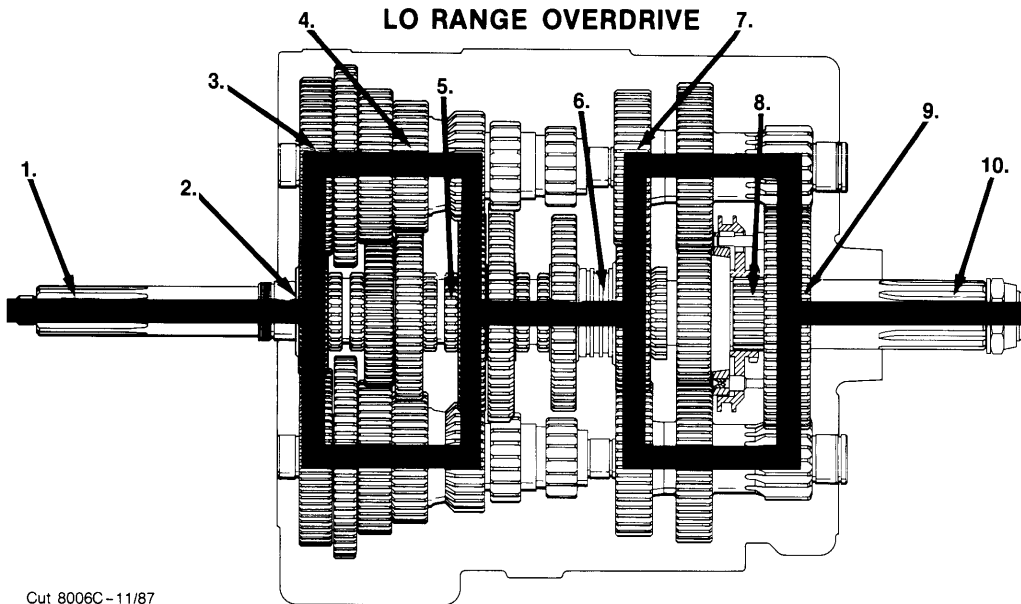

## Auxiliary Section Power Flow: HI RANGE DIRECT

7. The rear auxiliary drive gear transfers torque directly to the output shaft through sliding clutch.
8. Torque is delivered through the output shaft to driveline as HI RANGE 5th gear.

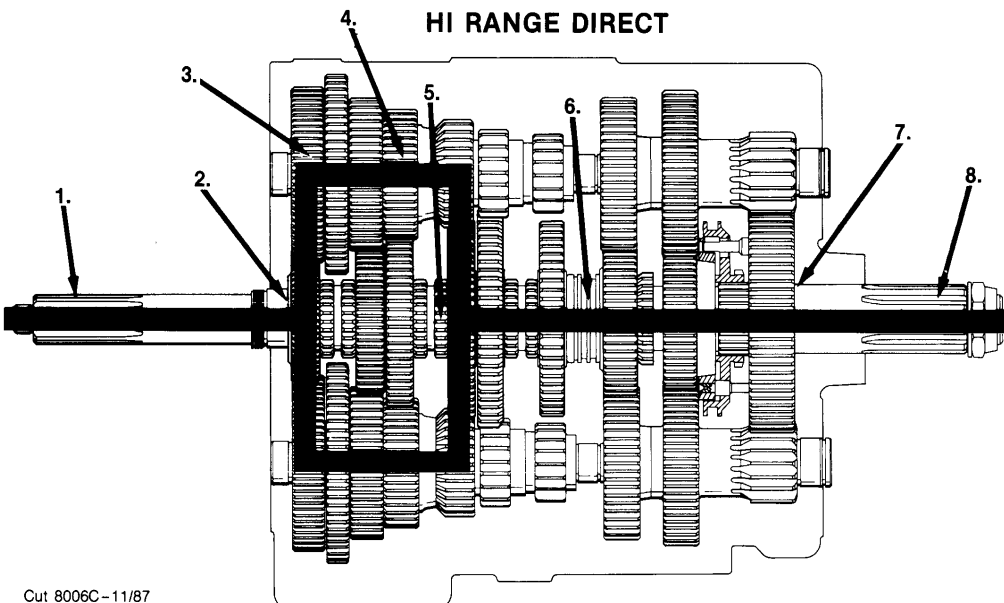

# POWER FLOW

## Auxiliary Section Power Flow: HI RANGE OVERDRIVE

7. The front auxiliary drive gear splits torque between the two auxiliary countershaft drive gears.
8. Torque is delivered along both auxiliary countershafts to mating countershaft gears of "engaged" rear auxiliary drive gear.
9. Torque is transferred to output shaft through the sliding clutch.
10. Output shaft delivers torque to driveline as HI Range 5th gear OVERDRIVE.

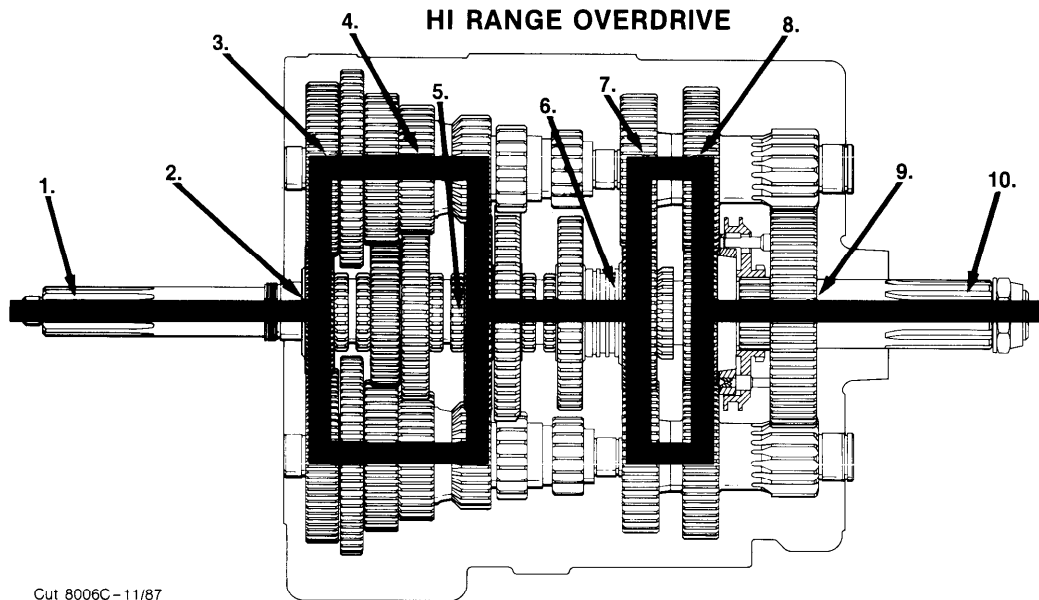

# TIMING

## Timing Procedures: All Models

It is essential that both countershaft assemblies of the front and auxiliary sections are "timed." This assures proper tooth contact is made between mainshaft gears seeking to center on the mainshaft during torque transfer and mating countershaft gears that distribute the load evenly. If not properly timed, serious damage to the transmission is likely to result from unequal tooth contact causing the mainshaft gears to climb out of equilibrium.

Timing is a simple procedure of marking the appropriate teeth of a gear set prior to installation and placing them in proper mesh while in the transmission. In the front section, it is necessary to time only the drive gear set. And depending on the model, only the LO range, deep reduction, or splitter gear set is timed in the auxiliary section.

### Front Section

#### A. Marking countershaft drive gear teeth.

1. Prior to placing each countershaft assembly into case, clearly mark the tooth located directly over the keyway of drive gear as shown. This tooth is stamped with an "O" to aid identification.

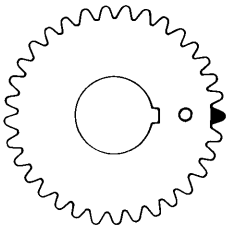

*Tooth on Countershaft directly over Keyway marked for timing*

Cut 7300 H-11/86

#### B. Marking main drive gear teeth.

1. Mark *any* two adjacent teeth on the main drive gear.
2. Mark the two adjacent teeth located directly opposite the first-set marked on the main drive gear. As shown below, there should be an equal number of unmarked gear teeth on each side between the marked sets.

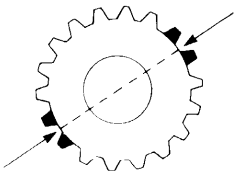

*Drive gear teeth correctly marked for timing.*

Cut 7300 G-11/86

#### C. Meshing marked countershaft drive gear teeth with marked main drive gear teeth.

(After placing the mainshaft assembly into case, the countershaft bearings are installed to complete installation of the countershaft assemblies.)

1. When installing the bearings on left countershaft, mesh the marked tooth of countershaft drive gear with either set or two marked teeth on the main drive gear.
2. Repeat the procedure when installing the bearings on right countershaft, making use of the remaining set of two marked teeth on the main drive gear to time assembly.

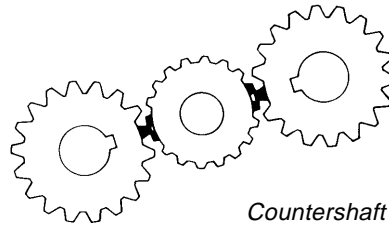

*Countershaft gear teeth meshed with drive gear teeth for correct timing.*

Cut 7300 F-1 1/86

### Auxiliary Section

#### A. Timing the auxiliary countershaft and LO range gear.

1. Mark any two adjacent teeth on "the LO range gear of set to be timed. Then mark the two adjacent teeth located directly opposite the first set marked as shown in Illustration B.
2. Prior to placing each auxiliary countershaft assembly into housing, mark the tooth stamped with an "O" on gear to mate with timed mainshaft gear as shown in Illustration A.
3. Install the LO range gear on the out put shaft and into the auxiliary case.
4. Seat the auxiliary countershaft bearings.
5. Install the rear bearing cover and tighten to recommended torque.
6. Place the auxiliary countershaft assemblies into position and mesh the marked teeth of the mating countershaft gears with the marked teeth of the LO range gear as shown in illustration C.

# TORQUE RECOMMENDATIONS

Correct torque application is extremely important to assure long transmission life and dependable performance. Over-tightening or under-tightening can result in a loose installation and, in many instances, eventually cause damage to transmission gears, shafts, and/or bearings. Use a torque wrench whenever possible to attain recommended lbs./ft. ratings. Do not torque capscrews dry.

## FRONT SECTION: ALL MODELS

(1) MAIN DRIVE GEAR BEARING NUT,  
250-300 Lbs./Ft., Apply  
Loctite Grade 277 Sealant and  
Stake to Input Shaft.

(6) FRONT BEARING COVER CAPSCREWS,  
35-45 Lbs./Ft.,  $\frac{3}{8}$ -16 Threads.  
Apply Loctite 242 to Threads.

(6) CLUTCH HOUSING NUTS.  
180-190 (170-175\*) Lbs./Ft.,  
 $\frac{5}{8}$ -18 Threads, Use Lockwashers.

(4) SLAVE AIR VALVE CAPSCREWS,  
8-12 Lbs./Ft.,  $\frac{1}{4}$ -20 Threads.  
Apply Loctite 242 to Threads.

(1) NEUTRAL SIGNAL SWITCH PLUG,  
35-50 Lbs./Ft.,  $\frac{3}{4}$ -16 Threads.

(5) SHIFT BLOCK AND YOKE LOCKSCREWS,  
35-45 Lbs./Ft.,  $\frac{7}{16}$ -20 Threads, Secure  
with Lockwire.

(16) SHIFT BAR HOUSING AND (4) SHIFT  
LEVER HOUSING CAPSCREWS, 35-45 Lbs./Ft.,  
 $\frac{3}{8}$ -16 Threads. Apply Loctite 242 to Threads.

(1) REVERSE SIGNAL SWITCH PLUG,  
35-50 Lbs./Ft.,  $\frac{9}{16}$ -18 Threads.

(2) SUPPORT STUD NUTS,  
170-185 Lbs./Ft.,  $\frac{5}{8}$ -18 Threads,  
Use Lockwashers.

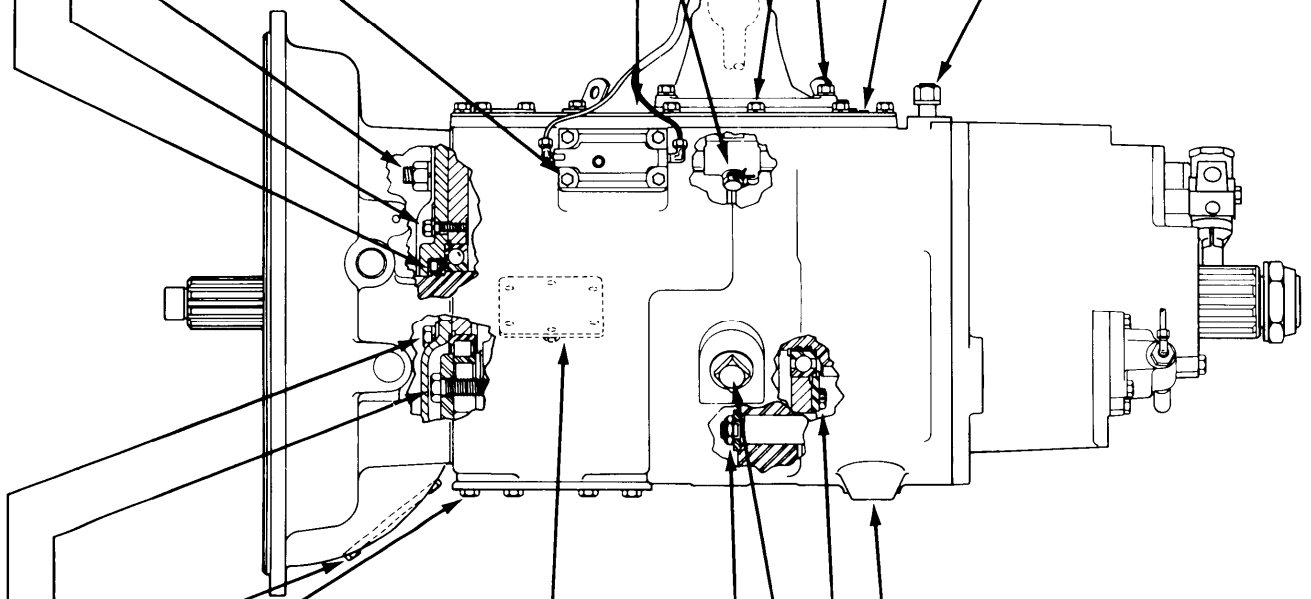

(6) SMALL P.T.O. COVER CAPSCREWS,  
35-45 Lbs./Ft.,  $\frac{3}{8}$ -16 Threads.  
Apply Loctite 242 to Threads.

(8) LARGE P.T.O. COVER CAPSCREWS,  
50-65 Lbs./Ft.,  $\frac{7}{16}$ -14 Threads.  
Apply Loctite 242 to Threads.

(4) HAND HOLE COVER CAPSCREWS,  
20-25 Lbs./Ft.,  $\frac{5}{16}$ -18 Threads.

(2) COUNTERSHAFT FRONT BEARING  
RETAINER

CAPSCREWS, 90-120 Lbs./Ft.,  $\frac{5}{8}$ -18 Threads.

(4) CLUTCH HOUSING CAPSCREWS, 90-100  
(70-75\*) Lbs./Ft.,  $\frac{1}{2}$ -13 Threads, Use Lockwashers.

(1) OIL DRAIN PLUG,  
45-55 Lbs./Ft.,  $\frac{3}{4}$  Pipe Threads.

(6) MAINSHAFT REAR BEARING RETAINER  
CAPSCREWS, 35-45 Lbs./Ft.,  
 $\frac{3}{8}$ -16 Threads, Secure with Lockwire.

(1) OIL FILL PLUG,  
60-75 Lbs./Ft.,  $1\frac{1}{4}$  Pipe Threads.

(2) REVERSE IDLER SHAFT NUTS,  
50-60 Lbs./Ft.,  $\frac{5}{8}$ -18 Threads.

\*With Aluminum Clutch Housing

# TORQUE RECOMMENDATIONS

## AUXILIARY SECTIONS

(2) AIR FILTER/REGULATOR MOUNTING  
CAPSCREWS 8-12 Lbs./Ft.,  $1/4$ -20 Threads.  
Apply Loctite 242 to Threads.

(1) RANGE CYLINDER SHIFT BAR NUT,  
70-85 Lbs./Ft.,  $5/8$ -18 Threads.

(2) RANGE SHIFT YOKE CAPSCREWS,  
50-65 Lbs./Ft.,  $1/2$ -20 Threads,  
Secure with Lockwire.

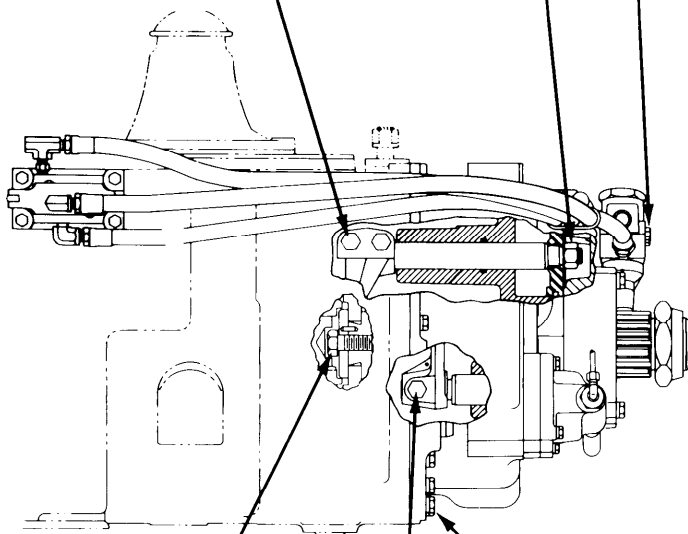

(1) CAPSCREW—  
REAR AUXILIARY  
RETAING NUT, 90-120 Lbs./Ft.,  
 $5/8$ -18 Threads.

(1) SPLITTER SHIFT YOKE LOCKSCREW,  
35-45 Lbs./Ft.,  $7/16$ -20 Threads,  
Secure with Lockwire.

(19) AUXILIARY HOUSING CAPSCREWS,  
35-45 Lbs./Ft.,  $3/8$ -16 Threads.  
Apply Loctite 242 to Threads.

(1) OUTPUT SHAFT NUT,  
450-500 Lbs./Ft.,  
2-16 Threads Oiled at  
Vehicle Installation.

(6) MAINSHAFT REAR BEARING COVER  
CAPSCREWS, 35-45 Lbs./Ft.,  $3/8$ -16 Threads.  
Apply Loctite 242 to Threads.

(4) RANGE CYLINDER MOUNTING  
CAPSCREWS, 35-45 Lbs./Ft.,  $3/8$ -16 Threads.  
Apply Loctite 242 to Threads.

(4) RANGE CYLINDER COVER  
CAPSCREWS, 35-45 Lbs./Ft.,  $3/8$ -16 Threads.  
Apply Loctite 242 to Threads.

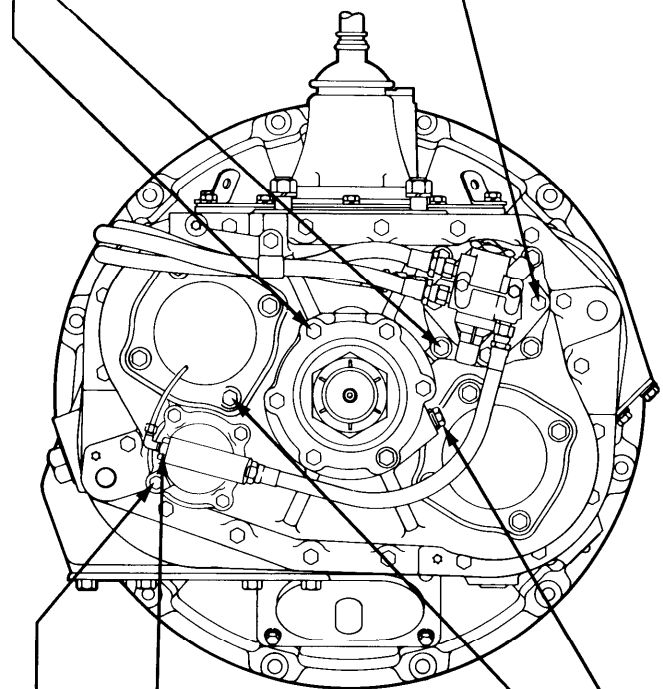

(1) RETAINING NUT/PLUG,  
40-50 Lbs./Ft.,  $5/8$ -18 Threads.

(4) SPLITTER CYLINDER COVER  
CAPSCREWS, 20-25 Lbs./Ft.,  
 $5/16$ -18 Threads.  
Apply Loctite 242 to Threads.

(8) COUNTERSHAFT REAR BEARING  
COVER CAPSCREWS, 35-45 Lbs./Ft.,  
 $3/8$ -16 Threads.  
Apply Loctite 242 to Threads.

(1) SPEEDOMETER HOUSING PLUG,  
35-50 Lbs./Ft.,  $13/16$ -20 Threads.  
Apply Loctite 242 to Threads.

# TOOL REFERENCE

some repair procedures pictured in this manual show the use of specialized tools. Their actual use is recommended as they make transmission repair easier, faster, and prevent costly damage to critical parts.

But for the most part, ordinary mechanic's tools such as socket wrenches, screwdrivers, etc., and other standard shop items such as a press, mauls and soft bars are all that is needed to successfully disassemble and reassemble any Fuller Transmission.

The specialized tools listed below can be obtained from a tool supplier or made from dimensions as required by the individual user. Detailed Fuller Transmission Tool Prints are available upon request by writing.

Eaton Corporation  
Transmission Division  
Technical Service Dept.  
P.O. Box 4013  
Kalamazoo, Michigan 49003

PAGE	TOOL	HOW OBTAINED
38	Tension Spring Driver	Made from Fuller Transmission Print T-11938
46	Auxiliary Section Hanger Bracket	Made from Fuller Transmission Print T-22823
46	Output Shaft Hanger Bracket	Made from Stop Nut and Flat Steel Stock
50	Snap Ring Pliers	Tool Supplier
51	Bearing Puller w/Set Screw	Made from Fuller Transmission Print T-10325
52	Bearing Pullers (Jaw-Type)	Tool Supplier
63	Oil Seal Driver	Made from Fuller Transmission Print T-18088-23
69	Bearing Drivers (Flanged-End)	Made from Fuller Transmission Print Series T-18042
77	Impact Puller (1/2-13 Threaded End)	Tool Supplier
102	Countershaft Support Tool	Made from Fuller Transmission Print T-22247
119	Torque Wrench, 1000 Lbs./Ft. Capacity	Tool Supplier

# PREVENTIVE MAINTENANCE

---

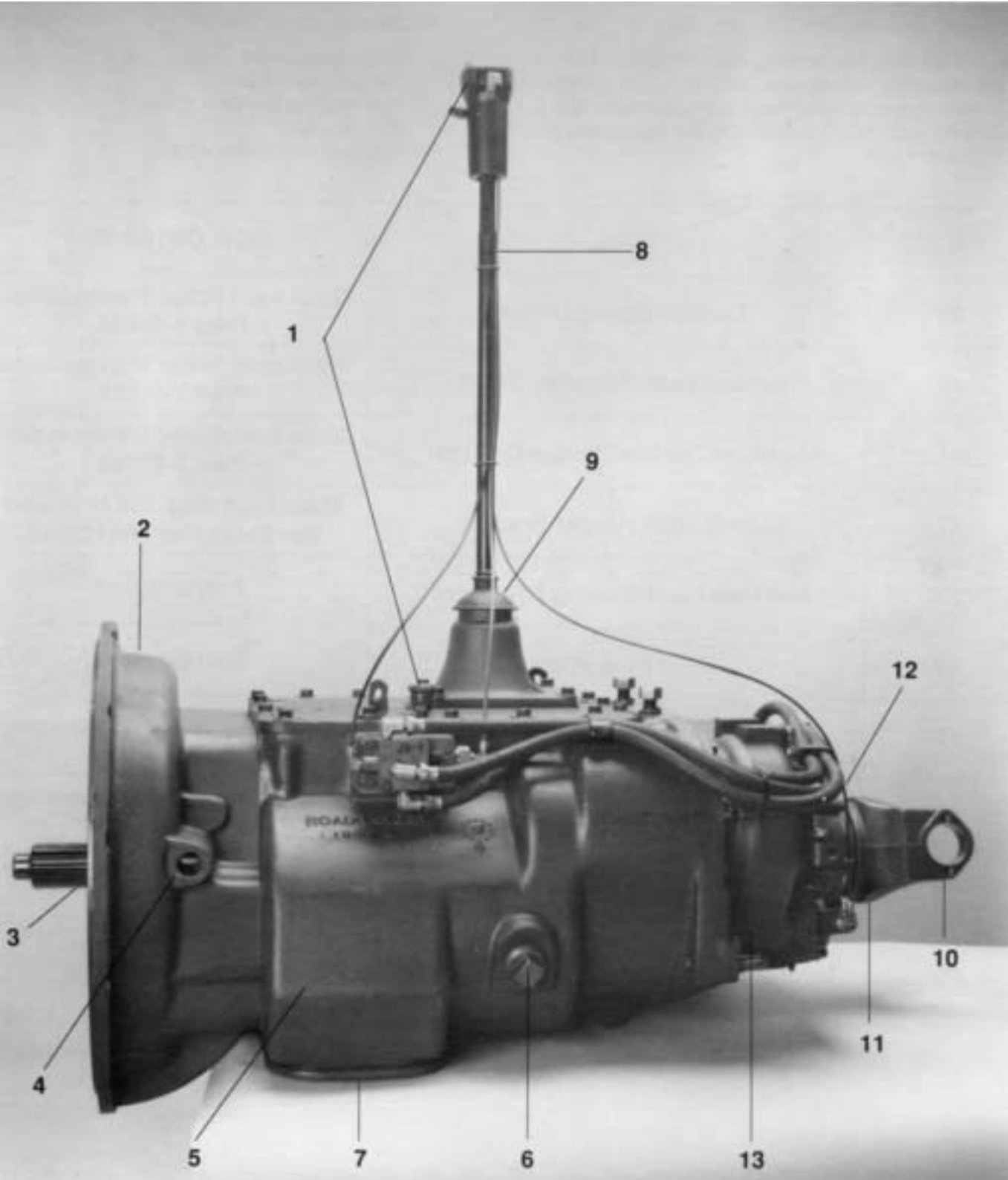



# PREVENTIVE MAINTENANCE

## PREVENTIVE MAINTENANCE CHECK CHART

### CHECKS WITHOUT PARTIAL DISASSEMBLY OF CHASSIS OR CAB

1. **Air System and Connections**
  - a. Check for leaks, worn air lines, loose connections and capscrews. See AIR SYSTEM.
2. **Clutch Housing Mounting**
  - a. Check all capscrews of clutch housing for looseness.
3. **Clutch Release Bearing (Not Shown)**
  - a. Remove hand hole cover and check radial and axial clearance in release bearing.
  - b. Check relative position of thrust surface of release bearing with thrust sleeve on push-type clutches.
4. **Clutch Pedal Shaft and Bores**
  - a. Pry upward on shafts to check wear.
  - b. If excessive movement is found, remove clutch release mechanism and check bushings in bores and wear on shafts.
5. **Lubricant**
  - a. Change at specified service intervals.
  - b. Use only the types and grades as recommended. See LUBRICATION.
6. **Filler and Drain Plugs**
  - a. Remove filler plugs and check level of lubricant at specified intervals. Tighten filler and drain plugs securely.
7. **Capscrews and Gaskets**
  - a. Check all capscrews, especially those on PTO covers and rear bearing covers for looseness which would cause oil leakage. See TORQUE RECOMMENDATIONS.
  - b. Check PTO opening and rear bearing covers for oil leakage due to faulty gasket.
8. **Gear Shift Lever**
  - a. Check for looseness and free play in housing. If lever is loose in housing, proceed with Check No. 9.

### 9. Gear Shift Lever Housing Assembly

- a. Remove air lines at slave valve and remove the gear shift lever housing assembly from transmission.
- b. Check tension spring and washer for set and wear.
- c. Check the gear shift lever spade pin and slot for wear.
- d. Check bottom end of gear shift lever for wear and check slot of yokes and blocks in shift bar housing for wear at contact points with shift lever.

### CHECKS WITH DRIVE LINE DROPPED

#### 10. Universal Joint Companion Flange or Yoke Nut

- a. Check for tightness. Tighten to recommended torque.

#### 11. Output Shaft (Not Shown)

- a. Pry upward against output shaft to check radial clearance in mainshaft rear bearing.

### CHECKS WITH UNIVERSAL JOINT COMPANION FLANGE OR YOKE REMOVED

**NOTE:** If necessary, use solvent and shop rag to clean sealing surface of companion flange or yoke. DO NOT USE CROCUS CLOTH, EMERY PAPER OR OTHER ABRASIVE MATERIALS THAT WILL MAR SURFACE FINISH.

#### 12. Splines on Output Shaft (Not Shown)

- a. Check for wear from movement and chucking action of the universal joint companion flange or yoke.

#### 13. Mainshaft Rear Bearing Cover

- a. Check oil seal for wear.

# PRECAUTIONS

---

## Disassembly

It is assumed in the detailed disassembly instructions that the lubricant has been drained from transmission, the necessary linkage and air lines disconnected and the transmission has been removed from vehicle chassis. Removal of the gear shift lever housing assembly (or remote control assembly) is included in the detailed instructions (Disassembly and Reassembly—Shifting Controls); however, this assembly **MUST** be detached from shift bar housing before transmission can be removed.

FOLLOW CLOSELY EACH PROCEDURE IN THE DETAILED INSTRUCTIONS. MAKING USE OF THE TEXT, ILLUSTRATIONS AND PHOTOGRAPHS PROVIDED.

1. **BEARINGS** — Carefully wash and relubricate all reusable bearings as removed and protectively wrap until ready for use. Remove bearings planned to be reused with pullers designed for this purpose.
2. **ASSEMBLIES** — When disassembling the various assemblies, such as the mainshaft, countershaft, and shift bar housing, lay all parts on a clean bench in the same sequence as removed. This procedure will simplify reassembly and reduce the possibility of losing parts.
3. **SNAP RINGS** — Remove snap rings with Pliers designed for this purpose. Snap rings removed in this manner can be reused, if they are not sprung or loose.
4. **INPUT SHAFT** — The input shaft can be removed from transmission without removing the coun-

tershafts, mainshaft, or main drive gear. Special procedures are required and provided in this manual.

5. **CLEANLINESS** — Provide a clean place to work. It is important that no dirt or foreign material enters the unit during repairs, Dirt is an abrasive and can damage bearings. It is always good practice to clean the outside of the unit before starting the planned disassembly.
6. **WHEN USING TOOLS TO MOVE PARTS** — Always apply force to shafts, housings, etc, with restraint. Movement of some parts is restricted. Never apply force to the part being driven after it stops solidly. The use of soft hammers, bars and mauls for all disassembly work is recommended.

## Inspection

Before reassembling the transmission, check each part carefully for abnormal or excessive wear and damage to determine reuse or replacement. When replacement is necessary, use only genuine Fuller Transmission parts to assure continued performance and extended life from your unit.

Since the cost of a new part is generally a small fraction of the total cost of downtime and labor, avoid reusing a questionable part which could lead to additional repairs and expense soon after initial reassembly. To aid in determining the reuse or replacement of any transmission part, consideration should also be given to the unit's history, mileage, application, etc.

Recommended inspection procedures are provided in the following checklist.

### A. BEARINGS

1. Wash all bearings in clean solvent. Check balls, rollers and raceways for pitting, discoloration, and spalled areas. Replace bearings that are pitted, discolored, or spalled.
2. Lubricate bearings that are not pitted, discolored, or spalled and check for axial and radial clearances.
3. Replace bearings with excessive clearances.
4. Check bearing fits. Bearing inner races should be tight to shaft; outer races slightly tight to slightly loose in case bore. If bearing spins freely in bore, however, case should be replaced.

### B. GEARS

1. Check gear teeth for frosting and pitting. Frosting of gear tooth faces present no threat of transmission failure. Often in continued operation of the unit, frosted gears will "heal" and not progress to the pitting stage. And in most cases, gears with light to moderate pitted teeth have considerable gear life remaining and can be reused. But gears with advanced stage pitting should be replaced.
2. Check for gears with clutching teeth abnormally worn, tapered, or reduced in length from clashing in shifting. Replace gears found in any of these conditions.

# PRECAUTIONS

---

## Inspection (cont'd.)

3. Check axial clearance of gears. Where excessive clearance is found, check gear snap ring, washer, spacer, and gear hub for excessive wear. Maintain .005" to .012" axial clearance between mainshaft gears.

## C. SPLINES

1. Check splines on all shafts for abnormal wear. If sliding clutch gears, companion flange, or clutch hub have worn into the sides of the splines, replace the specific shaft affected.

## D. TOLERANCE WASHERS

1. Check surfaces of all tolerance washers. Washers scored or reduced in thickness should be replaced.

## E. REVERSE IDLER GEAR ASSEMBLIES

1. Check for excessive wear from action of roller bearings.

## F. GRAY IRON PARTS

1. Check all gray iron parts for cracks and breaks. Replace parts found to be damaged.

## G. CLUTCH RELEASE PARTS

1. Check clutch release parts. Replace yokes worn at cam surfaces and bearing carrier worn at contact pads.
2. Check pedal shafts. Replace those worn at bushing surfaces.

## H. SHIFT BAR HOUSING ASSEMBLY

1. Check for wear on shift yokes and blocks at pads and lever slot. Replace excessively worn parts.
2. Check yokes for correct alignment. Replace sprung yokes.
3. Check lockscrews in yokes and blocks. Tighten and rewire those found loose.
4. If housing has been disassembled, check neutral notches of shift bars for wear from interlock balls.

## 1. GEAR SHIFT LEVER HOUSING ASSEMBLY

1. Check spring tension on shift lever. Replace tension spring and washer if lever moves too freely.
2. If housing is disassembled, check spade pin and corresponding slot in lever for wear. Replace both parts if excessively worn.

## J. BEARING COVERS

1. Check covers for wear from thrust of adjacent bearing. Replace covers damaged from thrust of bearing outer race.
2. Check bores of covers for wear. Replace those worn oversize.

## K. OIL RETURN THREADS AND SEALS

1. Check oil return threads in front bearing cover. If sealing action of threads has been destroyed by contact with input shaft, replace bearing cover.
2. Check oil seal in rear bearing cover. If sealing action of lip has been destroyed, replace seal.

## L. SLIDING CLUTCHES

1. Check all shift yokes and yoke slots in sliding clutches for extreme wear or discoloration from heat.
2. Check engaging teeth of sliding clutches for partial engagement pattern.

## M. SYNCHRONIZER ASSEMBLY

1. Check synchronizer for burrs, uneven and excessive wear at contact surface, and metal particles.
2. Check blocker pins for excessive wear or looseness.
3. Check synchronizer contact surfaces on the auxiliary drive and low range gears for excessive wear.

## N. O-RINGS

1. Check all O-rings for cracks or distortion. Replace if worn.

# PRECAUTIONS

---

## Reassembly

Make sure that interiors of case and housings are clean. It is important that dirt and other foreign materials be kept out of the transmission during reassembly. Dirt is an abrasive and can damage polished surfaces of bearings and washers. Use certain precautions, as listed below, during reassembly.

1. **GASKETS** — Use new gaskets throughout the transmission as it is being rebuilt. Make sure all gaskets are installed. An omission of any gasket can result in oil leakage or misalignment of bearing covers.
2. **CAPSCREWS** — To prevent oil leakage, use Loctite 242 thread sealant on all capscrews. For torque ratings, see TORQUE RECOMMENDATIONS.
3. **O-RINGS** — Lubricate all O-rings with silicone lubricant.
4. **ASSEMBLY** — Refer to the illustrations provided in the detailed disassembly instructions as a guide to reassembly.
5. **INITIAL LUBRICATION** — Coat all limit washers and splines of shafts with Lubriplate during reassembly to prevent scoring and galling of such parts.
6. **AXIAL CLEARANCES** — Maintain original axial clearances of .005" to .012" for mainshaft gears.
7. **BEARINGS** — Use of flanged-end bearing drivers is recommended for the installation of bearings. These special drivers apply equal force to both bearing races, preventing damage to balls/rollers and races while maintaining correct bearing alignment with bore and shaft. Avoid using a tubular or sleeve-type driver, whenever possible, as force is applied to only one of the bearing races. See TOOL REFERENCE.
8. **UNIVERSAL JOINT COMPANION FLANGE OR YOKE** — Pull the companion flange or yoke tightly into place with the output shaft nut, using 450-500 foot-pounds of torque. Make sure the speedometer drive gear or a replacement spacer of the same width has been installed. Failure to pull the companion flange or yoke tightly into place will permit the output shaft to move axially with resultant damage to the rear bearing.

**IMPORTANT: REFER TO THE APPROPRIATE ILLUSTRATED PARTS LIST (SPECIFIED BY MODEL SERIES) TO ENSURE THAT PROPER PARTS ARE USED DURING REASSEMBLY OF THE TRANSMISSION.**

# CHANGING INPUT SHAFT

## Special Procedure

In some cases, it may become necessary to replace the input shaft due to excessive clutch wear on the splines. Except for removal of the shift bar housing assembly, the input shaft can be removed without further disassembly of the transmission. Removal of the clutch housing is optional.

**NOTE:** The following illustration and instructions pertain to changing the input shaft ONLY. To change the main drive gear, complete disassembly of the front section is required.

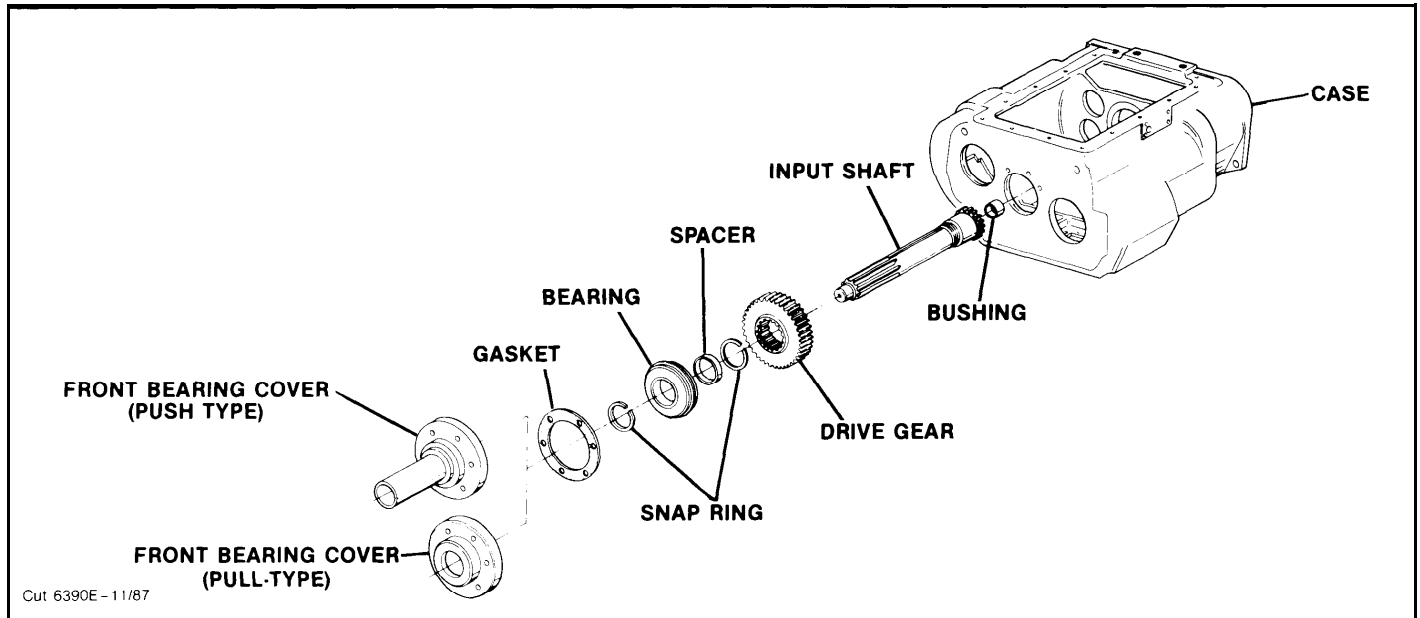

## Disassembly

1. Remove the gear shift lever housing assembly (or remote control assembly) from shift bar housing, and the shift bar housing assembly from transmission case.
2. Remove the front bearing cover and gasket. If necessary, remove the O-ring from cover of models so equipped.
3. Remove the bearing retaining snap ring from groove in shaft.
4. Push down on input shaft to cock bearing in bore. Drive input shaft toward rear of transmission, through bearing as far as possible. Pull input shaft forward to expose snap ring of bearing.
5. Use pry bars to complete removal of bearing.
6. Remove drive gear spacer and snap ring.
7. Pull input shaft forward and out of drive gear and case.

## Reassembly

1. If necessary, install bushing in pocket of input shaft.
2. Install new input shaft into splines of main drive gear, just far enough to expose snap ring groove in I.D. of drive gear.
3. Install snap ring in snap ring groove inside drive gear.
4. Install drive gear spacer on input shaft.
5. Install drive gear bearing on input shaft and into case bore.
6. Install bearing retainer snap ring.
7. Install front bearing cover and gasket. Make sure to align oil return hole in the case with hole in cover.
8. To facilitate proper reinstallation of the shift bar housing assembly on case, make sure mainshaft sliding clutches are placed in the neutral position.
9. Reinstall the shift bar housing assembly, the front bearing cover and all other parts and assemblies previously removed, making sure to replace the gaskets used.

# AIR SYSTEM

---

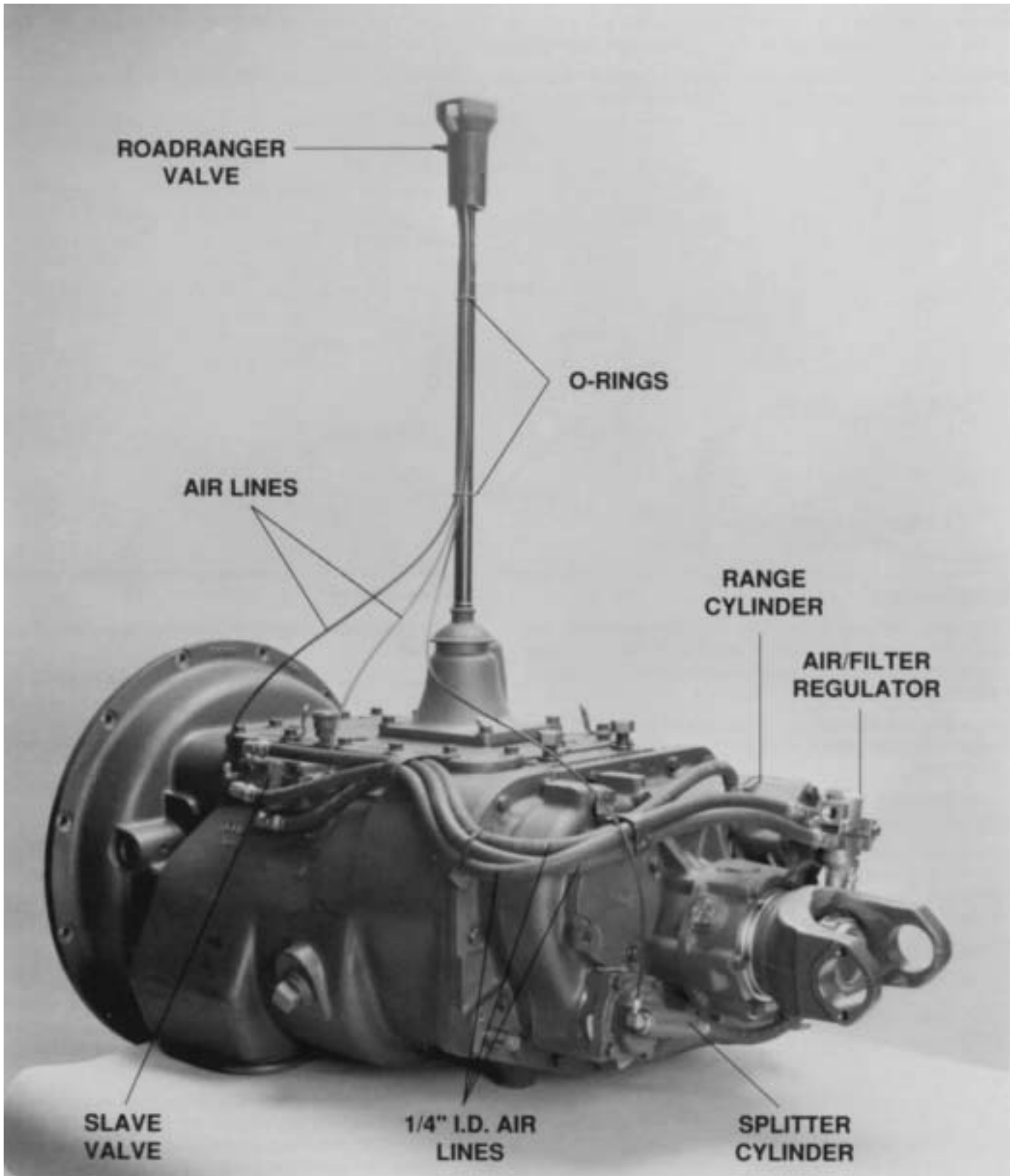

# AIR SYSTEM

## RANGE SHIFT AIR SYSTEM

### Operation

The Range Shift Air System consists of the air filter/regulator, slave valve, a Range Control Valve or Master Control Valve, range cylinder, fittings and connecting air lines. See Air System Schematics.

CONSTANT AIR from the air filter/regulator is supplied to the "S" or Supply Port of slave valve and passed through to the INLET or "S" Port of control valve.

WHILE IN LO RANGE, the control valve is OPEN and AIR is returned to slave valve at the "P" or End Port. This signals the valve to supply AIR in line between the LO Range or "L" Port of slave valve and the LO Range Port of range cylinder housing. AIR received at this port moves the range piston to the rear and causes the auxiliary LO RANGE gear to become engaged.

WHILE IN HI RANGE, the control valve is CLOSED and NO AIR is returned to the slave valve. This signals the slave valve to supply AIR in line between the HI Range or "H" Port of valve and the HI Range Port of range cylinder cover. AIR received at this port moves the range piston forward to engage the auxiliary drive gear with sliding clutch and bypass the LO RANGE gear set.

Range shifts can be made ONLY when the gear shift lever is in, or passing through, neutral. Thus, the range desired can be PRESELECTED while the shift lever is in a gear position. As the lever is moved through neutral, the actuating plunger in the shift bar housing releases the slave valve, allowing it to move to the selected range position.

### Trouble Shooting

If the transmission fails to make a range shift or shifts too slowly, the fault may be in the Range Shift Air System or actuating components of the shift bar housing assembly.

To locate the trouble, the following checks should be made with normal vehicle air pressure applied to the system, but with the engine off.

**⚠ WARNING** NEVER WORK UNDER A VEHICLE WHILE ENGINE IS RUNNING as personal injury may result from the sudden and unintended movement of vehicle under power. Always place transmission in the neutral position.

#### 1. INCORRECT AIR LINE HOOK-UPS (See Air System Schematics)

With the gear shift lever in neutral, move the control that provides range selection UP and DOWN.

- A. If the air lines are crossed between control valve and slave valve, there will be CONSTANT AIR flowing from the exhaust port of control valve WHILE IN HI RANGE.

- B. If the air lines are crossed between the slave valve and range cylinder, the transmission gearing will not correspond with the range selection. A LO RANGE selection will result in a HI RANGE engagement and vice versa.

#### 2. AIR LEAKS

With the gear shift lever in neutral, coat all air lines and fittings with soapy water and check for leaks, moving the control that provides range selection UP and DOWN.

- A. If there is a steady leak from the exhaust port of control valve, O-rings and/or related parts of the control valve are defective.
- B. If there is a steady leak from breather of slave valve: an O-ring in valve is defective, or there is a leak past O-rings of range cylinder piston.
- C. If transmission fails to shift into LO RANGE or is slow to make the range shift and the case is pressurized, see Check No. 7 of this section.
- D. Tighten all loose connections and replace defective O-rings and parts.

#### 3. AIR FILTER/REGULATOR (See illustration, Page 23.)

With the gear shift lever in neutral, check the breather of air filter/regulator assembly. There should be NO AIR leaking from this port. The complete assembly should be replaced if a steady leak is found.

Cut off the vehicle air supply to the air filter/regulator assembly, disconnect the air line at fitting in Supply OUTLET and install an air gage in opened port. Bring the vehicle air pressure to normal. Regulated air pressure should be 57.5 to 62.5 Psi.

**DO NOT ADJUST SCREW AT BOTTOM OF REGULATOR TO OBTAIN CORRECT READINGS.** The air regulator has been PREADJUSTED within the correct operating limits. Any deviation from these limits, especially with regulators that have been in operation for some time, is likely to be caused by dirt or worn parts. If replacement or cleaning of the filter element does nothing to correct the air pressure readings, replace the complete assembly, as the air regulator is nonserviceable.

#### 4. RANGE VALVE (See Page 24.)

With the gear shift lever in neutral, select HI RANGE and disconnect the air line at the OUTLET or "P" Port of control valve.

# AIR SYSTEM

- A. When LO RANGE is selected, a steady blast of air will flow from opened port. Select HI RANGE to shut off air flow. This indicates the control valve is operating properly. Reconnect air line.
- B. If control valve does not operate properly, check for restrictions and air leaks. Leaks indicate defective or worn O-rings.

## 5. HI RANGE OPERATION

With the gear shift lever in neutral, select LO RANGE and disconnect the 1/4" I.D. air line at the port of range cylinder cover. Make sure this line leads from the HI Range or "H" Port of slave valve.

- A. When HI RANGE is selected, a steady blast of air should flow from disconnected line. Select LO RANGE to shut off air flow.
- B. Move the shift lever to a gear position and select HI RANGE. There should be NO AIR flowing from disconnected line. Return the gear shift lever to the neutral position. There should now be a steady flow of air from disconnected line. Select LO RANGE to shut off air flow and reconnect air line.
- C. If the air system does not operate accordingly, the slave valve or actuating components of the shift bar housing assembly are defective.

### IMPORTANT: RANGE PRESELECTION

The plunger pin, located in case bore between the slave valve and actuating plunger of shift bar housing, prevents the slave valve from operating while the shift lever is in a gear position. When the lever is moved to or through the neutral position, the pin is released and the slave valve becomes operational.

## 6. LO RANGE OPERATION

With the gear shift lever in neutral, select HI RANGE and disconnect the 1/4" I.D. air line at the fitting on range cylinder housing. Make sure this line leads from the LO Range or "L" Port of slave valve.

- A. When LO RANGE is selected, a steady blast of air should flow from disconnected line. Select HI RANGE to shut off air flow.
- B. Move the shift lever to a gear position and select LO RANGE. There should be NO AIR flowing from disconnected line. Return the gear shift lever to the neutral position. There should now be a steady flow of air from disconnected line. Select HI RANGE to shut off air flow and reconnect air line.
- C. If the air system does not operate accordingly, the slave valve or actuating components of the shift bar housing assembly are defective.

## 7. RANGE CYLINDER (Refer to the following illustration.)

If any of the seals in the range cylinder assembly are defective, the range shift will be affected.

- A. Leak at either O-ring A results in complete failure to make a range shift; steady flow of air from breather of slave valve in both ranges.
- B. Leak at gasket B results in a steady flow of air to atmosphere while in HI RANGE.
- C. Leak at O-ring C results in a slow shift to LO RANGE; pressurizing of transmission case.

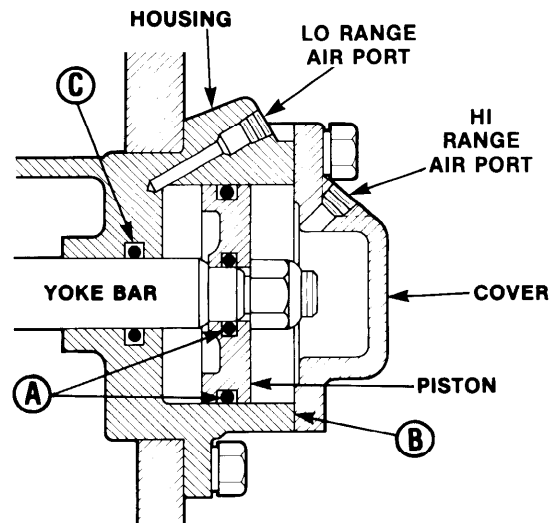

Cut 7420-5/87

Range Cylinder Assembly—All Models



# AIR SYSTEM

## AIR FILTER/REGULATOR ASSEMBLY

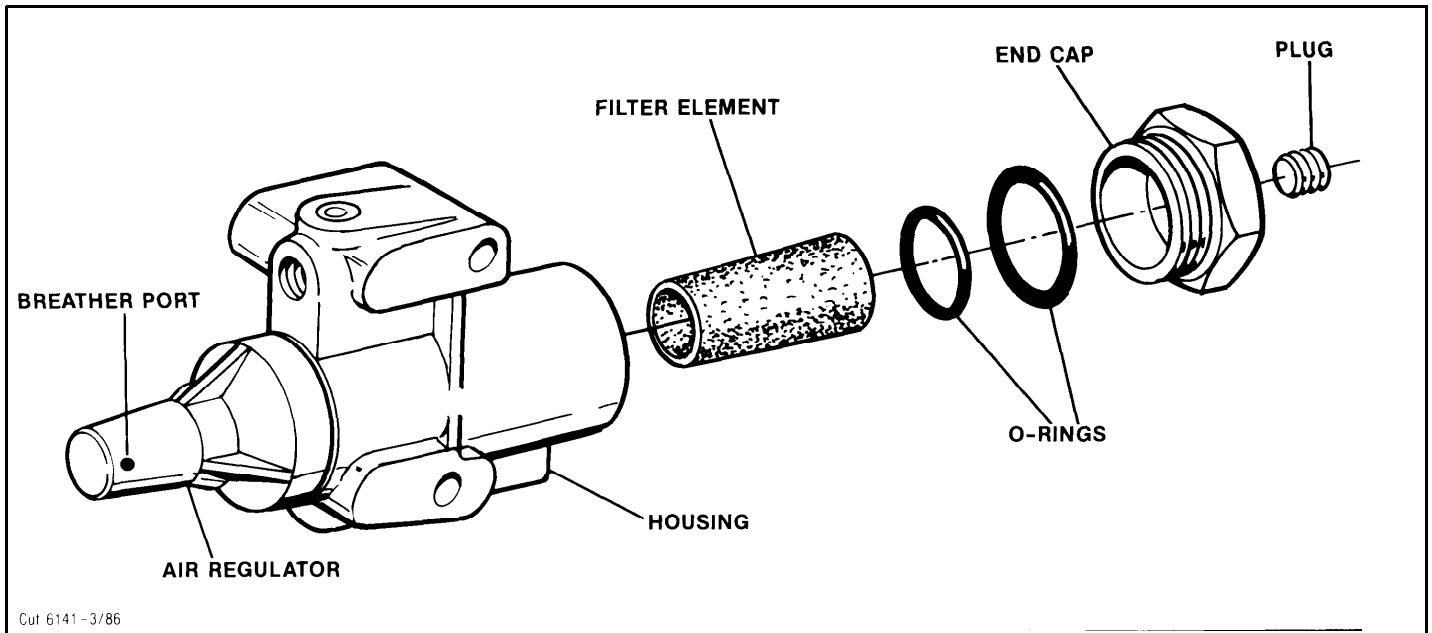

The air filter contains a replaceable filter element which can be removed by turning out the end cap. This element should be cleaned at each oil change, or more often under high humidity conditions. Replace if necessary.

## SLAVE VALVES

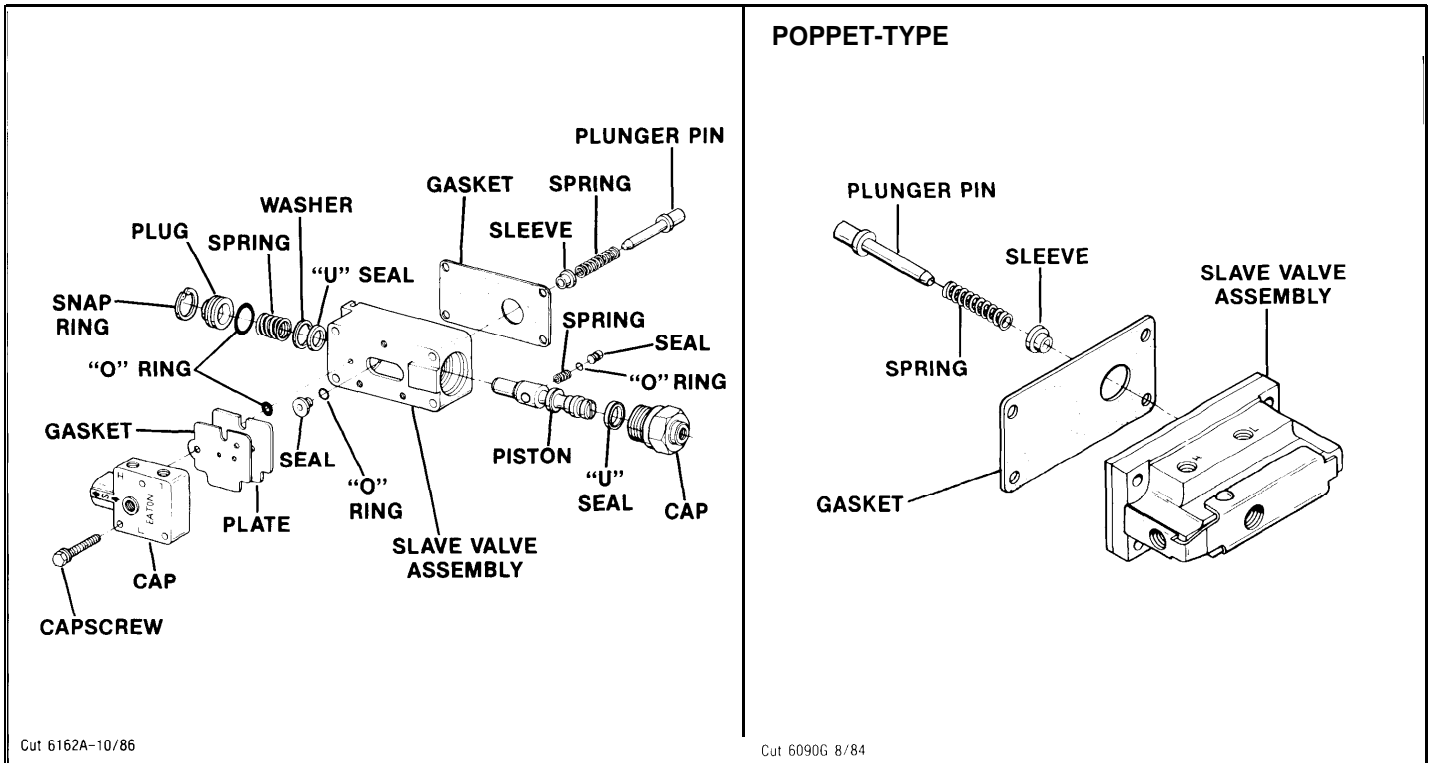

Refer to the drawing for disassembly and reassembly of the piston-type slave valve assemblies. Should the poppet-type slave valve assembly prove to be defective, replace the complete assembly, as it is non-serviceable. The actuating components used with these valve assemblies are non-interchangeable. Failure to use the correct plunger pin, spring, and alignment sleeve during installation on the transmission will cause hard shifting in LO Range gears.

# AIR SYSTEM

## ROADRANGER VALVE A-5013

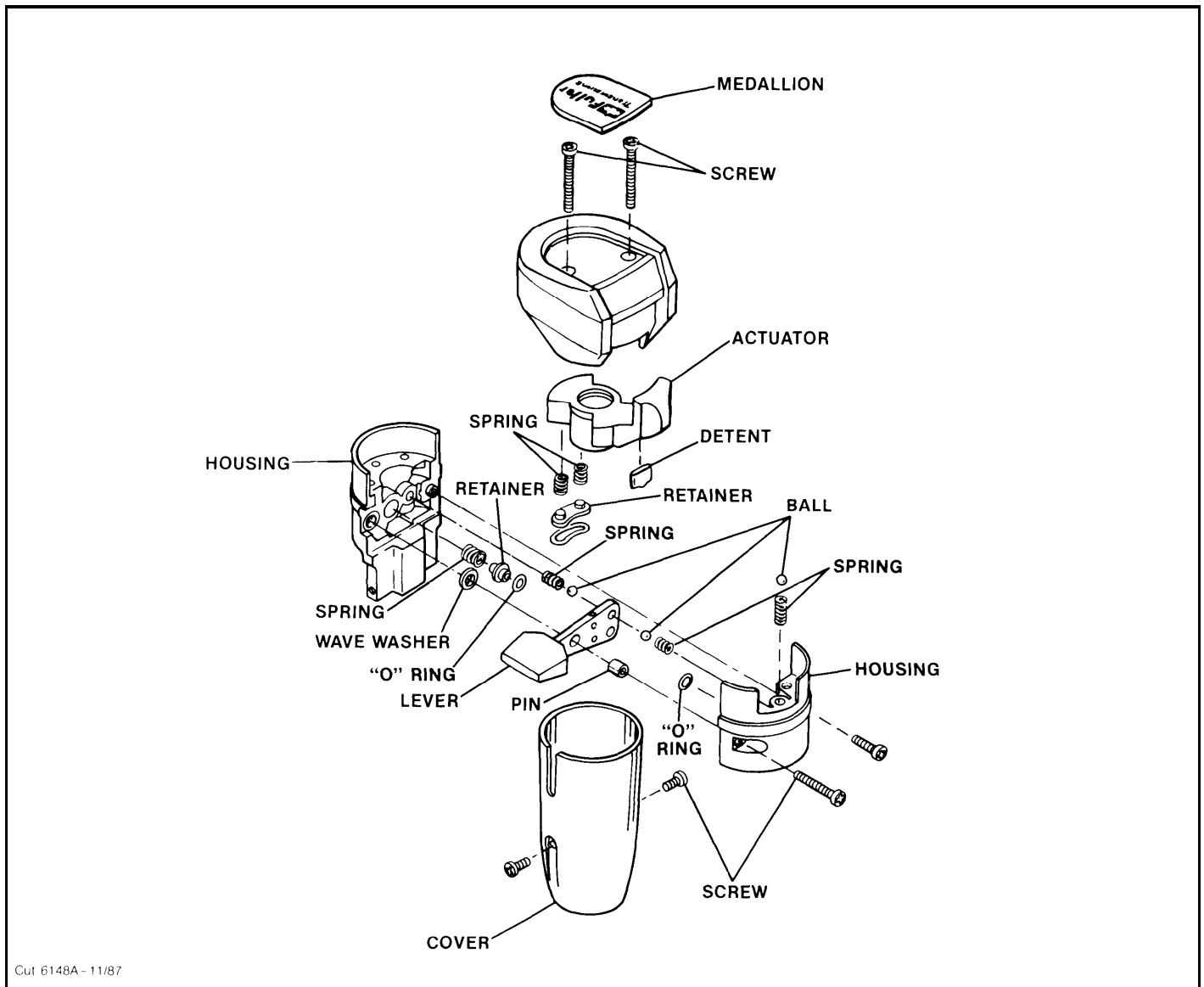

### Removal and Disassembly

1. Remove two screws holding bottom cover to valve and slide cover down gearshift lever to expose air line fittings. Disconnect air lines.
2. Loosen jam nut and turn control valve from gear shift lever.
3. Pry medallion from recess in top cover.
4. Turn out the two screws to remove the top cover from valve housing.
5. Turn out the two screws in side of valve housing to separate the housing.
6. Remove the Range Preelection Lever from left housing and the position balls and guide from lever.

7. If necessary, remove the spring and O-ring from bores in left housing.
8. If necessary, remove the springs, O-ring and sleeve from bores in right housing.

### Reassembly and Installation

1. Refer to the drawing for proper reassembly. Use a VERY SMALL amount of silicone lubricant on the O-rings to avoid clogging ports. A small amount of grease on the position springs and balls will help to hold them in place during reassembly.
2. Install control valve on gear shift lever and tighten jam nut.
3. Attach air lines and install bottom cover.

# AIR SYSTEM

## SPLITTER SHIFT AIR SYSTEM:

### Operation

In addition to the various components of the Range Shift Air System, the Splitter Shift Air System utilizes a splitter cylinder and the Roadranger Valve A-4900. See Air System Schematics.

CONSTANT AIR from the air filter/regulator assembly is supplied to the splitter cylinder at the port on right side of cylinder cover. The Insert valve installed in cover (see page 27) provides the proper air flow needed to move the splitter piston in the cylinder (rearward to engage rear auxiliary drive gear for operation in direct; forward to engage the front auxiliary drive gear for operation in overdrive).

WHILE IN HI OR LO RANGE, AIR needed to make the splitter selection and complete the shift is supplied to the Roadranger valve from the tee fitting at the HI RANGE or "H" port of the slave valve. When the overdrive selection is made, the AIR passes through the Roadranger valve and is supplied to the Left Port of cylinder cover.

With Splitter Control Button in the "DIRECT"/REARWARD position, the "SP" Port of the Roadranger valve is CLOSED and NO AIR is supplied to the Left Port of the Splitter cylinder cover.

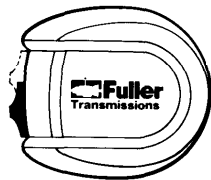

**Button REARWARD**  
(“SP” Port Closed)

While in HI RANGE the button can be moved FORWARD to operate in OVERDRIVE. The "SP" Port of valve is OPENED when overdrive is selected, supplying AIR to the Left Port of the Splitter cylinder cover.

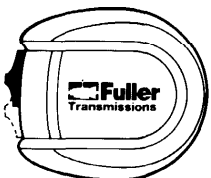

**Button FORWARD**  
(“SP” Port Opened)

### Trouble Shooting

If the transmission fails to shift or shifts too slowly to or from the "split" position, the fault may be in the Splitter Shift Air System or related components of the Range Shift Air System.

To locate the trouble, the following checks should be made with normal vehicle air pressure supplied to the system, but with the engine off.

**WARNING** NEVER WORK UNDER A VEHICLE WHILE ENGINE IS RUNNING as personal injury may result from the sudden and unintended movement of vehicle under power. Always place transmission in the neutral position.

**NOTE:** It is assumed that correct PSI readings were obtained from the air filter/regulator and all air lines have been checked for leaks.

- 1. Air Supply (See Air System Schematics.)**  
With the gear shift lever in neutral, select HI or LO RANGE and loosen the connection at the "S" Port of the Roadranger Valve until it can be determined that AIR is supplied to valve. Reconnect air line.  
If there is NO AIR, check for a restriction in the air line between the Roadranger valve and slave valve. Make sure this line is connected to fitting at the supply Port of slave valve.
- 2. Roadranger Valve (See Page 24 and Air System Schematics.)**  
With the gear shift lever in neutral, disconnect the air line at the Left Port of splitter cylinder cover, making sure this line leads from the "SP" Port of the Roadranger Valve.
  - A. WHILE IN HI OR LO RANGE, move the Splitter Control Button FORWARD. There should be AIR flowing from disconnected line. Move the button REARWARD to shut off air flow and reconnect air line.
  - B. If the preceding conditions do not exist, the Roadranger valve is defective, or there is a restriction in the air lines.
- 3. Splitter Cylinder. (Refer to the following illustration.)**  
If any of the seals in the splitter cylinder assembly are defective, the splitter shift will be affected. The degree of air lost will govern the degree of failure, from slow shifting to complete shift failure.
  - A. Leak at O-ring A results in a slow shift to engage rear auxiliary drive gear; pressurizing of transmission case; auxiliary gearing can be disengaged.

# AIR SYSTEM

- B. Leak at O-ring B results in slow shifting or complete failure to engage and disengage front or rear auxiliary drive gearing; steady flow of air from exhaust port of Roadranger valve and/or cylinder cover when Splitter Control Button is in the REARWARD position.
- C. Leak at gasket C results in a slow shift to disengage rear auxiliary drive gear; steady flow of air to atmosphere.

## 4. Insert Valve (See Page 27).

Any constant flow of air from exhaust port of cylinder cover usually indicates a faulty insert valve. Exhaust should occur ONLY BRIEFLY when Splitter Control Button is moved REARWARD WHILE IN LO and HI RANGE.

A faulty insert valve, leaking at the O-rings of valve O.D. or from inner seals results in constant air leak and shift failure. Two indications of defective O-rings or seals are:

- A. CONSTANT AIR flowing from exhaust port of cylinder cover.
- B. CONSTANT AIR flowing from Exhaust Port "E" of control valve WHILE SPLITTER CONTROL BUTTON IS REARWARD OR FORWARD (providing the control valve is operating properly).

The three O-rings in position on valve O.D. can be replaced. However, if an inner seal is damaged, the complete assembly MUST be replaced.

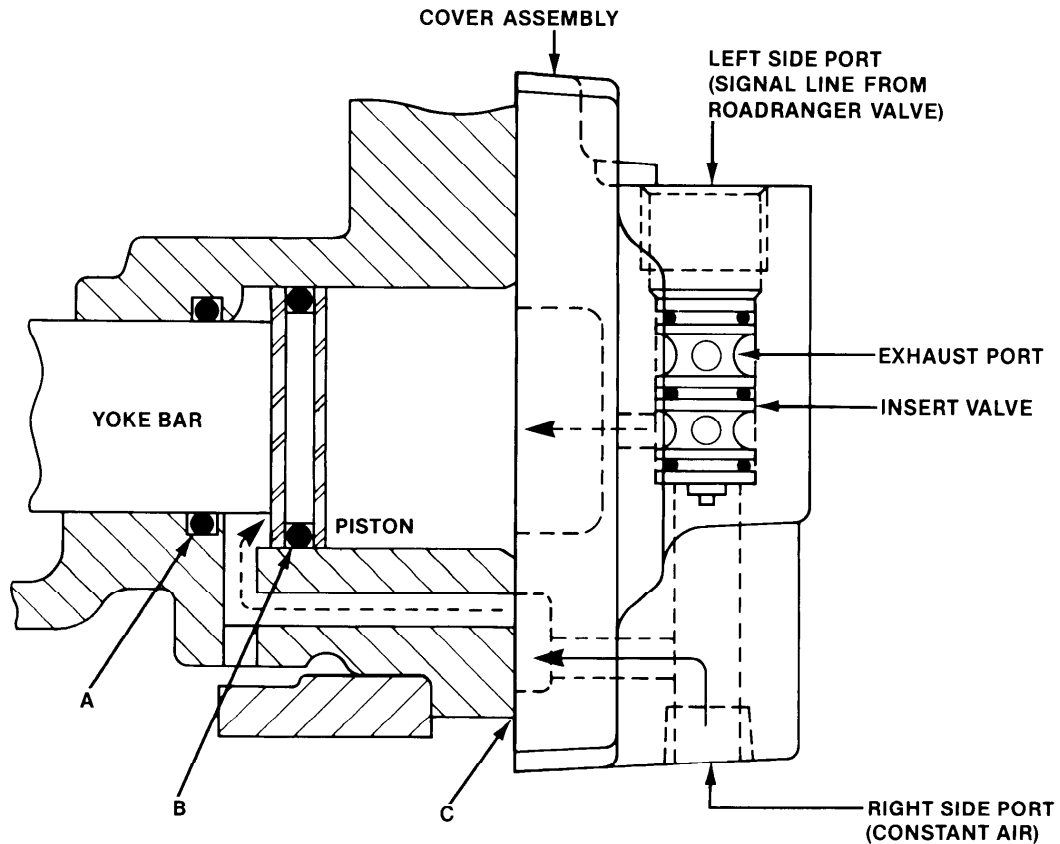

Out 7450D - 8/86

# AIR SYSTEM

## INSERT VALVE: (EQUIPPED WITH ROADRANGER VALVE A-5013)

The insert valve is a self-contained 1-3/16" valve assembly located in the splitter cylinder cover. It CAN-

NOT be disassembled except for the three O-rings on outer diameter. The O-rings provide a stationary seal and do not move in cylinder.

When installing the insert valve in bottom edge of cover, apply Fuller #71206 silicone lubricant or its equivalent to O-rings and cylinder walls. Install valve in bore with flat surface to the outside. When installing the special valve retaining nut, apply Fuller #71204 adhesive/sealant or its equivalent to threads and tighten. See TORQUE RECOMMENDATIONS.

Travel of the small insert valve piston is only  $\frac{3}{16}$ ". As shown in the illustrations below, when NO AIR is applied to the top side of valve piston, CONSTANT AIR supplied from the regulator passes to the FRONTSIDE of cylinder piston, moving the yoke bar backward to engage the REAR AUXILIARY DRIVE GEAR (LO RANGE DIRECT AND HI RANGE DIRECT). The piston moves up to cut off air to the back side of the cylinder piston. This air is exhausted out the cylinder cover as the piston moves rearward.

When AIR is applied to top side of valve piston, through signal line, the piston moves down passing air through the bottom of insert valve to the front and backside of the cylinder piston, moving the yoke bar FORWARD engaging the FRONT AUXILIARY DRIVE GEAR (LO RANGE OVERDRIVE AND HI RANGE OVERDRIVE).

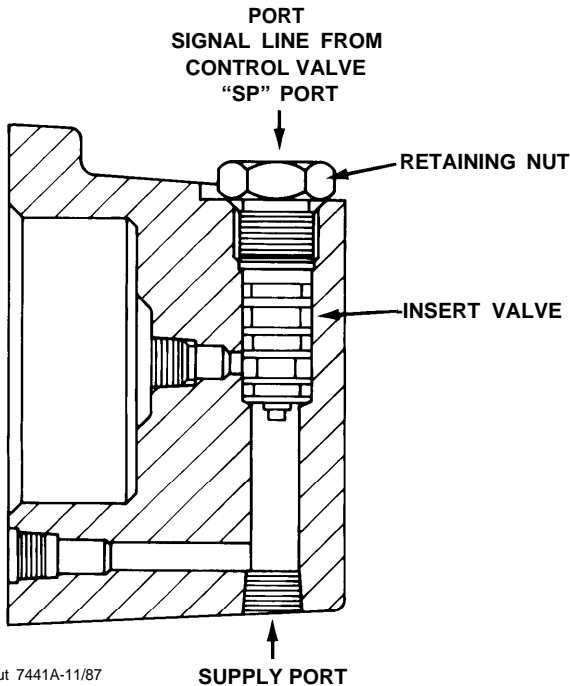

Cut 7441A-11/87

### LOW RANGE AND HIGH RANGE DIRECT

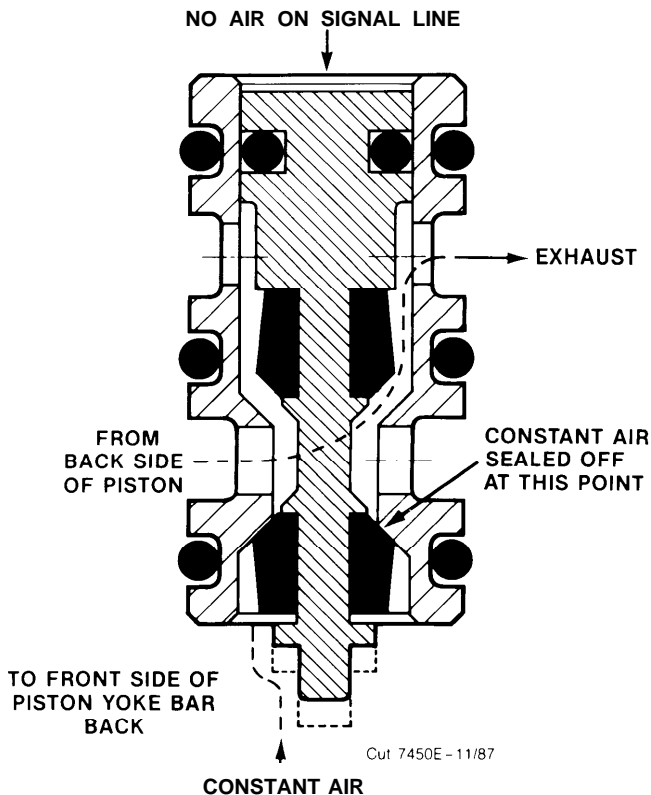

Cut 7450E-11/87

### OVERDRIVE

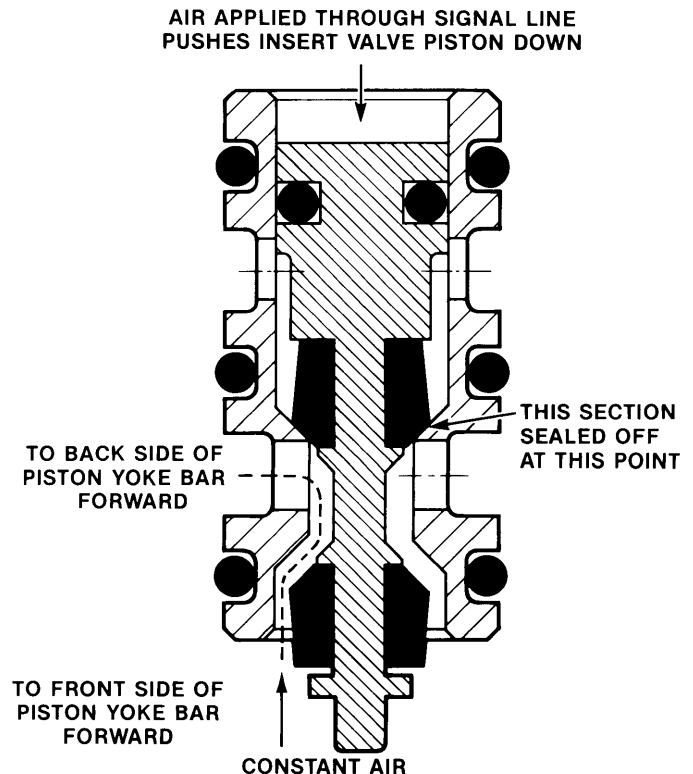

Cut 7450F-11/87

## RTO-15618 and RTLO-XX618 Models

### LO Range L

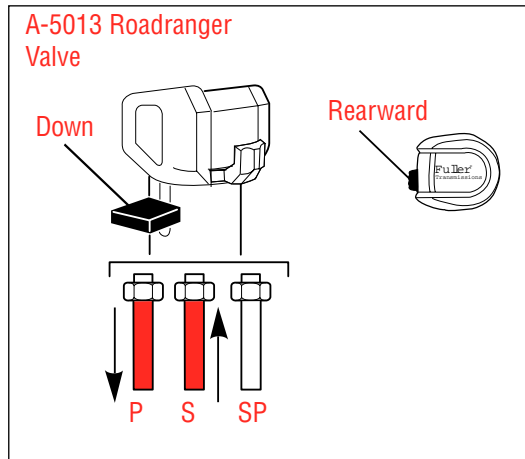

### Slave Valve Identification

A-5000 Valve

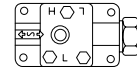

19470 Valve

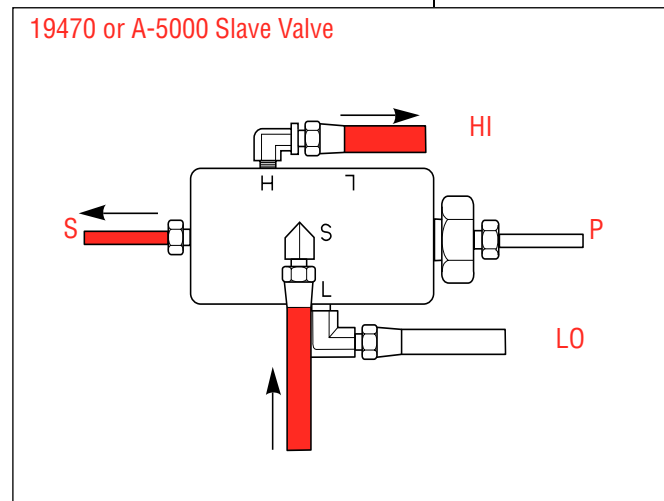
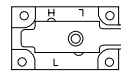

## Schematic

For all questions concerning removal and replacement, refer to Eaton Service and Parts Literature.

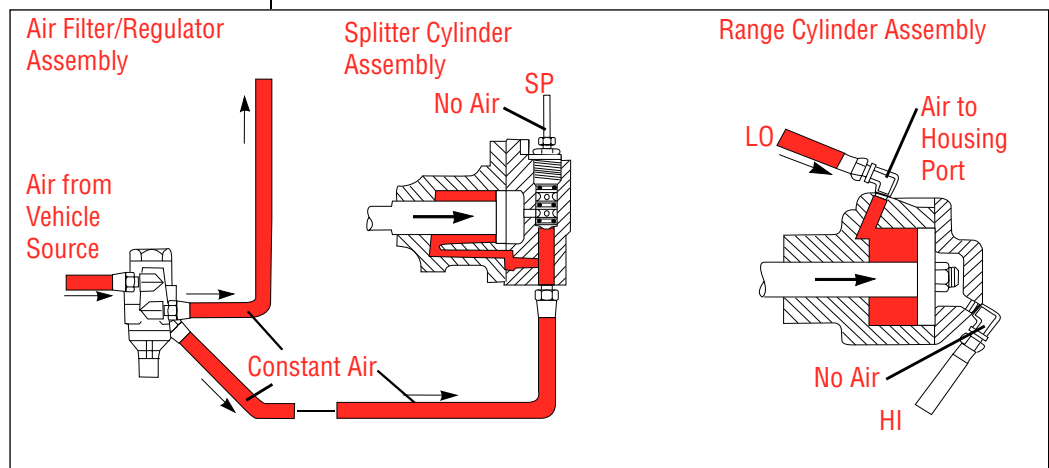

# RT0-15618 and RTLO-XX618 Models

## LO Range H

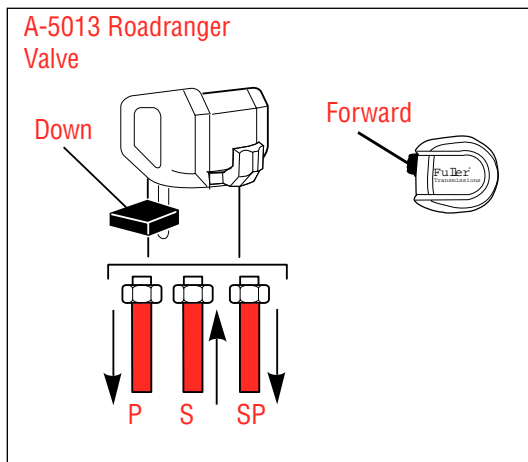

### Slave Valve Identification

A-5000 Valve

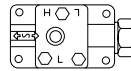

19470 Valve

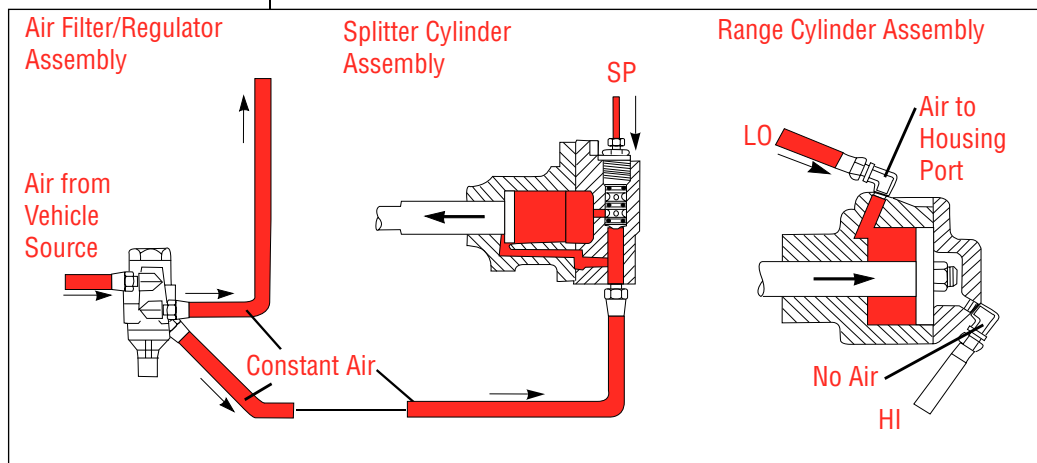
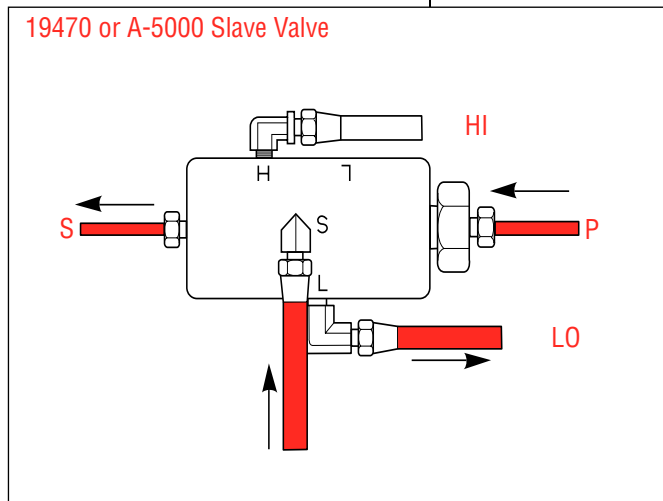
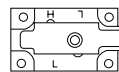

## Schematic

For all questions concerning removal and replacement, refer to Eaton Service and Parts Literature.

## RT0-15618 and RTLO-XX618 Models

### HI Range L

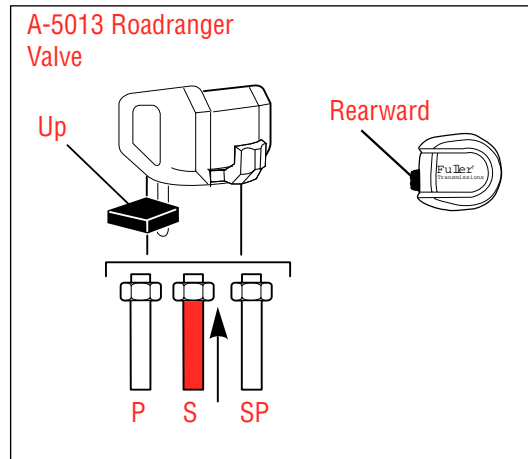

### Slave Valve Identification

#### A-5000 Valve

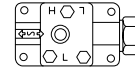

#### 19470 Valve

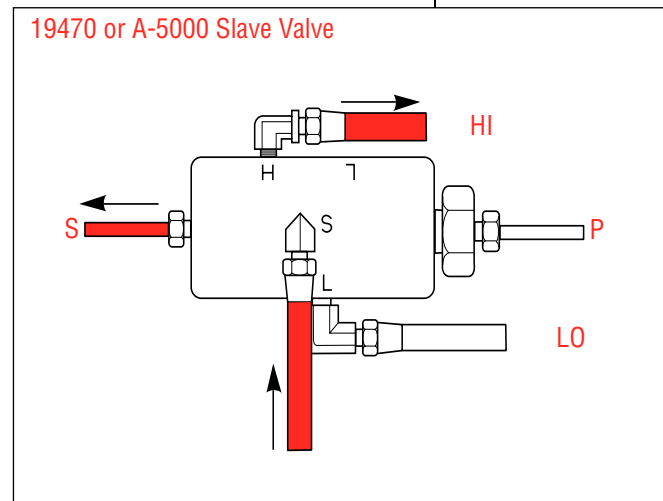
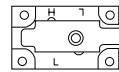

## Schematic

For all questions concerning removal and replacement, refer to Eaton Service and Parts Literature.

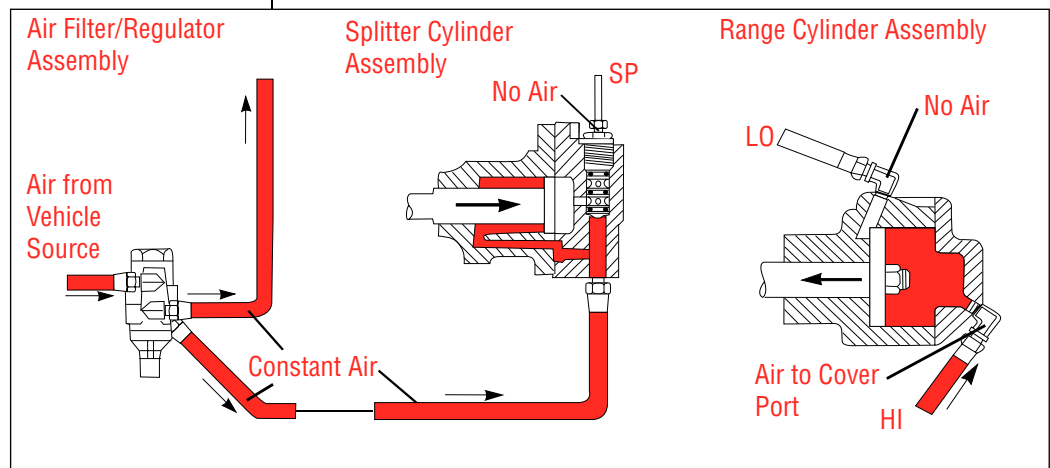



# RTO-15618 and RTLO-XX618 Models

## HI Range H

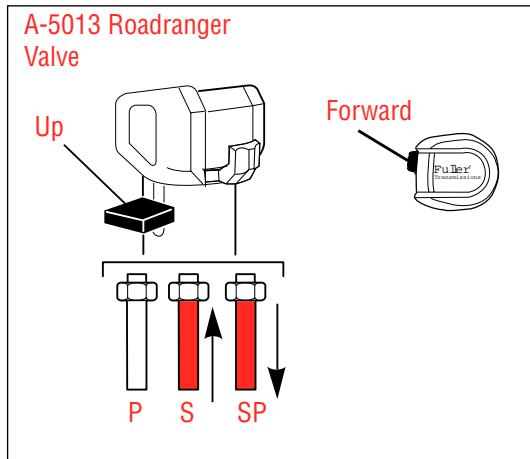

### Slave Valve Identification

A-5000 Valve

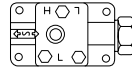

19470 Valve

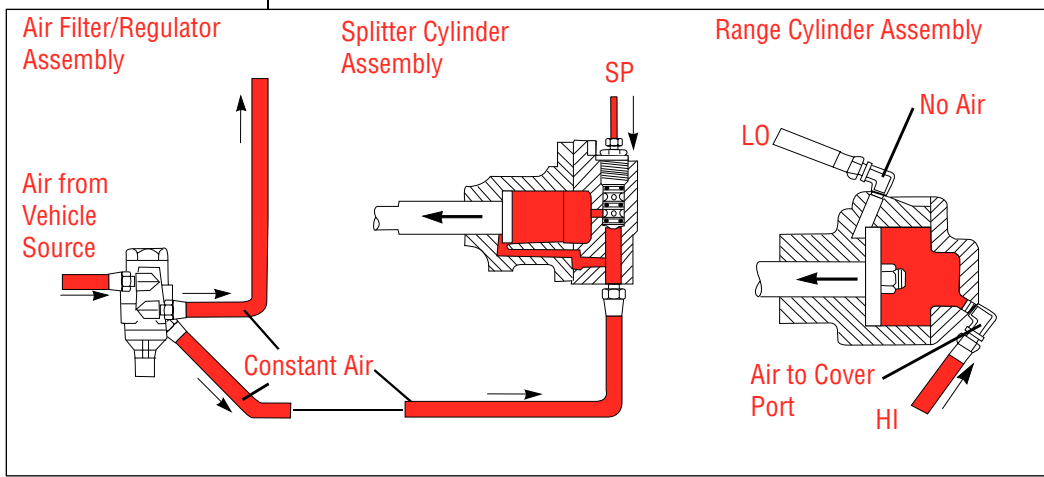
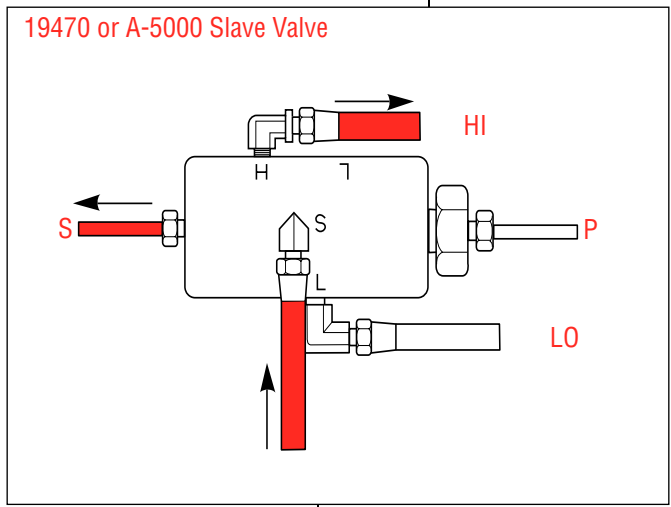
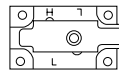

**Schematic**

For all questions concerning removal and replacement, refer to Eaton Service and Parts Literature.

# DISASSEMBLY SHIFTING CONTROLS

## Air System

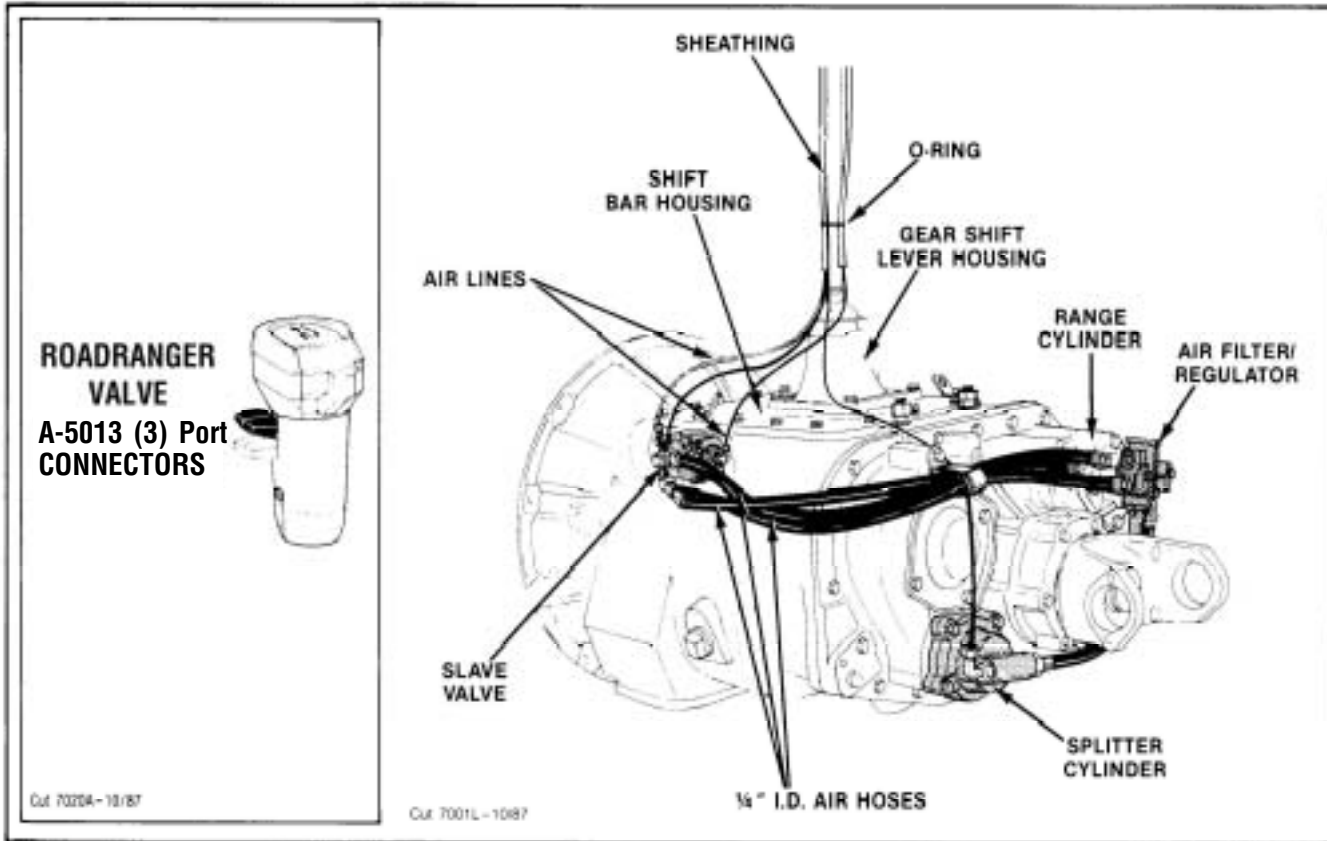

### A. Removal of Air Control



1. Disconnect the two air lines at the "S" or Supply Port and "P" or End Port of the slave valve on the transmission case.

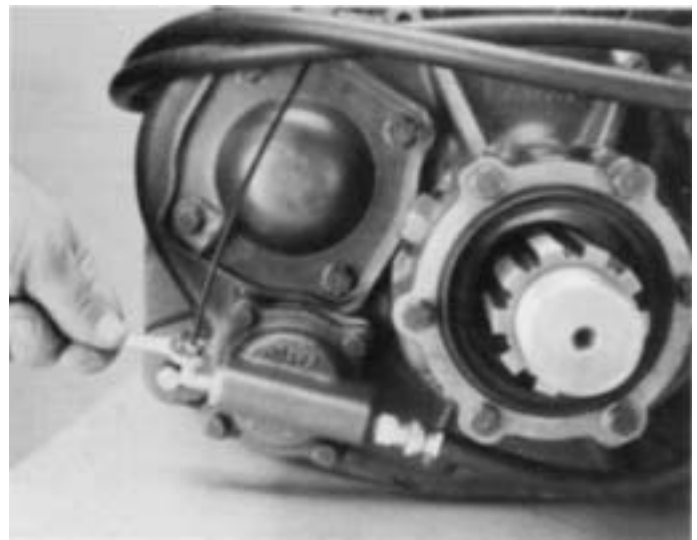

2. Remove the air line at the splitter cylinder cover.

**NOTE:** If desired, the gear shift lever housing assembly can now be removed from shift bar housing by removing the four capscrews from the tower.

# DISASSEMBLY SHIFTING CONTROLS

---

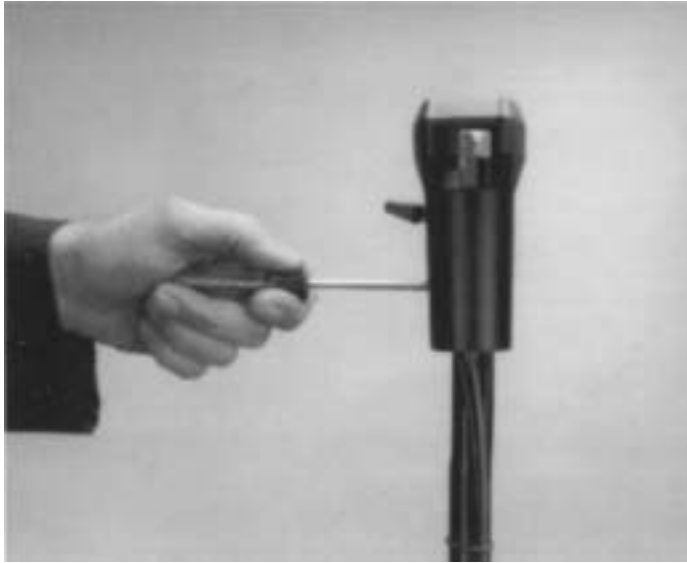

3. Turn out the two mounting screws in the Roadranger valve cover.



4. Slide the cover down to expose the valve ports and disconnect the three air lines.



5. Loosen the jam nut and turn the valve and nut from gear shift lever. Remove the valve cover, air lines sheathing and O-rings from lever.

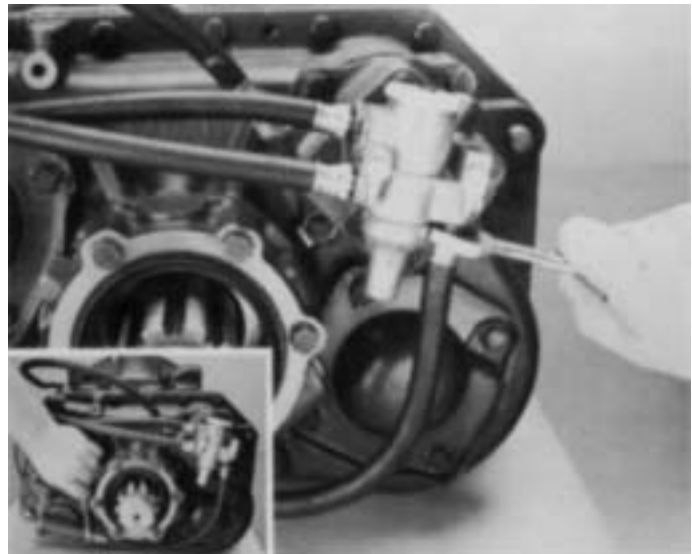

6. Disconnect and remove the 1/4" I.D. air line between Splitter Cylinder (inset) and air filter/regulator.

# DISASSEMBLY SHIFTING CONTROLS

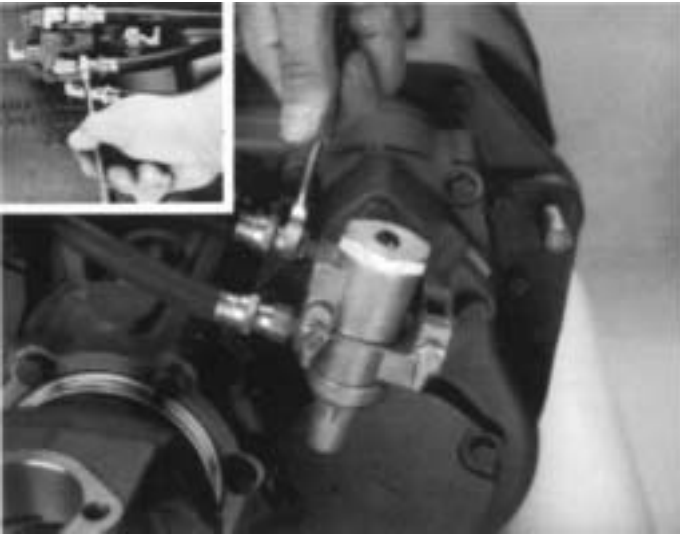

7. Disconnect and remove the 1/4" I.D. air hoses between the slave valve (inset) and air filter/regulator assembly and range cylinder assembly.

## B. Removal of Air Filter/Regulator Assembly



1. Turn out the two capscrews and remove the air filter/regulator assembly.

**NOTE:** For disassembly and reassembly of Air Filter/Regulator Assembly, see Page 23.

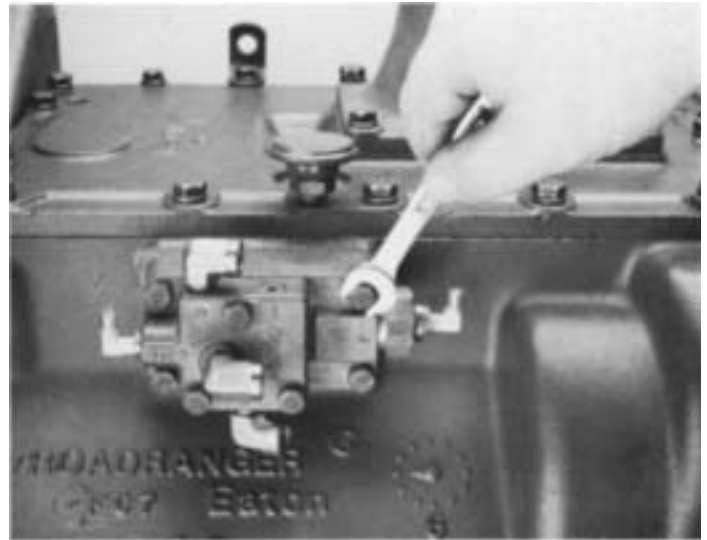

2. Turn out the four retaining capscrews and remove slave valve from transmission case.



3. Remove the hat-type alignment sleeve from bore in slave valve.

# DISASSEMBLY SHIFTING CONTROLS

---



4. Remove the spring and plunger pin from bore in transmission case. Remove slave valve gasket.

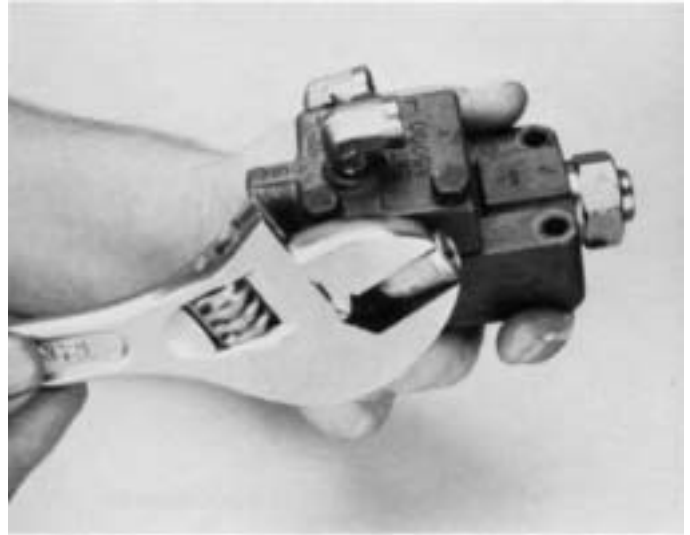

5. If necessary, remove the air line fittings from slave valve.

**NOTE:** For disassembly and reassembly of piston-type Slave Valve Assembly, see Page 23.

# DISASSEMBLY GEAR SHIFT LEVER ASSEMBLY

## A. Removal and Disassembly



1. Turn out the four retaining cap screws, jar lightly to break gasket seal and remove the gear shift lever housing and gasket from shift bar housing.

**NOTE:** Remote control housings are removed from shift bar housing in the same manner. For disassembly and reassembly of LRC Assemblies, see illustrated Parts List No. P-541. For disassembly and reassembly of SRC Assemblies, see illustrated Parts List No. P-515.

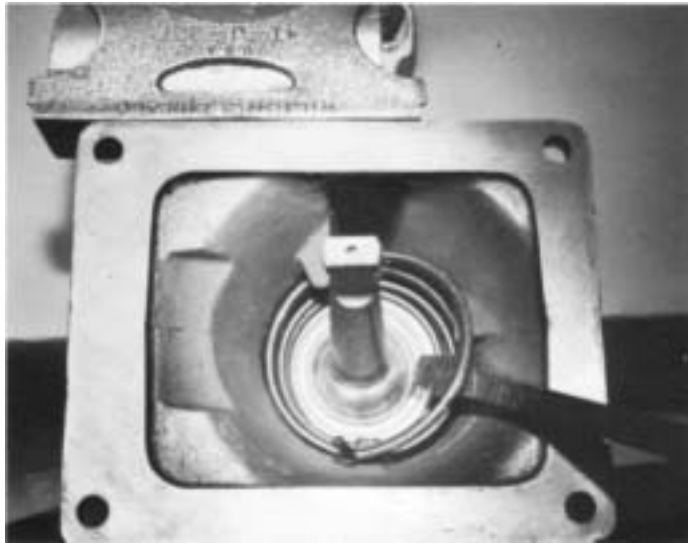

2. Remove the boot from gear shift lever and secure assembly in vise with bottom of housing up. Use a large screwdriver to twist between the spring and housing, forcing the spring from under the lugs in housing. Do one coil at a time.

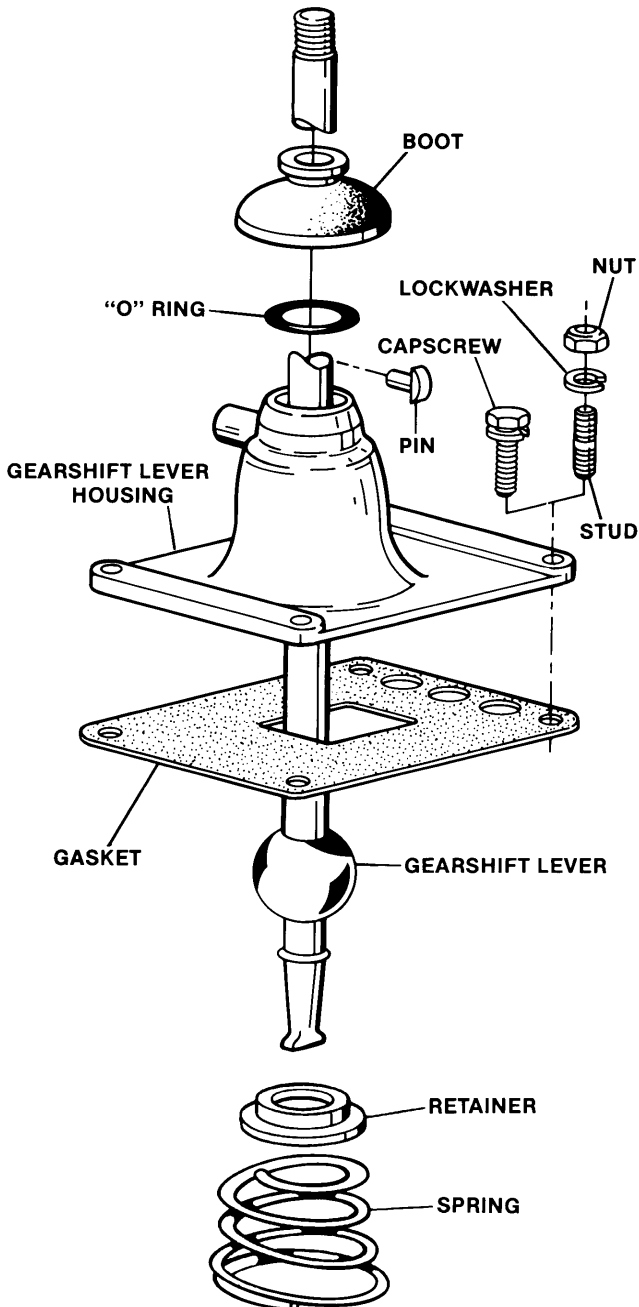

# REASSEMBLY GEAR SHIFT LEVER ASSEMBLY

## B. Reassembly of Gear Shift Lever Housing Assembly



3. Remove the tension spring, washer and gear shift lever from housing.

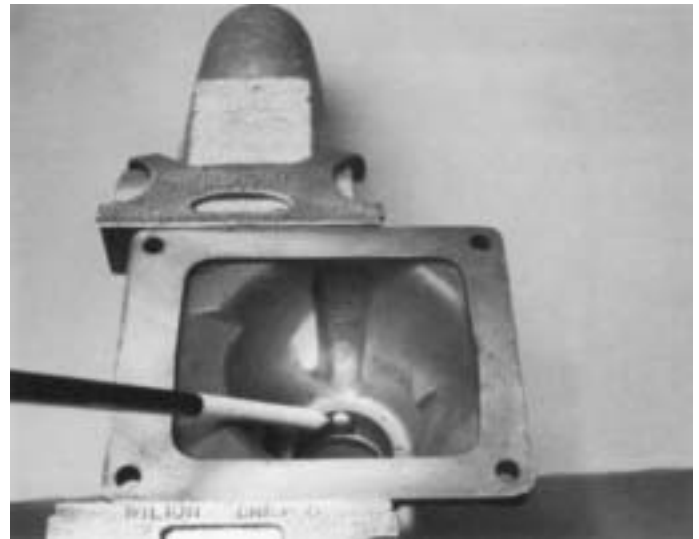

1. With the gear shift lever housing secured in vise as during disassembly, install the spade pin in bore of housing tower. If previously removed, install the O-ring in tower groove.

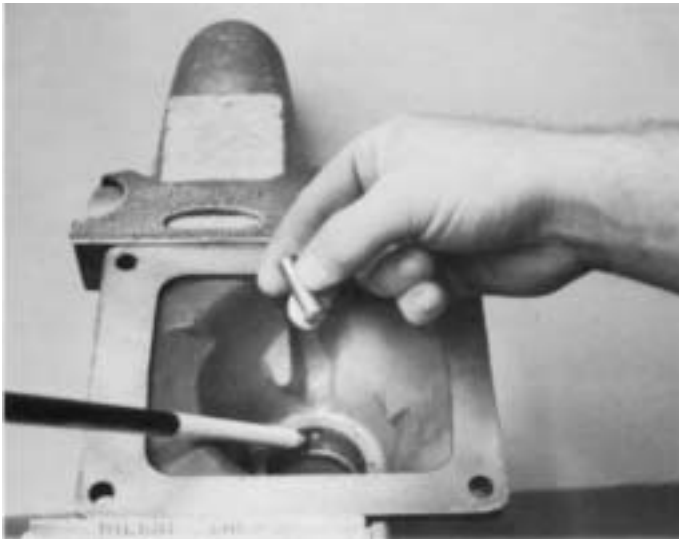

4. Remove the spade pin from bore in housing tower. If necessary, remove the O-ring from groove inside tower.



2. Position the gear shift lever in housing with spade pin in lever ball slot and install the tension spring washer over ball, dished-side up.

# REASSEMBLY GEAR SHIFT LEVER ASSEMBLY

---



3. Install the tension spring under lugs in housing, seating one coil at a time. Use of a spring driving tool is recommended.



4. Remove the assembly from vise and install the rubber boot over gear shift lever and against housing.



# DISASSEMBLY AND REASSEMBLY SHIFT BAR HOUSING

## SHIFT BAR HOUSING ASSEMBLY

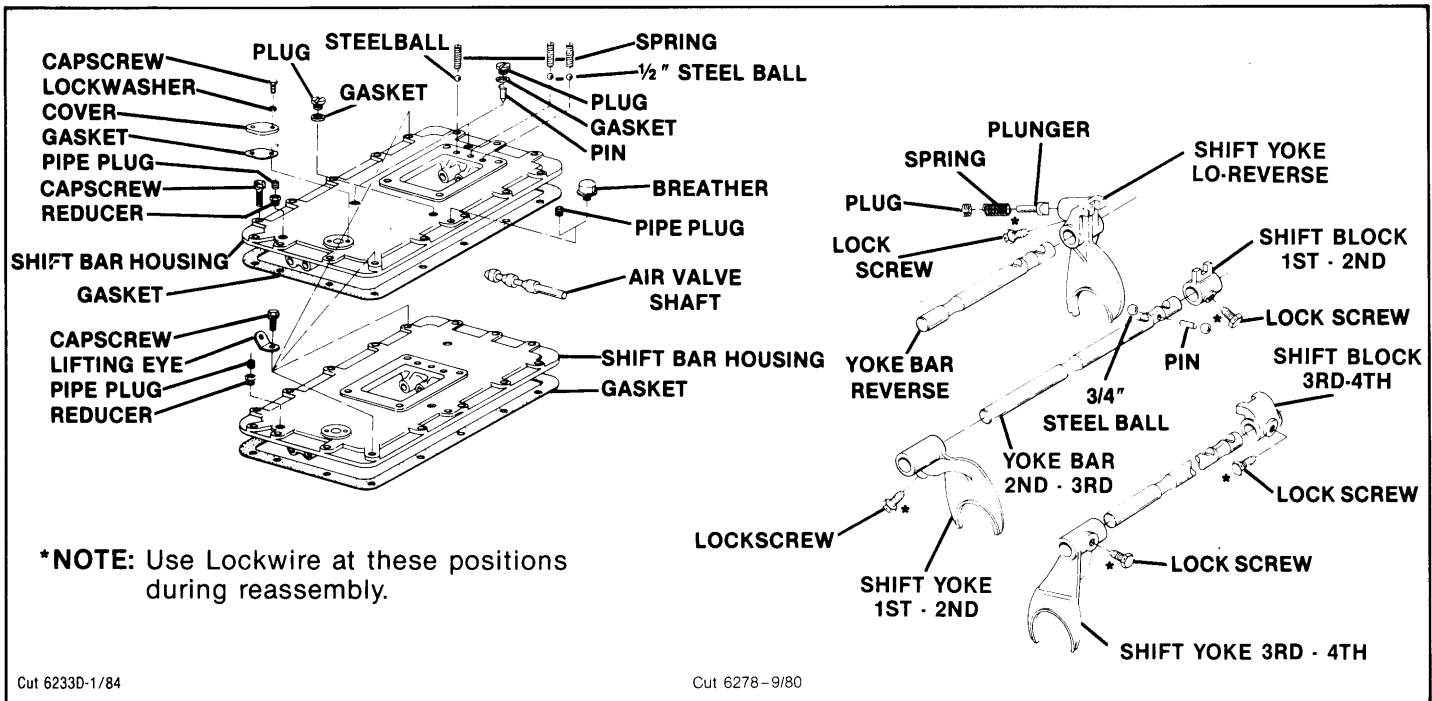

### A. Removal and Disassembly of the Shift Bar Housing Assembly

For models equipped with an Oil Pump and/or Cooler Assemblies, make sure to disconnect the lube line at the fitting on the shift bar housing before doing the following instructions.



Turn out the retaining capscrews. Jar the top to break the gasket seal and lift the shift bar housing from the transmission case. Remove the gasket.

**NOTE:** During disassembly, lay all parts on a clean bench in order of removal from the housing to make reassembly easier. Shift bars not being removed must be kept in the neutral position or the interlocking parts will lock the bars.



2. Tilt the assembly and remove the three sets of tension springs and balls from the housing bores.

# DISASSEMBLY AND REASSEMBLY SHIFT BAR HOUSING

---

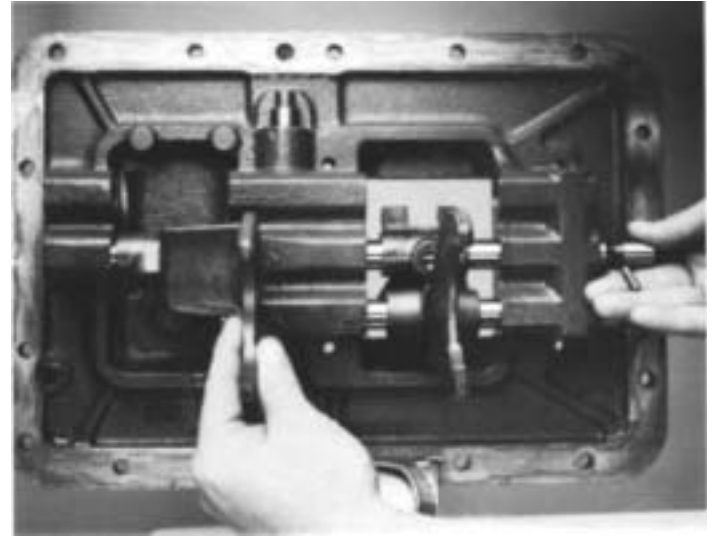
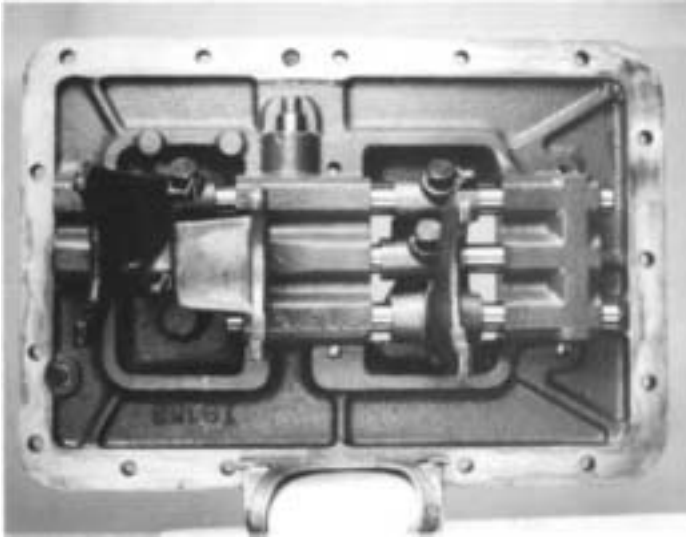

3. Secure the assembly in a vise with the plunger-side up. (The front of the housing will be to the left.) For models so equipped, cut the lockwire and turn out the retaining capscrews to remove the oil trough from the housing.

**NOTE:** Start with the upper shift bar, move all bars to the right and out the rear boss bore. Cut the lockwire and remove the lockscrews from each bar just before their removal.

5. Move the 1st-2nd speed shift bar to the housing rear, removing the yoke and block from the bar. As the neutral notch in the bar clears the rear boss, remove the small interlock pin from the bore.

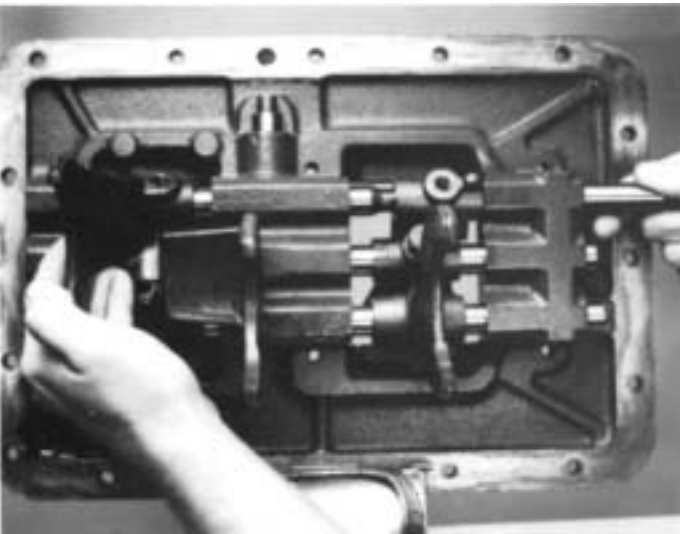

4. Move the 3rd-4th speed shift bar to the housing rear, removing the yoke and block from the bar.

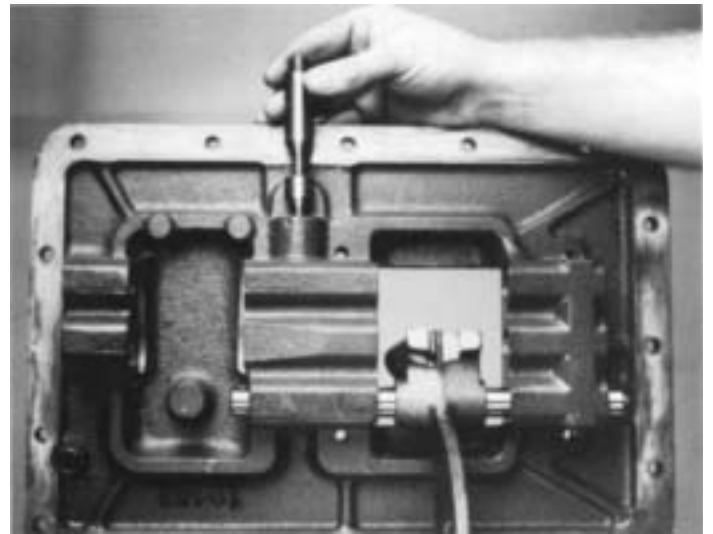

6. Remove the actuating plunger from the center boss bore.

# DISASSEMBLY AND REASSEMBLY SHIFT BAR HOUSING

## B. Reassembly of the Shift Bar Housing Assembly.

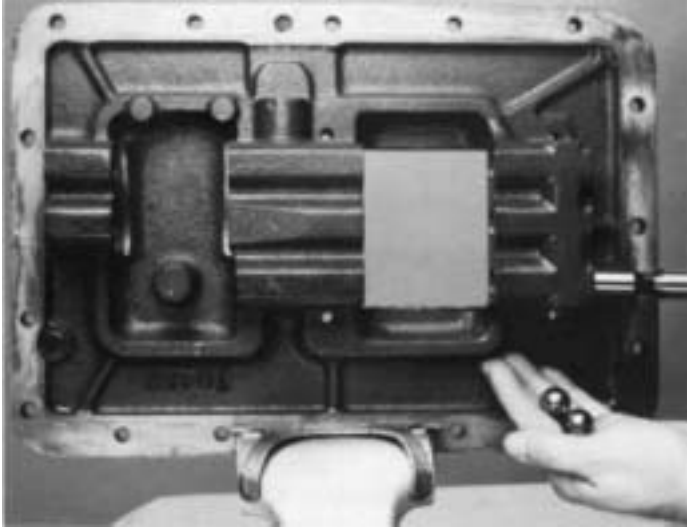

7. Move the short LO-Reverse speed shift bar to the housing rear, remove the yoke from the bar. As the shift bar is removed from the housing, two 3/4 in-terlock balls will drop from the rear boss bottom bore.



1. If previously removed, install the reverse-stop plunger in the LO-Reverse shift yoke, making sure the plunger is fully seated in the yoke slot bore.



8. If necessary, remove the plug, spring, and reverse-stop plunger from the LO-Reverse speed shift yoke bore.



2. Install the spring in the yoke bore and on the plunger shank.

# DISASSEMBLY AND REASSEMBLY SHIFT BAR HOUSING



3. Install the plug and tighten to compress the spring (left). Back the plug out 1 - 1 1/2 turns and stake the plug through the small hole in the yoke (right.)

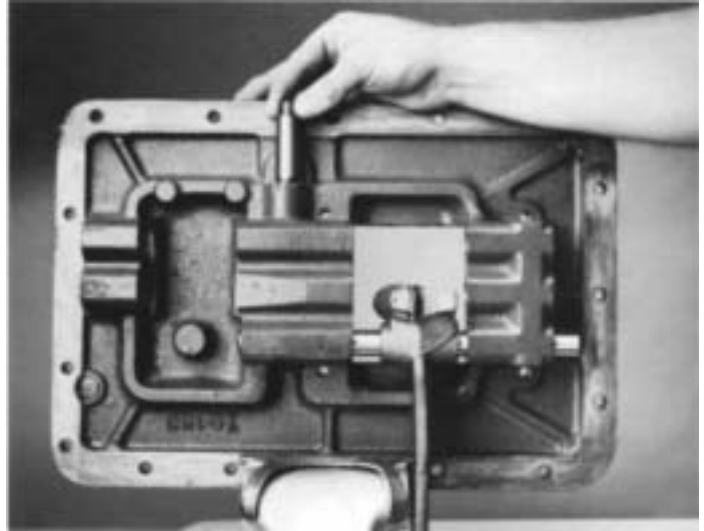

5. While holding the plunger shank, install the actuating plunger in the center boss bore.



4. Secure the shift bar housing in a vise. Hold the notched-end of the short LO-Reverse speed shift bar, install the bar in the lower bore of the shift bar housing bosses. Install the yoke lockscrew, tighten and wire securely.

**NOTE:** Start with the lower shift bore of the rear boss and move to the left (front of the housing). Keep bars in the neutral position during installation. DO NOT EXCEED the recommended torque ratings for the yoke lockscrews as over-tightening may distort the shift bars.

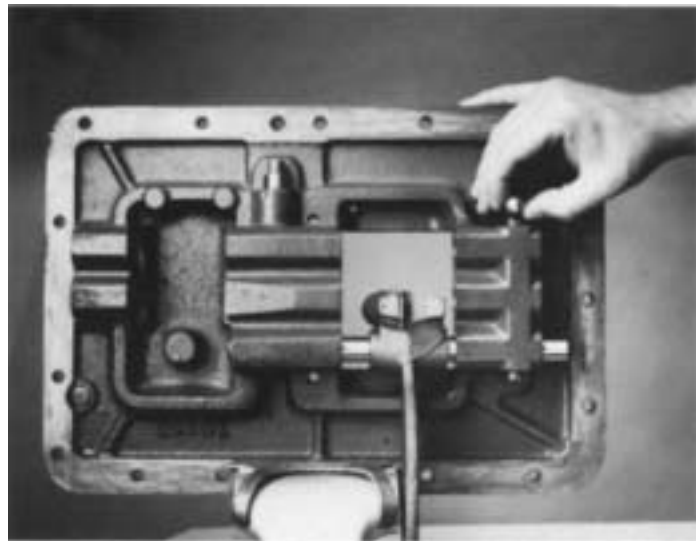

6. Install one 3/4" interlock ball in the rear boss top bore. This ball rides between LO-Reverse and 1st-2nd speed shift bars.

# DISASSEMBLY AND REASSEMBLY SHIFT BAR HOUSING

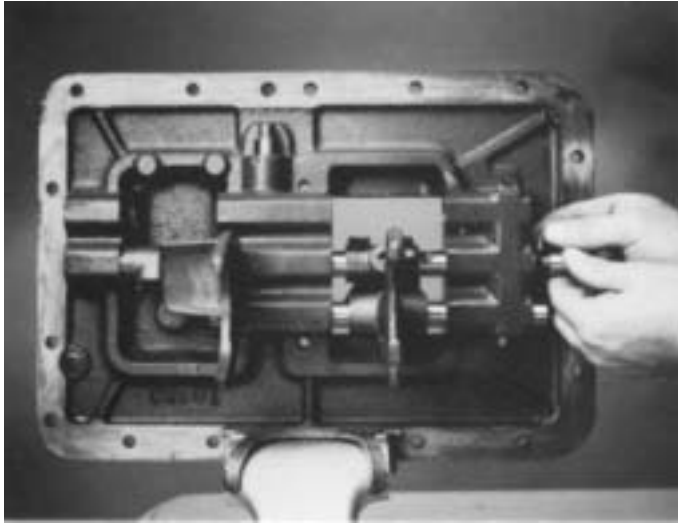

7. While holding the notched-end of the bar, install the 1st-2nd speed shift bar in the housing boss middle bore. Position the shift block on the bar between the center and rear bosses, and the yoke on the bar between the front and center bosses, long hub to the housing front. Just before inserting the notched-end of the rear boss bar, install the small interlock pin VERTICALLY in the neutral notch bore. Install the block and yoke lockscrews, tighten, and lockwire securely.

**NOTE:** It is necessary that the interlock pin remain in a vertical position during reassembly as rotation of the bar causes the pin to jam in the tension spring bores.

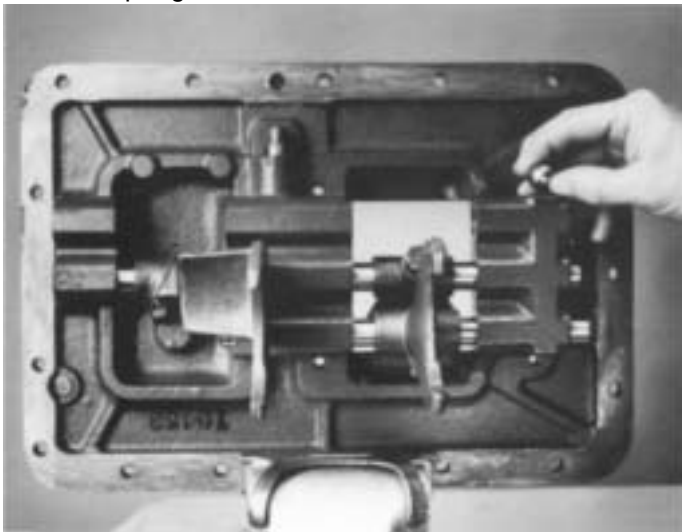

8. Install the other 3/4" interlock ball in the rear boss top bore. This ball rides between the 1st-2nd and the 3rd-4th speed shift bars.

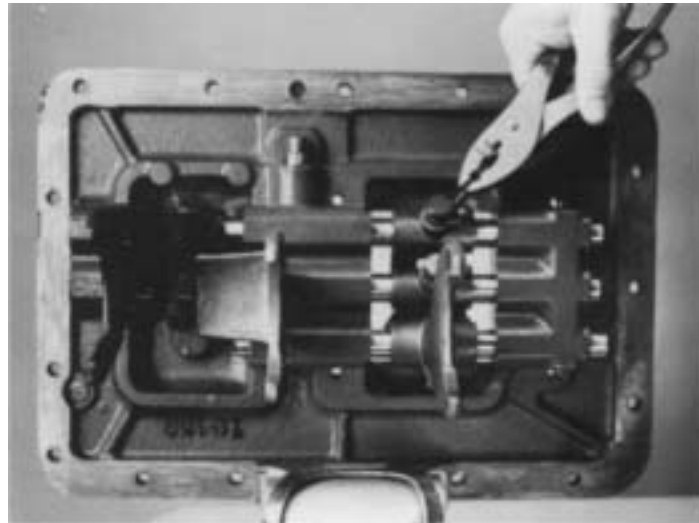

9. While holding notched-end of the bar, install the 3rd-4th speed shift bar in the housing boss upper bore, position the shift block on the bar between the front and center bosses, long hub to the housing rear. Install the block and yoke lockscrews, tighten, and lockwire securely.
10. For models so equipped, install the oil trough on the housing. Tighten the capscrews and lockwire securely.

# DISASSEMBLY AND REASSEMBLY SHIFT BAR HOUSING

---

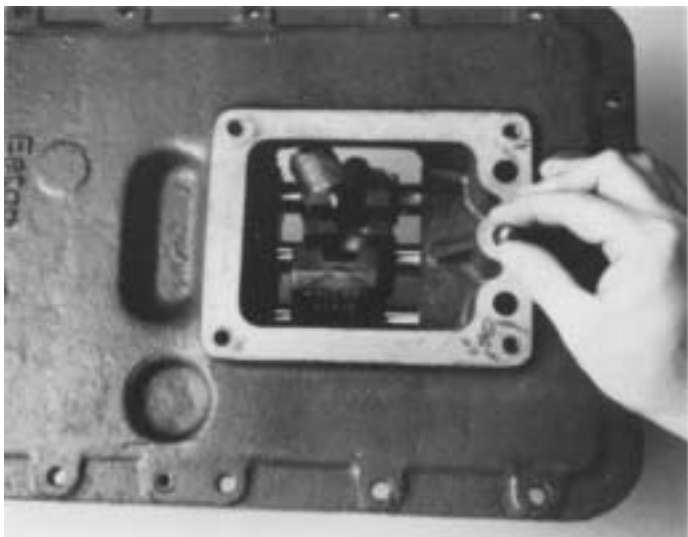

**11.** Remove the assembly from the vise. Install the three tension balls, one in each bore on the housing top.



**12.** Install the three tension springs, one over each ball in the housing bores.

# REMOVAL - OUTPUT YOKE, AUXILIARY SECTION, AND CLUTCH HOUSING

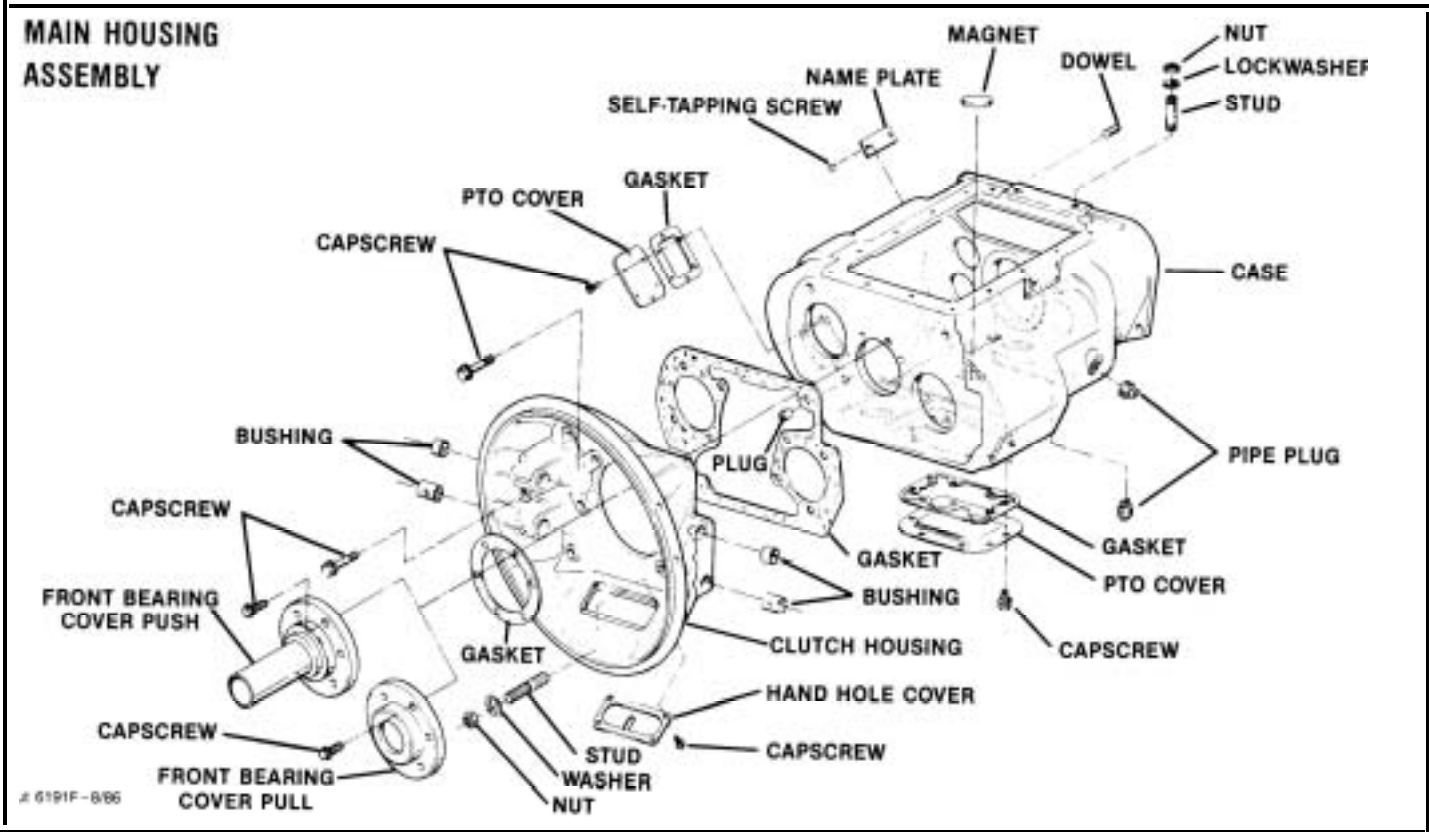

## A. Removal Output Yoke



1. Lock transmission by engaging two mainshaft gears with the mainshaft sliding clutches (inset.) Use a large breaker bar to turn the output shaft nut from the output shaft.



2. Pull yoke straight to the rear and off the output shaft.

# REMOVAL - OUTPUT YOKE, AUXILIARY SECTION, AND CLUTCH HOUSING

## B. Removal of Auxiliary Section



1. Turn out the nineteen cap screws that attach the two sections.

**NOTE:** There are three lengths of cap screws, note their location.

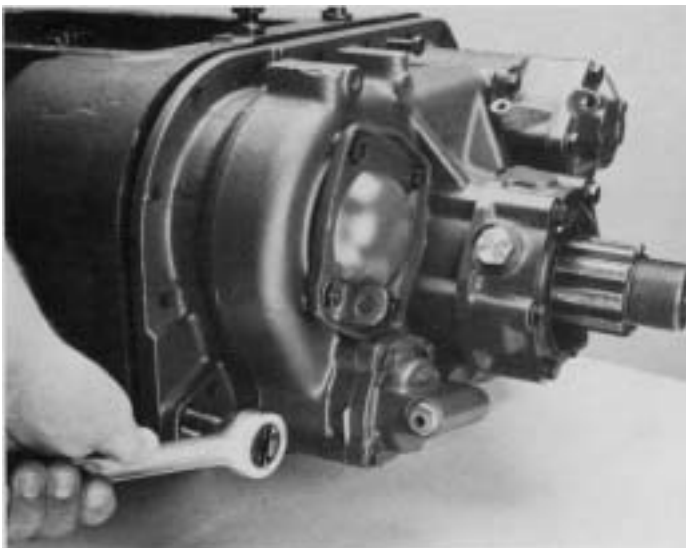

2. Insert three cap screws in the tapped holes of housing flange. Tighten evenly to move auxiliary section to the rear and just far enough from front section to break gasket seal.

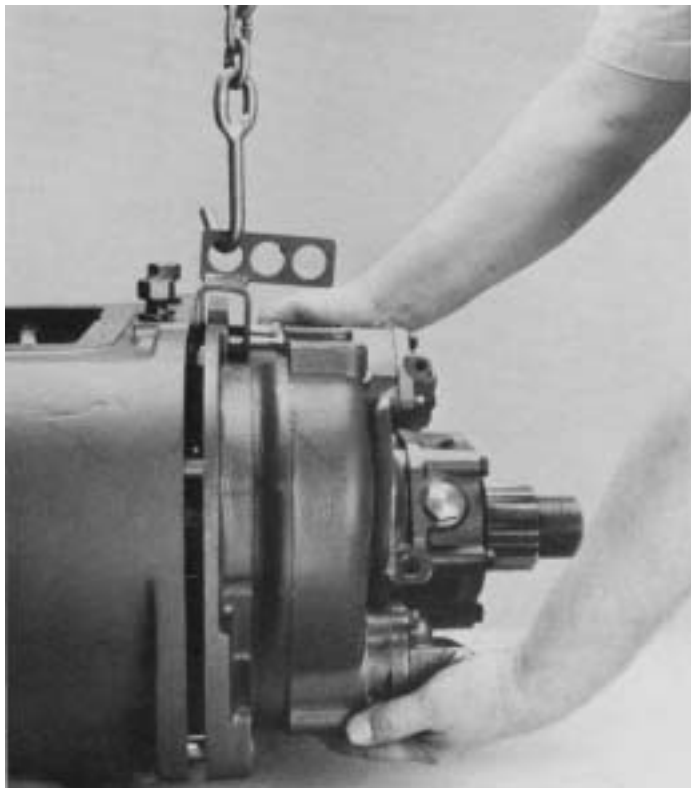

3. Remove cap screws and attach a chain hoist to auxiliary section. Move the assembly to the rear until free of front section and remove gasket.

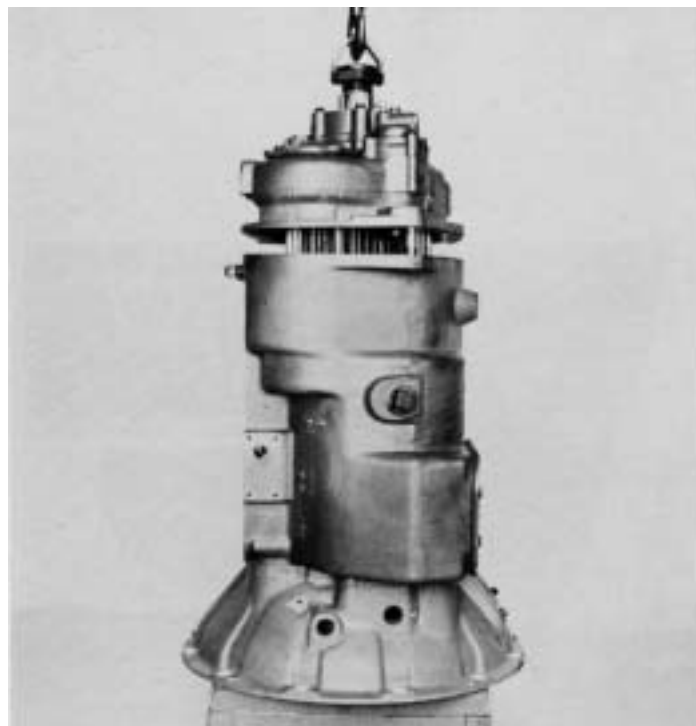

4. The auxiliary section can also be removed with the transmission set in the vertical position. Block under the clutch housing to prevent damage to the input shaft. Remove the retaining cap screws from the housing flange. Lift the assembly from the front section. Remove the gasket.



# REMOVAL - OUTPUT YOKE, AUXILIARY SECTION, AND CLUTCH HOUSING

---

## D. Removal Clutch Housing

**NOTE:** For models so equipped remove the clutch release mechanism and/or clutch brake assembly.

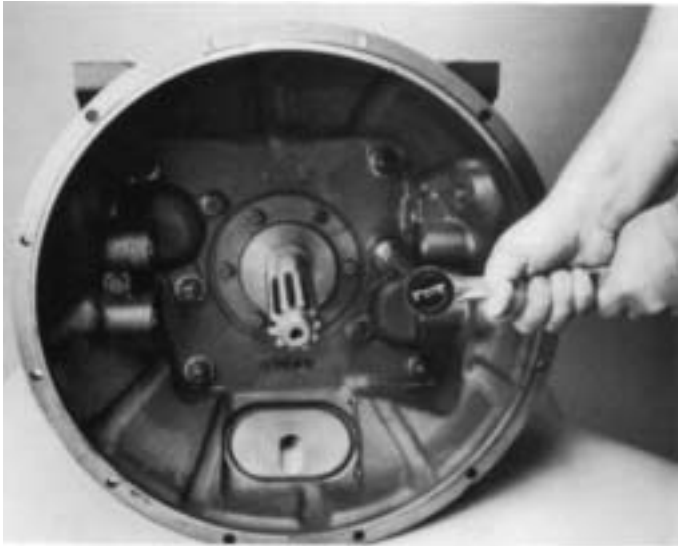

1. Remove the six capscrews, six nuts, and six lock-washers from studs that secure the clutch housing to transmission case.

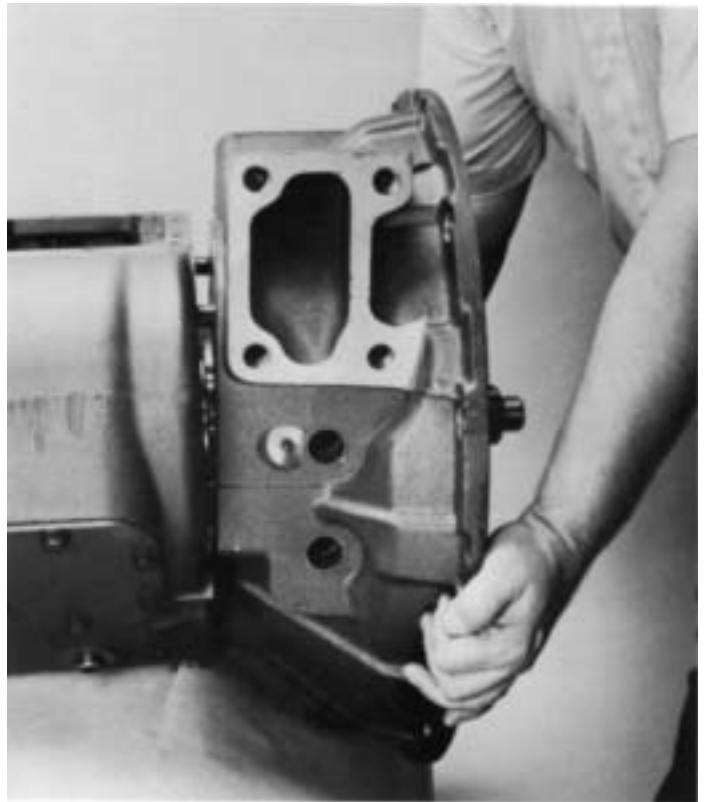

2. Jar the clutch housing with a rubber mallet to break gasket seal and pull from transmission case. Remove gasket.

# DISASSEMBLY - AUXILIARY SECTION

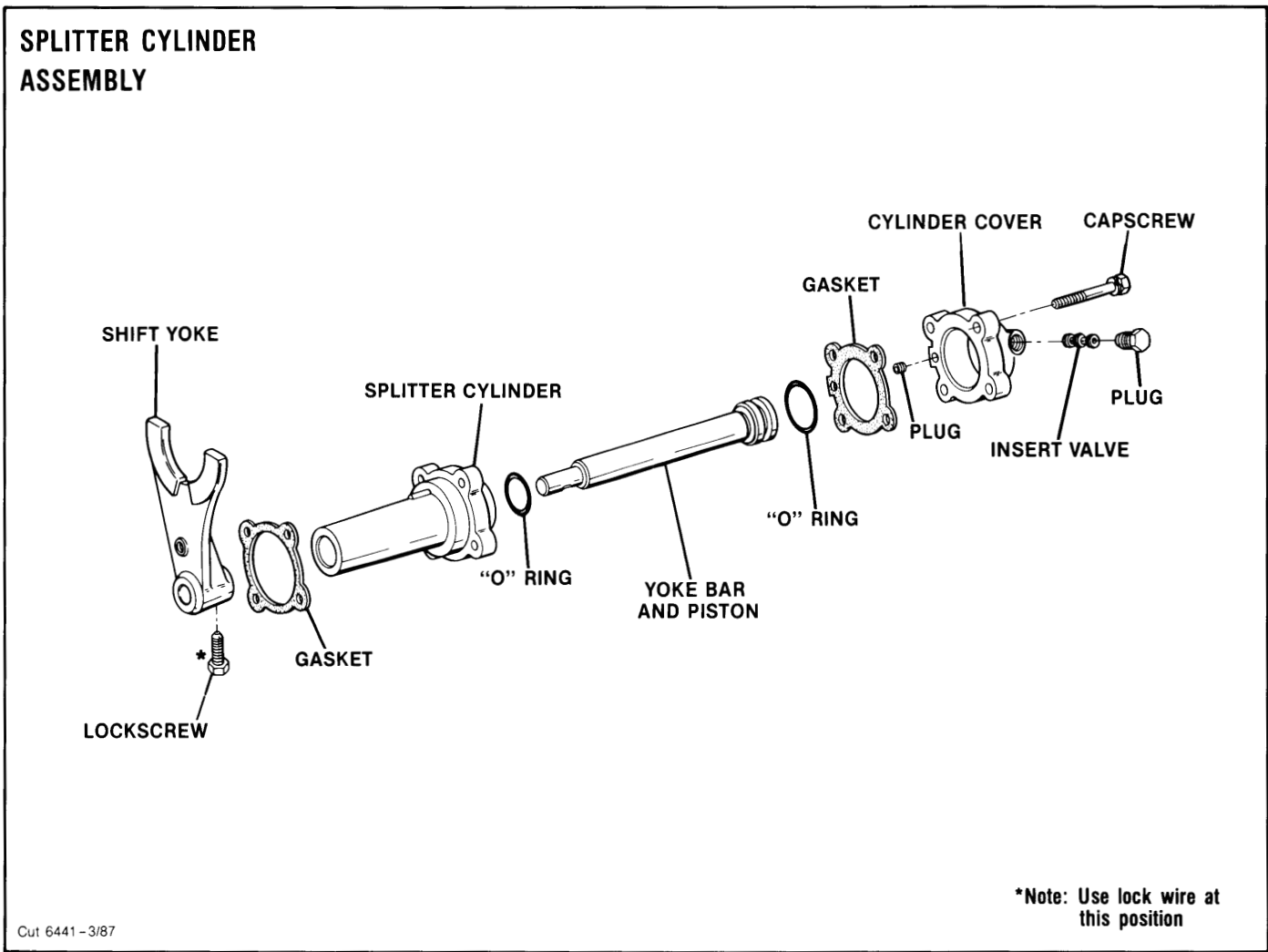

## A. Removal and Disassembly Rear Auxiliary Drive Gear and Yoke



1. Cut the lockwire on the splitter yoke retaining bolt and loosen the bolt.



2. Remove the retaining bolt, splitter yoke and sliding clutch assembly from the auxiliary section.

# DISASSEMBLY - AUXILIARY SECTION

## AUXILIARY MAINSHAFT ASSEMBLY

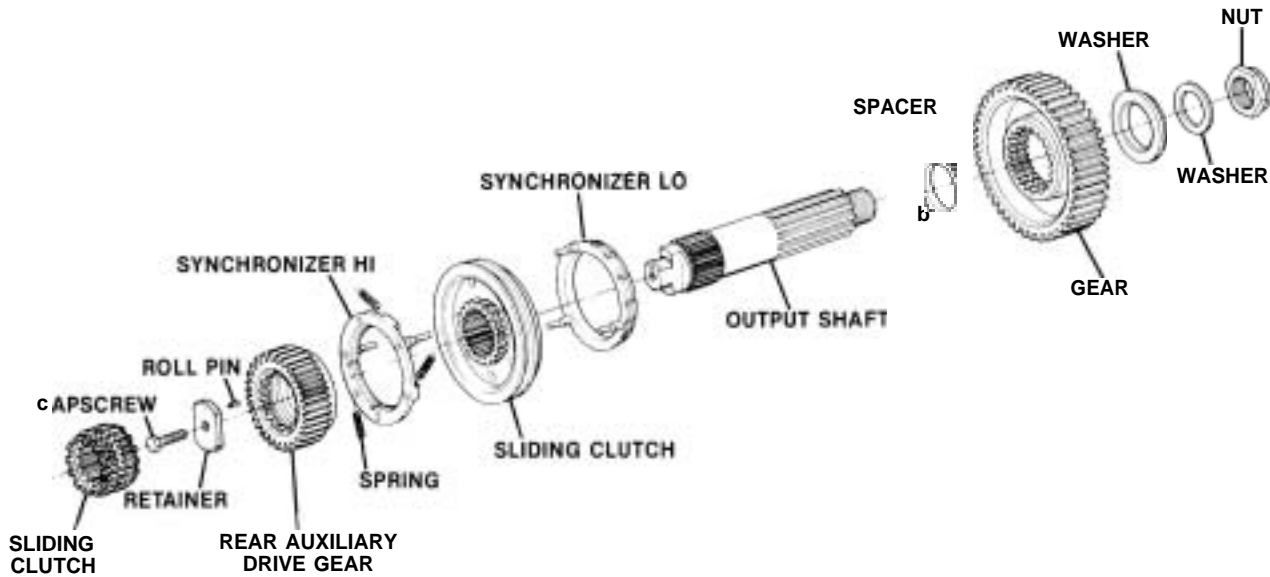

Cut 6593 L-4/87

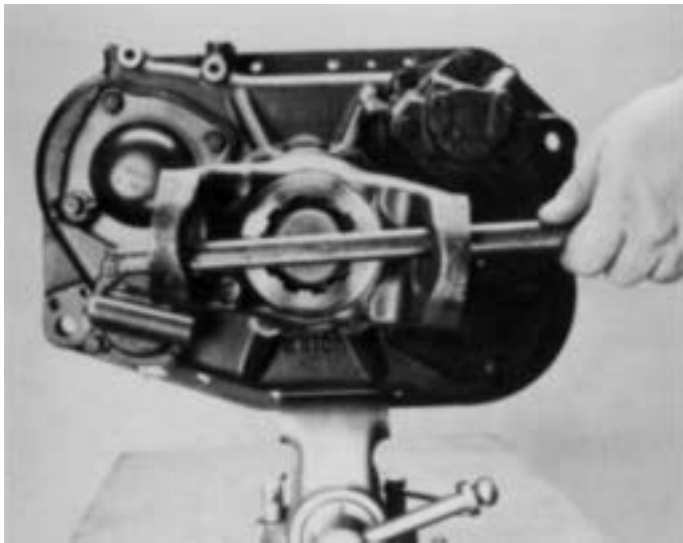

3. Temporarily install an output yoke on the output shaft and secure it by placing a bar through the yoke.

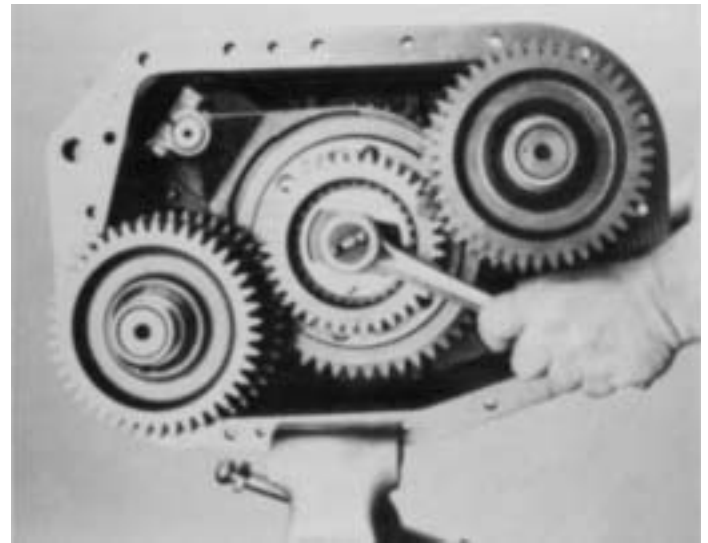

4. Break loose the 15/16" retaining cap screw on the front of the output shaft.

# DISASSEMBLY - AUXILIARY SECTION

## AUXILIARY COUNTERSHAFT ASSEMBLY

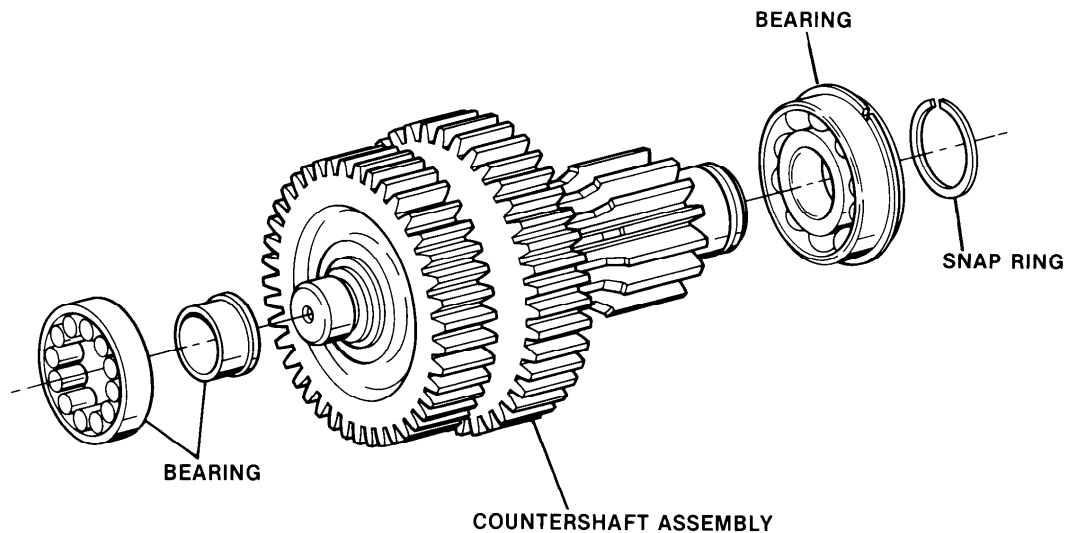

### B. Removal of Auxiliary Countershafts

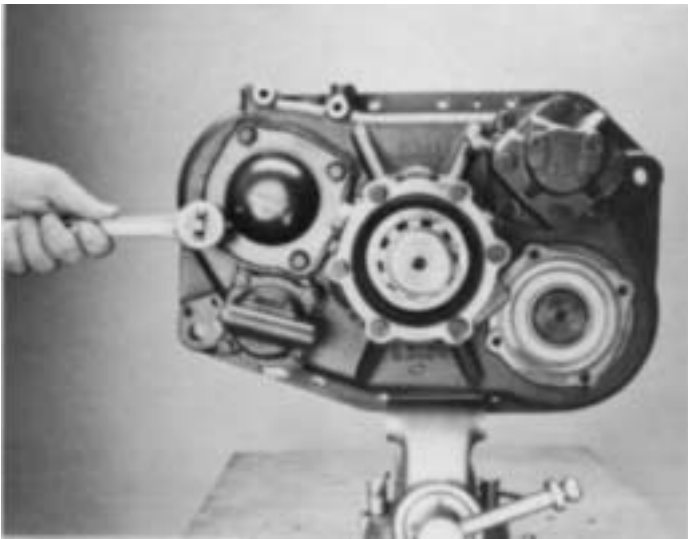

1. Remove the eight cap screws and countershaft bearing covers.

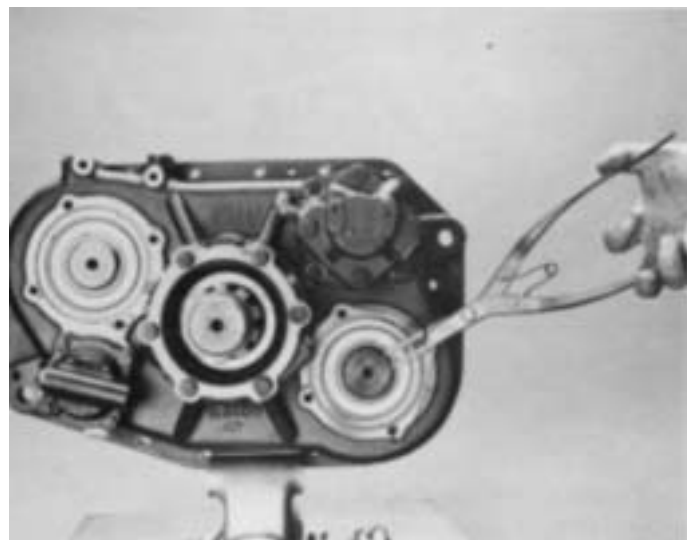

2. Remove snap rings from rear of both auxiliary countershafts.

# DISASSEMBLY - AUXILIARY SECTION

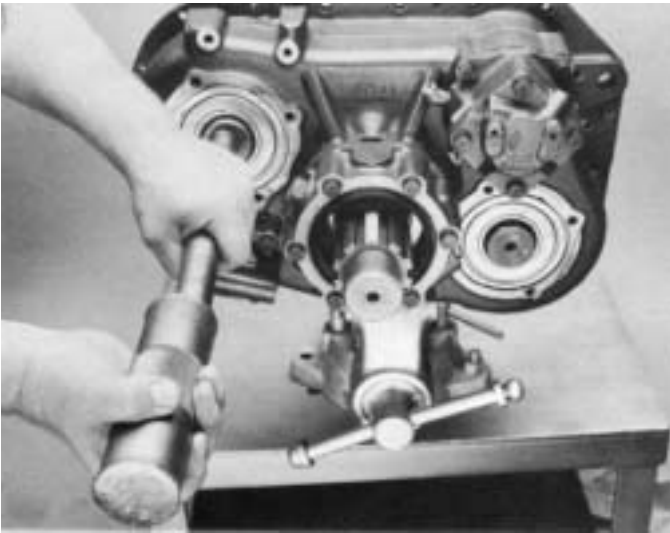

3. Use a soft bar and maul to drive the countershaft forward far enough to partially unseat the rear bearings.

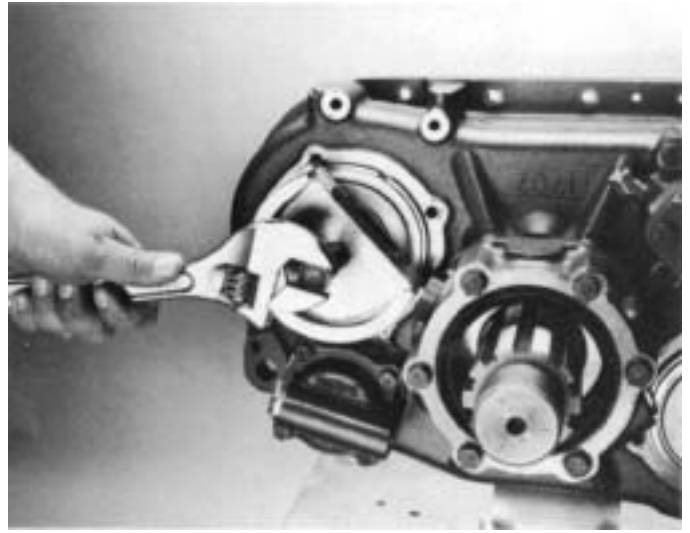

5. Use a bearing puller to remove bearings from countershaft.

**CAUTION** Countershafts will fall as bearings are removed.

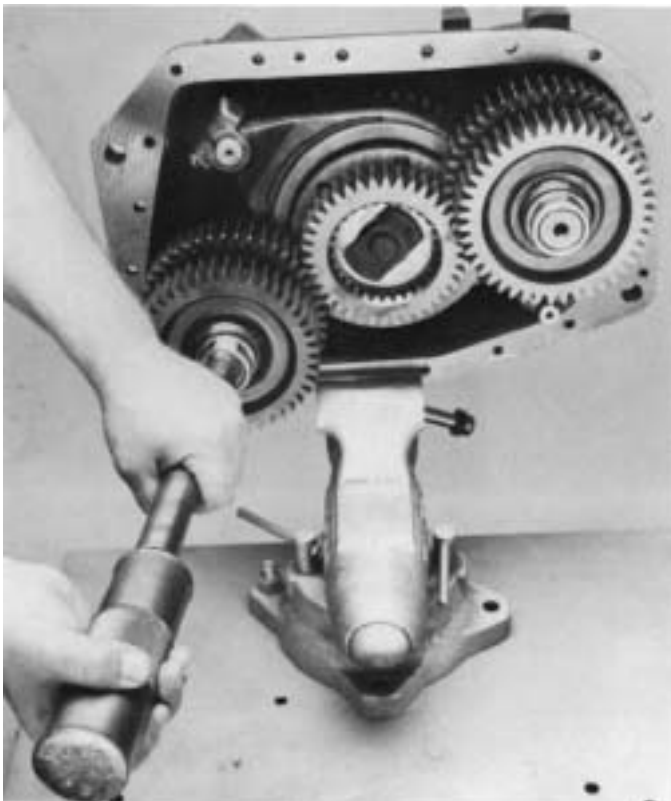

4. Drive the countershaft to the rear to expose the bearing snap rings, but use caution so as not to damage the bearing inner race on each countershaft front.

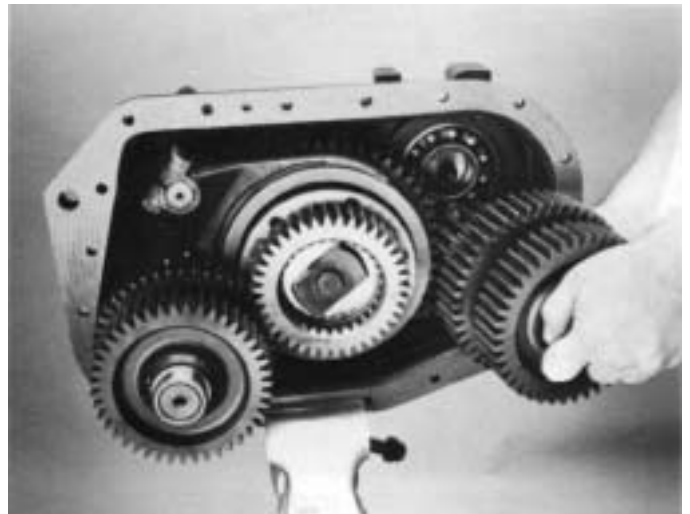

6. Remove auxiliary countershaft from auxiliary sec-

# DISASSEMBLY - AUXILIARY SECTION

## C. Removal Rear Auxiliary Drive Gear Assembly

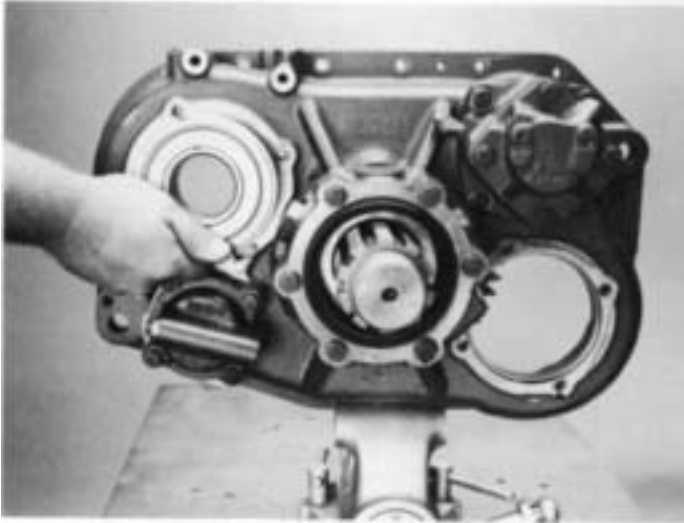

7. Remove the bearings from the countershaft rear bearing bores.

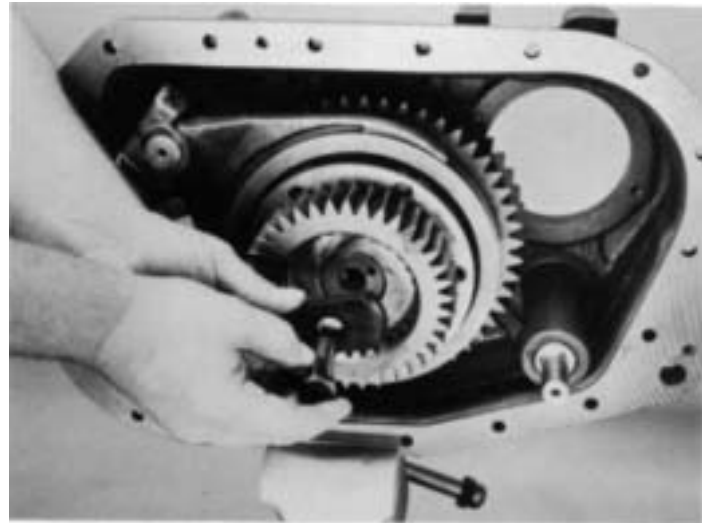

1. Remove the 15/16" cap screw and retainer that holds the rear auxiliary drive gear on the output shaft.



8. If necessary, secure the assembly in a vise and remove the bearing inner race from countershaft front with jaw pullers.

**NOTE:** The vise used should be equipped with brass jaws or wood blocks to prevent damage to the countershaft.

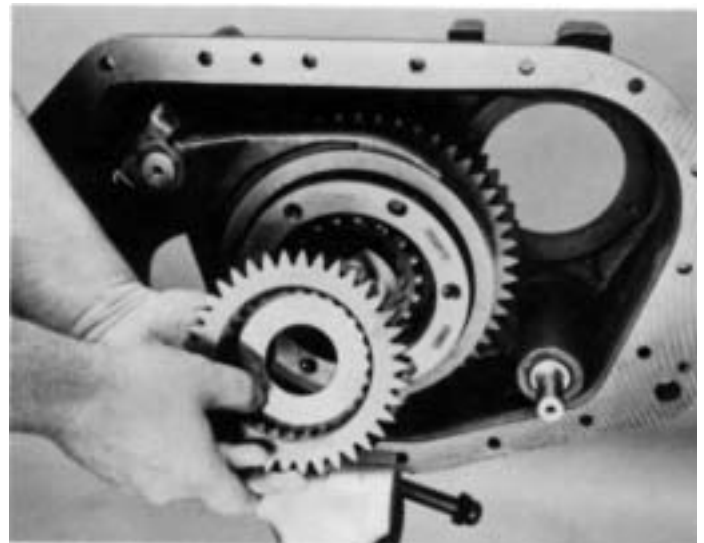

2. Remove the rear auxiliary drive gear from the output shaft.

# DISASSEMBLY - AUXILIARY SECTION

## RANGE CYLINDER ASSEMBLY

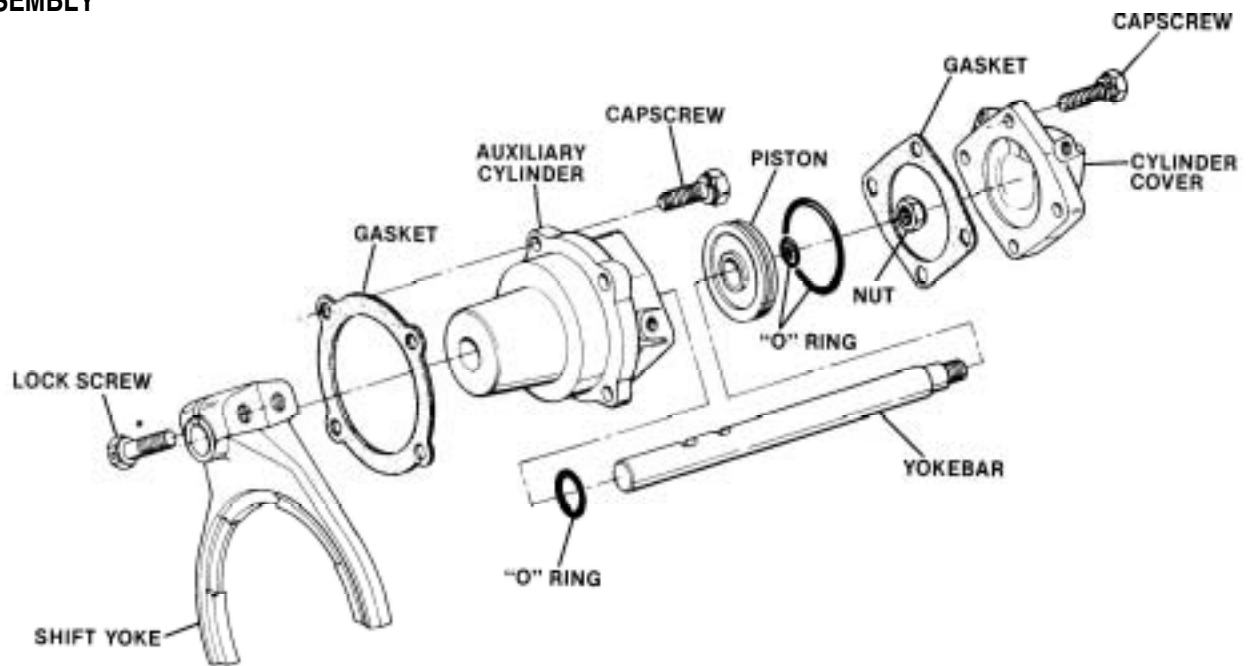

Cut 6427-5/83

\*Note: Use lockwire at this position

### D. Removal and Disassembly of Range Cylinder Assembly.

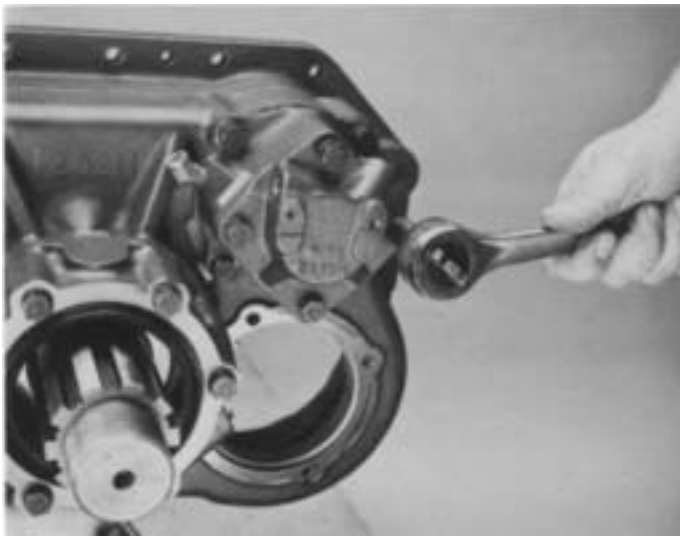

1. Remove the capscrews, range cylinder cover, and gasket.

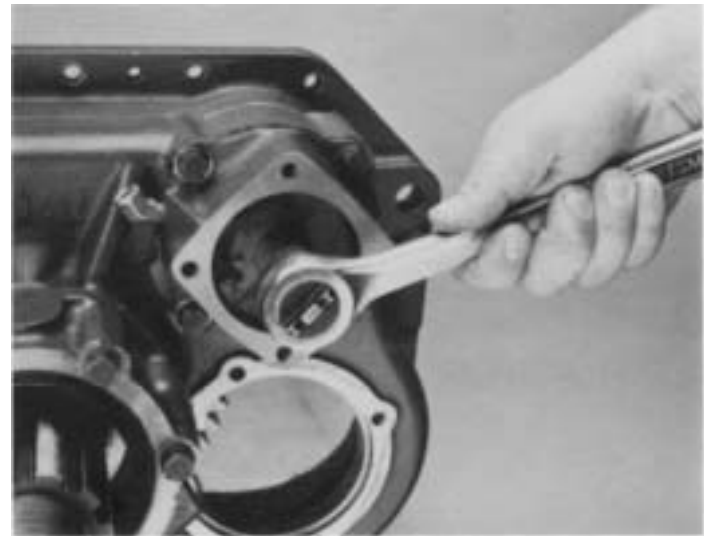

2. Remove nut from yoke bar.

# DISASSEMBLY - AUXILIARY SECTION

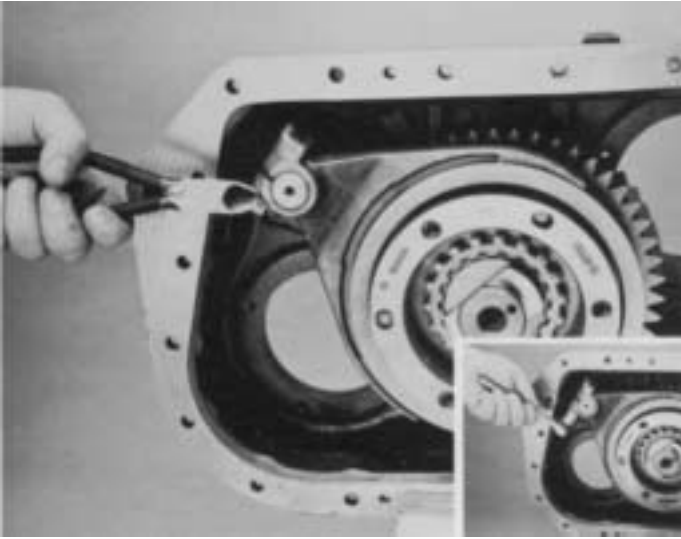

3. Cut the lockwire. Remove the two 3/4" yoke lock-screws (inset).

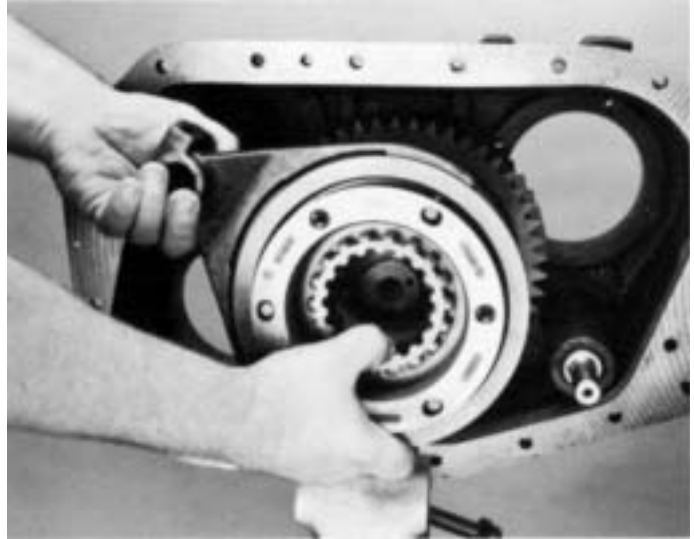

5. Remove the shift yoke and synchronizer assembly from output shaft.

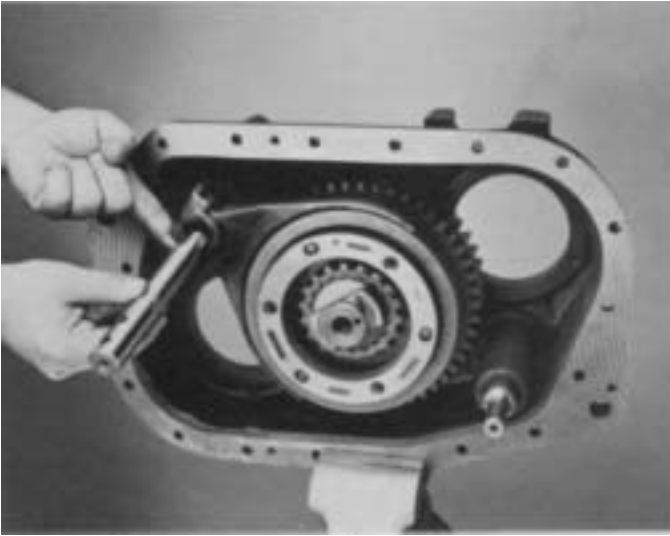

4. Pull the yoke bar from the cylinder housing bore.

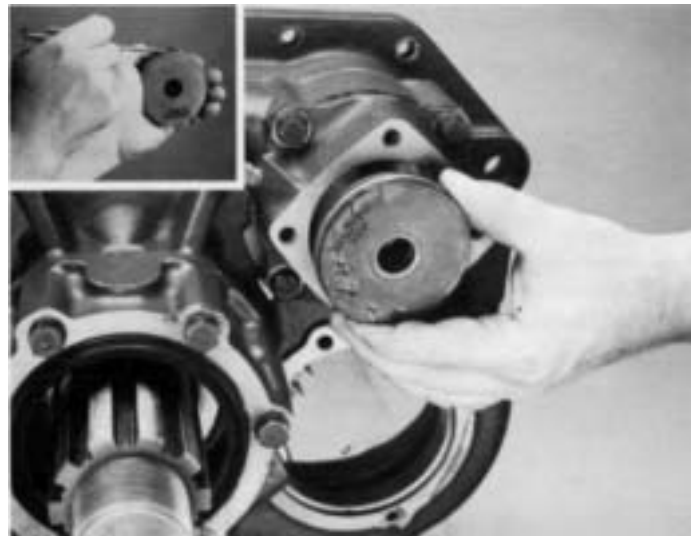

6. Remove the range piston from the cylinder bore. If necessary, remove the O-rings from the position I.D. and O.D. (inset).



# DISASSEMBLY - AUXILIARY SECTION

---

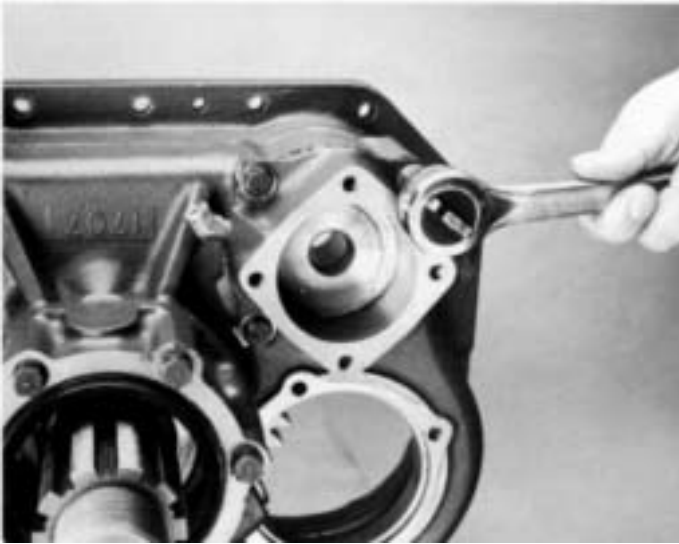

7. Remove capscrews and range cylinder housing.

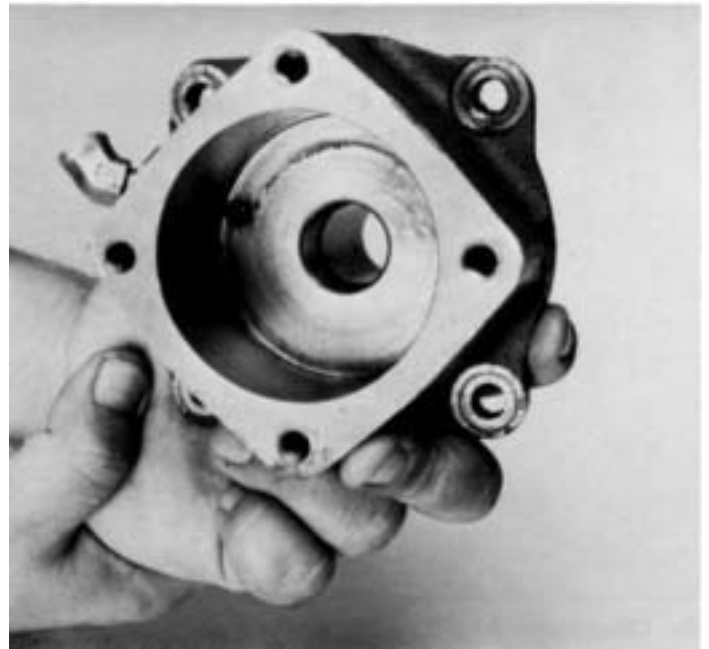

8. If necessary, remove the small O-ring from the range cylinder housing bore.

# DISASSEMBLY - AUXILIARY SECTION

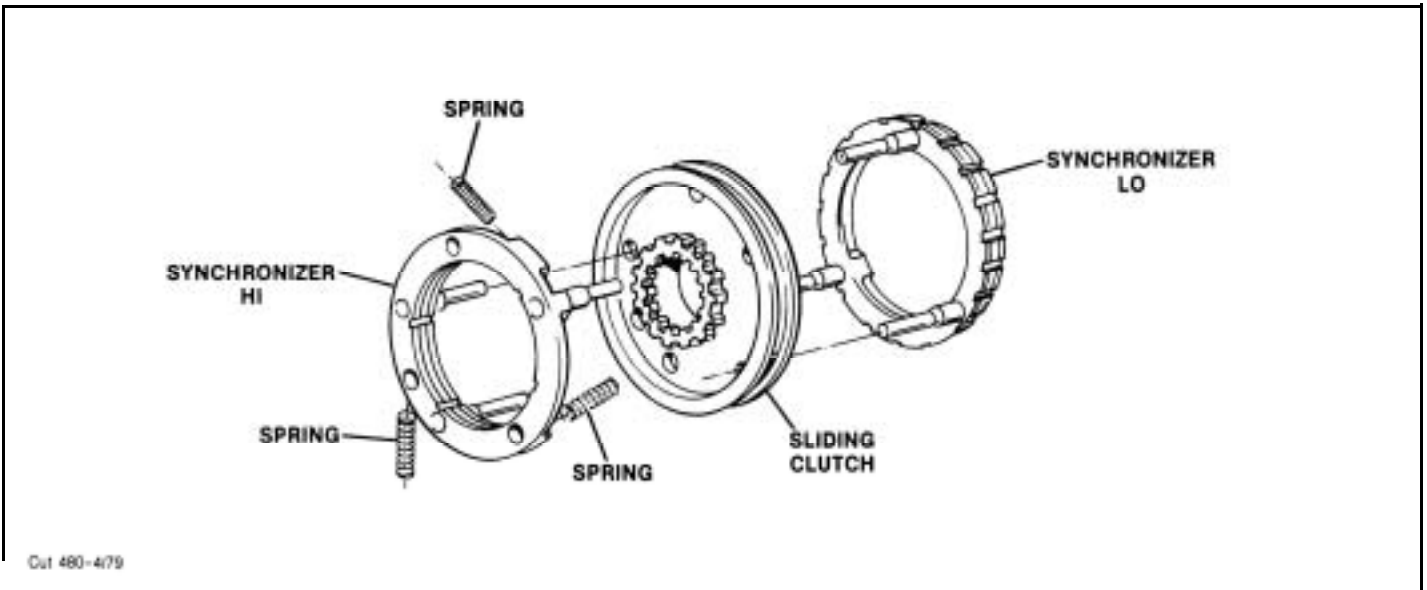

## E. Disassembly Synchronizer Assembly

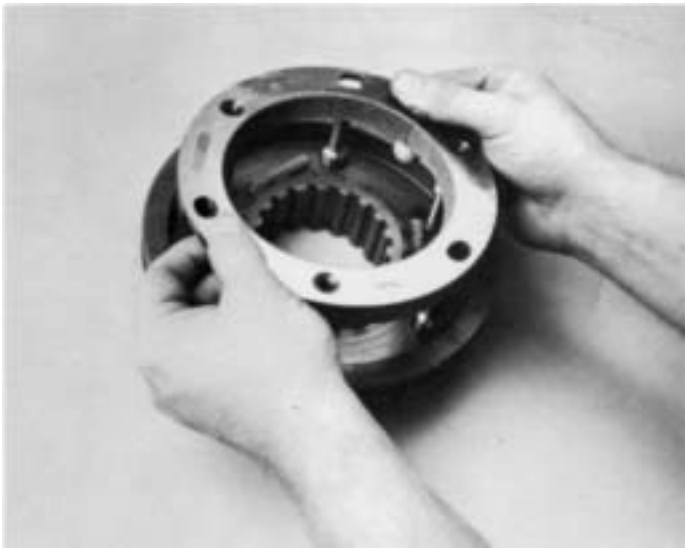

1. Place the larger LO range synchronizer ring on the bench. Cover the assembly with a shop rag to prevent losing the three springs released from the high range synchronizer at the pin locations. Pull the HI range synchronizer from the blocker pins.



2. Remove the sliding clutch from the synchronizer ring LO range pins.

# DISASSEMBLY-AUXILIARY SECTION

## F. Removal and Disassembly Output Shaft and Rear Bearing Assemblies.



1. Use a soft bar and maul to drive the output shaft forward and through the rear bearing assembly.



2. Remove the bearing inner spacer from the output shaft.



3. Use the front face of the reduction gear as a base, press the output shaft through the bearing and gear. This frees the bearing, LO range gear, and the splined washer.



4. Remove the stepped washer, LO range gear, and splined washer from the shaft.

# DISASSEMBLY - AUXILIARY SECTION

## G. Removal Splitter Cover

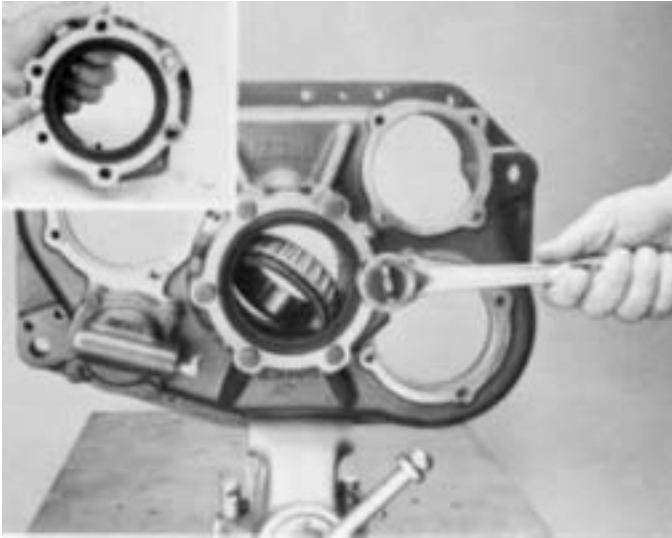

5. Remove the rear bearing retaining cap screws, rear bearing cover, and gasket from the auxiliary housing. The rear bearing cone drops from the housing bore when the cover is removed. If necessary, remove the oil seal from the cover (inset).

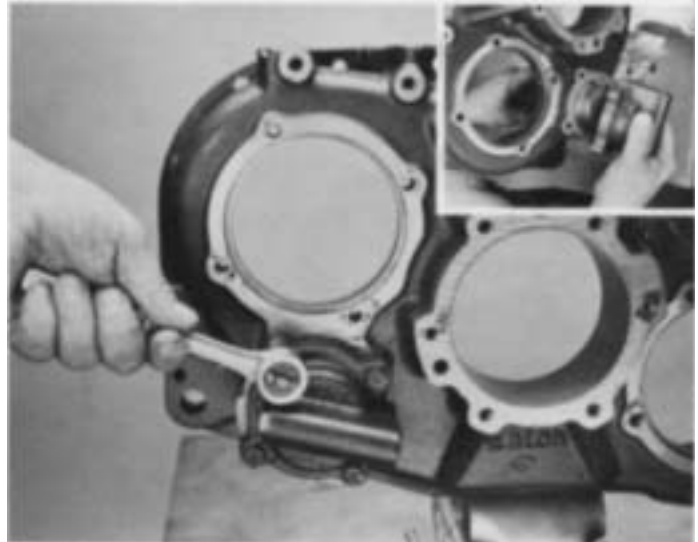

1. Remove the cap screws from the splitter cylinder cover and remove the splitter cylinder cover and gasket from the auxiliary section case.



6. Remove the two bearing cups and spacer from the bearing bore.



2. If necessary, turn out the insert valve retaining nut and remove insert valve from bore.

# DISASSEMBLY,,AUXILIARY SECTION

---

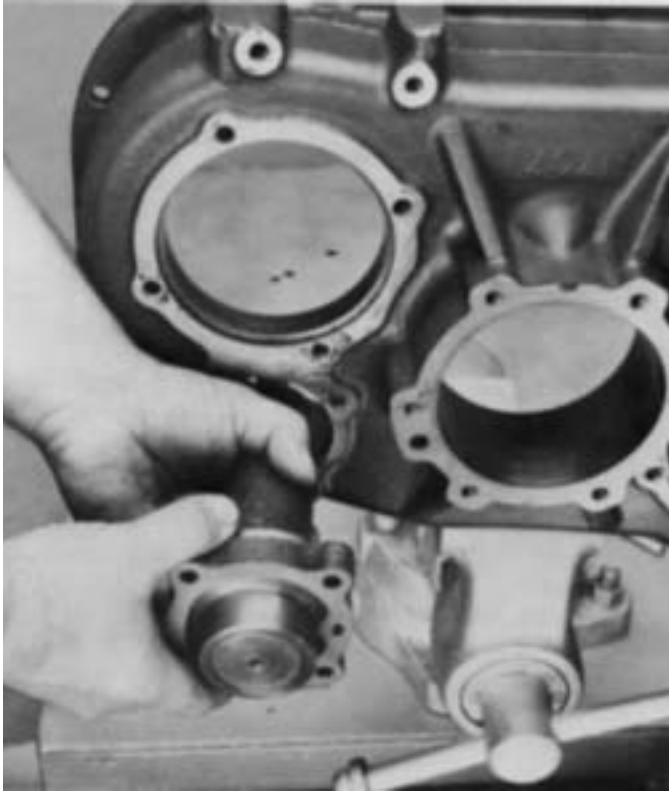

3. Remove the splitter cylinder housing and yoke bar from the auxiliary housing.

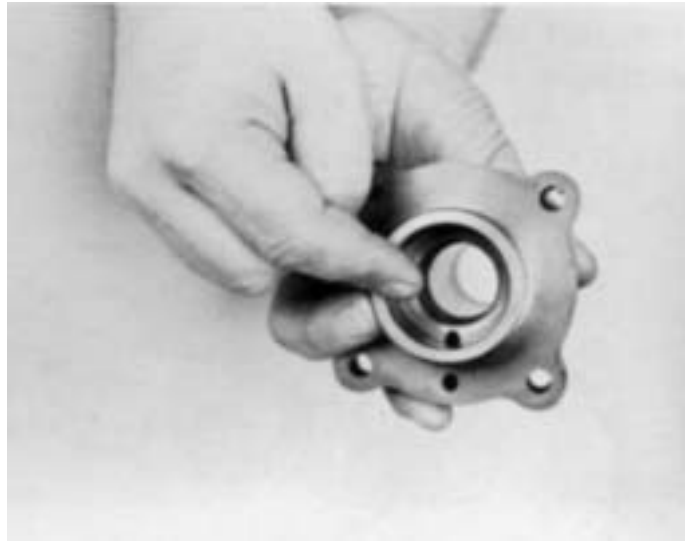

5. If necessary, remove the small O-ring from the cylinder housing bore.



4. Pull the yoke bar from cylinder housing. If necessary, remove the O-ring from piston O.D. (inset).

# REASSEMBLY-AUXILIARY SECTION

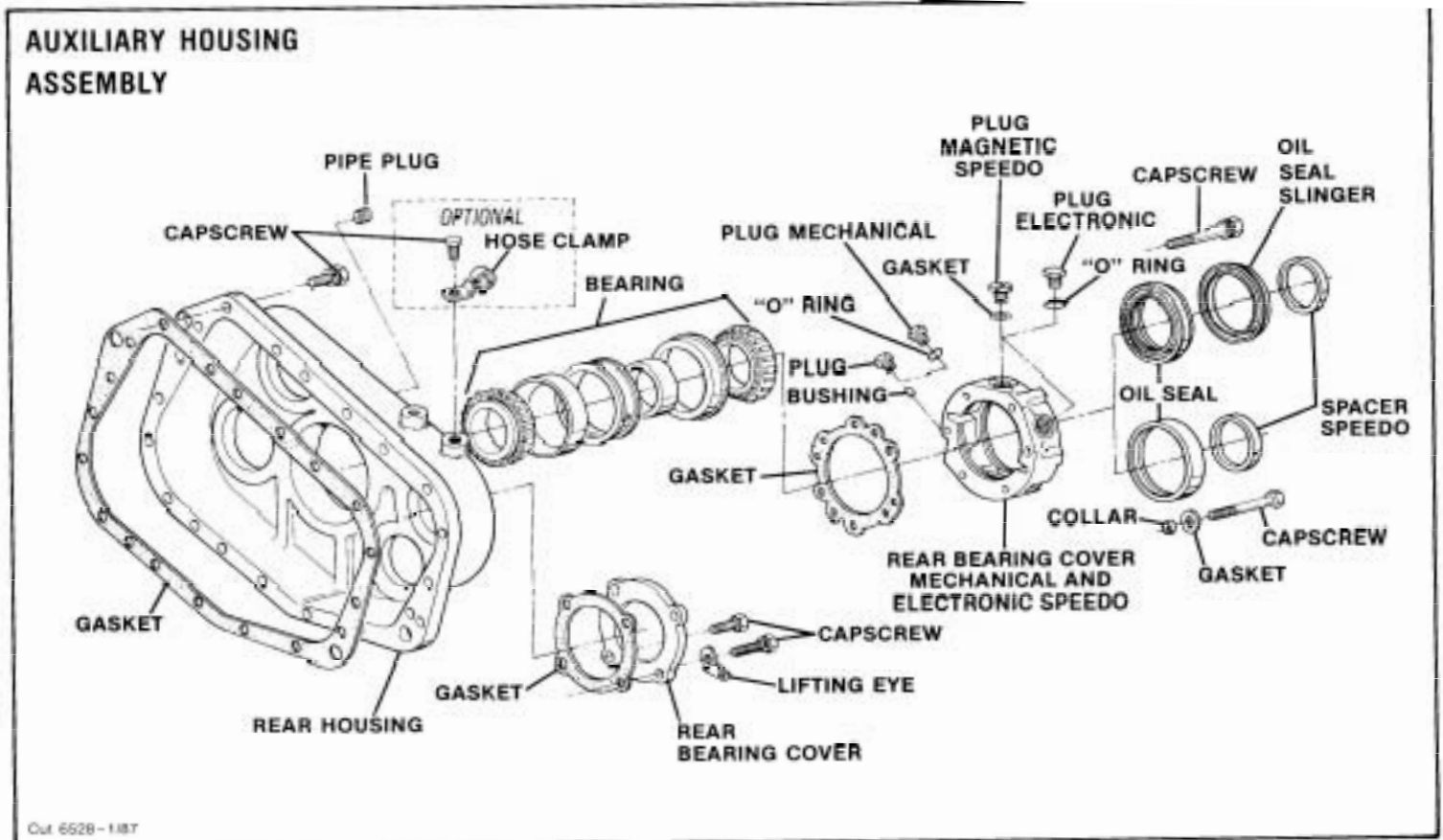

## A. Reassembly and Installation of

**NOTE:** Make sure magnetic plugs preinstalled in auxiliary housing.

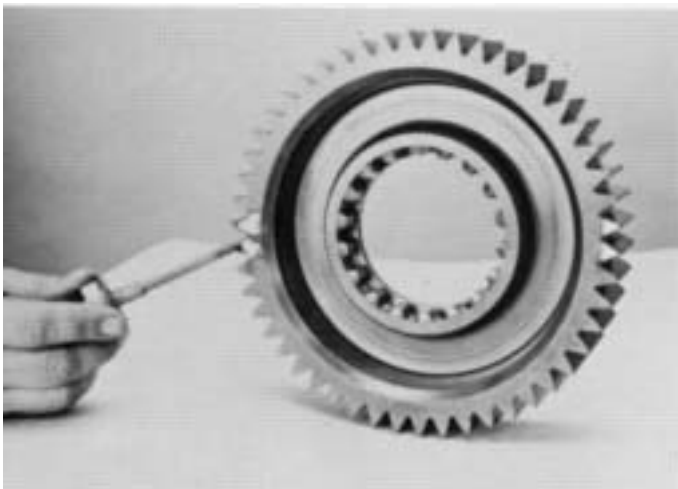

1. **IMPORTANT:** Mark timing teeth on the LO Range gear. A highly visible color of toolmaker's dye is recommended.
  - a. Mark any two adjacent gear teeth on LO Range gear, front side.
  - b. Then mark the two adjacent teeth which are directly opposite the first set marked. There should be the same number of teeth between the markings on each side of the gear.



2. Placed splined washer on output shaft shoulder facing up as shown.

# REASSEMBLY-AUXILIARY SECTION

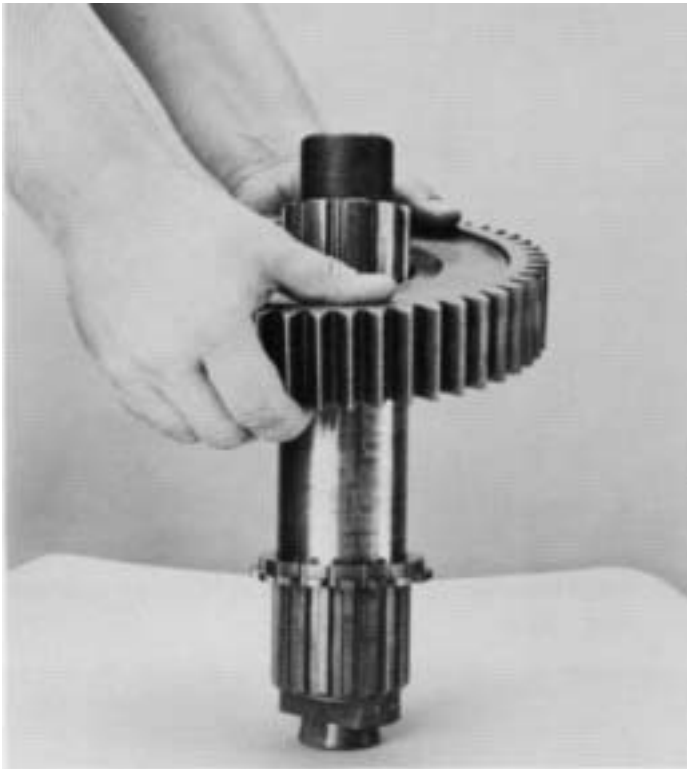

3. Install the LO Range gear on the output shaft, clutching teeth engaged with the splines down to engage the washer splines.



5. Using a heat lamp or hot plate and oil heat the output shaft rear bearing and install on output shaft. Seat the bearing securely on shaft. Bearing can also be installed using the appropriate driver.

**NOTE:** DO NOT HEAT BEARING ABOVE 275°F (136°C).



4. Install the LO Range gear rear washer on output shaft and against gear, with chamfer side facing up.



6. Install the bearing inner spacer on the output shaft.

# REASSEMBLY - AUXILIARY SECTION

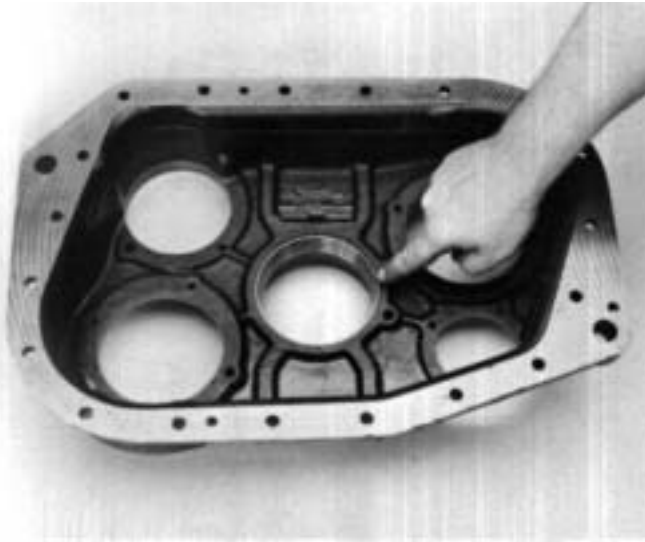

7. Install front bearing race in auxiliary housing bearing bore.

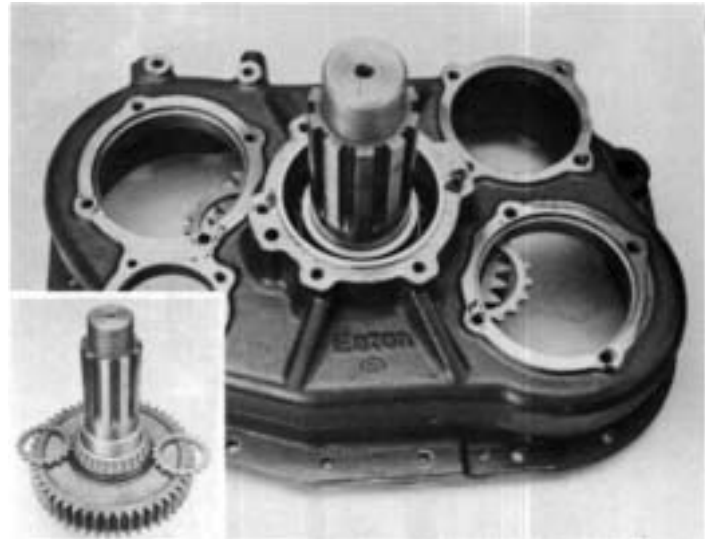

9. Place two mainshaft spacers or flat steel stock of equivalent thickness (.190") on the rear face of the LO range gear, 180° from each other. Install the auxiliary housing over the output shaft assembly allowing the housing to rest on the blocking.



8. Install rear bearing race and rear bearing outer spacer in auxiliary housing bearing bore. The bearing race will be at proper depth when race shoulder is seated on top of bearing bore.



10. Heat the rear bearing cone and install on the shaft, taper side down and inside the cup. Make sure the lip of the rear bearing cup is fully seated on the housing with the bearing installed.

NOTE: DO NOT HEAT THE BEARING ABOVE 275°F (136°C).



# REASSEMBLY - AUXILIARY SECTION

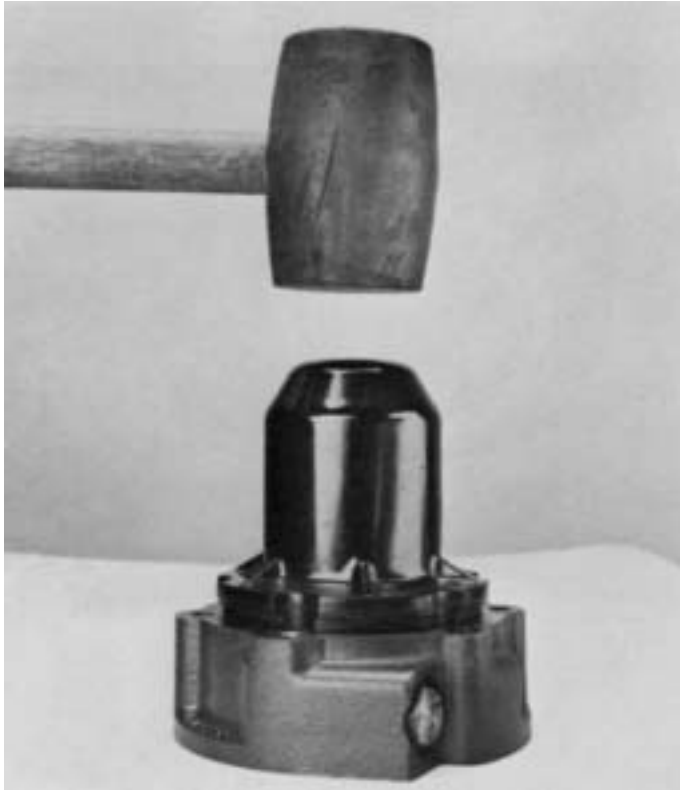

11. If previously removed, install the oil seal in the rear bearing cover. The seal should be installed with an oil seal installation tool. (Fuller part No. K-2091)

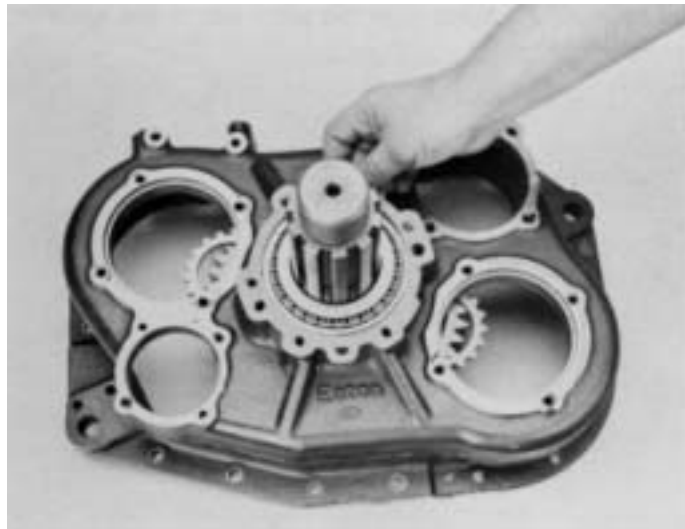

12. Position the corresponding new gasket on cover mounting surface.

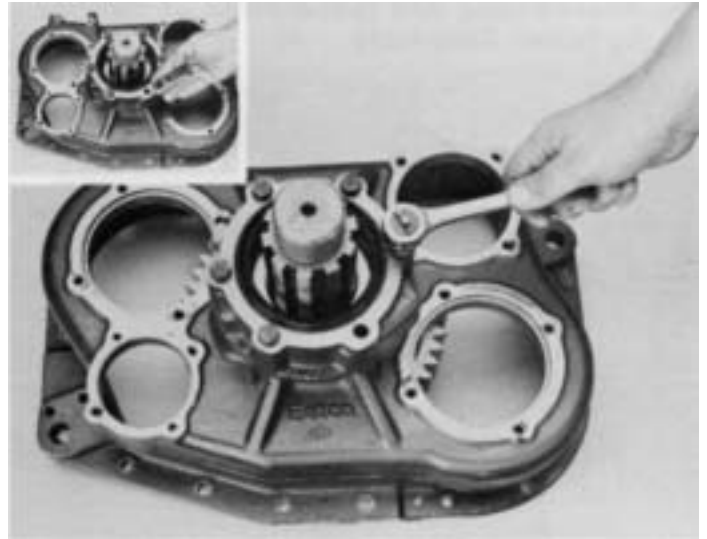

13. Install the rear bearing cover on the auxiliary housing. Use the nylon collar and brass washer with the cap screw at the chamfered hole which intersects the speedometer bore (inset). Tighten the cap screws to the recommended torque ratings.

**NOTE:** Because the collar becomes distorted when compressed, DO NOT REUSE OLD NYLON COLLAR.

# REASSEMBLY - AUXILIARY SECTION

## B. Reassembly and Installation of Splitter Cylinder Assembly

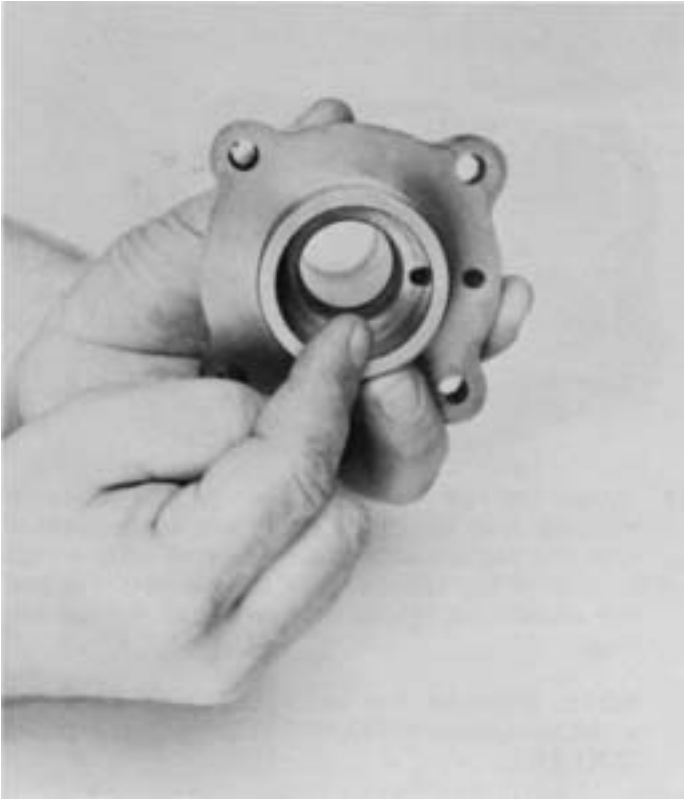

1. If previously removed, install the small O-ring in the cylinder housing bore.

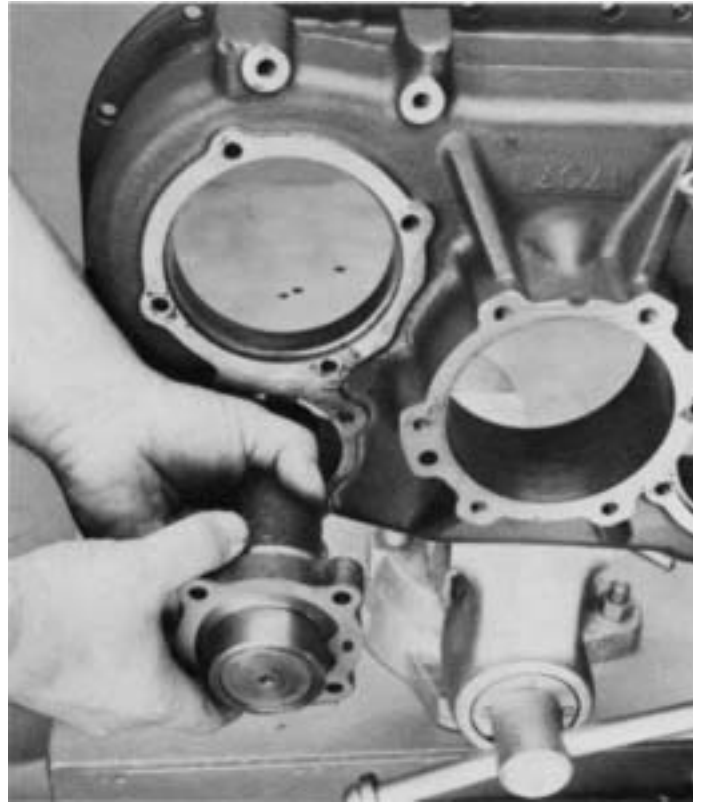

3. Position the corresponding new gasket on the housing mounting surface and install the splitter cylinder housing with the yoke bar in the auxiliary housing.



2. If removed, install the O-ring on the piston O.D. (left). Insert the yoke bar in the cylinder housing bore (right).



4. If previously removed, install the insert valve, flat end to the outside, and the valve retaining nut in the bottom bore of the cylinder cover. Tighten to recommended torque ratings.

**NOTE:** Prior to installation of the insert valve, make sure the three O-rings on the valve O.D. are not defective. Replace, if necessary.

# REASSEMBLY - AUXILIARY SECTION

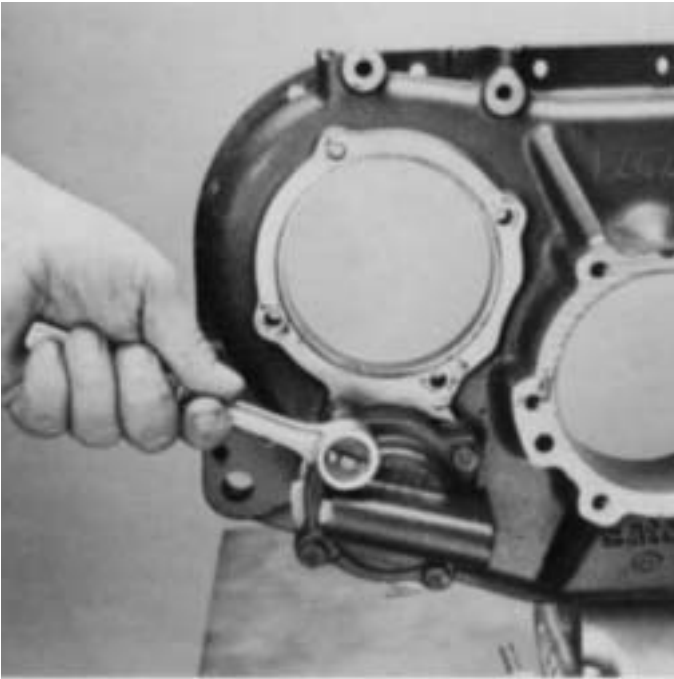

5. Position corresponding gasket on the splitter cylinder housing. Position the splitter cylinder cover and install four capscrews, tighten to recommended torque.

## C. Reassembly Synchronizer Assembly

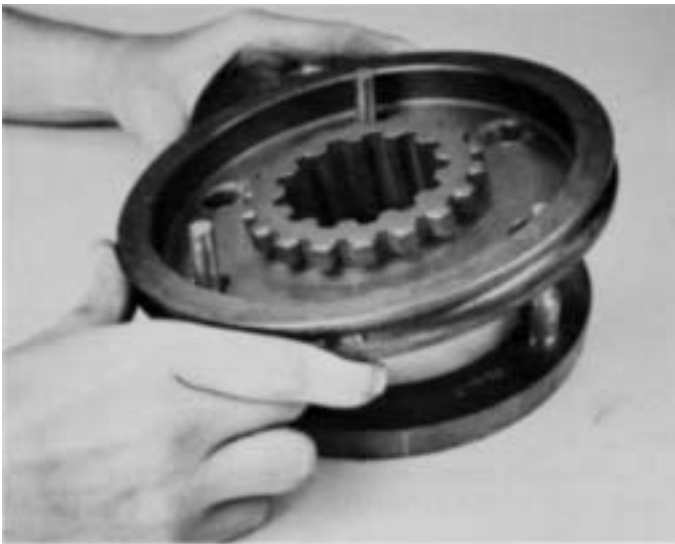

1. Place the larger LO range synchronizer ring face down on bench with pins up. Place the sliding clutch, recessed side up, on pins of LO range synchronizer.

**NOTE:** Pins on LO range synchronizer must line up with chamfered holes on bottom of sliding clutch.



2. Install the three springs in bores in HI range synchronizer ring.



3. Place the HI range synchronizer ring over pins of LO speed synchronizer ring, seating springs against pins.

# REASSEMBLY - AUXILIARY SECTION



4. Apply downward pressure to the HI range synchronizer ring WHILE TWISTING COUNTER-CLOCKWISE to compress the springs and fully seat ring on blocker pins of LO range synchronizer.

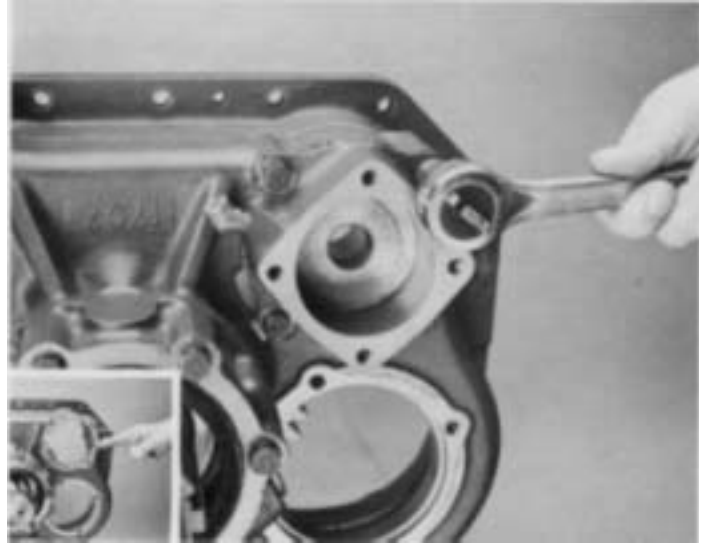

2. Position the corresponding new gasket on the housing mounting surface (inset). Install the cylinder housing in the rear bore of the auxiliary housing, air fitting to the upper left. Tighten the capscrews, to the recommended torque rating.

## E. Reassembly Range Cylinder

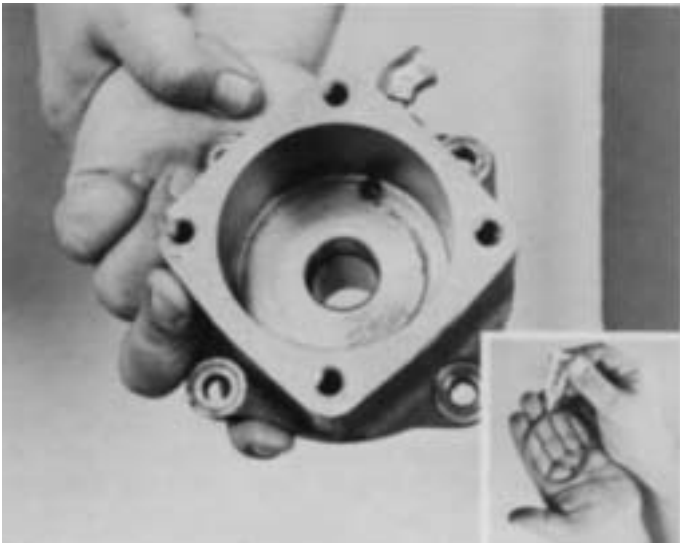

1. Install O-ring in slot of small bore in cylinder. Apply silicone to all O-rings (inset).

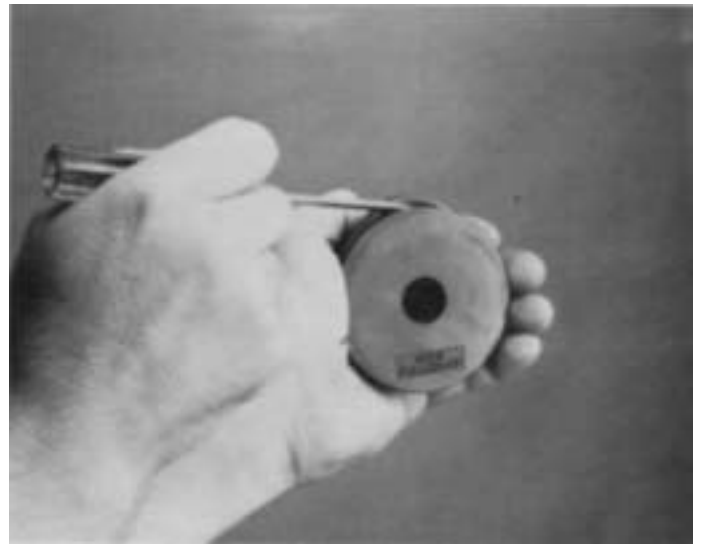

3. If previously removed, install the O-rings in the I.D. and O.D. of the range position.

# REASSEMBLY - AUXILIARY SECTION

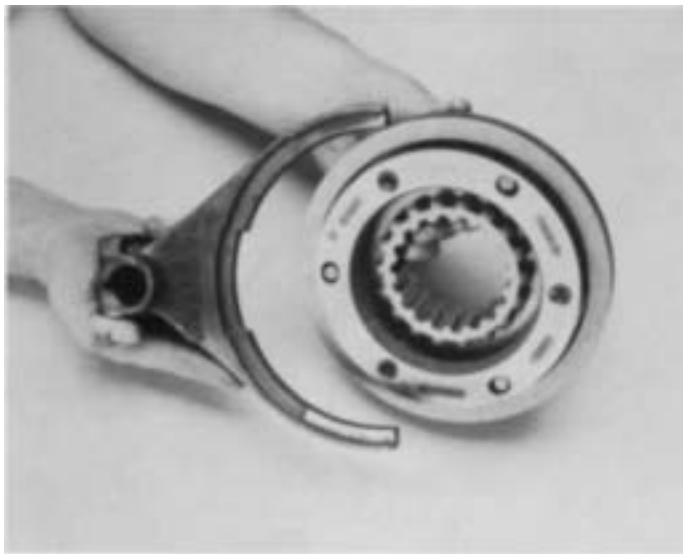

4. Place range shift yoke in slot of synchronizer sliding clutch, threaded hub of yoke up and facing HI range synchronizer.

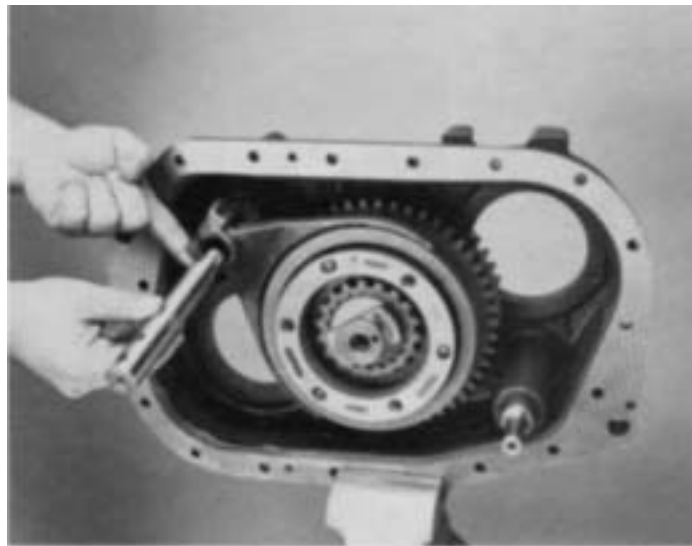

6. Insert threaded-end of yoke bar through yoke and into the range cylinder housing bore, aligning the notches in bar with yoke lock screw holes. Use caution not to damage O-ring in range cylinder.

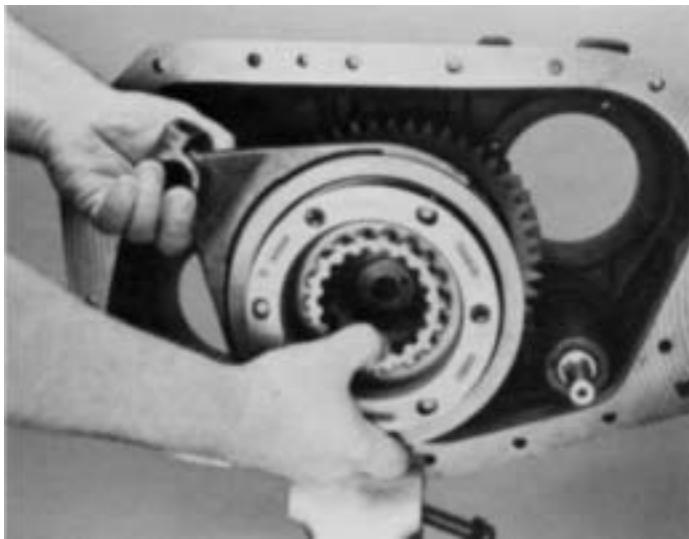

5. Place range shift yoke and synchronizer assembly into auxiliary housing, engaging splines of sliding clutch with output shaft, LO Range synchronizer to rear.

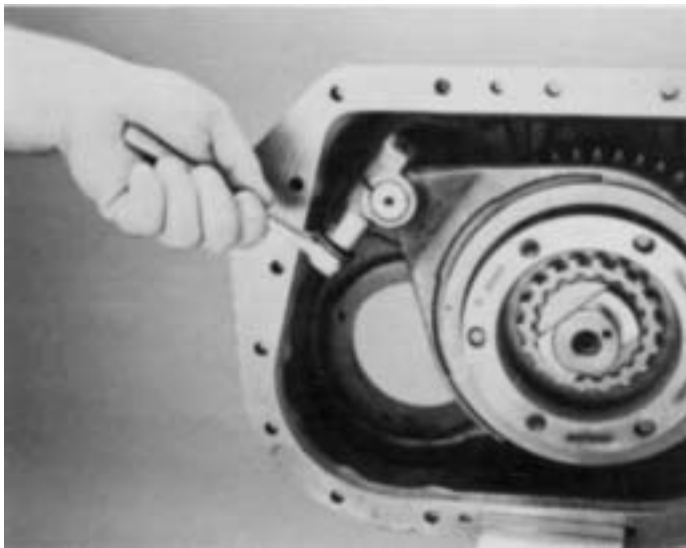

7. Install two 3/4" cap screws through bottom of range shift yoke and tighten to recommended torque, lockwire lock screws.

# REASSEMBLY-AUXILIARY SECTION

## F. Installation Rear Auxiliary Drive Gear

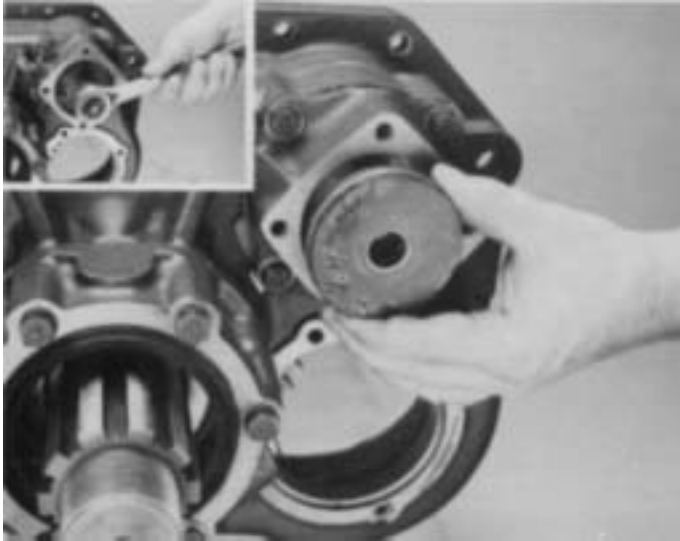

8. In cylinder housing bore, install the range piston on yoke bar, flat side to the rear. Secure with nut tightened to recommended torque ratings (inset).

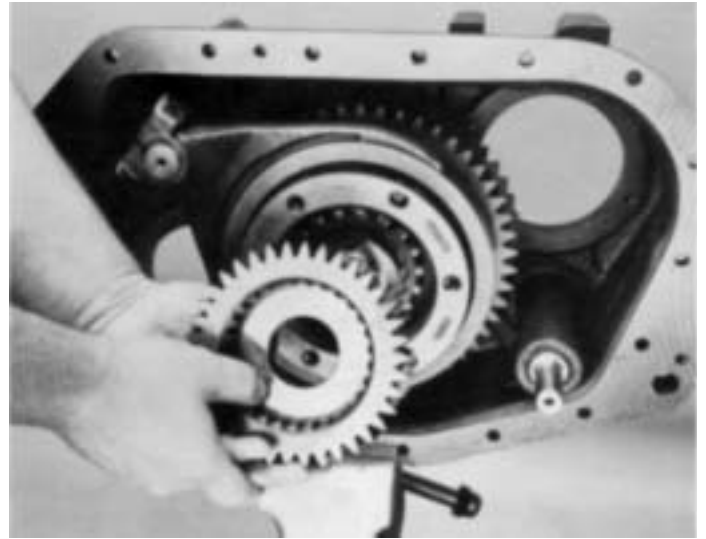

1. Install rear auxiliary drive gear on output shaft, with clutching in teeth facing forward.

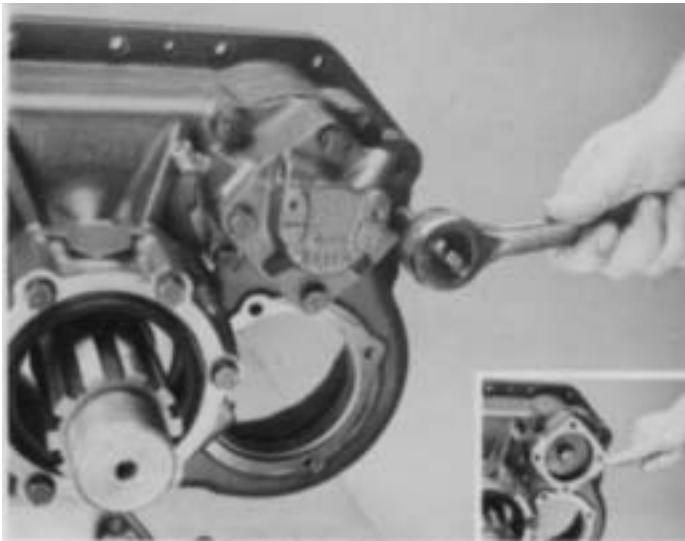

9. Position the corresponding new gasket on cow mounting surface (inset) and install the range cylinder cover on housing, open port to the upper left. Tighten capscrews to recommended torque rating.

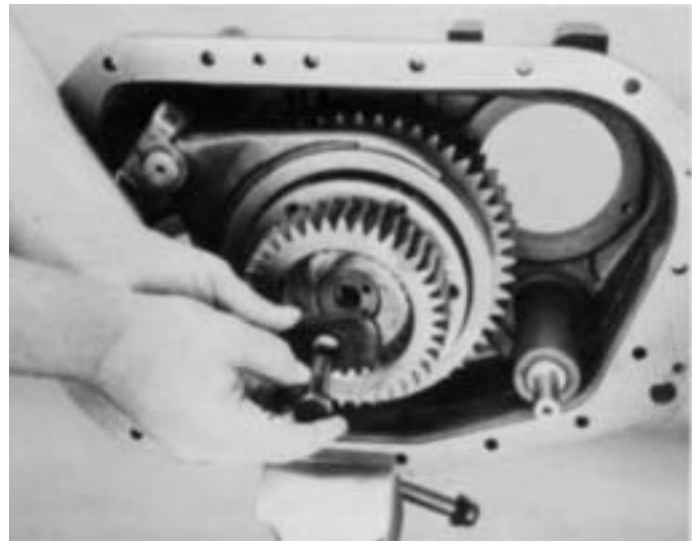

2. Install retainer with the retainer pin facing the synchronizer, match the pin with hole. Finger tighten the capscrew.

# REASSEMBLY - AUXILIARY SECTION

## G. Timing and Installation of Auxiliary Countershaft Assemblies

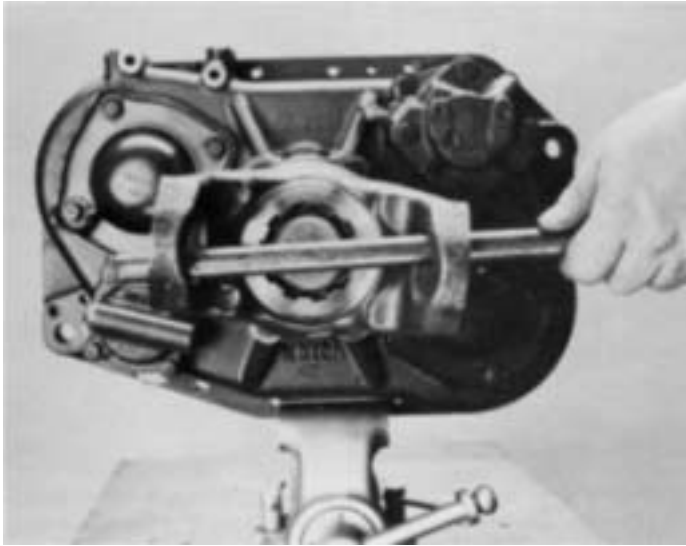

3. Temporarily install the output yoke. Insert and hold a breaker bar to keep the output shaft from turning.

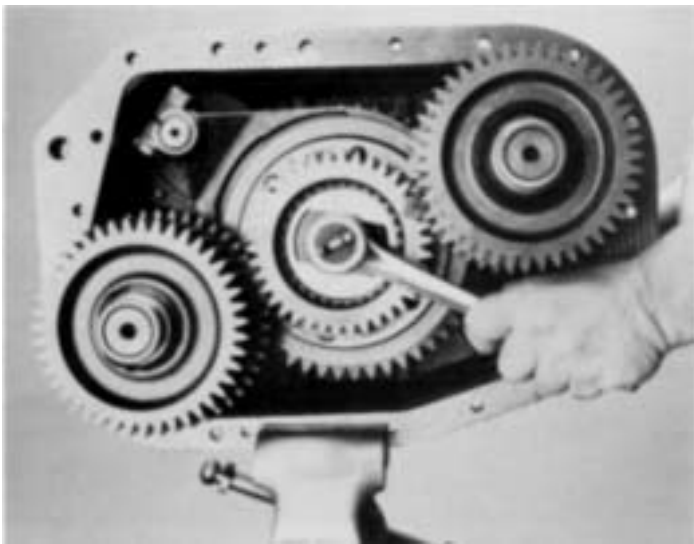

4. Tighten the 15/16" capscrew on the rear auxiliary drive gear to the recommended torque rating. Remove the output yoke and breaker bar.  
**WARNING:** Make sure to use a new bolt with Loctite and apply 90-120 lbs.-ft. of torque.

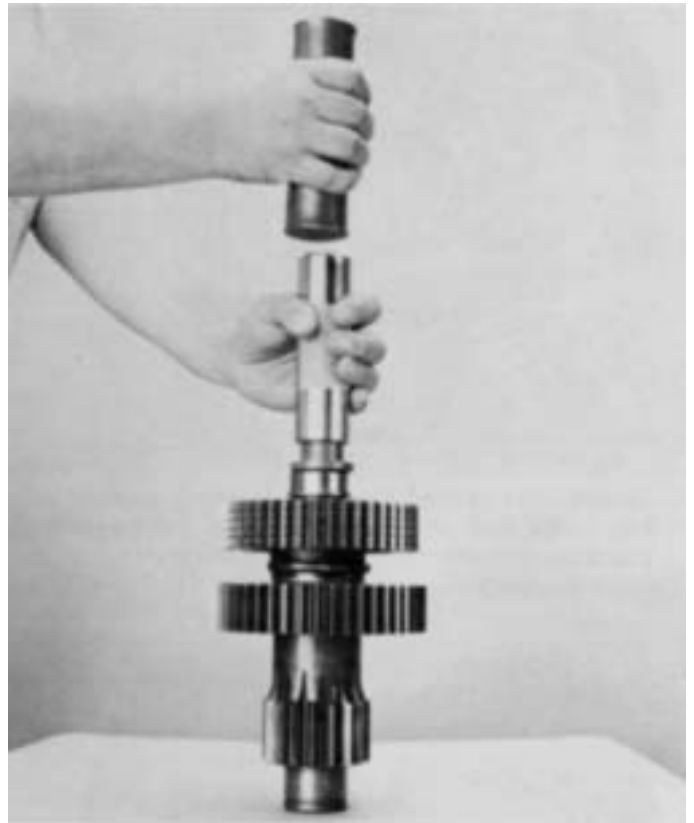

1. Use a proper bearing driver to seat the two countershaft bearing races.

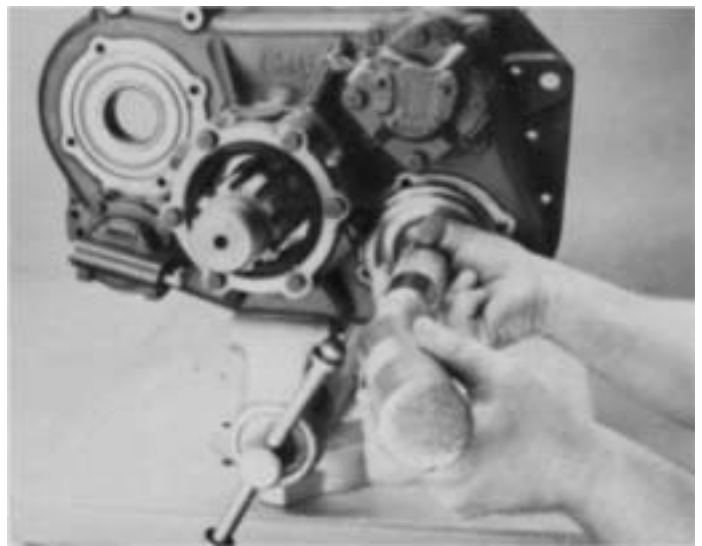

2. Install the bearings in the countershaft rear bearing bores.

# REASSEMBLY - AUXILIARY SECTION

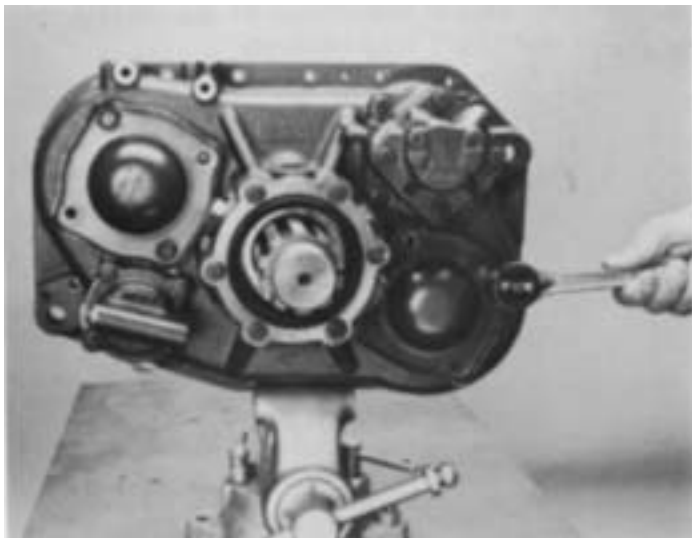

3. Temporarily install the rear bearing covers, use two bolts and no gasket to hold the bearing in place as the countershaft are driven into the auxiliary housing.

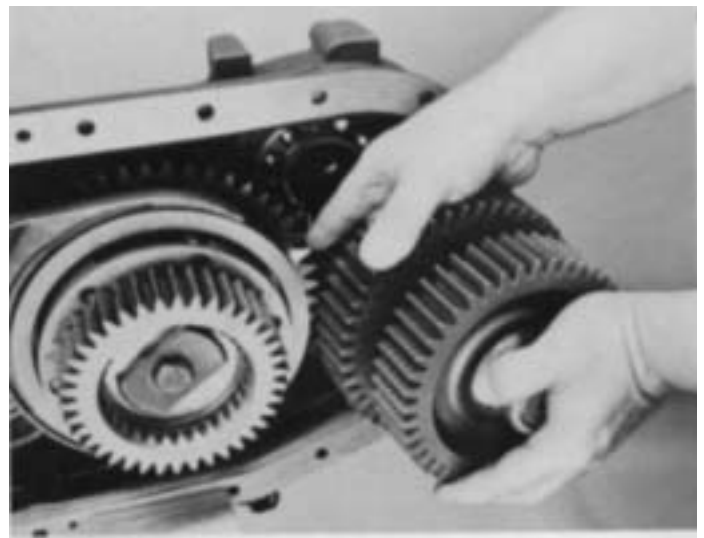

5. Place the upper countershaft assembly into position in housing. Mesh the marked tooth of the countershaft LO Range gear with either set of two marked teeth of the LO Range gear.



4. **IMPORTANT:** On the LO Range gear of each auxiliary countershaft assembly locate the "O" stamped on one tooth. Align tooth with "O", with smaller LO Range gear tooth and mark with a highly visible color of toolmaker's dye.

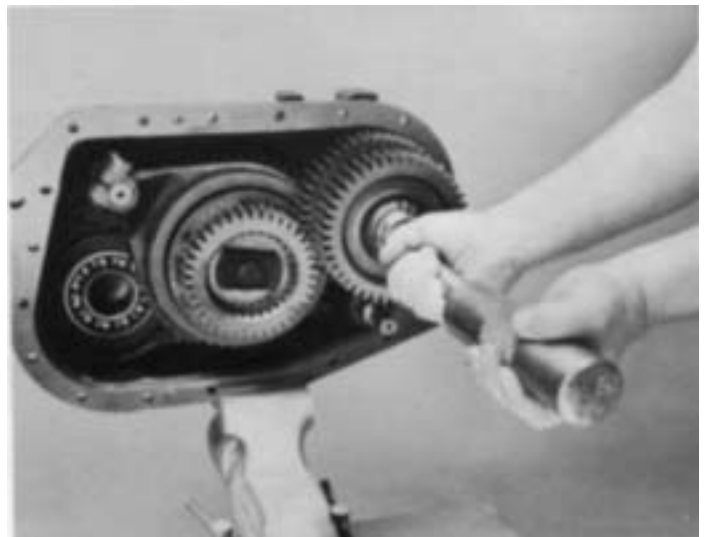

6. With a soft bar and maul, drive the countershaft into the auxiliary bearing.



# REASSEMBLY - AUXILIARY SECTION

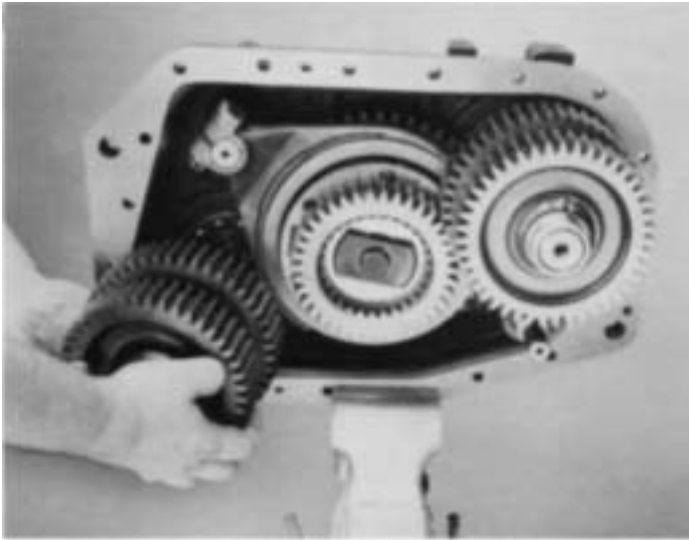

7. Repeat the previous procedure with the lower countershaft assembly, meshing the marked tooth of the countershaft LO Range gear with the remaining set of the two marked teeth of the LO Range gear.

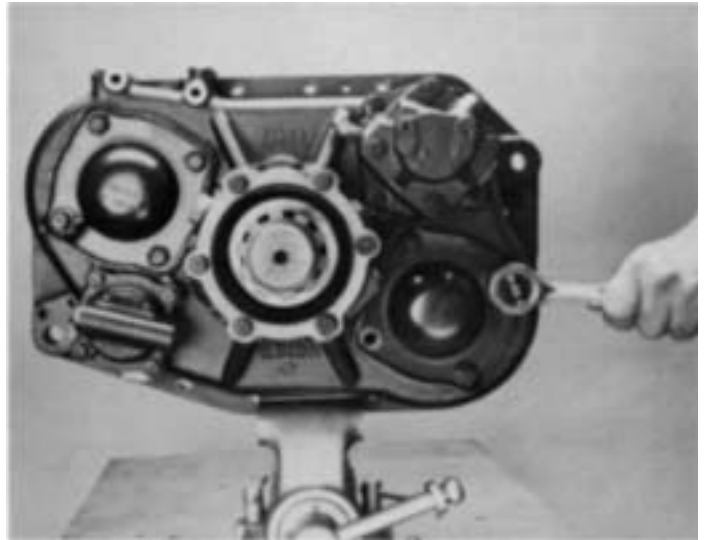

9. Position the corresponding new gasket on the cover mounting surface. Install both rear bearing covers. Tighten the capscrews to the recommended torque rating.

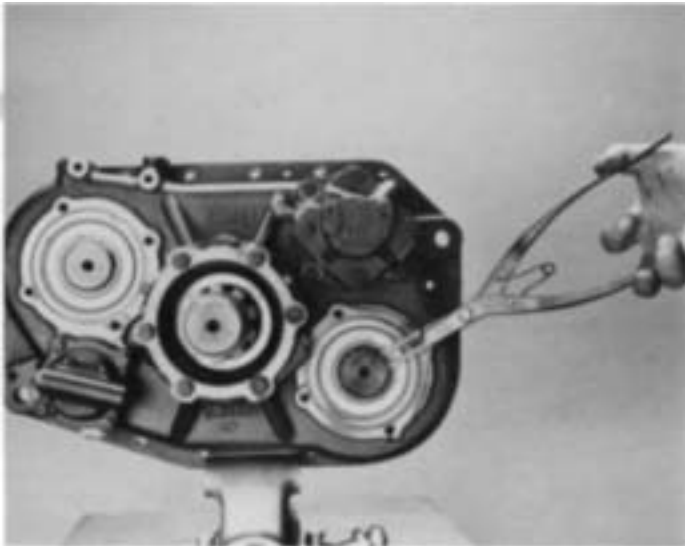

8. Remove countershaft rear bearing covers and install snap rings in the rear countershaft grooves.

# REASSEMBLY - AUXILIARY SECTION

---

## H. Installation of Splitter Sliding Clutch and Yoke



1. Place shift yoke in slot of splitter sliding clutch. Install clutch and yoke on splitter yoke bar.

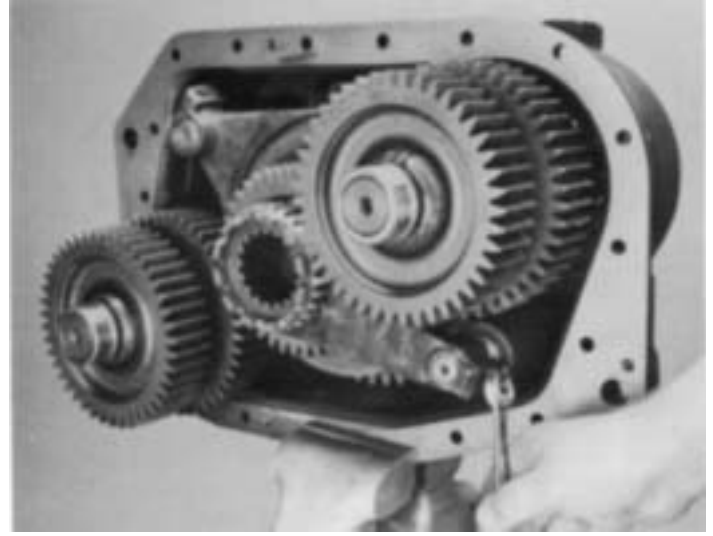

2. Install the lock screw and tighten to recommended torque rating. Wire securely. Remove the auxiliary section from the vise.

# DISASSEMBLY - FRONT SECTION

## AUXILIARY DRIVE GEAR ASSEMBLY

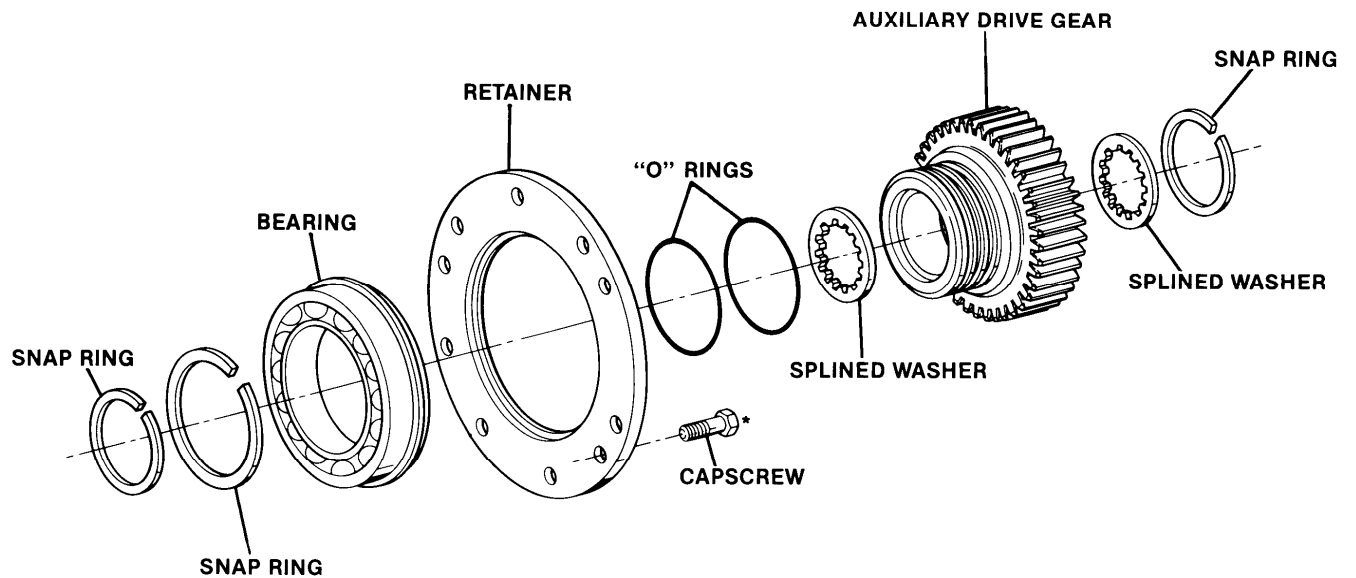

Cut 6417 L-3/87

\*Note: Use lock wire at this position

### A. Removal Front Auxiliary Drive Gear

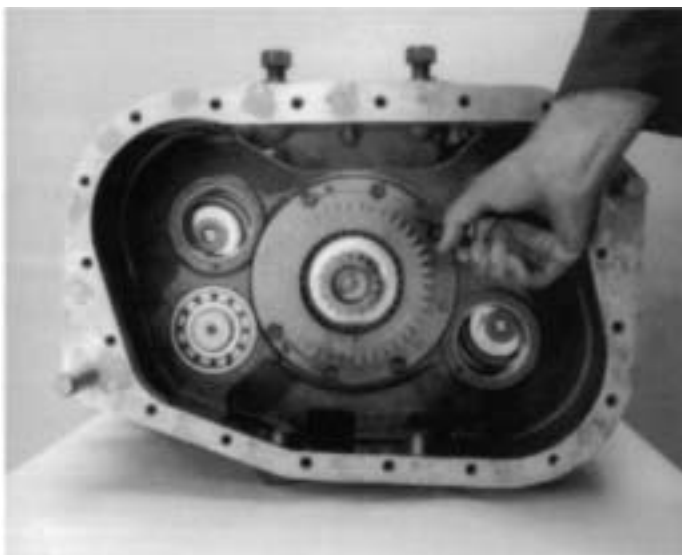

1. Cut lockwire from auxiliary bearing retainer ring cap screws.

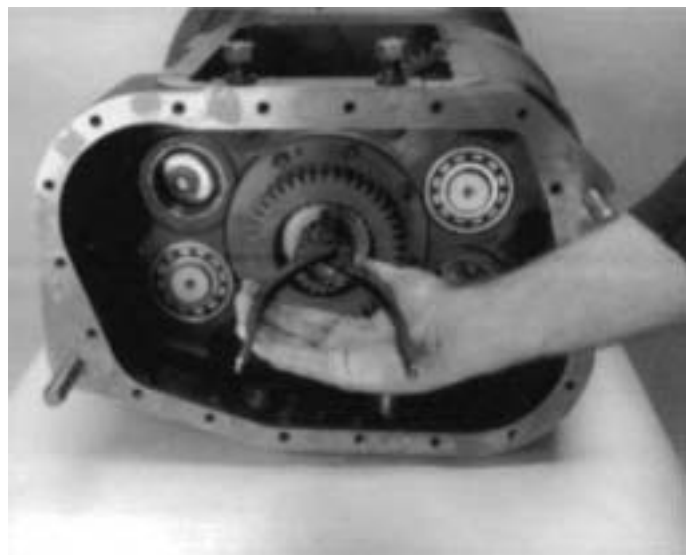

2. Remove snap ring from mainshaft rear groove.

# DISASSEMBLY - FRONT SECTION

---

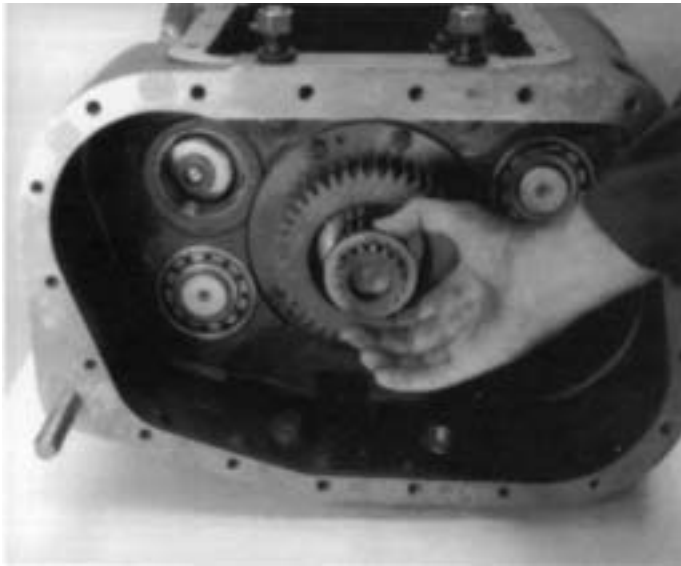

3. Remove the splined washer from inside front auxiliary drive gear assembly.

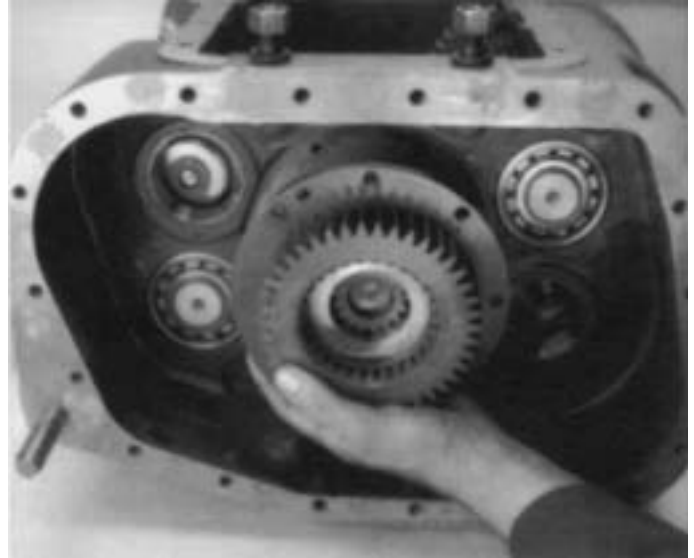

5. Remove front auxiliary drive gear from mainshaft.

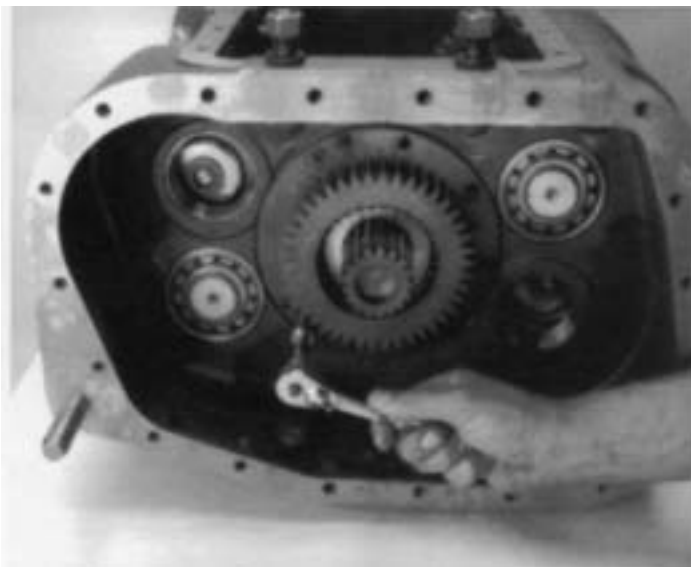

4. Remove six capscrews from the auxiliary bearing retainer ring. Insert three puller screws in the specially tapped holes of retainer ring. Tighten screws evenly to pull the front auxiliary drive gear assembly from case bore.



6. Remove the spline d washer from the mainshaft also remove the front auxiliary drive gear retaining snap ring from the mainshaft.

# DISASSEMBLY-FRONT SECTION

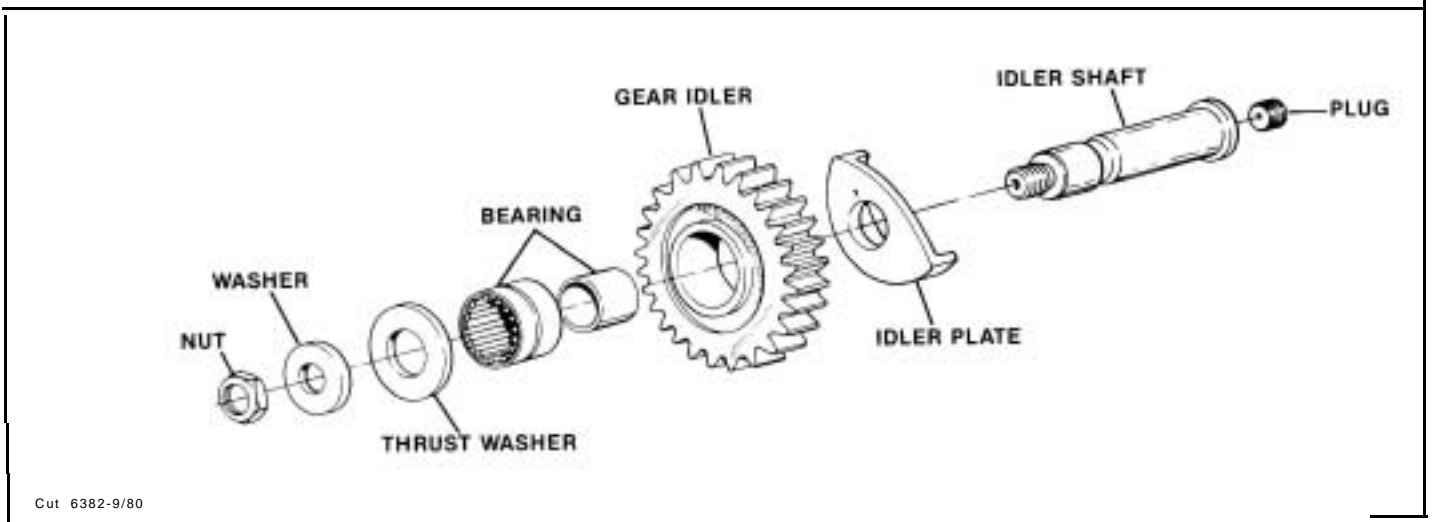

## B. Removal and Disassembly of Left Reverse Idler Gear Assembly



1. Move the mainshaft reverse gear as far to the rear as possible and remove the snap ring from I.D. of gear.

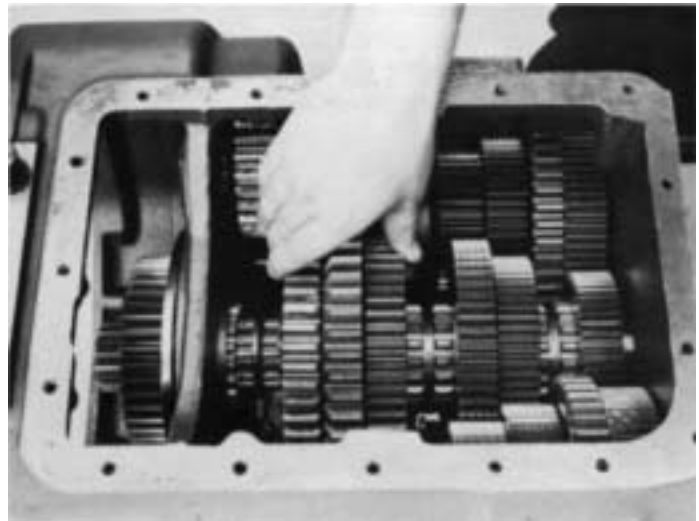

2. Move the reverse gear forward and against the LO speed gear, engaging the splines of mainshaft sliding clutch.

# DISASSEMBLY - FRONT SECTION

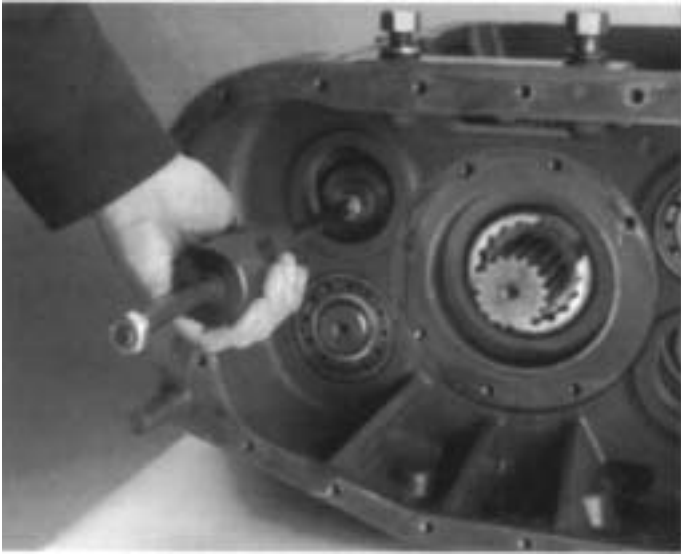

3. Using inside jaw pullers or impact puller, remove the auxiliary countershaft front bearing race from left reverse idler gear bore. If necessary, repeat the procedure for removing the auxiliary countershaft front bearing race from right reverse idler gear bore.

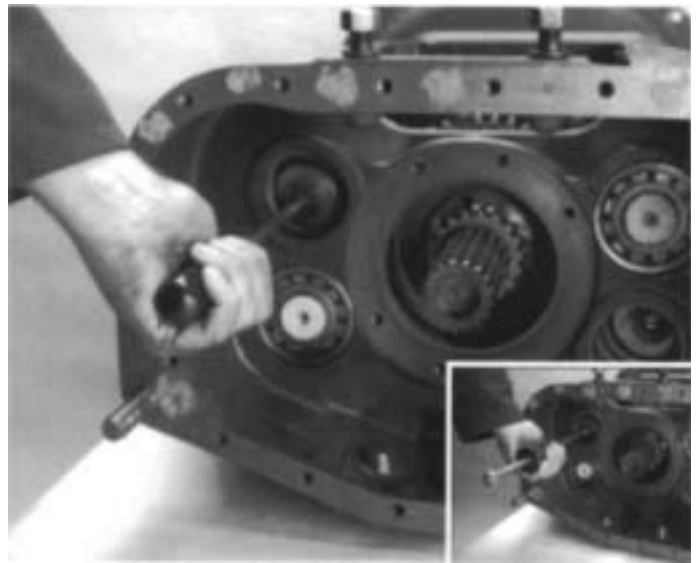

5. Remove the pipe plug from rear of idler shaft and use an impact puller, 1/2"-13 threaded end, to remove shaft from case bore (inset).



4. Loosen the nut on the idler shaft, (inset). Remove the stop nut and washer from front of idler shaft.

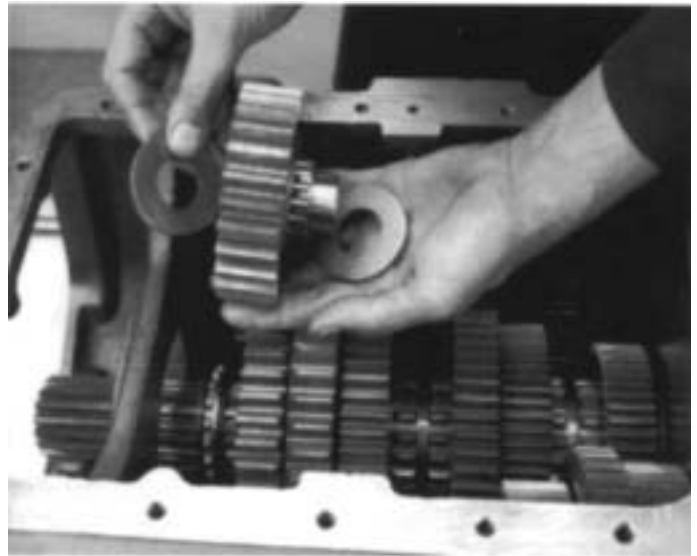

6. As the idler shaft and idler plate are moved to the rear, remove the thrust washer, and gear from case. If necessary, remove the inner race from bearing and remove needle bearing from idler gear.

# DISASSEMBLY-FRONT SECTION

## C. Removal of Countershaft Bearings

**NOTE:** In the following instructions, the front and rear bearings from BOTH countershaft are removed. For removal of the mainshaft assembly from case, it is necessary to remove the bearings from right countershaft ONLY.

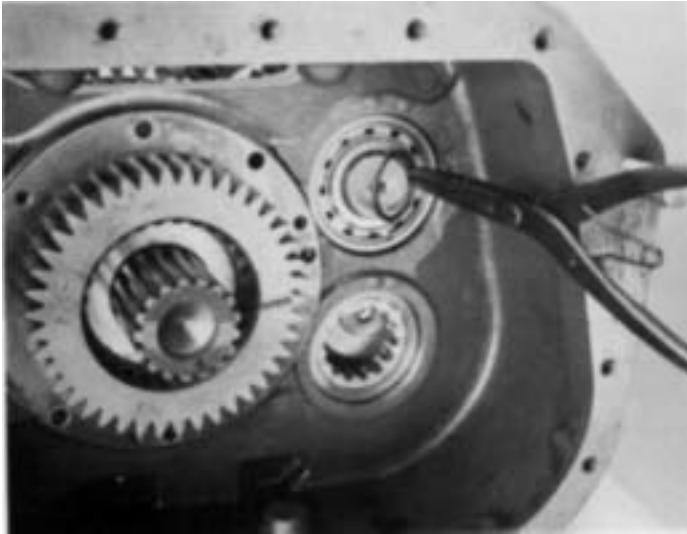

1. Temporarily reinstall front auxiliary drive gear on mainshaft, remove snap ring from each countershaft rear groove.

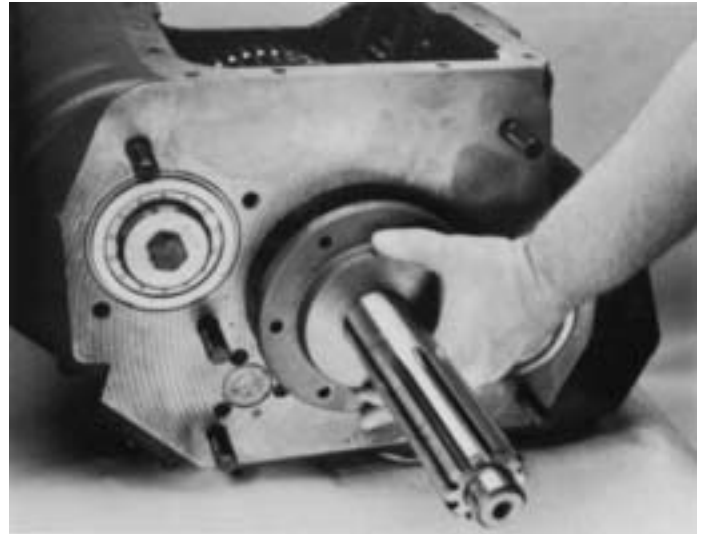

3. Remove front bearing cover.

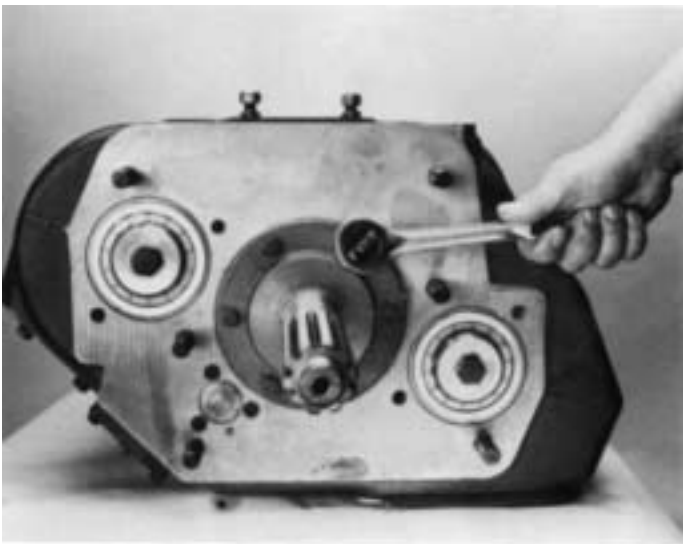

2. Remove six capscrews from front bearing cover.



4. From inside the case, use a soft bar and maul to drive the countershaft rear bearings to the rear and from case bores.

**NOTE:** This procedure will damage the bearings and should not be attempted unless replacement of the bearings is planned.

# DISASSEMBLY-FRONT SECTION

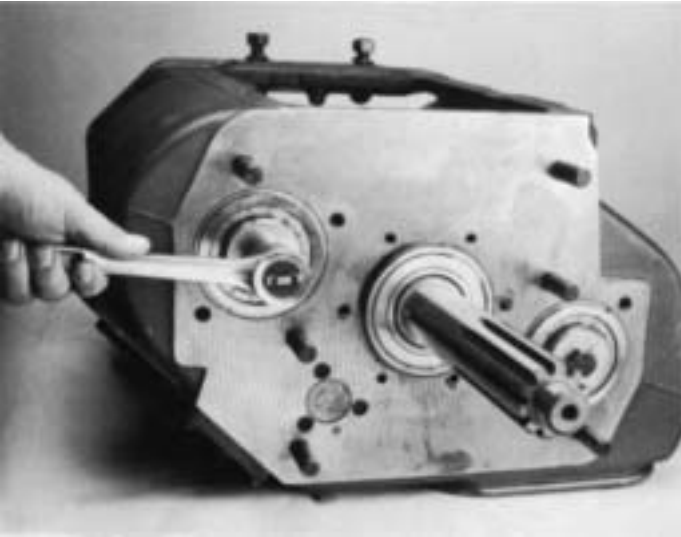

5. Turn out the cap screw and remove the front bearing retainer plate from each countershaft.



7. From the case rear, use a soft bar and maul to drive each countershaft forward to unseat the front bearings from case bores and expose the bearing snap rings.



6. Use a soft bar and maul to drive each countershaft to the rear as far as possible. This will partially unseat the front bearings.

**NOTE:** The soft bar used should have a flattened end that is large enough so as not to damage holes for roll pin and cap screw.



8. Use a bearing puller or pry bars to remove the countershaft front bearings.

**NOTE:** The bearing inner race of models equipped with roller-type front bearings will remain pressed on countershaft.



# DISASSEMBLY-FRONT SECTION

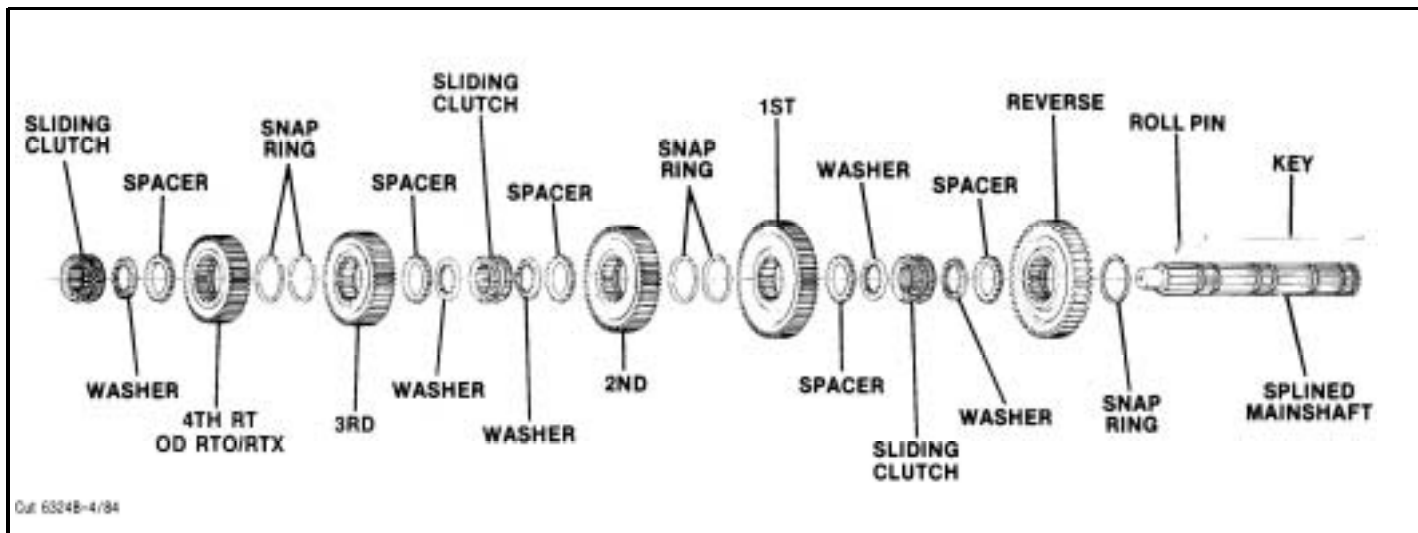

## D. Removal and Disassembly of Mainshaft Assembly

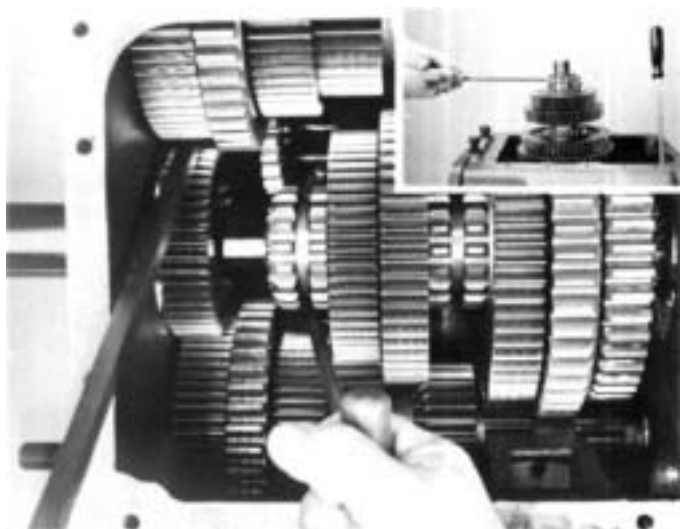

1. Block the right countershaft assembly against case wall and pull the mainshaft assembly to the rear to free pilot from input shaft pocket. Tilt front of mainshaft up and lift the assembly from case (inset). Use caution as the reverse gear is free and can fall from shaft.

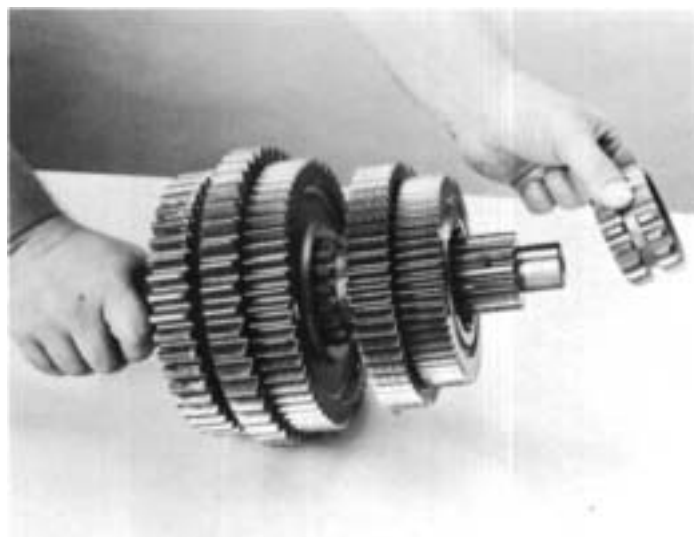

2. Remove the 3rd-4th speed sliding clutch from mainshaft front.

# DISASSEMBLY-FRONT SECTION

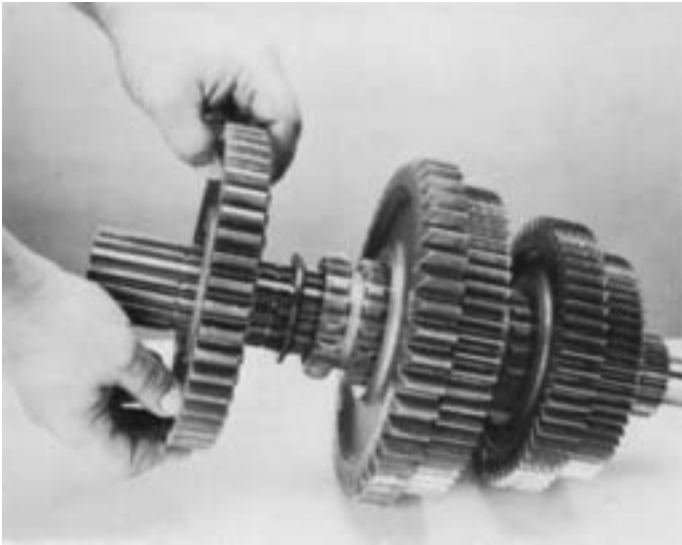

3. Remove the reverse gear and spacer from mainshaft rear.

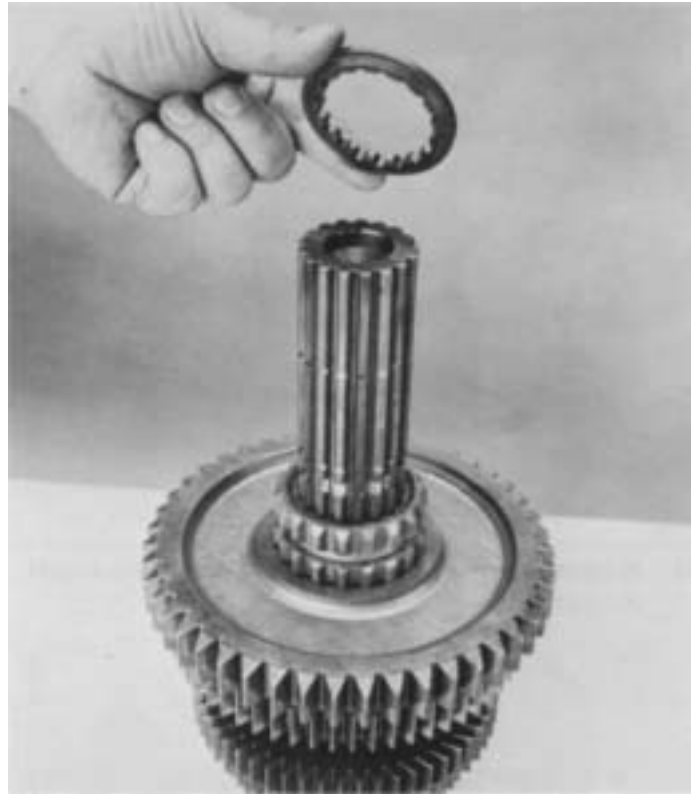

5. Turn the reverse gear limit washer to align its splines with those of the mainshaft and remove washer.



4. From mainshaft rear, pull the key from mainshaft key way.

**NOTE:** When removing limit washers, spacers and gears, note their location on mainshaft to facilitate reassembly. Keep the internal-splined washers and external-splined spacers with the gear from which they were removed. There is **ONLY** one limit washer and one spacer belonging to each gear.

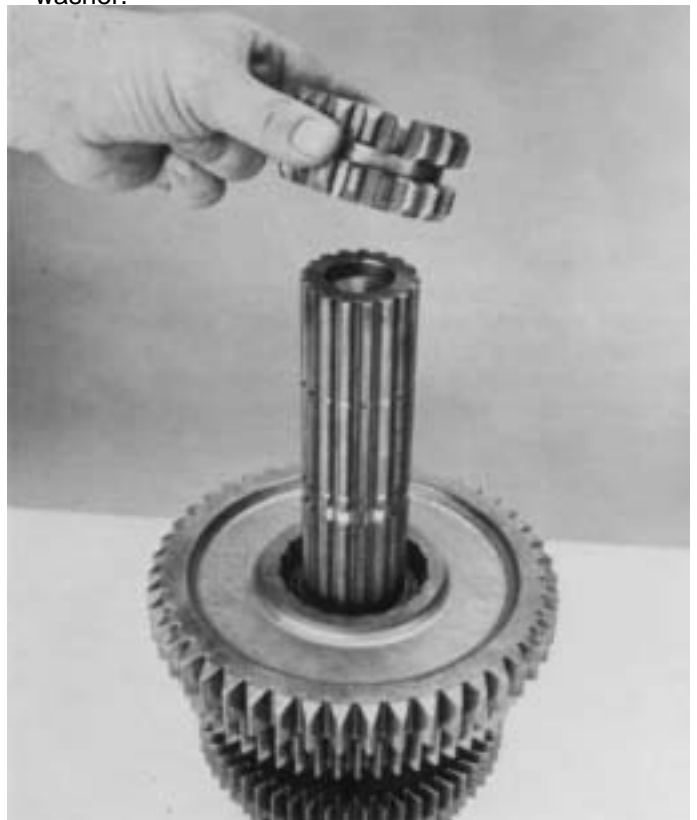

6. Remove the LO-Reverse speed sliding clutch from mainshaft.

# DISASSEMBLY-FRONT SECTION

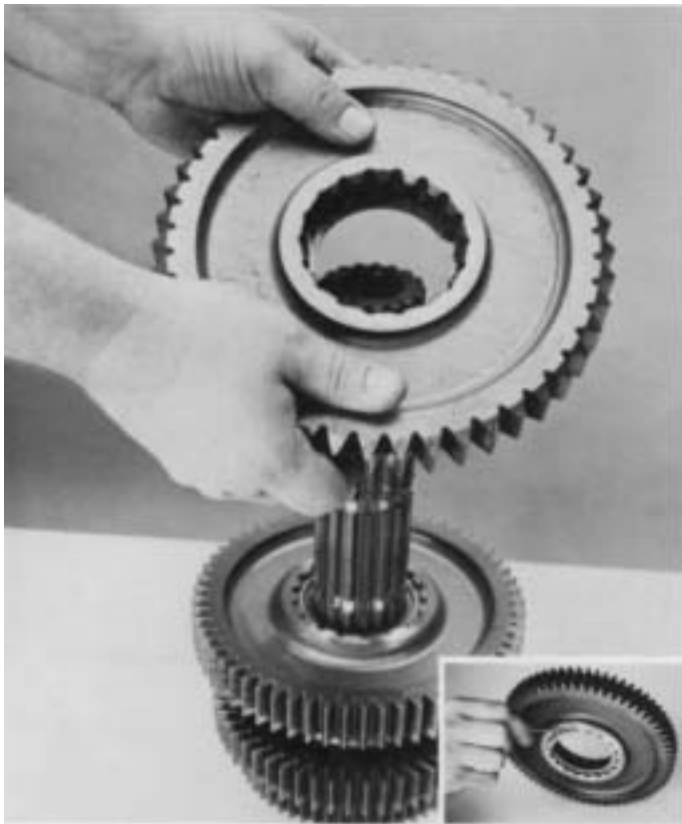

7. Using a small screwdriver, turn the limit washer in hub of LO speed gear to align its splines with those of the mainshaft. Pull the LO speed gear from rear of mainshaft to remove limit washer, spacer, and gear. If necessary, remove the snap ring from I.D. of gear (inset).

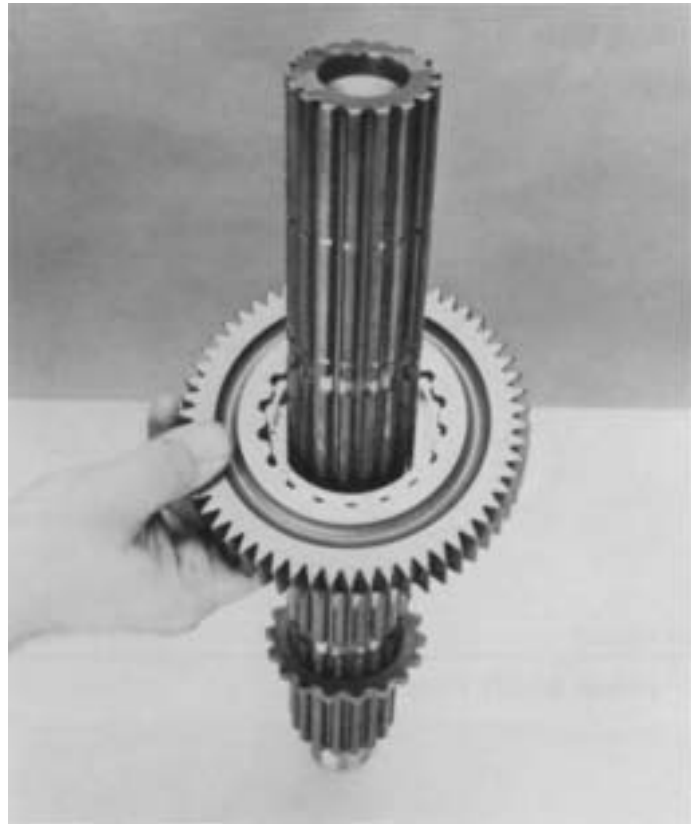

8. Remove each remaining gear, limit washer, spacer, and sliding clutch from mainshaft in the same manner previously detailed. And, if necessary, remove the snap ring from I.D. of each gear.

# DISASSEMBLY-FRONT SECTION

## DRIVE GEAR ASSEMBLY

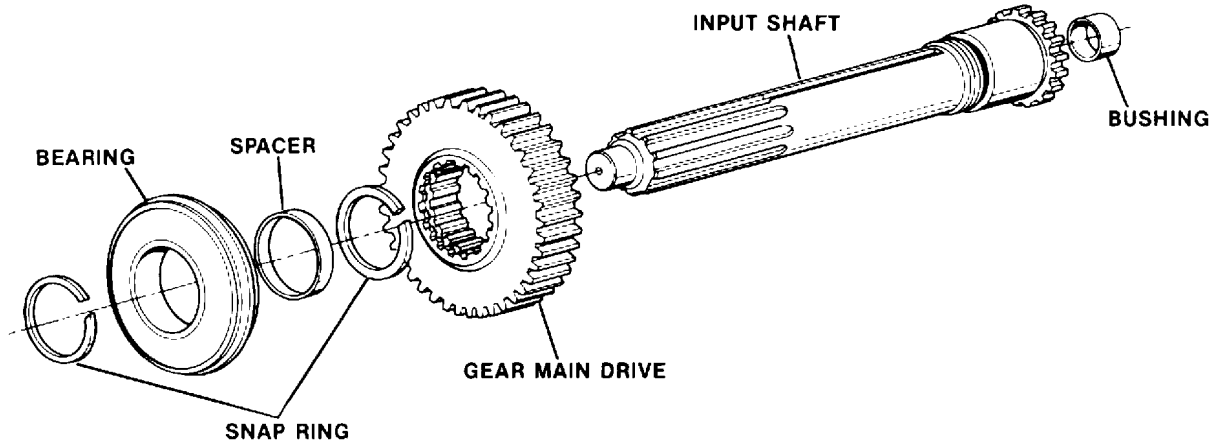

### E. Input Shaft Removal



1. Remove the bearing retaining snap ring from groove in shaft.

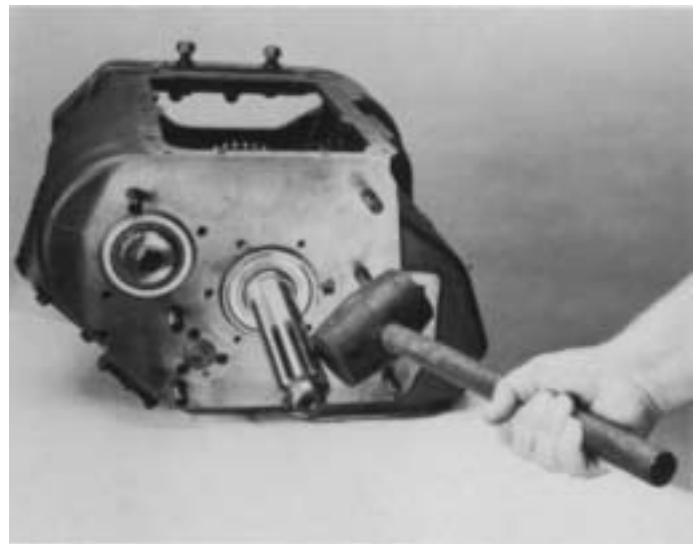

2. Use a rubber maul on the input shaft to cock the bearing in bore.

# DISASSEMBLY-FRONT SECTION



3. Drive input shaft toward rear of transmission, through bearing as far as possible. Pull input shaft.



4. Use pry bars or screwdriver to complete removal of bearing.

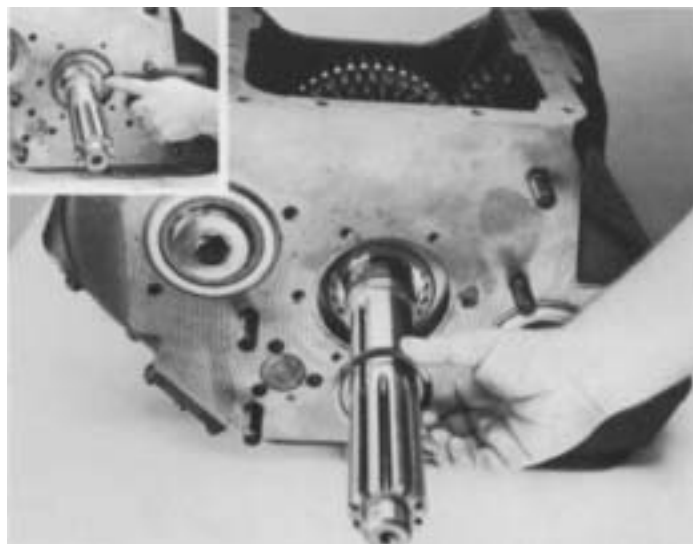

5. Remove drive gear spacer, and snap ring (inset).

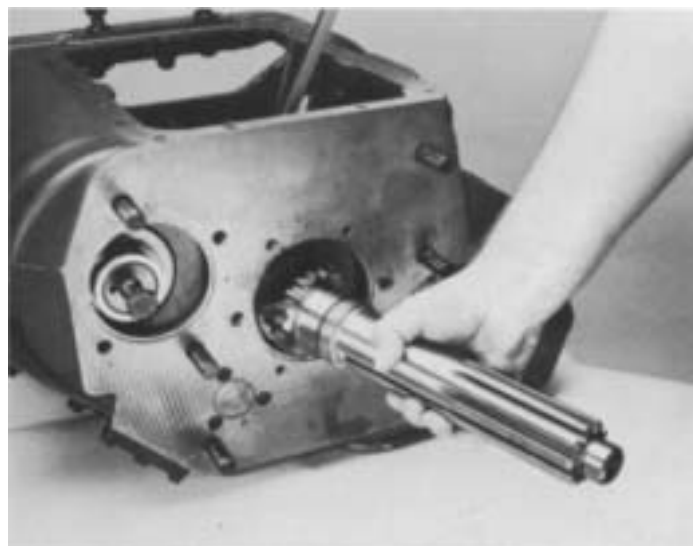

6. Pull input shaft forward and out of drive gear and case.

# DISASSEMBLY-FRONT SECTION

---

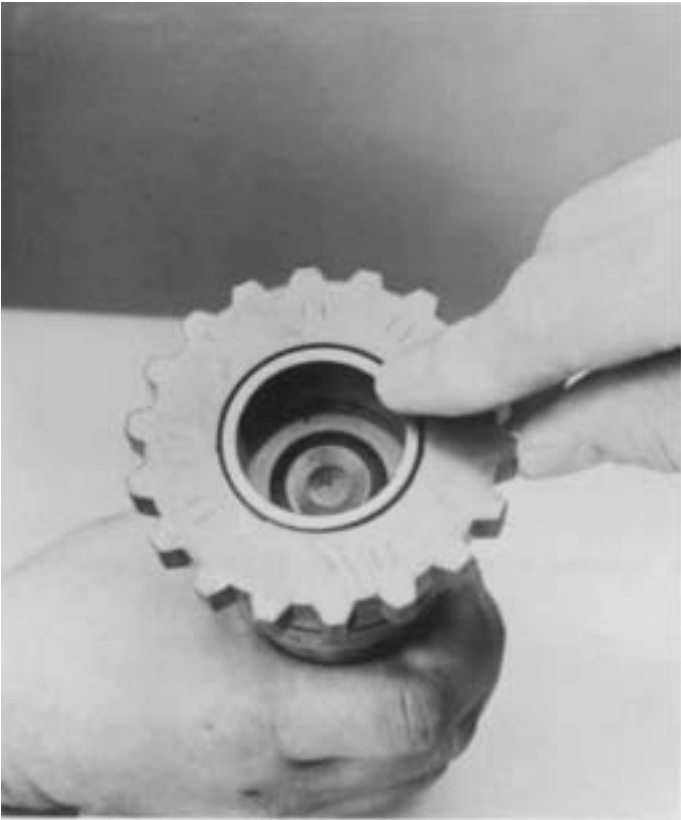

7. Check the bushing in pocket of input shaft, replace if worn.



8. Remove main drive gear from case.

# DISASSEMBLY - FRONT SECTION

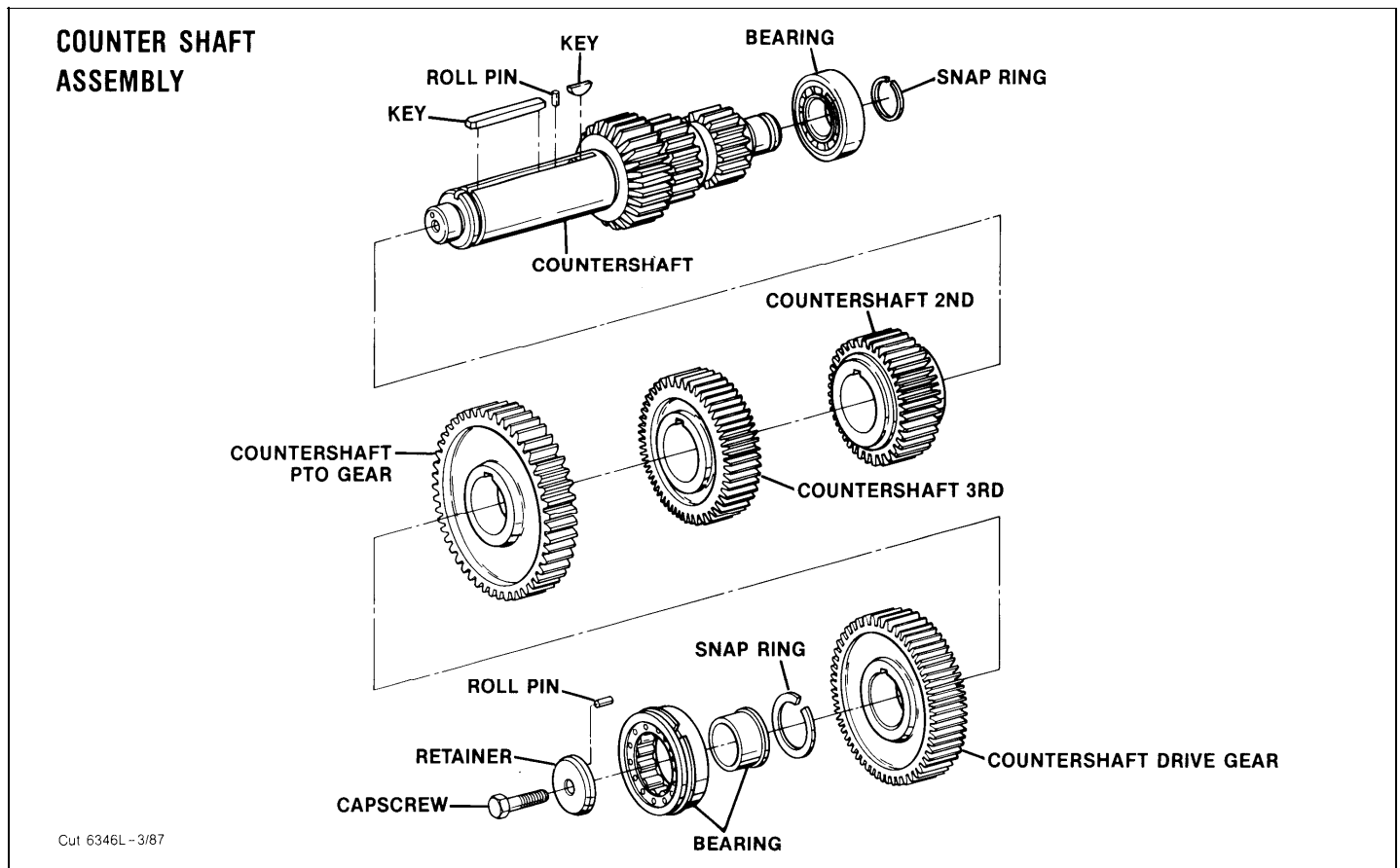

## F. Removal and Disassembly of Countershaft Assemblies

**NOTE:** Except for the PTO gears, the left and right countershaft assemblies are identical and disassembled in the same manner.

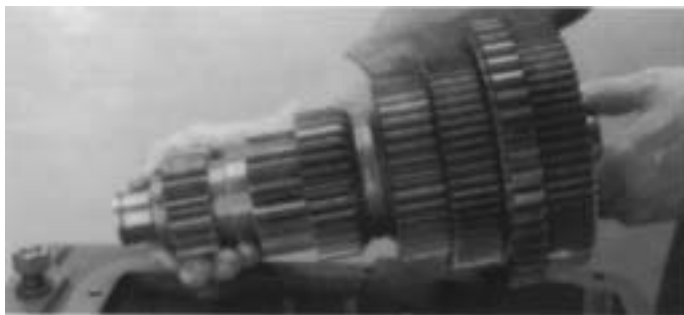

1. Move the right countershaft assembly to the rear as far as possible so front of shaft can be removed from case bore and moved to the center of the case. Lift the assembly from case and repeat the procedure for left countershaft assembly.

**NOTE:** The left and right reverse idler gear assemblies are identical and disassembled in the same manner. If removal and disassembly of this assembly is necessary, refer to Part B of this section.

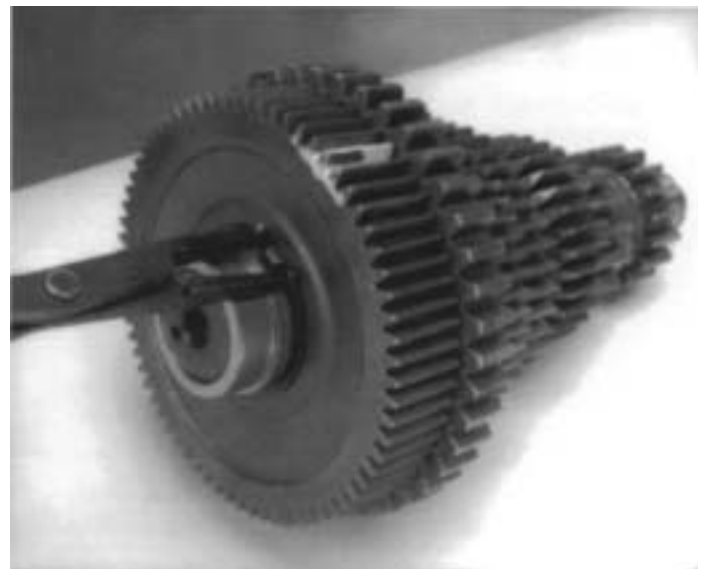

2. Remove the drive gear retaining snap ring from front of each countershaft.

# DISASSEMBLY - FRONT SECTION



3. Use the rear face of 3rd speed gear as a base, press the drive gear, PTO gear, and 3rd speed gear from each countershaft. This removes the front bearing inner race from the countershaft.  
**IMPORTANT: NEVER USE THE PTO GEAR AS A PRESSING BASE.** The narrow face width of this gear makes it very susceptible to breakage.



5. If necessary, remove the keys and roll pin from the countershaft.



4. Use a rear face of 2nd speed gear as a base and press it off the countershaft.  
**NOTE:** You can not remove any more gears from the countershaft.

## G. Removal and Disassembly of Right Reverse Idler Gear Assembly

**NOTE:** To remove the right reverse idler gear assembly see section B. The right and left reverse idler gear assemblies are disassembled in the same manner.



# DISASSEMBLY-FRONT SECTION

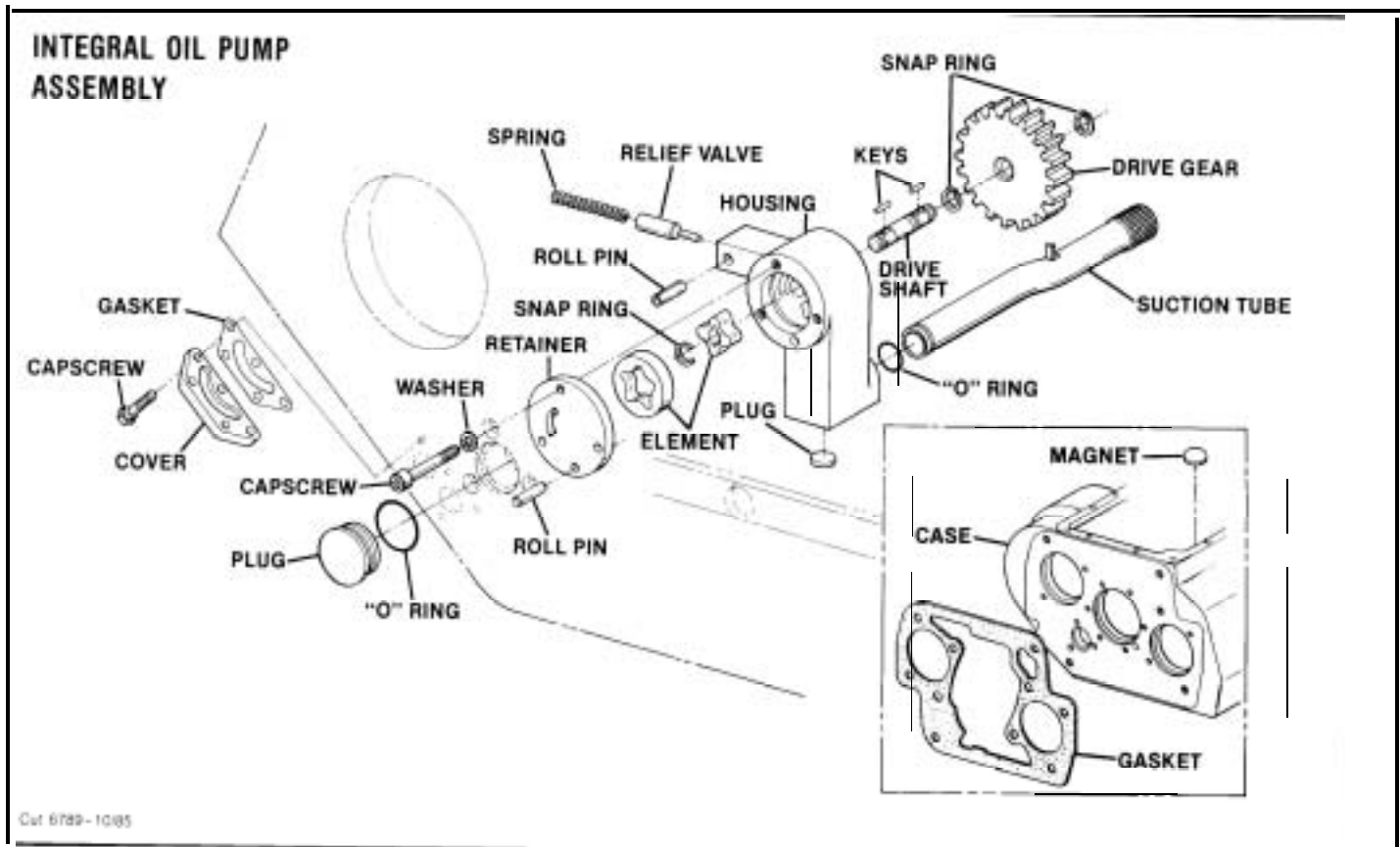

## H. Removed and Disassembly of Integral Oil Pump



1. Straighten locktang on suction tube (inset), remove suction tube from oil pump. If necessary remove O-ring from suction tube.

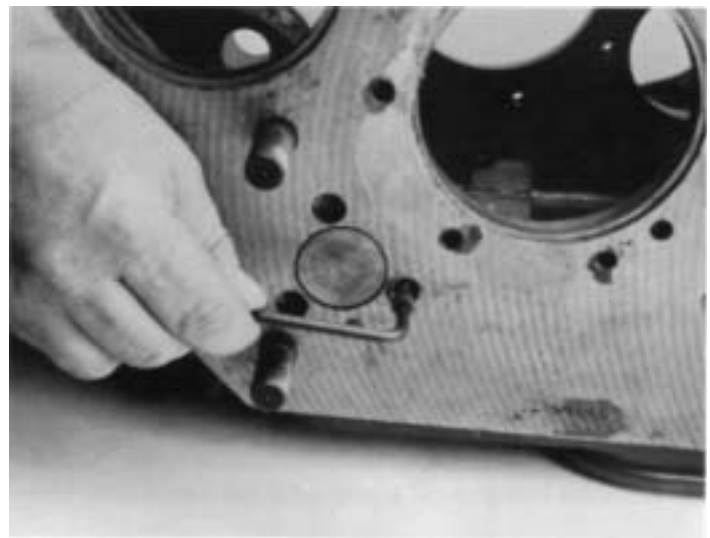

2. Remove three Allen head cap screws and washers that retain the integral oil pump to front of case.

# DISASSEMBLY-FRONT SECTION



3. Remove the integral oil pump from case.



5. Remove outer oil pump element from pump.



4. Remove integral oil pump retainer plate from case.



6. Remove drive gear retaining snap ring from drive shaft.

# DISASSEMBLY-FRONT SECTION

---

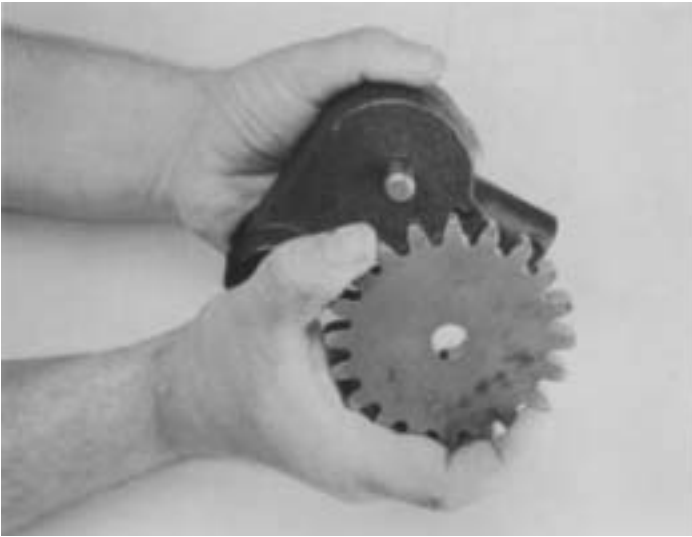

7. Remove drive gear from pump drive shaft



9. Remove element retaining snap ring from drive shaft.



8. Remove key from drive shaft keyway.



10. Remove internal oil pump element from drive shaft.

# DISASSEMBLY-FRONT SECTION



11. Remove two keys from drive shaft keyways.



14. Remove relief valve from housing bore.



12. Remove the drive shaft from integral oil pump housing. If necessary, remove rear drive gear retention snap ring from drive shaft.

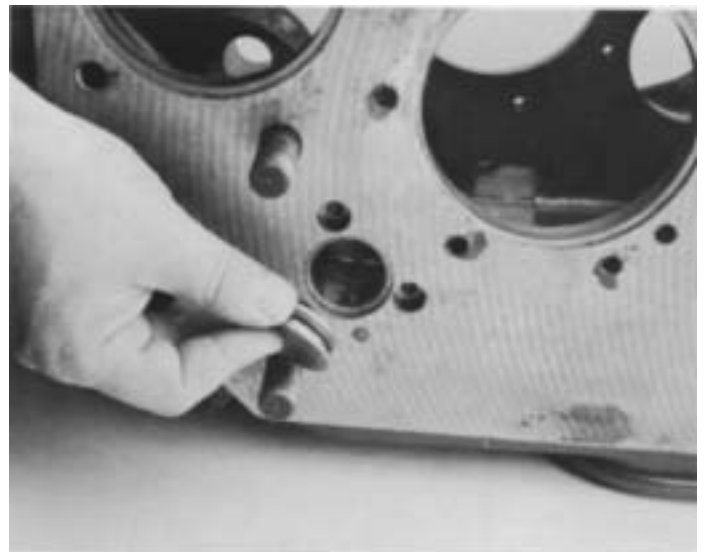

15. If necessary front case plug can be removed from case by driving the plug through front of case. Remove O-ring from O.D. of plug if necessary.



13. Remove relief valve roll pin from pump housing, relief valve spring can now be removed from relief valve housing bore (inset).

# DISASSEMBLY-FRONT SECTION

---

## 1. Disassembly Auxiliary Drive Gear Assembly

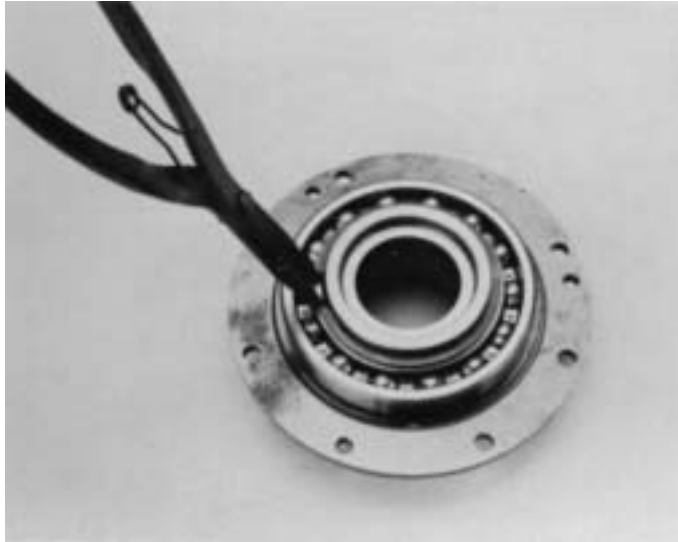

1. Remove the snap ring from hub of front auxiliary drive gear.



3. If necessary, remove the O-rings from hub O.D. of front auxiliary drive gear.



2. Using the rear face of retainer ring as a base, press the drive through bearing.

# REASSEMBLY-FRONT SECTION

---



1. If previously removed, install the O-rings on extended front hub of front auxiliary drive gear.



3. Start the front auxiliary drive gear bearing on front hub, bearing snap ring facing groove in retainer ring. Using both hands, press the bearing on gear with snap ring in groove of retainer ring (inset).

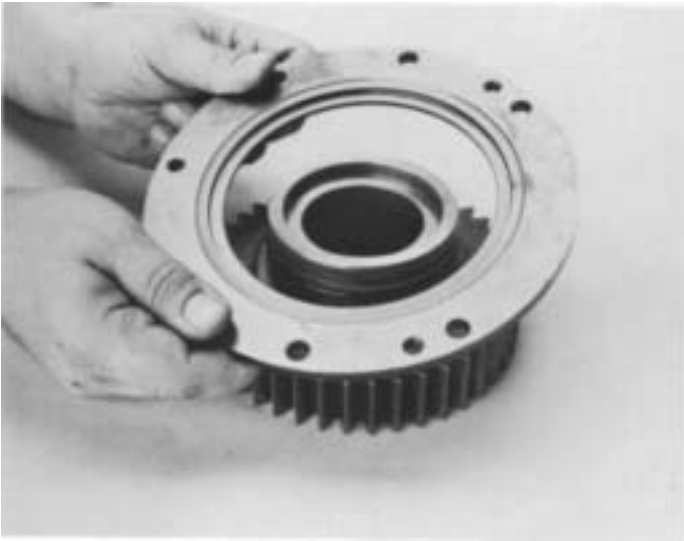

2. Install the retainer ring on front auxiliary drive gear, snap ring groove facing front hub and away from gear teeth.

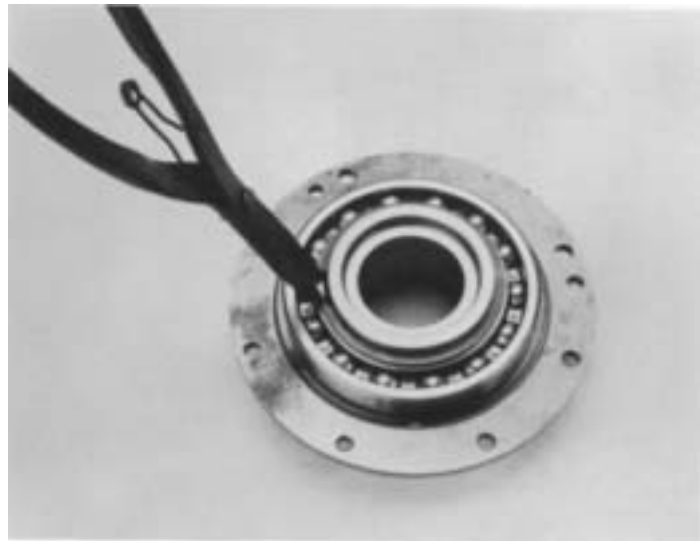

4. Install the snap ring in groove of front gear hub to retain bearing.

# REASSEMBLY-FRONT SECTION

---

## B. Reassembly and Installation of Integral Oil Pump



1. Replace O-ring on front case plug. Seat plug in front case bore with a maul.



3. Install relief valve spring in oil pump housing.



2. Install relief valve in intergral oil pump housing as shown.



4. Secure oil pump housing in a vice. Depress spring in housing bore and drive relief valve retention roll pin into roll pin bore.

# REASSEMBLY-FRONT SECTION



5. If removed replace drive shaft snap ring on pump drive shaft and insert drive shaft through pump housing bore as shown.



7. Install inner element retention snap ring in drive shaft snap ring groove.



6. Install two keys on drive shaft (inset), and install integral oil pump inner element on drive shaft, aligning keys on drive shaft with keyways on inner element.

**NOTE:** Place round key in the round keyway; square key in the square keyway.

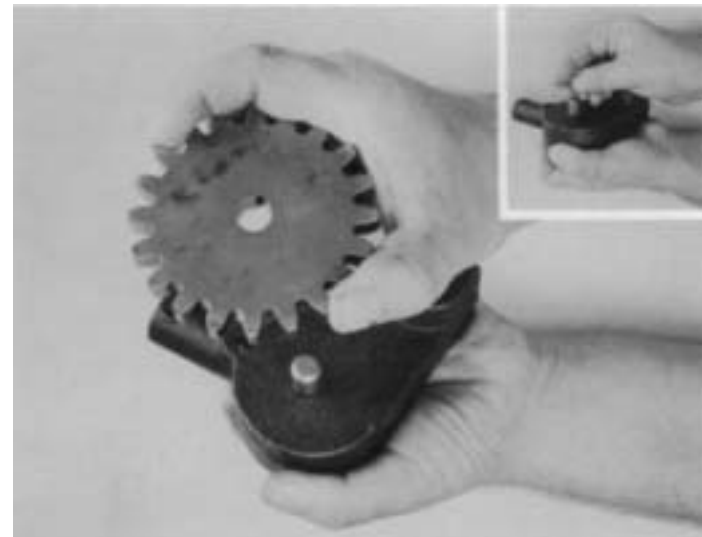

8. Install drive gear key in keyway of drive shaft (inset), install drive gear on drive shaft aligning keyway on drive gear with key on drive shaft.



# REASSEMBLY-FRONT SECTION

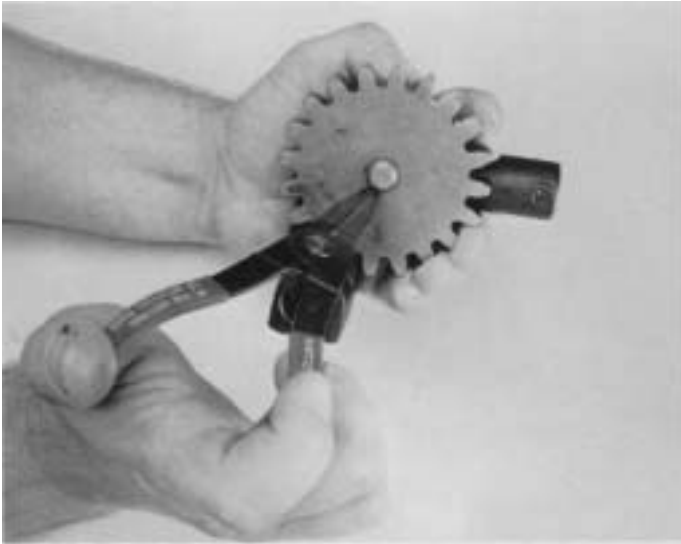

9. Install outer drive gear retention snap ring in groove of drive shaft.



11. Install integral oil pump retainer over alignment pin inside of case, bore in retainer facing rear of case.

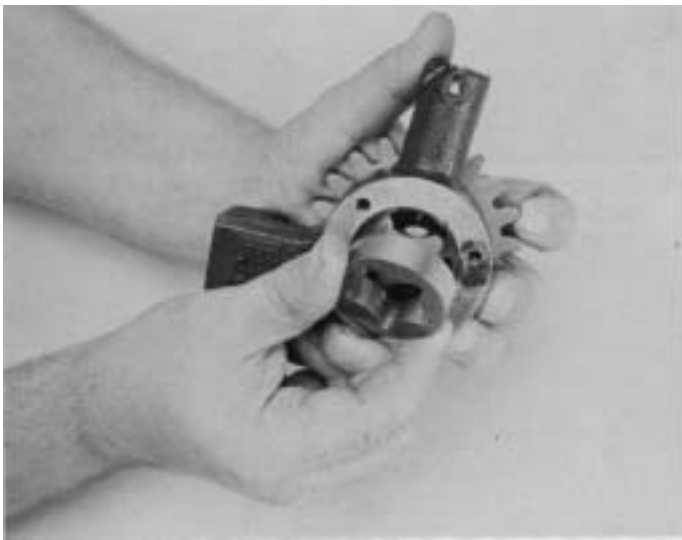

10. Install outer integral oil pump element over inner element.



12. Install integral oil pump assembly in case aligning front face of oil pump with retainer and alignment pin.

# REASSEMBLY-FRONT SECTION

---

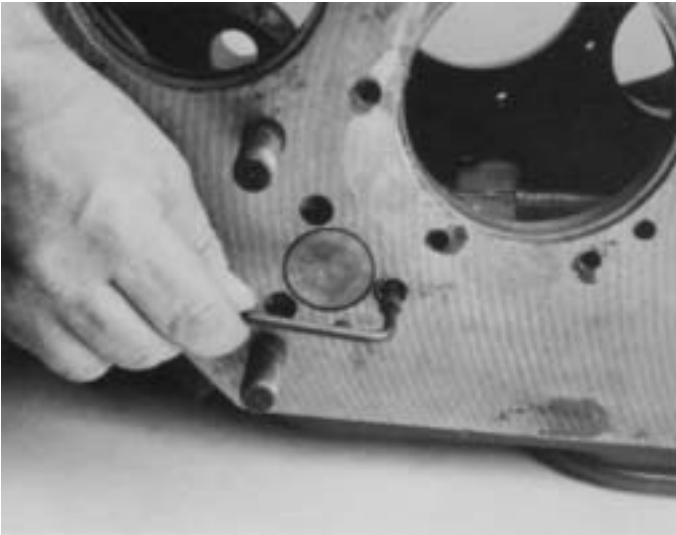

13. Install three cap screws and washers through front of case and into pump housing, tighten cap screws to recommended torque.



14. Replace O-ring on suction tube and install tube under case rib and into integral oil pump. Bend locktang of suction tube over case rib.

# REASSEMBLY - FRONT SECTION

## CASE ASSEMBLIES

**NOTE:** Before starting reassembly, make sure the three magnetic discs are solidly in place at bottom of case. These can be secured to disc mounting surfaces with Scotch Grip Rubber Adhesive or equivalent adhesive.

### C. Reassembly and Installation of Right Reverse Idler Gear Assembly

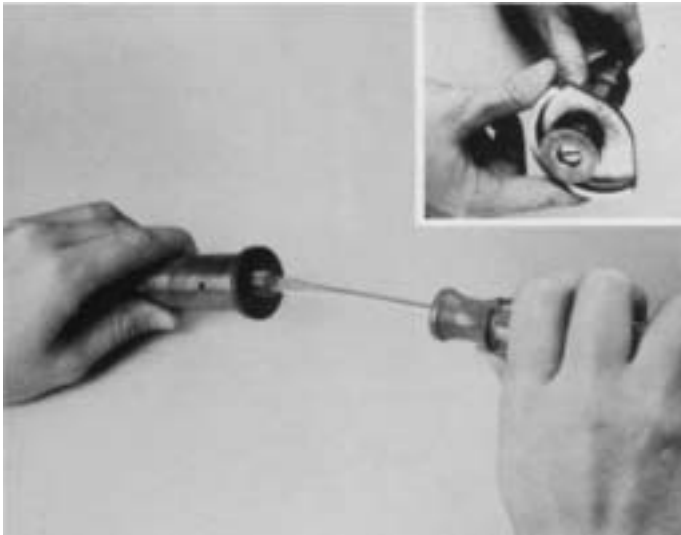

1. If previously removed, thread pipe plug in rear of reverse idler shaft and tighten. Install the thrust washer to the end of the idler shaft.

**NOTE:** If previously removed, replace the needle bearing into bore of reverse idler gear.

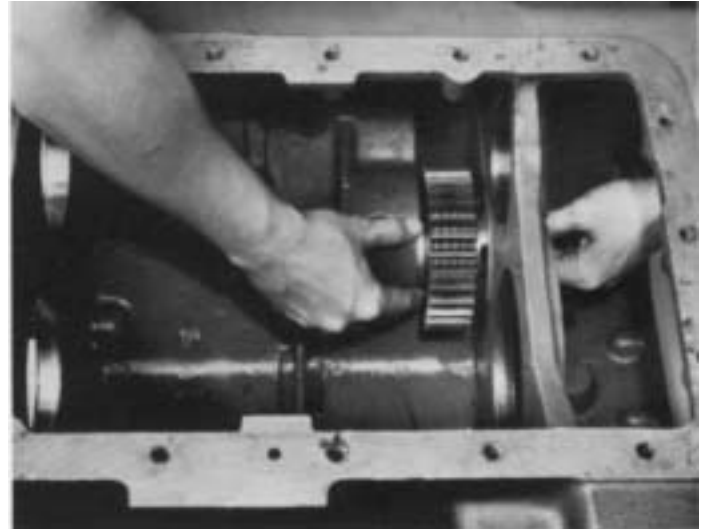

2. Install the bearing inner race on idler shaft and insert shaft into case bore, threaded-end of shaft to the front. As the idler shaft is moved forward, install the reverse idler gear on shaft, long hub to the front and seating on bearing inner race. Position the thrust washer on shaft between the gear and support boss in case and continue with movement of idler shaft forward into bore of Support boss.

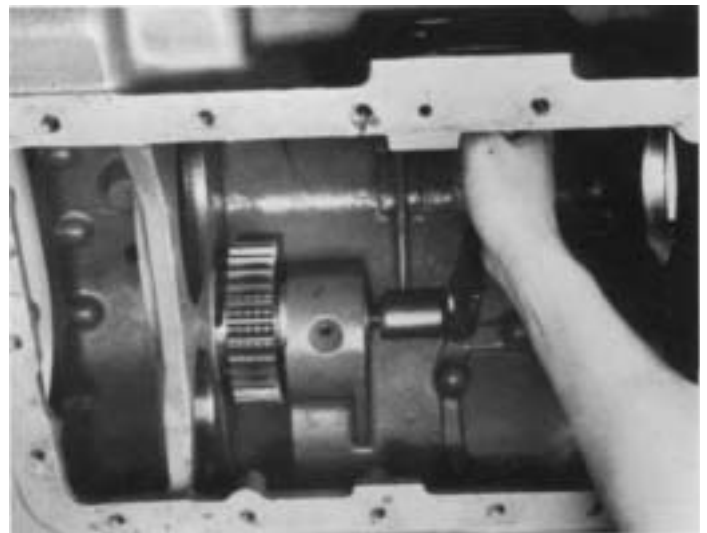

3. Making sure that the reverse idler shaft is seated in bore of support boss and forward as far as possible, install the washer and stop nut on front of shaft. Tighten nut to recommended torque rating.

# REASSEMBLY - FRONT SECTION

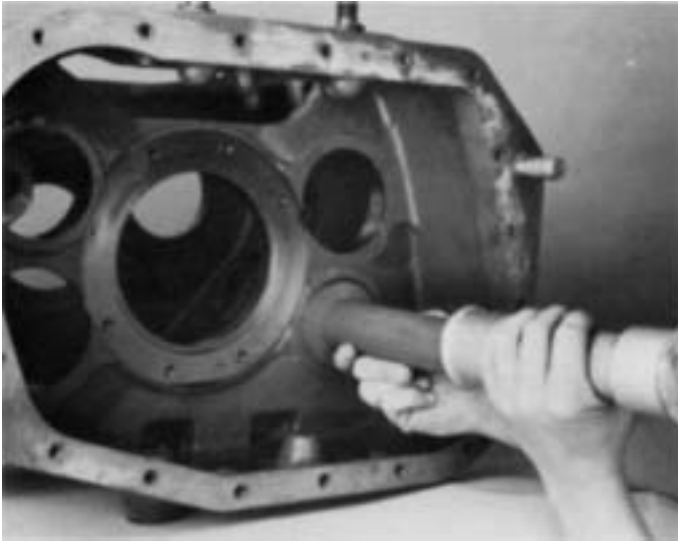

5. Install the OUTER RACE of auxiliary countershaft front bearing into case bore and against idler plate.

**NOTE:** The bearing INNER RACE is installed on front of auxiliary countershaft and never with outer race.

## D. Reassembly of Countershaft Assemblies

**NOTE:** Except for the PTO gears, the left and right countershaft assemblies are identical and reassembled in the same manner.



2. Align gear keyway with countershaft key and press 2nd speed gear on the countershaft, long hub of gear to countershaft rear.



1. If previously removed, install the roll pin and key in keyway of countershaft.

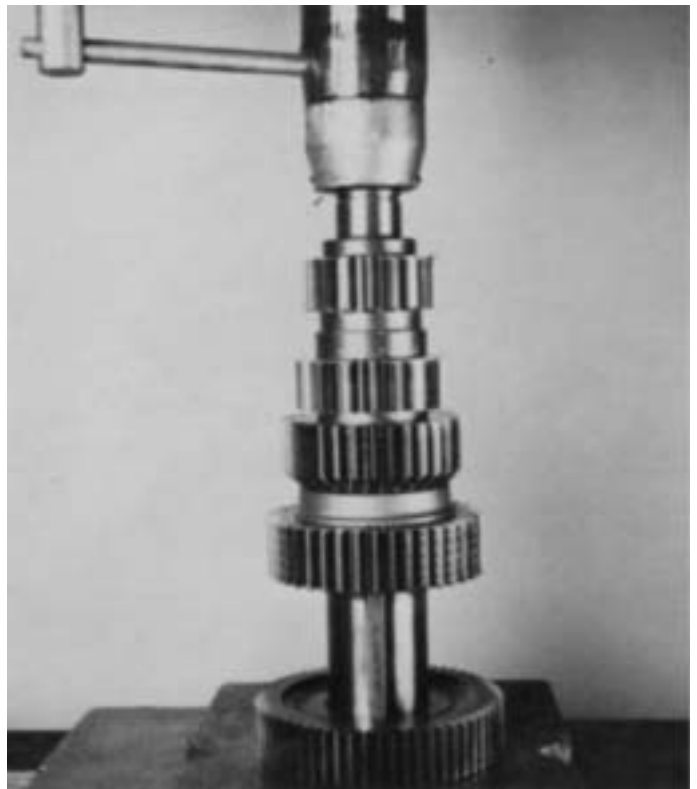

3. Press the 3rd speed gear on the countershaft, long hub of gear to countershaft front.

# REASSEMBLY - FRONT SECTION



2. Start the PTO gear onto countershaft, bullet-nose side of teeth facing up and toward rear of shaft. Align keyway of drive gear with key in countershaft and press BOTH gears onto shaft, long hub of drive gear against PTO gear.

**NOTE:** The left countershaft assembly has a 47-tooth PTO gear; the right countershaft assembly has a 45-tooth PTO gear.

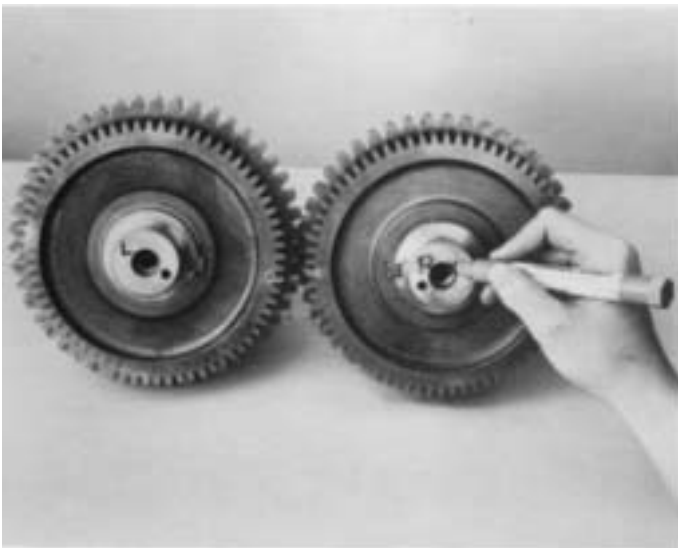

3. To avoid confusion during installation, mark the end of left countershaft with an "L", the end of right countershaft with an "R".



4. Install the drive gear retaining snap ring in groove on front of each countershaft.



5. Use a flanged-end driver to install bearing inner race on countershaft, shoulder of race against shoulder of countershaft.

# REASSEMBLY - FRONT SECTION

---

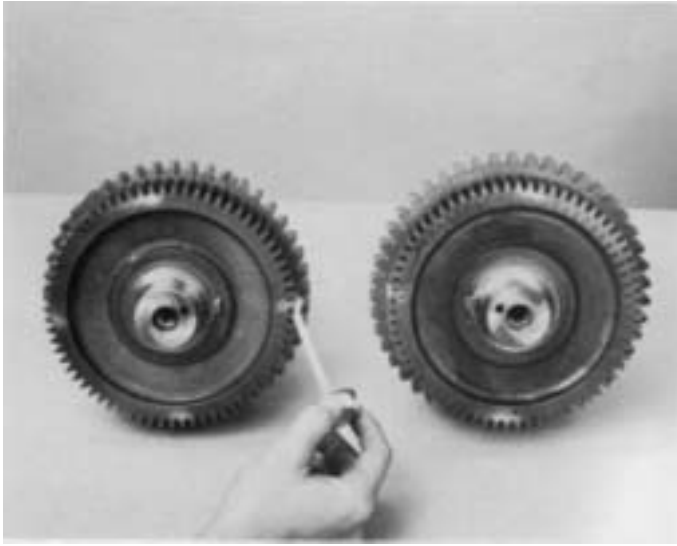

**IMPORTANT:** Mark the countershaft drive gear for timing purposes. On the drive gear of each countershaft assembly, mark the tooth aligned with keyway of gear and stamped with an "O" for easy identification. A highly visible color of toolmakers' dye is recommended for making timing marks.

## E. Partial Installation of Countershaft Assemblies

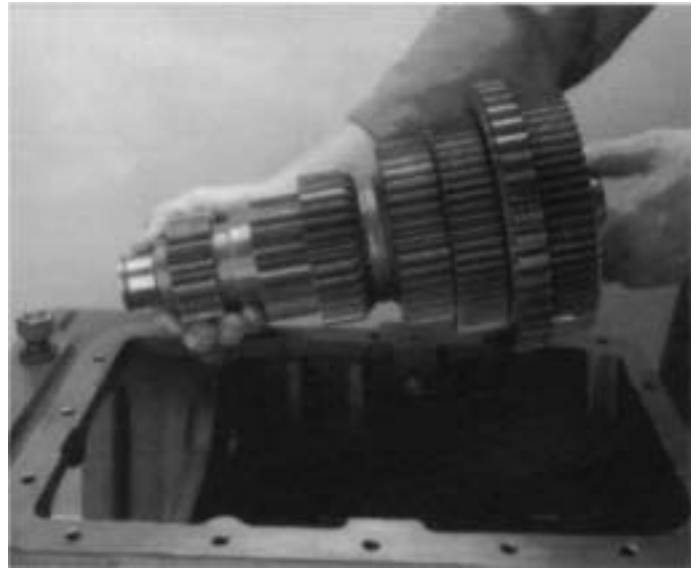

1. Place the left countershaft assembly into position in case, making sure that the "L"-marked assembly has the larger 47-tooth PTO gear. Place the right countershaft assembly into position in case, making sure that the "R"-marked assembly has the smaller 45-tooth PTO gear.

# REASSEMBLY-FRONT SECTION

## F. Bearing Installation of Left Countershaft Assembly



1. Move the left countershaft assembly to the rear and insert countershaft support tool or blocking to center shaft in rear case bore.



3. Center the front of left countershaft in bearing and move the assembly forward.



2. Use a flanged-end bearing driver to start the bearing in case bore.

NOTE: The inner race of roller-type front bearing is pressed on front of countershaft.



4. Use a flanged-end bearing driver to completely seat front bearing or bearing outer race in case bore.

# REASSEMBLY-FRONT SECTION

## G. Reassembly, Installation and Timing of Main Drive Gear Assembly



5. Position the retainer plate on front of left countershaft, roll pin in hole at end of shaft, and secure with capscrew tightening to recommended torque.

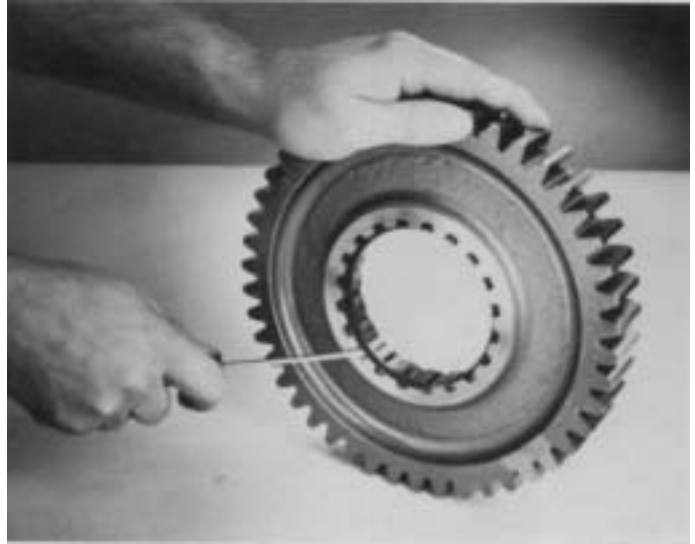

1. Install the snap ring in I.D. of main drive gear.



6. Remove countershaft support tool or blocking from rear case bore and install the left countershaft rear bearing with larger I.D. lead chamfer to the front of shaft and install the snap ring in groove at rear of left countershaft.



2. Mark the main drive gear for timing purposes. Mark any two adjacent teeth on drive gear and repeat the procedure for the two adjacent teeth directly opposite the first set marked. A highly visible color of toolmakers' dye is recommended for making timing marks.



# REASSEMBLY-FRONT SECTION

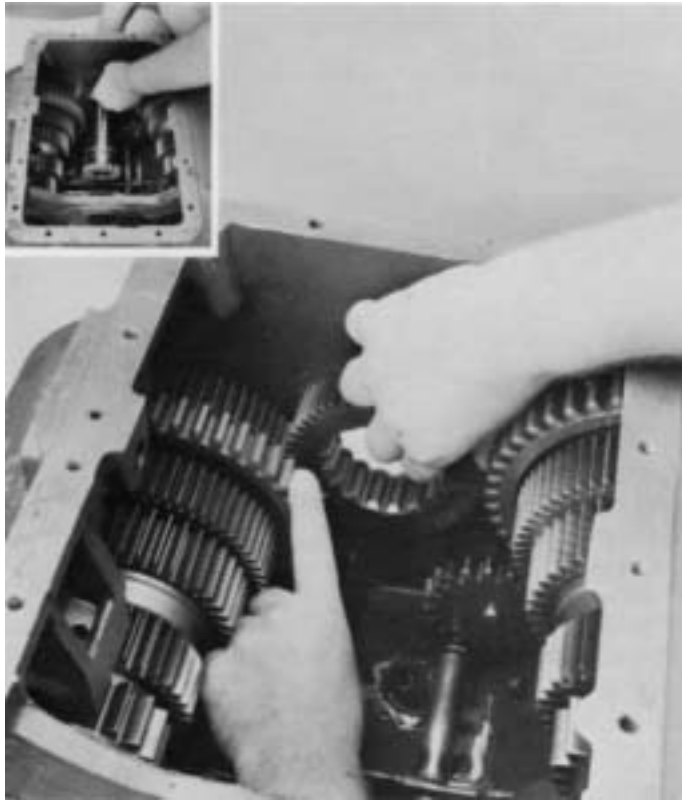

3. Mesh the marked tooth of left countershaft drive gear with either set of two marked teeth on main drive gear. Slide the input shaft through the main drive gear (inset).

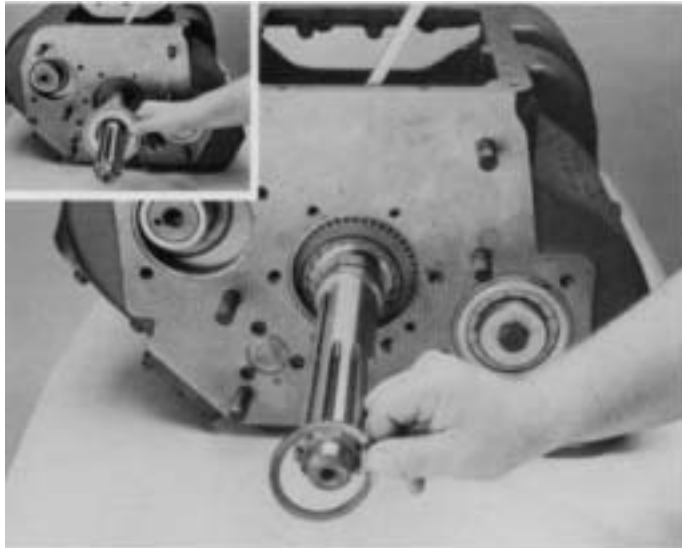

4. Install drive gear spacer. Install the bearing on the input shaft with external snap ring to the outside (inset).

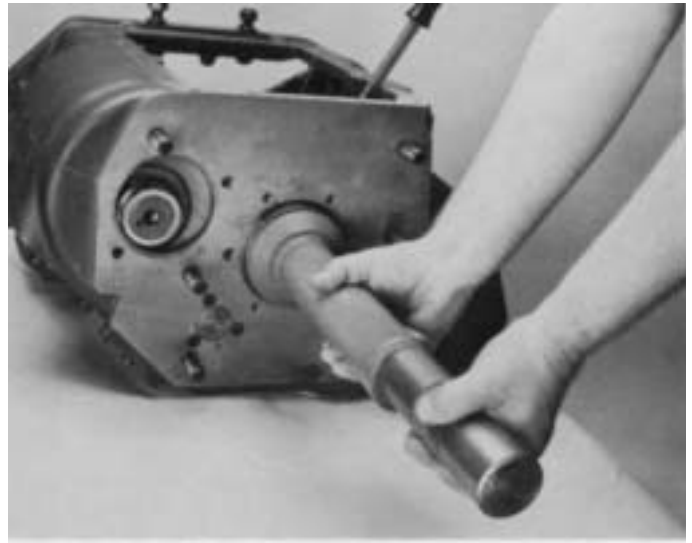

5. Install drive gear bearing on input shaft, seat bearing into case bore with proper bearing driver.

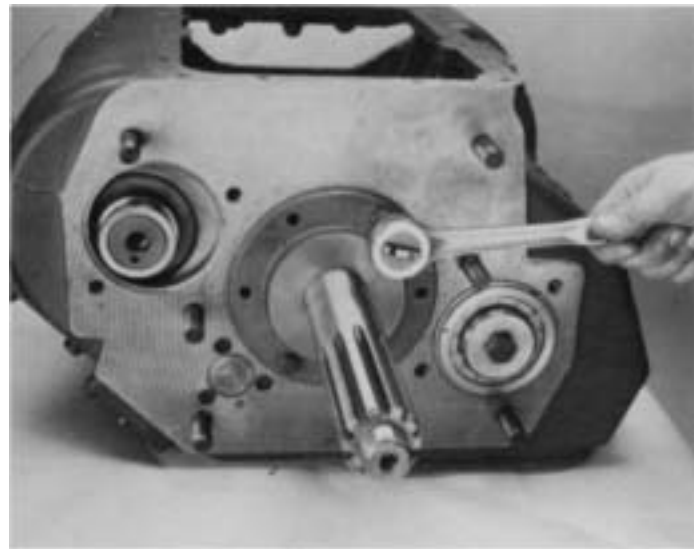

6. Temporarily install the front bearing cover.

# REASSEMBLY-FRONT SECTION

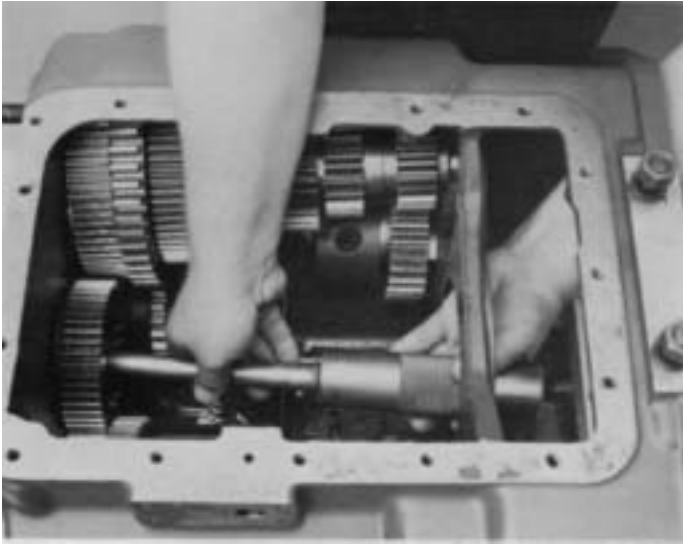

7. Use a soft bar and maul to drive the input shaft through bearing. Remove front bearing cover.

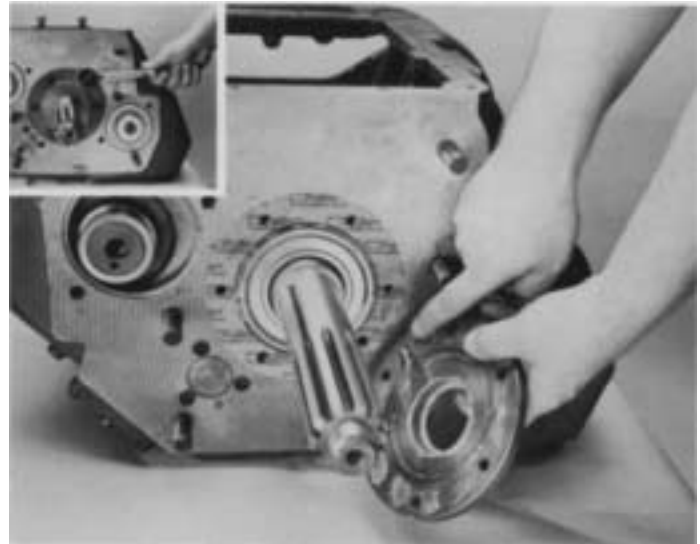

9. Install front bearing cover and gasket, making sure to align the oil return hole in the case with hole in cover. Secure the front bearing cover on case with six cap screws, tighten to recommended torque (inset).



8. Install bearing retainer snap ring.

# REASSEMBLY - FRONT SECTION

## H. Reassembly and Partial Installation of Mainshaft Assembly

1. If previously removed, install the corresponding snap rings in I.D. of mainshaft gears.

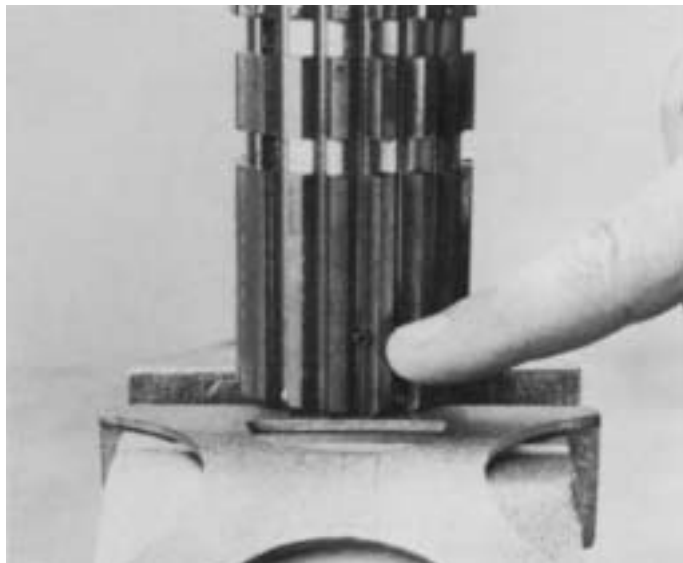

2. Secure the mainshaft in a vise equipped with brass jaws or wood blocks, pilot-end of shaft down. If previously removed, install the roll pin in keyway.

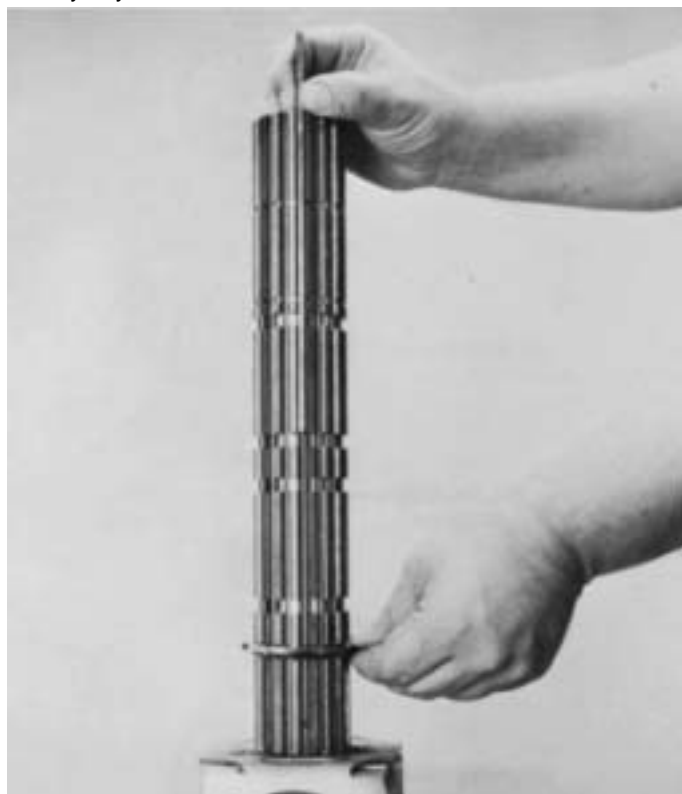

3. Install the 3rd speed gear limit washer on mainshaft, flat side of washer up. Rotate washer in the 1st or bottom groove of mainshaft to align the splines of washer with those of the mainshaft. install the key in mainshaft keyway to lock washer in place.

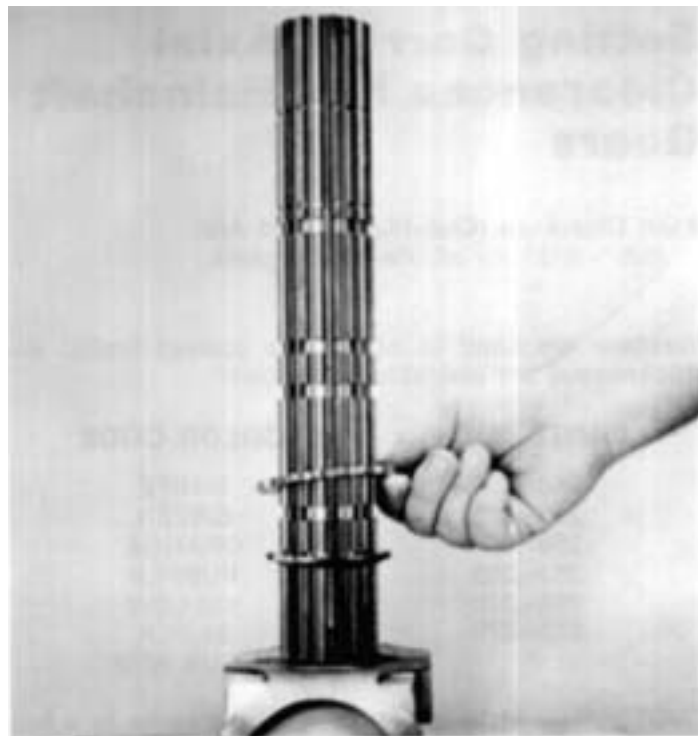

4. Install the spacer on shaft against washer.



5. Install the 3rd speed gear on mainshaft, clutching teeth down and engaged with external splines of spacer.

**NOTE:** Gear limit washers are internally splined and locked to mainshaft by the key. Gear spacers are externally splined to engage with clutching teeth in gear hubs. There is one limit washer and one spacer for each gear in the mainshaft assembly.

# REASSEMBLY—FRONT SECTION

## Setting Correct Axial Clearances For Mainshaft Gears

**Axial Clearance (End-Play) Limits Are:**  
 .005" -.012" for all mainshaft gears

Washers are used to obtain the correct limits; six thicknesses are available as follows:

LIMITS (INCH)	COLOR CODE
.248 -.250	WHITE
.253 -.255	GREEN
.258 -.260	ORANGE
.263 -.265	PURPLE
.268 -.270	YELLOW
.273 -.275	BLACK
	"PLUS RED"

**\*NOTE:** New style tolerance washers come in a full range of tolerances as corresponding colors listed above "plus red." (Example: "Orange plus red" limit washer has an inch limit thickness of .258-.260.)

Refer to Illustrated Parts Lists for washer part numbers.

Always use the .248 -.250 tolerance washer ("White" or "white plus red") in the reverse, LO and 2nd speed gear positions as shown at right.

**IMPORTANT: REFER TO THE APPROPRIATE ILLUSTRATED PARTS LIST (SPECIFIED BY MODEL SERIES) TO ENSURE THAT PROPER PARTS ARE USED DURING REASSEMBLY OF THE TRANSMISSION.**

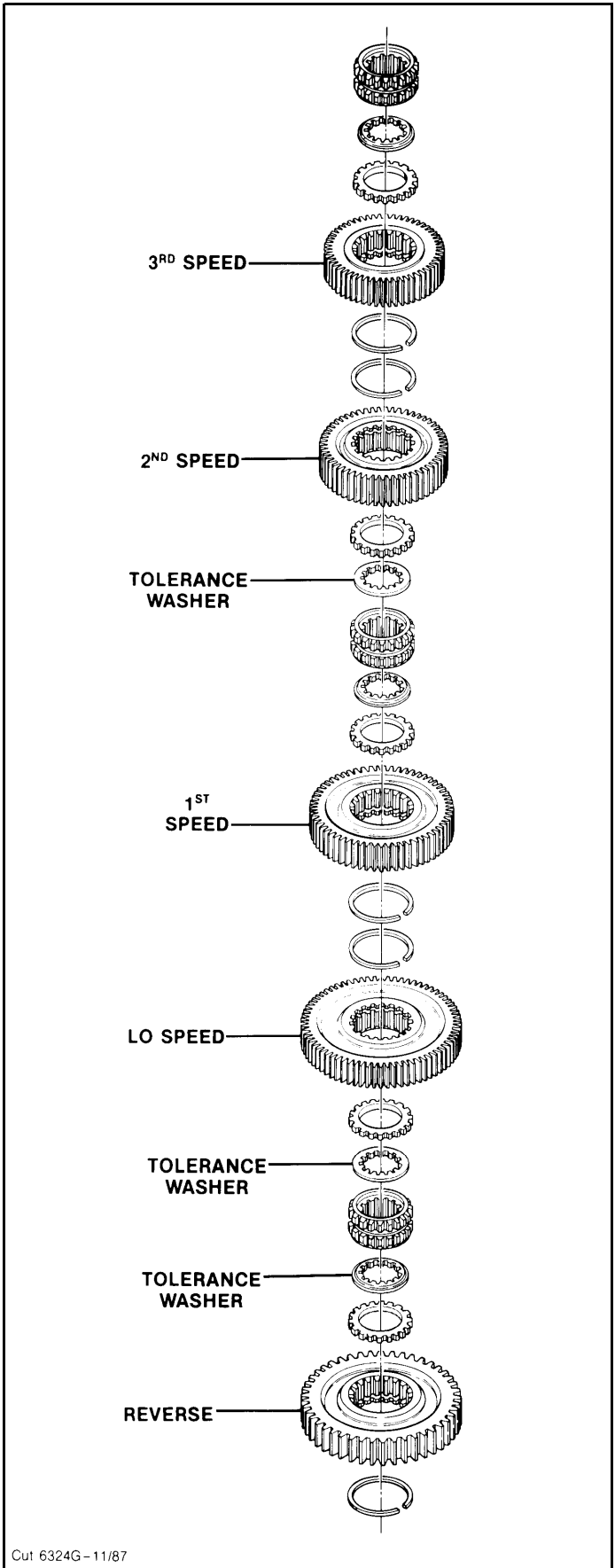

Cut 6324G-11/87

# REASSEMBLY-FRONT SECTION

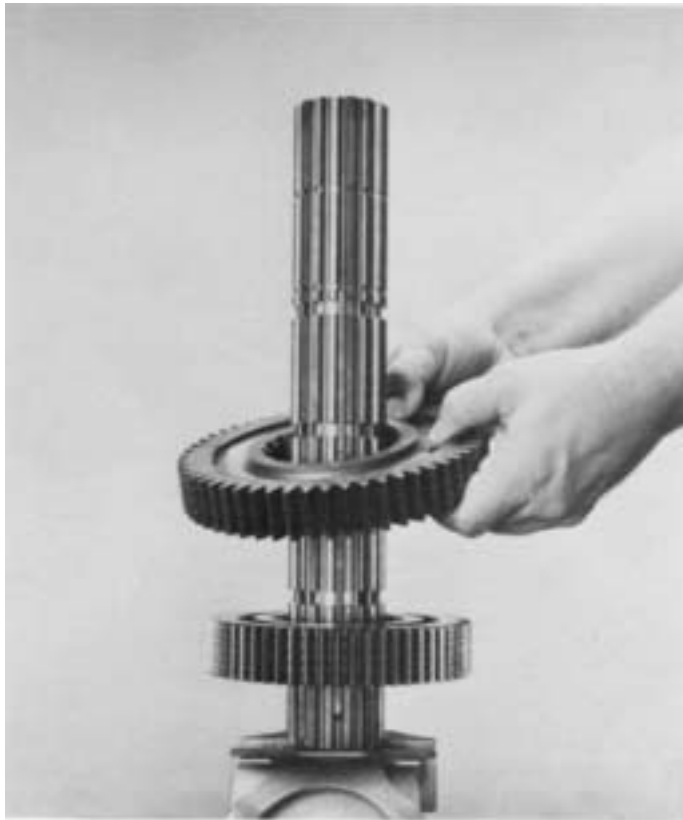

6. Install the 2nd speed gear on shaft against 3rd speed gear, clutching teeth up.

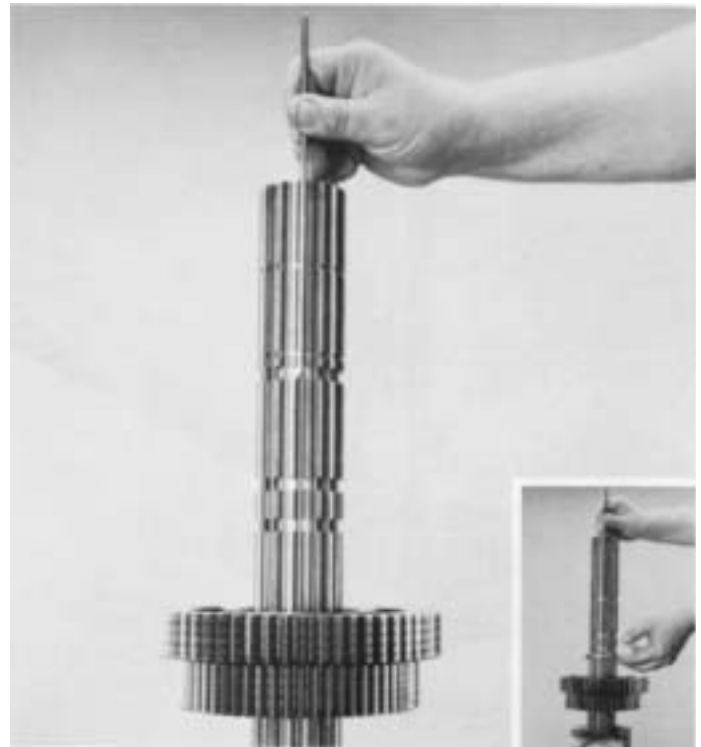

8. Remove the key from keyway and install the 2nd speed gear limit washer on mainshaft, flat side of washer down and against spacer. Rotate washer in the 2nd groove of mainshaft to align the splines of washer with those of the mainshaft and reinsert key in keyway to lock washer in place (inset).

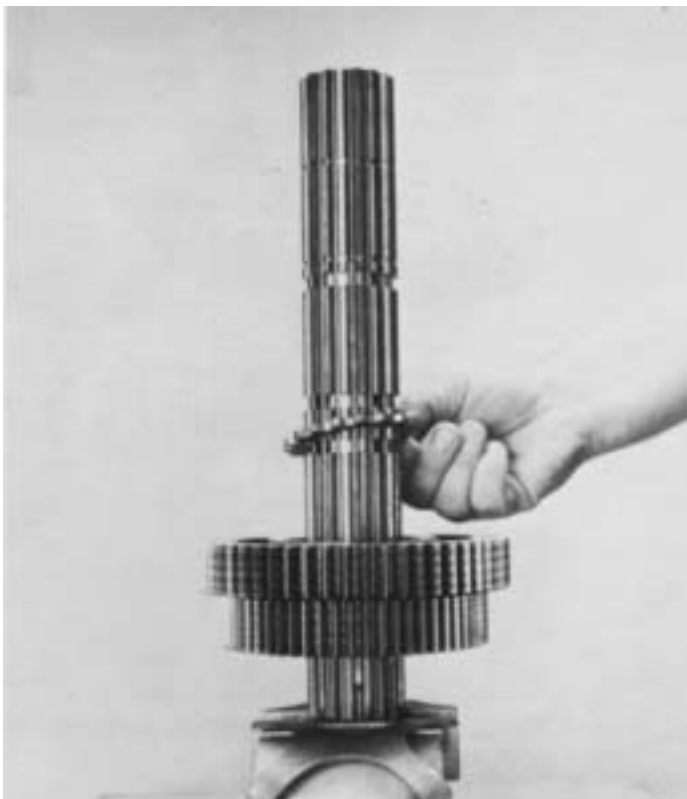

7. Install the spacer in 2nd speed gear, engaging the external splines of spacer with clutching teeth of gear.

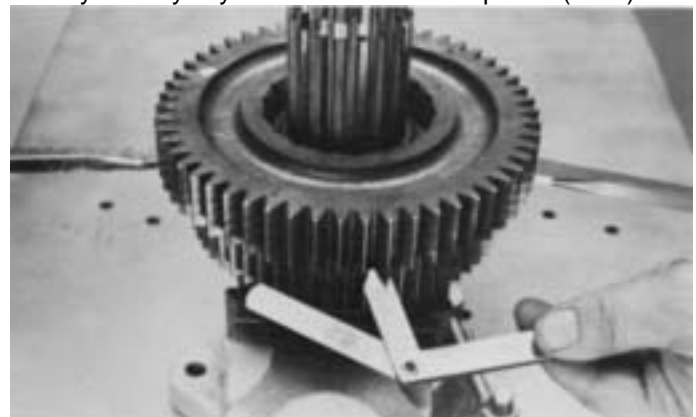

9. Insert two large screwdrivers between the 2nd and 3rd speed gears to check axial clearances. Apply slight downward pressure on screwdriver handles to spread gears evenly. Making sure the gear hubs are parallel, insert a feeler gage between hubs. Correct axial clearance is less than the minimum .005" to .012". If the clearance is less than the minimum .005" tolerance, the limit washer in the 2nd speed gear should be replaced by a thinner limit washer. This will increase the axial clearance between the gears. If the clearance checked is greater than the maximum .012" tolerance, a thicker limit washer should be installed in the 2nd speed gear. This would decrease the axial clearance between the gears.

# REASSEMBLY-FRONT SECTION

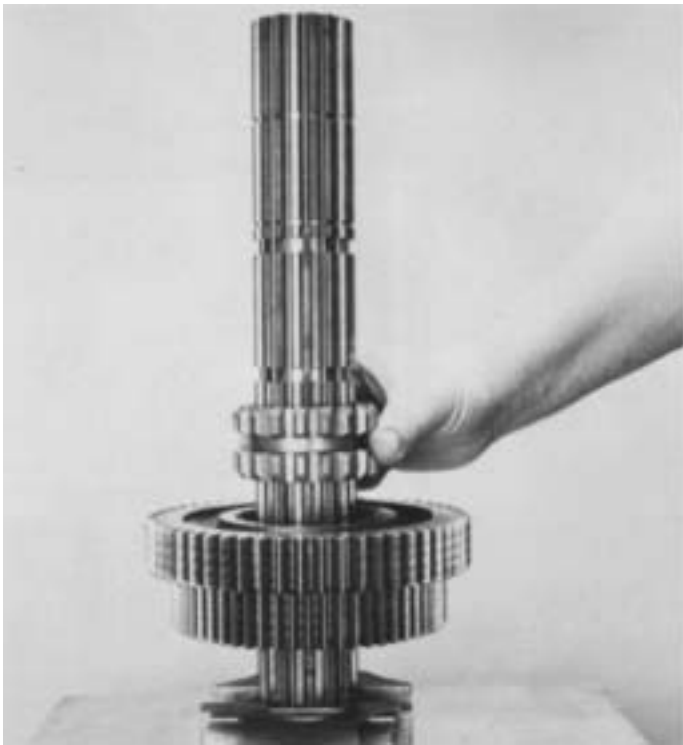

10. Install the 1st-2nd speed sliding clutch, aligning the missing internal spline of sliding clutch with key in mainshaft.

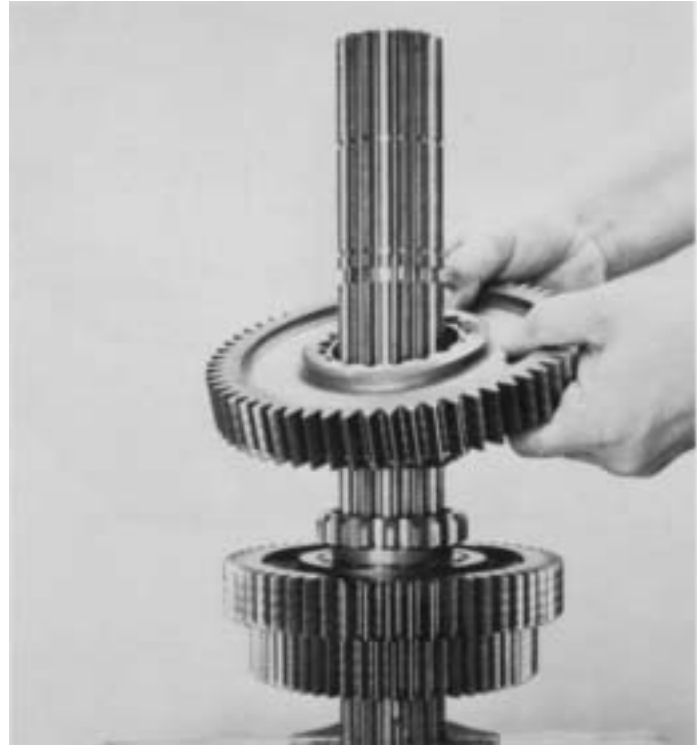

12. Install spacer and 1st speed gear on the mainshaft, clutching teeth down and engaged with external splines of spacer.

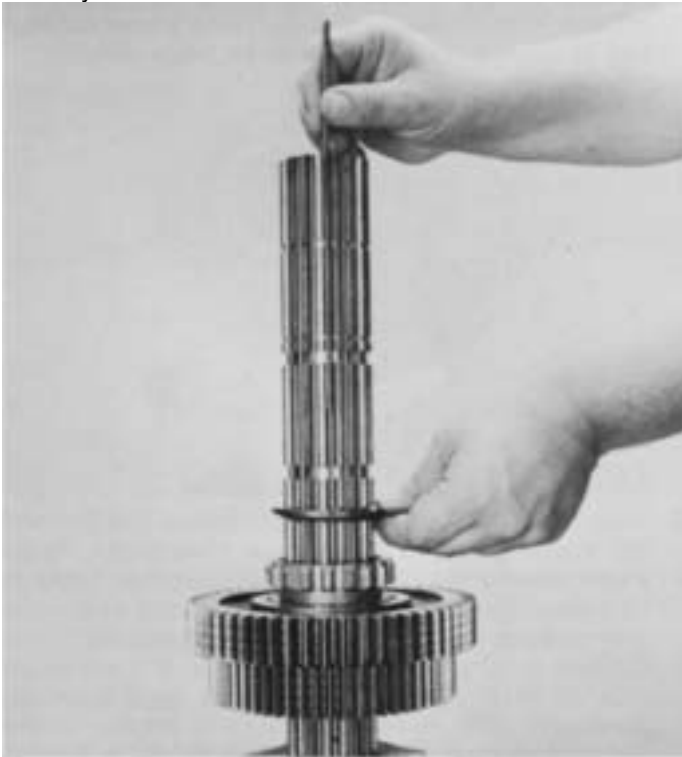

11. Remove the key from keyway and install the 1st speed gear limit washer on mainshaft, flat side of washer up. Rotate washer in the 2nd groove of mainshaft to align the splines of washer with those of the mainshaft and reinsert key in keyway to lock washer in place.

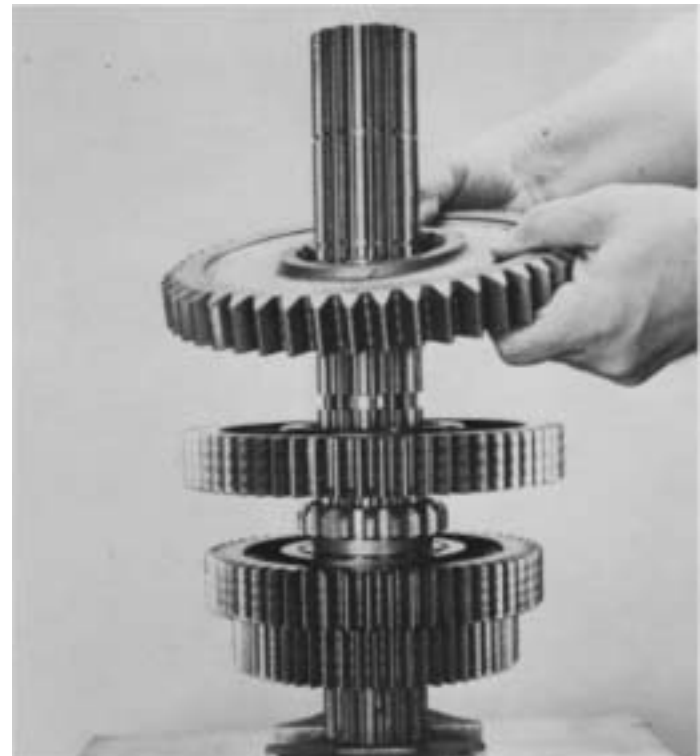

13. Install the LO speed gear on shaft against 1st speed gear, clutching teeth up.

# REASSEMBLY-FRONT SECTION

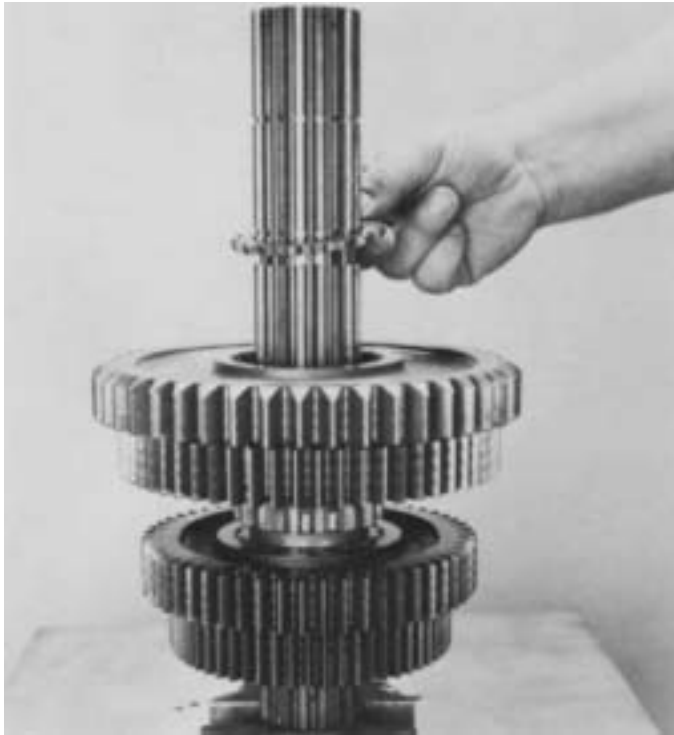

14. Install the spacer in LO speed gear, engaging the external splines of spacer with clutching teeth of

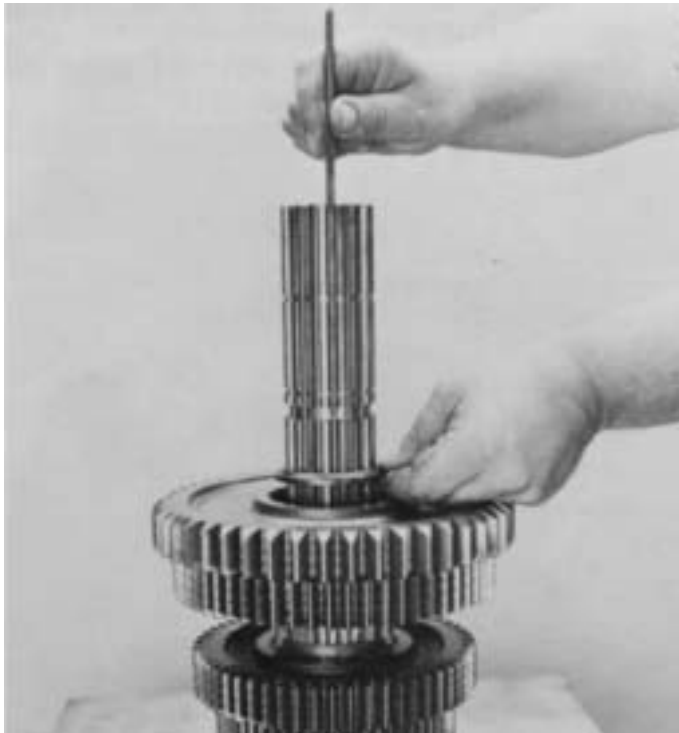

15. Remove the key from keyway and install the LO speed gear limit washer on mainshaft, flat side of washer down and against spacer. Rotate washer in the 4th groove of mainshaft to align the splines of washer with those of the mainshaft and reinsert key in keyway to lock washer in place.

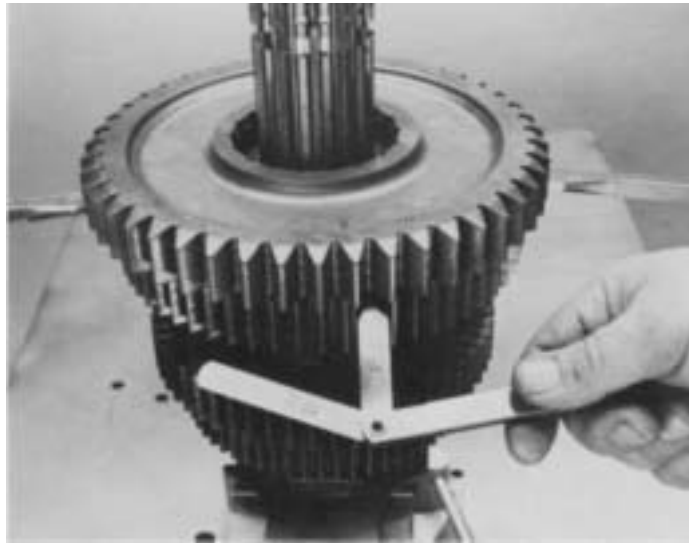

16. Check axial clearances and make adjustments, if necessary, between the LO and 1st speed gears as described in No. 9 of this section.

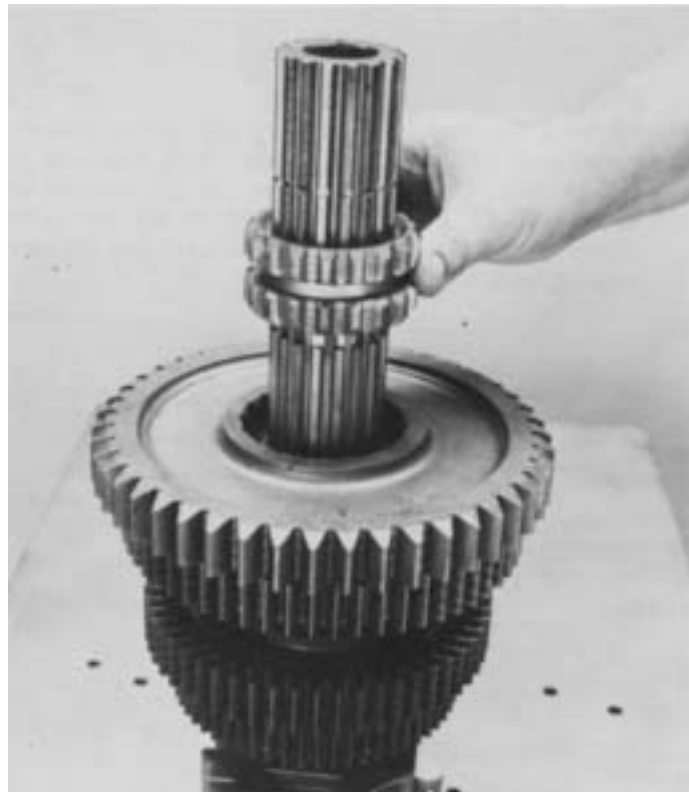

17. Install the LO-Reverse speed sliding clutch, aligning the missing internal spline of sliding clutch with key in mainshaft.

# REASSEMBLY - FRONT SECTION

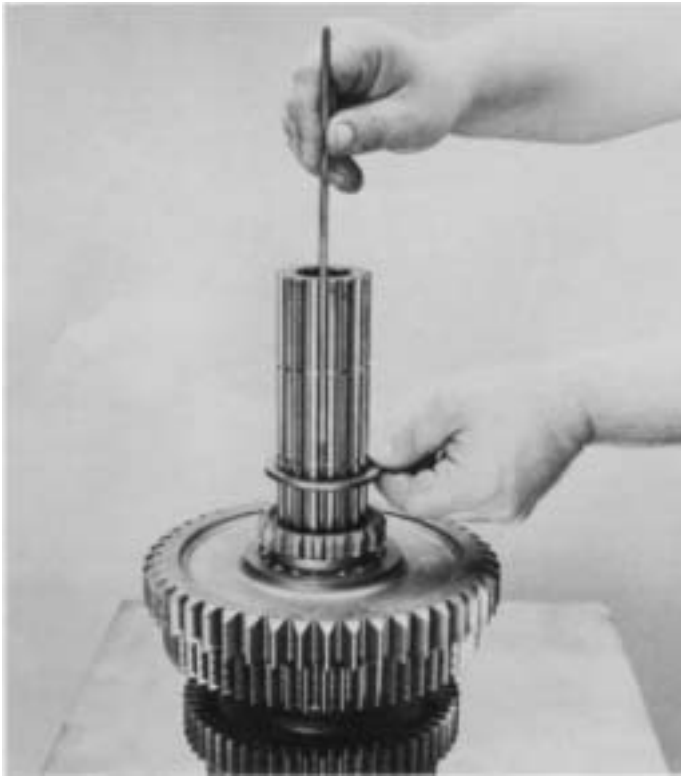

18. Remove the key from keyway and install the reverse gear limit washer on mainshaft, flat side of washer up. Rotate washer in the 5th groove of mainshaft to align the splines of washer with those of the mainshaft and reinsert key in keyway to lock washer in place.

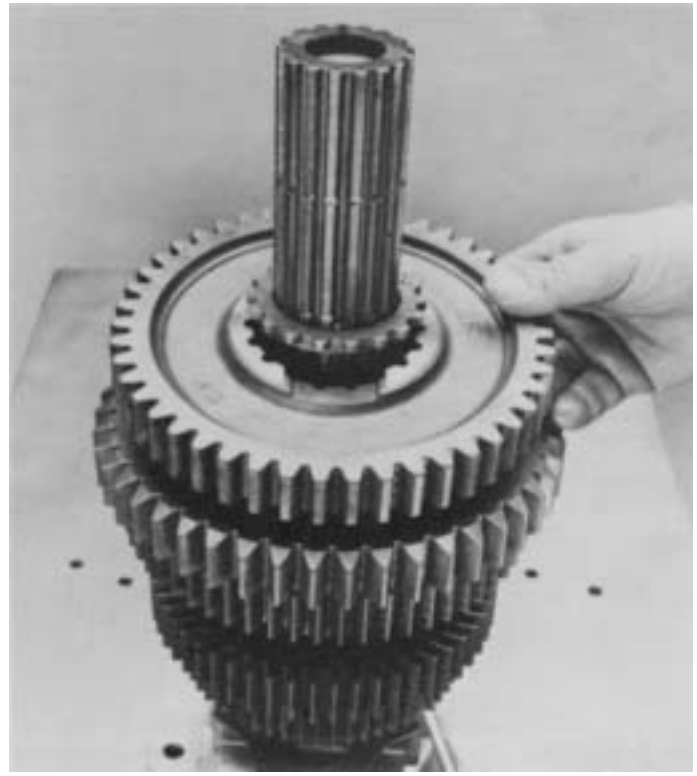

20. Install reverse gear on mainshaft. Engage the clutching teeth of gear with splines of spacer and sliding clutch and move the reverse gear against the LO speed gear.

**NOTE:** DO NOT REPLACE REVERSE GEAR INTERNAL SNAP RING AT THIS STEP

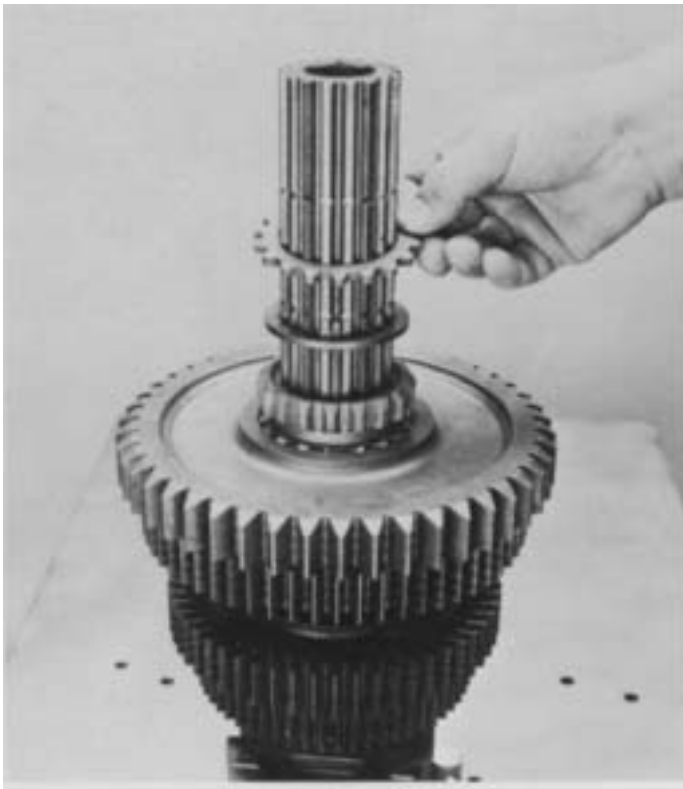

19. Install the spacer on shaft against washer.



21. Remove the mainshaft assembly from vise. Align the missing internal spline of 3rd-4th speed sliding clutch with key in mainshaft and install on front of shaft, engaging the external splines of sliding clutch with clutching teeth of 3rd speed gear.



# REASSEMBLY FRONT SECTION



22. Block the right countershaft assembly against case wall and lower the mainshaft assembly into position with the reverse gear held against LO speed gear and rear of shaft moved into case bore.



24. With the reverse gear remaining against LO speed gear, mesh the corresponding forward speed gears of left countershaft assembly. Check to make sure that marked tooth on left countershaft drive gear has remained in mesh with marked set of teeth on main drive gear.

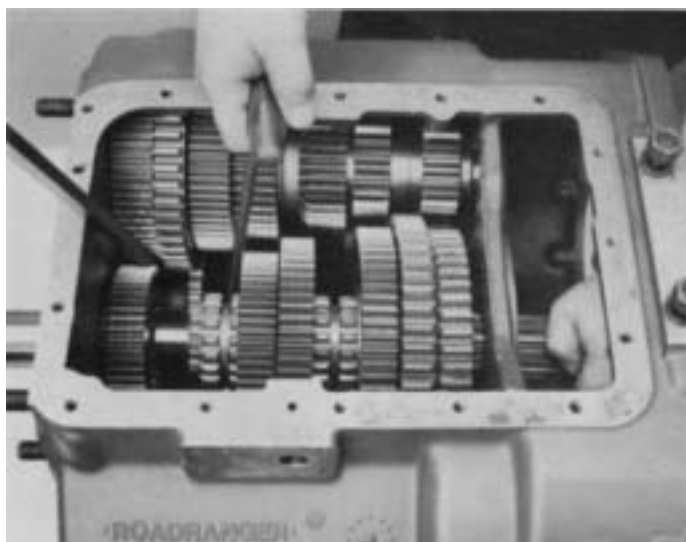

23. Move the pilot-end of mainshaft into pocket bushing of input shaft.



25. Center rear of mainshaft in case bore and install the auxiliary drive gear assembly on shaft, partially seating the bearing in bore. DO NOT COMPLETE INSTALLATION AT THIS TIME.

# REASSEMBLY FRONT SECTION

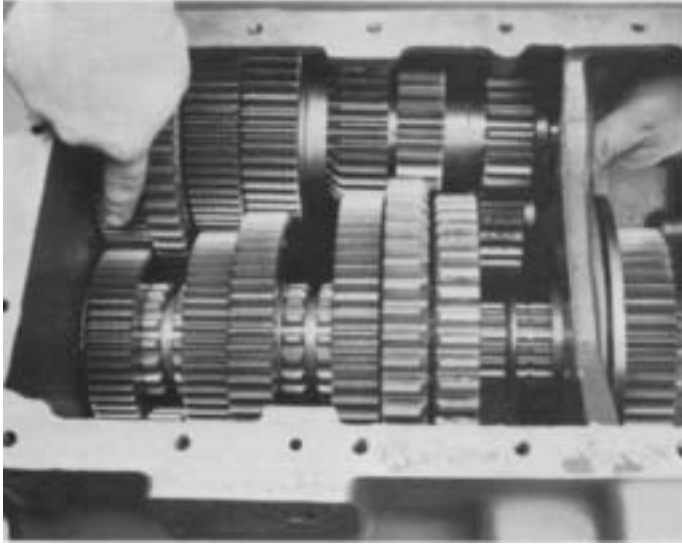

1. Remove blocking from right countershaft assembly and place it parallel to mainshaft assembly. Mesh the marked tooth of right countershaft drive gear with remaining set of two marked teeth on main drive gear.

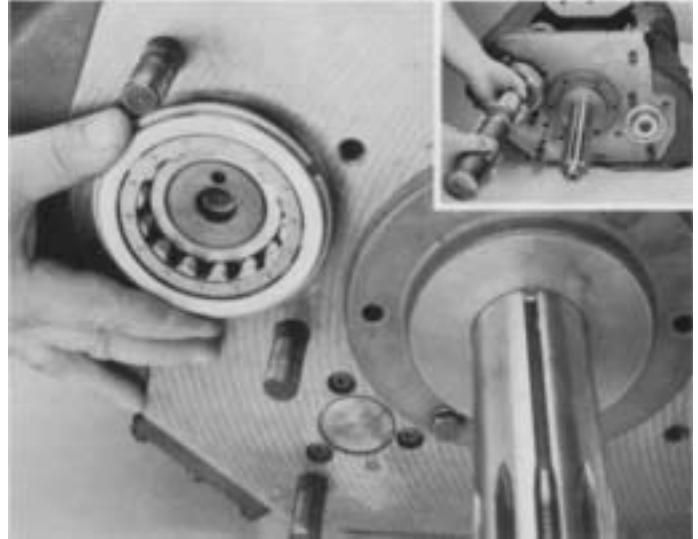

3. Position the front countershaft bearing in front bearing bore. Use the proper bearing driver to set the bearing (inset).

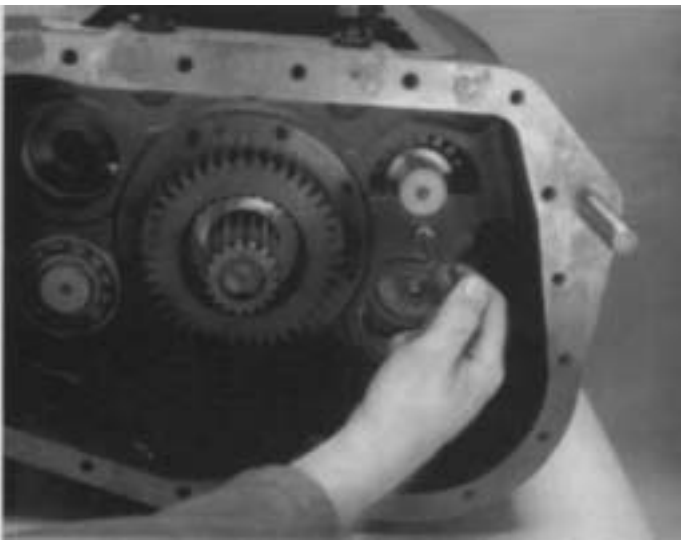

2. Insert countershaft support tool or blocking in rear bearing bore.

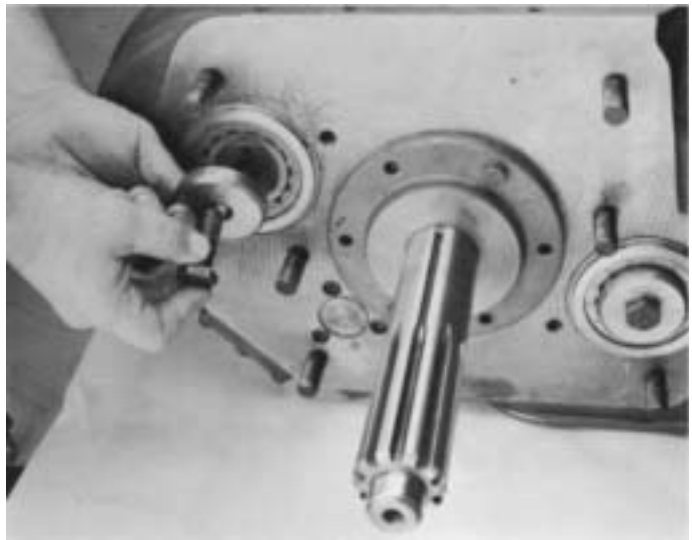

4. Install retainer washer and capscrew. Make sure to match roll pin in retainer with inner bearing hole.

# REASSEMBLY - FRONT SECTION

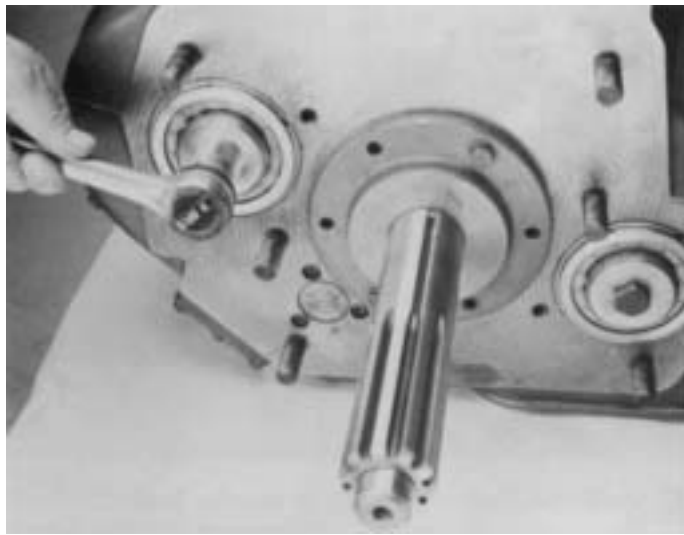

5. Tighten capscrew to the recommended torque.



7. With bearing installation complete, install the snap ring in right countershaft rear groove.

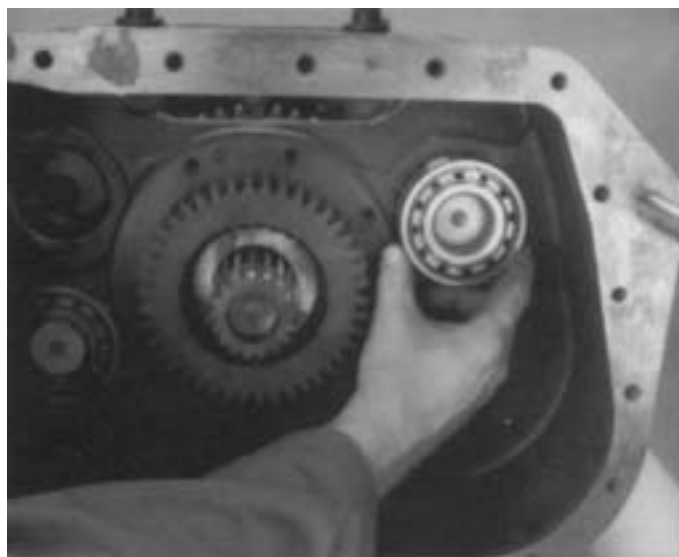

6. Position the countershaft rear bearing in rear bearing bore. Use the proper bearing driver to seat bearing in bore.

8. Move the reverse gear to the rear on mainshaft and use a screwdriver to engage sliding clutches with all forward speed gears. A sliding clutch that will not engage with a gear indicates the gear set is not in proper mesh. The bearings of the right countershaft would then need to be removed and the drive gear set retimed.

**NOTE:** Do not engage sliding clutches with more than one gear at the same time. This will lock the gearing and prevent the mainshaft and countershaft assemblies from rotating.

# REASSEMBLY - FRONT SECTION

## J. Reassembly and Installation of Left Reverse Idler Gear Assembly

**NOTE:** Since the left and right reverse idler gear assemblies are identical, reassembly and installation of the left reverse idler gear assembly should be performed at this time as described in Part C of this section.

## K. Completed Installation of Mainshaft and Auxiliary Drive Gear Assemblies

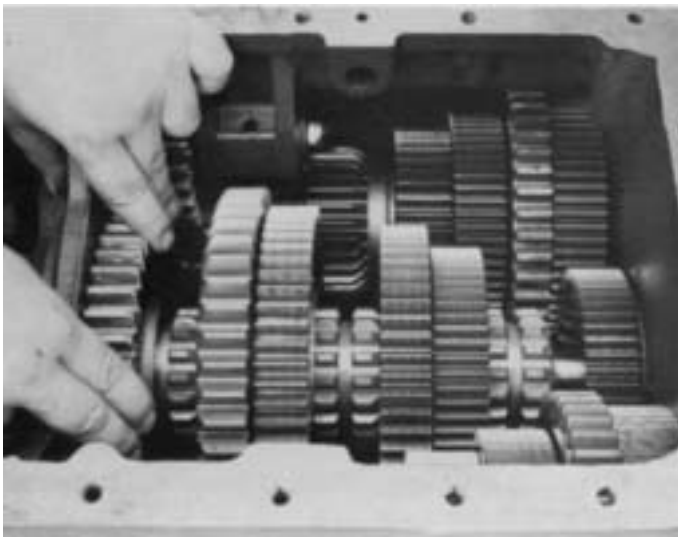

1. Move the reverse gear to the rear as far as possible, meshing teeth of gear with those of the reverse idler gears.

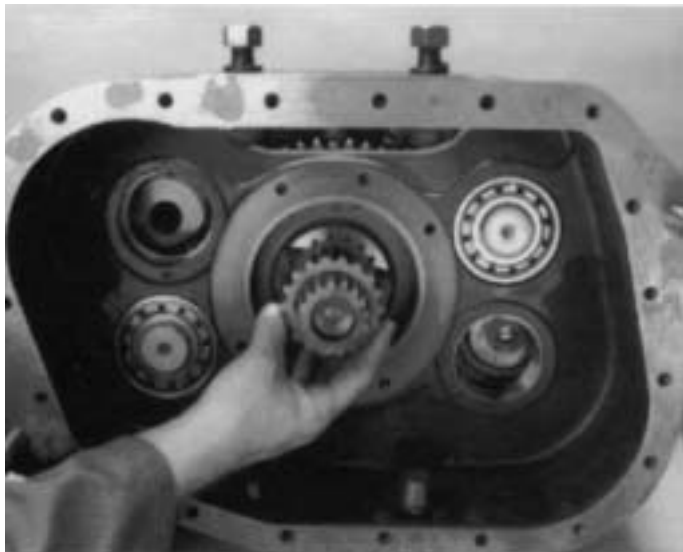

2. Align the external splines of spacer with clutching teeth of reverse gear and move spacer forward on the mainshaft and into reverse gear.

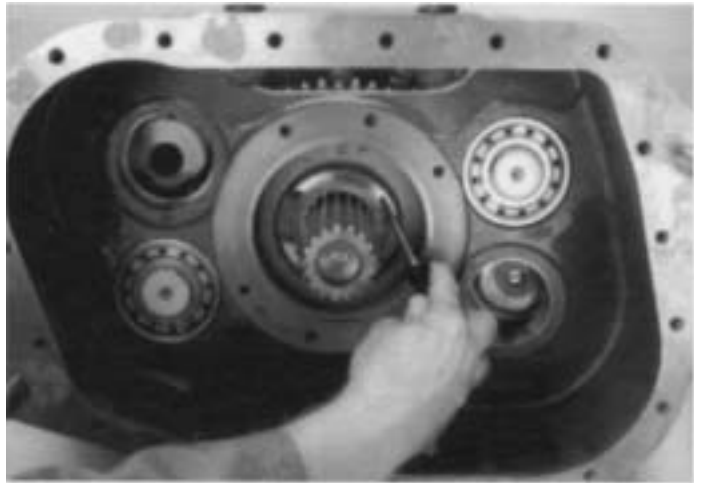

3. Install the snap ring in hub of reverse gear and move the reverse gear forward on mainshaft and into proper position in case.

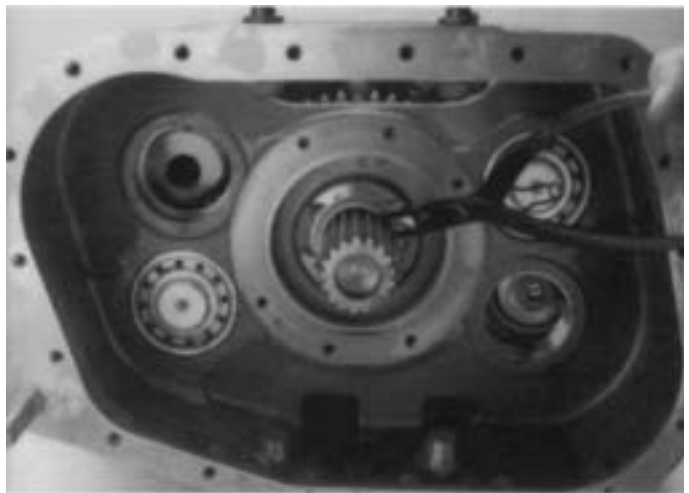

4. Install snap ring on mainshaft snap ring groove.



5. Install splined washer on mainshaft splines behind reverse gear.

# REASSEMBLY - FRONT SECTION

---

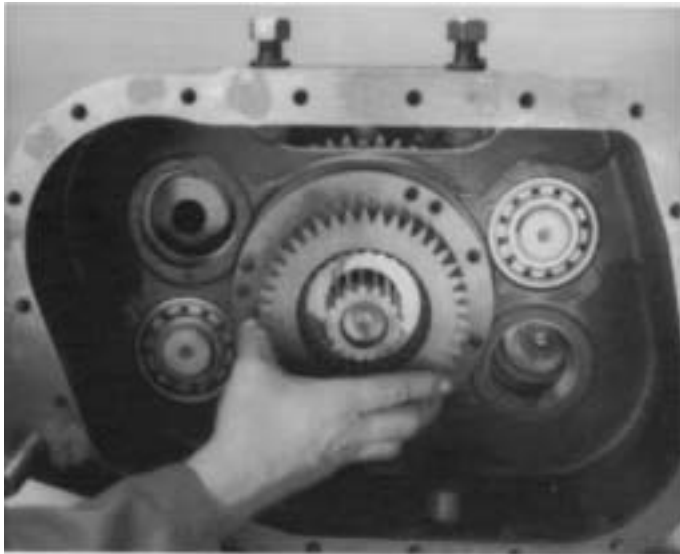

- 6.** Reinstall the front auxiliary drive gear assembly on rear of mainshaft. Use a flanged-end driver and maul to set bearing in case bore.



- 8.** Install splines washer on mainshaft splines behind auxiliary drive gear.

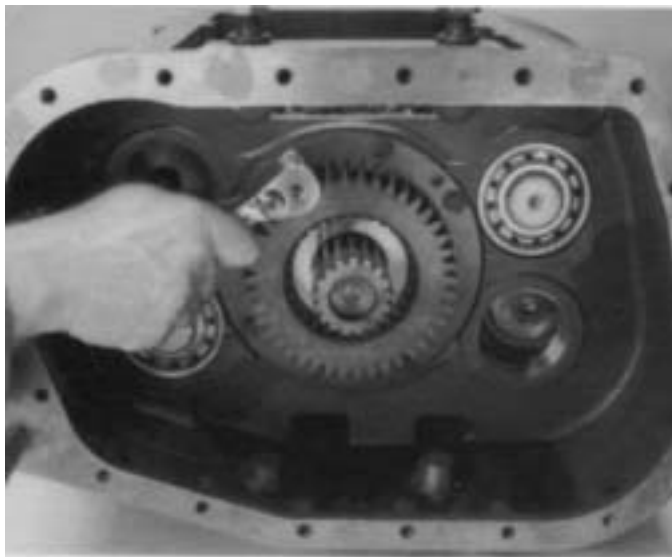

- 7.** Align the six capscrew holes in retainer with the tapped holes in case and install capscrews. Tighten to recommended torque ratings and lockwire the capscrews in groups of three.

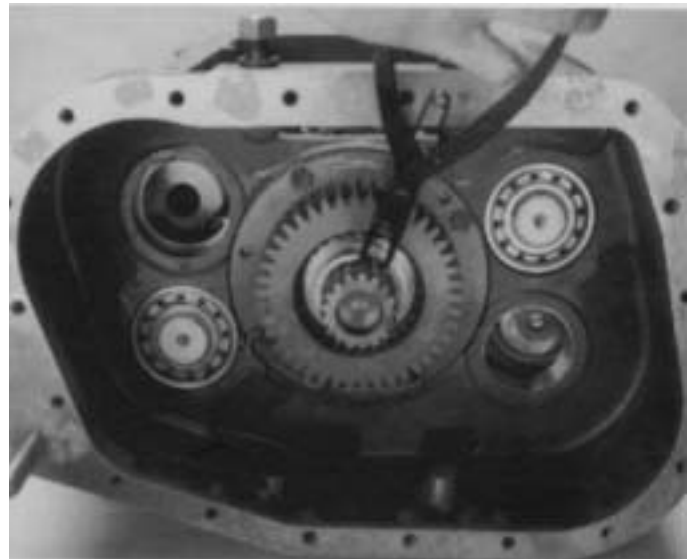

- 9.** Install the snap ring in groove at end of mainshaft.

# INSTALLATION - CLUTCH HOUSING, OUTPUT YOKE, AUXILIARY SECTION AND SHIMMING PROCEDURE

## A. Installation of Clutch Housing

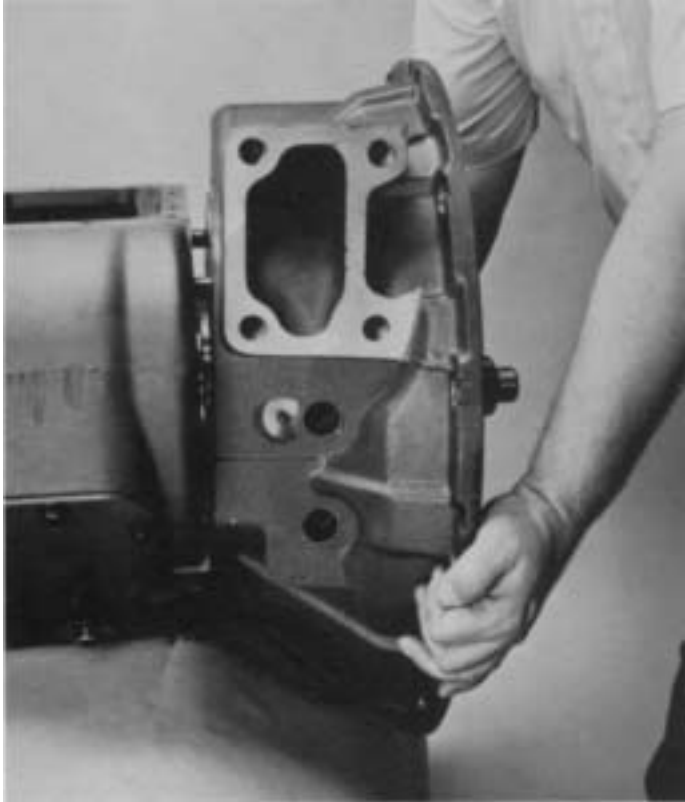

1. Position the corresponding new gasket on housing mounting surface and install the clutch housing on front case, piloting on the six studs and drive gear bearing cover.

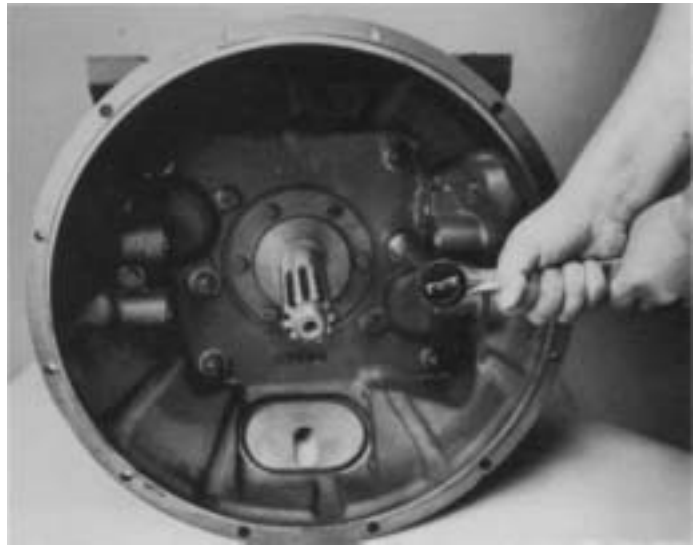

3. Install the six nuts with washers or lockwashers on studs and tighten. SEE TORQUE RECOMMENDATIONS.
4. For models so equipped, install the clutch release mechanism and/or clutch brake assembly.

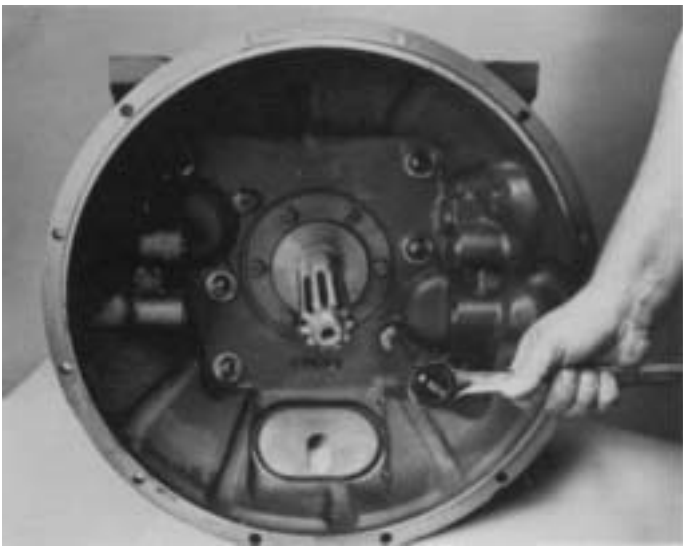

2. Install the six capscrews with lockwashers and tighten. See TORQUE RECOMMENDATIONS.

# INSTALLATION - CLUTCH HOUSING, AUXILIARY SECTION, & OUTPUT YOKE.

## B. Installation of Auxiliary Section

**NOTE:** Make sure the bearing inner race is installed on front of each auxiliary countershaft BEFORE proceeding with the following.

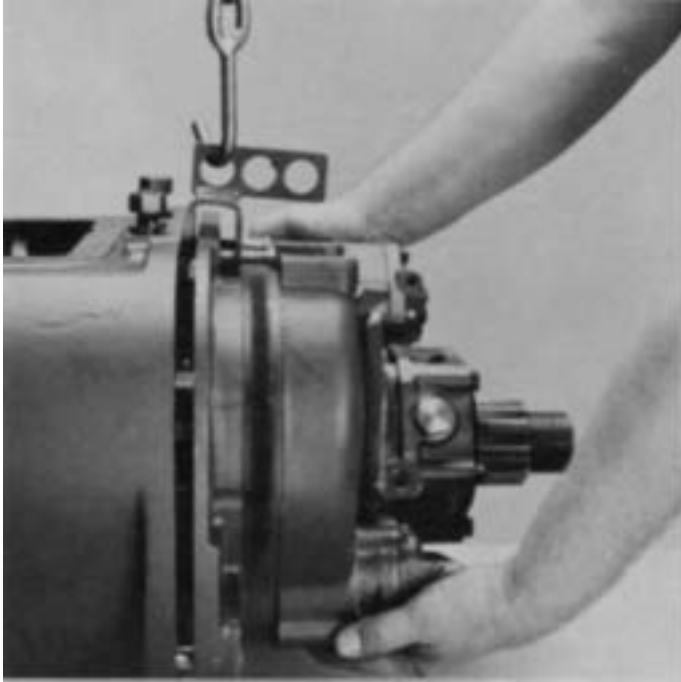

1. Attach a chain hoist to auxiliary. Move the assembly evenly into rear of front case, piloting it on the dowel pins. As assembly is moved forward, the countershaft drive gears will mesh with the auxiliary drive gear.



2. Install the retaining capscrews in flange of auxiliary plate/housing and tighten to secure the auxiliary section to the front section. See TORQUE RECOMMENDATIONS.

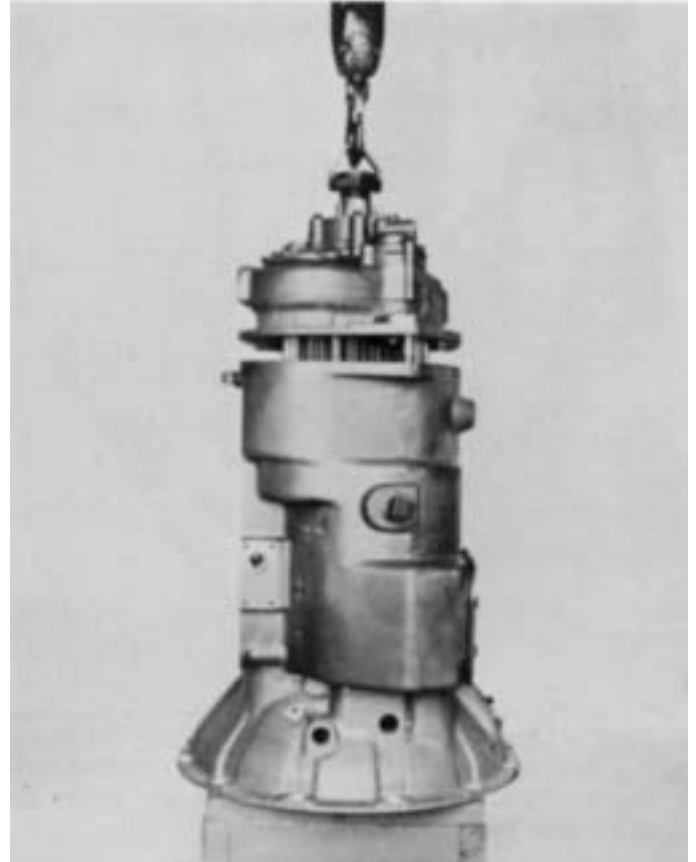

3. The auxiliary section can be installed with transmission set in the vertical position. Block under the clutch housing to prevent damage to the input shaft, position the corresponding new gasket on plate/housing mounting surface and lower the assembly onto rear of front case. Install the retaining capscrews and tighten securely. See TORQUE RECOMMENDATIONS.

# INSTALLATION - CLUTCH HOUSING, AUXILIARY SECTION, & OUTPUT YOKE.

## C. Installation Output Yoke



1. Install yoke slinger on output yoke with proper slinger driver, as shown.



2. For models so equipped, install speedometer drive gear or replacement spacer in position on output shaft (inset). Install the companion flange or yoke on splines of output shaft and move into rear bearing cover.

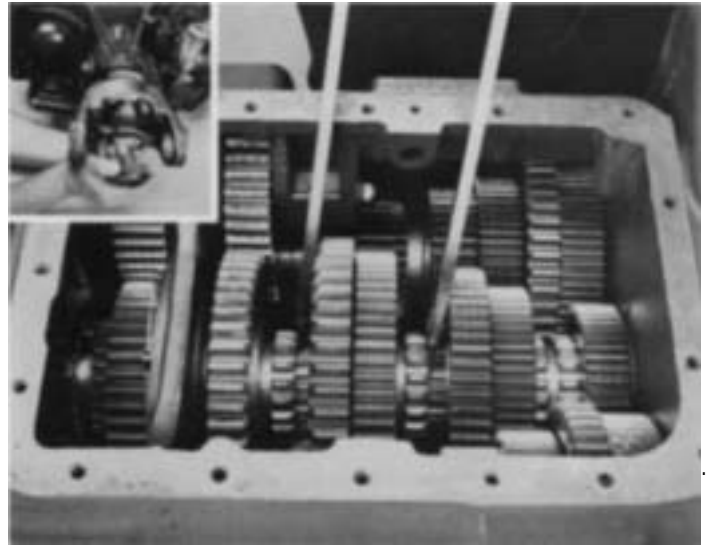

3. Lock the transmission by engaging two mainshaft gears with sliding clutches. Install the washer and nut on output shaft (inset).



4. Tighten the nut using the recommended torque ratings.



# INSTALLATION-SHIFTING CONTROLS

## A. Installation Shift Bar Housing

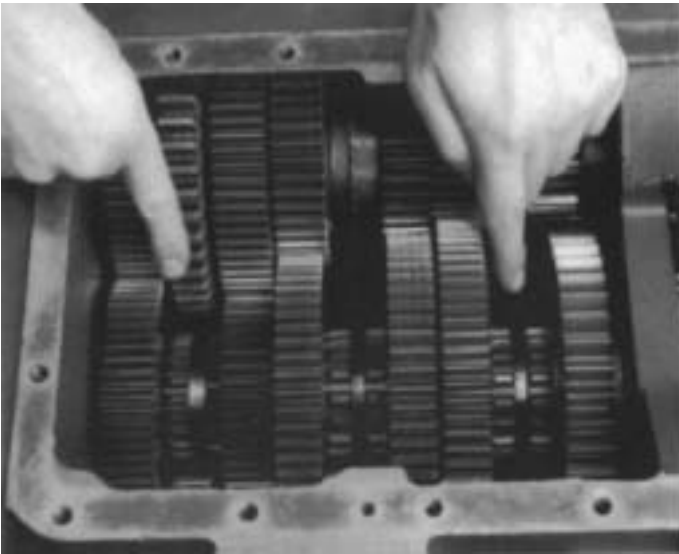

1. Place all three mainshaft sliding clutches in the neutral position. Install shift bar housing gasket in position clutches.

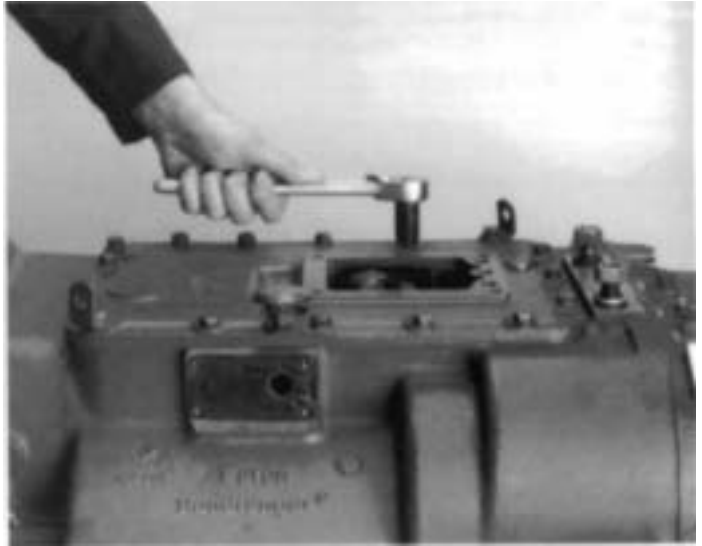

3. Install the thirteen cap screws in shift bar housing and tighten to recommended torque rating.

**NOTE:** There are two sizes of cap screws. The 1/2" cap screws are used with lifting eyes.



2. With all three shift yokes in the neutral position, install the shift bar housing assembly on case, fitting the shift yokes into the slots of the corresponding sliding clutches.

# INSTALLATION-SHIFTING CONTROLS

## GEAR SHIFT LEVER HOUSING ASSEMBLY

### B. Installation Gear Shift Lever Housing Assembly

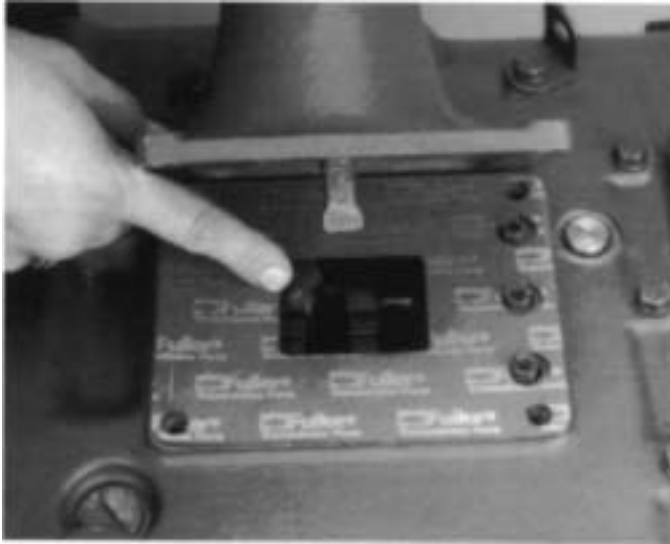

1. Check the shift bar housing assembly to make sure shift block and yoke notches are aligned in the neutral position. Install the gasket and gear shift lever housing assembly on shift bar housing, fitting the lever into the shift block and yoke notches



2. Install the four retaining cap screws in housing flange and tighten to recommended torque to secure the assembly to shift bar housing.

# INSTALLATION-SHIFTING CONTROLS

## C. Installation of Slave Valve

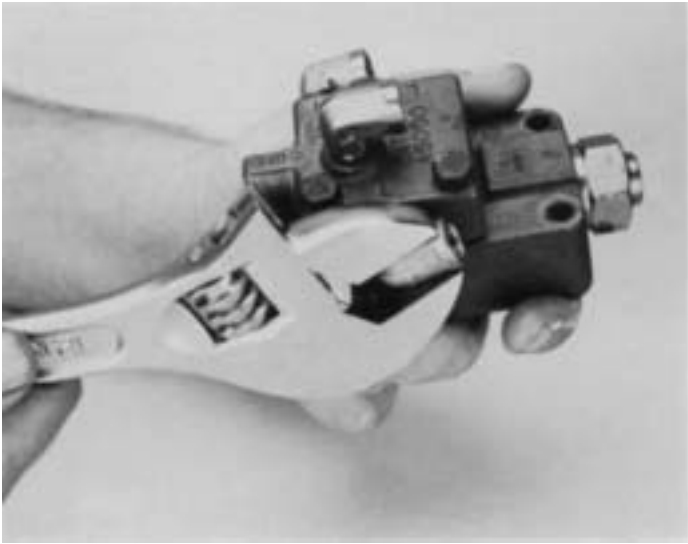

1. If previously removed, install the air line fittings on slave valve.



3. Install the hat-type alignment sleeve in bore of slave valve.



2. Install the spring on shank of actuating pin and insert in bore of transmission case.



4. Position gasket on valve mounting surface (inset) and install the slave valve on case, inserting the end of actuating pin into alignment sleeve. Secure the valve to case with four cap screws tighten evenly to recommended torque rating.

# INSTALLATION-SHIFTING CONTROLS

## D. Installation of Air Lines and Air Filter Regulator

**NOTE:** Recommended sealant for fittings is Fuller Sealant part number 71205.

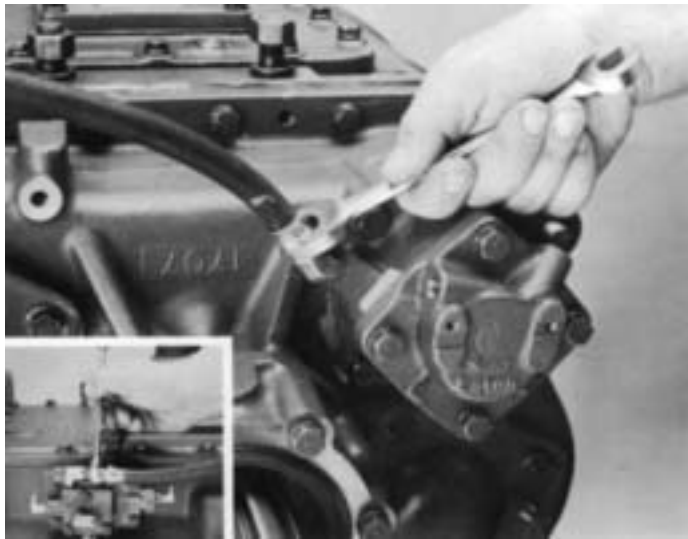

1. Connect the 1/4" I.D. air hose between the slave valve (inset) and the HI Range Port of the range cylinder. Tighten fittings securely.



3. Position the air filter/regulator on the auxiliary housing rear and install the two retaining cap-screws. Tighten to recommended torque.

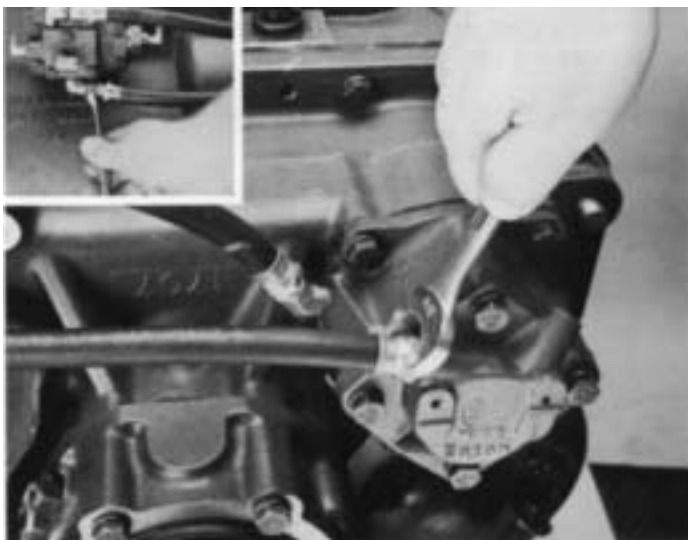

2. Connect the 1/4" I.D. air hose between the slave valve (inset) and the LO Range Port of the range cylinder. Tighten fittings securely.

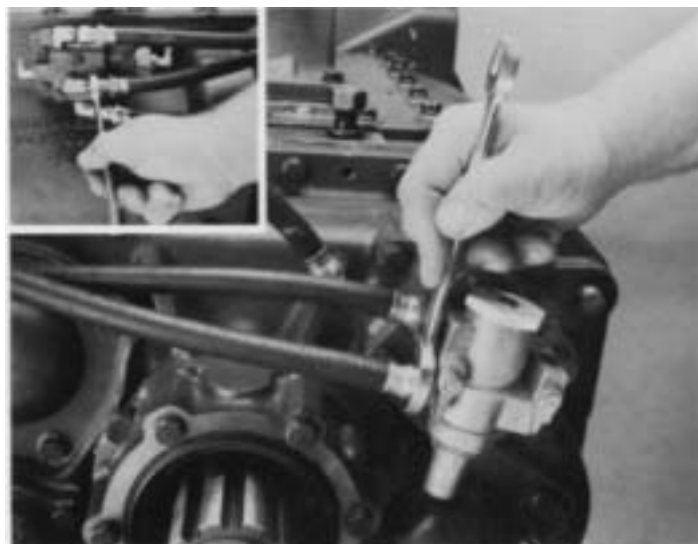

4. Connect the 1/4" I.D. air hose between the slave valve (inset) and the air filter/regulator. Tighten fittings securely.

# INSTALLATION-SHIFTING CONTROLS

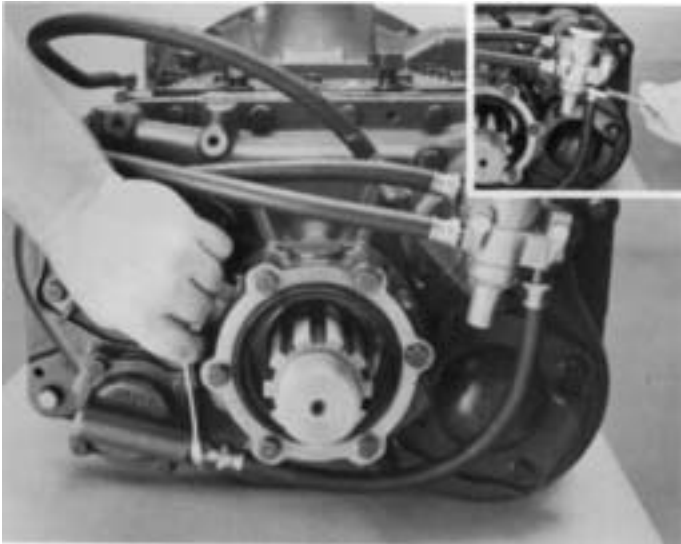

5. Connect the 1/4" I.D. air hose between the air filter/regulator (inset) and the splitter cylinder cover. Tighten fittings securely.



7. Install the jam nut on the shift lever. Thread the Roadranger valve on shift lever and secure by tightening jam nut against valve.



6. Install the Roadranger valve cover and the three air lines.

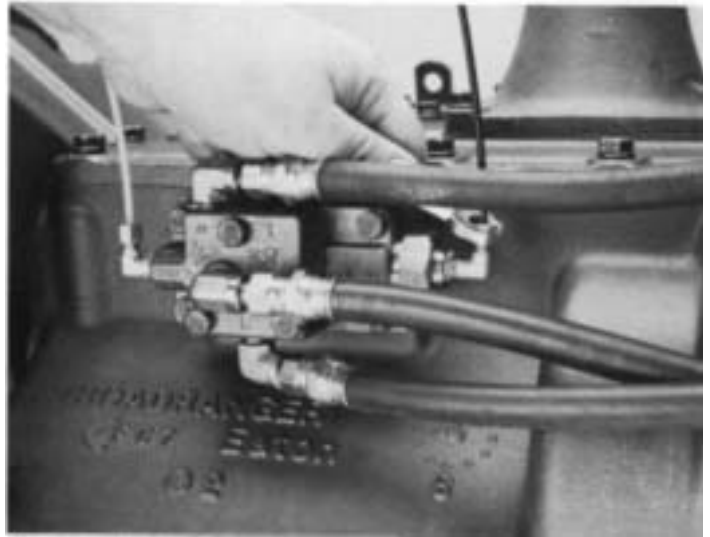

8. Connect the red air line to the "S" or Supply Port, and the black air line to the "P" or End Port of the slave valve. Tighten fittings securely.

# INSTALLATION-SHIFTING CONTROLS



9. Connect the red air line to the "S" or Supply Port and the black air line to the "P" Port on the Roadranger valve. Tighten fittings securely.



11. Position valve cover on Roadranger valve and secure by tightening the two mounting screws in cover,

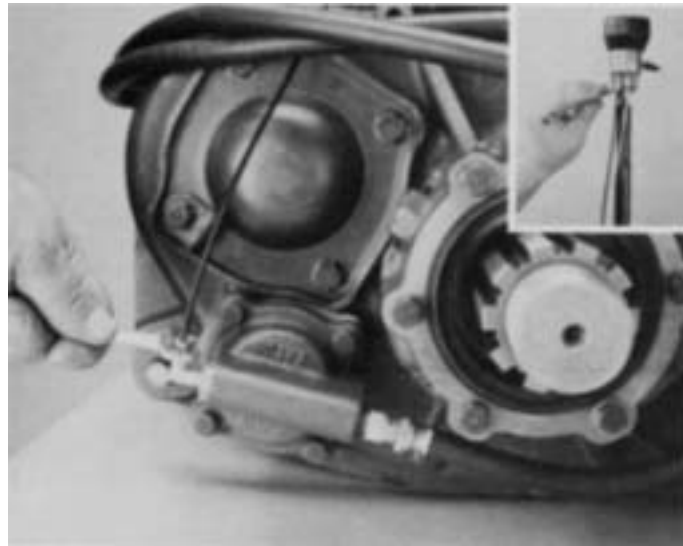

10. Connect the blue air line to the "SP" or Splitter Port on the Roadranger valve (inset). Connect the blue air line to the splitter cylinder cover. Tighten fittings securely.



Copyright Eaton Corporation, 2012. Eaton hereby grant their customers, vendors, or distributors permission to freely copy, reproduce and/or distribute this document in printed format. It may be copied only in its entirety without any changes or modifications. THIS INFORMATION IS NOT INTENDED FOR SALE OR RESALE, AND THIS NOTICE MUST REMAIN ON ALL COPIES.

**Note:** Features and specifications listed in this document are subject to change without notice and represent the maximum capabilities of the software and products with all options installed. Although every attempt has been made to ensure the accuracy of information contained within, Eaton makes no representation about the completeness, correctness or accuracy and assumes no responsibility for any errors or omissions. Features and functionality may vary depending on selected options.

**For spec'ing or service assistance, call 1-800-826-HELP (4357) or visit [www.eaton.com/roadranger](http://www.eaton.com/roadranger). In Mexico, call 001-800-826-4357.**

Roadranger: Eaton and trusted partners providing the best products and services in the industry, ensuring more time on the road.

**Eaton Corporation**

Vehicle Group  
P.O. Box 4013  
Kalamazoo, MI 49003 USA  
800-826-HELP (4357)  
[www.eaton.com/roadranger](http://www.eaton.com/roadranger)

Printed in USA