

Further Advancing the World Standard CNC from FANUC

FANUC

Series Oi-MODEL F

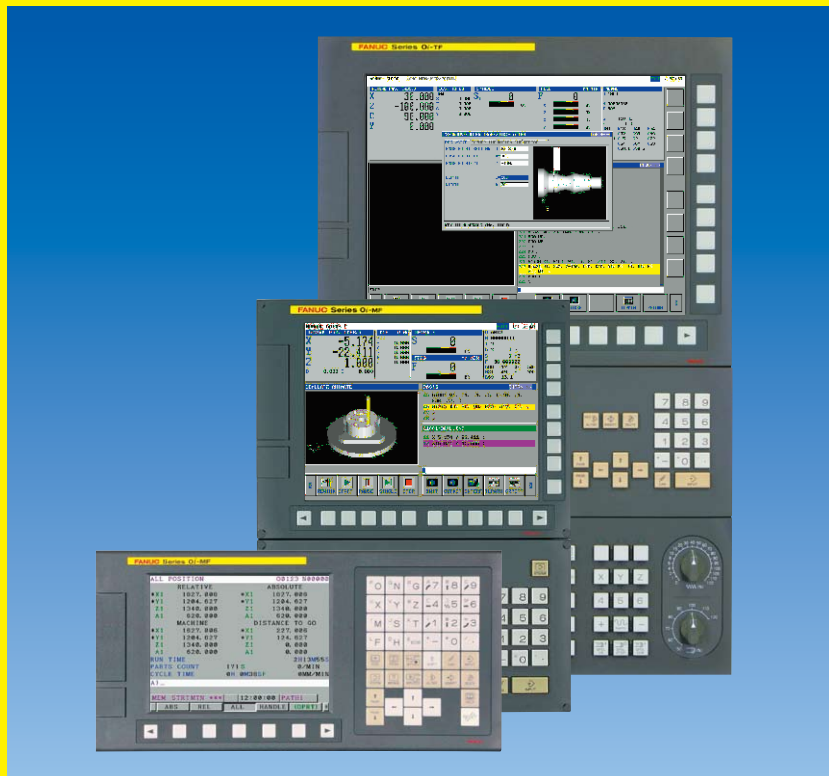

Further Advancing the World Standard CNC from FANUC

FANUC Series *oi*-MODEL F

New *oi* series CNC Provides Added Value to Machine Tools

Mach
Perfor

- New 15 inch large screen in *oi* series
- Servo technology with the highest performance in the world
- Achieves both high accuracy and smoothness with easily adjusting steps
- Provides the convenience of PC on CNC
- Loader control commanded by G code meets the request of automation



Minimizing
Downtime

Machine
Performance

High-Speed and High Quality Machining
Excellent Control Functions

- Nano CNC system combined with precise nano-calculation and leading-edge servo technology
- AI Contouring Control effective for high-speed and high precision machining
- Smart Tolerance Control makes it easy to adjust the precision needed for machining
- Smart Overlap enables a shorter cycle time for machining parts
- Servo HRV provides high-speed and high accuracy
- Spindle HRV has high acceleration and high response
- FANUC SERVO GUIDE with quick and smart tuning

Pursuing Ease of Use
Abundant CNC Functions and Operability

- Increasing the number of controllable axes makes it ideal for a wider range of machines
- 15 inch display unit is available in addition to the 8.4/10.4 inch display unit
- Loader is cost effective and easily configured with the new Loader Control function
- FANUC Platform enables the convenience of a PC in the CNC
- Support of various industrial networks and field networks
- Direct editing and operation of the CNC program on memory card

Performance

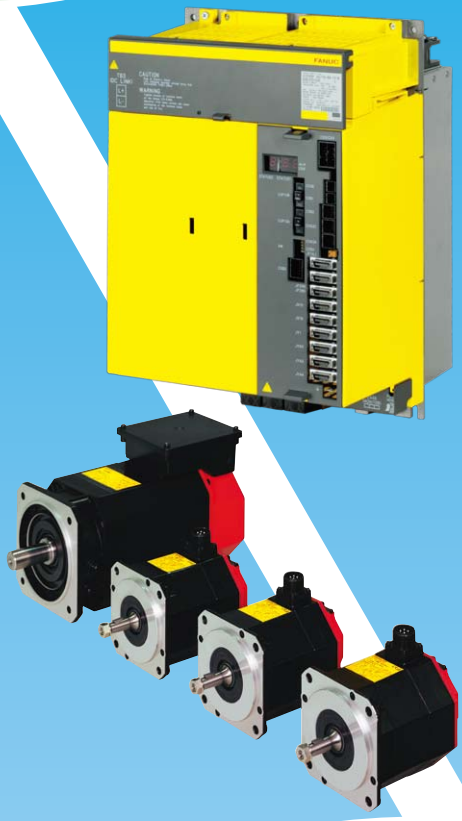

Ease of Use

Ease of Use

Seamless Functions with 30i-B series CNC

- Common screen and operability
- Common maintenance
- Common network functions
- Use of common peripheral devices
- Support of the same PMC functions

High Performance and Value

- Packaged with CNC functions
- Ultra compact CNC with less-wiring and high reliability with leading-edge technology
- Providing the best solution with the combination of βi servo system

CNC Lineup

FANUC Series Oi-MF

CNC for Machining Center

- 1 path system total controllable axes: up to 9 ^{*1}
- 2 path system total controllable axes: up to 11 ^{*1}

FANUC Series Oi-TF

CNC for Lathe

- 1 path system total controllable axes: up to 9 ^{*1}
- 2 path system total controllable axes: up to 11 ^{*1}

FANUC Series Oi-PF

CNC for Punch Press

- 1 path system total controllable axes: up to 7 ^{*1}
- (^{*1} : Total controllable axes is the sum of feed and spindle axes. Please refer to the specifications as for the maximum values of feed axes and spindle axes.)

Minimizing Downtime

Focusing on Minimizing Downtime High Reliability and Easy Maintenance

- Highly reliable hardware allows stable operation in a harsh factory environment
- Preventive maintenance to avoid machine from unexpected stop by sudden trouble, such as leakage detection function which detects the insulation deterioration of motor
- Various types of enhanced diagnosis functions improve maintainability so that the cause of trouble can be identified quickly

ity

- Integrated Operation & Programming Guidance with extremely simplified operations
FANUC MANUAL GUIDE *i*
- Programming Guidance with various machining cycles
FANUC MANUAL GUIDE *oi*
- High-speed and large capacity PMC with Function Block function as standard and multi-path PMC
- Safety achieved by the Dual Check Safety embedded into CNC
- Customize functions for each unique machine
- Tuning functions help easily set-up machine tool

State-of-the-Art Hardware

Ultra-Compact, Reduced Wiring, High Reliability

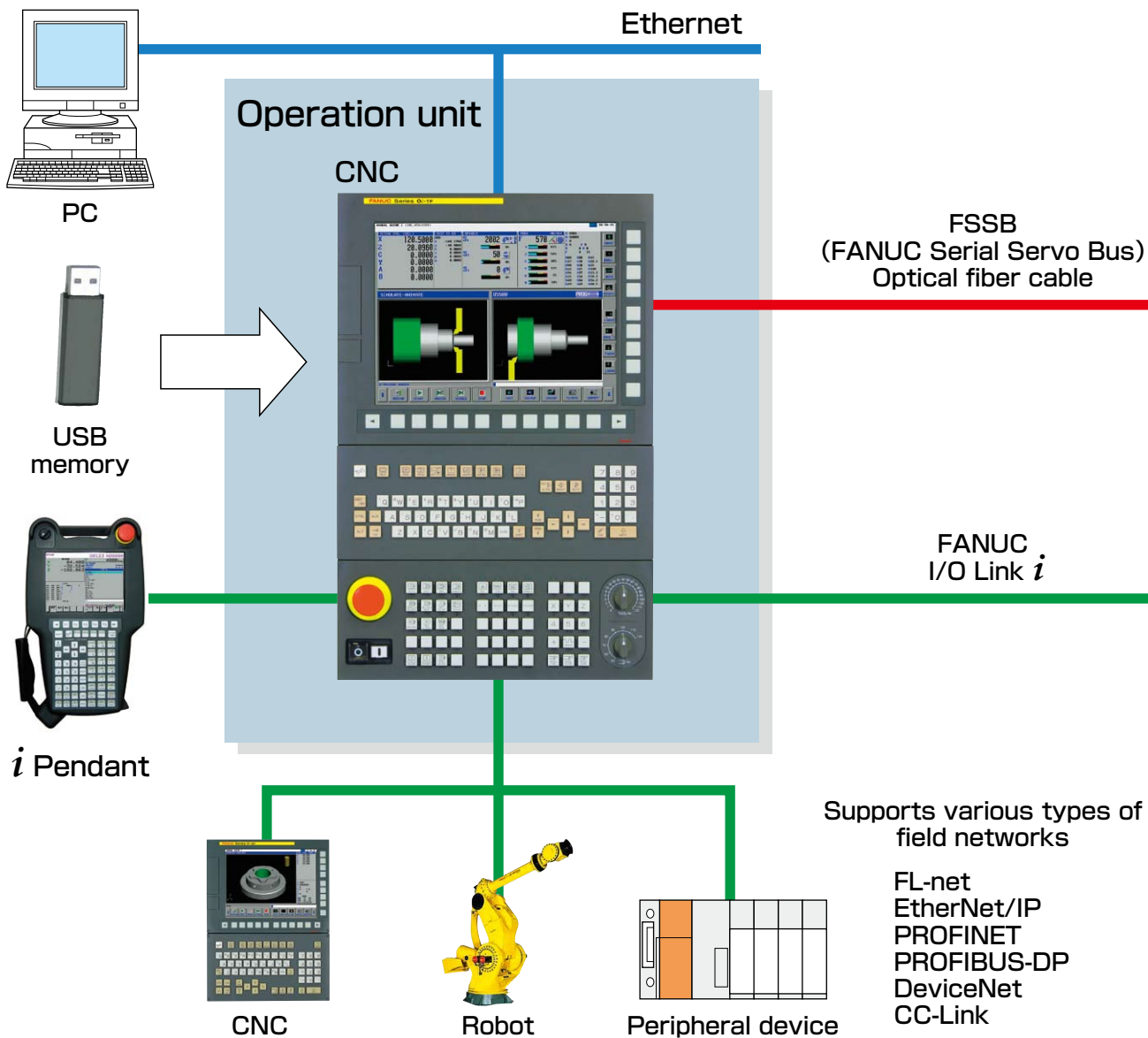

Thin and Compact CNC [Patent approved]

Small sized CNC integrated with the LCD enables a compact operation unit. The depth of CNC is only 60mm (*1).

Large 15 inch display is now available in the *O_i* series CNC, in addition to the 8.4/10.4 inch display. (*1:8.4/10.4 display with no optional slot)

Enhanced Basic Performance

Basic performance of the CNC, servos and the PMC to support advanced various functionalities, such as loader control and smart tolerance control.

Reduced Wiring [Patent approved]

Faster FSSB and FANUC I/O Link *i* realize further reduction of wiring and lower wiring cost.

Faster FSSB [Patent approved]

CNC and the amplifiers are connected with FSSB (FANUC Serial Servo Bus) using optical fiber cable. High performance and reduced wiring are realized by optimizing communication protocol and ECC technology with the high-speed and high level noise tolerance by the optical fiber cable. In addition, spindle amplifiers can be now connected to FSSB.

FANUC I/O Link *i* [Patent approved]

FANUC I/O Link *i* is a serial I/O interface between the PMC and various I/O units. Various kinds of units such as general I/O modules, machine operator panel can be connected to this I/O interface.

FANUC I/O Link *i* helps with quick recovery from trouble by making it easy to pinpoint the faulty part using various error detection capabilities such as bitwise DO ground fault detection and I/O power supply failure detection, etc. FANUC I/O Link *i* realizes Dual Check Safety with a single cable, although conventional systems require two cables.

Power magnetic Cabinet

SERVO AMPLIFIER *βi* SVSP-B series



I/O Unit



I/O module for connector panel

AC SPINDLE MOTOR *βi* series



AC SERVO MOTOR *βi* series

Network Support Functions

The various Industrial Ethernet and field networks are supported in order to suit a variety of network environments in the factory.

Ethernet is supported as a basic function, and the CNC can be connected to a personal computer to transfer a variety of NC data.

i Pendant

i Pendant is a portable operating unit. It is possible to watch the CNC screen and operate the machines at a distant point from the main operator's panel. Moreover, touch panel and the manual pulse generator can be selected as an option.

High Reliability Realized by ECC

By applying the ECC (Error correcting code), it can automatically correct the error from electrical noise inside of the CNC. As a result, a highly reliable CNC is realized.

FANUC AC SERVO MOTOR *βi* S series

High performance and value AC SERVO MOTOR for feed axis of machine tools

- Smooth rotation and compact size
- Quick acceleration
- Excellent waterproofing
- High resolution *βi* series PULSECODER
- Bayonet type power connector
- Reduced Backlash Brake

FANUC AC SPINDLE MOTOR *βi* I series

High performance and value AC SPINDLE MOTOR for spindle axis of machine tools

- Compact size and high power and high torque.
- High efficiency and low heat generation by SPINDLE HRV Control.

βiT series motors with hollow shaft are available which enable center through coolant by direct connection with spindle of machining center.

FANUC SERVO AMPLIFIER *βi* SVSP-B series

High reliability, high performance and value SERVO AMPLIFIER

*βi*SVSP-B is All in one SERVO AMPLIFIER (servo 3 axes + spindle 1 axis). High performance and value servo system is possible by enhancing machining performance, minimizing downtime, and ease of use.

Machining performance

High-speed Rigid Tapping effective for reducing cycle time is applied by optical interface of not only servo axis but also spindle axis.

Minimizing downtime

Trouble diagnosis function can quickly find cause of alarm.

Ease of use

Built-in cooling fan exchangeable from servo amplifier front side.

Increasing of additional axis to *βi*SVSP-B by applying Spindle Smart Acc/Dec.

Separated magnetic contactor reduced by applying STO (Safe Torque Off) function.

Easy Maintenance

Unexpected system down can be prevented by predictive trouble detection and warning indication.

Fans for cooling and battery are stored in a cartridge and can be replaced quite easily, and maintainability is enhanced.

Various alarm detection functions help reduce downtime by making it easy to pinpoint the faulty part.

High performance

High-Speed, High Quality Machining

Nano CNC System

[Patent approved]

High Quality Machining Achieved by Coordination Between “High Precision Operation in Nanometers” and “State-of-the-Art Servo Technology”

Nano interpolation that computes position commands for the digital servo control unit in nanometers, SERVO HRV Control and SPINDLE HRV Control for which the control cycle is made faster, and FANUC AC SERVO MOTOR α i series with a high resolution pulse coder are used as standard and make up “Nano CNC System,” which achieves high-quality machining.



Nano Interpolation



FANUC SERVO AMPLIFIER α i-B series

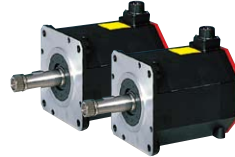

SERVO HRV Control
SPINDLE HRV Control

High-response and high-resolution pulse coder 32 million/rev

FANUC AC SERVO MOTOR α i series



FANUC AC SPINDLE MOTOR α i series

AI Contour Control

Optimum feedrate and acceleration control by reading blocks in advance

This can perform high-speed and high precision machining of complex free-form curved surfaces of aircraft parts, automobile parts and metal dies that are specified in continuous small blocks.

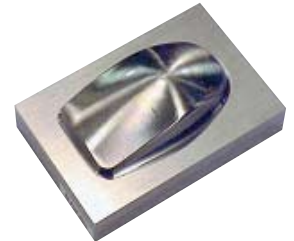

Smart Tolerance Control

Reducing steps and time of adjusting precision and achieving high quality machining

If speed is changed, the basic setting for speed control does not need to be changed and it is possible to reduce steps and time of adjusting precision by controlling speed properly within allowable error (Tolerance) to make machining precision constant. If continuous small segments are also specified, it is possible to prevent mechanical shock and improve smoothness of finishing surface.

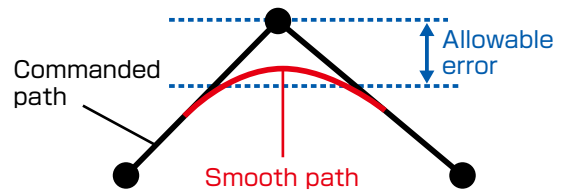

Smart Overlap

Reducing cycle time in part machining

It is possible to reduce cycle time by enabling to overlap between blocks of cutting feed and rapid traverse. Confirmation of tool path deviation is easy by automatic calculation screen for tool path deviation.

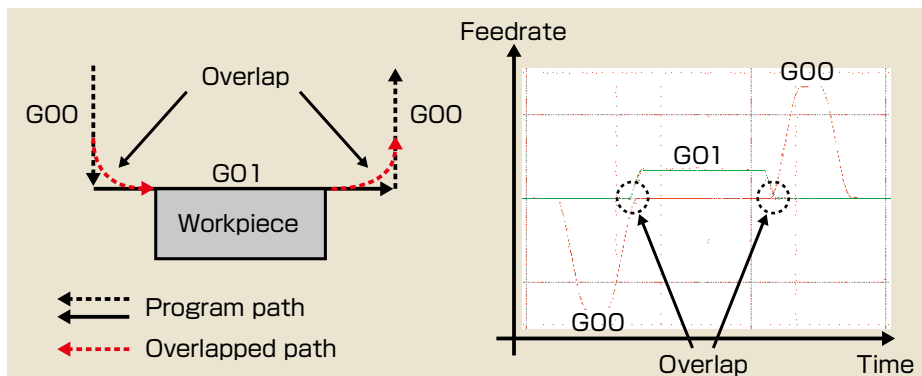

REUCING CYCLE TIME 00123 N00000

MENU >> Cutting block adjustment >> Automatic setting of overlap time (2/2)

Automatic calculation of tool path deviation by smart overlap

Target axis of automatic calculation = X 1 Y 2

Rapid traverse rate = 30000.000 30000.000

Cutting feedrate = 10000.000 2000.000 1000.000

	X	Y	X	Y	X	Y
Time constant(t3)	32	32	16	16	8	8
Time constant(t4)	16	16	8	8	8	8

Tool path deviation(mm)

G00 - G00	0.200	0.020	0.002
G00 - G01	0.200	0.020	0.002
G01 - G01	0.100	0.010	0.001

Tool path deviation by smart overlap is calculated automatically based on the feedrate settings. Note) This tool path deviation is theoretical value. It might be different from tool path deviation on tool tip of machine.

12:00:00 PATH1

CYCLE REDUCE COPY

Automatic calculation screen for tool path deviation

Advanced Digital Servo Technology

SERVO Motor System

SERVO AMPLIFIER
αi-B series



AC SPINDLE MOTOR
αi series

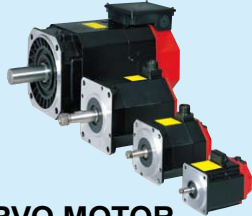

AC SERVO MOTOR
αi series

SERVO AMPLIFIER
βi SVSP-B series



AC SPINDLE MOTOR
βi series

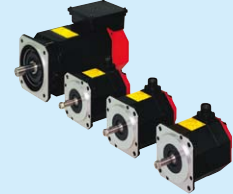

AC SERVO MOTOR
βi series

SERVO HRV Control

High-speed and high precision servo control

By combining hardware technology and software technology such as the latest servo control HRV3+, high-speed and high precision control with nano-meter level is ensured.

Mechanical resonance can be suppressed by automatic following HRV filter even though its frequency is changed.

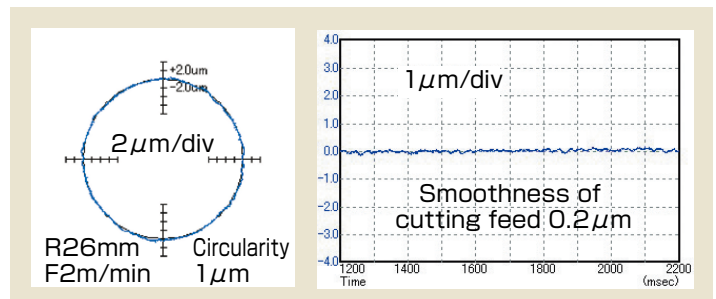

Application example of SERVO HRV3

SPINDLE HRV Control

FSSB High-speed rigid tapping

The spindle amplifier is connected to CNC by FSSB (Optical interface). High performance rigid tap in the synchronization point of view is achieved by direct transferring of spindle position data to servo axis with high speed FSSB communication. It realizes high-speed and high accuracy rigid tap with maximum acceleration power of spindle motor. It will help to shorten cycle time.

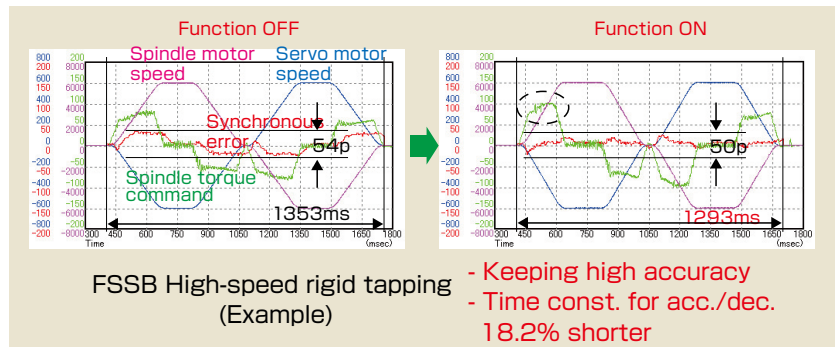

FSSB High-speed rigid tapping (Example)
- Keeping high accuracy
- Time const. for acc./dec. 18.2% shorter

FANUC SERVO GUIDE

Quick & smart tuning of servo and spindle

This software provides the integrated environment for making test programs, setting parameters, and data measurement needed for servo and spindle tuning. It has substantial automatic tuning functions for gains, filters, and others.

With SERVO GUIDE, quick and smart optimization of servo and spindle can be achieved.

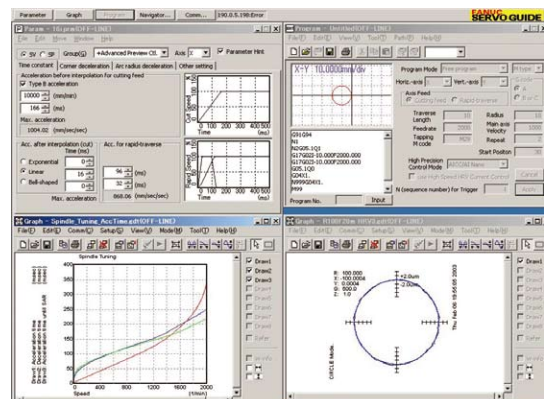

Pursuing Ease of Use

Ease of Use

Abundant CNC functions

Increase of CNC Functions

Increasing the number of controllable axes and paths makes it ideal for a wider range of machines.

- Extended axis number (from 8 axes to 9 axes) on 1 path system
- 2 path system is available on *Oi*-MF
- No count Cs axis for number of feed axes, the number of controllable feed axes is increased

In addition to 8.4/10.4 display unit, larger 15 inch display unit is available.

By using the large display, the operability is further improved.

Enabling the commonly used and other various functions (program folder management of part program etc.) of *30i*-B series, the usability of CNC system is further improved.

- Axis name expansion
- Program folder management
- Quick program restart
- Flexible path axis assignment
- Multi-path PMC function, Ladder Dividing Management function
- Main menu screen etc.

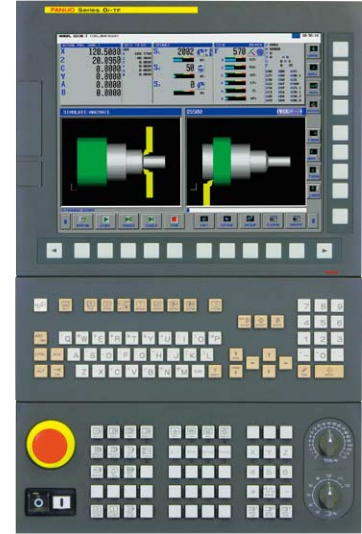

15 inch display unit

Function for Loader Control

Loader control can be easily achieved at low cost. This function can contribute to the automation of machine tools. Loader can be controlled by the same G codes as those of machining programs. There is no need to control an axis by the PMC ladder, etc. Loader programs can be executed independently of machining programs.

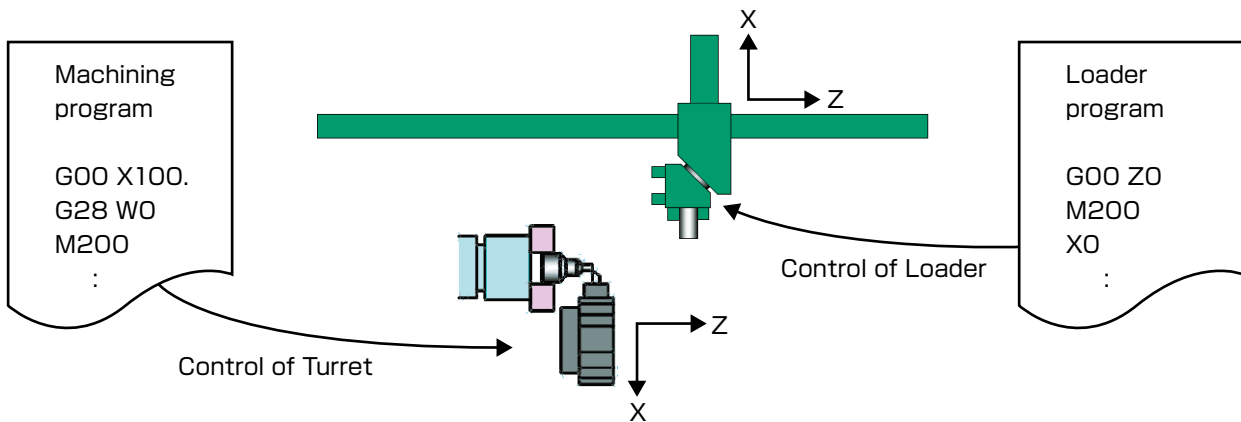

Memory Card / Data Server Editing / Operation

The programs stored in a memory card and Data Server can be edited by the CNC edit functions and can be executed as well as the programs in built-in CNC program memory. Memory card and Data Server can be used as large-capacity program memory together with built-in CNC memory.

compact flash card



compact flash card adaptor

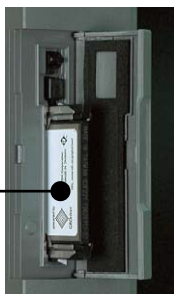

A compact flash card can be stored in the CNC main unit.

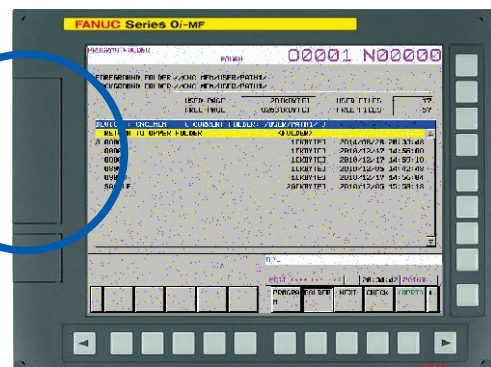
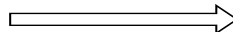

Excellent Operability

Ease of Use

FANUC Platform Provides Convenience of PC on CNC

Convenient platform with useful functions (e.g. high-speed graphics, remote desk top function, large memory, etc.) can be added on the CNC.

- MANUAL GUIDE *i* advanced guidance function (help for the screen and scaling and rotation of animation) can be enabled.
- Remote desk top function improves convenience of CNC by enabling operation of the PC connected via Ethernet from CNC. (e.g. operating the CAD/CAM, referencing the manual, etc.)
- Large programs can be edited and operated with built-in large memory.

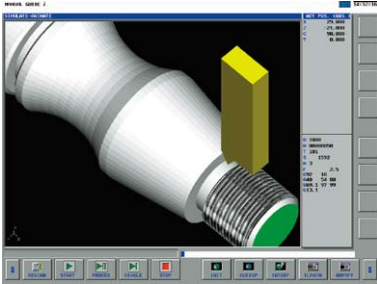

MANUAL GUIDE *i*
Scaling and rotation of animation

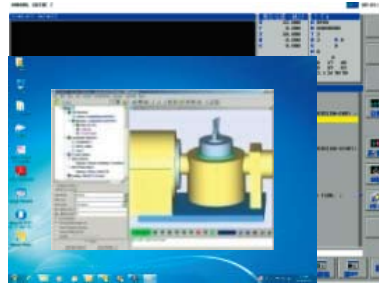

Remote desk top function
Operating the PC connected via Ethernet from CNC

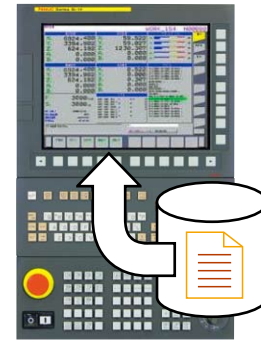

Memory operation
with large memory

Integrated Operation & Programming Guidance with extremely simplified operations

FANUC MANUAL GUIDE *i*

MANUAL GUIDE *i* is an integrated operation guidance, which provides easy operation guidance from programming through machine operation on one single screen. It can be used for lathes, milling machines and machining centers.

- Integrated operating screen
- ISO code part programming
- Powerful program editing functions
- Various machining cycles
- Realistic machining simulation
- Set-up guidance
- Multi-path lathe function

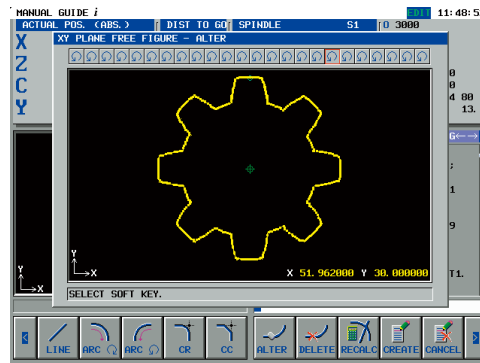

Free figure input screen

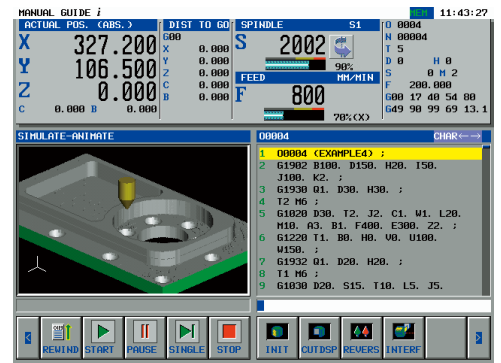

Machining simulation screen

Programming Guidance with various machining cycles

FANUC MANUAL GUIDE *Oi*

MANUAL GUIDE *Oi* is an easy to use part programming operation guidance function that simplifies the creation of a machining program. It is concentrated to the functionality of creating a part program and can be used for lathes, milling machines and machining centers.

- ISO code part programming
- G-code and M-code assistance
- Various machining cycles
- Contour programming

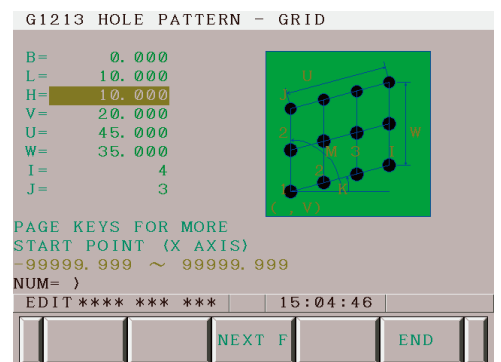
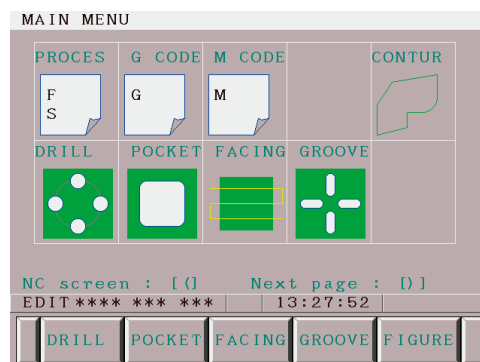

Network Support Functions

Ease of Use

With plenty of network functions, you can construct an optimum system for machine tools

Ethernet

Embedded Ethernet of 100Mbps is supported on the CNC main board. CNC can be connected to a personal computer to transfer NC programs and monitor CNC status.

The Fast Ethernet board can be mounted as an option. Data can be transferred simultaneously among multiple computers at high speed. These features are ideal to construct a production system which exchanges information among machining lines and factory host computer.

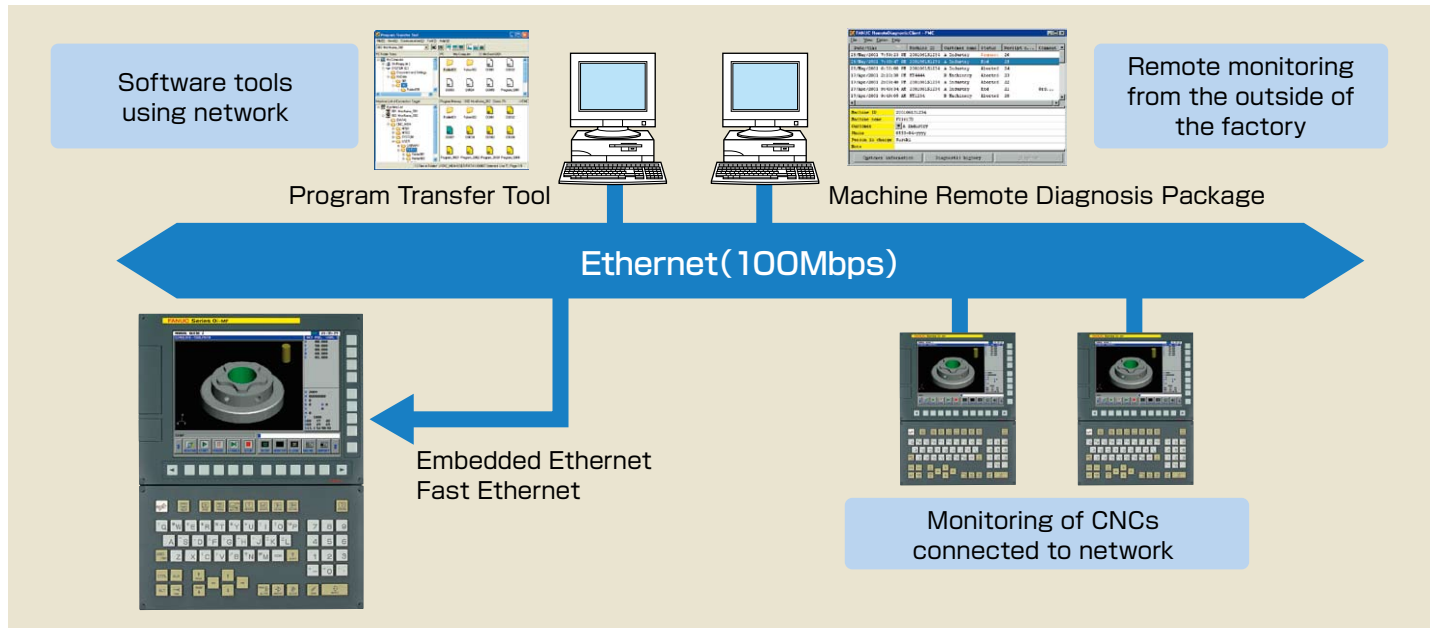

Fast Data Server

NC programs can be stored in the built-in compact flash card in the Fast Data Server for high-speed machining and program editing. Other Ethernet functions can be used simultaneously using Data Server.

- High speed transfer between Data Server and PC
- Up to 16G bytes capacity for storing NC programs
- Memory operation and program editing

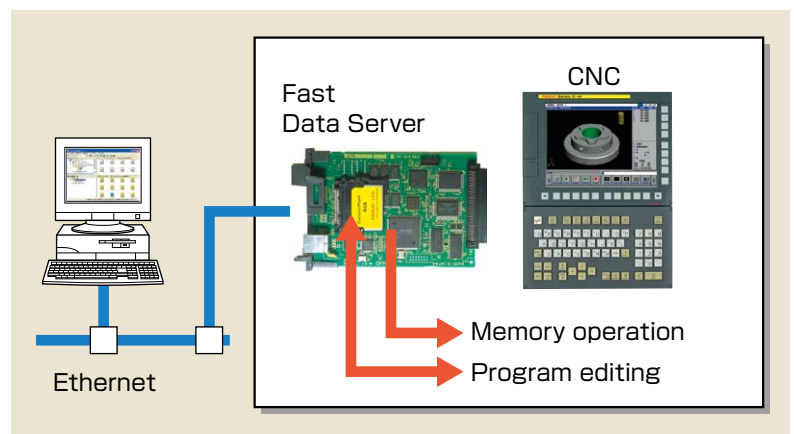

Industrial Ethernet / Field Network

The I/O signals of various peripheral devices such as waterproof equipment can be controlled and monitored by the ladder program.

Supports various networks

- FL-net
- EtherNet/IP
- PROFINET
- PROFIBUS-DP (Master/Slave)
- DeviceNet (Master/Slave)
- CC-Link (Slave)

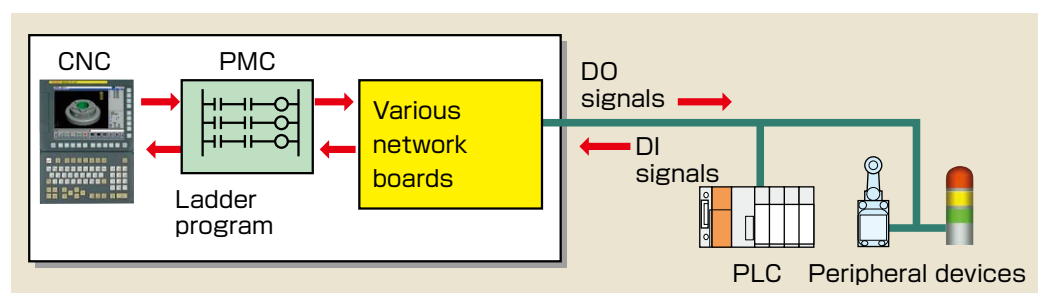

High-Speed, Large Capacity, and Multi-path PMC

High-Speed and Large Capacity

PMC becomes much faster. PMC, which consists of a dedicated processor and custom LSI, processes a large sequence of programs at a high speed.

- Program capacity Max. 100,000 steps (Total of all PMC paths)
- Internal relay (R) Max. 60,000 bytes
- Data table (D) Max. 60,000 bytes
- PMC paths Max. 3 paths (Max. 16 ladder programs)

Multi-path PMC

One PMC can execute up to 3 independent ladder programs. Each ladder program has an independent data area, which enables programs to be developed as independent modules. Ladder programs for loader and peripheral control can be created, added and modified separately. Ladder programs can easily be developed and the machine can easily be systematized according to each user's machine configuration. External PLC or other devices for peripheral control becomes unnecessary, which reduces system costs.

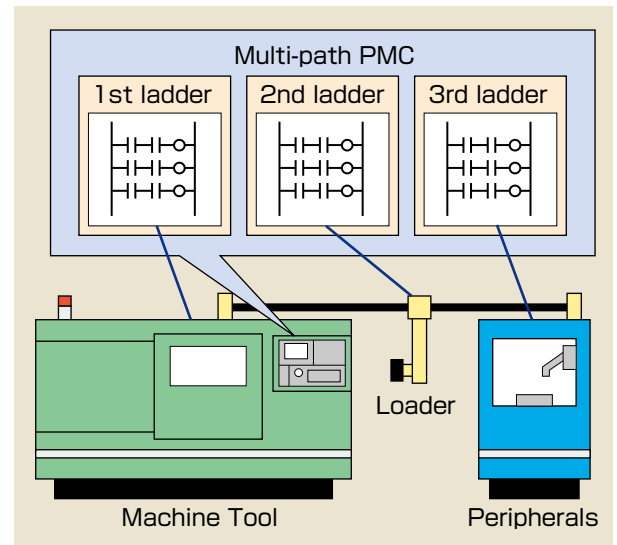

Function Block function (Basic function)

- This function enables to call up repeatedly used ladder circuit patterns in blocks.
- By combining multiple Function Blocks, machine tool builders can create complex ladder programs more efficiently, as if assembling components, with fewer steps for ladder program development and fewer ladder diagram drawings for maintenance.
(Note: Function block does not have an effect on reducing the total program size.)

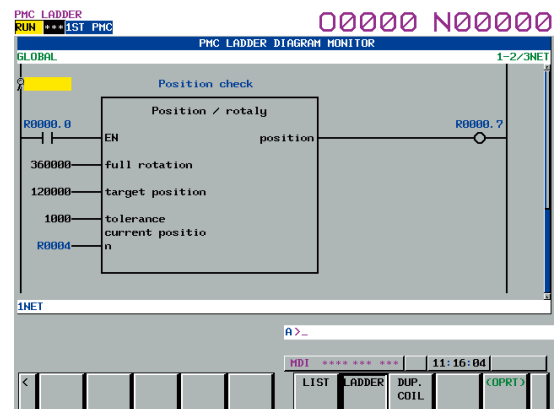

Function Block function

Safety Function

Dual Check Safety + Servo STO

Dual Check Safety is a safety function that conforms to the international safety standard (ISO 13849-1). This function offers a high level of safety by redundant monitoring, and by providing duplicate paths of breaking power for the servo/spindle amplifier. Safety functions built into the CNC make it easier to conform to the safety standards for machine tools.

- Cost can be reduced by significantly simplifying additional circuits for adherence to the safety standard.
- Two PMC functions have been incorporated into the CNC to duplicate sequence control for safety-related input/output signals.
- Safety-related input/output that is defined by a MTB allows redundant monitoring for controlling peripheral devices.
- By using FANUC I/O Link *i*, 1 channel I/O Link cable can configure safety function.
- The safety machine operator's panel which can make the key signals a safety-related signal is prepared.
- STO (Safe Torque Off function) is equipped in the servo amplifier. Power lines for the motor can be shut off without using the electro-magnetic conductor.

Many Customizable Functions

Ease of Use

Customizable functions are available, which allow machine tool builders to customize their own machine tools

Customizing operation screens	➔	C Language Executor/ FANUC PICTURE
MCN operator's panel is realized by softkey	➔	Machine operation menu function
Implementing original sequence control based on PMC	➔	FANUC LADDER-III

C Language Executor

Machine tool builders can create their own operation screens, which enables unique CNC display and operation.

- C language is used for programming.
- Multi window display enables creation of pop-up menus.
- Operation screens using the touch panel can be created.
- In addition to standard ANSI functions, many functions are available for CNCs and PMCs.
- High-level tasks to which high execution priority is assigned can monitor signal and position information.



FANUC PICTURE

FANUC PICTURE enables a machine operation screen to be created only by pasting screen components such as buttons and lamps on the personal computer.

- Easy-to-use interface unique to FANUC.
- A screen usable on a display unit with or without a touch panel can be created.
- A screen usable on a 15 inch display unit and with vertical soft keys can be created.
- A created screen is executed by the C language executor, and can coexist with a C language executor application created by a machine tool builder.

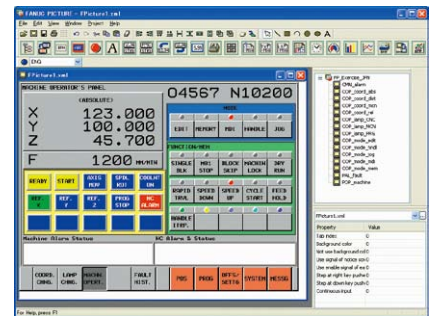

Machine Operation Menu Function

The softkey displayed on CNC screen can be used as a button to operate the machine.

Machine operation such as turning on or off the coolant, that is usually done with the machine operation board, can be done with a softkey on the CNC screen instead.

- The vertical softkey or horizontal softkey is used as a machine operation menu key.
- The hierarchy of the machine operation menu and the displayed character string can be set easily with a special tool on PC.

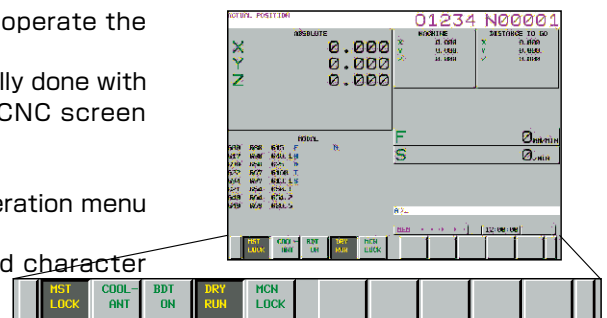

FANUC LADDER-III

For machine customization, a machine tool builder's own sequence control can be incorporated into the built-in PMC. A PMC sequence program can be created on a personal computer by using FANUC LADDER-III, a very easy-to-use programming tool with many useful functions.

- A program can be created with ladder and function block.
- A program can be coded using signal names instead of signal addresses.
- Online monitoring and editing can be performed by connecting a personal computer with the CNC via Ethernet.

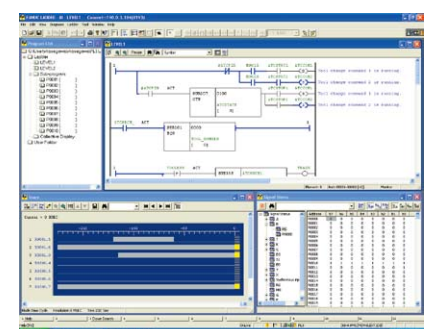

Easy Setup and Maintenance

Ease of Use

Easily support setup and tuning of CNC system

Parameter Tuning Screen

Parameter Tuning Screen supports the necessary parameter setting for start-up and adjustment of CNC, Servo and Spindle. In menu screen, various setting and adjustment screens are selected by cursor operation, and the parameter is set on each screen.

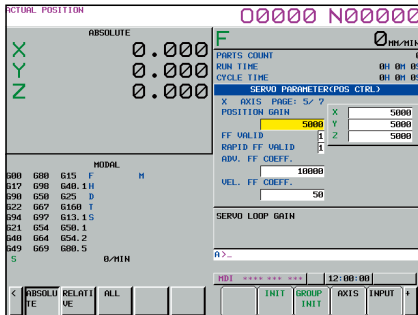

Servo parameter setting screen

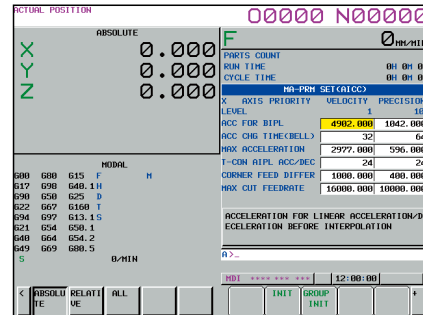

Machining parameter setting screen

“One-shot setting” for servo axes and “One-shot tuning” of filter and velocity gain

The recommended parameters for high-speed and high precision machining can be set only by pressing the soft-key once. Usually enough precision can be achieved with only this “One-shot setting”.

If higher precision is required, filters to eliminate machine resonance and optimum velocity gain for each machine can also be set automatically by only pressing soft-key for Parameter Tuning of Servo Gain.

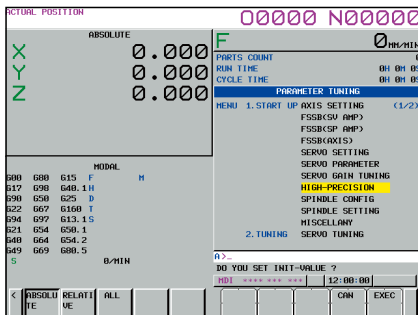

Menu screen

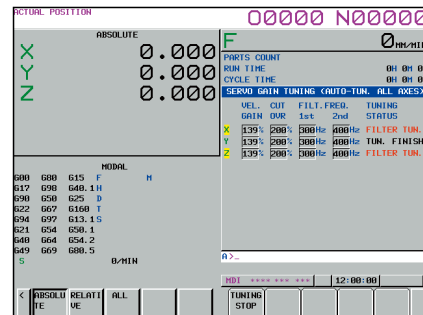

Servo gain tuning screen

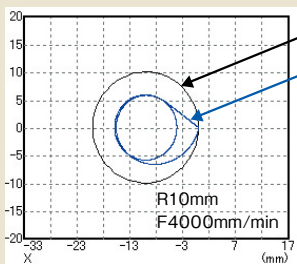

Radius shrinkage 4mm

Before applying
Parameter Setting for High Precision

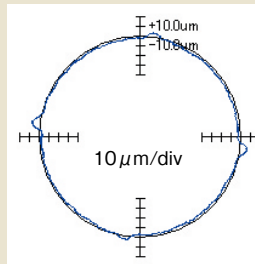

Protrusion 6µm

After applying
Parameter Setting for High Precision

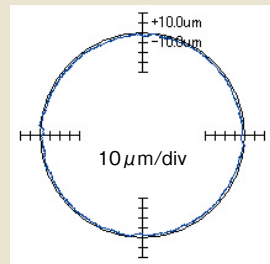

Protrusion 3µm

After applying
Parameter Tuning of Velocity Gain

“One-shot setting” for spindle axes

The initial parameters for start-up of the spindle can be set by “One-shot setting”. The necessary parameters are set automatically by inputting spindle configuration items, such as motor model, maximum speed, sensors. This screen supports the initial setting also for the optimum orientation function and the parameters for high speed rigid tapping.

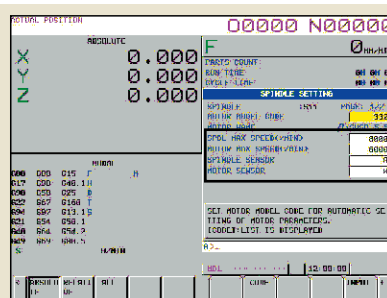

Spindle parameter setting screen

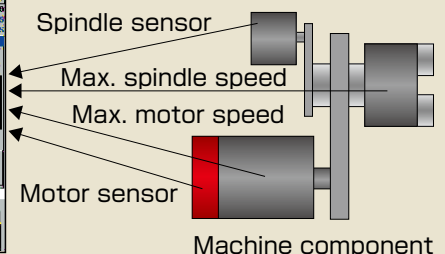

Machine component

Functions for minimizing downtime

Preventive Maintenance

Leakage Detection Function

Insulation deterioration sometimes causes a machine to stop due to cutting fluid infiltrating the motor, especially in a severe machining environment. The leakage detection function built-in amplifier automatically measures insulation resistance of the motor, and detects insulation deterioration when it comes to an abnormal level, thereby preventing machine from unexpected stop.

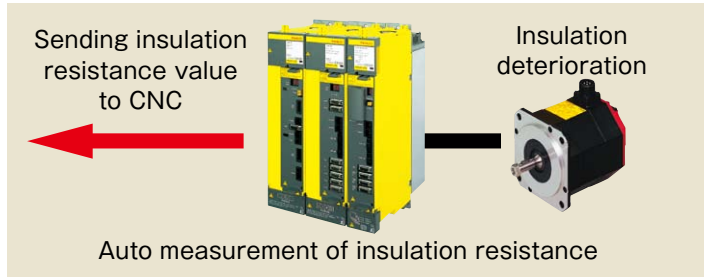

Cooling Fan Warning Function

Fan motors may have some trouble with exposure to coolant oil with long-term usage in a FA environment. A decrease in rotational speed of each cooling fan motor of the CNC and the amplifier is detected as a warning. By this function, deterioration of the fan are detected and can be replaced before fan stops. Fans are stored in a cartridge and can be replaced quite easily, so maintainability is enhanced.

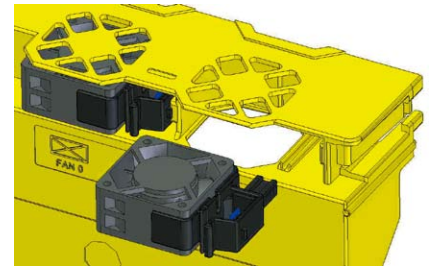

Failure Part Detection

Trouble Diagnostic Function

If a power failure or disconnection of the communication cable happened on the I/O modules and servo amplifiers, it would be detected from a warning alarm from detection functions embedded in the I/O Link *i* and FSSB. It can specify at which point the failure happens. In addition to that, I/O link *i* can detect the ground fault of each DO.

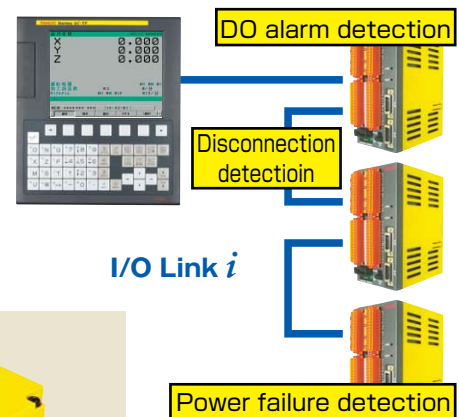

Encoder Communication Check Circuit

When Pulsecoder communication alarm occurs, it is sometimes time consuming to identify the failing part because there are three possibilities: detector, feedback cable, or servo amplifier. It might cause long machine downtime. Encoder Communication Check Circuit outputs the dummy feedback signal which makes it easier to identify the failing part quickly.



Protecting Machine at Power Failure

Machine Protection at Power Failure

Damage of workpieces and tools at power failure is prevented where a stable power supply cannot be expected.

- **Gravity-axis drop prevention**
Motor brake is activated quickly by detecting the power failure using power failure detection method in the standard α IPS-B.
- **Stop distance reduction** *1)
Feed axes are decelerated to stop in order to prevent feed axes crashing with high-speed machine tools.
- **Retract** *2)
Tool is retracted from workpiece keeping synchronization with gear cutting machine.

*1), *2) "Power Failure Backup Module (Hardware)" or "Power Failure Backup Function (Software)" shall be applied.

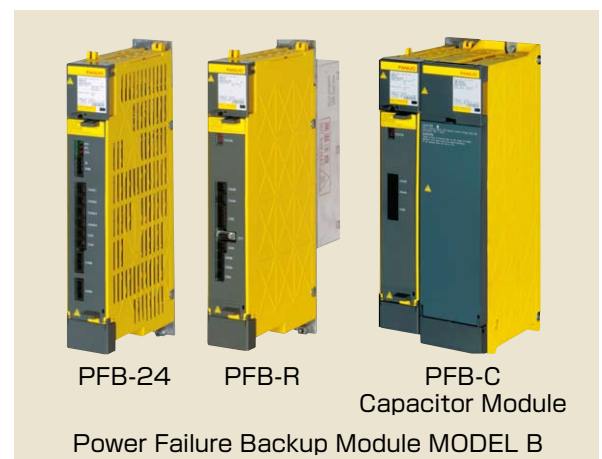

Powerful Software Tools

Supports development of machine tool builders in a variety of fields such as simulation and data management

FANUC NCGuide

Software tool "FANUC NCGuide" simulates CNC operation on a PC to fully utilize the ever advancing CNC functions. FANUC NCGuide is available for the following two purposes:

- Training of CNC / MANUAL GUIDE *i* operations
- Development and debugging of PMC ladder and custom software

Training of CNC / MANUAL GUIDE *i* operations

FANUC NCGuide is a software tool that enables training of CNC / MANUAL GUIDE *i* operations on a PC. It allows operators to be trained without using an actual machine tool. This software tool can also be used for CNC education of students in school. With a machining simulation function of MANUAL GUIDE *i*, machining programs can be checked easily.

- Training of CNC / MANUAL GUIDE *i* can be enabled
- Edit operation of the machining programs and cycles at EDIT mode can be enabled
- Machining simulation function (animation, tool path drawing) can be enabled



Development and debugging of PMC ladder and custom software

With a PMC simulation function, execution and debugging of the ladder is available on a PC.

FANUC PICTURE, C Language Executor and Macro Executor can also be executed, so that this software tool can be used to debug a custom screen created by a machine tool builder.

- PMC ladder can be executed on PC
- Ladder can be efficiently debugged with a PMC simulation function interacting with the CNC simulation function
- Ladder can be edited and displayed interacting with FANUC LADDER-III
- With a machine signal simulation function, the ladder can be debugged in near-actual machine environment
- Custom software made with FANUC PICTURE / C Language Executor / Macro Executor can be executed

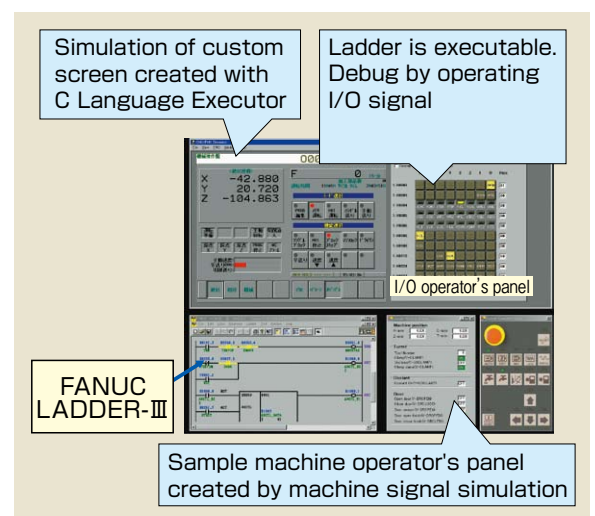

FANUC Program Transfer Tool

FANUC Program Transfer Tool is a software tool for transferring part programs and data by connecting PC and CNC via Ethernet.

Files in the CNC program memory are displayed on the tool in an easy-to-understand way, so input/output operation can be easily performed with a mouse.

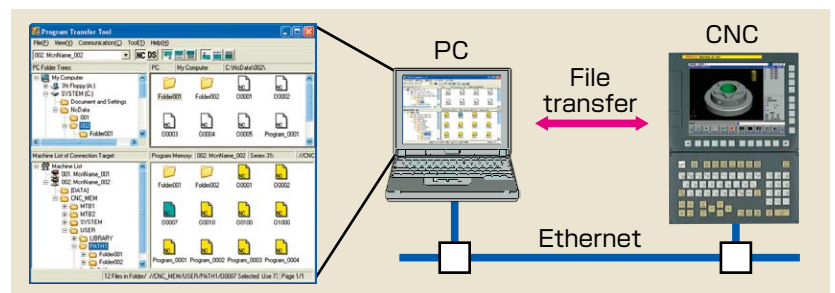

FANUC CNC Setting Tool

FANUC CNC Setting Tool is a software tool used to set and manage CNC parameters on a personal computer. Parameters can be set and managed efficiently without referring to the manual.

- Parameters are classified by the CNC function
- Detailed explanation is displayed by selecting a parameter
- CNC parameter is transmitted via Ethernet or memory card

Maintenance and Customer Support

Worldwide Customer Service and Support

FANUC operates customer service and support network worldwide through subsidiaries and affiliates. FANUC provides the highest quality service with the prompt response at any location nearest you.



FANUC Training Center

FANUC Training Center operates versatile training courses to develop skilled engineers effectively in several days.

Inquiries : Yamanakako-mura, Yamanashi,
Japan 401-0501

Phone : 81-555-84-6030
Fax : 81-555-84-5540



FANUC CORPORATION

• Headquarters Oshino-mura, Yamanashi 401-0597, Japan
Phone: 81-555-84-5555 Fax: 81-555-84-5512 <http://www.fanuc.co.jp>

<ul style="list-style-type: none"> • America and South America FANUC America Corporation FANUC South America Equipment of Automation Service Ltd. (Brazil) • Europe, the middle east and Africa FANUC Europe Corporation, S.A. FANUC Deutschland GmbH FANUC FA France SAS FANUC FA UK LIMITED FANUC FA Italia S.r.l. FANUC FA Iberia S.A.U FANUC FA Satis ve Servis Tic. Ltd. Sti. (Turkey) FANUC FA Bulgaria Ltd. FANUC Czech s.r.o. FANUC FA Hungary Kft FANUC SOUTH AFRICA (PTY) LIMITED "FANUC AUTOMATION" LLC (Russia) 	<p>Tel 1-847-898-5000</p> <p>Tel 55-11-3952-8888</p> <p>Tel 352-727777-1</p> <p>Tel 49-7158-187400</p> <p>Tel 33-1-6989-7000</p> <p>Tel 44-1895-634182</p> <p>Tel 39-02-45795-1</p> <p>Tel 34-943-74-82-90</p> <p>Tel 90-216-651-1408</p> <p>Tel 359-2-963-3319</p> <p>Tel 420-234-072-111</p> <p>Tel 36-23-332-007</p> <p>Tel 27-11-392-3610</p> <p>Tel 7-495-956-9780</p>	<p>Fax 1-847-898-5001</p> <p>Fax 55-11-3856-0848</p> <p>Fax 352-727777-202</p> <p>Fax 49-7158-187455</p> <p>Fax 33-1-6989-7001</p> <p>Fax 44-1895-676140</p> <p>Fax 39-02-45795-250</p> <p>Fax 34-943-74-44-21</p> <p>Fax 90-216-6511405</p> <p>Fax 359-2-963-2873</p> <p>Fax 420-234-072-110</p> <p>Fax 36-23-332-008</p> <p>Fax 27-11-392-3615</p> <p>Fax 7-495-956-9785</p>	<ul style="list-style-type: none"> FANUC FA Polska Sp. zo.o. FANUC FA Nordic AB FANUC FA Switzerland GmbH • Asia and Oceania KOREA FANUC CORPORATION TAIWAN FANUC CORPORATION BEIJING-FANUC Mechatronics CO., LTD. FANUC INDIA PRIVATE LIMITED FANUC THAI LIMITED FANUC MECHATRONICS (MALAYSIA) SDN. BHD. PT. FANUC INDONESIA FANUC SINGAPORE PTE. LTD. FANUC OCEANIA PTY. LIMITED FANUC PHILIPPINES CORPORATION FANUC VIETNAM COMPANY LIMITED 	<p>Tel 48-71-7766-170</p> <p>Tel 46-8-505-80-700</p> <p>Tel 41-32-366-63-63</p> <p>Tel 82-55-278-1200</p> <p>Tel 886-4-2359-0522</p> <p>Tel 86-10-6298-4726</p> <p>Tel 91-80-2852-0041</p> <p>Tel 66-2-714-6111</p> <p>Tel 60-3-7628-0110</p> <p>Tel 62-21-4584-7285</p> <p>Tel 65-6-220-3911</p> <p>Tel 61-2-8822-4600</p> <p>Tel 63-2-813-3155</p> <p>Tel 84-8-3824-6638</p>	<p>Fax 48-71-7766-179</p> <p>Fax 46-8-505-80-701</p> <p>Fax 41-32-366-63-64</p> <p>Fax 82-55-284-9826</p> <p>Fax 886-4-2359-0771</p> <p>Fax 86-10-6298-4741</p> <p>Fax 91-80-2852-8491</p> <p>Fax 66-2-714-6120</p> <p>Fax 60-3-7628-0220</p> <p>Fax 62-21-4584-7288</p> <p>Fax 65-6-225-0098</p> <p>Fax 61-2-8822-4666</p> <p>Fax 63-2-813-3157</p> <p>Fax 84-8-3824-6637</p>
-----------------------------------------------------------------------------------------------------------------------------------------------------------------------------------------------------------------------------------------------------------------------------------------------------------------------------------------------------------------------------------------------------------------------------------------------------------------------------------------------------------------------------------------------------------------------------------------------------------------------------------------------------------------------------------	-----------------------------------------------------------------------------------------------------------------------------------------------------------------------------------------------------------------------------------------------------------------------------------------------------------------------------------------------------------------------------	--------------------------------------------------------------------------------------------------------------------------------------------------------------------------------------------------------------------------------------------------------------------------------------------------------------------------------------------------------------------------------	---------------------------------------------------------------------------------------------------------------------------------------------------------------------------------------------------------------------------------------------------------------------------------------------------------------------------------------------------------------------------------------------------------------------------------------------------------------------------------------------------------------------------------------------------------------------------------------------	--------------------------------------------------------------------------------------------------------------------------------------------------------------------------------------------------------------------------------------------------------------------------------------------------------------------------------------------------------------------------------	--------------------------------------------------------------------------------------------------------------------------------------------------------------------------------------------------------------------------------------------------------------------------------------------------------------------------------------------------------------------------------

• All specifications are subject to change without notice.
 • No part of this catalog may be reproduced in any form.
 • The products in the FANUC Series 0i-MODEL F listed in this catalog are not subject to Items 2 to 15 in the Attachment to the Foreign Exchange Order of the "Foreign Exchange and Foreign Trade Law" but are subject to Item 16 (catch-all controls).
 The export from Japan may be subject to an export license by the government of Japan.
 Further, re-export to another country may be subject to the license of the government of the country from where the product is re-exported. Furthermore, the product may also be controlled by re-export regulations of the United States government.
 Should you wish to export or re-export these products, please contact FANUC for advice.