



www.anceldirect.com

## User Manual

# FX Series Full System Scan Tool



## Table of Contents

<b>1. SAFETY PRECAUTIONS AND WARNINGS</b> .....	<b>4</b>
<b>2. GENERAL INFORMATION</b> .....	<b>5</b>
2.1 ON-BOARD DIAGNOSTICS (OBD) II .....	5
2.2 DIAGNOSTIC TROUBLE CODES (DTCs).....	5
2.3 LOCATION OF DATA LINK CONNECTOR (DLC) .....	7
2.4 OBD II READINESS MONITORS .....	8
2.5 OBD II MONITOR READINESS STATUS.....	9
2.6 OBD II DEFINITIONS.....	10
<b>3. USING THE SCAN TOOL</b> .....	<b>13</b>
3.1 TOOL DESCRIPTION .....	13
3.2 SPECIFICATIONS .....	13
3.3 ACCESSORIES INCLUDED .....	14
3.4 KEYBOARD.....	14
<i>Function Button</i> .....	14
3.4.1 <i>To set favorite car makes</i> .....	14
3.4.2 <i>To select live data at the actual value testing</i> ....	15
3.4.3 <i>Used as Tab button at special function</i> .....	15
3.4.4 <i>To load the keyboard for message input</i> .....	16
<i>Esc Button</i> .....	17
<i>Up Button</i> .....	17
<i>Down Button</i> .....	17
<i>Left Button</i> .....	17
<i>Right Button</i> .....	18
<i>OK Button</i> .....	18
3.5 POWER SUPPLY .....	18
3.6 DIAGNOSE.....	19
<i>American coverage</i> .....	19
<i>European coverage</i> .....	20
<i>Asian coverage</i> .....	21
3.7 FAVORITE .....	22
3.8 OBDII .....	22

3.9 SETTINGS .....	23
<i>Language</i> .....	24
<i>Unit</i> .....	25
<i>Beep</i> .....	26
<i>Key Test</i> .....	27
<i>LCD Test</i> .....	28
3.10 ABOUT .....	28
3.11 VEHICLE COVERAGE .....	29
3.12 PRODUCT TROUBLESHOOTING .....	29
<i>Vehicle Linking Error</i> .....	29
<i>Operating Error</i> .....	30
<i>Scan tool doesn't power up</i> .....	30
<b>4. DIAGNOSTIC OPERATIONS.....</b>	<b>31</b>
4.1 START A NEW TEST .....	31
4.2 START A QUICK TEST.....	34
4.3 READ IDENTIFICATION .....	39
4.4 READ FAULT MEMORY / READ DTC.....	40
4.5 CLEAR FAULT MEMORY / CLEAR DTC .....	41
4.6 READ LIVE DATA / DATASTREAM.....	43
<b>5. SOFTWARE UPDATE.....</b>	<b>46</b>
5.1 REGISTER THE SCAN TOOL.....	46
5.2 SOFTWARE UPDATE FLOW CHART .....	47
<b>6. WARRANTY AND SERVICE.....</b>	<b>48</b>
6.1 LIMITED ONE YEAR WARRANTY .....	48
6.2 SERVICE PROCEDURES.....	50
<b>FAQ (FREQUENCY ASK QUESTIONS) .....</b>	<b>50</b>

## 1. Safety Precautions and Warnings

**To prevent personal injury or damage to vehicles and/or the scan tool, read this instruction manual first and observe the following safety precautions at a minimum whenever working on a vehicle:**

- ✦ Always perform automotive testing in a safe environment.
- ✦ Wear safety eye protection that meets ANSI standards.
- ✦ Keep clothing, hair, hands, tools, test equipment, etc. away from all moving or hot engine parts.
- ✦ Operate the vehicle in a well-ventilated work area: Exhaust gases are poisonous.
- ✦ Put blocks in front of the drive wheels and never leave the vehicle unattended while running tests.
- ✦ Use extreme caution when working around the ignition coil, distributor cap, ignition wires and spark plugs. These components create hazardous voltages when the engine is running.
- ✦ Put the transmission in PARK (for automatic transmission) or NEUTRAL (for manual transmission) and make sure the parking brake is engaged.
- ✦ Keep a fire extinguisher suitable for gasoline/chemical/ electrical fires nearby.
- ✦ Don't connect or disconnect any test equipment while the ignition is on or the engine is running.
- ✦ Keep the scan tool dry, clean, free from oil/water or grease. Use a mild detergent on a clean cloth to clean the outside of the scan tool, when necessary.

## **2. General Information**

### **2.1 On-Board Diagnostics (OBD) II**

The first generation of On-Board Diagnostics (OBD I) was developed by the California Air Resources Board (ARB) and implemented in 1988 to monitor some of the emission control components on vehicles. As technology evolved and the desire to improve the On-Board Diagnostic system increased, a new generation of On-Board Diagnostic system was developed. This second generation of On-Board Diagnostic regulations is called "OBD II".

The OBD II system is designed to monitor emission control systems and key engine components by performing either continuous or periodic tests of specific components and vehicle conditions. When a problem is detected, the OBD II system turns on a warning lamp (MIL) on the vehicle instrument panel to alert the driver typically by "Check Engine" or "Service Engine Soon".

The system will also store important information about the detected malfunction so that a technician can accurately find and fix the problem.

Here below three pieces of such valuable information:

- 1) Malfunction Indicator Light (MIL) is commanded as 'ON' or 'OFF';
- 2) Diagnostic Trouble Codes (DTCs) are stored;
- 3) Readiness Monitor status.

### **2.2 Diagnostic Trouble Codes (DTCs)**

OBD II Diagnostic Trouble Codes are codes that are stored by the on-board computer diagnostic system in response to a problem found in the vehicle. These codes identify a particular problem area and are intended to

provide you with a guide as to where a fault might be occurring within a vehicle. OBD II Diagnostic Trouble Codes consists of a five-digit alphanumeric code. The first character, a letter, identifies which control system sets the code. The other four characters, all numbers, provide additional information on where the DTC originated and the operating conditions that caused it to set. Here below is an example to illustrate the structure of the digits:

### Explanation of OBD2 Diagnostic Trouble Codes

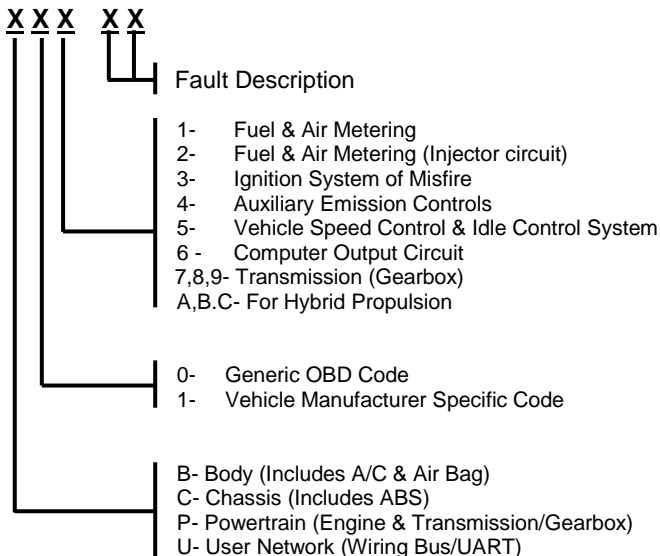

### 2.3 Location of Data Link Connector (DLC)

The DLC (Data Link Connector or Diagnostic Link Connector) is the standardized 16-cavity connector where diagnostic scan tools interface with the vehicle's on-board computer. The DLC is usually located 12 inches from the center of the instrument panel (dash), under or around the driver's side for most vehicles.

If Data Link Connector is not located under dashboard, a label should be there telling location. For some Asian and European vehicles, the DLC is located behind the ashtray and the ashtray must be removed to access the connector. If the DLC cannot be found, refer to the vehicle's service manual for the location.

OBID II Port Location - If you are not sure, please consult car mechanic

The blue blocks show the possible OBID II port locations.  
They maybe different according to different car models

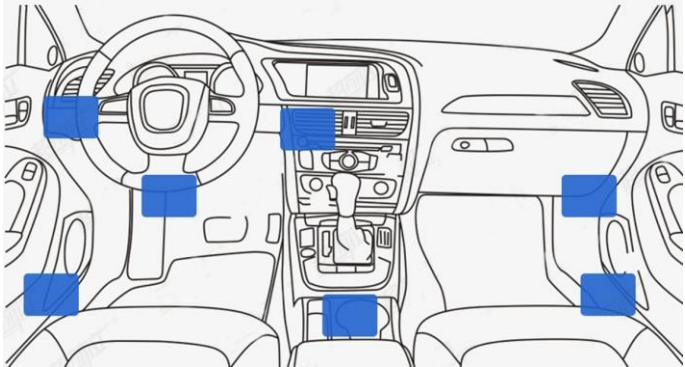

## 2.4 OBD II Readiness Monitors

An important part of a vehicle's OBD II system is the Readiness Monitors, which are indicators used to find out if all of the emissions components have been evaluated by the OBD II system. They are running periodic tests on specific systems and components to ensure that they are performing within allowable limits.

Currently, there are eleven OBD II Readiness Monitors (or I/M Monitors) defined by the U.S. Environmental Protection Agency (EPA). Not all monitors are supported by all vehicles and the exact number of monitors in any vehicle depends on the motor vehicle manufacturer's emissions control strategy.

**Continuous Monitors** -- Some of the vehicle components or systems are continuously tested by the vehicle's OBD II system, while others are tested only under specific vehicle operating conditions. The continuously monitored components listed below are always ready:

- ⊛ Misfire
- ⊛ Fuel System
- ⊛ Comprehensive Components (CCM)

Once the vehicle is running, the OBD II system is continuously checking the above components, monitoring key engine sensors, watching for engine misfire, and monitoring fuel demands.

**Non-Continuous Monitors** -- Unlike the continuous monitors, many emissions and engine system components require the vehicle to be operated under specific conditions before the monitor is ready.



These monitors are termed non-continuous monitors. For different ignition type engines, the available monitors are different too.

The following monitors are to be used for spark ignition engines only:

- ✓ EGR System
- ✓ O2 Sensors
- ✓ Catalyst
- ✓ Evaporative System
- ✓ O2 Sensor Heater
- ✓ Secondary air
- ✓ Heated Catalyst

The following monitors are to be used for compression ignition engines only:

- ✓ EGR System
- ✓ NMHC Catalyst
- ✓ NOx after treatment
- ✓ Boost pressure system
- ✓ Exhaust gas sensor
- ✓ PM filter

## **2.5 OBD II Monitor Readiness Status**

OBD II systems must indicate whether or not the vehicle's PCM's monitor system has completed testing on each component. Components that have been tested will be reported as "Ready", or "Complete", meaning they have been tested by the OBD II system.

The purpose of recording readiness status is to allow inspectors to determine if the vehicle's OBD II system has tested all the components and/or systems.

The power-train control module (PCM) sets a monitor to “Ready” or “Complete” after an appropriate drive cycle has been performed. The drive cycle that enables a monitor and sets readiness codes to “Ready” varies for each individual monitor.

Once a monitor is set as “Ready” or “Complete”, it will remain in this state. A number of factors, including erasing of diagnostic trouble codes (DTCs) with a scan tool or a disconnected battery, can result in Readiness Monitors being set to “Not Ready”.

Since the three continuous monitors are constantly evaluating, they will be reported as “Ready” all of the time. If testing of a particular supported non-continuous monitor has not been completed, the monitor status will be reported as “Not Complete” or “Not Ready.”

In order for the OBD monitor system to become ready, the vehicle should be driven under a variety of normal operating conditions. These operating conditions may include a mix of highway driving and stop and go, city type driving, and at least one overnight-off period. For specific information on getting your vehicle’s OBD monitor system ready, please consult your vehicle owner’s manual.

## **2.6 OBD II Definitions**

**Power-train Control Module (PCM)** -- OBD II terminology for the on-board computer that controls engine and drive train.

**Malfunction Indicator Light (MIL)** -- Malfunction Indicator Light (Service Engine Soon, Check Engine) is a term used for the light on the instrument panel. It is to alert the driver and/or the repair technician that there is a

problem with one or more of vehicle's systems and may cause emissions to exceed federal standards. If the MIL illuminates with a steady light, it indicates that a problem has been detected and the vehicle should be serviced as soon as possible. Under certain conditions, the dashboard light will blink or flash. This indicates a severe problem and flashing is intended to discourage vehicle operation. The vehicle onboard diagnostic system cannot turn the MIL off until necessary repairs are completed or the condition no longer exists.

**DTC** -- Diagnostic Trouble Codes (DTC) that identifies which section of the emission control system has malfunctioned.

**Enabling Criteria** -- Also termed Enabling Conditions. They are the vehicle-specific events or conditions that must occur within the engine before the various monitors will set, or run. Some monitors require the vehicle to follow a prescribed "drive cycle" routine as part of the enabling criteria. Drive cycles vary among vehicles and for each monitor in any particular vehicle.

**OBD II Drive Cycle** -- A specific mode of vehicle operation that provides conditions required to set all the readiness monitors applicable to the vehicle to the "ready" condition. The purpose of completing an OBD II drive cycle is to force the vehicle to run its onboard diagnostics.

Some form of a drive cycle needs to be performed after DTCs have been erased from the PCM's memory or after the battery has been disconnected. Running through a vehicle's complete drive cycle will "set" the readiness monitors so that future faults can be detected. Drive cycles vary depending on the vehicle and the monitor that

needs to be reset. For vehicle specific drive cycle, consult the vehicle's Owner's Manual.

**Freeze Frame Data** -- When an emissions related fault occurs, the OBD II system not only sets a code but also records a snapshot of the vehicle operating parameters to help in identifying the problem. This set of values is referred to as Freeze Frame Data and may include important engine parameters such as engine RPM, vehicle speed, air flow, engine load, fuel pressure, fuel trim value, engine coolant temperature, ignition timing advance, or closed loop status.

## 3. Using the Scan Tool

### 3.1 Tool Description



1	Up button
2	Left button
3	Right button
4	Down button
5	OK button

6	Power Supply Port
7	USB Port
8	Esc button
9	Function button
10	Main cable port

### 3.2 Specifications

No	Item	Description
1	Display	TFT color display(480 x 272 dpi)
2	Working Temp	-20 to 60°C (32 to 140 °F)
3	Storage Temp.	-20 to 70°C (-4 to 158 °F)
4	Power Supply:	12 - 18V power provided via vehicle battery or adapter
5	Dimensions	L: 270 mm W: 250mm H:75mm
6	Gross Weight	1.5kg

### 3.3 Accessories Included

No	Item	Description
1	User Manual	Instructions for tool operations
2	Main cable	Connect the tool and the OBDII connector to the vehicle
3	OBDII connector	Provide the power supply and communicates between tool and vehicle
4	USB cable	Used to upgrade the software for the scan tool
5	Carry case:	A portable case to store the scan tool when not in use

### 3.4 Keyboard

#### **Function Button**

**Function Button** - Corresponds with “Fn” on screen for executing commands

There are several functions for Fn button as below:

#### **3.4.1 To set favorite car makes**

**How to do:.**

**Diagnose --- OK --- American --- OK --- Fn --- GM**

A green cross will be popup on the right corner of the vehicle icon.

**Note:**

- Move **Left** and **Right** button to set favorite car makes
- Click **Fn** again to cancel favorite car makes settings

### 3.4.2 To select live data at the actual value testing

How to do:

Diagnose --- OK --- EUROPEAN --- BENZ --- OK ---  
 Down Button --- [2] Transport or V-Class --- OK --- [1]  
 Sprinter --- OK --- [1] 906 --- OK --- [1] Gasoline engine  
 --- OK --- [1] Left-hand steering --- OK --- [1] Manual  
 transmission --- OK --- [2] Control units --- [1] Drive ---  
 OK --- [1] ETC --- Electronic transmission control ---  
 OK --- Down Button --- [5] Actual values --- [1] Speeds  
 --- OK --- Fn Button --- [1] 001 Y33/6n2 (speed sensor

A red cross will be popup on the left of the live data

**Note:**

- Move **Up** and **Down** to select more items
- Move **Left** and **Right** for page up and page down
- Only live data can be selected for graphic display

### 3.4.3 Used as Tab button at special function

How to do:

Diagnose --- OK --- EUROPEAN --- BENZ --- OK  
 --- Down Button --- [2] Transport or V-Class ---  
 OK --- [1] Sprinter --- OK --- [1] 906 --- OK --- [1]  
 Gasoline engine --- OK --- [1] Left-hand steering  
 --- OK --- [1] Manual transmission --- OK --- [2]  
 Control units --- [1] Drive --- OK --- [1] ETC ---  
 Electronic transmission control --- OK --- Down  
 Button --- [6] Actuators --- OK --- [1] Test all  
 solenoid valves --- OK --- OK

### 3.4.4 To load the keyboard for message input

**How to do:**  
**Diagnose --- OK --- EUROPEAN --- VW --- Live**  
**Data --- Input Chanel Number**



Test all solenoid valves	
011 Selected gear by means of selector lever	D
Function Button Description	
F1: START	
Press "Fn" to operate other modules	

F1

Test all solenoid valves	
011 Selected gear by means of selector lever	D
Function Button Description	
F1: START	
Press "Fn" to operate other modules	

F1

Test all solenoid valves	
011 Selected gear by means of selector lever	D
Function Button Description	
F1: START	
Press "Fn" to operate other modules	

F1



A red cross will be popup on the left of the live data

Three conditions are shown as below when click the **Fn** button, in this case the **Up**, **Down**, **Left**, **Right** and **OK** buttons will be activated accordingly:

**Note:**

- Move **Up** and **Down** to select more items
- Move **Left** and **Right** for page up and page down  
Only live data can be selected for graphic display

**Esc Button**

**Esc Button** - Cancels a selection (or action) from a menu or returns to the previous screen

**Up Button**

**Up Button** - Moves up through menu and submenu items in menu mode. When more than one screen of data is retrieved, moves up through the current screen to the previous screens for additional data. When looking up DTC, it is used to change value of selected character

**Down Button**

**Down Button** - Moves down through menu and submenu items in menu mode. When more than one screen of data is retrieved, moves down through the current screen to next screens for additional data. When looking up DTC, it is used to change value of selected character

**Left Button**

**Left Button** - When look up DTC definitions, moves to previous character and views additional information on previous screens if DTC definition covers more than one screen; views previous screen /frames of recorded data.

### **Right Button**

**Right Button** -When look up DTC definitions, moves to next character and view additional information on next screens if DTC definition covers more than one screen; views next screen or next frames of recorded data.. It is also used to view next trouble code when viewing DTCs.

### **OK Button**

**OK Button** - Confirms a selection /action from a menu.

## **3.5 Power Supply**

Before using the scan tool, you must provide power to the scan tool. There are two methods for providing power to the scan tool.

- DC external power adapter.
- Cable connection to vehicle.



During vehicle testing, power for the scan tool is usually provided through the vehicle cable connection. When the scan tool is not connected to a vehicle, the scan tool can be powered with an AC/DC external power adapter.

While the scan tool is powered via the vehicle Data Link Connector (DLC), just follow the steps below to turn on the scan tool:

- 1) Connect the Cable to scan tool.
- 2) Find DLC on vehicle.

*NOTE: The DLC cover may be found for some vehicles and you need to remove the plastic cover before plugging the OBDII connector.*

- 3) Plug the OBDII connector to the vehicle's DLC.
- 4) Power up the tool, and wait for the **Main Screen**.

 Diagnose	 OBDII V3.0	 Settings	 Favorite
 About			



### 3.6 Diagnose

 Diagnose	<p>This section provides the car diagnosis base on different areas and car makes.</p>
---	---

Three options are available for area choices as below:

 AMERICAN	 ASIAN	 EUROPEAN	
--	---	--	--

#### *American coverage*

 FORD	 GM	 CHRYSLER	
---	---	---	--

**European coverage**

 ALFA	 VW	 BENZ	 BMW
ALFA-ROMEO	AUDI	BENZ	BMW
 CITROEN	 VW	 FIAT	 FORD
CITROEN	VOLKSWAGEN	FIAT	FORD
 JAGUAR	 LANCIA	 LAND ROVER	 MINI
JAGUAR	LANCIA	LANDROVER	MINI
 OPEL	 PEUGEOT	 PORSCHE	 RENAULT
OPEL	PEUGEOT	PORSCHE	RENAULT
 VAUXHALL	 SEAT	 SKODA	 SMART
VAUXHALL	SEAT	SKODA	SMART
 VOLVO			
VOLVO			

**Asian coverage**

 ACURA	 DAEWOO	 DAIHATSU	 TOYOTA
 HONDA	 HYUNDAI	 INFINITI	 ISUZU
 KIA	 LEXUS	 MAZDA	 MITSUBISHI
 NISSAN	 SSANGYONG	 SUBARU	 SUZUKI

### 3.7 Favorite



This section provides user customizing car makes adding function.

#### How to do:

- 1) Move the **Left/Right** or **Up/Down** button under the Main Menu to select the button **Diagnose**.
- 2) Press **OK**, and then select some area from American, Asian and European. The screen will display different car makes in list.
- 3) Press **Fn**, a green mark will be displayed on the upper right corner of the car make icon.
- 4) Press **OK** to save the setting. Any car icons can be added and saved as the **Favorite** by this way.
- 5) The user can access **Favorite** for car testing which is common used.

### 3.8 OBDII



This section provides OBD protocols for vehicle communication including:

- ✦ SAE J1850-41.6 Kbps (PWM)
- ✦ SAE J1850-10.4 Kbps (VPW)"
- ✦ ISO 14230 (KWP2000)"
- ✦ ISO 9141-2"
- ✦ ISO 15765 (CAN)"

### 3.9 Settings

 Settings	<p>This section provides system setting functions for the scan tool.</p>
---	--

Five options are available for area choices as below:

 LANGUAGE	 UNIT	 BEEP	 KEY TEST
 LCD TEST			

#### To enter the Settings menu

From the **Main Screen**, use **Left/Right** to select **Settings**, and press **OK**.

Following the instructions to do adjustments and settings could make your diagnosis more conveniently and easily.

*NOTE: Settings of the unit will remain until change to the existing settings is made.*

## Language



This section provides multiple languages for different areas.

Generally speaking two languages will be fixed, and English language is set as default before delivery.

### How to do:

- 1) Move the **Left/Right** or **Up/Down** button under the Main Screen to select the button **Settings**.
- 2) Press **OK** and then press **Language**.
- 3) The screen will display two languages in list. Move **Left/Right** button to the desired language and then press **Fn**, a green mark will be displayed on the upper right corner of the car make icon.
- 4) Press **OK** to save the current setting. The system will remember the language setting and display all information with the set language.

### NOTE:

- ☛ **English is the default language.**
- ☛ **Press *Esc* to exit without saving.**



## Unit



This section provides unit measuring options between English and Metric.

### How to do:

- 1) Move the **Left/Right** or **Up/Down** button under the Main Screen to select the button **Settings**.
- 2) Select **Unit** and press **OK**.
- 3) The below screen will be displayed for unit measurement setting.

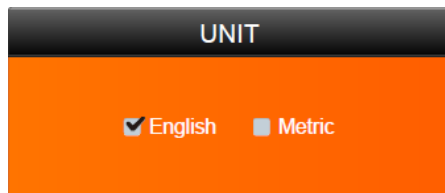

- 4) Move the button **Left/Right** to set the unit required.
- 5) Press **OK** to save the selection.

### NOTE:

- ✦ **Metric is the default setting.**
- ✦ **Press Esc to exit without saving.**

## Beep



This section provides button sound testing with ON/OFF options.

### How to do:

- 1) Move the **Left/Right** or **Up/Down** button under the Main Screen to select the button **Settings**.
- 2) Select **Beep** and press **OK**.
- 3) The below screen will be displayed for button beep sound setting.

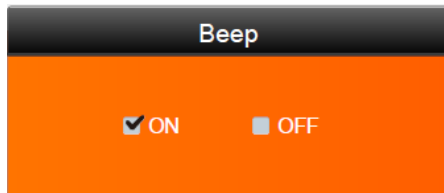

- 4) Move the button **Left/Right** to set the unit required.
- 5) Press **OK** to save the selection.

### NOTE:

- ⊗ **ON is the default setting.**
- ⊗ **Press Esc to exit without saving.**

## Key Test

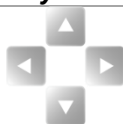

This section provides the keys testing options. The user can check whether the keyboard is working properly.

### How to do:

- 1) Move the **Left/Right** or **Up/Down** button under the Main Screen to select the button **Settings**.
- 2) Select **Key Test** and press **OK**.
- 3) The below screen will be displayed:



- 4) Press the button **Fn**, **Esc**, **Up**, **Down**, **Left**, **Right**, **OK** one by one to test keys.

### NOTE:

- ⌂ Press **Fn** for 2s to quit the testing.

### LCD Test



This section provides LCD display testing options. The user can check

#### How to do:

- 1) Move the **Left/Right** or **Up/Down** button under the Main Screen to select the button **Settings**.
- 2) Select **LCD Test** and press **OK**.
- 3) The LCD screen will display red, green, blue, white and black with sequence to test whether the LCD display is working properly.

#### NOTE:

- ☛ Press **Esc** to exit the screen testing.

### 3.10 About



This section provides some important information such as product serial number, register password, firmware version, system software version, hardware version, manufacture date etc.

#### How to do:

- 1) Move the **Left/Right** or **Up/Down** button under the Main Screen to select the button **About**.
- 2) Press **OK** and the LCD screen will display some important information.

### 3.11 Vehicle Coverage

On the basis of all OBD II compliant vehicles, including those equipped with universal protocol -- Control Area Network (CAN), ANCEL FX Series Auto Scanner expands vehicle system coverage and offers more diagnostic power to the vehicle technicians.

Featuring expanded global vehicle coverage, the scan tool offers technicians a significant improvement on model years covered by supported manufactures. We've worked backwards to include non-OBDII vehicles, which can be diagnosed by setting up with optional OBDI adaptors.

For a complete listing of all the added vehicle coverage, download a copy of the official ANCEL FX Series scan tool Software Release Note.

### 3.12 Product Troubleshooting

#### Vehicle Linking Error

A communication error occurs if the scan tool fails to communicate with vehicle's ECU (Electronic Control Unit).

You need to do the following to check up:

- Verify that the ignition is ON.
- Check if the scan tool's connector is securely connected to the vehicle's DLC.
- Turn the ignition off and wait for about 10 seconds. Turn the ignition back to on and continue the testing.
- Verify the control module is not defective.

### **Operating Error**

If the scan tool freezes, then an exception occurs or the vehicle's ECU (Electronic Control Unit) is too slow to respond to requests.

You need to do the following to reset the tool:

Reset the scan tool.

- Turn the ignition off and wait for about 10 seconds.  
Turn the ignition back to on and continue the testing.

### **Scan tool doesn't power up**

If the scan tool won't power up or operates incorrectly in any other way, you need to do the following to check up:

- Check if the scan tool's connector is securely connected to the vehicle's DLC;
- Check if the DLC pins are bent or broken. Clean the DLC pins if necessary.
- Check vehicle battery to make sure it is still good with at least 8.0 volts.

## 4. Diagnostic operations

### 4.1 Start a New Test

Before using the scan tool to diagnose, you must connect the scan tool to the vehicle with the OBDII connector and the main cable.

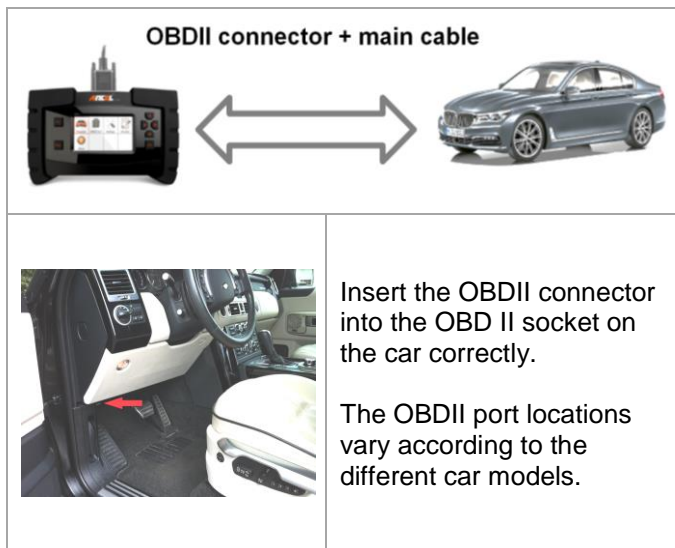

Follow the steps to begin the diagnostics.









- 1) Turn on the scan tool and wait for the **Main Screen**.
- 2) Select **Diagnose** in the **Main Screen**.

 Diagnose	 OBDII V3.0	 Settings	 Favorite
 About			

3) Select **EUROPEAN** as below:

 AMERICAN	 ASIAN	 EUROPEAN	
---	--	---	--

4) Select **BMW** for testing (Taking **BMW** as an example):

 ALFA-ROMEO	 AUDI	 BENZ	 BMW
 CITROEN	 VOLKSWAGEN	 FIAT	 FORD



5) The page pops out, select item **[1] 1 Series** as below:

<b>Diagnosis</b>	
[1]	1 Series
[2]	2 Series
[3]	3 Series
[4]	4 Series
[5]	5 Series
[6]	6 Series
[7]	7 Series

6) Press **OK**, the following page will be displayed:

<b>1 Series</b>	
[1]	E87 / E88
[2]	F20 / F21

## 4.2 Start a Quick Test

7) The page will be displayed as below:

E87 / E88	
[1]	Quick test
[2]	Drive
[3]	Chassis
[4]	Body
[5]	Service functions

**NOTE:**

The **Quick test** on the first line supporting all system listed in *Drive, Chassis and Body*.

8) Press **OK** to confirm the selection **[1] Quick test**, and then the below page will be displayed:

Information	
Do you want to start the quick test?	
<input checked="" type="button" value="Yes"/>	<input type="button" value="No"/>

9) Press **OK** to select **Yes** for starting the quick test.  
It will take several seconds to actuate the short test.

<b>Information</b>	
Short test have been finished!	
<div style="background-color: #cccccc; padding: 5px; display: inline-block;">Press OK key to continue!</div>	

**NOTE:**

- ⊕ Press **Right** to select **NO** and cancel the quick test.
- ⊕ Press **Esc** to stop the operation during the quick test.

10) Press **OK**, the below page will be displayed:

<b>Short test</b>	
[1]	View Faults in control unit
[2]	View quick test result
[3]	Quick delete

**NOTE:**

**Up/Down:** To view items on current page one by one

**Left/Right:** To view items on next and previous page

11) Press **OK**, the below page will be displayed:

<b>Short test</b>	
DME/DDE (Motor/Diesel Electronics)	1F
29CC	DME: Misfire, several cylinders
EKPS Fuel-pump control	3F
50	Ignition, cylinder 3
67	Knock sensor 4

**NOTE:**

- ⊗ The scan tool will display all control units with this item selection.
- ⊗ **Up/Down:** To view items on current page one by one
- ⊗ **Left/Right:** To view items on next and previous page

12) Press **Down** to select the item **[2] View quick test result** from the list below:

<b>Short test</b>	
[1]	View Faults in control unit
[2]	View quick test result
[3]	Quick delete

13) Press **OK**, the below page will be displayed:

<b>Short test</b>	
CAS Car Access System	No fault code!
EGS transmission control	No fault code!
DME/DDE (Motor/Diesel Electronics)	1F
EKPS Fuel-pump control system	3F
AL active steering	No fault code!
ARS Dynamic Drive 2	No fault code!

**NOTE:**

- ⊗ The scan tool will display all quick test results with this item selection.
- ⊗ **Up/Down:** To view items on current page one by one
- ⊗ **Left/Right:** To view items on next and previous page

14) Press **Down** to select **[3] Quick delete** from the list:

<b>Short test</b>	
[1]	View Faults in control unit
[2]	View quick test result
[3]	Quick delete

15) Press **OK**, the below page will be displayed:

<b>Quick delete</b>	
[1]	Clear fault in control unit
[2]	Clear faults of all control unit

**NOTE:**

- ⊛ **Up/Down:** To view items on current page one by one
- ⊛ **Left/Right:** To view items on next and previous page

16) Press **OK** to confirm the first choice **[1] Clear fault in control unit**. The following information will be displayed:

<b>Information</b>
Quick delete is successfully finished!
Press OK key to continue!

17) After pressing **OK**, the page will be displayed:

<b>Short test</b>	
CAS Car Access System	No fault code!
EGS transmission control	No fault code!
DME/DDE (Motor/Diesel Electronics)	1F
EKPS Fuel-pump control system	3F
AL active steering	No fault code!
ARS Dynamic Drive 2	No fault code!

**NOTE:**

- ⊗ **Up/Down:** To view items on current page one by one
- ⊗ **Left/Right:** To view items on next and previous page
- ⊗ **Esc:** Back to previous menu

### 4.3 Read Identification

18) After pressing **OK**, the below page will be displayed

<b>CAS Car Access System</b>	
[1]	Identification
[2]	Read fault memory
[3]	Clear fault memory
[4]	Diagnosis request

19) Press **OK** to confirm the first choice **[1] Identification**.  
The following information will be displayed:

Identification	
CAS Car Access System	
Physical hardware number	8353731
BMW Part number	8353731
Coding index	48
Date of manufacture (DD.MM.YYYY)	30.07.2015
Diagnosis index	12611

**NOTE:**

- ★ **Up/Down:** To view items on current page one by one
- ★ **Left/Right:** To view items on next and previous page
- ★ **Esc/Enter:** Back to previous menu

## 4.4 Read fault memory / Read DTC

20) Press **Down** to select the item **[2] Read fault memory** from the list below:

CAS Car Access System	
[1]	Identification
[2]	Read fault memory
[3]	Clear fault memory
[4]	Diagnosis request



21) After pressing **OK**, the below page will be displayed

<b>Information</b>	
No fault code!	
<div style="background-color: #cccccc; padding: 5px; display: inline-block;">Press OK key to continue!</div>	

**NOTE:**

⊙ **Enter:** *Back to previous menu*

## 4.5 Clear fault memory / Clear DTC

22) After pressing **OK**, the scan tool will be back to previous menu shown as below, and select the item **[3]**

**Clear fault memory:**

<b>CAS Car Access System</b>	
[1]	Identification
[2]	Read fault memory
[3]	Clear fault memory
[4]	Diagnosis request

23) The following page will be displayed as below

Information	
Do you want to carry out this function?	
<input checked="" type="button" value="Yes"/>	<input type="button" value="No"/>

**NOTE:**

⊗ **Press *Right* to select **NO** and cancel the quick test.**

24) Press **OK** to select **Yes** and delete fault memory.

Information
Erase fault code(s) successfully!
<input checked="" type="button" value="Press OK key to continue!"/>

**NOTE:**

⊗ **Enter: Back to previous menu**

## 4.6 Read live data / DataStream

25) After pressing **OK**, the scan tool will be back to previous menu shown as below, and select the item **[4]**

**Diagnosis request:**

Diagnosis request	
[1]	Programming
[2]	Internal Hall sensors
[3]	Inputs
[4]	Terminals
[5]	Remote control
[6]	Key
[7]	Remote control battery status

28) Press **Down** to select **[4] Terminals** from the list:

Diagnosis request	
[1]	Programming
[2]	Internal Hall sensors
[3]	Inputs
[4]	Terminals
[5]	Remote control
[6]	Key
[7]	Remote control battery status

29) After pressing **OK**, the page will be displayed:

<b>Diagnosis request</b>		
<input type="checkbox"/>	[1]	Terminal 30E
<input type="checkbox"/>	[2]	Terminal 30L
<input type="checkbox"/>	[3]	Terminal 15-1
<input type="checkbox"/>	[4]	Terminal 15-2
<input type="checkbox"/>	[5]	Terminal 15-3
<input type="checkbox"/>	[6]	Terminal 15-4
<input type="checkbox"/>	[7]	Terminal 15, Wake Up (PT CAN)

30) Press **Left** and **Right** to view next or previous pages.

<b>Diagnosis request</b>		
<input type="checkbox"/>	[8]	Terminal 15, Wake Up (ACC)
<input type="checkbox"/>	[9]	Voltage, terminal 50E
<input type="checkbox"/>	[10]	Current, terminal 50L
<input type="checkbox"/>		
<input type="checkbox"/>		
<input type="checkbox"/>		
<input type="checkbox"/>		

31) Press **OK** to select all items listed.

<b>Diagnosis request</b>			
<input type="checkbox"/>	[1]	Terminal 30E	16.65 (V)
<input type="checkbox"/>	[2]	Terminal 30L	16.65 (V)
<input type="checkbox"/>	[3]	Terminal 15-1	16.65 (V)
<input type="checkbox"/>	[4]	Terminal 15-2	16.65 (V)
<input type="checkbox"/>	[5]	Terminal 15-3	16.65 (V)
<input type="checkbox"/>	[6]	Terminal 15-4	16.65 (V)
<input type="checkbox"/>	[7]	Terminal 15, Wake Up (PT CAN)	16.65 (V)

32) Press **Fn** to select items requested.

<b>Diagnosis request</b>			
<input type="checkbox"/>	[1]	Terminal 30E	
<input type="checkbox"/>	[2]	Terminal 30L	
<input checked="" type="checkbox"/>	[3]	Terminal 15-1	
<input type="checkbox"/>	[4]	Terminal 15-2	
<input checked="" type="checkbox"/>	[5]	Terminal 15-3	
<input type="checkbox"/>	[6]	Terminal 15-4	
<input type="checkbox"/>	[7]	Terminal 15, Wake Up (PT CAN)	

**NOTE: The scan tool will display live data in graphic.**

33) Press **Down** to select **[5] Service functions**:

E87 / E88	
[1]	Quick test
[2]	Drive
[3]	Chassis
[4]	Body
[5]	Service functions

**NOTE:**

**ANCEL FX Series scan tool provides other system available, such as Drive, Chassis, Body, ABS,Airbag, EPB, AC,ACS(esp) etc.**

## 5. Software Update

This function always you to update the scan tool software through a computer

### 5.1 Register the scan tool

User would update the scan tool ONLY after you have registered the tool on ANCEL website: [www.anceldirect.com](http://www.anceldirect.com) Then you could download software, update online retrieve information and get warranty services.

**NOTE: Prior to registration, please confirm your network is working properly.**

## 5.2 Software Update Flow Chart

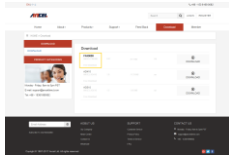

1 Visit ANCEL website as below  
[www.anceldirect.com/download.html](http://www.anceldirect.com/download.html)



2 Download Update Client  
 and then following the  
 instructions



3 Input details for online registration  
 and submit the form. Keep in mind  
 the user information and download  
 latest software



4 Connect PC and the main  
 unit with USB cable before  
 software updating



The screenshot shows the ANCEL software update interface. It lists three software versions for download:

Model	Version	Size	Action
ALFA	ALFA 1.1 2017-02-21	2.41 MB	Download
AMFORD	AMFORD 1.1 2017-02-17	2.44 MB	Download
AUDI	AUDI 1.12 2017-02-17	5.37 MB	Download

Callouts in the image point to the 'Download' button for the first item, the 'Update Selected' button, and the 'Update All' button. A note also points to the 'Click the button to display all history version' link.

## **6. Warranty and Service**

### **6.1 Limited One Year Warranty**

Subject to the conditions of this limited warranty, ANCEL warrants its customer that this product is free of defects in material and workmanship at the time of its original purchase for a subsequent period of one year.

In the event this product fails to operate under normal use, during the warranty period, due to defects in materials and workmanship, ANCEL will, at its sole option, either repair or replace the product in accordance with the terms and conditions stipulated herein.

#### **Terms and Conditions**

1. If ANCEL repairs or replaces the product, the repaired or replaced product shall be warranted for the remaining time of the original warranty period. No charge will be made to the customer for replacement parts or labor charges incurred by ANCEL in repairing or replacing the defective parts.
2. The customer shall have no coverage or benefits under this limited warranty if any of the following conditions are applicable:
  - a) The product has been subjected to abnormal use, abnormal conditions, improper storage, exposure to moisture or dampness, unauthorized modifications, unauthorized repair, misuse, neglect, abuse, accident, alteration, improper installation, or other acts which are not the fault of ANCEL, including damage caused by shipping.
3. The customer shall bear the cost of shipping the product to ANCEL. And ANCEL shall bear the cost of shipping the product back to the customer after the completion of service under this limited warranty.



4. ANCEL does not warrant uninterrupted or error-free operation of the product. If a problem develops during the limited warranty period, the consumer shall take the following step-by-step procedure:
  - a) The customer shall return the product to the place of purchase for repair or replacement processing, contact your local ANCEL distributor or visit our website [www.anceldirect.com](http://www.anceldirect.com) to get further info
  - b) The customer shall include a return address, daytime phone number and/or fax number, complete description of the problem and original invoice specifying date of purchase and serial number.
  - c) The customer will be billed for any parts or labor charges not covered by this limited warranty.
  - d) ANCEL will repair the Product under the limited warranty within 30 days after receipt of the product. If ANCEL cannot perform repairs covered under this limited warranty within 30 days, or after a reasonable number of attempts to repair the same defect, ANCEL at its option, will provide a replacement product or refund the purchase price of the product less a reasonable amount for usage.
  - e) If the product is returned during the limited warranty period, but the problem with the product is not covered under the terms and conditions of this limited warranty, the customer will be notified and given an estimate of the charges the customer must pay to have the product repaired, with all shipping charges billed to the customer. If the estimate is refused, the product will be returned freight collect. If the product is returned after the expiration of the limited warranty period, ANCEL normal service policies shall apply and the customer will be responsible for all shipping charges.

5. Any implied warranty of merchantability, or fitness for a particular purpose or use, shall be limited to the duration of the foregoing limited written warranty. Otherwise, the foregoing limited warranty is the consumer's sole and exclusive remedy and is in lieu of all other warranties, express or implied. ANCEL shall not be liable for special, incidental, punitive or consequential damages, including but not limited

## 6.2 Service Procedures

If you have any questions, please contact your local store, distributor or visit our website at [www.anceldirect.com](http://www.anceldirect.com). If it becomes necessary to return the scan tool for repair, contact your local distributor for more information.

## FAQ (Frequency Ask Questions)

### Why the Vehicle Linking Error?

A communication error occurs if the scan tool fails to communicate with the vehicle's ECU (Electronic Control Unit)

#### Answer:

Verify that the ignition is ON.

Check if the scan tool's connector is securely connected to the vehicle's DLC.

Turn the ignition off and wait for about 10 seconds and turn the ignition back to ON and continue the testing.

Verify the control module is not defective

### **Why the Operating Error?**

If the scan tool freezes, then an exception occurs or the vehicle's ECU is too slow to respond the requests.

#### **Answer:**

Reset the scan tool first and turn the ignition off and wait for about 10 seconds and turn the ignition back to ON and continue the testing.

### **Why the Scan Tool Doesn't Power Up?**

If the scan tool won't power up or operates incorrectly in any other way.

#### **Answer:**

Check if the scan tool's connector is securely connected to the vehicle's DLC

Check if the DLC pins are bent or broken. Clean the DLC pins if necessary.

Check vehicle battery to make sure it is still good with at least 8.0 V

### **Why Cannot Install the FX Series Update Client Correctly?**

After installing the FX Update Client software, the system won't accept the serial number for the FX machines.

#### **Answer:**

You need to connect the PC and the FX machines with the USB cable before software download

**OBDSpace TECHNOLOGY CO ., LTD**

Runfeng office longhua district Shenzhen

GuangDong 518000 P.R China

TEL: 0755-81751202

E-Mail: [sales@anceldirect.com](mailto:sales@anceldirect.com)

Website: [www.anceldirect.com](http://www.anceldirect.com)