

G_Series

Gas Ring Blowers
US Edition

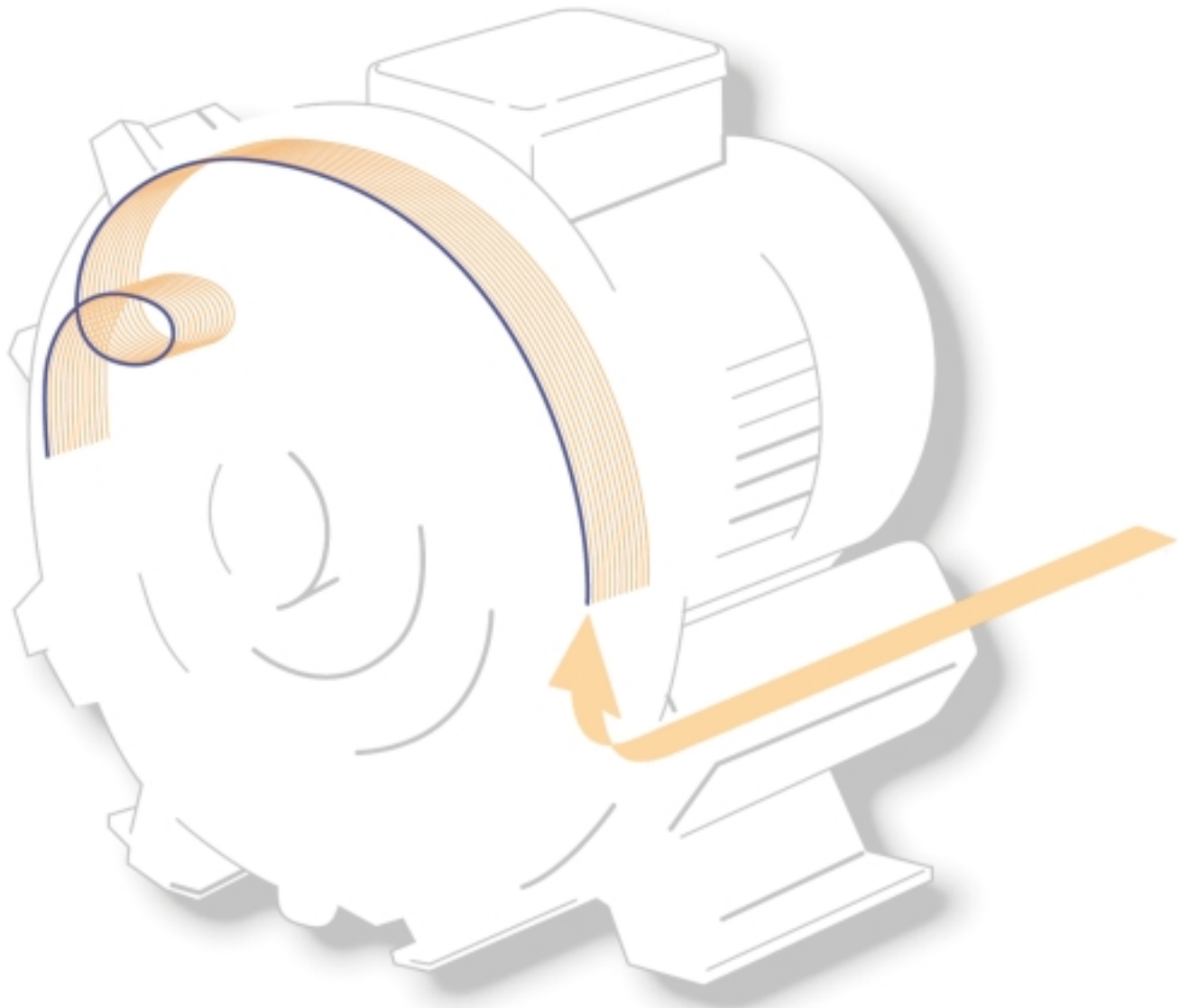

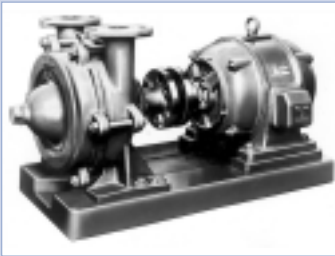
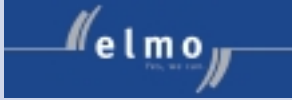

In May 2002 the Nash Engineering Company, USA, and elmo vacuum technology GmbH, Germany, formerly a Siemens subsidiary, merged to create a global leader in vacuum technology.

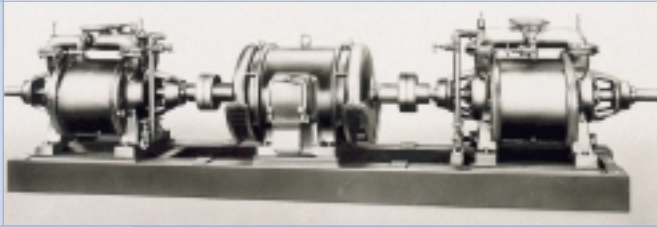

Headquartered in Connecticut, the company has manufacturing sites in the US, Brazil, Germany and China. A global network of sales and service centers makes sure that nash_elmo is nearby when our customers need us.



Let's do it. Together.

G_Series Gas ring blowers and compressors

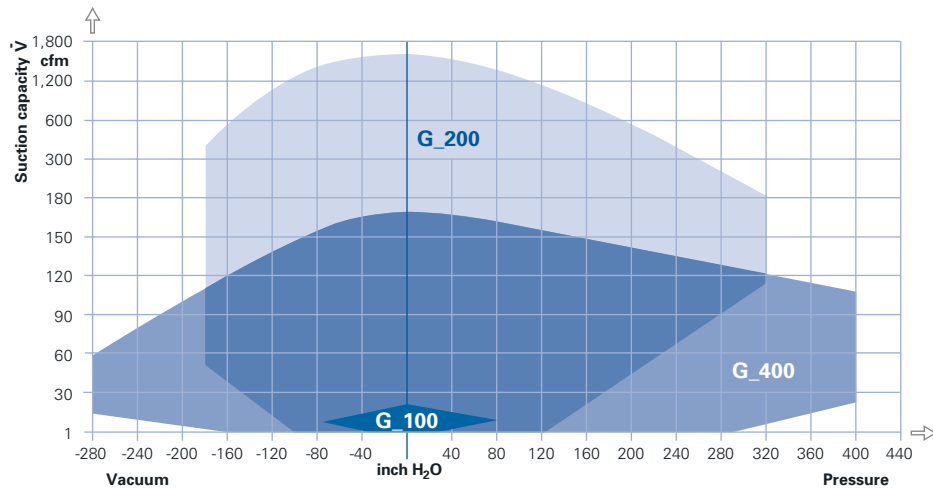

Some technologies are so good that it's hard to improve them. Gas ring blowers from nash_elmo are such an example. They've proven their reliability in service for many decades, performing flawlessly day in and day out with virtually no down time. Existing noise levels have been lower than that of most other vacuum pumps and compressors.

G_Series pumps and compressors are used for conveying gases and gas-air mixtures.

Main features:

- Low noise level
- Low Maintenance
- Reliable and built-to-last
- Robust yet light-weight
- Can be installed in any axial orientation
- Wide performance range
- For use worldwide (UL/CSA/IEC/EN approval)
- 50/60 Hz voltage range motors
- ATEX 94/9 EG

Contents

Series overview	4 - 5
Selection and ordering information	
G_100	6 - 9
G_200	10 - 19
G_200e (with frequency converter)	20 - 25
G_400	26 - 29
G_400e (with frequency converter)	30 - 33
Accessories – selection and ordering information	34 - 43
Dimensions – gas ring compressors	44 - 58
Dimensions – accessories	59 - 63
Annex	
Application examples	66 - 75
Conversion tables	76
Physical basics for blower applications	77 - 78
General safety information	79 - 80
Quality	81
ATEX	82
Footnotes and Voltage Overview	83

G_Series Gas ring blowers and compressors

Applications

- Pneumatic conveying systems
- Lifting and holding of parts by vacuum
- Packaging machines
- Aeration of sewage-treatment plants
- Filling of bags/bottles/hoppers
- Soil remediation
- Thermoforming
- Sorting/enveloping of letters
- Food-processing
- Laser printers
- Dental suction equipment
- Paper processing
- Printers/copiers
- Textile machines
- Aeration of fish ponds
- Gas analysis
- Swimming-pool equipment/whirlpools

G_100

Driven via an electronically commutated, permanent-field DC motor. Infinitely variable over the entire power range.



G_200

Single-stage version.



G_200

Two-stage, for tougher requirements.



G_200e

With integrated frequency converter for high volume flows and/or automatic modification to changing loads.



G_400

Single-stage, for high pressure ranges.



G_400

Multi-stage, reliability for high differential pressures



G_400e

With integrated frequency converter.



G_200e and G_400e also available with external frequency converter

The G_Series vacuum pumps and compressors are available in a wide selection for performance ranges up to 1,770 cfm and differential pressures of up to 400 inch H₂O. They cover the most varied requirements flexibly and powerfully. If frequency converters are used, any operating point can be precisely selected, maintained and controlled. These converters can be integrated into the machine but are also available as stand-alone models.

Ex stock for use world-wide

The G_Series pumps and compressors feature voltage range motors for 50 and 60 Hz in protection class IP 55 (insulation class F) and are UL 507 and CSA 22.2. No. 113 approved. This makes them the ideal solution for world-wide use: they can be used without modifications or tests in Europe, Asia and America. They are mostly available ex stock.

Large range of accessories

nash-elmo offers a large range of accessories for our G_series that are ideally suited for these machines.

A special sound protection hood was designed for noise sensitive environments such as schools, living quarters, hospitals and production facilities. They can be installed outside, are maintenance-free and easy to transport.

An additional rigid silencer is now available for the G_200 that will reduce the noise level even further.

G_Series – operating principle

The impellers in the G_Series machines are mounted directly on the motor shaft for non-contact compression entirely without friction. Maximum operational reliability, even at high differential pressures, is ensured by the arrangement of the bearings outside the compression chamber.

The gas is taken in through the inlet **1**. As it enters the side channel **2**, the rotating impeller **3** imparts velocity to the gas in the direction of rotation.

Centrifugal force in the impeller blades accelerates the gas outward and the pressure increases. Every rotation adds kinetic energy, resulting in further increase of pressure along the side channel.

The side channel narrows at the rotor, sweeping the gas off the impeller blades and discharging it through the outlet silencer **4** where it exits the pump.

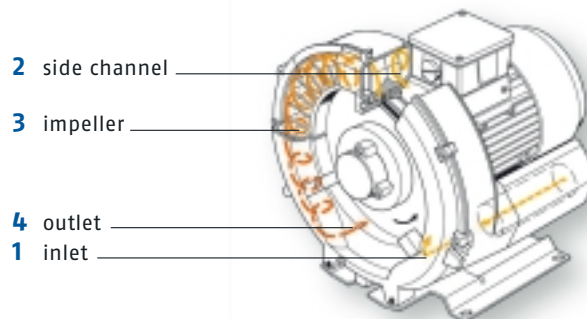

G_100

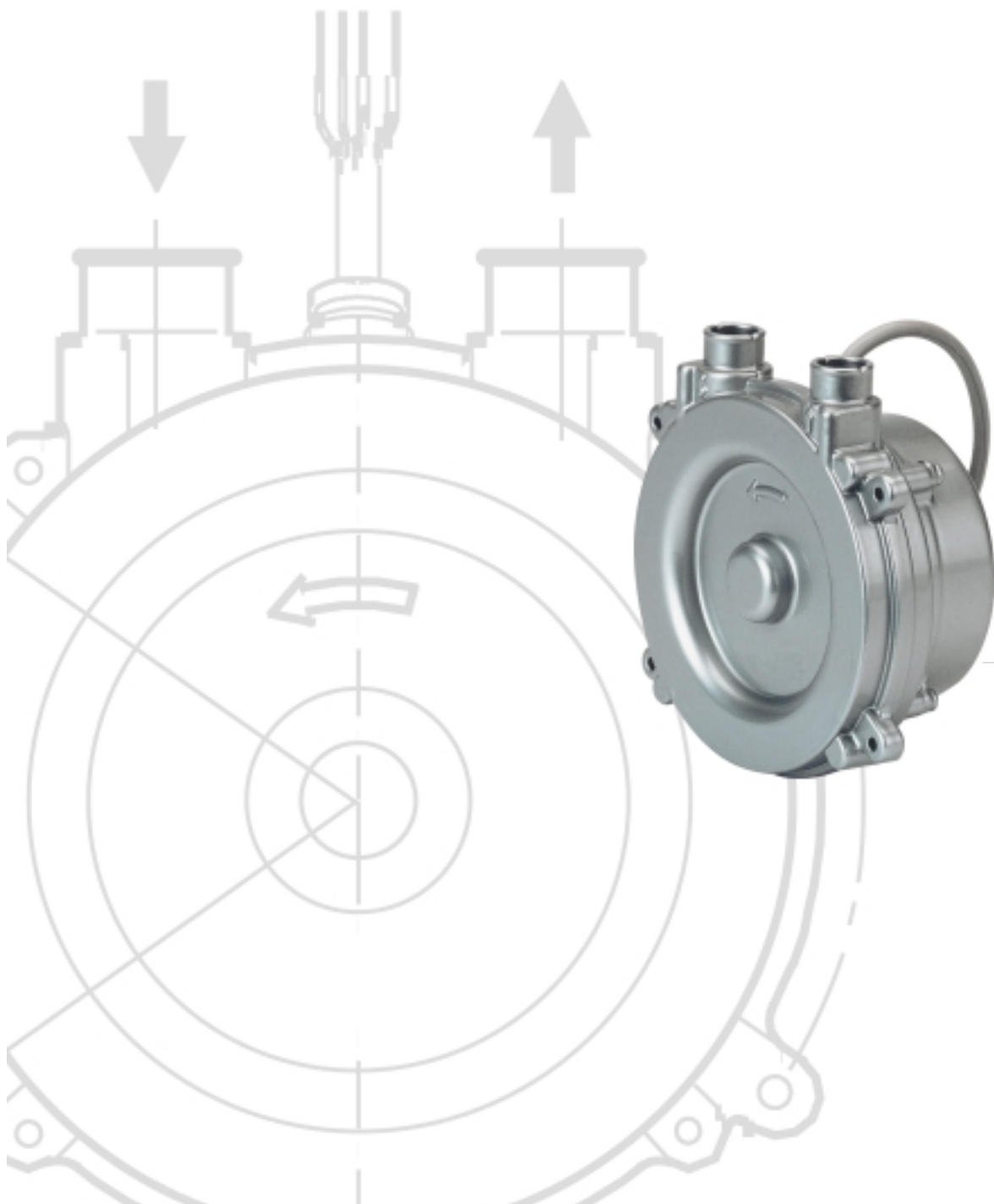

G_100

The smallest gas ring blower on the market

With a height and width of approx. 5 inches and a depth of approx. 2.4 inches, the G_100 blowers have the size of a CD and are the smallest gas ring vacuum blowers available on the market. Furthermore, the adjustable volume flow of the machines ensures that only the exact performance required is actually being supplied – not more.

These blowers are employed primarily in fine mechanical and medical technology applications. With their robust and built-to-last design, they are also used in other industries such as mechanical engineering.

The G_100 is driven via an electronically commuted DC motor. This guarantees a high level of efficiency and maintenance-free operation for more than 20,000 operating hours. The operating electronics are a standard feature of the machines which allow infinitely variable control of speed and output of the blower.

**Selection diagram, ordering information,
accessories, dimensions**

pages 8 – 9



The performance curves are valid for pumping air at 60 °F (15 °C) at the inlet flanges with an air pressure of 29,9 in Hg abs. (1,013 mbar) and a tolerance of ±10%. The total pressure differences are valid up to an intake and ambient temperature of 77 °F (25 °C).

Vacuum-compressor selection diagram

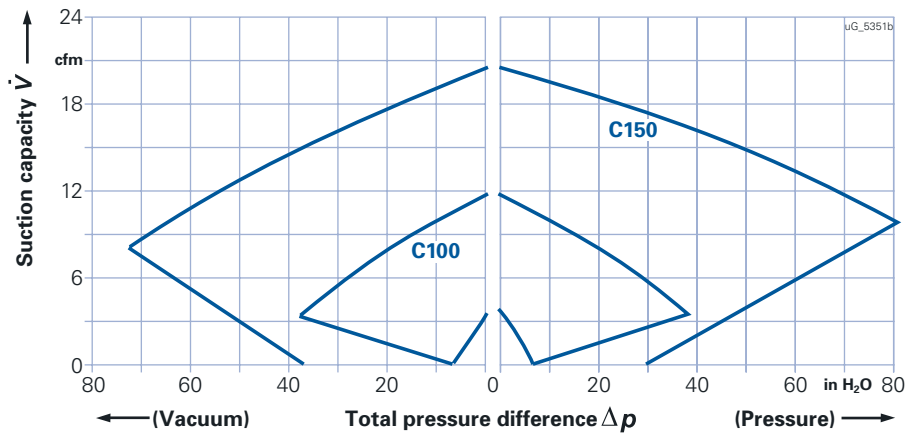

Selection and ordering information

Curve no.	Control voltage (0...10 V DC)	Order no.	output	Rated voltage	current	Max. differential vacuum pump in H ₂ O	com- pressor in H ₂ O	Sound pressure level ¹⁾ dB(A)	Weight
Speed n min ⁻¹	V		hp	V	A				lbs
IP66, with hood and integrated electronics									
C100		2BH1 000-0AB32	0.12	24 DC	4.5	–	–	48	2.2
n _{max.}	10					36.9	35.7		
7000	7.15 ± 0.1					32.5	35.3		
6000	6.1 ± 0.1					27.3	28.9		
5000	5.1 ± 0.1					20.9	22.1		
4000	4.05 ± 0.1					13.6	14.5		
3000	3.05 ± 0.1					8.0	8.4		
IP 66, with external electronics									
C150		2BH1 000-0AA53²⁾	0.38	48 DC	8	72.3	80.3	50	2.6

Variant "without hood" available on request.

1) Measuring-surface sound-pressure level acc. to EN 21680-1, measured at 1 m distance with closed suction and pressure side at 7,400 min⁻¹.

Tolerance: ± 3 dB(A).

2) External operating electronics compulsory

Accessories for 2BH100

	Delivery loose Order no.	Delivery with the pump abbreviation ¹⁾	Weight approx. lbs
External electronics (Variotronic) ²⁾ , loose	2BX4 130	B30	0.44
Set of plugs ³⁾ , loose , eight-pole, for connecting motor Variotronic, comprising: 1 x socket casing, 3 x socket contact AWG 20 5 x socket contact AWG 26, 2 x 1 each spare contact	2BX4 131	B20	–
Suction filter	2BX4 134	B36	0.66
Silencer	2BX4 135	B37	0.22
Rubber buffer (1 set = 4 pieces) (rubber metal bearing)	2BX4 132	B31	–

1) Please add a „-Z“ to the order number and add the abbreviation as follows: Example 2BH1 000-0AB32-Z

B30 + B31

2) With ambient temperatures over 25°C the operating speed may be less depending on the cooling of the electronics system.

3) Note: Pliers for the socket contacts are not included with delivery; obtainable from Molex Deutschland/Heilbronn; Germany
Fax +49 (0) 70 66 / 95 55 29; Type 69008-0274.

Dimensions for 2BH100 (inch)

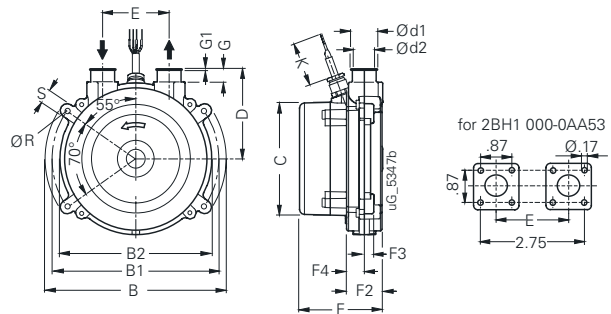

Type	B	B1	B2	C	D	Ø d1	Ø d2	E	F	F2	F3	F4	G	G1	K	Ø R	S
2BH1 000-0AB32	5.7	5.2	4.8	3.5	2.8	0.8	0.7	2.1	2.6	1.1	0.3	0.6	0.4	0.04	17.7	0.2	0.4
2BH1 000-0AA53	3.7	2.4		3.6													

Dimensional drawings are also available as .dxf files on request.

Dimensions of accessories for 2BH100 (inch)

External electronics (Variotronic)

2BX4 130

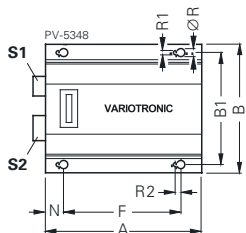

S1 Control signal

S2 Motor connection

Rubber buffer

2BX4 132

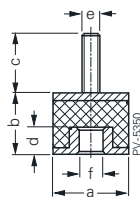

Set of plugs

2BX4 131

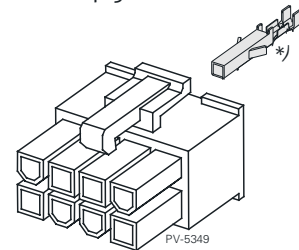

Order no.	A	B	B1	F	N	Ø R	R1	R2
2BX4 130	4.41	3.62	3.15	3.31	0.51	0.26	0.12	0.22
Order no.	a	b	c	d	e	f		
2BX4 132	Ø0.39	0.39	0.39	0.16	M 4	M 4		

*) 2BX4 131: Pliers not included in scope of order

G_200



G_200 single
and multi-stage



G_200e with integrated or external
frequency converter

G_200

Classics with innovative technology

With their high inlet volume flow (up to 1,470 cfm) and a differential pressure of up to 313 inch H₂O, our low noise G_series allrounders have earned their reputation and convinced thousands of customers all over the world.

They are reliable, low-maintenance and durable and are the first choice for many applications in mechanical engineering.

When used with a frequency converter the performance of the G_200 pumps and compressors can be increased considerably.

The G_200 machines are UL/CSA approved and can be used without further testing all over the world.

Available at short notice or ex stock and also as ATEX certified models, the G_200 family is a classic that has proven its innovative quality.

Selection diagrams and tables for G_200, vacuum and compressor mode, 50 and 60 Hz	pages 12 - 19
G_200e, pumps and compressors with speed control and frequency converter	pages 20 - 25
Details on voltages, footnotes etc. see	page 83

G_Series G_200, 50 Hz



The performance curves are valid for pumping air at 60 °F (15 °C) at the inlet flanges with an air pressure of 29,9 in Hg abs. (1,013 mbar) and a tolerance of ±10%. The total pressure differences are valid up to an intake and ambient temperature of 77 °F (25 °C).

Selection diagram, vacuum operation

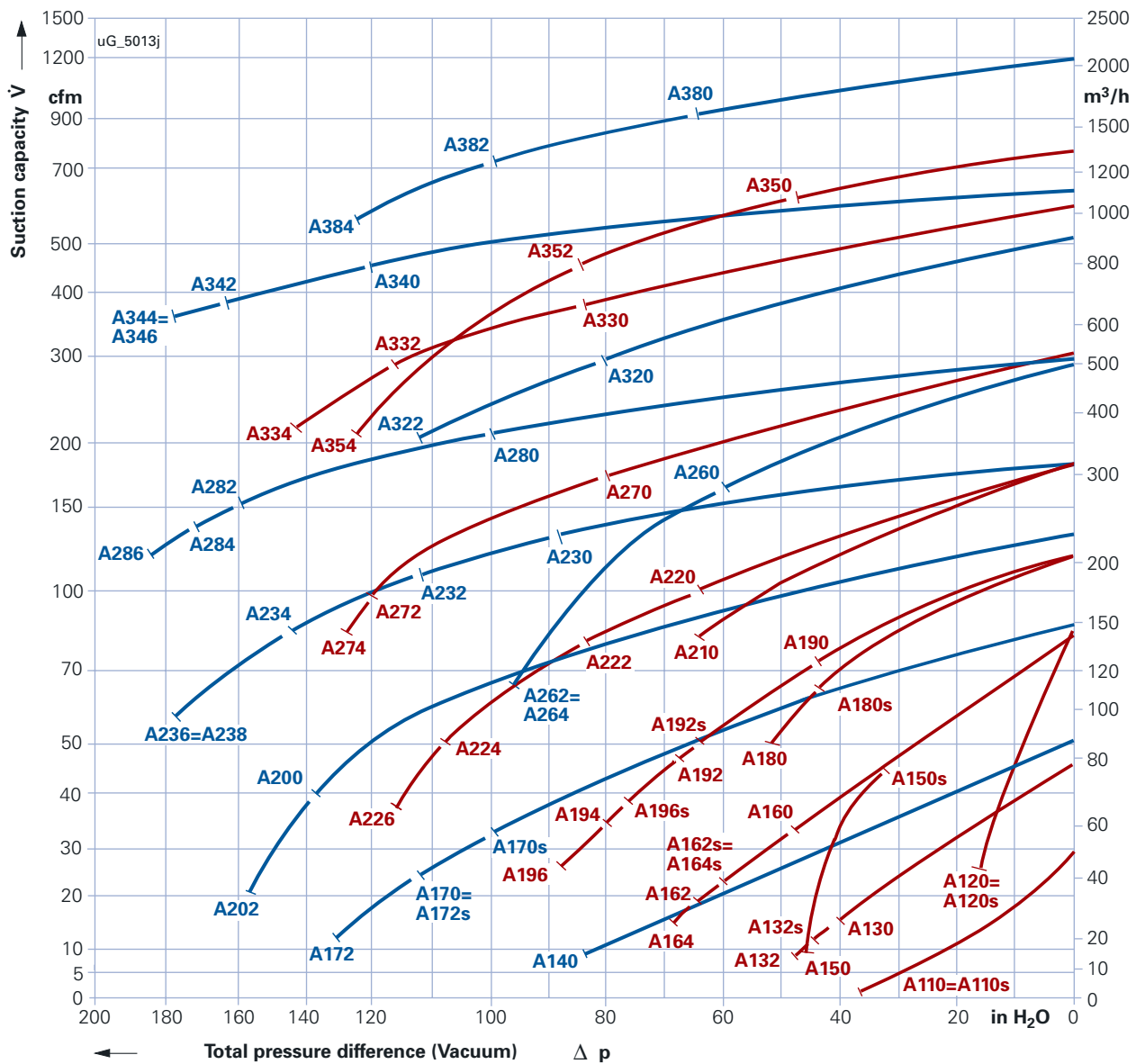

Selection and ordering information for 50 Hz, 3AC, IP55

Curve no.	Motor			Order no.	Weight approx.	Sound pressure level ¹⁾	Vacuum-relief valve ²⁾	Pressure-relief valve ²⁾
	output hp	Rated voltage ⁴⁾ V	current A					
A110	0.27	200-240 Δ / 345-415 Y	2.1 Δ / 1.2 Y	2BH1 100-7A H 0 6	15	50	–	–
A120	0.34	200-240 Δ / 345-415 Y	1.38 Δ / 0.8 Y	2BH1 200-7A H 0 6	18	57	–	–
A130	0.34	200-240 Δ / 345-415 Y	2.1 Δ / 1.2 Y	2BH1 300-7A H 0 6	18	53	1 x 110/141	1 x 111/143
A132	0.54	200-240 Δ / 345-415 Y	2.6 Δ / 1.5 Y	2BH1 300-7A H 1 6	22	53	1 x 110/141	1 x 111/143
A140	1	200-240 Δ / 345-415 Y	3.8 Δ / 2.2 Y	2BH1 310-7H H 2 6	31	55	1 x 110/141	1 x 111/143
A150	0.8	200-240 Δ / 345-415 Y	2.8 Δ / 1.6 Y	2BH1 490-7A H 1 6	31	63	–	–
A160	1	200-240 Δ / 345-415 Y	3.8 Δ / 2.2 Y	2BH1 400-7A H 0 6	29	63	1 x 110/141	1 x 111/143
A162	1.1	200-240 Δ / 345-415 Y	4.2 Δ / 2.4 Y	2BH1 400-7A H 1 6	33	63	1 x 110/141	1 x 111/143
A164	1.7	200-240 Δ / 345-415 Y	6.6 Δ / 3.8 Y	2BH1 400-7A H 2 6	35	63	1 x 110/141	1 x 111/143
A170	2.2	200-240 Δ / 345-415 Y	7.5 Δ / 4.3 Y	2BH1 410-7H H 3 6	53	66	1 x 110/141	1 x 111/143
A172	3	200-240 Δ / 345-415 Y	9.7 Δ / 5.6 Y	2BH1 410-7H H 4 6	60	66	1 x 110/141	1 x 111/143
A180	1.5	200-240 Δ / 345-415 Y	7.5 Δ / 4.3 Y	2BH1 590-7A H 2 6	46	64	–	–
A190	1.1	200-240 Δ / 345-415 Y	4.2 Δ / 2.4 Y	2BH1 500-7A H 0 6	40	64	1 x 110/145	1 x 111/147
A192	1.7	200-240 Δ / 345-415 Y	6.6 Δ / 3.8 Y	2BH1 500-7A H 1 6	44	64	1 x 110/145	1 x 111/147
A194	2.2	200-240 Δ / 345-415 Y	7.5 Δ / 4.3 Y	2BH1 500-7A H 2 6	46	64	1 x 110/145	1 x 111/147
A196	3	200-240 Δ / 345-415 Y	9.7 Δ / 5.6 Y	2BH1 500-7A H 3 6	55	64	1 x 110/145	1 x 111/147
A200	4	200-240 Δ / 345-415 Y	12.5 Δ / 7.2 Y	2BH1 510-7H H 4 6	86	72	1 x 110/145	1 x 111/147
A202	5.4	200-240 Δ / 345-415 Y	17.4 Δ / 10 Y	2BH1 510-7H H 5 6	95	72	1 x 110/145	1 x 111/147
A210	3	200-240 Δ / 345-415 Y	12.5 Δ / 7.2 Y	2BH1 690-7A H 2 6	68	69	–	–
A220	2.2	200-240 Δ / 345-415 Y	8.5 Δ / 4.9 Y	2BH1 600-7A H 0 6	57	69	1 x 110/145	2 x 111/147
A222	3	200-240 Δ / 345-415 Y	10.0 Δ / 5.8 Y	2BH1 600-7A H 1 6	64	69	1 x 110/145	1 x 111/147
A224	3	200-240 Δ / 345-415 Y	12.5 Δ / 7.2 Y	2BH1 600-7A H 2 6	75	69	1 x 110/145	1 x 111/147
A226	5.4	200-240 Δ / 345-415 Y	16.5 Δ / 9.5 Y	2BH1 600-7A H 3 6	93	69	1 x 110/145	1 x 111/147
A230	3	200-240 Δ / 345-415 Y	9.7 Δ / 5.6 Y	2BH1 610-7H H 1 6	93	73	1 x 110/145	1 x 111/147
A232	3	200-240 Δ / 345-415 Y	12.5 Δ / 7.2 Y	2BH1 610-7H H 2 6	104	73	1 x 110/145	1 x 111/147
A234	5.8	200-240 Δ / 345-415 Y	17.3 Δ / 10 Y	2BH1 610-7H H 3 6	117	73	1 x 110/145	1 x 111/147
A236	7.4	200-240 Δ / 345-415 Y	23 Δ / 13.3 Y	2BH1 610-7H H 4 6	154	73	1 x 110/145	1 x 111/147
A238	10	200-240 Δ / 345-415 Y	29 Δ / 16.7 Y	2BH1 610-7H H 5 6	170	73	1 x 110/145	1 x 111/147
A260	5.4	200-240 Δ / 345-415 Y	16.4 Δ / 9.5 Y	2BH1 640-7G H 3 6	117	74	1 x 110/145	3 x 111/147
A262	7.4	200-240 Δ / 345-415 Y	23 Δ / 13.3 Y	2BH1 640-7G H 4 6	161	74	1 x 110/145	2 x 111/147
A264	10	200-240 Δ / 345-415 Y	29 Δ / 16.7 Y	2BH1 640-7G H 5 6	190	74	1 x 110/145	1 x 111/147
A270	5.4	200-240 Δ / 345-415 Y	16.4 Δ / 9.5 Y	2BH1 800-7A H 0 6	247	70	2 x 110	2 x 111
A272	7.4	200-240 Δ / 345-415 Y	23 Δ / 13.3 Y	2BH1 800-7A H 1 6	278	70	1 x 110	1 x 111
A274	10	200-240 Δ / 345-415 Y	29 Δ / 16.7 Y	2BH1 800-7A H 2 6	282	70	1 x 110	1 x 111
A280	7.4	200-240 Δ / 345-415 Y	23 Δ / 13.3 Y	2BH1 810-7H H 1 6	359	74	1 x 110	2 x 111
A282	10	200-240 Δ / 345-415 Y	29 Δ / 16.7 Y	2BH1 810-7H H 2 6	373	74	1 x 110	2 x 111
A284	14.8	200-240 Δ / 345-415 Y	48.5 Δ / 28 Y	2BH1 810-7H H 3 6	452	74	1 x 110	1 x 111
A286	20.1	200-240 Δ / 345-415 Y	56.5 Δ / 32.5 Y	2BH1 810-7H H 4 6	487	74	1 x 110	1 x 111
A320	10	200-240 Δ / 345-415 Y	30.8 Δ / 17.6 Y	2BH1 840-7J H 2 6	353	74	3 x 110	1 x 151
A322	14.8	200-240 Δ / 345-415 Y	48.5 Δ / 28 Y	2BH1 840-7J H 3 6	441	74	2 x 110	2 x 111
A330	11.4	200-240 Δ / 345-415 Y	33 Δ / 19.1 Y	2BH1 900-7A H 0 6	379	74	1 x 150	1 x 151
A332	16.8	200-240 Δ / 345-415 Y	48.5 Δ / 28 Y	2BH1 900-7A H 1 6	421	74	2 x 110	3 x 111
A334	24.8	200-240 Δ / 345-415 Y	64.5 Δ / 37 Y	2BH1 900-7A H 3 6	450	74	2 x 110	2 x 111
A340	16.8	200-240 Δ / 345-415 Y	48.5 Δ / 28 Y	2BH1 910-7H H 1 6	584	74	1 x 150	1 x 151
A342	22.1	200-240 Δ / 345-415 Y	60 Δ / 35 Y	2BH1 910-7H H 2 6	613	74	3 x 110	1 x 151
A344	26.8	200-240 Δ / 345-415 Y	69 Δ / 40 Y	2BH1 910-7H H 3 6	650	74	3 x 110	3 x 111
A346	33.5	200-240 Δ / 345-415 Y	90 Δ / 52 Y	2BH1 910-7H H 4 6	717	74	3 x 110	3 x 111
A350	11.4	200-240 Δ / 345-415 Y	33 Δ / 19.1 Y	2BH1 930-7A H 0 6	384	75	1 x 150	1 x 151
A352	16.7	200-240 Δ / 345-415 Y	48.5 Δ / 28 Y	2BH1 930-7A H 1 6	425	75	1 x 150	1 x 151
A354	24.8	200-240 Δ / 345-415 Y	64.5 Δ / 37 Y	2BH1 930-7A H 3 6	454	75	2 x 110	3 x 111
A380	20.1	200-240 Δ / 345-415 Y	59 Δ / 34 Y	2BH1 943-7G H 2 6 ³⁾	595	75	1 x 152	1 x 153
A382	26.8	200-240 Δ / 345-415 Y	69 Δ / 40 Y	2BH1 943-7G H 3 6 ³⁾	661	75	1 x 152	1 x 153
A384	33.5	200-240 Δ / 345-415 Y	90 Δ / 52 Y	2BH1 943-7G H 4 6 ³⁾	728	75	3 x 110	1 x 153

Selection and ordering information for 50 Hz, 1AC, IP55

A110s	0.27	230	1.5	2BH1 100-7A A 0 1	15	50	–	–
A110s	0.27	115 / 230	2.9 / 1.45	2BH1 100-7A V 0 5	15	50	–	–
A120s	0.34	115 / 230	3.1 / 1.6	2BH1 200-7A V 0 5	18	57	–	–
A132s	0.50	115 / 230	5.4 / 2.7	2BH1 300-7A V 1 5	22	53	1 x 110/141	1 x 111/143
A150s	0.7	230	4.1	2BH1 490-7A A 1 1	31	63	–	–
A162s	1.1	230	5.2	2BH1 400-7A A 1 1	33	63	1 x 110/141	1 x 111/143
A164s	1.5	115 / 230	14.6 / 7.3	2BH1 400-7A V 2 5	35	63	1 x 110/141	1 x 111/143
A170s	2	230	9.1	2BH1 410-7H A 3 1	42	66	1 x 110/141	1 x 111/143
A172s	2	115 / 230	22 / 11	2BH1 410-7H V 4 5	53	66	1 x 110/141	1 x 111/143
A180s	1.6	230	7.9	2BH1 590-7A A 2 1	46	64	–	–
A192s	1.5	230	6.9	2BH1 500-7A A 1 1	44	64	1 x 110/145	1 x 111/147
A196s	2	115 / 230	22 / 11	2BH1 500-7A V 3 5	49	64	1 x 110/145	1 x 111/147

Details on voltages, footnotes etc. see page 83.

The performance curves are valid for pumping air at 60 °F (15 °C) at the inlet flanges with an air pressure of 29,9 in Hg abs. (1,013 mbar) and a tolerance of ±10%. The total pressure differences are valid up to an intake and ambient temperature of 77 °F (25 °C).

Selection diagram, compressor operation

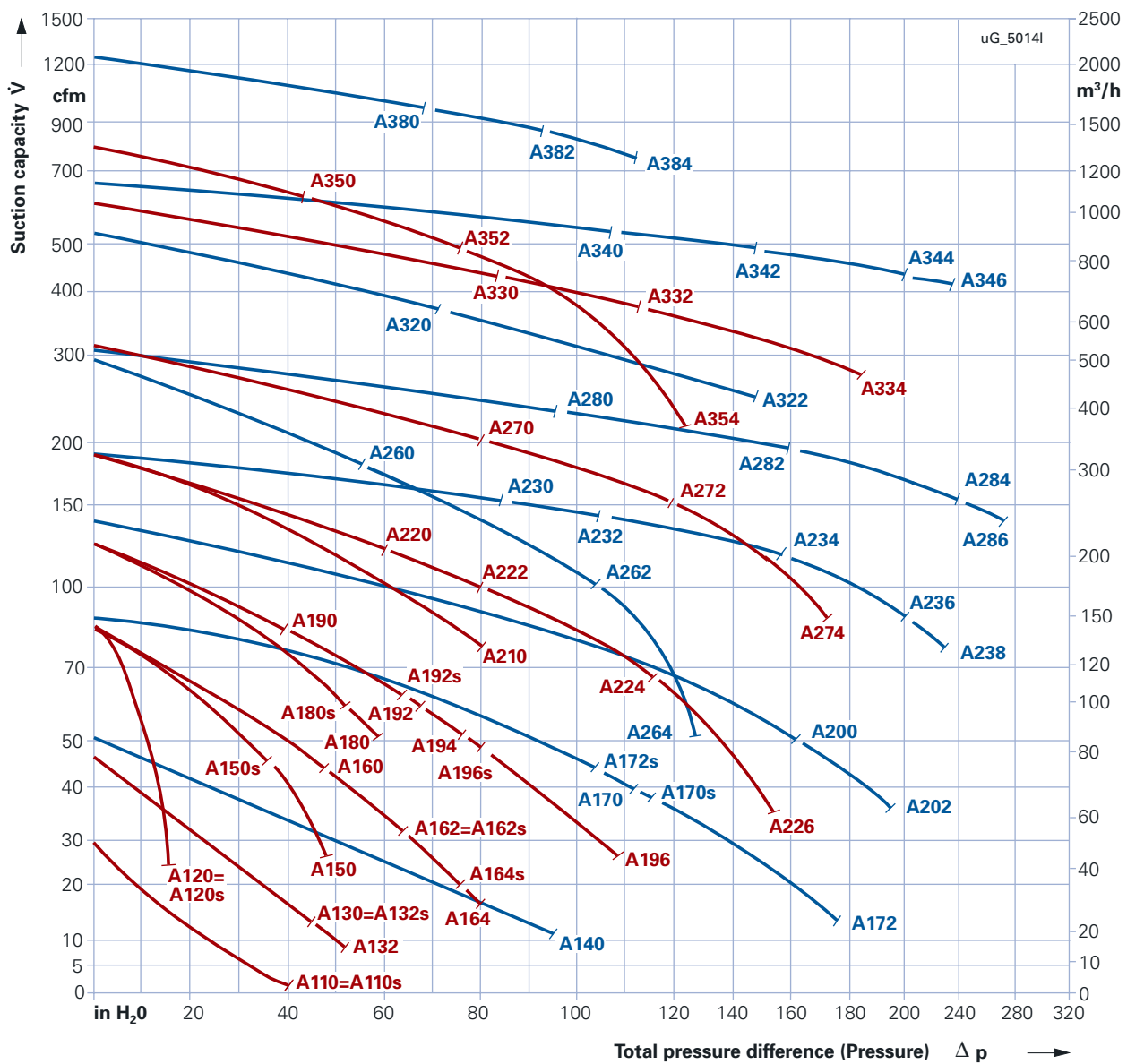

G_Series G_200, 60 Hz



The performance curves are valid for pumping air at 60 °F (15 °C) at the inlet flanges with an air pressure of 29,9 in Hg abs. (1,013 mbar) and a tolerance of ±10%. The total pressure differences are valid up to an intake and ambient temperature of 77 °F (25 °C).

Selection diagram, vacuum operation

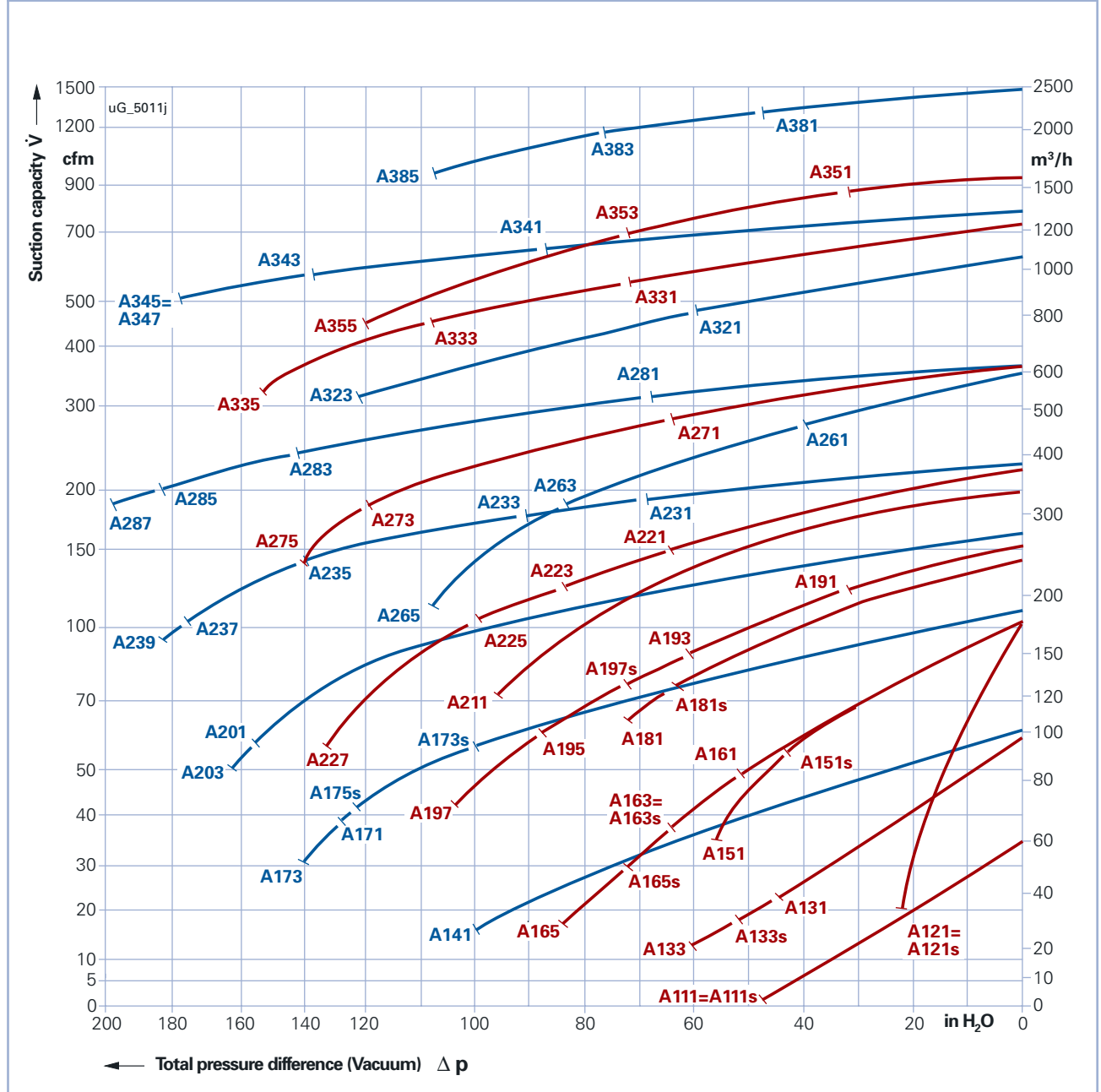

Selection and ordering information for 60 Hz, 3AC, IP55

Curve no.	Motor			Order no.	Weight approx. lbs	Sound pressure level ¹⁾ dB(A)	Vacuum-relief valve ²⁾ Items x type 2BX2...	Pressure-relief valve ²⁾ Items x type 2BX2...
	output hp	Rated voltage ⁴⁾ V	current A					
A111	0.3	220-275 Δ / 380-480 Y	2.0 Δ / 1.2 Y	2BH1 100-7A H 0 6	15	53	–	–
A121	0.4	220-275 Δ / 380-480 Y	1.74 Δ / 1.0 Y	2BH1 200-7A H 0 6	18	61	–	–
A131	0.4	220-275 Δ / 380-480 Y	2.0 Δ / 1.15 Y	2BH1 300-7A H 0 6	18	56	1 x 114/142	1 x 115/144
A133	0.7	220-275 Δ / 380-480 Y	2.6 Δ / 1.5 Y	2BH1 300-7A H 1 6	22	56	1 x 114/142	1 x 115/144
A141	1.1	220-275 Δ / 380-480 Y	3.75 Δ / 2.15 Y	2BH1 310-7H H 2 6	31	61	1 x 114/142	1 x 115/144
A151	1.1	220-275 Δ / 380-480 Y	3.6 Δ / 2.1 Y	2BH1 490-7A H 1 6	31	64	–	–
A161	1.1	220-275 Δ / 380-480 Y	3.75 Δ / 2.15 Y	2BH1 400-7A H 0 6	29	64	1 x 114/142	1 x 115/144
A163	1.3	220-275 Δ / 380-480 Y	4.0 Δ / 2.3 Y	2BH1 400-7A H 1 6	33	64	1 x 114/142	1 x 115/144
A165	2	220-275 Δ / 380-480 Y	6.9 Δ / 4.0 Y	2BH1 400-7A H 2 6	35	64	1 x 114/142	1 x 115/144
A171	2.8	220-275 Δ / 380-480 Y	7.6 Δ / 4.4 Y	2BH1 410-7H H 3 6	53	69	1 x 114/142	1 x 115/144
A173	3.4	220-275 Δ / 380-480 Y	10.0 Δ / 5.8 Y	2BH1 410-7H H 4 6	60	69	1 x 114/142	1 x 115/144
A181	2.3	220-275 Δ / 380-480 Y	7.6 Δ / 4.4 Y	2BH1 590-7A H 2 6	46	70	–	–
A191	1.3	220-275 Δ / 380-480 Y	4.0 Δ / 2.3 Y	2BH1 500-7A H 0 6	40	70	1 x 114/146	2 x 115/148
A193	2	220-275 Δ / 380-480 Y	6.9 Δ / 4.0 Y	2BH1 500-7A H 1 6	44	70	1 x 114/146	1 x 115/148
A195	2.8	220-275 Δ / 380-480 Y	7.6 Δ / 4.4 Y	2BH1 500-7A H 2 6	46	70	1 x 114/146	1 x 115/148
A197	3.4	220-275 Δ / 380-480 Y	10.3 Δ / 6.0 Y	2BH1 500-7A H 3 6	55	70	1 x 114/146	1 x 115/148
A201	4.6	220-275 Δ / 380-480 Y	12.6 Δ / 7.3 Y	2BH1 510-7H H 4 6	86	74	1 x 114/146	1 x 115/148
A203	6.2	220-275 Δ / 380-480 Y	17.2 Δ / 9.9 Y	2BH1 510-7H H 5 6	43	74	1 x 114/146	1 x 115/148
A211	4.6	220-275 Δ / 380-480 Y	12.6 Δ / 7.3 Y	2BH1 690-7A H 2 6	68	72	–	–
A221	2.8	220-275 Δ / 380-480 Y	8.8 Δ / 5.1 Y	2BH1 600-7A H 0 6	57	72	1 x 114/146	2 x 115/148
A223	3.4	220-275 Δ / 380-480 Y	10.3 Δ / 6.5 Y	2BH1 600-7A H 1 6	64	72	1 x 114/146	2 x 115/148
A225	4.6	220-275 Δ / 380-480 Y	12.6 Δ / 7.3 Y	2BH1 600-7A H 2 6	75	72	1 x 114/146	1 x 115/148
A227	6.2	220-275 Δ / 380-480 Y	16.4 Δ / 9.5 Y	2BH1 600-7A H 3 6	42	72	1 x 114/146	1 x 115/148
A231	3.4	220-275 Δ / 380-480 Y	10.3 Δ / 6.0 Y	2BH1 610-7H H 1 6	93	76	2 x 114/146	2 x 115/148
A233	4.6	220-275 Δ / 380-480 Y	12.6 Δ / 7.3 Y	2BH1 610-7H H 2 6	104	76	2 x 114/146	2 x 115/148
A235	6.4	220-275 Δ / 380-480 Y	18 Δ / 10.4 Y	2BH1 610-7H H 3 6	53	76	1 x 114/146	2 x 115/148
A237	8.5	220-275 Δ / 380-480 Y	23 Δ / 13.3 Y	2BH1 610-7H H 4 6	70	76	1 x 114/146	1 x 115/148
A239	11.5	220-275 Δ / 380-480 Y	30 Δ / 17.3 Y	2BH1 610-7H H 5 6	77	76	1 x 114/146	1 x 115/148
A261	6.2	220-275 Δ / 380-480 Y	16.4 Δ / 9.5 Y	2BH1 640-7G H 3 6	53	78	2 x 114/146	3 x 115/148
A263	8.5	220-275 Δ / 380-480 Y	23 Δ / 13.3 Y	2BH1 640-7G H 4 6	73	78	2 x 114/146	3 x 115/148
A265	11.5	220-275 Δ / 380-480 Y	30 Δ / 17.3 Y	2BH1 640-7G H 5 6	86	78	1 x 114/146	2 x 115/148
A271	6.2	220-275 Δ / 380-480 Y	16.4 Δ / 9.5 Y	2BH1 800-7A H 0 6	112	74	2 x 114	2 x 115
A273	8.5	220-275 Δ / 380-480 Y	23 Δ / 13.3 Y	2BH1 800-7A H 1 6	126	74	1 x 114	2 x 115
A275	11.5	220-275 Δ / 380-480 Y	30 Δ / 17.3 Y	2BH1 800-7A H 2 6	128	74	1 x 114	1 x 115
A281	8.5	220-275 Δ / 380-480 Y	23 Δ / 13.3 Y	2BH1 810-7H H 1 6	163	78	3 x 114	3 x 115
A283	11.5	220-275 Δ / 380-480 Y	30 Δ / 17.3 Y	2BH1 810-7H H 2 6	169	78	2 x 114	2 x 115
A285	16.9	220-275 Δ / 380-480 Y	50.2 Δ / 29 Y	2BH1 810-7H H 3 6	205	78	1 x 114	2 x 115
A287	23.2	220-275 Δ / 380-480 Y	60 Δ / 34.5 Y	2BH1 810-7H H 4 6	221	78	1 x 114	1 x 115
A321	11.5	220-275 Δ / 380-480 Y	30.8 Δ / 17.6 Y	2BH1 840-7J H 2 6	160	78	1 x 152	1 x 153
A323	16.9	220-275 Δ / 380-480 Y	50.2 Δ / 29 Y	2BH1 840-7J H 3 6	200	78	3 x 114	1 x 151
A331	13.1	220-275 Δ / 380-480 Y	33 Δ / 19.1 Y	2BH1 900-7A H 0 6	172	79	1 x 152	1 x 153
A333	19.4	220-275 Δ / 380-480 Y	50 Δ / 29 Y	2BH1 900-7A H 1 6	191	79	3 x 114	1 x 151
A335	28.6	220-275 Δ / 380-480 Y	68 Δ / 39 Y	2BH1 900-7A H 3 6	204	79	2 x 114	3 x 115
A341	19.4	220-275 Δ / 380-480 Y	50 Δ / 29 Y	2BH1 910-7H H 1 6	265	84	1 x 152	1 x 153
A343	25.5	220-275 Δ / 380-480 Y	63 Δ / 36.5 Y	2BH1 910-7H H 2 6	278	84	1 x 150	1 x 153
A345	30.8	220-275 Δ / 380-480 Y	72 Δ / 42 Y	2BH1 910-7H H 3 6	295	84	3 x 114	1 x 151
A347	38.9	220-275 Δ / 380-480 Y	90 Δ / 52 Y	2BH1 910-7H H 4 6	325	84	3 x 114	1 x 151
A351	13.1	220-275 Δ / 380-480 Y	33 Δ / 19.1 Y	2BH1 930-7A H 0 6	174	80	1 x 152	1 x 153
A353	19.4	220-275 Δ / 380-480 Y	50 Δ / 29 Y	2BH1 930-7A H 1 6	193	80	1 x 152	1 x 153
A355	28.6	220-275 Δ / 380-480 Y	68 Δ / 39 Y	2BH1 930-7A H 3 6	206	80	1 x 150	1 x 151
A381	23.5	220-275 Δ / 380-480 Y	63 Δ / 36.5 Y	2BH1 943-7G H 2 6 ³⁾	270	84	1 x 154	1 x 155
A383	30.8	220-275 Δ / 380-480 Y	72 Δ / 42 Y	2BH1 943-7G H 3 6 ³⁾	300	84	1 x 152	1 x 155
A385	38.9	220-275 Δ / 380-480 Y	90 Δ / 52 Y	2BH1 943-7G H 4 6 ³⁾	330	84	1 x 152	1 x 153

Selection and ordering information for 60 (50) Hz, 1AC, IP55

A111s	0.3	115 / 230	5.2 / 2.6	2BH1 100-7A V 0 5	15	53	–	–
A121s	0.43	115 / 230	5.7 / 2.9	2BH1 200-7A V 0 5	18	61	–	–
A133s	0.6	115 / 230	6.0 / 3.0	2BH1 300-7A V 1 5	22	56	1 x 114/142	1 x 115/144
A151s	0.83	115	10	2BH1 490-7A B 1 6	31	64	–	–
A163s	1.2	115	11.6	2BH1 400-7A B 1 6	33	64	1 x 114/142	1 x 115/144
A165s	1.7	115 / 230	16.6 / 8.3	2BH1 400-7A V 2 5	35	64	1 x 114/142	1 x 115/144
A173s	2.4	115 / 230	24 / 12	2BH1 410-7H V 4 5	53	69	1 x 114/142	1 x 115/144
A181s	2.4	115	21.5	2BH1 590-7A B 2 6	46	70	–	–
A197s	2.4	115 / 230	24 / 12.0	2BH1 500-7A V 3 5	49	70	1 x 114/146	1 x 115/148

▲ ▲ Details on voltages, footnotes etc. see page 83.

The performance curves are valid for pumping air at 60 °F (15 °C) at the inlet flanges with an air pressure of 29,9 in Hg abs. (1,013 mbar) and a tolerance of ±10%. The total pressure differences are valid up to an intake and ambient temperature of 77 °F (25 °C).

Selection diagram, compressor operation

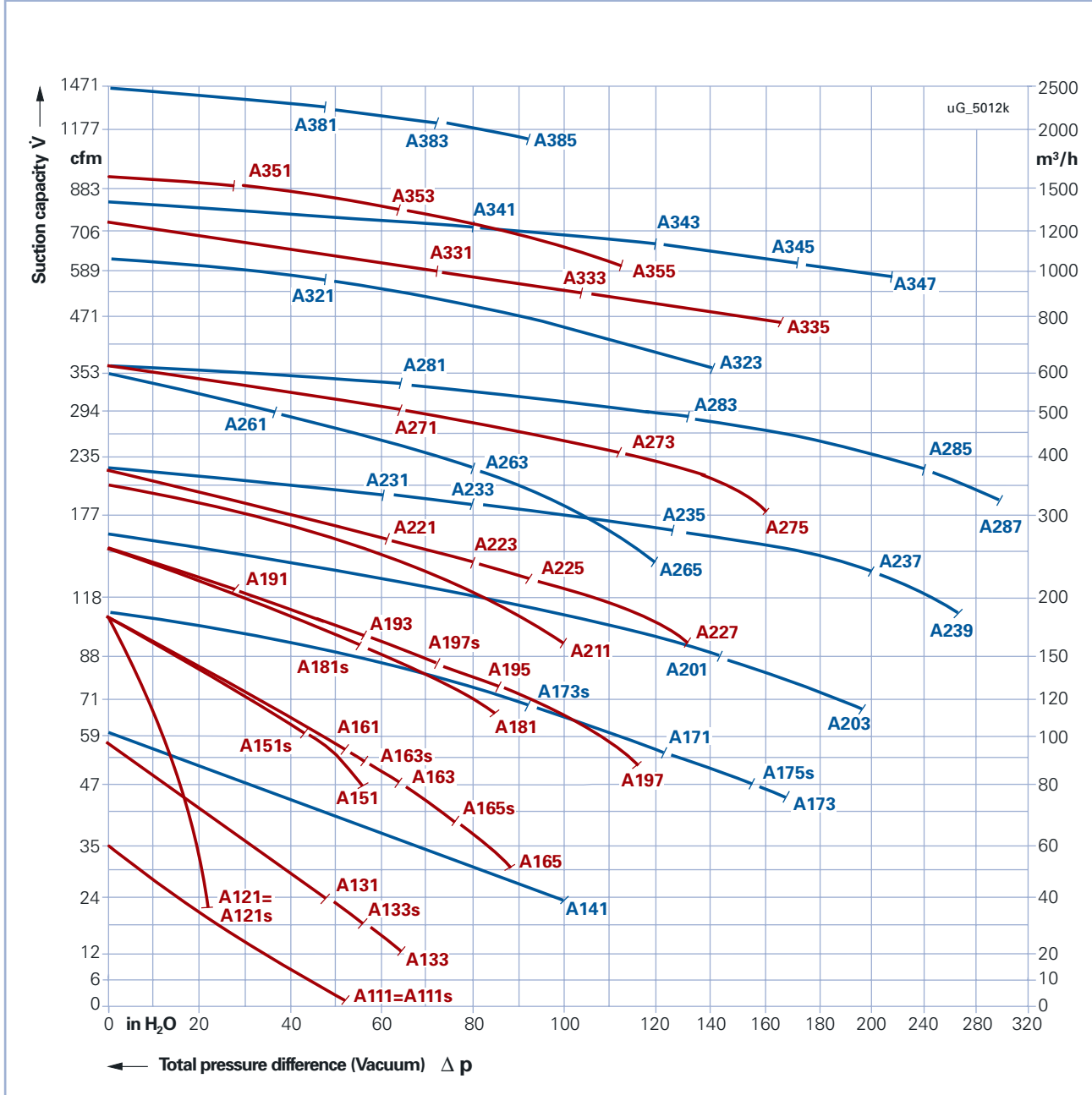

▶ Please open this page for selection diagram.

Selection and ordering information for G6_Mx_3AC_7PS

Line no.	output kW	input voltage ¹⁾ V	motor power A	constant A	• Available reference	Height mm	Weight kg	Sound power dB(A)	Value-to-value conversion factor ²⁾	Pressure-rotal value ³⁾	Pressure-rotal value ³⁾
A111	0.22	220/230	1.0	1.2	2001-200-3A-W-0	7	53	-	-	-	-
A112	0.28	220/230	1.2	1.5	2001-200-3A-W-0	8	61	-	-	-	-
A113	0.38	220/230	1.5	1.8	2001-200-3A-W-0	9	68	-	-	1 x 110/124	1 x 110/124
A114	0.5	220/230	1.8	2.1	2001-200-3A-W-0	10	76	-	-	1 x 110/124	1 x 110/124
A115	0.65	220/230	2.1	2.5	2001-200-3A-W-0	11	84	-	-	1 x 110/124	1 x 110/124
A116	0.85	220/230	2.5	3.0	2001-200-3A-W-0	12	92	-	-	1 x 110/124	1 x 110/124
A117	1.1	220/230	3.0	3.6	2001-200-3A-W-0	13	100	-	-	1 x 110/124	1 x 110/124
A118	1.4	220/230	3.6	4.3	2001-200-3A-W-0	14	108	-	-	1 x 110/124	1 x 110/124
A119	1.8	220/230	4.3	5.1	2001-200-3A-W-0	15	116	-	-	1 x 110/124	1 x 110/124
A120	2.2	220/230	5.1	6.1	2001-200-3A-W-0	16	124	-	-	1 x 110/124	1 x 110/124
A121	2.8	220/230	6.1	7.3	2001-200-3A-W-0	17	132	-	-	1 x 110/124	1 x 110/124
A122	3.5	220/230	7.3	8.7	2001-200-3A-W-0	18	140	-	-	1 x 110/124	1 x 110/124
A123	4.5	220/230	8.7	10.4	2001-200-3A-W-0	19	148	-	-	1 x 110/124	1 x 110/124
A124	5.8	220/230	10.4	12.5	2001-200-3A-W-0	20	156	-	-	1 x 110/124	1 x 110/124
A125	7.5	220/230	12.5	15.0	2001-200-3A-W-0	21	164	-	-	1 x 110/124	1 x 110/124
A126	9.5	220/230	15.0	18.0	2001-200-3A-W-0	22	172	-	-	1 x 110/124	1 x 110/124
A127	12.0	220/230	18.0	21.6	2001-200-3A-W-0	23	180	-	-	1 x 110/124	1 x 110/124
A128	15.0	220/230	21.6	25.9	2001-200-3A-W-0	24	188	-	-	1 x 110/124	1 x 110/124
A129	19.0	220/230	25.9	31.1	2001-200-3A-W-0	25	196	-	-	1 x 110/124	1 x 110/124
A130	24.0	220/230	31.1	37.3	2001-200-3A-W-0	26	204	-	-	1 x 110/124	1 x 110/124
A131	3.0	380-480	4.5	5.4	2001-200-3A-W-2	27	58	-	-	1 x 110/124	1 x 110/124
A132	3.8	380-480	5.4	6.5	2001-200-3A-W-2	28	64	-	-	1 x 110/124	1 x 110/124
A133	4.8	380-480	6.5	7.8	2001-200-3A-W-2	29	70	-	-	1 x 110/124	1 x 110/124
A134	6.0	380-480	7.8	9.4	2001-200-3A-W-2	30	76	-	-	1 x 110/124	1 x 110/124
A135	7.5	380-480	9.4	11.3	2001-200-3A-W-2	31	82	-	-	1 x 110/124	1 x 110/124
A136	9.5	380-480	11.3	13.6	2001-200-3A-W-2	32	88	-	-	1 x 110/124	1 x 110/124
A137	12.0	380-480	13.6	16.3	2001-200-3A-W-2	33	94	-	-	1 x 110/124	1 x 110/124
A138	15.0	380-480	16.3	19.6	2001-200-3A-W-2	34	100	-	-	1 x 110/124	1 x 110/124
A139	19.0	380-480	19.6	23.5	2001-200-3A-W-2	35	106	-	-	1 x 110/124	1 x 110/124
A140	24.0	380-480	23.5	28.2	2001-200-3A-W-2	36	112	-	-	1 x 110/124	1 x 110/124
A141	3.0	380-480	4.5	5.4	2001-200-3A-W-3	37	58	-	-	1 x 110/124	1 x 110/124
A142	3.8	380-480	5.4	6.5	2001-200-3A-W-3	38	64	-	-	1 x 110/124	1 x 110/124
A143	4.8	380-480	6.5	7.8	2001-200-3A-W-3	39	70	-	-	1 x 110/124	1 x 110/124
A144	6.0	380-480	7.8	9.4	2001-200-3A-W-3	40	76	-	-	1 x 110/124	1 x 110/124
A145	7.5	380-480	9.4	11.3	2001-200-3A-W-3	41	82	-	-	1 x 110/124	1 x 110/124
A146	9.5	380-480	11.3	13.6	2001-200-3A-W-3	42	88	-	-	1 x 110/124	1 x 110/124
A147	12.0	380-480	13.6	16.3	2001-200-3A-W-3	43	94	-	-	1 x 110/124	1 x 110/124
A148	15.0	380-480	16.3	19.6	2001-200-3A-W-3	44	100	-	-	1 x 110/124	1 x 110/124
A149	19.0	380-480	19.6	23.5	2001-200-3A-W-3	45	106	-	-	1 x 110/124	1 x 110/124
A150	24.0	380-480	23.5	28.2	2001-200-3A-W-3	46	112	-	-	1 x 110/124	1 x 110/124

G_Series G_200, 60 Hz

The performance curves are valid for pumping air at 25 °C dry bulb temperature. The total pressure differences are valid up to an intake and outlet temperature of 25 °C.

1) Delta line voltage, 3-phase, etc. see page 42.

2) $\frac{\text{Value} \times \text{rotal}}{\text{Value} \times \text{rotal}}$

3) $\frac{\text{Value} \times \text{rotal}}{\text{Value} \times \text{rotal}}$

17

18

G_Series G_200e with frequency converter



The G_200 pumps and compressors with integrated frequency converter (FC) are supplied with a standard speed of 5,000 min⁻¹. A reduction in the speed and thus adaptation to the required duty point is possible

1. manually: by adjusting the setting at the potentiometer
2. automatically: by specifying the target value via the analogue input (0 ... 10 V, 0 ... 20 mA)
3. automatically: via the digital input

The range meets the EMC guidelines because of the radio interference suppression filter (class A) that is installed as standard.

Standard protection features:

- Over-voltage protection
- Short-circuit protection
- Overheating protection of converter
- PTC thermistor for integrated converter, optional for external converter

Selection and ordering information for 3 AC, 45...65 Hz, 360-550 V, IP55

Curve no.	Rated performance P (in hp)	Speed range min ⁻¹	Order no.		
			Gas ring compressor with integrated FC	Gas ring compressor for external FC	external FC
A142e	2.0	2,200 ... 5,000	2BH1 310-7HN21	2BH1 310-7HH26	2FC4 152-2NE00
A162e	3.0	2,200 ... 5,000	2BH1 400-7AN21	2BH1 400-7AH26	2FC4 222-2NE00

Selection diagram 2BH1 310-...

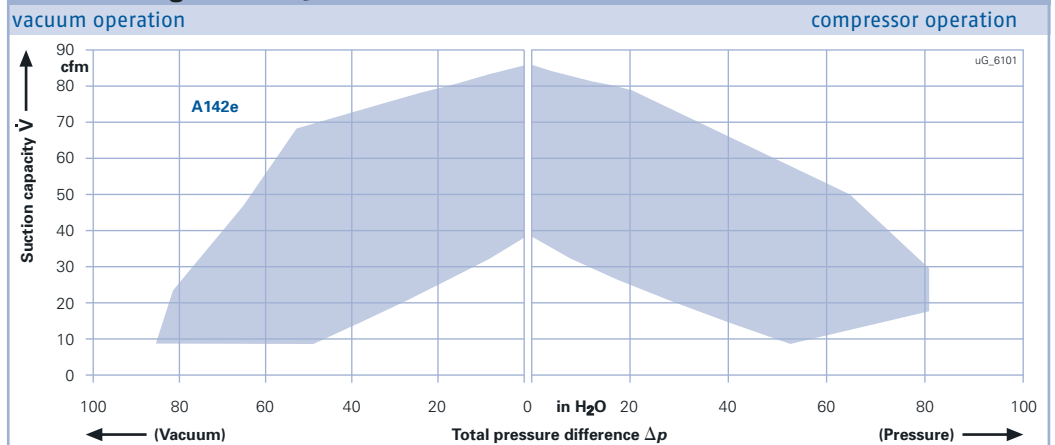

Selection diagram 2BH1 400-...

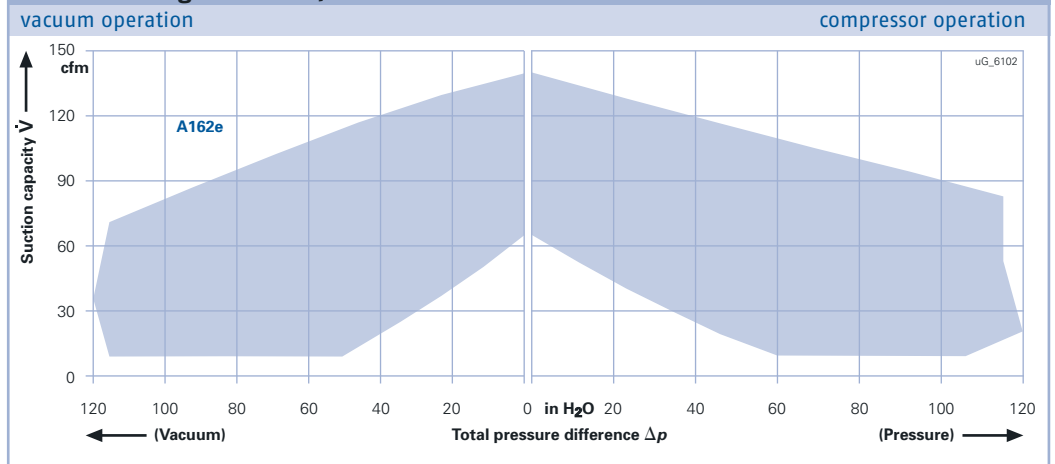

The performance curves are valid for pumping air at 60 °F (15 °C) at the inlet flanges with an air pressure of 29,9 in Hg abs. (1,013 mbar) and a tolerance of ±10%. The total pressure differences are valid up to an intake and ambient temperature of 77 °F (25 °C).

Selection and ordering information for 3 AC, 45...65 Hz, 360-550 V, IP55

Curve no.	Rated performance P (in hp)	Speed range min ⁻¹	Order no.		
			Gas ring compressor with integrated FC	Gas ring compressor for external FC	external FC
A174e	5.4	2,200 ... 5,000	2BH1 410-7HN41	2BH1 410-7HH46	2FC4 402-2NE00
A193e	5.4	2,200 ... 5,000	2BH1 500-7AN31	2BH1 500-7AH36	2FC4 402-2NE00
A205e	10	2,200 ... 5,000	2BH1 510-7HN51	2BH1 510-7HH56	2FC4 752-2NE00

Selection diagram 2BH1 410-...

vacuum operation

compressor operation

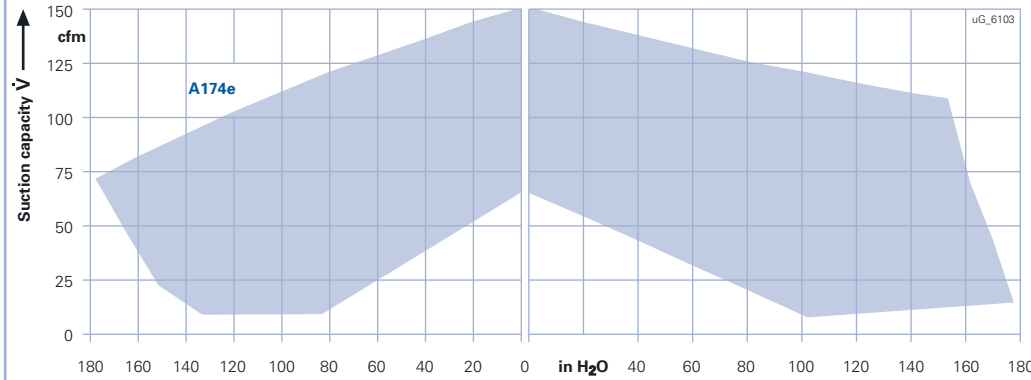

Selection diagram 2BH1 500-...

vacuum operation

compressor operation

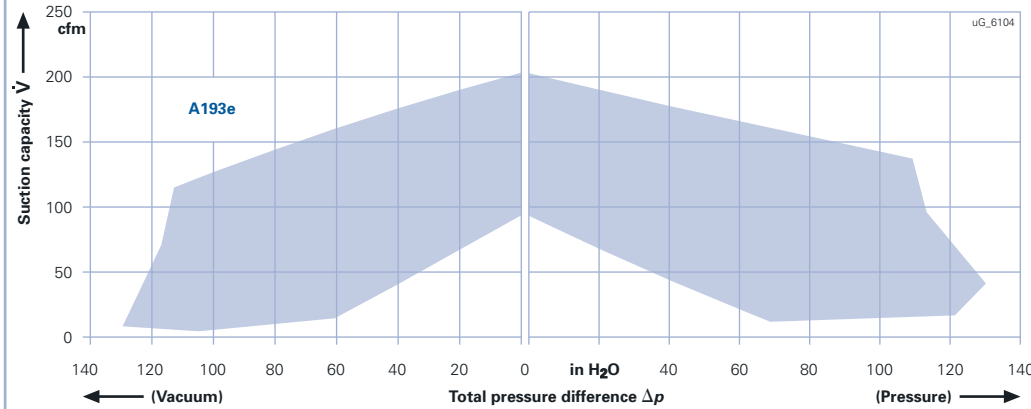

Selection diagram 2BH1 510-...

vacuum operation

compressor operation

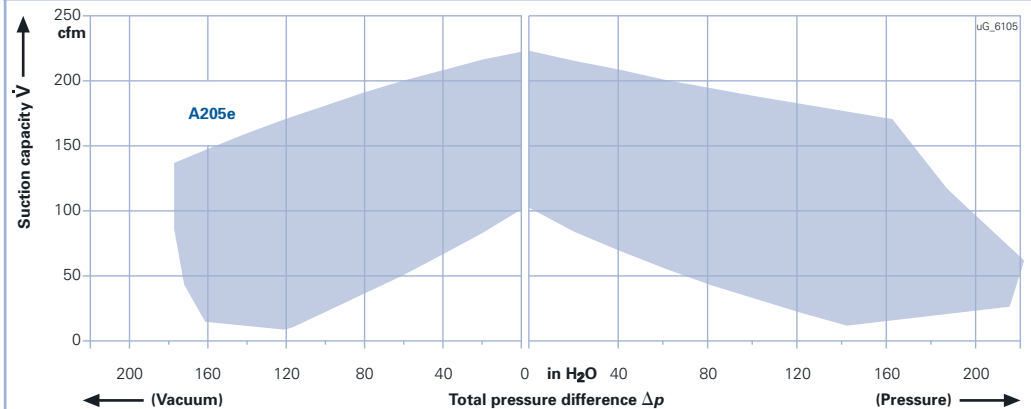

The performance curves are valid for pumping air at 60 °F (15 °C) at the inlet flanges with an air pressure of 29,9 in Hg abs. (1,013 mbar) and a tolerance of ±10%. The total pressure differences are valid up to an intake and ambient temperature of 77 °F (25 °C).

G_Series G_200e with frequency converter



Selection and ordering information for 3 AC, 45...65 Hz, 360-550 V, IP55

Curve no.	Rated performance P (in hp)	Speed range min ⁻¹	Order no.		
			Gas ring compressor with integrated FC	Gas ring compressor for external FC	external FC
A223e	10.1	2,200 ... 5,000	2BH1 600-7AN31	2BH1 600-7AH36	2FC4 752-2NE00
A233e	10.1	2,200 ... 5,000	2BH1 610-7HN31	2BH1 610-7HH36	2FC4 752-2NE00
A235e	14.8	2,200 ... 5,000	–	2BH1 610-7HH56	2FC4 113-2NE00
A264e	14.8	2,200 ... 4,200	–	2BH1 640-7GH46	2FC4 113-2NE00
A265e	20.1	2,200 ... 5,000	–	2BH1 640-7GH56	2FC4 153-2NE00

Selection diagram 2BH1 600-...

vacuum operation

compressor operation

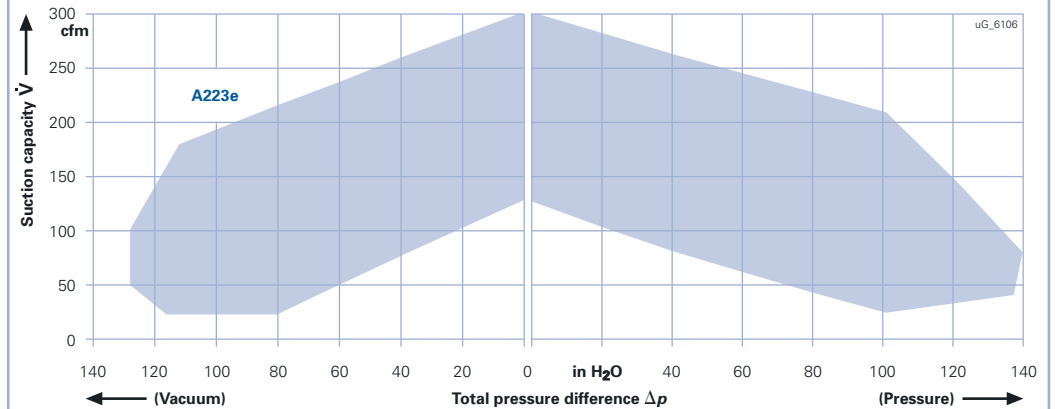

Selection diagrams 2BH1 610-...

vacuum operation

compressor operation

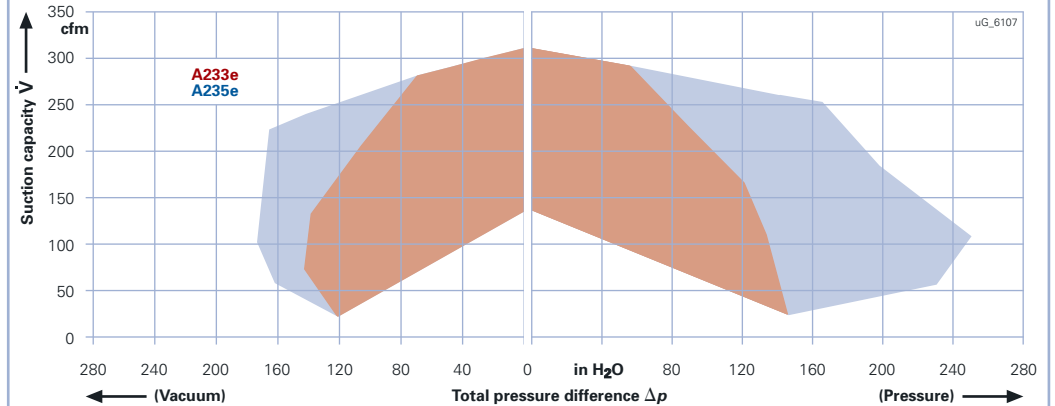

Selection diagrams 2BH1 640-...

vacuum operation

compressor operation

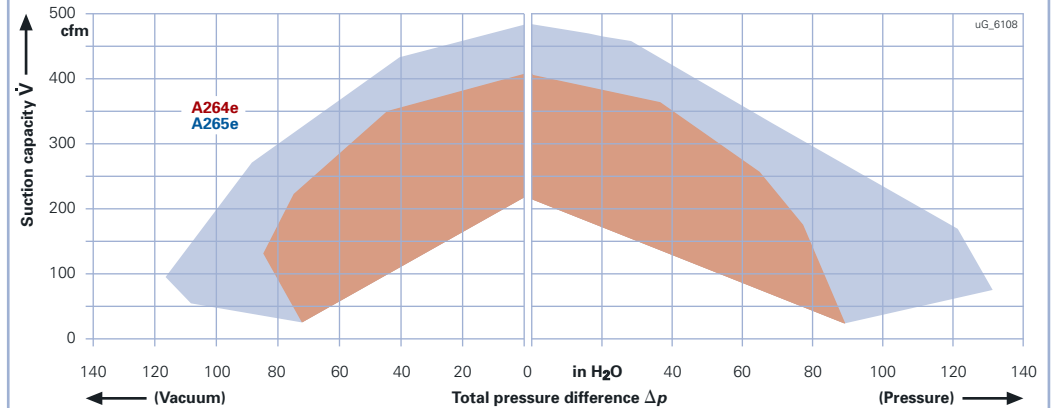

The performance curves are valid for pumping air at 60 °F (15 °C) at the inlet flanges with an air pressure of 29,9 in Hg abs. (1,013 mbar) and a tolerance of ±10%. The total pressure differences are valid up to an intake and ambient temperature of 77 °F (25 °C).

Selection and ordering information for 3 AC, 45...65 Hz, 360-550 V, IP55

Curve no.	Rated performance P (in hp)	Speed range min ⁻¹	Order no.		
			Gas ring compressor with integrated FC	Gas ring compressor for external FC	external FC
A270e	10	2,200 ... 5,000	2BH1 800-7AN01	2BH1 800-7AH06	2FC4 752-2NE00
A272e	20.1	2,200 ... 5,000	–	2BH1 800-7AH26	2FC4 153-2NE00
A282e	20.1	2,200 ... 5,000	–	2BH1 810-7HH26	2FC4 153-2NE00
A284e	40.2	2,200 ... 5,000	–	2BH1 810-7HH46	2FC4 303-2NE00
A323e	29.5	2,200 ... 5,000	–	2BH1 840-7JH36	2FC4 223-2NE00

Selection diagrams 2BH1 800-...

vacuum operation

compressor operation

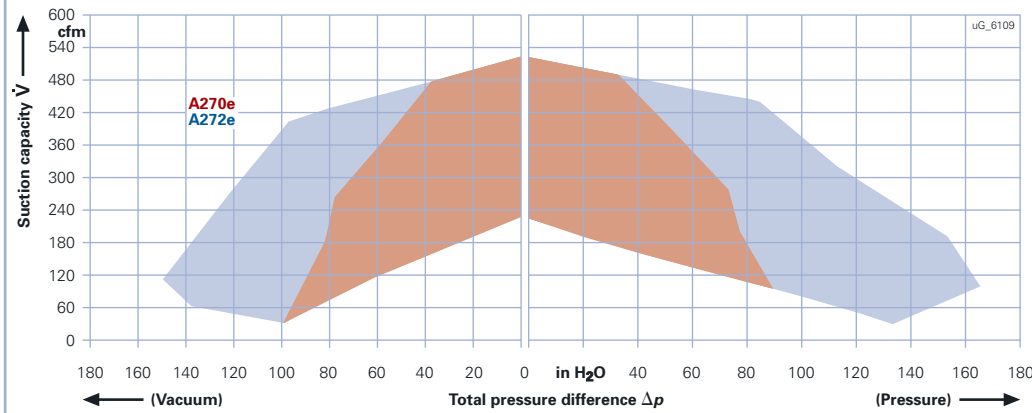

Selection diagrams 2BH1 810-...

vacuum operation

compressor operation

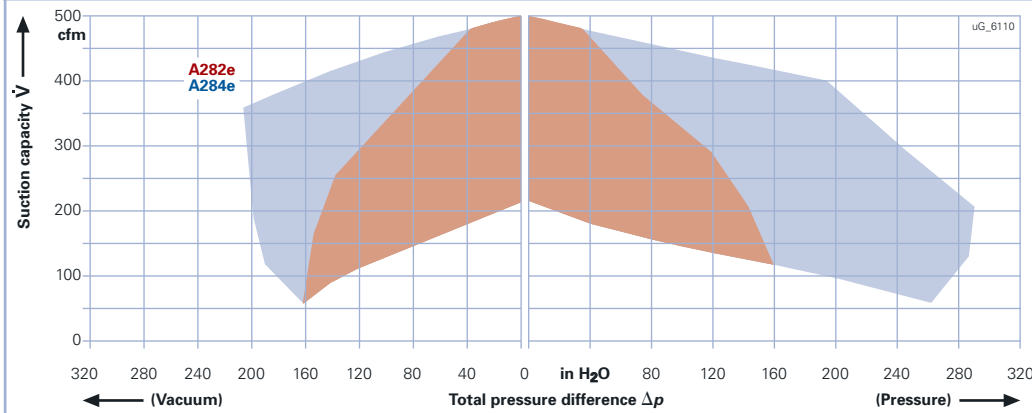

Selection diagram 2BH1 840-...

vacuum operation

compressor operation

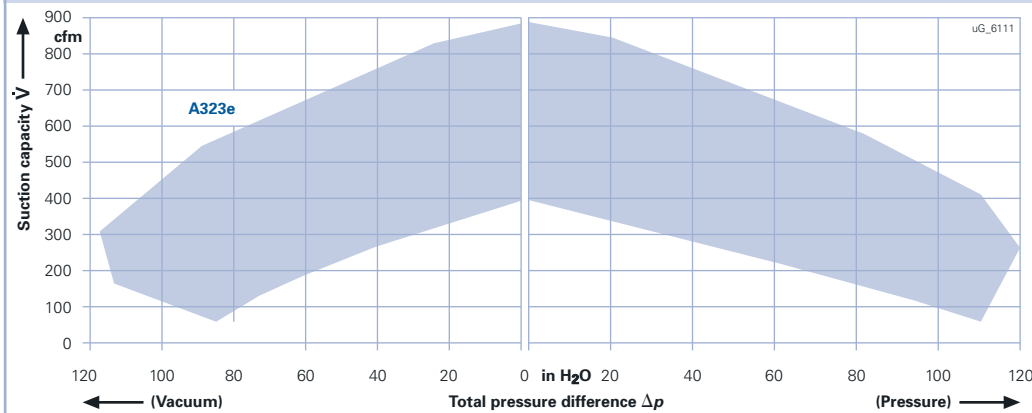

The performance curves are valid for pumping air at 60 °F (15 °C) at the inlet flanges with an air pressure of 29,9 in Hg abs. (1,013 mbar) and a tolerance of ±10%. The total pressure differences are valid up to an intake and ambient temperature of 77 °F (25 °C).

G_Series G_200e with frequency converter



Selection and ordering information for 3 AC, 45...65 Hz, 360-550 V, IP55

Curve no.	Rated performance P (in hp)	Speed range min ⁻¹	Order no.		
			Gas ring compressor with integrated FC	Gas ring compressor for external FC	external FC
A330e	20.1	2,200 ... 4,200	–	2BH1 900-7AH06	2FC4 153-2NE00
A333e	40.2	2,200 ... 4,200	–	2BH1 900-7AH36	2FC4 303-2NE00
A341e	29.5	2,200 ... 4,200	–	2BH1 910-7HH16	2FC4 223-2NE00
A344e	60.3	2,200 ... 4,200	–	2BH1 910-7HH46	2FC4 453-2NE00
A382e	29.5	2,200 ... 3,600	–	2BH1 943-7GH26	2FC4 223-2NE00
A384e	60.3	2,200 ... 4,200	–	2BH1 943-7GH46	2FC4 453-2NE00

Selection diagrams 2BH1 900-...

vacuum operation

compressor operation

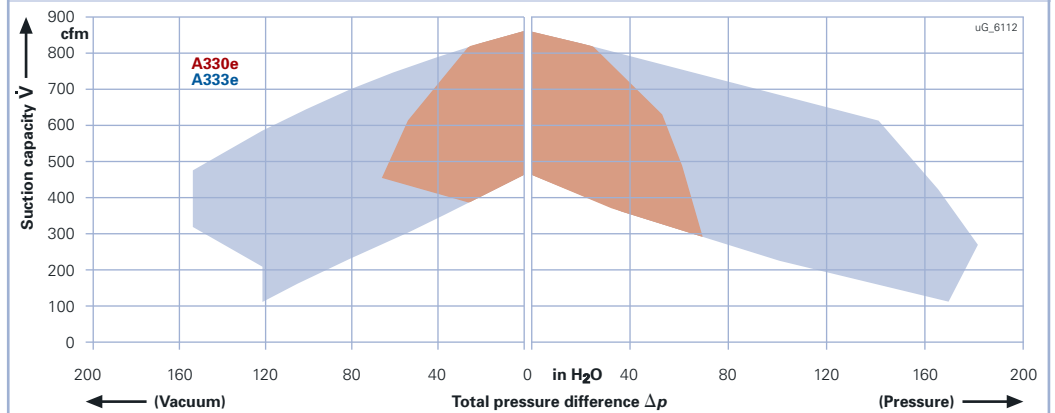

Selection diagrams 2BH1 910-...

vacuum operation

compressor operation

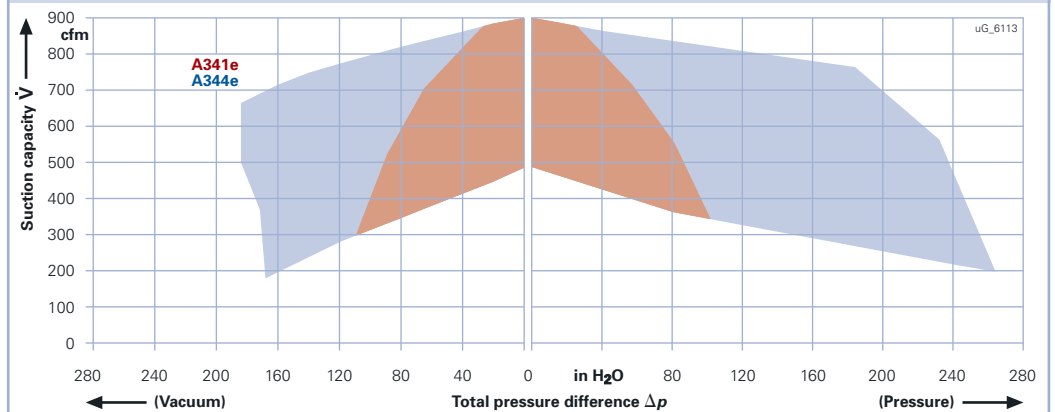

Selection diagrams 2BH1 943-...

vacuum operation

compressor operation

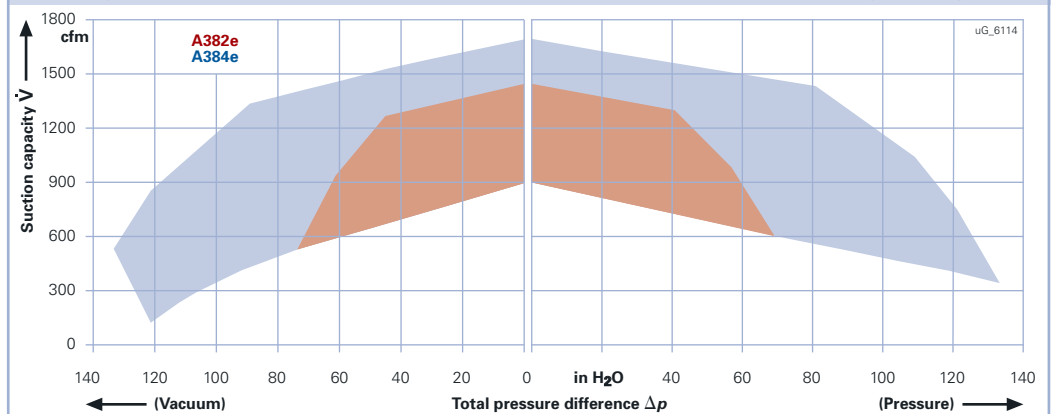

The performance curves are valid for pumping air at 60 °F (15 °C) at the inlet flanges with an air pressure of 29,9 in Hg abs. (1,013 mbar) and a tolerance of ±10%. The total pressure differences are valid up to an intake and ambient temperature of 77 °F (25 °C).

Notes

G_400



G_400 single and multi-stage



G_400e with integrated or external frequency converter

G_400

Unsurpassed at highest differential pressure

Our revolutionary G_400 blowers can create pressure differences of up to 400 inch H₂O – more than any other gas ring pump! So far, the systems used to reach these differential pressure ranges were much louder and larger – or subject to wear. Now the advantages of wear-free operation coupled with a low noise level can also be used in the most demanding applications.

The G_400 vacuum pumps and compressors can work up to 20,000 hours without maintenance down time.

These specialist machines have proven their reliability under the harshest of conditions. Their noise level was already impressively low, but our engineers and designers were able to make them even more quiet.

Selection diagrams and tables for G_400, vacuum and compressor mode, 50 and 60 Hz	pages	28-29
G_400e pumps and compressors with speed control and frequency converter	pages	30-33
Details on voltages, footnotes etc. see	page	83

Selection and ordering information for 50 Hz, 3AC, IP55

Curve no.	Motor			Order no.	Weight approx. lbs	Sound pressure level ¹⁾ dB(A)	Vacuum-relief valve ²⁾ Items x Typ 2BX2...	Pressure-relief valve ²⁾ Items x Typ 2BX2...
	output hp	Rated voltage ⁴⁾ V	current A					
B140	0.8	200-240 Δ / 345-415 Y	2.8 Δ / 1.6 Y	2BH7 210-0A H 1 6-7	35	57	1 x 110/141	1 x 111/143
B150	1.1	200-240 Δ / 345-415 Y	4 Δ / 2.3 Y	2BH7 220-0A H 2 6-7	53	58	1 x 110/141	1 x 111/143
B152	2	200-240 Δ / 345-415 Y	7.5 Δ / 4.3 Y	2BH7 220-0A H 5 6-7	62	58	1 x 110/141	1 x 111/143
B170	0.7	200-240 Δ / 345-415 Y	2.8 Δ / 1.6 Y	2BH7 310-0A H 1 6-7	35	57	1 x 110/141	1 x 111/143
B172	1.1	200-240 Δ / 345-415 Y	4 Δ / 2.3 Y	2BH7 310-0A H 2 6-7	37	57	1 x 110/141	1 x 111/143
B180	1.5	200-240 Δ / 345-415 Y	5.4 Δ / 3.1 Y	2BH7 320-0A H 4 6-7	64	59	1 x 110/141	1 x 111/143
B182	2	200-240 Δ / 345-415 Y	7.5 Δ / 4.3 Y	2BH7 320-0A H 5 6-7	66	59	1 x 110/141	1 x 111/143
B200	1.5	200-240 Δ / 345-415 Y	5.4 Δ / 3.1 Y	2BH7 410-0A H 1 6-7	51	58	1 x 110/141	1 x 111/143
B210	2	200-240 Δ / 345-415 Y	7.5 Δ / 4.3 Y	2BH7 420-0A H 2 6-7	73	61	1 x 110/141	1 x 111/143
B212	4.4	200-240 Δ / 345-415 Y	13 Δ / 7.5 Y	2BH7 420-0A H 5 6-7	86	61	1 x 110/141	1 x 111/143
B230	2	200-240 Δ / 345-415 Y	7.5 Δ / 4.3 Y	2BH7 510-0A H 1 6-8	57	64	1 x 110/141	1 x 111/143
B232	3	200-240 Δ / 345-415 Y	11.4 Δ / 6.6 Y	2BH7 510-0A H 2 6-8	64	64	1 x 110/141	1 x 111/143
B240	3	200-240 Δ / 345-415 Y	11.4 Δ / 6.6 Y	2BH7 520-0A H 2 6-8	88	64	1 x 110/141	1 x 111/143
B244	5.4	200-240 Δ / 345-415 Y	15.5 Δ / 9 Y	2BH7 520-0A H 7 6-8	51	65	1 x 110/141	1 x 111/143
B260	3	200-240 Δ / 345-415 Y	11.4 Δ / 6.6 Y	2BH7 610-0A H 1 6-8	71	65	1 x 110/141	1 x 111/143
B262	4.4	200-240 Δ / 345-415 Y	13 Δ / 7.5 Y	2BH7 610-0A H 3 6-8	77	65	1 x 110/141	1 x 111/143
B270	4.4	200-240 Δ / 345-415 Y	13 Δ / 7.5 Y	2BH7 620-0A H 3 6-8	106	67	1 x 110/141	1 x 111/143
B272	7.6	200-240 Δ / 345-415 Y	21.5 Δ / 12.5 Y	2BH7 620-0A H 5 6-8	65	68	1 x 110/141	1 x 111/143
B282	10.1	200-240 Δ / 345-415 Y	27.5 Δ / 16 Y	2BH7 630-0A H 6 6-8	86	72	1 x 110/141	1 x 111/143

Selection and ordering information for 60 Hz, 3AC, IP 55

B141	0.8	220-275 Δ / 380-480 Y	3 Δ / 1.7 Y	2BH7 210-0A H 1 6-7	35	62	1 x 114/142	1 x 115/144
B151	1.3	220-275 Δ / 380-480 Y	4 Δ / 2.3 Y	2BH7 220-0A H 2 6-7	53	62	1 x 114/142	1 x 115/144
B153	2.4	220-275 Δ / 380-480 Y	7.6 Δ / 4.4 Y	2BH7 220-0A H 5 6-7	62	62	1 x 114/142	1 x 115/144
B171	0.8	220-275 Δ / 380-480 Y	3 Δ / 1.7 Y	2BH7 310-0A H 1 6-7	35	62	1 x 114/142	1 x 115/144
B173	1.3	220-275 Δ / 380-480 Y	4 Δ / 2.3 Y	2BH7 310-0A H 2 6-7	37	62	1 x 114/142	1 x 115/144
B181	1.7	220-275 Δ / 380-480 Y	5.4 Δ / 3.1 Y	2BH7 320-0A H 4 6-7	64	63	1 x 114/142	1 x 115/144
B183	2.4	220-275 Δ / 380-480 Y	7.6 Δ / 4.4 Y	2BH7 320-0A H 5 6-7	66	63	1 x 114/142	1 x 115/144
B201	1.7	220-275 Δ / 380-480 Y	5.4 Δ / 3.1 Y	2BH7 410-0A H 1 6-7	51	62	1 x 114/142	1 x 115/144
B211	2.4	220-275 Δ / 380-480 Y	7.6 Δ / 4.4 Y	2BH7 420-0A H 2 6-7	73	66	1 x 114/142	1 x 115/144
B213	5.1	220-275 Δ / 380-480 Y	13.8 Δ / 8 Y	2BH7 420-0A H 5 6-7	86	66	1 x 114/142	1 x 115/144
B231	2.4	220-275 Δ / 380-480 Y	7.6 Δ / 4.4 Y	2BH7 510-0A H 1 6-8	57	68	1 x 114/142	1 x 115/144
B233	3.4	220-275 Δ / 380-480 Y	11.2 Δ / 6.5 Y	2BH7 510-0A H 2 6-8	64	68	1 x 114/142	1 x 115/144
B241	3.4	220-275 Δ / 380-480 Y	11.2 Δ / 6.5 Y	2BH7 520-0A H 2 6-8	88	70	1 x 114/142	1 x 115/144
B245	6.2	220-275 Δ / 380-480 Y	16.5 Δ / 9.5 Y	2BH7 520-0A H 7 6-8	51	71	1 x 114/142	1 x 115/144
B261	3.4	220-275 Δ / 380-480 Y	11.2 Δ / 6.5 Y	2BH7 610-0A H 1 6-8	71	71	1 x 114/142	1 x 115/144
B263	5.1	220-275 Δ / 380-480 Y	14.2 Δ / 8.2 Y	2BH7 610-0A H 3 6-8	77	71	1 x 114/142	1 x 115/144
B271	5.1	220-275 Δ / 380-480 Y	14.2 Δ / 8.2 Y	2BH7 620-0A H 3 6-8	106	71	1 x 114/142	1 x 115/144
B273	8.9	220-275 Δ / 380-480 Y	21 Δ / 12 Y	2BH7 620-0A H 5 6-8	65	72	1 x 114/142	1 x 115/144
B283	11.5	220-275 Δ / 380-480 Y	27.5 Δ / 16 Y	2BH7 630-0A H 6 6-8	86	76	1 x 114/142	1 x 115/144

Selection and ordering information for 50 Hz, 1AC, IP 55

B140s	0.7	115 / 230	13 / 3.1	2BH7 210-0A V 7 5-7	40	57		
B150s	2	115 / 230	19.4 / 9.7	2BH7 220-0A V 7 5-7	66	58		
B172s	1.3	115 / 230	15.2 / 7.6	2BH7 310-0A V 7 5-7	40	57		
B180s	2	115 / 230	19.4 / 9.7	2BH7 320-0A V 7 5-7	71	59		
B200s	1.5	115 / 230	16.0 / 8.0	2BH7 410-0A V 4 5-7	51	58		

Selection and ordering information for 60 Hz, 1AC, IP 55

B141s	0.8	115 / 230	14.2 / 7.1	2BH7 210-0A V 7 5-7	40	62		
B151s	2.4	115 / 230	20.6 / 10.3	2BH7 220-0A V 7 5-7	66	62		
B173s	1.5	115 / 230	18 / 9	2BH7 310-0A V 7 5-7	40	62		
B181s	2.4	115 / 230	20.6 / 10.3	2BH7 320-0A V 7 5-7	71	63		
B201s	1.7	115 / 230	20 / 10	2BH7 410-0A V 4 5-7	51	62		

Details on voltages, footnotes etc. see page 83.

G_Series G_400e with frequency converter



The G_400 pumps and compressors with integrated frequency converter (FC) are supplied with a standard speed of 5,000 min⁻¹. A reduction in the speed and thus adaptation to the required duty point is possible

1. manually: by adjusting the setting at the potentiometer
2. automatically: by specifying the target value via the analogue input (0 ... 10 V, 0 .. 20 mA)
3. automatically: via the digital input

The range meets the EMC guidelines because of the radio interference suppression filter (class A) that is installed as standard.

Standard protection features:

- Over-voltage protection
- Short-circuit protection
- Overheating protection of converter
- PTC thermistor for integrated converter, optional for external converter

Selection and ordering information for 3 AC, 45...65 Hz, 360-550 V, IP55

Curve no.	Rated performance P (in hp)	Speed range min ⁻¹	Order no.			Sound-pressure level ¹⁾ dB(A)
			Gas ring compressor with integrated FC	Gas ring compressor for external FC	external FC	
B141e	2	2,200 ... 5,000	2BH7 210-0AN11-7	2BH7 210-0AH16-7	2FC4 152-2NE00	74
B145e	4	2,200 ... 5,000	2BH7 210-0AN51-7	2BH7 210-0AH56-7	2FC4 302-2NE00	74
B155e	4	2,200 ... 5,000	2BH7 220-0AN51-7	2BH7 220-0AH56-7	2FC4 302-2NE00	74

Selection diagrams 2BH7 210-...

vacuum operation

compressor operation

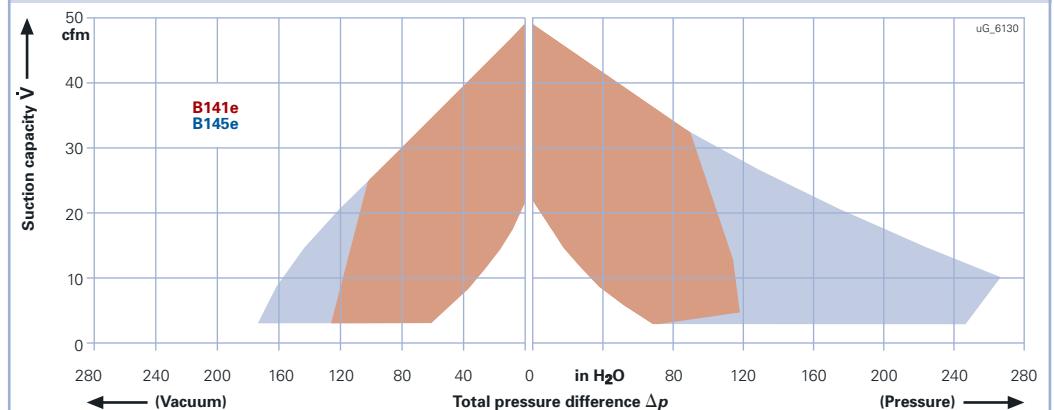

Selection diagram 2BH7 220-...

vacuum operation

compressor operation

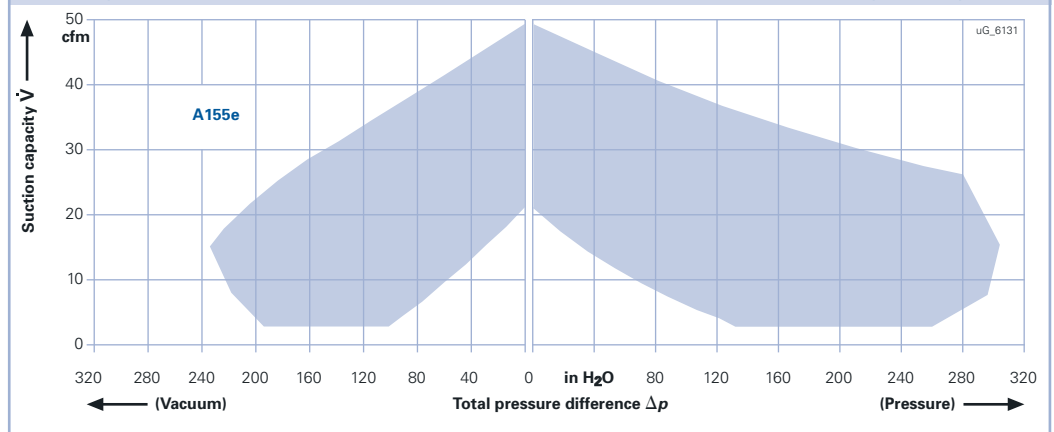

The performance curves are valid for pumping air at 60 °F (15 °C) at the inlet flanges with an air pressure of 29,9 in Hg abs. (1,013 mbar) and a tolerance of ±10%. The total pressure differences are valid up to an intake and ambient temperature of 77 °F (25 °C).

Selection and ordering information for 3 AC, 45...65 Hz, 360-550 V, IP55

Curve no.	Rated performance P (in hp)	Speed range min ⁻¹	Order no.			Sound-pressure level ¹⁾ dB(A)
			Gas ring compressor with integrated FC	Gas ring compressor for external FC	external FC	
B172e	2	2,200 ... 5,000	2BH7 310-0AN21-7	2BH7 310-0AH26-7	2FC4 152-2NE00	76
B176e	5.4	2,200 ... 5,000	2BH7 310-0AN61-7	2BH7 310-0AH66-7	2FC4 402-2NE00	76
B185e	4	2,200 ... 5,000	2BH7 320-0AN51-7	2BH7 320-0AH56-7	2FC4 302-2NE00	76
B188e	7.4	2,200 ... 5,000	2BH7 320-0AN81-7	2BH7 320-0AH86-7	2FC4 552-2NE00	76
B201e	3	2,200 ... 5,000	2BH7 410-0AN11-7	2BH7 410-0AH16-7	2FC4 222-2NE00	76
B205e	7.4	2,200 ... 5,000	2BH7 410-0AN51-7	2BH7 410-0AH56-7	2FC4 552-2NE00	76

Selection diagrams 2BH7 310-...

vacuum operation

compressor operation

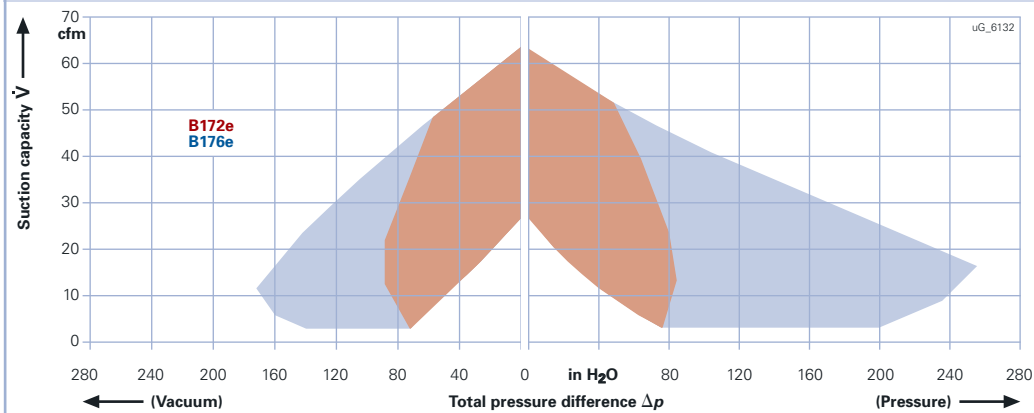

Selection diagrams 2BH7 320-...

vacuum operation

compressor operation

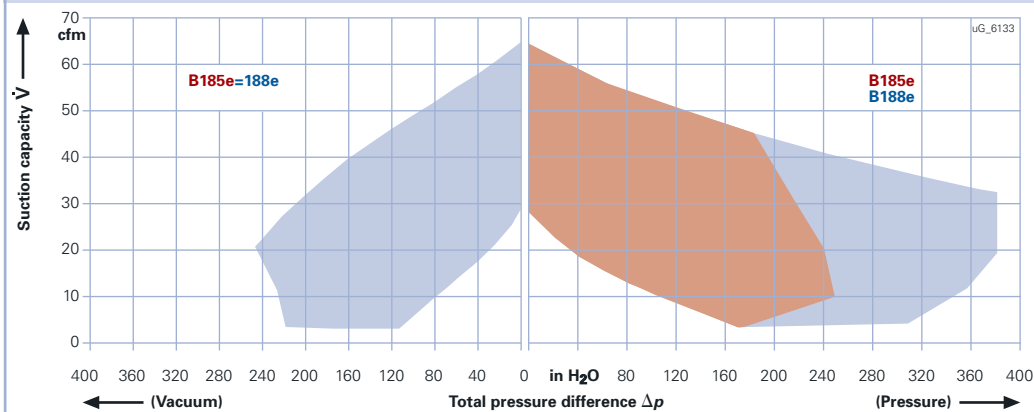

Selection diagrams 2BH7 410-...

vacuum operation

compressor operation

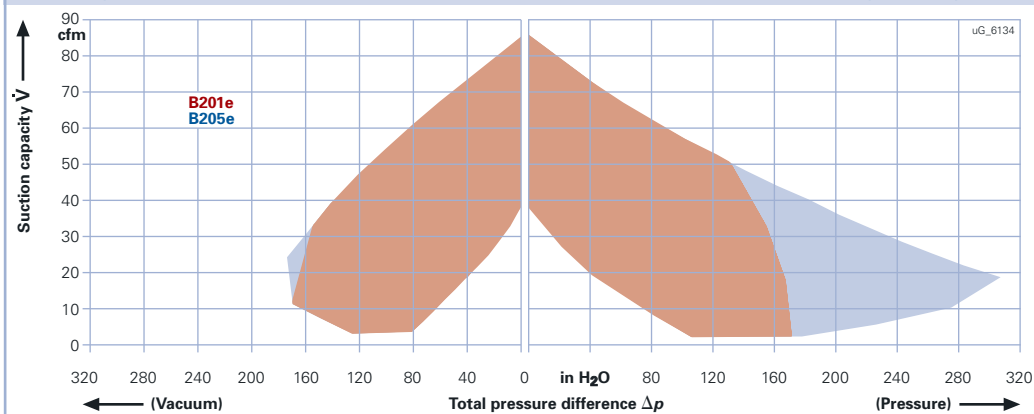

The performance curves are valid for pumping air at 60 °F (15 °C) at the inlet flanges with an air pressure of 29,9 in Hg abs. (1,013 mbar) and a tolerance of ±10%. The total pressure differences are valid up to an intake and ambient temperature of 77 °F (25 °C).

G_Series G_400e with frequency converter



Selection and ordering information for 3 AC, 45...65 Hz, 360-550 V, IP55

Curve no.	Rated performance P (in hp)	Speed range min ⁻¹	Order no.			Sound-pressure level ¹⁾ dB(A)
			Gas ring compressor with integrated FC	Gas ring compressor for external FC	external FC	
B212e	4	2,200 ... 5,000	2BH7 420-0AN21-7	2BH7 420-0AH26-7	2FC4 302-2NE00	76
B215e	7.4	2,200 ... 5,000	2BH7 420-0AN51-7	2BH7 420-0AH56-7	2FC4 552-2NE00	76
B232e	5.4	2,200 ... 5,000	2BH7 510-0AN21-8	2BH7 510-0AH26-8	2FC4 402-2NE00	78
B236e	10	2,200 ... 5,000	2BH7 510-0AN61-8	2BH7 510-0AH66-8	2FC4 752-2NE00	78
B247e	10	2,200 ... 5,000	2BH7 520-0AN71-8	2BH7 520-0AH76-8	2FC4 752-2NE00	78
B248e	14.8	2,200 ... 5,000	—	2BH7 520-0AH86-8	2FC4 113-2NE00	78

Selection diagrams 2BH7 420-...

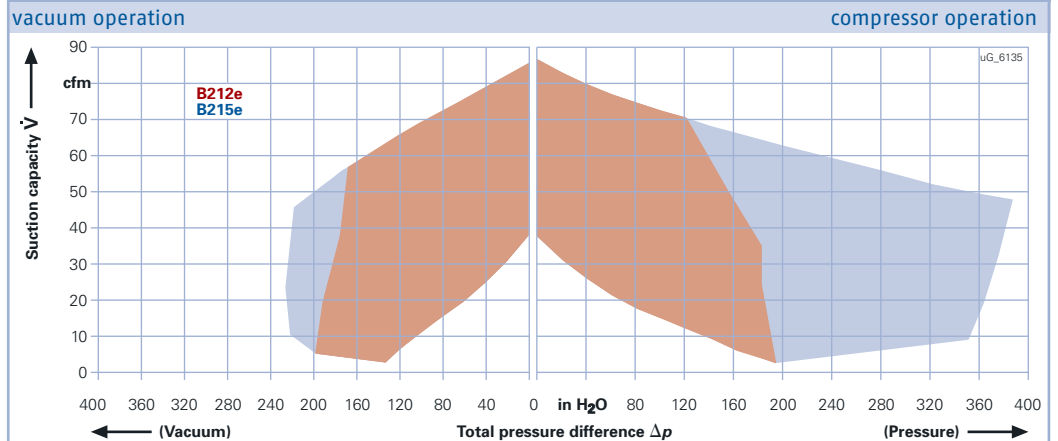

Selection diagrams 2BH7 510-...

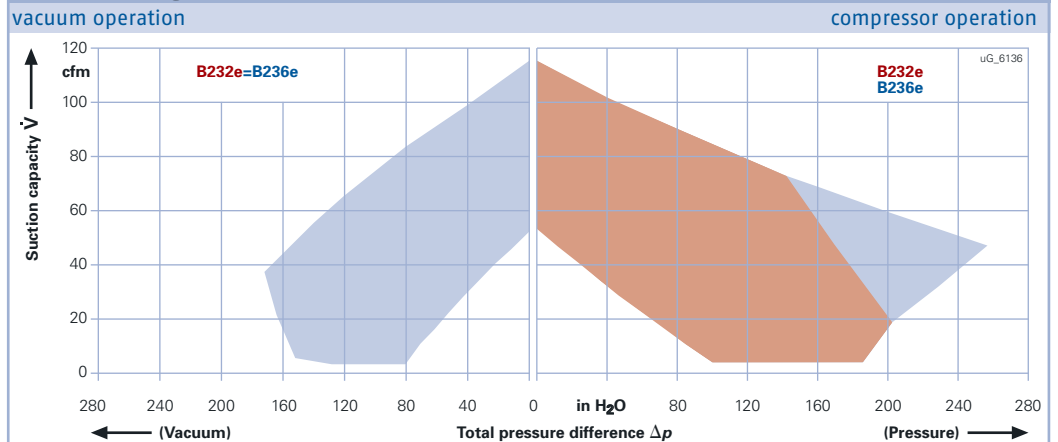

Selection diagrams 2BH7 520-...

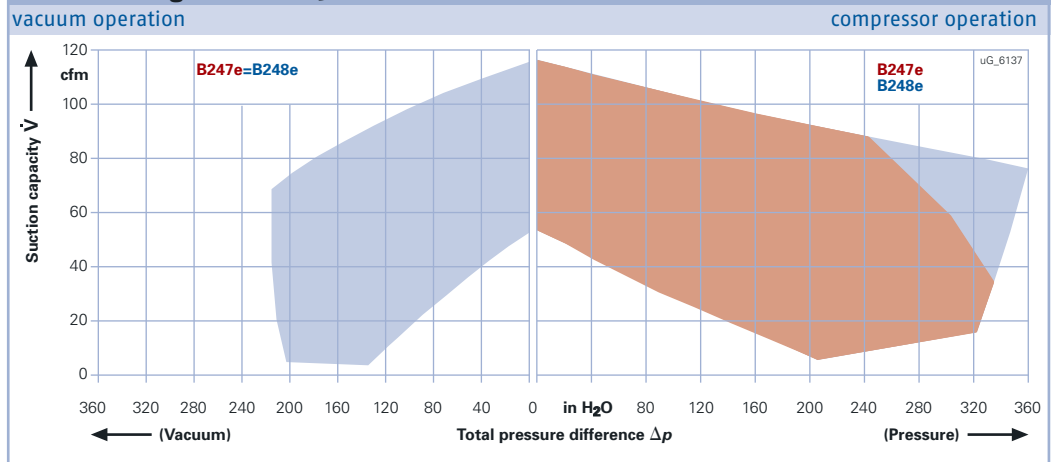

The performance curves are valid for pumping air at 60 °F (15 °C) at the inlet flanges with an air pressure of 29,9 in Hg abs. (1,013 mbar) and a tolerance of ±10%. The total pressure differences are valid up to an intake and ambient temperature of 77 °F (25 °C).

Selection and ordering information for 3 AC, 45....65 Hz, 360-550 V, IP55

Curve no.	Rated performance P (in hp)	Speed range min ⁻¹	Order no.			Sound-pressure level ¹⁾ dB(A)
			Gas ring compressor with integrated FC	Gas ring compressor for external FC	external FC	
B263e	7.4	2,200 ... 5,000	2BH7 610-0AN31-8	2BH7 610-0AH36-8	2FC4 552-2NE00	77
B265e	14.8	2,200 ... 5,000	–	2BH7 610-0AH56-8	2FC4 113-2NE00	77
B273e	7.4	2,200 ... 5,000	2BH7 620-0AN31-8	2BH7 620-0AH36-8	2FC4 552-2NE00	80
B275e	14.8	2,200 ... 5,000	–	2BH7 620-0AH56-8	2FC4 113-2NE00	80
B285e	14.8	2,200 ... 5,000	–	2BH7 630-0AH56-8	2FC4 113-2NE00	80
B286e	20.1	2,200 ... 5,000	–	2BH7 630-0AH66-8	2FC4 153-2NE00	80

Selection diagrams 2BH7 610-...

vacuum operation

compressor operation

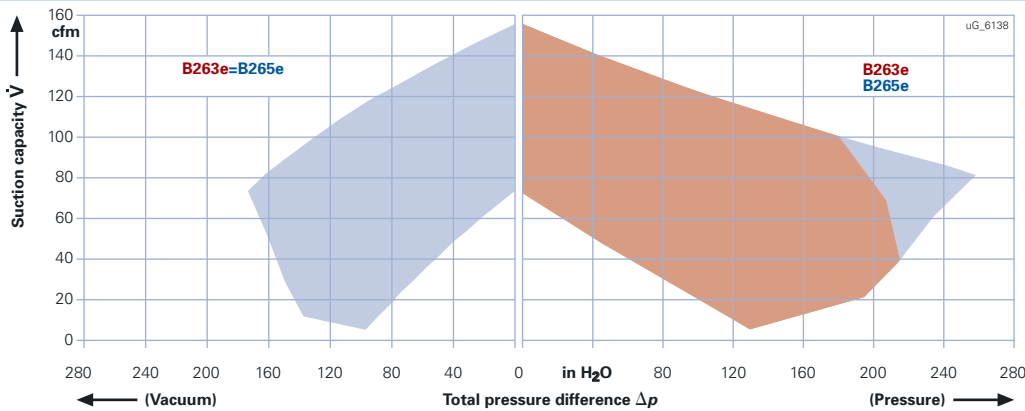

Selection diagrams 2BH7 620-...

vacuum operation

compressor operation

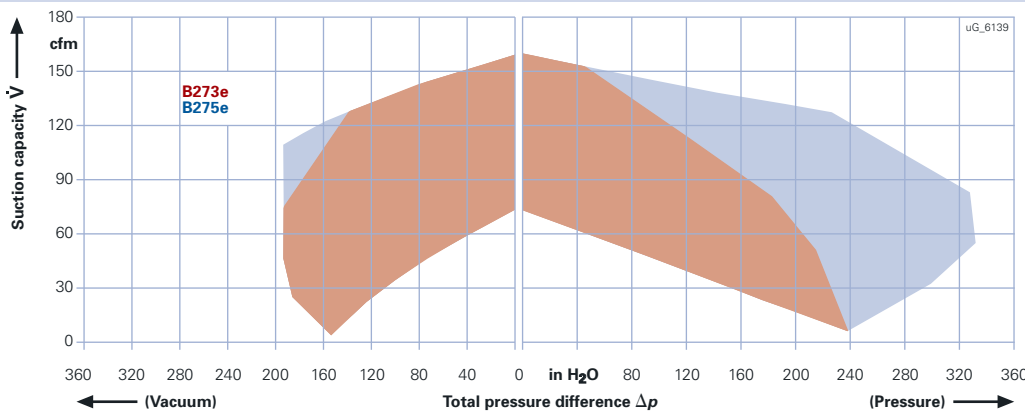

Selection diagrams 2BH7 630-...

vacuum operation

compressor operation

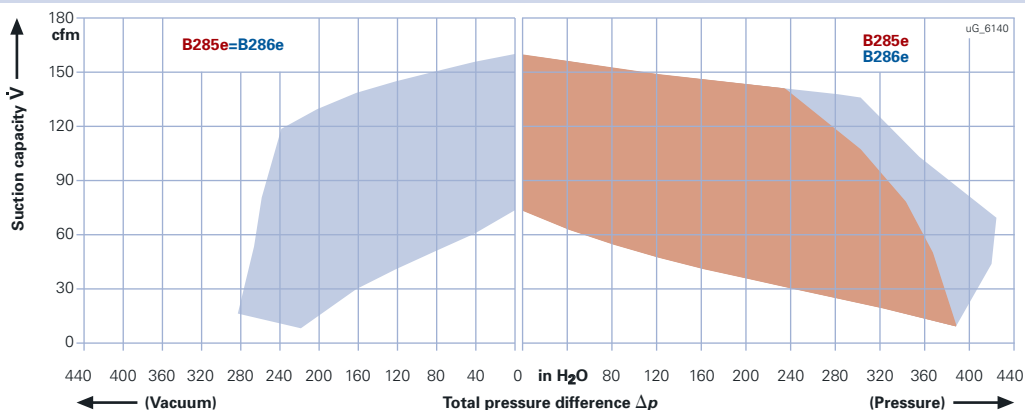

The performance curves are valid for pumping air at 60 °F (15 °C) at the inlet flanges with an air pressure of 29,9 in Hg abs. (1,013 mbar) and a tolerance of $\pm 10\%$. The total pressure differences are valid up to an intake and ambient temperature of 77 °F (25 °C).

Acces



series

Accessories for **G_Series** 2BH1 and 2BH7
Filters, sound protection hoods, flanges, valves...

Selection and ordering details accessories
for G_200 and G_400

pages 36 - 43

Accessories for pumps & compressors G_Series 2BH1 / 2BH7

Example



Particle size:
Paper: 7 - 9 µm
Polyester: 3 µm

Selection and ordering data			
	For type	Order no.	Weight approx. lbs
In line filter for vacuum pumps ¹⁾			
- incl. mounting kit for fixed installation: gasket, threaded flange, double pipe nipple, pipe elbow and through-filter	Paper filter insert 2BH1 1./3.	2BX2 060	6.0
	2BH7 2.-...0./-...1./-...2./-...4. 2BH7 3 / 7 4/ 7 5/ 7 6 2BH7 2.-...5./-...6./-...7./-...8.	2BX2 060 2BX4 060	6.0 6.0
- incl. gasket, hose flange, double reduction nipple through-filter and hose clips, but excluding the connecting hose between filter and vacuum pump	Polyester filter insert 2BH1 1./3.	2BX4 082	6.0
	Paper filter insert 2BH1 2. / 2BH1 40.-...0./-...1./-...2. 2BH1 49 / 2BH1 5/ 1 6. 2BH1 40.-...3. / -...4. 2BH1 41	2BX2 061 2BX2 064	11.0 11.0
- incl. reduction nipple, through-filter and hose clips excl. connecting hose between filter and vacuum pump	Polyester filter insert 2BH1 2 2BH1 40.-...0./-...1./-...2. 2BH1 49 / 2BH1 5/ 1 6 2BH1 40.-...3./-...4. 2BH1 41	2BX4 081 2BX4 083	11.0 11.0
	Paper filter insert 2BH1 8. Polyester filter insert 2BH1 8.	2BX2 063 2BX4 084	12.1 12.1
- incl. connecting flange, gasket, adapting nipple, through-filter, hose clips and connecting hose between filter and vacuum pump	Paper filter insert 2BH1 90/ 91 2BH1 94	2BX2 065 2BX2 066	44.1 48.5
	Polyester filter insert 2BH1 90/ 91 2BH1 94	2BX4 085 2BX4 086	44.1 48.5
Replacement filter elements			
for in line filters Order Example: EWN:5014022002	Paper filter insert 2BX2 060 2BX2 061/ 063/ 064 2BX2 065/ 066	501 40220 02 501 40220 04 501 40220 05	0.9 1.3 1.8
	Polyester filter insert 2BX4 082 2BX4 081/ 083/ 084 2BX4 085/ 086	501 40000 03 501 40002 01 501 40220 15	0.9 1.3 1.8
for suction filters Order Example: EWN:5014022001	Paper filter insert 2BX2 100 2BX2 101/ 102/ 107/ 108 2BX2 103/ 104	501 40220 01 501 40220 02 501 40220 03	0.9 1.1 1.3
	Polyester filter insert 2BX4 062 2BX4 061/ 063/ 064 2BX4 065/ 066 2BX4 085/ 086	501 40001 01 501 40000 03 501 40220 13 501 40220 15	0.9 1.1 1.3 1.8

Example

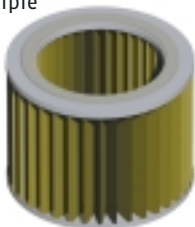

¹⁾ All filters are suitable only for separation with dry air and cannot be used for liquids.
Installation must be made to ensure that no water can enter the filter.

Selection and ordering data



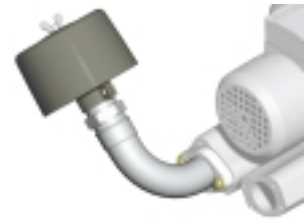

	For type	Order no.	Weight approx. lbs
Suction filter for compressors¹⁾			
- incl. mounting kit: gasket, threaded flange pipe elbow and, according to G_Series type, spigot, adaptor flange, nipple and reducing coupling	Paper filter insert 2BH1 1./ 3.	2BX2 100	3.1
	Polyester filter insert 2BH1 1./ 3.	2BX4 062	3.1
	Paper filter insert 2BH1 2. / 2BH1 40.-...0./ -...1./ -...2. 2BH1 49	2BX2 101	6.6
	Polyester filter insert 2BH1 2. / 2BH1 40.-...0. / -...1. / -...2. 2BH1 49	2BX4 061	6.6
	Paper filter insert 2BH1 40.-...3./ -...4. 2BH1 41	2BX2 107	6.6
	Polyester filter insert 2BH1 40.-...3./ -...4. 2BH1 41	2BX4 063	6.6
	Paper filter insert 2BH1 5./ 60/ 61/ 69	2BX2 102	6.0
	Polyester filter insert 2BH1 5. / 60 / 61 / 69	2BX4 064	6.0
	Paper filter insert 2BH1 64	2BX2 103	11.2
	Polyester filter insert 2BH1 64	2BX4 065	11.2
	Paper filter insert 2BH1 8.	2BX2 104	11.2
	Polyester filter insert 2BH1 8.	2BX4 066	11.2
	Paper filter insert 2BH7 2.-...1./ -...2./ -...4. 2BH7 3. / 4.	2BX2 100	3.1
	Polyester filter insert 2BH7 2.-...1./ -...2./ -...4. 2BH7 3/4.	2BX4 062	3.1
	Paper filter insert 2BH7 5./ 6. 2BH7 2.-...5./ -...6./ -...7./ -...8.	2BX4 080	3.1
	Paper filter insert 2BH7 5./ 6.	2BX2 108	6.6
	Paper filter insert 2BH7 2.-...N1./ -..N2./ -..N4.	2BX2 100	3.1
	Paper filter insert 2BH7 2.-...N5. / -..N6. / -..N7. / -..N8.	2BX4 080	3.1
	Paper filter insert 2BH7 3.-...N.. 2BH7 4.-...N.. 2BH7 5.-...N.. 2BH7 6.-...N..	2BX2 108	6.6

Example



Particle size:
Paper: 7 - 9 µm
Polyester: 3 µm

Accessories for pumps & compressors G_Series 2BH1 / 2BH7

Selection and ordering data					
	For type	Order no.	Weight approx. lbs		
Example 	- incl. connecting flange, gasket, adapting nipple, through-filter, hose clips and connecting hose between filter and vacuum pump	Paper filter insert 2BH1 90/ 91	2BX2 065	44.1	
		2BH1 94	2BX2 066	48.5	
		Polyester filter insert 2BH1 90/ 91	2BX4 085	44.1	
		2BH1 94	2BX4 086	48.5	
Suction-side through-filter ¹⁾					
Example 	- for floor mounting (1 set = 4 retaining washers, 4 fixing screws M 12 x 20 and 5 clamping devices)	2BH1 943	2BX2 124	7.7	
90° elbow					
Example 	- incl. gasket and screws	2BH1 310	2BX4 313²⁾	2.0	
		2BH1 410	2BX4 314²⁾	3.1	
		2BH1 510/ 1610	2BX4 315²⁾	5.3	
		2BH1 910	2BX4 319²⁾	13.7	
1 set of feet					
Example 	- for vertical mounting on the end-cover (1 set = 3 pieces)	2BH1 2.	-	-	
		2BH1 1./ 3./ 4.	2BX2 120	0.3	
		2BH1 5.	2BX2 121	0.3	
		2BH1 6.	2BX2 122	1.0	
		2BH1 8.	2BX2 123	3.1	
		2BH1 90./ 91.	2BX2 123	3.1	
		2BH7 2.	2BX2 135	0.3	
		2BH7 3./ 4.	2BX2 127	0.3	
		2BH7 5./ 6.	2BX2 128	0.4	
		- for horizontal mounting on the feet (1 set = 4 pieces)	2BH1 1./ 2./ 3./ 4.	2BX4 100	0.3
			2BH1 5.	2BX4 101	0.3
			2BH1 6.	2BX4 102	0.3
2BH1 8.	2BX4 103		1.0		
2BH1 90./ 91.	2BX4 104		3.1		

¹⁾ All filters are suitable only for separation with dry air and cannot be used for liquids. Installation must be made to ensure that no water can enter the filter.

²⁾ If you wish to order this together with the pump, please add a "Z" to the order number of the pump and the additional information "C21" as follows in this example:

2BH1 310-7HH26-Z
C21

Selection and ordering data

	For type	Order no. ¹⁾	Dimensions inch			Weight approx. lbs
			Width	Height	Length	
Sound protection hoods for G_200						
For applications in noise-sensitive areas we have designed a special sound protection hood for the G_200.	2BH1 300-7..0.	2BX4 321	20.47	19.88	29.53	77
	2BH1 300-7..1.	2BX4 322				
These hoods offer a reduction in sound pressure levels audible for the human ear of up to 10 dB(A). Tonal peaks that are especially unpleasant can be lowered by up to 20 dB.	2BH1 310-7..2.	2BX4 323				
	2BH1 400-7..0.	2BX4 324				
	2BH1 400-7..1./-7..2.	2BX4 325				
	2BH1 410-7..3./-7..4.	2BX4 326				
	2BH1 490-7..1.	2BX4 325				
	2BH1 500-7..0./-7..1.	2BX4 327	22.83	21.85	33.46	95
	2BH1 500-7..2./-7..3.	2BX4 328				
	2BH1 510-7..4.	2BX4 350				
	2BH1 510-7..5.	2BX4 329				
	2BH1 590-7..1./-7..2.	2BX4 328				
They can be installed both inside and outside. We also supply the sound protection hood already integrated with the compressor or pump. ²⁾	2BH1 600-7..1.	2BX4 330	24.21	24.02	36.42	108
	2BH1 600-7..2.	2BX4 331				
Advantages at a glance: <ul style="list-style-type: none"> ■ Reduction of sound pressure levels of up to 10 dB (A) ■ The tonal peaks that are least pleasant can be considerably reduced ■ Easy to install ■ Weather resistant (for use outdoors) ■ Maintenance-free ■ Can be supplied with compressor ■ Available at short notice 	2BH1 600-7..3.	2BX4 332				
	2BH1 610-7..1.	2BX4 333				
	2BH1 610-7..2.	2BX4 334				
	2BH1 610-7..3.	2BX4 335				
	2BH1 610-7..4./-7..5.	2BX4 336				
	2BH1 610-7..7.	2BX4 337				
	2BH1 640-7..1./-7..2./-7..3.	2BX4 338				
	2BH1 640-7..4./-7..5.	2BX4 339				
	2BH1 690-7..1./-7..2.	2BX4 331				
	2BH1 800-7..0.	2BX4 340	27.56	30.31	42.52	201
	2BH1 800-7..1./-7..2.	2BX4 341				
	2BH1 810-7..2.	2BX4 342				
	2BH1 810-7..3./-7..4.	2BX4 343				
	2BH1 900-7..0.	2BX4 346	32.28	32.28	47.64	236
	2BH1 900-7..1./-7..2./-7..3.	2BX4 347				
	2BH1 910-7..1./-7..2./-7..3.	2BX4 348				
	2BH1 943-7..2.	2BX4 351	30.71	64.17	39.76	324
2BH1 943-7..3.	2BX4 352					
2BH1 943-7..4.	2BX4 349					

1) Order number of the sound protection hood for separate delivery

2) "If you wish to order this together with the pump, please add a "Z" to the order number of the pump and the additional information "Z22" as follows in this example:

2BH1 310-7HH26-Z
Z22

Example



Accessories for pumps & compressors G_Series 2BH1 / 2BH7

Example

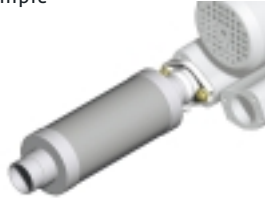

Selection and ordering data					
	For type	Silencing	Order no.	Ø	Weight approx. lbs
Additional silencer					
- incl. gasket, hose flange, hose clip, and screws The silencing is measured with average throttling and hose connected to the suction side vacuum pump (or to the discharge side of the compressor) in an echochamber according to DIN 45635 part 2	2BH1 20	4dB	2BX4 010		1.3
	2BH1 10 / 30	6dB	2BX4 011		1.1
	2BH1 31	5dB			
	2BH1 40-...0./-...1./-...2.	5dB	2BX4 010		1.3
	2BH1 49	4dB			
	2BH1 40-...3./-...4.	5dB	2BX4 015		1.3
	2BH1 41.	4dB			
	2BH1 50	6dB	2BX4 010		1.3
	2BH1 51	5dB			
	2BH1 60	7dB	2BX4 010		1.3
	2BH161/ 2BH1 64	6dB			
	2BH1 8	8dB	2BX4 012		4.6
	2BH1 81/ 2BH1 84	7dB			
	2BH1 90	3dB	2BX4 013		8.8
	2BH1 91	3dB			
	2BH1 94	3dB	2BX4 014		23.1
	2BH7 2-...1./-...2./-...4.	4dB	2BX1 031		1.0
	2BH7 3/ 7 4/ 7 5/ 7 6				
	2BH7 2-...5./-...6./-...7./-...8.	4dB	2BX4 000		1.0
	Threaded flange				
- incl. gasket and screws	2BH1 1./ 3.		2BX1 037	G1 ¹ / ₄	0.5
	2BH1 2.		2BX1 038	G1 ¹ / ₂	1.0
	2BH1 40-...0./-...1./-...2 / 2BH1 49				
	2BH1 4-...3./-...4./ 2BH1 41		2BX1 040	G1 ¹ / ₂	1.0
	2BH1 5./ 1 6.		2BX1 041	G2	1.0
	NPT conical				
	2BH1 5./ 16.		2BX4 041	NPT2	1.0
	2BH1 90/ 91		2BX1 042	G4	3.5
	NPT conical				
	2BH1 90/ 91		2BX4 042	NPT4	3.5
	2BH1 94		2BX1 043	G5	13.0
	NPT conical				
	2BH1 94		2BX4 043	NPT5	13.0
2BH7 2-...1./-...2./-...4.		2BX1 037	G1 ¹ / ₄	0.5	
2BH7 3/ 7 4/ 7 5/ 7 6					
2BH7 2-...5.		2BX4 040	G1 ¹ / ₄	0.5	
Hose flange					
- incl. gasket and screws	2BH1 2.		2BX1 033		0.2
	2BH1 40-...0./-...1./-...2.				
	2BH1 49./ 2BH1 5.				
	2BH1 1./ 3.		2BX1 032		0.2
	2BH1 40-...3./-...4./ 2BH1 41		2BX1 034		0.3
	2BH1 6.		2BX1 036		0.4
	2BH1 8.		2BX1 047		0.9
	2BH1 90./ 91.		2BX1 048		5.7
	2BH1 94.		2BX1 046		16.5
	2BH7 2-...1./-...2./-...4.		2BX1 032		0.2
	2BH7 3/ 7 4/ 7 5/ 7 6				
	2BH7 2-...5./-...6./-...7./-...8.		2BX4 020		0.2

Example



Example



Selection and ordering data

	For type	Order no.	Weight approx. lbs		
Vacuum relief valve – suction side ¹⁾					
- with adaptor, gasket and screws	for 50 Hz operation: 2BH1 3./ 1 4. 2BH1 5./ 1 6.	2BX2 141 ■ 2BX2 145 ■	1.1 1.1		
	2BH7 2...-...1./ -...2./ -...4. 2BH7 3./ 7 4. / 7 5./ 7 6. 2BH7 2...-...5.	2BX2 141 ■ 2BX2 171 ■	1.1 1.1		
	for 60 Hz operation: 2BH1 3. / 14. 2BH1 5. / 16.	2BX2 142 ■ 2BX2 146 ■	1.1 1.1		
	2BH7 2...-...1./ -...2./ -...4. 2BH7 3./ 7 4/ 7 5/ 7 6 2BH7 2...-...5.	2BX2 142 ■ 2BX2 172 ■	1.1 1.1		
	Pressure relief valve – discharge side ¹⁾				
	- with adaptor, gasket and screws	for 50 Hz operation: 2BH1 3./ 1 4. 2BH1 5./ 1 6. 2BH7 2...-...1./ -...2./ -...4. 2BH7 3./ 7 4/ 7 5/ 7 6 2BH7 2...-...5.	2BX2 143 ■ 2BX2 147 ■ 2BX2 143 ■ 2BX2 173 ■	1.1 1.1 1.1 1.1	
		for 60 Hz operation: 2BH1 3. / 14. 2BH1 5. / 16. 2BH7 2...-...1./ -...2./ -...4. 2BH7 3./ 7 4/ 7 5/ 7 6. 2BH7 2...-...5.	2BX2 144 ■ 2BX2 148 ■ 2BX2 144 ■ 2BX2 174 ■	1.1 1.1 1.1 1.1	
		Loose vacuum relief valve – suction side ¹⁾			
		– for pipeline mounting	for 50 Hz operation: 2BH1 3. to 2BH1 8. 2BH1 900-...1./ -...3. 2BH1 910-...2./ -...3./ -...4. 2BH1 930-...3. 2BH1 943-...4. 2BH1 900-...0. 2BH1 910-...1. 2BH1 930-...0./ -...1. 2BH1 943-...2./ -...3.	2BX2 110 ■ 2BX2 150 ■ 2BX2 152 ■ 2BX2 110 ■	0.7 30.9 59.5 0.7
			for 60 Hz operation: 2BH1 3 to 2BH1 6 2BH1 80 / 81 2BH1 840-...3. 2BH1 900-...1./ -...3. 2BH1 910-...3. 2BH1 910-...2. 2BH1 930-...3. 2BH1 840-...2. 2BH1 900-...0. 2BH1 910-...1. 2BH1 930-...0./ -...1. 2BH1 943-...3./ -...4. 2BH1 943-...2.	2BX2 114 ■ 2BX2 150 ■ 2BX2 152 ■ 2BX2 154 ■ 2BX2 114 ■	0.7 30.9 59.5 119.0 0.7

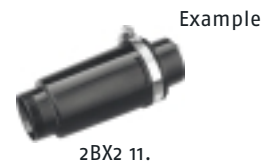
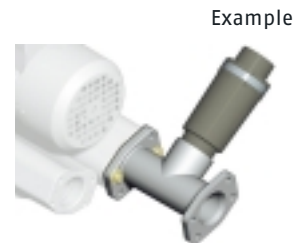
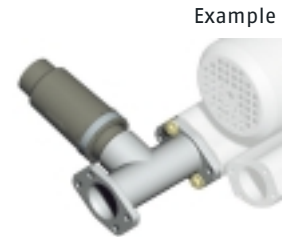



¹⁾ For the required quantity see pages 13, 17 and 29.

■ The suffix „-Z“ must be added to the Order No., and the Order No. of the machine must be given

Example: 2BX2 110-Z

MLFB=2BH1 800-7AH06

Accessories for pumps & compressors G_Series 2BH1 / 2BH7

Selection and ordering data					
	For type	Order no.	Weight approx. lbs		
Loose pressure relief valve – discharge side ¹⁾					
– for pipeline mounting					
Example  2BX2 11.	for 50 Hz operation: 2BH1 3 to 2BH1 6 2BH1 80 / 81 2BH1 840-...3. 2BH1 900-...1./-...3. 2BH1 910-...3./-...4. 2BH1 930-...3. 2BH1 840-...2. 2BH1 900-...0. 2BH1 910-...1./-...2. 2BH1 930-...0./-...1. 2BH1 943-...2./-...3./-...4. 2BH7	2BX2 111 ■	0.7		
		2BX2 151 ■	17.6		
		2BX2 153 ■	39.7		
		2BX2 111 ■	0.7		
		Example  2BX2 15.	for 60 Hz operation: 2BH1 3 to 2BH1 6 2BH1 80 / 81 2BH1 900-...3. 2BH1 840-...3. 2BH1 900-...1. 2BH1 910-...3./-...4. 2BH1 930-...3. 2BH1 840-...2. 2BH1 900-...0. 2BH1 910-...1./-...2. 2BH1 930-...0./-...1. 2BH1 943-...4. 2BH1 943-...2./-...3. 2BH7	2BX2 115 ■	0.7
				2BX2 151 ■	17.6
				2BX2 153 ■	39.7
				2BX2 155 ■	72.8
				2BX2 115 ■	0.7

Selection and ordering data					
Solenoid valves (incl. adaptor, if necessary for mounting)	Supply voltage / Rated current	For type	Order no.	Weight approx. kg	
Changeover valve					
Example  Single spool for changeover from vacuum to pressure operation Load factor: 100 % Operating time: ≤ 0.35 s Release time: ≤ 0.4 s	24 V DC 1.5 A	2BH1 30-7	2BX9 328-0MA0	5.5	
		2BH1 40-7	2BX9 328-0MM00	6.6	
		2BH1 49-7	2BX9 328-0ME0	5.5	
	230 V AC 50/60 Hz 0.16 A	2BH1 31. to 2BH1 91.	on request		
		2BH1 30-7	2BX9 328-0MA1	5.5	
		2BH1 40-7	2BX9 328-0MM10	6.6	
Double spool for change over from / to vacuum. pressure or idling operation Load factor: 100 % Operating time: ≤ 0.35 s Release time: ≤ 0.4 s	24 V DC 0.8 A	2BH1 30-7	2BX9 328-0MB0	5.5	
		2BH1 40-7	2BX9 328-0MD0	5.5	
		2BH1 31. to 2BH1 91.	on request		
	230 V AC 50/60 Hz 0.14 A	2BH1 30-7	2BX9 328-0MB1	5.5	
		2BH1 40-7	2BX9 328-0MD1	5.5	
		2BH1 31. to 2BH1 91.	on request		

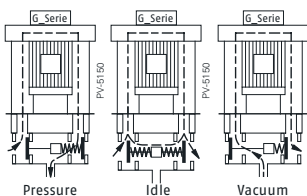

Selection and ordering data

Solenoid valves (incl. adaptor, if necessary for mounting)	Supply voltage / Rated current	For type	Order no.	Weight approx. lbs	
Changeover valve					
- for changeover from vacuum to pressure operation Load factor: 100 % Operating time: ≤ 0.35 s Release time: ≤ 0.4 s	24 V DC 1.0 A	2BH1 50.-7..0/ 1. 2BH1 59.-7..1. 2BH1 50.-7..2/ 3. 2BH1 59.-7..2.	2BX9 328-0ML00 2BX9 328-0ML02	21.2 15.4	
		2BH1 60.-7..0/ 1./ 2. 2BH1 60.-7..3. 2BH1 64.-7..3. 2BH1 69.-7..1./ 2.	2BX9 328-0ML02 2BX9 328-0MP03 2BX9 328-0MR03 2BX9 328-0ML02	15.4 11.2 18.7 15.4	
		2BH1 31. to 2BH1 91.	on request		
		230 V AC 50/60 Hz 0.13 A	2BH1 50.-7..0/ 1. 2BH1 59.-7..1. 2BH1 50.-7..2/ 3. 2BH1 59.-7..2. 2BH1 60.-7..0/ 1./ 2.	2BX9 328-0ML10 2BX9 328-0ML12 2BX9 328-0ML12	21.2 15.4 15.4
		2BH1 60.-7..3. 2BH1 64.-7..3. 2BH1 69.-7..1./ 2.	2BX9 328-0MP13 2BX9 328-0MR13 2BX9 328-0ML12	11.2 18.7 15.4	
		2BH1 31. to 2BH1 91.	on request		
	- for changeover from vacuum to pressure operation Load factor: 100 % Operating time: ≤ 0.35 s Release time: ≤ 0.4 s	24 V DC 1.0 A	2BH7 .1.	2BX9 328-1MC0	6.2
		230 V AC 50/60 Hz 0.13 A	2BH7 .1.	2BX9 328-1MC1	6.2
	- for changeover from vacuum to pressure operation Load factor: 100 % Operating time: ≤ 0.35 s Release time: ≤ 0.4 s	24 V DC o.r.	2BH1 80/ 81 2BH1 90/ 91	on request	
		230 V AC 50/60 Hz o.r.	2BH1 80/ 81 2BH1 90/ 91	on request	
Switch-over valve					
- to switch between two different pressure/vacuum pipelines with the same flow direction or flow interruption with one conveyor pipeline Load factor: 100 % Operating time: ≤ 0.35 s Release time: ≤ 0.4 s	24 V DC 2.4 A	2BH1 5/ 1 6	2BX9 328-0MJ0	10.6	
	230 V AC 50/60 Hz 0.5 A	2BH1 5/ 1 6	2BX9 328-0MJ1	10.6	

Example

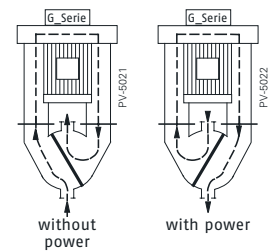

Example

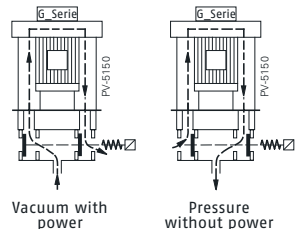

Example

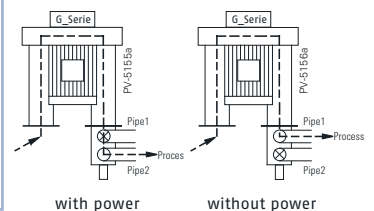

Dimens

ions

Dimension drawings for

G_200	Pages 46 - 53
G_200e	Page 54
G_400	Pages 56 - 57
G_400e	Page 58
Accessories	Pages 59 - 63

Dimensions

Dimensions for 2BH1 10., 2BH1 20., 2BH1 30., 2BH1 40., 2BH1 49. (inch)

2BH1 200

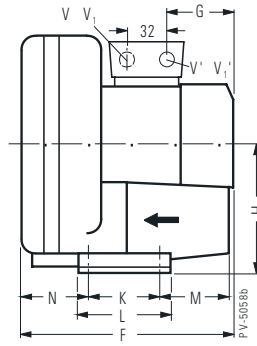
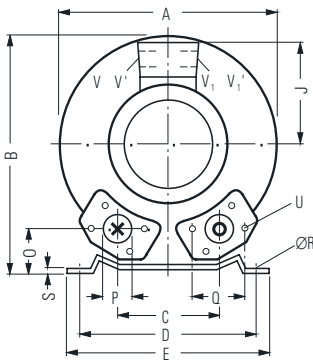

2BH1 10. / 2BH1 30. / 2BH1 40. / 2BH1 49.

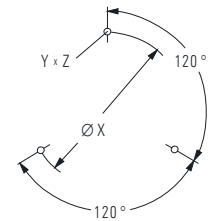
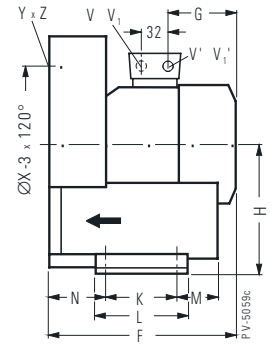
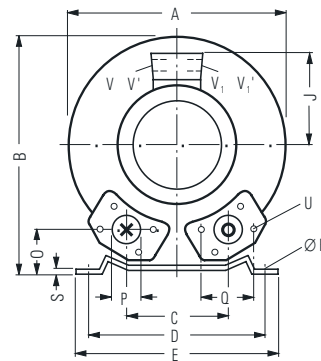

Hole pattern, cover

Type	Phases	Curve no.	A	B	C	D	E	F	G	H	J	K	L	M	N	O	P	Q	Ø R
2BH1 200 - 7AA0. - 2AB0. - 7AH0.	1 ~ 3 ~	A120s A121s A120/121	9.17	9.84	4.33	8.07	9.06	9.61	3.78 3.54 3.62	5.35	3.98	3.27	4.25	3.94	2.95	2.05	G11/2 (.59 deep)	2.83	0.39
2BH1 30. - 7A.1. 2BH1 10. - 7A.0. und 2BH1 30. - 7A.0. - 7A.1.	1 ~ 3 ~	A132s/133s A130/131 A132/133	9.69	9.72	3.54			10.08	5.24 8.62 10.08	5.04	4.37			2.95	2.80	1.54	G11/4 (.59 deep)	2.52	
2BH1 40. - 7A.1. - 7A.2.	1 ~	A162s/163s A164s/165s	11.22	11.89	4.53	8.86	10.04	11.50	6.14	6.06	4.72	3.74	5.12	2.76	2.95	1.81	G11/2 (.59 deep)	2.83	0.47
2BH1 40. - 7A.0. - 7A.1. - 7A.2.	3 ~	A160/161 A162/163 A164/165						10.59 11.50	5.08 6.02		4.72								
2BH1 49. - 7AA1. - 7AB1. - 7AH1.	1 ~ 3 ~	A150s A151s A150/151							6.14 6.02										
Type	Phases	Curve no.	S	U	V (1 ~)	V' (1 ~)	V ₁ (3 ~)	V' ₁ (3 ~)	Y x Z	X-holes	Ø X								
2BH1 200 - 7AA0. - 2AB0. - 7AH0.	1 ~ 3 ~	A120s A121s A120/121	0.10	M 6 x 19	M 16 x 1.5	M 25 x 1.5 Pg 11	— —	— —	— —	— —	— —								
2BH1 30. - 7A.1. 2BH1 10. - 7A.0. und 2BH1 30. - 7A.0. - 7A.1.	1 ~ 3 ~	A132s/133s A130/131 A132/133		M 6 x 17	M 16 x 1.5	M 25 x 1.5	— —	— —	M 6 x 15	0°/120°/240°	Ø 5.51								
2BH1 40. - 7A.1. - 7A.2.	1 ~	A162s/163s A164s/165s	0.12	M 6 x 19	M 16 x 1.5	M 25 x 1.5	— —	— —	— —	— —	Ø 6.85								
2BH1 40. - 7A.0. - 7A.1. - 7A.2.	3 ~	A160/161 A162/163 A164/165			— — —	— — —	— — —	— — —	— — —	— — —	— — —								
2BH1 49. - 7AA1. - 7AB1. - 7AH1.	1 ~ 3 ~	A150s A151s A150/151			M 16 x 1.5	M 25 x 1.5	— —	— —	— —	— —	— —								

Dimensions for 2BH1 31., 2BH1 41. (inch)

2BH1 31. / 2BH1 41.

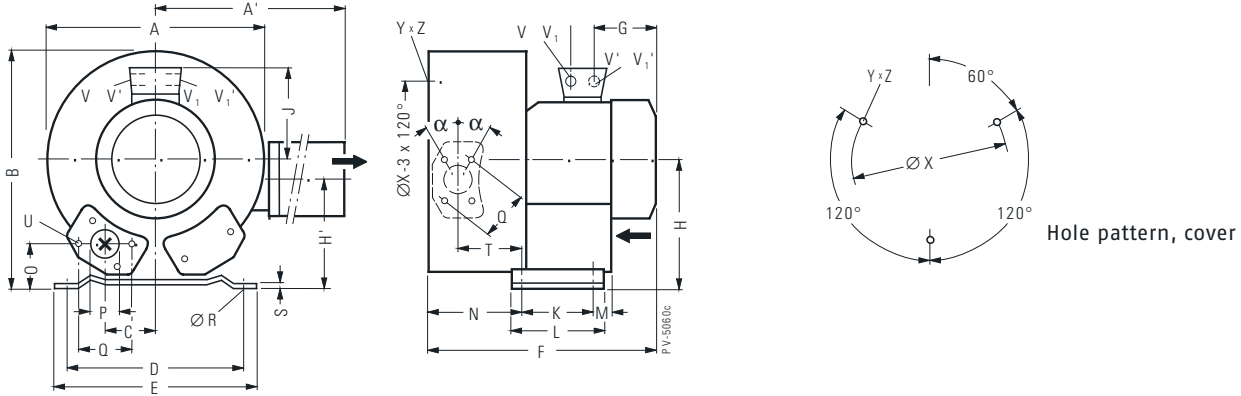

Type	Phases	Curve no.	A	A'	B	C	D	E	F	G	H	H'	J	K	L	M	N	O	P	Q
2BH1 31. - 7H.2.	3 ~	A140/141	11.18	12.44	10.63	1.77	8.07	9.06	12.44	5.08	5.04	4.17	4.37	3.27	4.25	2.95	5.12	1.54	G1 ¹ / ₄ (.59 deep)	2.52
2BH1 41. - 7H.3.	3 ~	A170/171	12.64	12.64	12.40	2.28	8.86	10.04	15.79	7.28	6.06	6.06	5.04	3.74	5.12	2.76	5.94	1.81	G1 ¹ / ₂ (.59 deep)	2.83
- 7H.4.		A172/173																		
Type	Phases	Curve no.	Ø R	S	T	U	V (1 ~)	V' (1 ~)	V ₁ (3 ~)	V' ₁ (3 ~)	a	Ø X	Y x Z	X-holes						
2BH1 31. - 7H.2.	3 ~	A140/141	0.39	0.10	3.46	M 6 x 17	-	-	M 25 x 1,5	M 16 x 1,5	27°	5.51	M 6 x 15	51°/171°/291°						
2BH1 41. - 7H.3.	3 ~	A170/171	0.47	0.12	4.17	M 6 x 19	-	M 25 x 1,5	M 16 x 1,5		28°	6.58	M 6 x 15							
- 7H.4.		A172/173				-	-	-	-											

2BH1 31. / 2BH1 41.

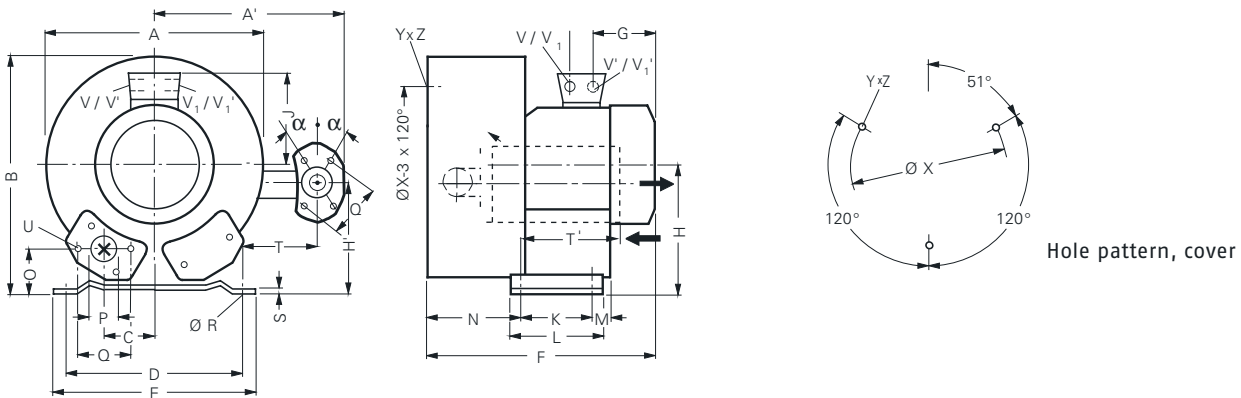

Type	Phases	Curve no.	A	A'	B	C	D	E	F	G	H	H'	J	K	L	M	N	O	P
2BH1 31. - 7H.2.	Z 3 ~	A140/141	11.18	16.50	10.63	1.77	8.07	9.06	12.44	5.08	5.04	4.17	3.86	3.27	4.25	2.95	5.12	1.54	G1_x0.6
2BH1 41. - 7H.3.	Z 1 ~ / 3 ~	A170/171/171s	12.64	12.09	12.44	2.28	8.86	10.04	15.79	7.28	6.06	6.06	5.04	3.74	5.12	2.76	5.98	1.81	G1_x0.6
- 7H.4.	Z 1 ~ / 3 ~	A172/173/172s/173s	12.64	12.09	12.44	2.28	8.86	10.04	15.79	7.28	6.06	6.06	5.04	3.74	5.12	2.76	5.98	1.81	G1_x0.6
Type	Phases	Curve no.	Q	Ø R	S	T	T'	U	V / V ₁	V' / V' ₁	α	Ø X	Y x Z	X-holes					
2BH1 31. - 7H.2.	3 ~	A140/141	2.52	0.39	0.10	5.75	6.85	M 6 x 0.7	M 25 x 1,5	M 16 x 1,5	27°	5.51	M 6 x 0.6	51°/171°/291°					
2BH1 41. - 7H.3.	3 ~	A170/171	2.84	0.47	0.10	6.26	6.38	M 6 x 0.8	M 16 x 1,5	M 25 x 1,5	28°	6.85	M 6 x 0.6	51°/171°/291°					
- 7H.4.		A172/173	2.84	0.47	0.10	6.26	6.38	M 6 x 0.8	M 25 x 1,5	M 16 x 1,5	28°	6.85	M 6 x 0.6	51°/171°/291°					

▲ Z = C 21, outlet elbow

Dimensions

Dimensions for 2BH1 50., 2BH1 59., 2BH1 60., 2BH1 69. (inch)

2BH1 50. / 2BH1 59.
2BH1 60. / 2BH1 69.

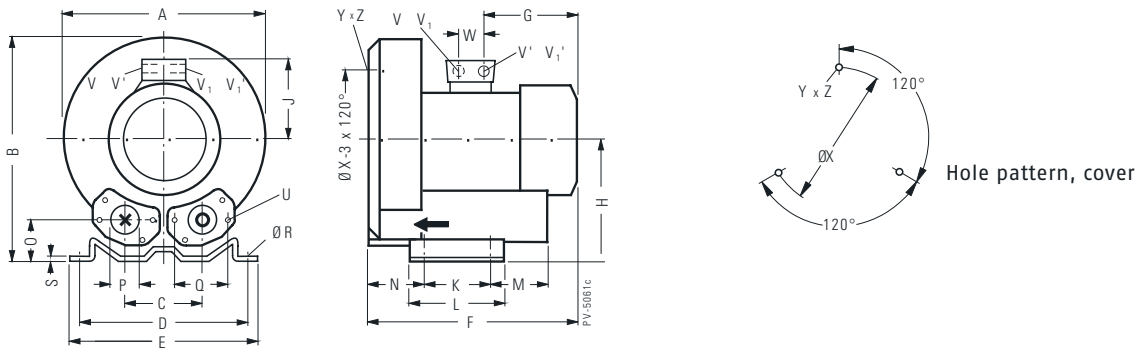

Type	Phases	Curve no.	A	B	C	D	E	F	G	H	J	K	L	M	N	O	P	Q	Ø R
2BH1 50. - 7A.1.	1 ~	A192s/193s	13.15	13.27	4.72	10.24	11.61	12.32	6.14	6.89	4.72	4.53	6.10	3.78	3.43	1.89	2.17	3.27	0.55
		A196s/197s						13.58	7.40		5.04								
2BH1 50. - 7A.0.	3 ~	A190/191						12.36	6.02		4.72								
		A192/193																	
		A194/195						13.62	7.28		5.04								
2BH1 59. - 7AA2.	1 ~	A180s					11.61	13.58	7.40	6.87									0.59
		A181s																	
	3 ~	A180						12.36	6.02		4.72								
		A181						13.58	7.28		5.04								
2BH1 60. - 7A.0.	3 ~	A220	15.04	15.12	4.92	11.42	12.80	14.84		7.80		5.51	7.09	3.31	4.29	2.13			
		A222/223																	
		A224/225						16.18	7.48		5.31								
2BH1 69. - 7A.1.	3 ~	A210						14.84	3.35		5.04								
		A210/211									5.31								
Type	Phases	Curve no.	S	U	V (1 ~)	V' (1 ~)	V ₁ (3 ~)	V' ₁ (3 ~)	Ø X	Y x Z	X-holes	W							
2BH1 50. - 7A.1.	1 ~	A192s/193s	0.16	M 8 x 17	M 16 x 1.5	M 25 x 1.5	—	—	7.87	M 8 x 20	0°/120°/240°	1.26							
		A196s/197s					—	—											
2BH1 50. - 7A.0.	3 ~	A190/191			—	—	M 25 x 1.5	M 16 x 1.5											
		A192/193			—	—													
		A194/195			—	—													
2BH1 59. - 7AA2.	1 ~	A180s			M 16 x 1.5	M 25 x 1.5	—	—											
		A181s					—	—											
	3 ~	A180			—	—	M 25 x 1.5	M 16 x 1.5											
		A181			—	—													
2BH1 60. - 7A.0.	3 ~	A220	0.18		—	—			9.45	M 10 x 20									
		A222/223			—	—	—	—											
		A224/225			M 32 x 1.5	M 32 x 1.5	M 32 x 1.5	M 32 x 1.5				1.65							
2BH1 69. - 7A.1.	3 ~	A210			—	—	M 25 x 1.5	M 16 x 1.5				1.26							
		A210/211			M 32 x 1.5	M 32 x 1.5	M 32 x 1.5	M 32 x 1.5				1.65							

Dimensions for 2BH1 51., 2BH1 61., 2BH1 64. (inch)

2BH1 61.-...4.
-...5.

2BH1 51.
2BH1 61.-...1.
-...2.
-...3.

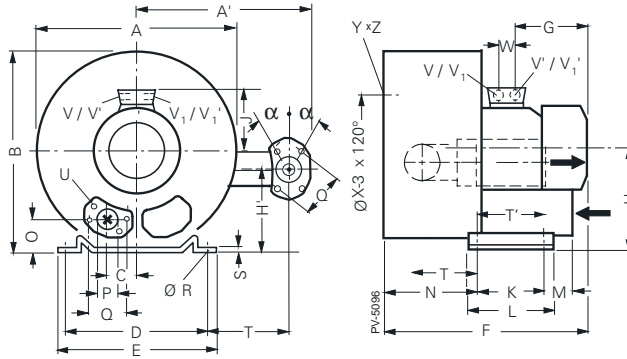
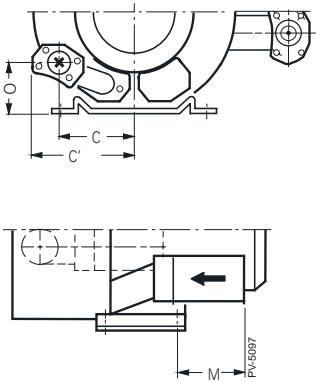

Hole pattern, cover

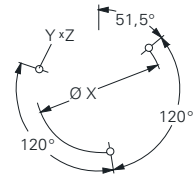

Type	Phases	Curve no.	A	A'	B	C	C'	D	E	F	G	H	H'	J	K	L	M	N	O
2BH1 51. -7H.1.-Z	3~	A200/201	14.65	14.53	14.69	2.36	-	10.24	11.61	19.49	7.48	6.89	5.67	5.32	4.53	6.10	3.86	6.73	1.89
2BH1 51. -7H.5.-Z	3~	A202/203	14.65	14.53	14.69	2.36	-	10.24	11.61	19.65	8.82	6.89	5.67	5.32	4.53	6.10	3.86	6.73	1.89
2BH1 61. -7H.1.-Z	3~	A230/231	16.73	14.88	16.54	2.48	-	11.41	12.80	18.62	7.09	7.80	6.42	5.59	5.51	7.09	3.31	8.07	2.13
2BH1 61. -7H.2.-Z	3~	A232/233	16.73	14.88	16.54	2.48	-	11.41	12.80	18.62	7.09	7.80	6.42	5.59	5.51	7.09	3.31	8.07	2.13
2BH1 61. -7H.3.-Z	3~	A234/235	16.73	14.88	16.54	2.48	-	11.41	12.80	18.62	7.09	7.80	6.42	5.59	5.51	7.09	3.31	8.07	2.13
2BH1 61. -7H.4.-Z	3~	A236/237	16.73	14.88	16.54	6.06	7.72	11.41	12.80	18.62	7.09	7.80	6.42	5.59	5.51	7.09	3.31	8.07	3.70
2BH1 61. -7H.5.-Z	3~	A238/239	16.73	14.88	16.54	6.06	7.72	11.41	12.80	18.62	7.09	7.80	6.42	5.59	5.51	7.09	3.31	8.07	3.70
Type	Phases	Curve no.	Ø P	Q	Ø R	S	T	T'	U	V/V ₁	V'/V' ₁	α	Ø X	Y x Z	X-holes	W			
2BH1 51. -7H.4.-Z	3~	A200/201	2.17	3.27	0.55	0.16	7.80	9.21	M8x0.67	M32x1.5	M32x1.5	23.5°	7.87	M8x0.79	51°/171°/291°	1.65			
2BH1 51. -7H.5.-Z	3~	A202/203	2.17	3.27	0.55	0.16	7.80	9.21	M8x0.67	M32x1.5	M32x1.5	23.5°	7.87	M8x0.79	51°/171°/291°	1.65			
2BH1 61. -7H.1.-Z	3~	A230/231	2.17	3.27	0.59	0.18	7.56	8.70	M8x0.67	M25x1.5	M16x1.5	23.5°	9.45	M10x0.79	51°/171°/291°	1.26			
2BH1 61. -7H.2.-Z	3~	A232/233	2.17	3.27	0.59	0.18	7.56	8.70	M8x0.67	M25x1.5	M16x1.5	23.5°	9.45	M10x0.79	51°/171°/291°	1.65			
2BH1 61. -7H.3.-Z	3~	A234/235	2.17	3.27	0.59	0.18	7.56	8.70	M8x0.67	M32x1.5	M32x1.5	23.5°	9.45	M10x0.79	51°/171°/291°	1.65			
2BH1 61. -7H.4.-Z	3~	A236/237	2.17	3.27	0.59	0.18	7.56	8.70	M8x0.67	M32x1.5	M32x1.5	23.5°	9.45	M10x0.79	51°/171°/291°	1.65			
2BH1 61. -7H.5.-Z	3~	A238/239	2.17	3.27	0.59	0.18	7.56	8.70	M8x0.67	M32x1.5	M32x1.5	23.5°	9.45	M10x0.79	51°/171°/291°	1.65			

▲ Z = C 21, outlet elbow

Dimensions

Dimensions for 2BH1 51., 2BH1 61., 2BH1 64. (inch)

2BH1 61.-...4.
-...5.

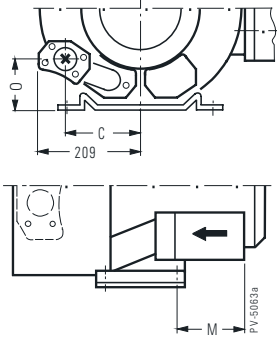

2BH1 51.
2BH1 61.-...1.
-...2.
-...3.

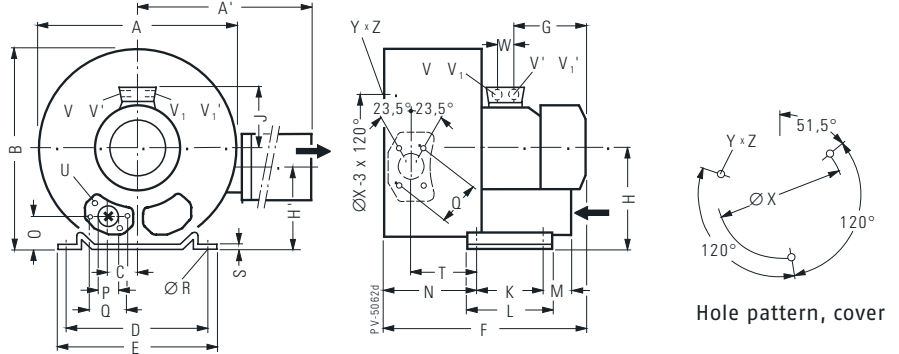

Type	Curve no.	A	A'	B	C	D	E	F	G	H	H'	J	K	L	M	N	O	Ø P	Q
2BH1 51. - 7H.4.	A200/201	14.65	16.18	14.61	2.36	10.24	11.61	18.31	7.48	6.89	5.67	5.31	4.53	6.10	3.86	6.73	1.89	2.17	3.27
	- 7H.5.	A202/203						19.65	8.82										
2BH1 61. - 7H.1.	A230/231	16.77	16.69	16.54	2.48	11.42	12.80	18.62	7.28	7.80	6.46	5.04	5.51	7.09	3.31	8.07	2.13		
	- 7H.2.	A232/233						19.96	7.48			5.31							
	- 7H.3.	A234/235						20.79	8.31			5.83							
	- 7H.4.	A236/237				6.06		22.44	8.86			6.57			8.86		3.70		
	- 7H.5.	A238/239																	

Type	Curve no.	Ø R	S	T	U	V	V'	V ₁	V' ₁	Ø X	Y x Z	X-holes	W
2BH1 51. - 7H.4.	A200/201	0.55	0.16	4.57	M 8 x 17					7.87	M 8 x 20	51.5°/171.5°/291.5°	1.65
	- 7H.5.	A202/203						4 x M 32 x 1.5					
2BH1 61. - 7H.1.	A230/231	0.59	0.18	5.08	M 8 x 17	M 25 x 1.5	M 16 x 1.5	-	-	9.45	M 10 x 20		1.26
	- 7H.2.	A232/233						-	-				1.65
	- 7H.3.	A234/235						4 x M 32 x 1.5					
	- 7H.4.	A236/237											
	- 7H.5.	A238/239											

2BH1 64.-...4.
-...5.

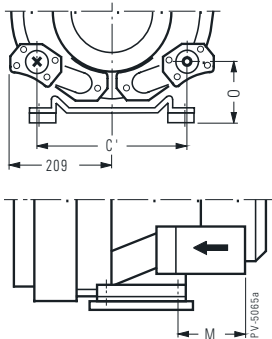

2BH1 64.-...3.

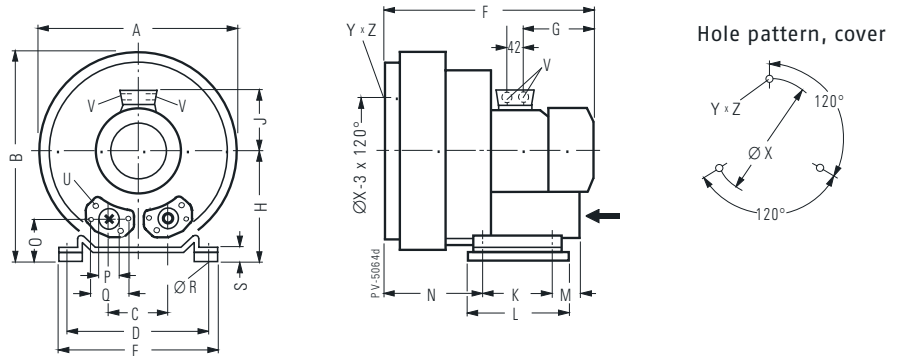

Type	Curve no.	A	B	C	C'	D	E	F	G	H	J	K	L	M	N
2BH1 64. - 7G.3.	A260/261	16.69	16.93	4.92	-	11.42	12.80	20.79	8.31	8.58	5.83	5.51	7.40	3.31	8.07
	- 7G.4.	A262/263				12.17		22.40	8.82		6.57			8.86	
	- 7G.5.	A264/265													

Type	Curve no.	O	Ø P	Q	Ø R	S	U	V	Ø X	Y x Z	X-holes
2BH1 64. - 7G.3.	A260/261	2.91	2.17	3.27	0.59	0.96	M 8 x 17	4 x M 32 x 1.5	9.45	M 10 x 20	0°/120°/240°
	- 7G.4.	A262/263	4.49								
	- 7G.5.	A264/265									

Dimensions for 2BH1 80., 2BH1 81., 2BH1 84. (inch)

2BH1 80.

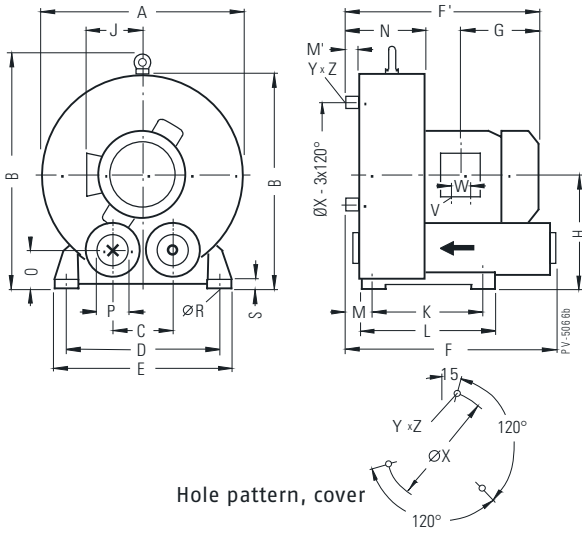

2BH1 81.

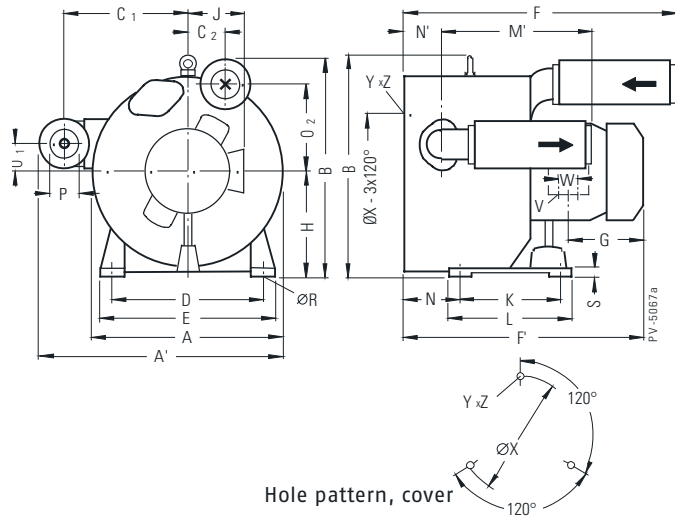

Type	Curve no.	A	A'	B	B'	C	C1	C2	D	E	F	F'	G	H	J	K	L	M	M'	N
2BH1 80. - 7A.0.	A270/271	19.61	-	20.24	22.32	5.71	-	-	14.37	16.54	19.49	18.50	8.31	10.43	5.83	11.02	12.44	1.38	0.39	6.69
- 7A.1.	A272/273										19.41	8.82		6.57						
- 7A.2.	A274/275																			
2BH1 81. - 7H.1.	A280/281	19.72	25.04	20.31	-	12.52	2.70		23.66	23.54								15.83	5.53	
- 7H.2.	A282/283																			
- 7H.3.	A284/285						2.87		28.58	27.05	11.46									
- 7H.4.	A286/287																			
Type	Curve no.	N'	O	O ₁	O ₂	Ø P	Ø R	S	V	W	Ø X	Y x Z	X-holes							
2BH1 80. - 7A.0.	A270/271	-	3.19	-	-	2 1/2" F-NPT	0.59	0.87	2 x Pg 21	1.65	16.06	M 12 x 20	15°/135°/255°							
- 7A.1.	A272/273																			
- 7A.2.	A274/275																			
2BH1 81. - 7H.1.	A280/281	4.09	-	2.60	7.32	2 1/2" F-NPT			4 x M 52 x 1.5				0°/120°/240°							
- 7H.2.	A282/283																			
- 7H.3.	A284/285				9.21				4 x M 40 x 1.5	2.13										
- 7H.4.	A286/287																			

2BH1 84 1.

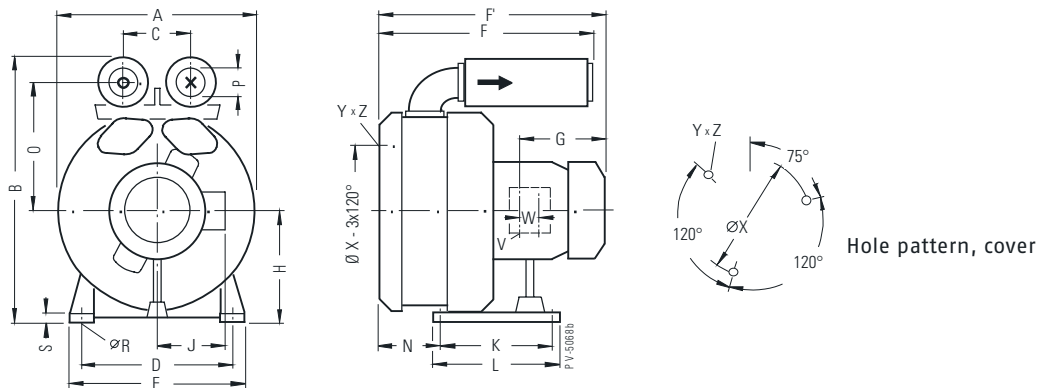

Type	Curve no.	A	B	C	D	E	F	F'	G	H	J	K	L	N
2BH1 84. - 7J.2.	A320/321	19.61	25.67	6.30	14.37	16.54	20.51	23.54	8.82	10.43	6.58	11.02	12.44	5.55
- 7J.3.	A322/323							27.05	11.46		7.76			
Type	Curve no.	O	Ø P	Ø R	S	V	W	Ø X	Y x Z	X-holes				
2BH1 84. - 7J.2.	A320/321	12.52	2 1/2" F-NPT	0.59	0.87	4 x M 32 x 1.5	1.65	16.06	M 12 x 20	75°/195°/315°				
- 7J.3.	A322/323					4 x M 40 x 1.5	2.13							

Dimensions

Dimensions for 2BH1 91., 2BH1 90. (inch)

2BH1 91.

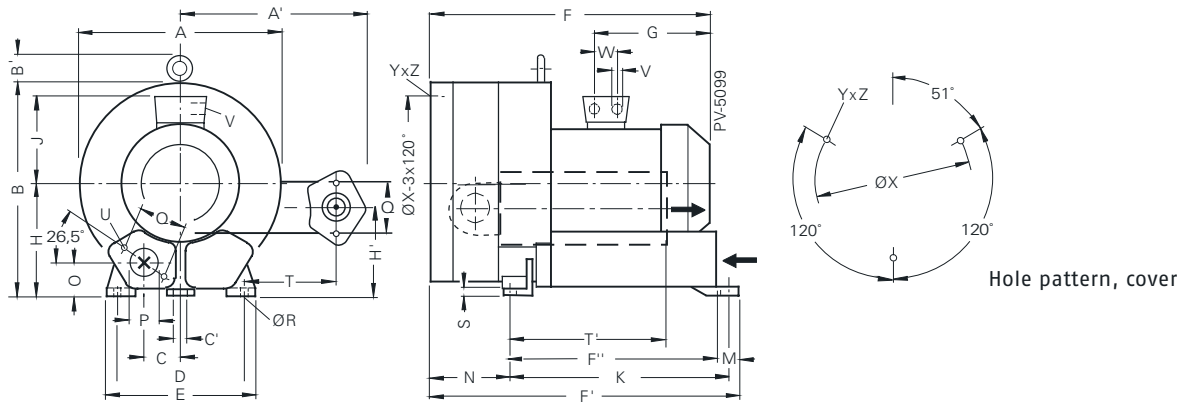

Type	Phases	Curve no.	A	A'	B	B'	C	C'	D	E	F	F'	F''	G	H	H'	J	K	M	N
2BH1 91.-7H.1.-Z	3~	A340/341	22.05	20.59	22.40	2.48	4.09	0.59	14.17	16.34	30.12	33.86	26.02	9.65	11.81	9.67	7.65	23.47	1.69	9.53
2BH1 91.-7H.2.-Z	3~	A342/343	22.05	20.59	22.40	2.48	4.09	0.59	14.17	16.34	30.12	33.86	26.02	9.65	11.81	9.67	7.65	23.47	1.69	9.53
2BH1 91.-7H.3.-Z	3~	A344/345	22.05	20.59	22.40	2.48	4.09	0.59	14.17	16.34	30.12	33.86	26.02	9.65	11.81	9.67	7.65	23.47	1.69	9.53
Type	Phases	Curve no.	Ø	P	Q	Ø R	S	T	U	V	W	Ø X	Y x Z	X-holes						
2BH1 91.-7H.1.-Z	3~	A340/341	3.58	3.94	5.91	0.59	0.98	3.74	M 12 x 1.2	M40 x 1.5	2.13	19.29	M 12 x 1.2	51°/171°/291°						
2BH1 91.-7H.2.-Z	3~	A342/343	3.58	3.94	5.91	0.59	0.98	3.74	M 12 x 1.2	M40 x 1.5	2.13	19.29	M 12 x 1.2	51°/171°/291°						
2BH1 91.-7H.3.-Z	3~	A344/345	3.58	3.94	5.91	0.59	0.98	3.74	M 12 x 1.2	M40 x 1.5	2.13	19.29	M 12 x 1.2	51°/171°/291°						

▲ Z = C 21, outlet elbow

2BH1 90. / 1 930

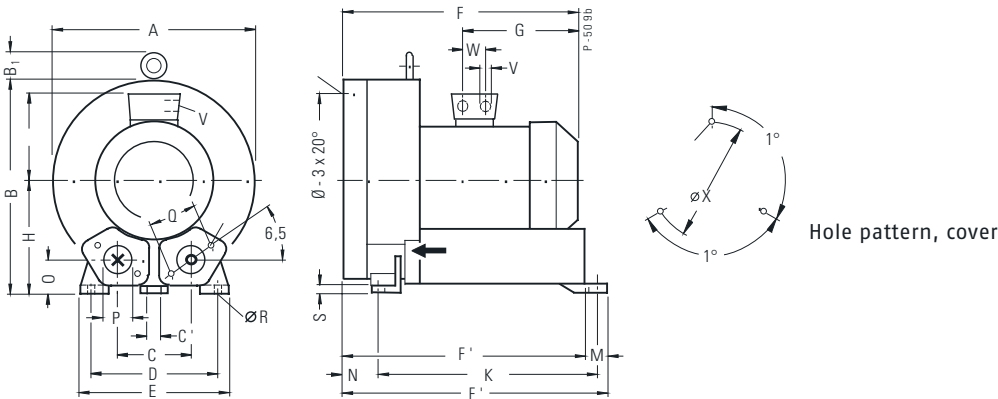

Type	Curve no.	A	B	B1	C	C'	D	E	F	F'	F''	G	H	J	K	M	N
2BH1 90. und																	
2BH1 93. - 7A.0.	A330/331/350/351	21.85	22.44	2.44	8.15	0.59	14.17	16.34	21.38	28.58	26.54	10.47	11.81	6.57	23.47	2.05	4.25
- 7A.1.	A332/333/352/353								24.84			13.58		7.76			
- 7A.3.	A334/335/354/355																
Type	Curve no.	Ø	P	Q	Ø R	S	U	V	W	Ø X	Y x Z	X-holes					
2BH1 90. und																	
2BH1 93. - 7A.0.	A330/331/350/351	3.58	3.94	5.91	0.59	0.98	M 12 x 30	4 x M32 x 1.5	1.65	19.29	M 12 x 30	0°/120°/240°					
- 7A.1.	A332/333/352/353							4 x M40 x 1.5	2.13								
- 7A.3.	A334/335/354/355																

Dimensions for 2BH1 91., 2BH1 943 (inch)

2BH1 91.

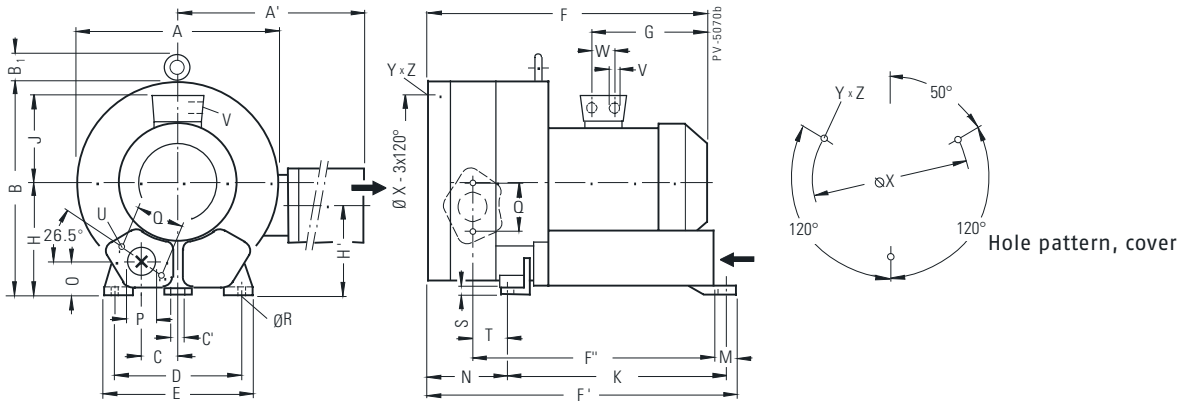

Type	Curve no.	A	A'	B	B1	C	C'	D	E	F	F'	F''	G	H	H'	J	K	M	
2BH1 91. - 7H.1.	A340/341	22.05	31.34	22.83	2.05	4.09	0.59	14.17	16.34	30.12	33.86	26.02	11.46	11.81	9.65	7.76	23.46	2.05	
- 7H.2.	A342/343																		
- 7H.3.	A344/345																		
Type	Curve no.	N	O	Ø P	Q	Ø R	S	T	U	V	W	Ø X	Y x Z	X-holes					
2BH1 91. - 7H.1.	A340/341	9.53	3.58	3.94	5.91	0.59	0.98	3.74	M 12 x 30	4 x M40 x 1.5	2.13	19.29	M 12 x 30	51.4°/171.4°/291.4°					
- 7H.2.	A342/343																		
- 7H.3.	A344/345																		

2BH1 943.

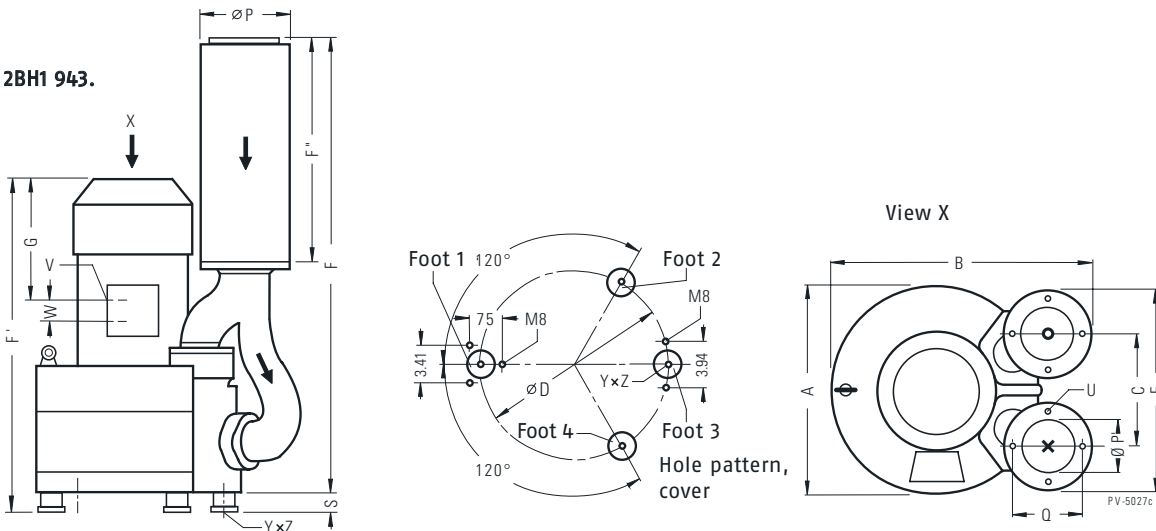

Type	Curve no.	A	B	C	D	E	F	F'	F''	G	P	P'
2BH1 943 - 7G.2.	A380/381	22.05	28.15	12.09	19.29	22.05	47.28	30.12	23.62	13.58	9.92	5.12
- 7G.3.	A382/383											
- 7G.4.	A384/385							33.27		15.16		
Type	Curve no.	Q	S	U	V	W	Y x Z					
2BH1 943 - 7G.2.	A380/381	8.27	1.57	M 16 x 30	2 x M 40 x 1.5	2.13	M 12 x 10.5					
- 7G.3.	A382/383											
- 7G.4.	A384/385											

2BH1 943

(only cover mounting possible)
 Dimensions for fixing elements
 2BX2 124 see page 52
 (not included in the scope of
 supply of the pump/compressor).

Dimensions

Dimensions for 2BH1 with converter (inch)

2BH1 400 ... 2BH1 600

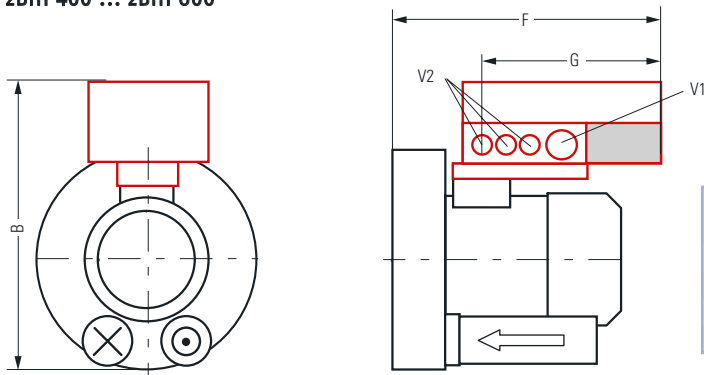

Type	Curve no.	A	B	F	G	V1	V2
2BH1 400-0AN21	A162e	-	15.83	12.80	7.01	M25+M20	3 x M16
2BH1 500-0AN31	A193e	-	16.71	17.38	10.94	M25	
2BH1 600-0AN31	A223e	-	18.56	18.74			
2BH1 800-0AN01	A270e	20.57	-	21.22			

2BH1 310 ... 2BH1 610

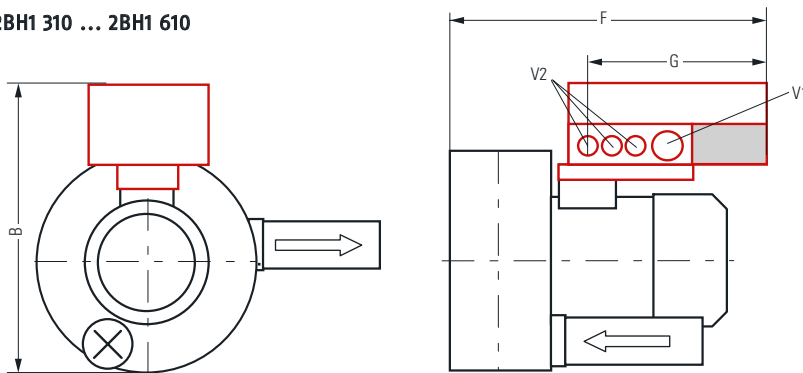

Type	Curve no.	A	B	F	G	V1	V2
2BH1310-0AN21	A142e	-	14.49	14.65	7.01	M25+M20	3 x M16
2BH1410-0AN41	A174e	-	15.59	19.55	10.94	M25	
2BH1510-0AN51	A205e	-	17.15	20.83			
2BH1610-0AN31	A233e	-	18.56	22.52		M25+M20	

2BH1 800

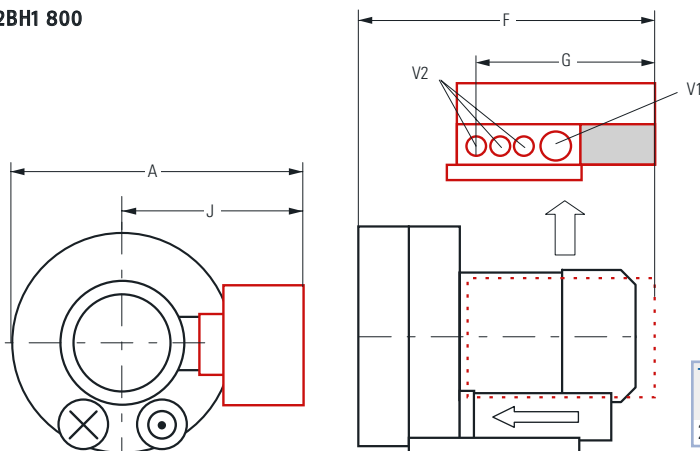

Type	Curve no.	A	B	F	G	V1	V2
2BH1 800-0AN01	A270e	20.57	-	21.22	10.94	M25	3 x M16

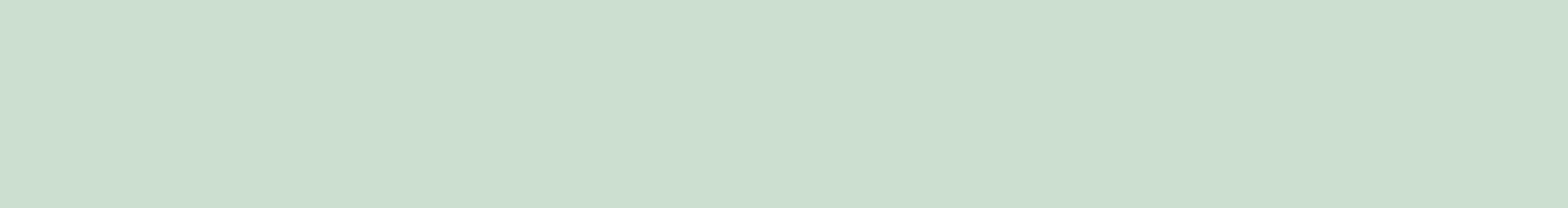

Dimensions

Dimensions for 2BH7 2., 2BH7 3., 2BH7 4., 2BH7 5., 2BH7 6. (inch)

Type	Curve no.	A	B	B'	B1	C	C2	D	E	F	G	H	H1	J	K	M	N	O	P
2BH7 210 - 0AH1.	B140/141	11.57	12.56	—	1.54	3.43	—	10.24	11.73	11.54	5.08	6.57	—	4.37	4.13	9.92	2.56	4.88	G 1 ¹ / ₄
2BH7 310 - 0AH1.	B170/171	12.32	13.35	—		3.70	—	11.42	12.80	11.61		6.97	—	4.72		10.08	2.64	5.12	(.71deep)
- 0AH2.	B172/173																		
2BH7 410 - 0AH1.	B200/201	13.62	14.76	—	1.50	4.06	—	12.40	13.78	12.64	6.02	7.68	—		5.12	10.24	2.60	5.63	
2BH7 510 - 0AH1.	B230/231	14.49	15.55	—	1.54	4.49	—	12.91	14.29	14.21	7.28	8.07	—	5.04	5.98	10.43	2.68	5.83	
- 0AH2.	B232/233																		
2BH7 610 - 0AH1.	B260/261	16.46	17.91	—		5.00	—	14.61	15.98	14.33	7.28	9.25	—			10.67	2.84	6.77	
- 0AH3.	B263/264									15.35	8.31								
2BH7 220 - 0AH2.	B150/151	12.32	12.84	14.13	—	—	1.69	10.24	11.73	18.46	5.12	6.57	10.71	4.37		16.77	9.49	4.84	G 1 ¹ / ₄
- 0AH5.	B152/153									20.67	7.28			5.04					(.71deep)
2BH7 320 - 0AH5.	B182/283	13.03	13.58	14.96	—	—	1.85	11.42	12.80	19.49	6.02	6.97	11.46	4.72		16.97	9.57	5.12	
2BH7 420 - 0AH2.	B210/211	14.29	14.84	16.30	—	—	2.05	12.40	13.78	20.83	7.09	7.68	12.56	5.04	5.12	17.17		5.63	
- 0AH5.	B212/213									21.81	8.31								
2BH7 520 - 0AH2.	B240/241	15.24	15.83	17.13	—	—	2.24	12.91	14.29	21.61	7.28	8.11	13.50	5.04	5.98	17.83	10.08	5.83	
- 0AH7.	B244/245									23.74	8.31			5.83					
2BH7 620 - 0AH3.	B270/271	17.40	17.99	19.49	—	—	2.48	14.65	15.98	22.76		9.29	15.31	5.04		18.03	10.20	6.81	
- 0AH5.	B272/273									25.31	9.76			5.83					
Type	Curve no.	Q	R	S1	S2	S3	T	T1	U	V	V 1	W	X	Y x Z					
2BH7 210 - 0AH1.	B140/141	2.52	0.55	0.16	5.51	1.22	4.13	4.21	M 6 x 17	M 25 x 1.5	M 16 x 1.5	1.26	6.02	M 6 x 15					
2BH7 310 - 0AH1.	B170/171						4.49	4.57											
- 0AH2.	B172/173																		
2BH7 410 - 0AH1.	B200/201						4.92	5.00					6.57						
2BH7 510 - 0AH1.	B230/231			0.20			5.39	5.43					7.56	M 8 x 15					
- 0AH2.	B232/233																		
2BH7 610 - 0Ah1.	B260/261						6.02	6.10					8.98						
- 0AH3.	B263/264																		
2BH7 220 - 0AH2.	B150/151	2.51		0.16			4.13	4.21					—	—					
- 0AH5.	B152/153												—	—					
2BH7 320 - 0AH5.	B182/283						4.49	4.57					—	—					
2BH7 420 - 0AH2.	B210/211						4.92	5.00					—	—					
- 0AH5.	B212/213												—	—					
2BH7 520 - 0AH2.	B240/241			0.20			5.39	5.43					1.65	—					
- 0AH7.	B244/245									2 x M 32 x 1.5			1.26	—					
2BH7 620 - 0AH3.	B270/271						6.02	6.10		M 25 x 1.5			1.65	—					
- 0AH5.	B272/273									2 x M 32 x 1.5			—	—					

Dimensions for 2BH7 63. (inch)

Type	Curve no.	A	B	B'	C2	D	E	F	G	H	H1	K	M	N
2BH7 630 - 0AH6..	B282/283	17.40	18.00	19.49	2.48	14.61	15.98	27.95	10.51	9.29	15.31	6.57	21.18	13.35
Type	Curve no.	O	P	Q	R	S1	S2	T	U	V	W1	W2		
2BH7 630 - 0AH6..	B282/283	6.77	G 1 ¹ / ₄ (.71 deep)	2.52	0.55	0.20	5.75	6.02	M 6 x 17	for M 32 x 1.5	1.65	5.51		

Dimensions for 2BH7 2., 2BH7 3., 2BH7 4., 2BH7 5., 2BH7 6. (inch)

2BH7 21. / 2BH7 31. / 2BH7 41. / 2BH7 51. / 2BH7 61.

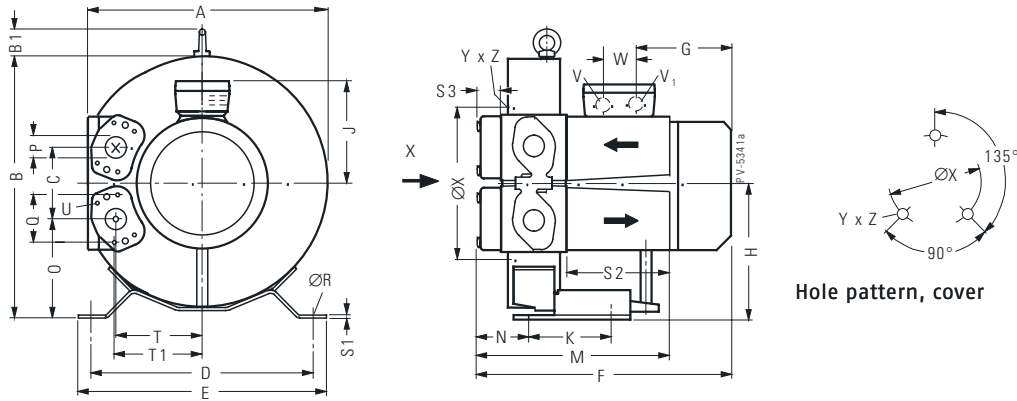

2BH7 22. / 2BH7 32. / 2BH7 42. / 2BH7 52. / 2BH7 62.

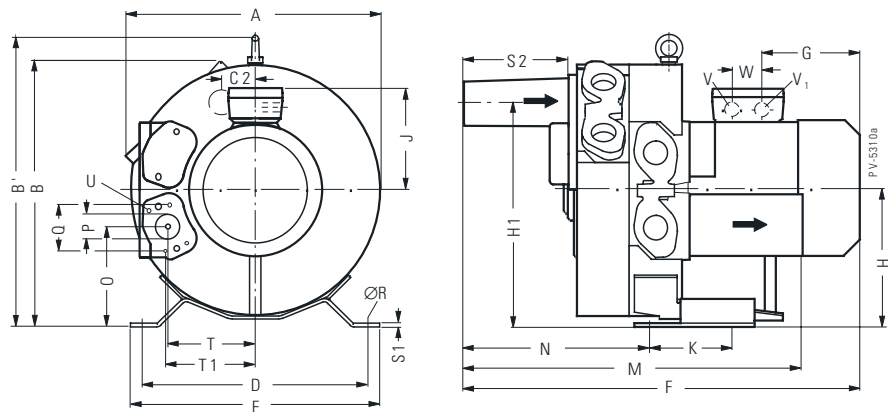

Dimensions for 2BH7 63. (inch)

2BH7 63.

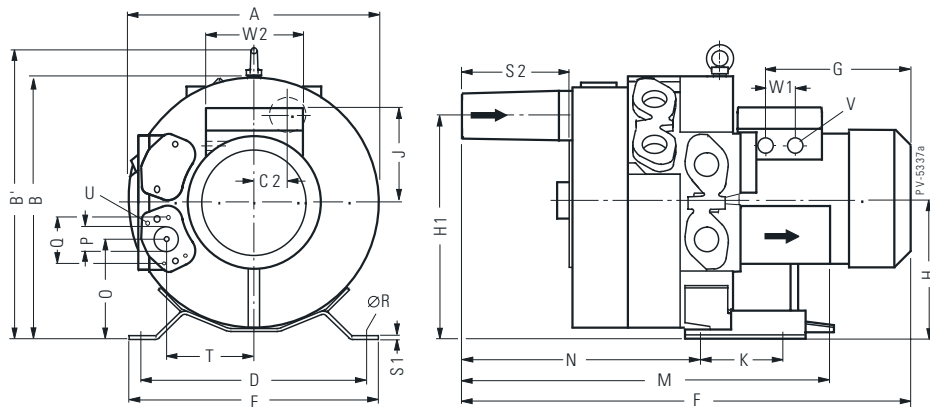

Dimensions

Dimensions for 2BH7 with converter (inch)

2BH7 210 ... 2BH7 610

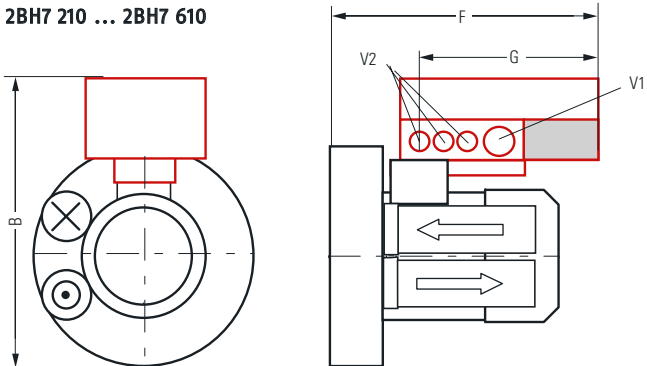

Type	Curve no.	B	F	G	V1	V2
2BH7 210-0AN11	B141e	16.02	13.74	7.01	M25+M20	3 x M16
2BH7 210-0AN51	B145e	16.40	18.48	10.95	M25	
2BH7 310-0AN21	B172e	16.42	13.82	7.01	M25+M20	
2BH7 310-0AN61	B176e	16.79	17.58	10.95	M25	
2BH7 410-0AN11	B201e	17.44	13.94	7.01	M25+M20	
2BH7 410-0AN51	B205e	17.50	16.06	10.95	M25	
2BH7 510-0AN21	B232e	17.89	17.97			
2BH7 510-0AN61	B236e	18.33	18.03			
2BH7 610-0AN31	B263e	19.07	16.54			

2BH7 220 ... 2BH7 620

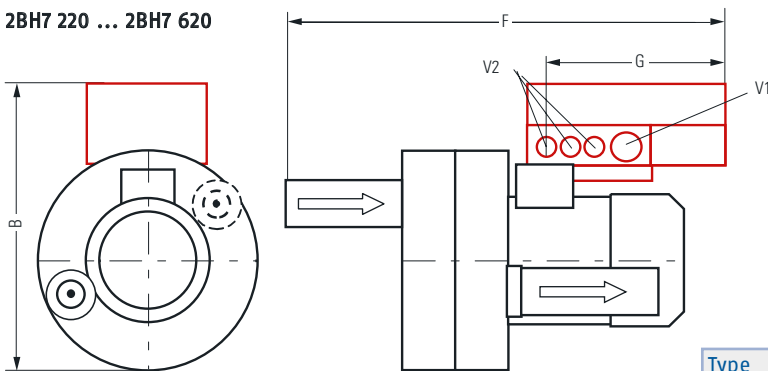

Type	Curve no.	B	F	G	V1	V2
2BH7 220-0AN51	B155e	16.40	24.43	11.30	M25	3 x M16
2BH7 320-0AN51	B185e	16.79	24.51			
2BH7 320-0AN81	B188e		22.91			
2BH7 420-0AN21	B212e	17.50	24.59			
2BH7 420-0AN51	B215e		22.99			
2BH7 520-0AN71	B247e	18.88	25.47			
2BH7 620-0AN31	B273e	19.11	23.94			

Dimensions for suction-side through-filter (inch)

2BX2 060
2BX4 060
2BX4 082

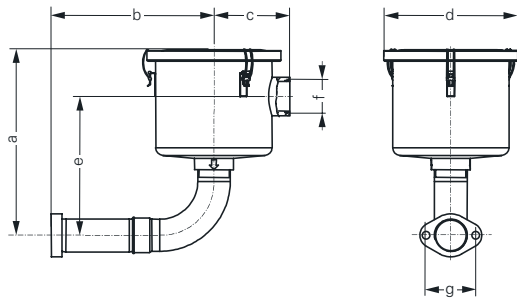

2BX2 061
2BX2 064
2BX4 081
2BX4 083

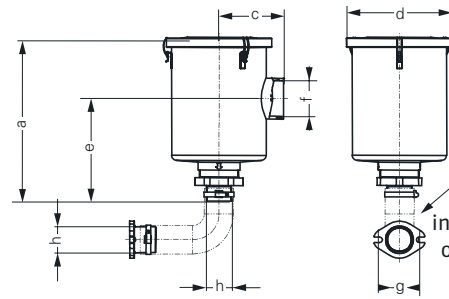

Not included in the scope of delivery!

2BX2 063
2BX4 084

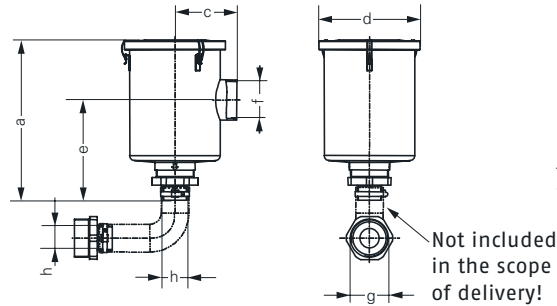

2BX2 065
2BX2 066
2BX4 085
2BX4 086

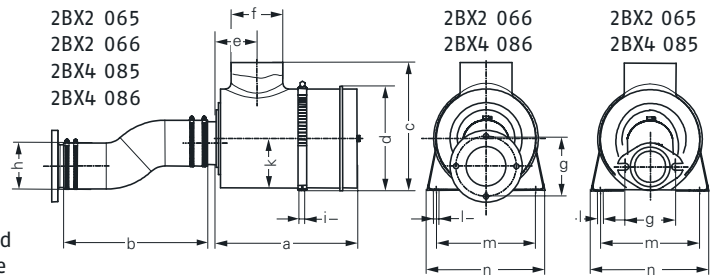

Type	a	b	c	d	e	f	g	h	i	k	l	m	n
2BX2 060 / 2BX4 060 / 2BX4 082	9.49	8.78	3.86	Ø6.81	7.09	G1 1/4	2.52	-	-	-	-	-	-
2BX2 061 / 2BX4 081 / 2BX2 064 / 2BX4 083	12.52	-	4.84	Ø7.91	7.83	G2 1/2	2.83	Ø1.97	-	-	-	-	-
2BX2 063 / 2BX4 084	12.52	-	4.84	Ø7.91	7.83	G2 1/2	G2 1/2	G1 1/2	-	-	-	-	-
2BX2 065 / 2BX4 085	19.29	19.69	17.52	Ø14.25	5.59	Ø7.09	5.91	Ø6.30	0.35	6.46	0.51	13.58	16.14
2BX2 066 / 2BX4 086	19.29	19.69	17.52	Ø14.25	5.59	Ø7.09	Ø8.27	6.30	0.35	6.46	0.51	13.58	16.14

Dimensions for suction filter (inch)

2BX2 104
2BX4 066

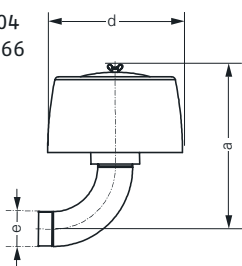

Model 01

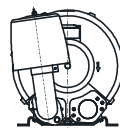

Model 02

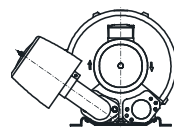

2BX2 100 2BX4 061
2BX2 101 2BX4 062
2BX2 102 2BX4 063
2BX2 103 2BX4 064
2BX2 107 2BX4 065
2BX2 108 2BX4 080

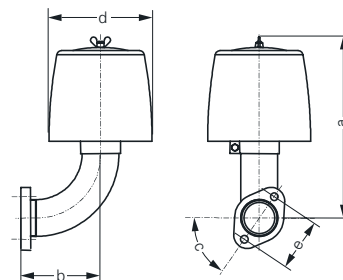

Type	Model	a	b	c	d	e
For / 2BH1						
2BX2 100 / 2BX4 062	01.02	10.12	3.74	45°	Ø5.20	2.52
2BX2 101 / 2BX4 061	01.02	11.81	7.05	45°	Ø6.61	2.95
2BX2 102 / 2BX4 064	01.02	11.61	5.12	55°	Ø6.61	3.35
	01	11.61	5.12	55°	Ø6.61	3.35
2BX2 103 / 2BX4 065	01	13.74	5.12	55°	Ø11.42	3.35
2BX2 104 / 2BX4 066		13.98			Ø11.42	R2 1/2
2BX2 107 / 2BX4 063	01	12.01	7.28	45°	Ø6.61	2.95
For 2BH7						
2BX2 100	01	10.12	3.74	45°	Ø5.20	2.52
2BX2 108	01	12.01	7.28	45°	Ø6.61	2.52
2BX4 080	01	10.12	3.74	45°	Ø5.20	2.52

Dimensions

Dimensions for additional silencer (inch)

2BX4 000
2BX4 010
2BX4 011
2BX4 013
2BX4 014
2BX4 015

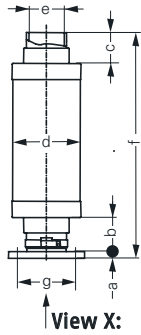

View X:

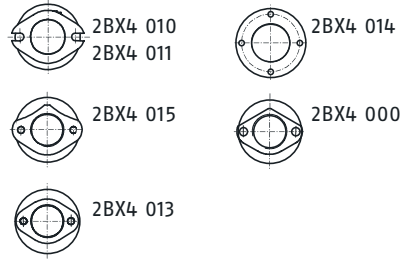

2BX4 012

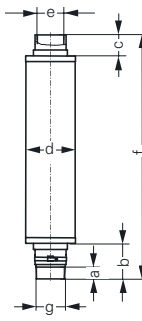

Type	a	b	c	d	e	f	g
2BX4 000	0.35	1.77	1.57	Ø3.27	Ø1.59	11.54	2.52
2BX4 010	0.35	1.77	1.57	Ø3.50	Ø1.99	11.57	2.83
2BX4 011	0.35	1.77	1.57	Ø2.95	Ø1.59	11.54	2.52
2BX4 012	1.26	2.56	2.20	Ø5.20	Ø3.15	25.63	G2 1/2
2BX4 013	0.87	2.95	2.36	Ø6.57	Ø4.53	25.90	5.91
2BX4 014	0.87	3.15	2.36	Ø8.23	Ø5.91	26.06	Ø8.27
2BX4 015	0.35	1.77	1.57	Ø3.46	Ø1.99	11.54	2.84

Dimensions for 90° elbow (inch)

2BX4 313
2BX4 314
2BX4 315
2BX4 319

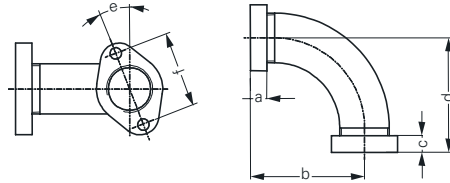

Type	a	b	c	d	e	f
2BX4 313	0.55	3.80	0.55	3.88	21.5°	2.52
2BX4 314	0.55	4.19	0.55	4.19	18°	2.95
2BX4 315	0.63	5.18	0.63	5.18	23.5°	3.35
2BX4 319	0.87	4.80	0.87	4.80	0°	5.91

Dimensions for threaded flange (inch)

2BX1 037
2BX1 038
2BX1 041
2BX1 042
2BX4 041
2BX4 042

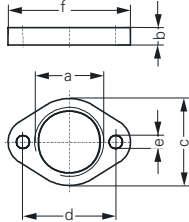

2BX1 040

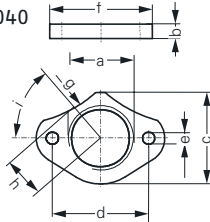

2BX4 040

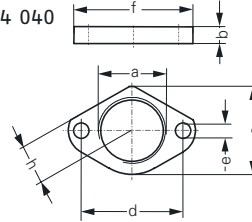

2BX1 043
2BX4 043

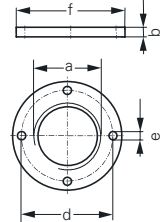

Type	a	b	c	d	e	f	g	h	i
2BX1 037	G1 1/4	0.55	2.20	2.54	0.37	3.15	-	-	-
2BX1 038	G1 1/2	0.55	2.83	2.95	0.37	3.94	-	-	-
2BX1 040	G1 1/2	0.55	2.83	2.95	0.37	3.94	R 3.94	1.22	57.5°
2BX1 041	G2	0.63	3.15	3.35	0.47	4.41	-	-	-
2BX1 042	G4	0.87	5.51	5.91	0.55	7.48	-	-	-
2BX1 043	G5	0.87	-	Ø8.27	0.71	Ø9.84	-	-	-
2BX4 040	G1 1/4	0.55	2.20	2.52	0.37	3.15	1.18	0.91	-
2BX4 041	NPT2	0.63	3.15	3.35	0.47	4.41	-	-	-
2BX4 042	NPT4	0.87	5.51	5.91	0.55	7.48	-	-	-
2BX4 043	NPT5	0.87	-	8.27	0.71	9.84	-	-	-

Dimensions for hose flange (inch)

2BX1 032
2BX1 033
2BX1 036

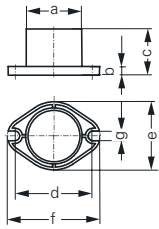

2BX1 034

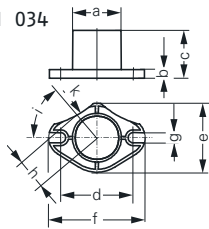

2BX1 046

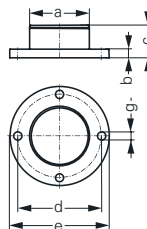

2BX4 020

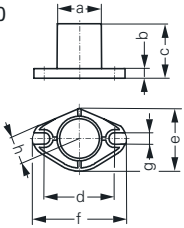

2BX1 047

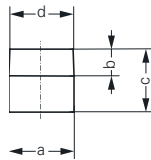

2BX1 048

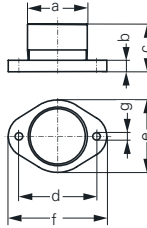

Type	a	b	c	d	e	f	g	h	i	k
2BX1 032 / 2BX4 020	Ø1.58	0.35	1.97	2.52	2.36	3.35	0.41	- / 0.91	-	-
2BX1 033	Ø1.97	0.35	1.97	3.27	2.84	3.94	0.41	-	-	-
2BX1 034	Ø1.97	0.35	1.97	2.83	2.84	3.94	0.41	1.22	57.5°	R 3.94
2BX1 036	Ø2.36	0.35	1.97	3.27	2.91	3.94	0.41	-	-	-
2BX1 046	Ø5.91	0.87	3.23	Ø8.27	Ø9.84	-	0.71	-	-	-
2BX1 047	Ø2.99	1.26	2.95	G2 1/2	-	-	-	-	-	-
2BX1 048	Ø4.53	0.87	3.62	5.91	5.51	7.48	0.71	-	-	-

Footprint Dimensions for vertical / horizontal mounting (inch)

Type	a	b	c	d	e	f
2BX2 120	Ø0.98	0.79	0.39	0.24	M6	M6
2BX2 121	Ø1.18	0.79	0.51	0.30	M8	M8
2BX2 122	Ø1.97	1.18	0.59	0.39	M10	M10
2BX2 123	Ø2.95	1.58	0.69	0.41	M12	M12
2BX2 127	Ø1.38	1.77	0.43	0.31	M6	M6
2BX2 128	Ø1.38	1.77	0.43	0.31	M8	M8
2BX2 135	Ø0.98	1.73	0.39	0.23	M6	M6

Type	a	b	c	d	e	f
2BX4 100	Ø0.98	0.79	0.39	0.24	M6	M6
2BX4 101	Ø1.18	0.79	0.51	0.30	M8	M8
2BX4 102	Ø1.97	1.18	0.59	0.39	M10	M10
2BX4 103	Ø2.95	1.57	1.57	0.41	M12	M12
2BX4 104	Ø2.95	1.57	1.57	0.41	M12	M12

2BX2 120
2BX2 121
2BX2 122
2BX2 123
2BX2 127
2BX2 128
2BX2 135

2BX4 100
2BX4 101
2BX4 102
2BX4 103
2BX4 104

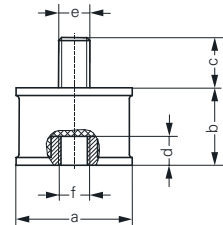

Dimensions for fixing clamp for 2BH1 943 (1 set = 4 feet) (inch)

2BX2 124

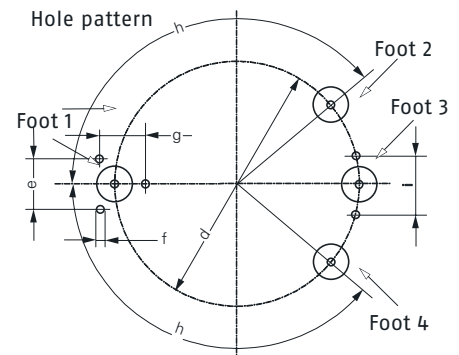
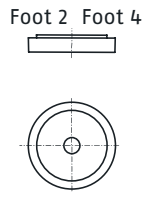
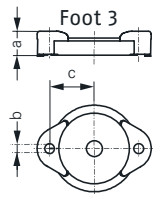
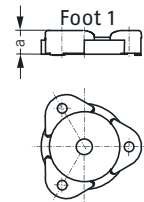

Type	a	b	c	d	e	f	g	h	i
2BX2 124	1.02	Ø0.39	3.27	19.29	3.41	M8	2.95	120°	3.94

Dimensions

Dimensions for vacuum relief valve with adaptor (inch)

2BX2 141
2BX2 142
2BX2 171
2BX2 172
for 2BH13/2BH7

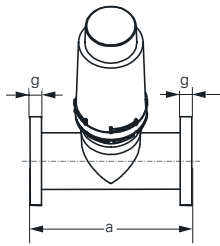
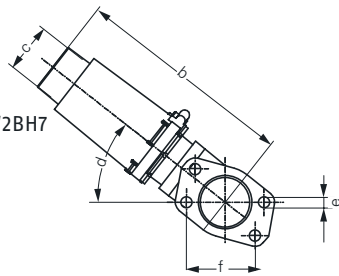

2BX2 141
2BX2 142
2BX2 171
2BX2 172
for 2BH14

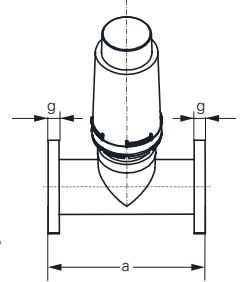
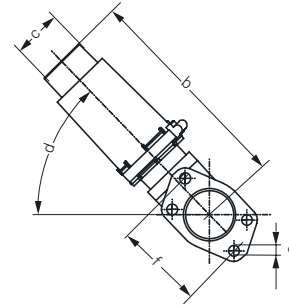

2BX2 145
2BX2 146

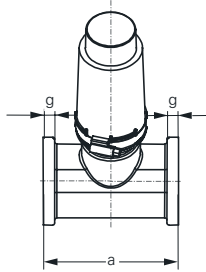
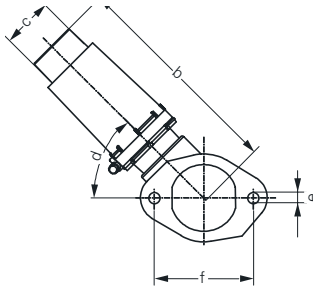

Type		a	b	c	d	e	f	g
2BX2 141 / 142	2BH13	5.24	7.13	Ø1.65	38°	Ø0.35	2.52	0.39
2BX2 171 / 172	2BH14	5.24	7.13	Ø1.65	48°	Ø0.35	2.91	0.39
2BX2 145 / 146		4.45	7.13	Ø1.65	45°	Ø0.37	3.27	0.39

Dimensions for pressure relief valve with adaptor (inch)

2BX2 143
2BX2 144
2BX2 173
2BX2 174
for 2BH13/
2BH7

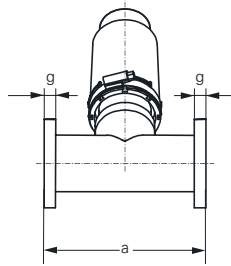
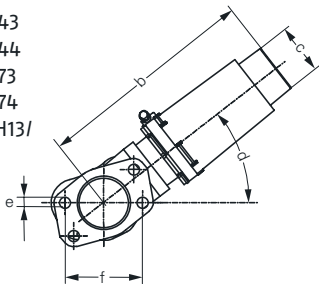

2BX2 143
2BX2 144
2BX2 173
2BX2 174
for 2BH14

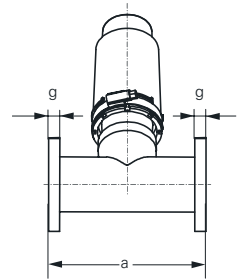
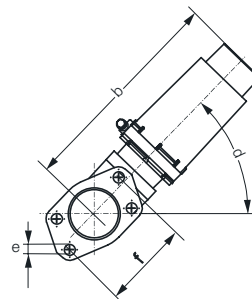

2BX2 147
2BX2 148

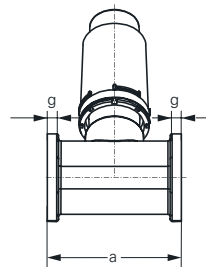
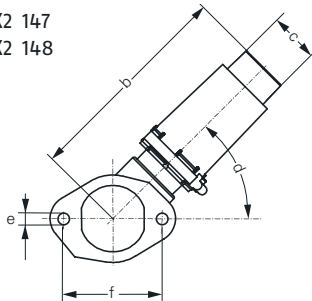

Type		a	b	c	d	e	f	g
2BX2 143 / 144	2BH13	5.24	7.13	Ø1.65	38°	Ø0.35	2.52	0.39
2BX2 173 / 174	2BH14	5.24	7.13	Ø1.65	48°	Ø0.35	2.91	0.39
2BX2 147 / 148		4.45	7.13	Ø1.65	45°	Ø0.37	3.27	0.39

Dimensions for vacuum relief valve (supplied loose for pipeline mounting) (inch)

2BX2 110
2BX2 114

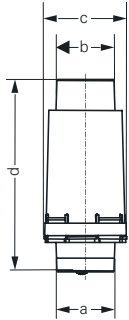

2BX2 150
2BX2 152
2BX2 154

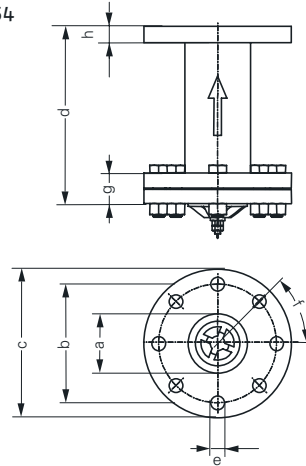

Type	a	b	c	d	e	f	g	h
2BX2 110 / 114	G1 1/4	Ø1.63	Ø2.36	5.53	-	-	-	-
2BX2 150	Ø3.15	Ø6.30	Ø7.87	9.41	Ø0.71	45°	1.61	0.75
2BX2 152	Ø4.92	Ø8.27	Ø9.84	15.51	Ø0.71	45°	1.81	0.94
2BX2 154	Ø7.87	Ø11.61	Ø13.39	23.39	Ø0.91	45°	1.89	0.94

Dimensions for pressure relief valve (supplied loose for pipeline mounting) (inch)

2BX2 111
2BX2 115



2BX2 151
2BX2 153
2BX2 155

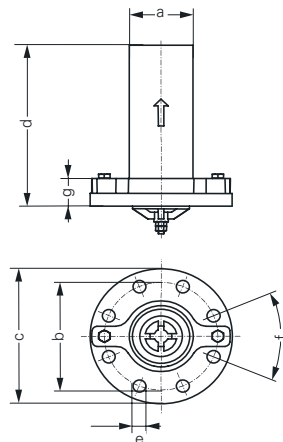

Type	a	b	c	d	e	f	g
2BX2 111 / 115	G1 1/4	Ø1.63	Ø2.36	5.53	-	-	-
2BX2 151	Ø3.15	Ø6.30	Ø7.87	9.41	Ø0.71	45°	1.61
2BX2 153	Ø4.92	Ø8.27	Ø9.84	15.51	Ø0.71	45°	1.81
2BX2 155	Ø7.87	Ø11.61	Ø13.39	23.39	Ø0.91	45°	1.89

An

nex

Application examples	66 - 75
Conversion tables	76
Physical basics for blower applications	77 - 78
General safety information	79 - 80
Quality	81
ATEX	82
Footnotes and Voltage Overview	83

Air cushion generation for paper processing machines

Several little blast pipes which are normally closed by ball valves are located in the table plate. When the balls are pressed down by the weight of a paper staple the valve is opened. Floating on an air cushion the paper now can be easily shifted and positioned.

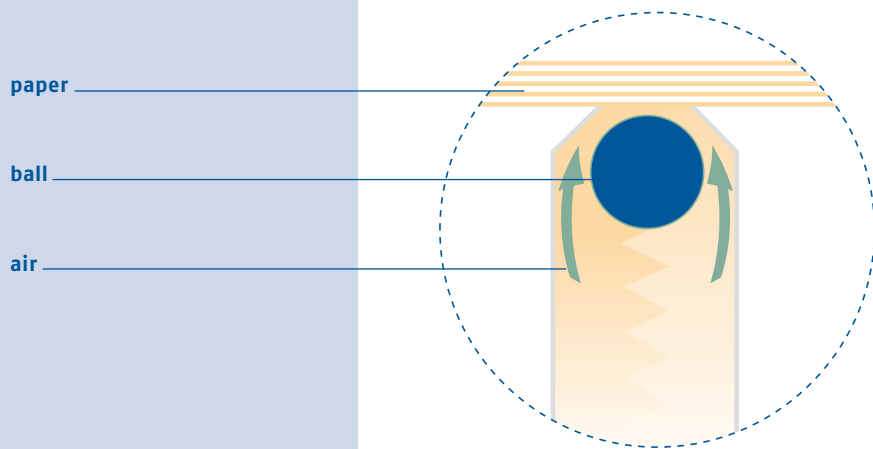

Bust pipe

Air cushioning for air tables

Ball valves used in air tables follow the same principle of design as those used for paper cutting machines. As a result most manufacturers of paper cutting machines also offer air tables.

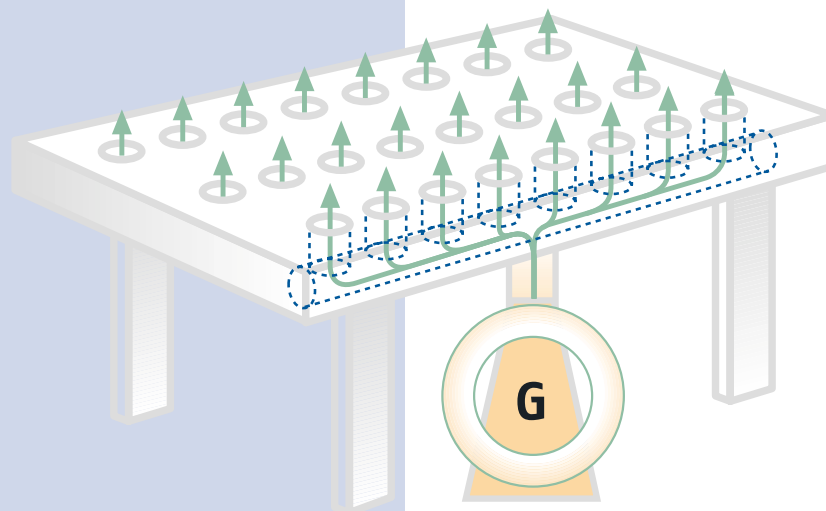

Air table equipped with a gas ring compressor

Vacuum generation for screen printing machines

Blowers used in a suction table generate a vacuum which secures the paper sheets during the printing process to prevent slipping.

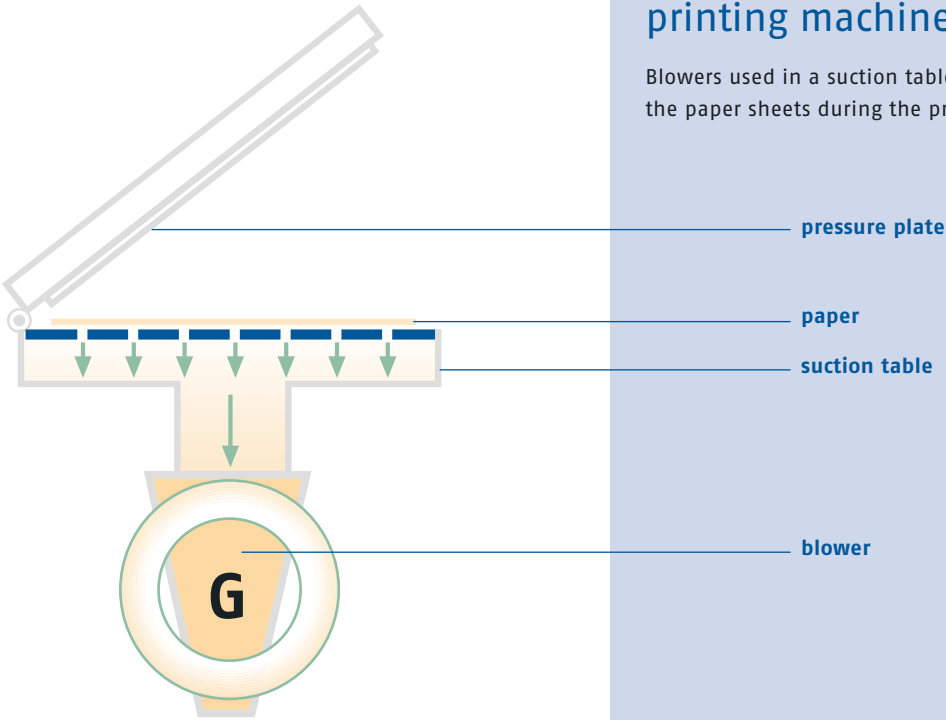

Suction table for screen printing

Powder spraying for printing machines (Dry and pressure spraying)

Powder is sprayed on the paper immediately after printing to avoid smearing of wet colour and sticking of paper to the machine. For spraying an injector is used.

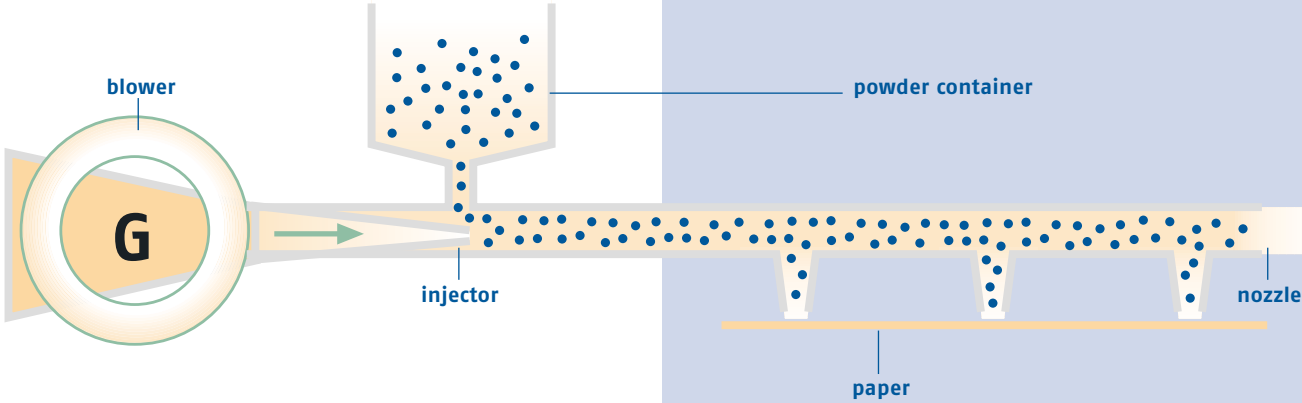

Powder spraying for printing machines

Air arm for printing machines

After passing the printing machine the sheets of paper are turned over and piled up. Both operations are supported by blast air.

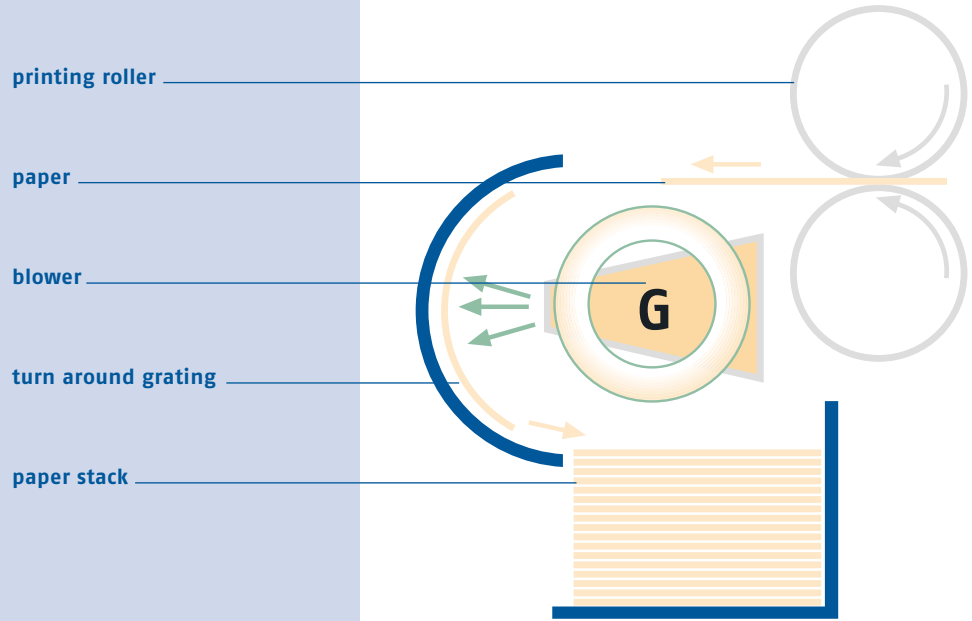

Turning over paper by blast air

Paper transport by air cushions

To avoid smearing of wet paint the sheets of paper are blown against a detent with the printed on side facing down.

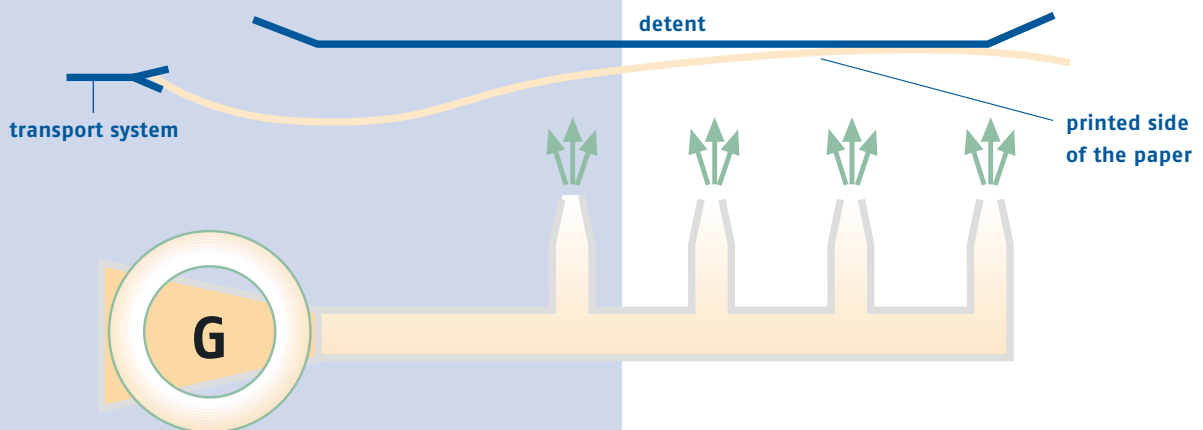

Blast air transportation of printed paper

Aeration of paper piles by blast air

Piled sheets of paper often tend to stick together especially when their surface is very smooth. Blast air can be used for separation by forming air cushions between the sheets.

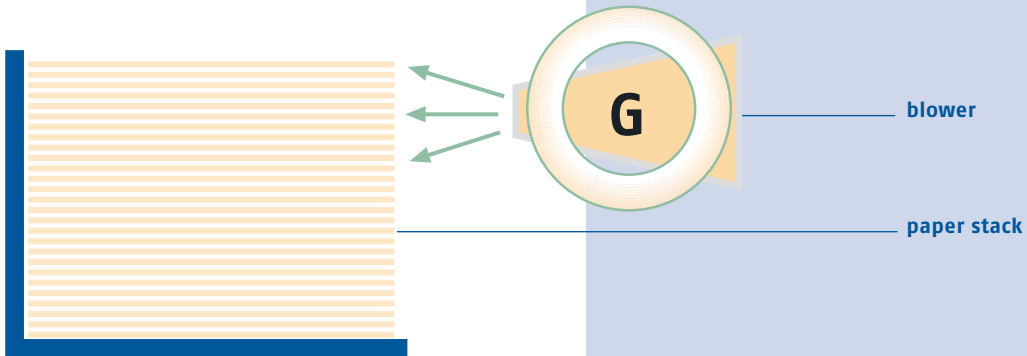

Loosening stacked paper by blast air

Suction of paper clippings

(e.g. perforating machines, paper cutting machines, punched-card machines, Hollerith machines etc.)

The paper clippings can be collected in a filter equipped settling chamber after being sucked off right at their origin.

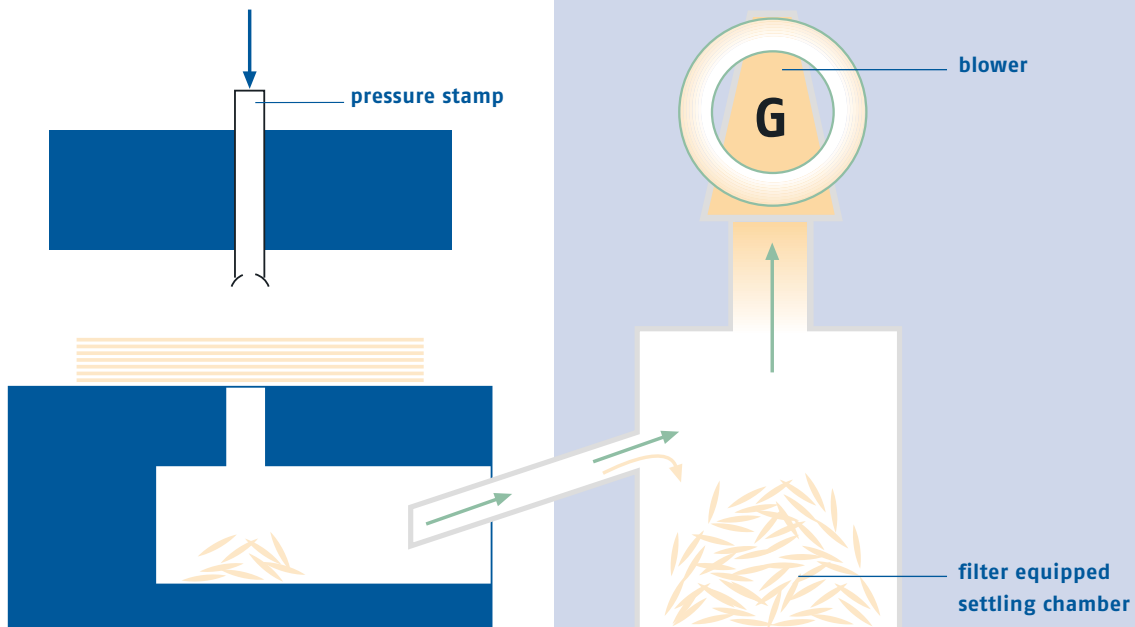

Sucking in paper clippings at a vacuum table

Evacuation of fruit packings

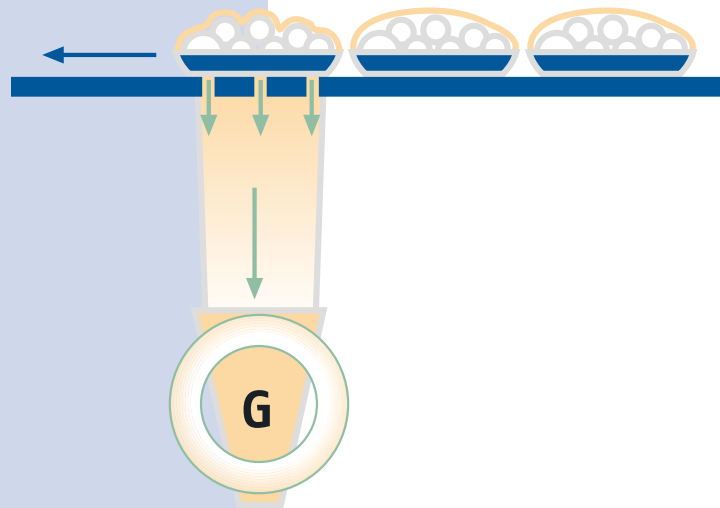

Evacuation of fruit packings

Packing eggs by suction air

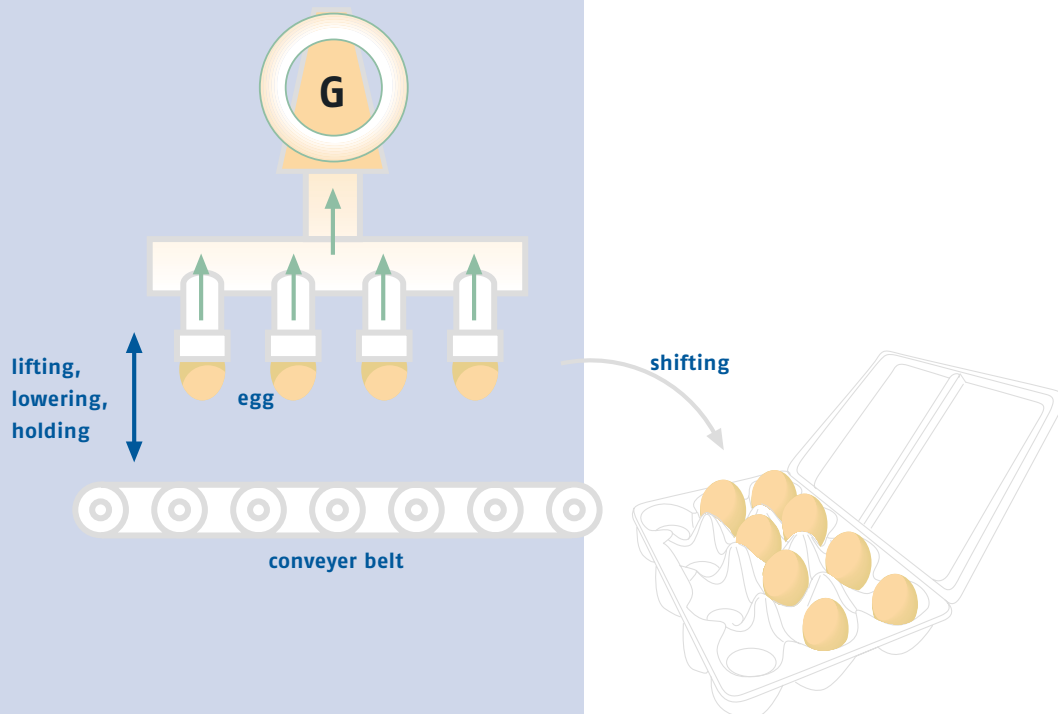

Packing eggs by suction air

Holding and clamping of workpieces

Suction air generated by a gas ring blower is used to secure the workpiece during machining. This way of clamping is especially important for parts that can't be secured by magnetic forces (e.g. workpieces consisting of wood, plastics, ceramics and non-ferrous metals).

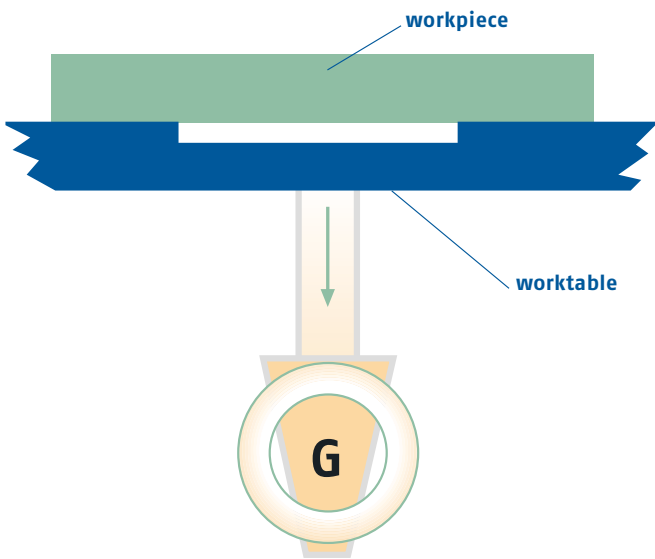

Clamping workpieces by suction air

Conveying machinery

Depending on their weight and size, the goods to be conveyed are secured by one or several suction cups.

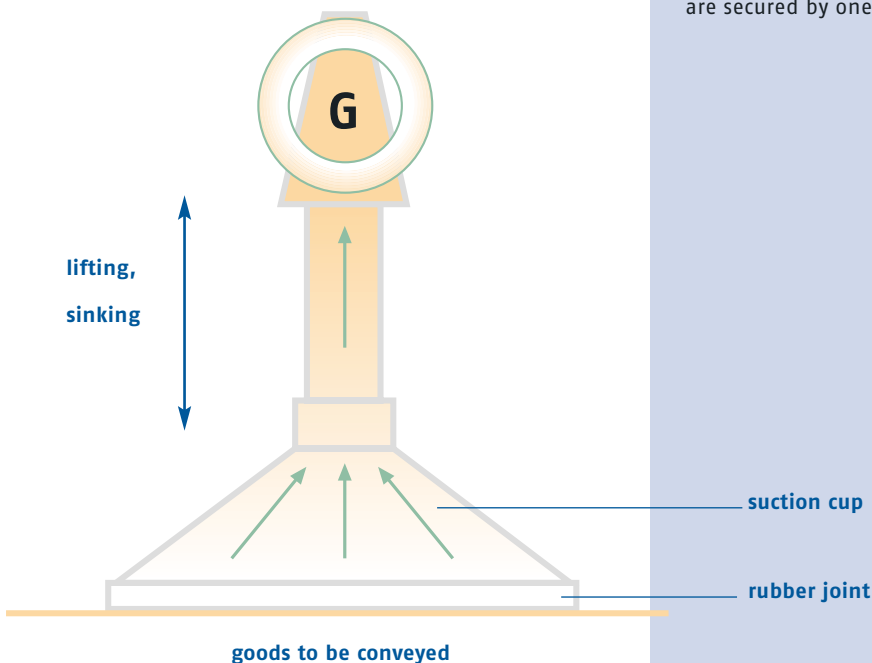

Lifting and transporting by suction air

Granulated material conveyers

Automated loading of molding presses and extruders. A blower generates a vacuum in the container for granulated material which is transported by the air flow. The gas ring blower is protected by a filter.

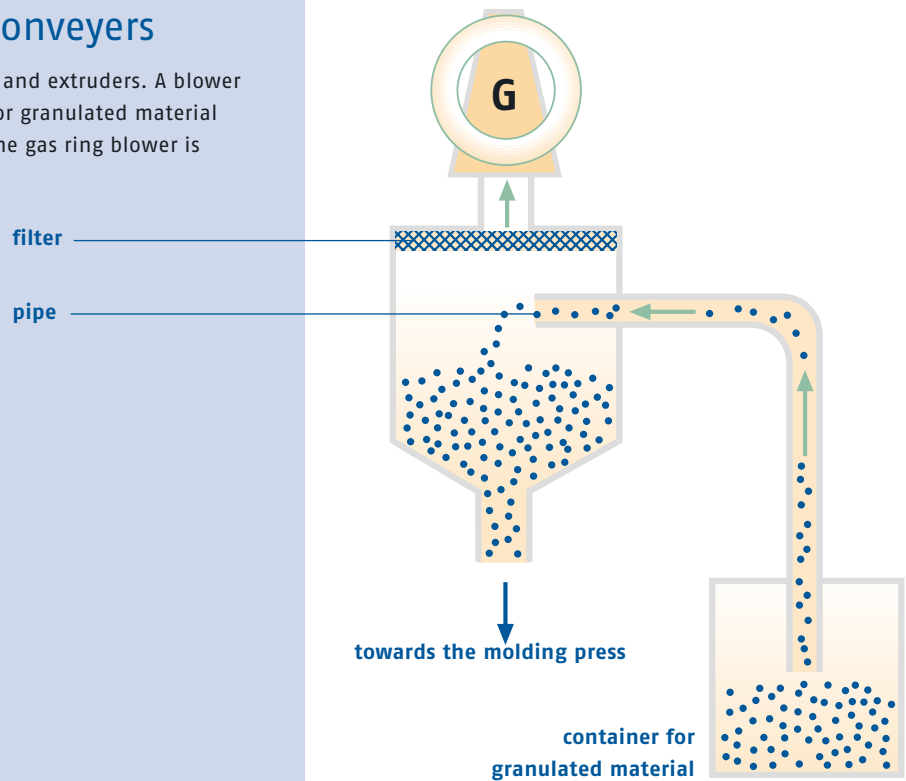

Pneumatic transportation of granulated material

Respirators

Fresh air is needed for breathing while working in polluted atmospheres. This is for example necessary in the chemical industry where big tanks, chambers etc. have to be cleaned.

Gas ring blowers can provide fresh air for one or several respirators at the same time. A hose diameter of 1" and a maximal hose length of 15 ft are required.

Another possibility is to pump fresh air into the protective helmet from above so that no pollutants are inhaled by the worker.

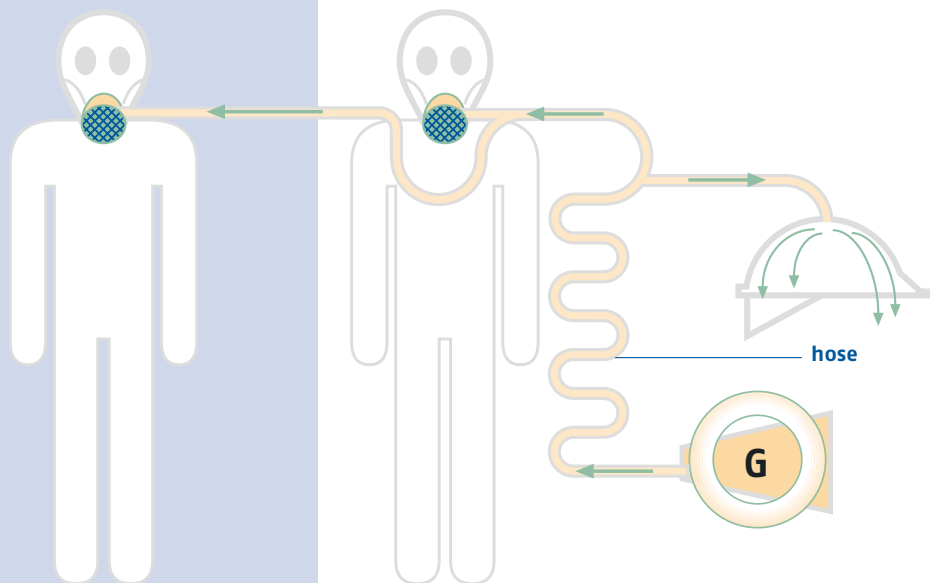

Respirators

Using suction air for dental appliances

In dental equipment vacuum air is used to empty the basin and to suck in cooling water from the drill as well as saliva and blood. Such applications require gas ring blowers that are protected against corrosion.

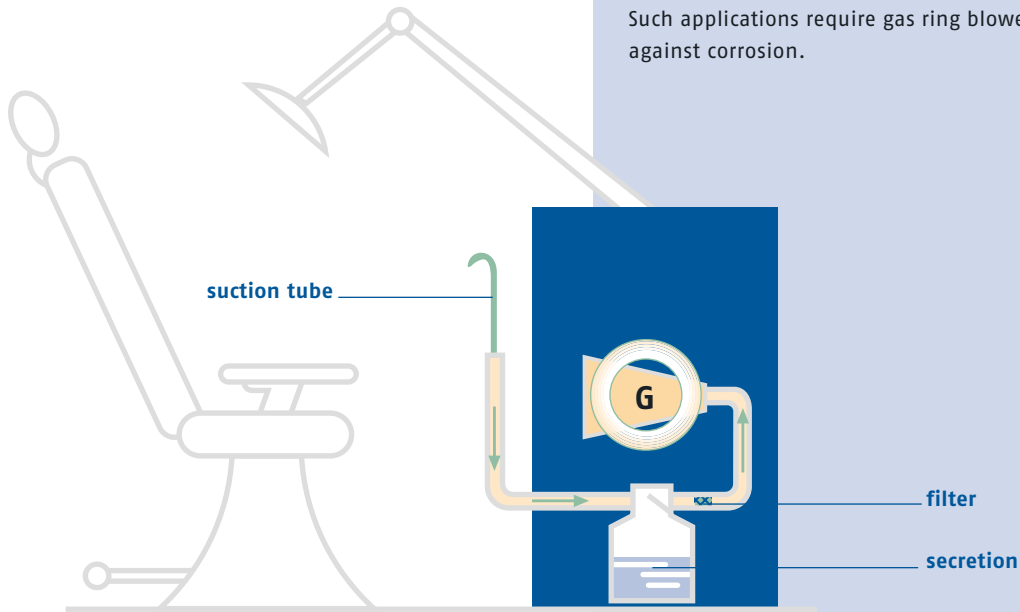

Dental chairs

Aeration of ponds

Pumping air into fish-hatching tanks can improve living conditions for the animals. This speeds up breeding so that more fish per area can be caught.

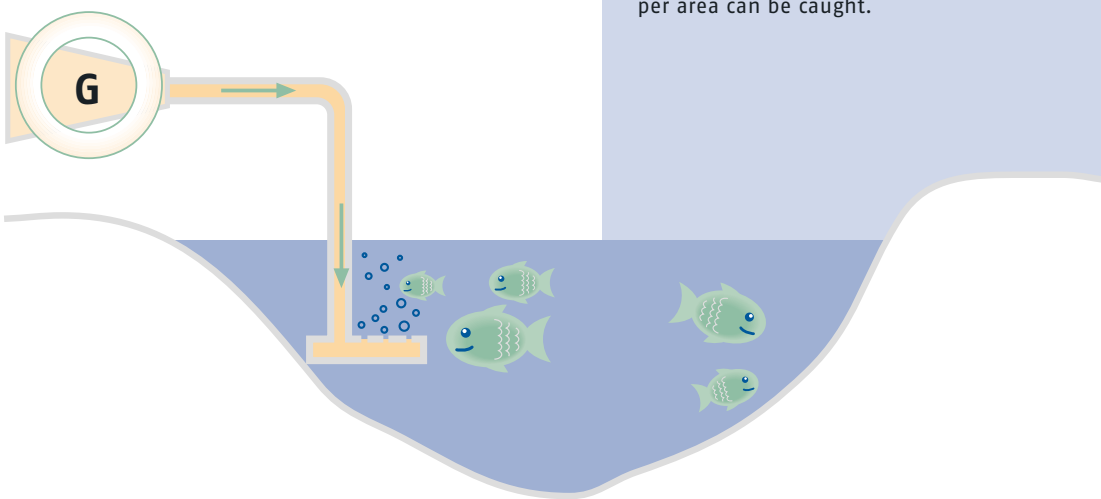

Aeration of ponds

G_Series Application examples

Dust exhaustion

Waste from industrial production processes often consists of fine-grained dust which is injurious to health. Therefore it must be collected and disposed of by either stationary or mobile devices.

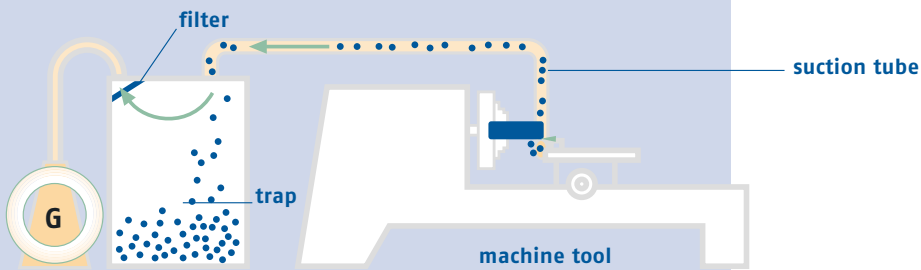

Stationary removal by suction

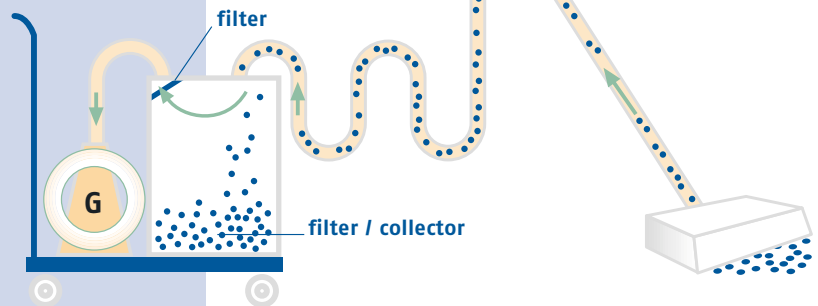

Mobile removal by suction

Cleaning sewers by suction

Suction trucks are widely used in the municipal sector for cleaning sewers. Gas ring blowers generate a vacuum which is used for sucking in soil or residue from sewers at a free air capacity of about 40 ft (plus vehicle height).

— inward pumping
— exhausting

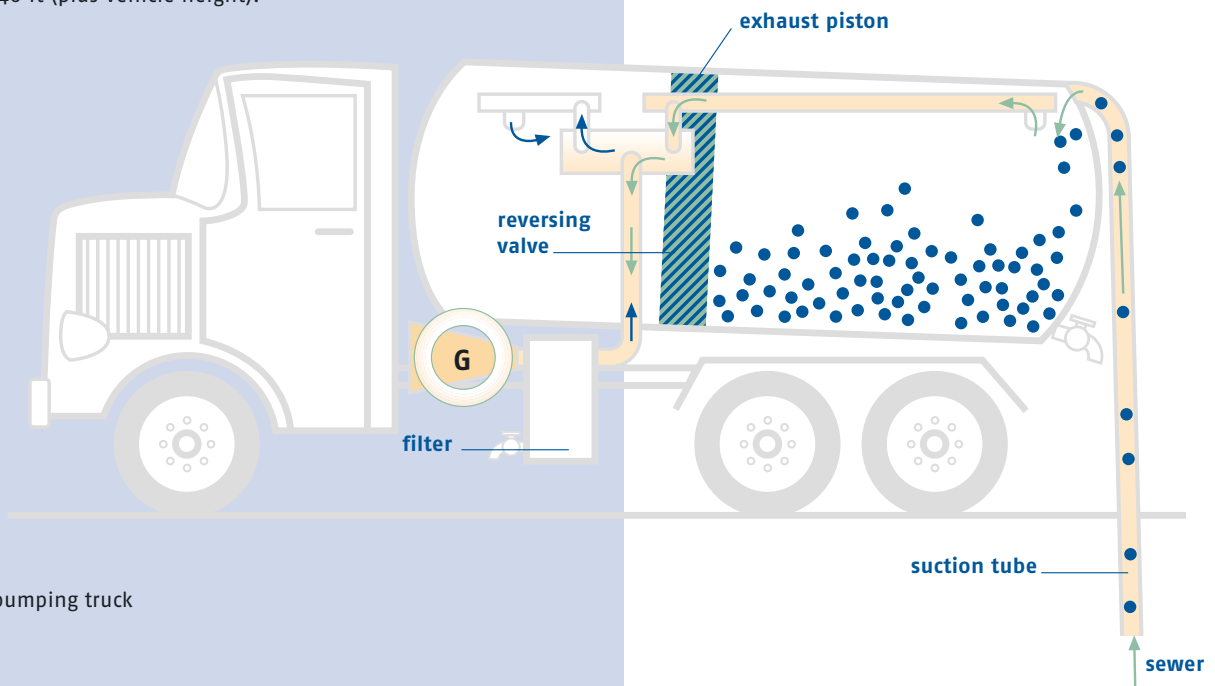

Sewer pumping truck

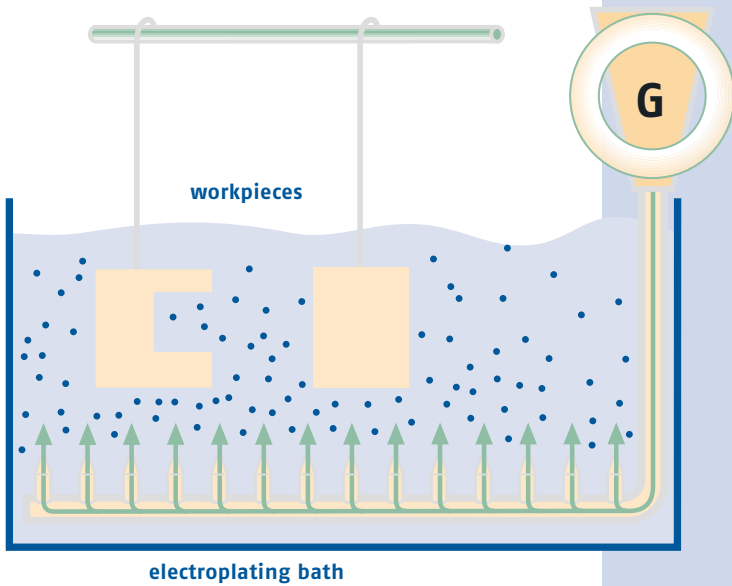

Aeration of electroplating baths

Aeration of electroplating baths

Air is blown through a perforated pipe into the electroplating bath to improve intermixture. In addition that air bubbles are kept off the workpiece's surface.

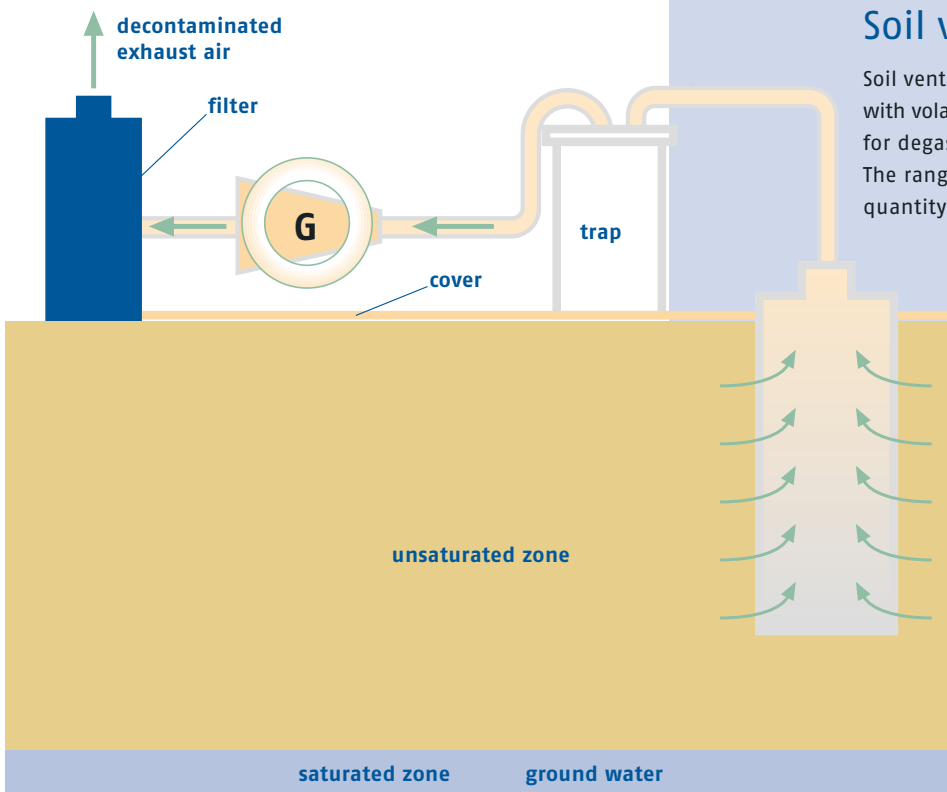

Soil-ventilation

Soil ventilation devices

Soil ventilation is used for soils that are unsaturated with volatile substances. This method is recommended for degassing BTX and LHKW contaminated soils. The range of degassing apparatus depends on the quantity, dissemination and saturation pressure of the pollutant as well as on the air flow in the subsoil.

Depending on conditions mentioned above the range may vary between 33 and 262 ft. Exhaust air must be disposed of according to pollution control regulations (filtering, flaring etc.).

Pressure			
Beginning units	Multiply by	to get	back conversion
atm	1.013	bar	0.987
atm	1013.3	mbar	0.001
atm	76	cm Hg	0.013
atm	29.92	in Hg	0.033
atm	1.033	kg/cm ²	0.968
mbar	0.0295	in Hg	33.86
mbar	0.075	cm Hg	13.33
mbar	100	Pa	0.01
mbar	10.2	mm H ₂ O	0.098
mbar	0.4	in H ₂ O	2.49
mbar	0.015	PSI	68.97
in Hg	13.6	in H ₂ O	0.074
in Hg	0.49	PSI	2.036
in H ₂ O	0.036	PSI	27.68

Suction capacity			
Beginning units	Multiply by	to get	back conversion
m ³ /h	35.31	ft ³ /h	0.028
m ³ /h	0.589	cfm	1.67
m ³ /h	16.67	l/min	0.06
m ³ /h	4.4	gal/min	0.227
cfm	7.48	gal/min	0.134

Power			
Beginning units	Multiply by	to get	back conversion
kW	1.34	hp	0.746
kW	3415.2	BTU/h	0.0003
BTU/h	0.0004	hp	2546.7

Mass			
Beginning units	Multiply by	to get	back conversion
kg	2.2	lbs	0.454

Length			
Beginning units	Multiply by	to get	back conversion
in	2.54	cm	0.394
in	0.083	feet	12
cm	0.033	feet	30.48

Temperature conversion			
Conversion			
from	to		
°F	°C	$t [^{\circ}\text{C}] = \frac{t [^{\circ}\text{F}] - 32}{1.8}$	
°C	°F	$t [^{\circ}\text{F}] = 1.8 \cdot t [^{\circ}\text{C}] + 32$	

Types of pressure

- Absolute pressure**
 The pressure measured from absolute zero, using ideal vacuum as the datum. The measured pressure is always greater than the reference pressure.
- Total pressure difference, pressure**
 The pressure measured above the prevailing atmospheric pressure. The datum is the prevailing atmospheric pressure and the measured pressure is always higher than the datum.
- Total pressure difference, vacuum**
 The pressure measured lower than the prevailing atmospheric pressure. The datum is the prevailing atmospheric pressure and the measured pressure is always lower than the datum.

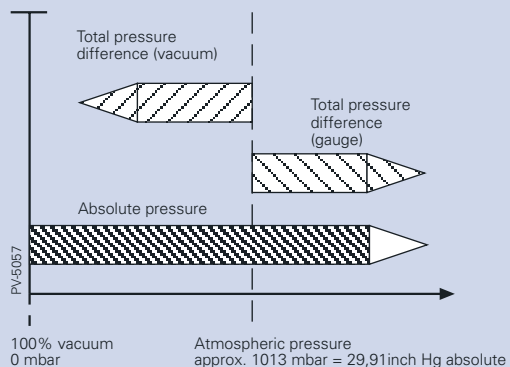

Physical basics for blower applications

Physical laws			
Variable	Volume	Pressure	Power
Speed change	$\dot{V}_2 = \dot{V}_1 \left(\frac{n_2}{n_1} \right)$	$p_2 = p_1 \left(\frac{n_2}{n_1} \right)^2$	$P_2 = P_1 \left(\frac{n_2}{n_1} \right)^3$
Temperature change		$p_2 = p_1 \frac{ta_1}{ta_2}$	
Density change		$p_2 = p_1 \left(\frac{\rho_2}{\rho_1} \right)$	$P_2 = P_1 \left(\frac{\rho_2}{\rho_1} \right)$

Index:

- 1 original (standard)
- 2 new

■ Symbols:

\dot{V}	Flow	[cfm]
n	Drive speed	[rpm]
p	Pressure	[in Hg] or [PSI]
P	Power	[hp]
ρ	Density	[lbs/cu.ft.]
ta	Temperature absolute	[°F] (standard: 68+ 460=528 °F)

Examples

■ 1. Flow dependent on speed

A blower is operating at 3600 rpm and delivering 2000 cfm. If the speed is reduced to 3000 rpm, what is the new flow?

$$\dot{V}_2 = \dot{V}_1 \left(\frac{n_2}{n_1} \right) = 2000 \times \frac{3000}{3600} \approx 1667 \text{ cfm}$$

■ 2. Pressure dependent on altitude

A blower is operating at an elevation of 5000 ft and is to deliver 3 PSI pressure. What pressure blower is required by standard conditions?

$$p_2 = 3 \times \frac{29.92}{24.89} \approx 3.6 \text{ PSI}$$

29,92 in Hg barometric pressure sea level

24,89 in Hg barometric pressure at a 5000 feet-level

When a blower is to operate at a high altitude it is frequently specified that the blower be capable of handling a given flow of standard conditions. It is then necessary to determine the equivalent flow of air at the higher altitude.

■ 3. A blower is to operate at 5000 ft altitude and is to handle 2000 cfm of standard air. What is the flow of air the blower must handle at 5000 ft altitude?

$$\dot{V}_2 = \dot{V}_1 \frac{29.92}{24.89} = 2000 \times \frac{29.92}{24.89} \approx 2404 \text{ cfm}$$

Annex

4. Pressure dependent on the speed ratio

A blower is operating at a speed of 3600 rpm and delivering air at 3 PSI pressure. If the speed is reduced to 3000 rpm, what is the new pressure?

$$p_2 = p_1 \left(\frac{n_2}{n_1} \right)^2 = 3 \times \left(\frac{3000}{3600} \right)^2 = 3 \times 0.83^2 \approx 2.08 \text{ PSI}$$

5. Pressure dependent on the temperature

A blower is to handle 200 °F air at 3 PSI pressure. What pressure (standard) blower is required?

$$p_2 = p_1 \times \frac{ta_2}{ta_1} = 3 \times \frac{660}{528} = 3.75 \text{ PSI}$$

A blower is capable of delivering 3PSI pressure with standard air. What pressure will develop handling 200 °F inlet air?

$$p_1 = p_2 \times \frac{ta_2}{ta_1} = 3 \times \frac{528}{660} = 2.4 \text{ PSI}$$

6. Power dependent of speed ratio

A blower is operating at a speed of 3600 rpm and requiring 10 hp. If the speed is reduced to 3000 rpm, what is the new required power?

$$P_2 = P_1 \left(\frac{n_2}{n_1} \right)^3 = 10 \times \left(\frac{3000}{3600} \right)^3 = 10 \times 0.83^3 \approx 5.78 \text{ hp}$$

Table for barometric pressure of various altitudes

The pressure values generated with the following formulae:

$$p' [\text{in Hg}] = p_0 - 29.92 [\text{in Hg}] \left(1 - \left(\frac{288[\text{K}] - 0.00198[\text{K}/\text{ft}] \times h[\text{ft}]}{288 \text{ K}} \right)^{5.255} \right)$$

$$p' [\text{hPa}] = p_0 - 1013.3 [\text{hPa}] \left(1 - \left(\frac{288[\text{K}] - 0.0065[\text{K}/\text{m}] \times h[\text{m}]}{288 \text{ K}} \right)^{5.255} \right)$$

with p_0 = pressure at your location.

In the table is p_0 the standard air pressure 29.92 in Hg or 1,013 mbar and feet = 0 the sea level.

Formulae in accordance to CINA (Comité International de Navigation Aérienne)

Barometric pressure of various altitudes

Altitude		barom. pressure p'			
feet	m	inch Hg	PSI	hPa=mbar	
0	0	29.92	14.69	1.013	
100	30	29.81	14.64	1.010	
200	61	29.71	14.59	1.006	
300	91	29.60	14.53	1.002	
400	122	29.49	14.48	999	
500	152	29.39	14.43	995	
600	183	29.28	14.38	992	
700	213	29.17	14.32	988	
800	244	29.07	14.27	984	
900	274	28.96	14.22	981	
1,000	305	28.86	14.17	977	
1,500	457	28.34	13.91	960	
2,000	610	27.82	13.66	942	
2,500	762	27.32	13.41	925	
3,000	914	26.82	13.17	908	
3,500	1,067	26.33	12.93	891	
4,000	1,219	25.84	12.69	875	
4,500	1,372	25.37	12.45	859	
5,000	1,524	24.90	12.22	843	
5,500	1,676	24.43	12.00	827	
6,000	1,829	23.98	11.77	812	
6,500	1,981	23.53	11.55	797	
7,000	2,134	23.09	11.34	782	
7,500	2,286	22.65	11.12	767	
8,000	2,438	22.22	10.91	753	
8,500	2,591	21.80	10.71	738	
9,000	2,743	21.39	10.50	724	
9,500	2,896	20.98	10.30	710	
10,000	3,048	20.58	10.10	697	
10,500	3,200	20.18	9.91	683	
11,000	3,353	19.79	9.72	670	
11,500	3,505	19.40	9.53	657	
12,000	3,658	19.03	9.34	644	
12,500	3,810	18.66	9.16	632	
13,000	3,962	18.29	8.98	619	
13,500	4,115	17.93	8.80	607	
14,000	4,267	17.57	8.63	595	
14,500	4,420	17.23	8.46	583	
15,000	4,572	16.88	8.29	572	

General safety information

NOTE:

The products in this catalogue are used in the

- capital goods industry
 - consumer goods industry
- and in such sectors as
- agriculture
 - the building industry and
 - allied trades.

This equipment has bare parts that are dangerous because they are live during operation; in some cases these are moving or rotating parts. Such parts could cause severe injury to persons and severe damage to property, for example in the event of unauthorised removal of protective covers, improper use, wrong operation or insufficient maintenance.

The people in charge of safety must therefore guarantee that:

- only qualified personnel are allowed to work on or around this equipment;
- these persons have access at all times to the operating instructions supplied and all other elements of the product documentation when working with the equipment, and are obliged to systematically follow the instructions given therein;
- unqualified personnel are not allowed to work on these machines or equipment or in the vicinity thereof.

Qualified personnel

are persons who – on account of their training, experience, instruction, knowledge of the appropriate standards, specifications, accident prevention regulations and the operating environment – have been authorised by those responsible for plant safety to perform the necessary work and at the same time to recognise and circumvent potential hazards.

Knowledge of first aid and familiarity with the pertinent life-saving equipment are also necessary.

The barring of unqualified personnel from work on heavy-current equipment is regulated by DIN VDE 0105 or IEC 364.

For the sake of clarity, the operating instructions supplied with the equipment cannot contain all the detailed information on possible design variants and in particular cannot take into account every conceivable type of installation, operation or maintenance. The operating instructions therefore basically contain only the information necessary to enable qualified personnel (see above) to operate the machines or equipment correctly in industrial applications.

In the event that the machines or equipment are intended for service outside of industry, where more exacting demands may be placed on them (such as touch protection for children), the installation work must be supplemented by further protective measures that are to be implemented locally.

Where clarifications are necessary, particularly with respect to lack of product-specific detailed information, please contact the sales office concerned, quoting the type designation and manufacturing number of the machine or equipment.

It is advisable to arrange for our service centres to take charge of the necessary planning, installation, commissioning and after-sales service.

General delivery conditions

Export regulations

According to the current provisions (01/2003) of the German and US export regulations, the products listed in this catalogue do not require any export permit. Export or re-export is therefore allowed without the permission of the competent authorities unless the Order on Foreign Trade lays down country-specific restrictions. This is subject to change. The markings given on the delivery slip and invoice are the decisive criteria. An export permit obligation may arise for specific countries as a result of the intended use of the products.

Unless otherwise stated on the individual pages of this catalogue, we reserve the right to make changes, especially to the given values, dimensions and weights.

Illustrations are not binding. Our General Conditions of Trade and Delivery apply.



Electronic check of the dimensional accuracy of a G-Series impeller.



Fully automatic final check of endshields of F-Series and G-Series drives.

Trade marks

All product designations are trade marks or product names of nash_elmo Industries or other companies.

Responsible for the technical content

Dipl.-Ing. Lutz Kasimir
nash_elmo Industries GmbH
Corporate Communication



Only quality has a future

Technical progress and market success are inseparable from the high quality of nash_elmo products. To guarantee this high quality level, a reliable quality assurance system has been established for monitoring all phases of production from development to delivery.

This quality assurance system meets the worldwide requirements, complies with the relevant standards and specifications and fulfills the requirements of ISO 9001:2000.

This gives our customers the following advantages:

- maximum operational safety;
- high, consistent supply reliability;
- compliance with the requirements of the European Market;
- participation in national and international tenders.



Check of performance data and printing of the test protocol.

ATEX information

Since July 1, 2003, it is compulsory by law within the European Union to design explosion-proof machines according to ATEX 94/9 EG.

Free trade within the EC for ATEX compliant machines and devices are therefore guaranteed due to European standardization of machine requirements. ATEX also includes non-electric devices that are a potential ignition source.

A subdivision "Gas/particle(dust) explosion protection" according to ATEX results through the marking G (as)/D (ust). The „zones“ (according to RL 1999/92/EG) represent work areas in which an explosive atmosphere¹⁾ can occur.

Depending upon the frequency and the duration of the appearance of the explosive atmosphere, ATEX subdivides different zones in which corresponding categories are assigned.

„Continuously or for longer periods of time“

Zone 0 (=G) und 20 (=D) Devices of category 1

„Occur occasionally“

Zone 1 (=G) und 21 (=D) Devices of category (1 or) 2

„Normally not likely to occur, or only for short periods of time“

Zone 2 (=G) und 22 (=D) Devices of category (1, 2 or) 3

Our G_200 and G_400 ranges of gas ring compressors are produced according to the ATEX requirements. Machines in the EEx version have been discontinued and replaced by machines corresponding to the new directive, category 3.

There is an ATEX version of every housing size of the G_200 range available in category 3D, 3G, 3/2D and 3/2G²⁾. The side channel blowers comply with the temperature class T3 with a max. (surface) temperature of 125°C and correspond to the protection class IP55. For the category 3/2D, the blowers correspond to the protection class IP65..

All ATEX machines of the G_200 series are available for the categories 3D, 3G and 3/2D as fixed voltage machines for 50 and 60 Hz. For the category 3/2G, only a pure 50-Hz version is available.

1) Mixture of air (oxygen) and flammable gases, steam, powder.

2) 3/2 means: Category 3 inside, Category 2 outside

G_Series Voltage Overview

Voltages at 50 Hz ⁴⁾			
2BH1 ...-...□.□			
3-phase			
185-225 V Δ / 320-390 V Y	H	1	CUL US
200-240 V Δ / 345-415 V Y	H	6	CUL US
345-415 V Δ	H	7	CUL US
500 V Δ	C	5	CUL US
1-phase			
100/200 V	V	4	CUL US
115/230 V	V	5	CUL US
230 V	A	1	
Voltages at 60 Hz ⁴⁾			
3-phase			
200-240 V Δ / 345-415 V Y	H	1	CUL US
220-275 V Δ / 380-480 V Y	H	6	CUL US
380-480 V Δ	H	7	CUL US
575 V Δ	C	5	CUL US
1-phase			
100/200 V	V	4	CUL US
115/230 V	V	5	CUL US
115 V	B	6	
230 V	B	8	
Voltages 3-phase ATEX ⁴⁾			
50 Hz, categories 3D, 3G, 3/2D			
230 V Δ / 400 V Y	D	1	
500 V Δ	D	5	
400 V Δ / 690 V Y	D	6	
50 Hz, category 3/2G			
230 V Δ / 400 V Y	D	1	
500 V Δ	D	5	
400 V Δ / 690 V Y	D	6	
60 Hz, categories 3D, 3G, 3/2D			
460 V Δ	D	1	
575 V Δ	D	5	
460 V Y	D	6	
60 Hz, category 3/2G			
440 V Y	G	1	
575 V Δ	G	5	
440 V Δ	G	6	

Specification of voltage in order number: ▲ ▲

Other voltages available upon request

Footnotes:

- 1) Measuring surface sound-pressure level acc. to EN 216801, measured at a distance of 1 m. The pump is throttled to a medium inlet pressure, a hose is connected to the discharge side, and a vacuum-relief valve is not fitted.
- 2) For selection and ordering information, see accessories. The pressure limits of the valves are based on a cooling agent and ambient temperature of 25 °C.
- 3) For 2BH1 943, only mounting on the end-casing is possible.
- 4) Tolerances: the motors comply with DIN EN 60 034/DIN IEC 34-1 and Insulation Class F:

Three-phase:

fixed voltages incl. ATEX ± 10 %
voltage range ± 5 %
in compliance with UL and CSA - 10 % / + 6 %
(UL 507 u. CSA 22.2 No. 113)

Single-phase:

Fixed voltages: ± 5 %
If during continuous operation only 90% of the maximum end pressure is used, the admissible tolerance increases to ± 10 %.
In compliance with UL and CSA - 10 % / + 6 %
(UL 507 u. CSA 22.2 No. 113)

Frequency:

± 2 %
The motors comply with the IEC and European norms quoted. The European norms replace the national norms of the following member states: Germany (VDE), France (NF C), Belgium (NBNC), Great Britain (BS), Italy (CEI), Netherlands (NEN), Sweden (SS), Switzerland (SEV) and others.

The machines also comply with various national norms.

The following norms have been adapted to the publications IEC 60 034-1 and the motors can be used at standard rated performance:

UL 507	USA
CSA 22.2, No. 113	Canada
IS 325	India
IS 4722	
NEK_IEC 60034-1	Norway



Our product range

L_Series Liquid ring vacuum pumps and compressors

- Chemical and petrochemical industry
- Process engineering
- Paper and pulp industry
- Power plants
- Plastics industry
- Medical technology
- Food industry
- General mechanical engineering

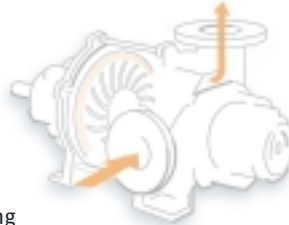

D_Series Dry pumps

- Chemical and pharmaceutical industry
- Process engineering
- Metallurgy
- Packaging industry
- Food industry



V_Series Vane pumps

- Chemical and petrochemical industry
- Food processing industry
- Packaging
- General mechanical engineering



F_Series Radial Fans

- Plastics industry
- Printing industry
- Glass industry
- Industrial furnaces
- Industrial vacuums



S_Series Standardized systems

- Chemical industry
- Process industry
- Food processing industry
- Packaging
- Power generation and supply

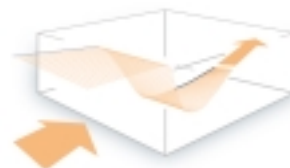

correction level: A2a/2005