



G1000® Integrated Flight Deck

Cockpit Reference Guide for the Beechcraft 200/B200 Series



System Software 0985.00 or later

GARMIN ▲

FLIGHT INSTRUMENTS

NAV/COM/TRANSPONDER/AUDIO PANEL

AUTOMATIC FLIGHT CONTROL SYSTEM

GPS NAVIGATION

FLIGHT PLANNING

PROCEDURES

HAZARD AVOIDANCE

ADDITIONAL FEATURES

ANNUNCIATIONS & ALERTS

APPENDIX

INDEX

Copyright © 2008 Garmin Ltd. or its subsidiaries. All rights reserved.

This manual reflects the operation of System Software version 0985.00 or later for the Beechcraft 200 and B200. Some differences in operation may be observed when comparing the information in this manual to earlier or later software versions.

Garmin International, Inc., 1200 East 151st Street, Olathe, Kansas 66062, U.S.A.
Tel: 913/397.8200 Fax: 913/397.8282

Garmin AT, Inc., 2345 Turner Road SE, Salem, OR 97302, U.S.A.
Tel: 503/391.3411 Fax 503/364.2138

Garmin (Europe) Ltd, Liberty House, Bulls Copse Road, Hounslow Business Park,
Southampton, SO40 9RB, U.K.
Tel: 44/0870.8501241 Fax: 44/0870.8501251

Garmin Corporation, No. 68, Jangshu 2nd Road, Shijr, Taipei County, Taiwan
Tel: 886/02.2642.9199 Fax: 886/02.2642.9099

Web Site Address: www.garmin.com

Except as expressly provided herein, no part of this manual may be reproduced, copied, transmitted, disseminated, downloaded or stored in any storage medium, for any purpose without the express written permission of Garmin. Garmin hereby grants permission to download a single copy of this manual and of any revision to this manual onto a hard drive or other electronic storage medium to be viewed for personal use, provided that such electronic or printed copy of this manual or revision must contain the complete text of this copyright notice and provided further that any unauthorized commercial distribution of this manual or any revision hereto is strictly prohibited.

Garmin® and G1000® are registered trademarks of Garmin Ltd. or its subsidiaries. WATCH®, FliteCharts®, and SafeTaxi® are trademarks of Garmin Ltd. or its subsidiaries. These trademarks may not be used without the express permission of Garmin.

NavData® is a registered trademark of Jeppesen, Inc.; XM® is a registered trademark of XM Satellite Radio, Inc.



WARNING: Navigation and terrain separation must NOT be predicated upon the use of the terrain avoidance feature. The terrain avoidance feature is NOT intended to be used as a primary reference for terrain avoidance and does not relieve the pilot from the responsibility of being aware of surroundings during flight. The terrain avoidance feature is only to be used as an aid for terrain avoidance. Terrain data is obtained from third party sources. Garmin is not able to independently verify the accuracy of the terrain data.



WARNING: The displayed minimum safe altitudes (MSAs) are only advisory in nature and should not be relied upon as the sole source of obstacle and terrain avoidance information. Always refer to current aeronautical charts for appropriate minimum clearance altitudes.



WARNING: The altitude calculated by G1000 GPS receivers is geometric height above Mean Sea Level and could vary significantly from the altitude displayed by pressure altimeters, such as the GDC 74B Air Data Computer, or other altimeters in aircraft. GPS altitude should never be used for vertical navigation. Always use pressure altitude displayed by the G1000 PFD or other pressure altimeters in aircraft.



WARNING: Do not use outdated database information. Databases used in the G1000 system must be updated regularly in order to ensure that the information remains current. Pilots using any outdated database do so entirely at their own risk.



WARNING: Do not use basemap (land and water data) information for primary navigation. Basemap data is intended only to supplement other approved navigation data sources and should be considered as an aid to enhance situational awareness.



WARNING: Traffic information shown on system displays is provided as an aid in visually acquiring traffic. Pilots must maneuver the aircraft based only upon ATC guidance or positive visual acquisition of conflicting traffic.



WARNING: XM Weather should not be used for hazardous weather penetration. Weather information provided by the GDL 69A is approved only for weather avoidance, not penetration.



WARNING: NEXRAD weather data is to be used for long-range planning purposes only. Due to inherent delays in data transmission and the relative age of the data, NEXRAD weather data should not be used for short-range weather avoidance.



WARNING: Use of the Stormscope is not intended for hazardous weather penetration (thunderstorm penetration). Stormscope information, as displayed on the G1000 MFD, is to be used only for weather avoidance, not penetration.



WARNING: The Garmin G1000, as installed in the Hawker Beechcraft 200/B200 aircraft, has a very high degree of functional integrity. However, the pilot must recognize that providing monitoring and/or self-test capability for all conceivable system failures is not practical. Although unlikely, it may be possible for erroneous operation to occur without a fault indication shown by the G1000. It is thus the responsibility of the pilot to detect such an occurrence by means of cross-checking with all redundant or correlated information available in the cockpit.



WARNING: For safety reasons, G1000 operational procedures must be learned on the ground.



WARNING: The United States government operates the Global Positioning System and is solely responsible for its accuracy and maintenance. The GPS system is subject to changes which could affect the accuracy and performance of all GPS equipment. Portions of the Garmin G1000 utilize GPS as a precision electronic NAVigation AID (NAVAID). Therefore, as with all NAVAIDs, information presented by the G1000 can be misused or misinterpreted and, therefore, become unsafe.



WARNING: To reduce the risk of unsafe operation, carefully review and understand all aspects of the G1000 Pilot's Guide documentation and the G1000 Integrated Avionics System and GFC 700 AFCS in Hawker Beechcraft 200 and B200 King Air Airplane Flight Manual Supplement. Thoroughly practice basic operation prior to actual use. During flight operations, carefully compare indications from the G1000 to all available navigation sources, including the information from other NAVAIDs, visual sightings, charts, etc. For safety purposes, always resolve any discrepancies before continuing navigation.



WARNING: The illustrations in this guide are only examples. Never use the G1000 to attempt to penetrate a thunderstorm. Both the FAA Advisory Circular, Subject: Thunderstorms, and the Aeronautical Information Manual (AIM) recommend avoiding “by at least 20 miles any thunderstorm identified as severe or giving an intense radar echo.”



WARNING: Lamp(s) inside this product may contain mercury (HG) and must be recycled or disposed of according to local, state, or federal laws. For more information, refer to our website at www.garmin.com/aboutGarmin/environment/disposal.jsp.



WARNING: Because of anomalies in the earth’s magnetic field, operating the G1000 within the following areas could result in loss of reliable attitude and heading indications. North of 70° North latitude and south of 70° South latitude. An area north of 65° North latitude between longitude 75° West and 120° West. An area south of 55° South latitude between longitude 120° East and 165° East.



CAUTION: The PFD and MFD displays use a lens coated with a special anti-reflective coating that is very sensitive to skin oils, waxes, and abrasive cleaners. **CLEANERS CONTAINING AMMONIA WILL HARM THE ANTI-REFLECTIVE COATING.** It is very important to clean the lens using a clean, lint-free cloth and an eyeglass lens cleaner that is specified as safe for anti-reflective coatings.



CAUTION: The Garmin G1000 does not contain any user-serviceable parts. Repairs should only be made by an authorized Garmin service center. Unauthorized repairs or modifications could void both the warranty and the pilot’s authority to operate this device under FAA/FCC regulations.



NOTE: All visual depictions contained within this document, including screen images of the G1000 panel and displays, are subject to change and may not reflect the most current G1000 system and aviation databases. Depictions of equipment may differ slightly from the actual equipment.



NOTE: This device complies with part 15 of the FCC Rules. Operation is subject to the following two conditions: (1) this device may not cause harmful interference, and (2) this device must accept any interference received, including interference that may cause undesired operation.



NOTE: The data contained in the terrain and obstacle databases comes from government agencies. Garmin accurately processes and cross-validates the data, but cannot guarantee the accuracy and completeness of the data.



NOTE: This product, its packaging, and its components contain chemicals known to the State of California to cause cancer, birth defects, or reproductive harm. This notice is being provided in accordance with California's Proposition 65. If you have any questions or would like additional information, please refer to our web site at www.garmin.com/prop65.



NOTE: Interference from GPS repeaters operating inside nearby hangars can cause an intermittent loss of attitude and heading displays while the aircraft is on the ground. Moving the aircraft more than 100 yards away from the source of the interference should alleviate the condition.



NOTE: Use of polarized eyewear may cause the flight displays to appear dim or blank.



NOTE: The purpose of this Cockpit Reference Guide is to provide the pilot a resource with which to find operating instructions on the major features of the G1000 system more easily. It is not intended to be a comprehensive operating guide. Complete operating procedures for the system are found in the G1000 Pilot's Guide for this aircraft.

Blank Page

Part Number	Change Summary
190-00929-00	Initial release

Revision	Date of Revision	Affected Pages	Description
A	November, 2008	All	Production release

Blank Page

FLIGHT INSTRUMENTS	1
Selecting the Altimeter Barometric Pressure Setting	1
Selecting Standard Barometric Pressure (29.92 in Hg)	1
Change Altimeter Barometric Pressure Setting Units	1
Synchronizing the Altimeter Barometric Pressure Settings	1
Synchronize CDI	1
Change Navigation Sources	2
Enable/Disable OBS Mode While Navigating with GPS	2
Generic Timer	2
Configure Vspeed Bugs Individually	2
Turn Vspeed Bugs On or Off by Category	3
Set Barometric/Radar Altimeter Minimum Descent Altitude	3
Testing the Radar Altimeter	3
Displaying Wind Data	3
NAV/COM/TRANSPONDER/AUDIO PANEL	5
ADF Tuning (Optional)	5
DME Tuning	5
Enter a Transponder Code	5
Activate ADS-B Transmit	5
Selecting a COM Radio	5
Selecting a NAV Radio	6
NAV/COM Tuning	6
Intercom	6
Passenger Address (PA) System	7
Clearance Recorder and Player	7
AUTOMATIC FLIGHT CONTROL SYSTEM	9
Flight Director Activation	9
Vertical Modes	10
Lateral Modes	11
GPS NAVIGATION	13
Direct-to Navigation	13
Activate a Stored Flight Plan	14
Activate a Flight Plan Leg	14
Stop Navigating a Flight Plan	15
Vertical Navigation (VNAV)	15
FLIGHT PLANNING	17
Weight Planning	17
Trip Planning	17
Create a New User Waypoint Defined by Latitude & Longitude	19

Create a New User Waypoint Defined by Radials from Other Waypoints	20
Create a New User Waypoint Defined by a Radial & Distance from Another Waypoint.....	21
Delete a User Waypoint.....	23
Create a New Flight Plan	23
Import a Flight Plan from an SD Card	24
Insert a Waypoint in the Active Flight Plan	25
Enter an Airway in a Flight Plan.....	26
Invert An Active Flight Plan.....	26
Remove a Departure, Arrival, Approach, or Airway from a Flight Plan	27
Store a Flight Plan	27
Edit a Stored Flight Plan	27
Delete a Waypoint from the Flight Plan	28
Invert and Activate a Stored Flight Plan.....	28
Copy a Flight Plan.....	28
Delete a Flight Plan.....	29
Graphical Flight Plan Creation.....	29
Export a Flight Plan to an SD Card	29
PROCEDURES	31
Load and Activate a Departure Procedure	31
Activate A Departure Leg	31
Load An Arrival Procedure	31
Activate An Arrival Leg	32
Load and/or Activate an Approach Procedure	32
Activate An Approach in the Active Flight Plan.....	33
Activate a Vector to Final Approach Fix	33
Activate A Missed Approach in the Active Flight Plan	33
HAZARD AVOIDANCE	35
Customizing the Hazard Displays on the Navigation Map	35
STORMSCOPE® (Optional)	35
XM Weather (Optional).....	37
Traffic Systems	38
Terrain Awareness & Warning System (TAWS) Display.....	40
Airborne Color Weather Radar	42
ADDITIONAL FEATURES	45
Synthetic Vision.....	45
Terminal Procedure Charts	46
XM® Radio Entertainment.....	48

ANNUNCIATIONS & ALERTS	51
Advisory Annunciations	51
Comparator Annunciations	51
Reversionary Sensor Annunciations	52
AFCS Alerts	52
TAWS Alerts	53
Aural Alerts	55
MFD & PFD Message Advisories	56
Database Message Advisories	57
GMA 1347D Message Advisories	60
GIA 63W Message Advisories	61
GEA 71 Message Advisories	64
GTX 33 Message Advisories	64
GRS 77 Message Advisories	65
GMU 44 Message Advisories	67
GDL 69A Message Advisories	67
GWX 68 Alert Messages	68
GDC 74B Message Advisories	68
GCU 477 Message Advisories	69
GMC 710 Message Advisories	69
Miscellaneous Message Advisories	70
APPENDIX	75
PFD Softkey Map	75
MFD Softkey Map	80
INDEX	Index-1

Blank Page

FLIGHT INSTRUMENTS

SELECTING THE ALTIMETER BAROMETRIC PRESSURE SETTING

Turn the **BARO** Knob to select the desired setting.

SELECTING STANDARD BAROMETRIC PRESSURE (29.92 IN HG)

Push the **BARO** Knob to select standard pressure.

CHANGE ALTIMETER BAROMETRIC PRESSURE SETTING UNITS

- 1) Press the **PFD** Softkey to display the second-level softkeys.
- 2) Press the **ALT UNIT** Softkey.
- 3) Press the **IN** Softkey to display the barometric pressure setting in inches of mercury (in Hg).

Or:

Press the **HPA** Softkey to display the barometric pressure setting in hectopascals.

- 4) Press the **BACK** Softkey to return to the top-level softkeys.

SYNCHRONIZING THE ALTIMETER BAROMETRIC PRESSURE SETTINGS

- 1) Select the **AUX-SYSTEM SETUP** Page on the MFD.
- 2) Press the **FMS** Knob to activate the cursor.
- 3) Turn the large **FMS** Knob to highlight **BARO** in **SYNCHRONIZATION** Window.
- 4) Turn the small **FMS** Knob clockwise to **ON** or counterclockwise to **OFF**.

SYNCHRONIZE CDI

- 1) Select the **AUX-SYSTEM SETUP** Page on the MFD.
- 2) Press the **FMS** Knob to activate the cursor.
- 3) Turn the large **FMS** Knob to highlight **CDI** in **SYNCHRONIZATION** Window.
- 4) Turn the small **FMS** Knob clockwise to **ON** or counterclockwise to **OFF**.

CHANGE NAVIGATION SOURCES

- 1) Press the **CDI** Softkey to change from GPS to VOR1 or LOC1. This changes the NAV1 standby frequency in the upper left corner of the PFD to light blue, indicating this is the frequency selected for tuning.
- 2) Press the **CDI** Softkey again to change from VOR1 or LOC1 to VOR2 or LOC2. This changes the NAV2 standby frequency in the upper left corner of the PFD to light blue, indicating this is the frequency selected for tuning.
- 3) Press the **CDI** Softkey a third time to return to GPS.

ENABLE/DISABLE OBS MODE WHILE NAVIGATING WITH GPS

- 1) Press the **OBS** Softkey to select OBS Mode.
- 2) Turn a **CRS** Knob to select the desired course to/from the waypoint. Press a **CRS** Knob to synchronize the Selected Course with the bearing to the next waypoint.
- 3) Press the **OBS** Softkey again to disable OBS Mode.

GENERIC TIMER

- 1) Press the **TMR/REF** Softkey, then turn the large **FMS** Knob to select the time field (hh/mm/ss). Turn the **FMS** Knobs to set the desired time, then press the **ENT** Key. The UP/DOWN field is now highlighted.
- 2) Turn the small **FMS** Knob to display the UP/DOWN window. Turn the **FMS** Knob to select 'UP' or 'DOWN', then press the **ENT** Key. 'START?' is now highlighted.
- 3) Press the **ENT** Key to START, STOP, or RESET the timer (if the timer is counting DOWN, it will start counting UP after reaching zero). Press the **CLR** Key or the **TMR/REF** Softkey to remove the window.

CONFIGURE VSPEED BUGS INDIVIDUALLY

- 1) Press the **TMR/REF** Softkey.
- 2) Turn the large **FMS** Knob to highlight the desired Vspeed.
- 3) Use the small **FMS** Knob to change the Vspeed in 1-kt increments (when a speed has been changed from a default value, an asterisk appears next to the speed).
- 4) Press the **ENT** Key or turn the large **FMS** Knob to highlight the ON/OFF field

- 5) Turn the small **FMS** Knob clockwise to ON or counterclockwise to OFF.
- 6) To remove the window, press the **CLR** Key or the **TMR/REF** Softkey.

TURN VSPEED BUGS ON OR OFF BY CATEGORY

- 1) Press the **TMR/REF** Softkey.
- 2) Press the **MENU** Key.
- 3) Turn the **FMS** Knob to highlight the desired option.
- 4) Press the **ENT** Key. Press the **TMR/REF** Softkey to remove the window.

SET BAROMETRIC/RADAR ALTIMETER MINIMUM DESCENT ALTITUDE

- 1) Press the **TMR/REF** Softkey.
- 2) Turn the large **FMS** Knob to highlight the OFF/BARO/RAD ALT field to the right of 'MINIMUMS'.
- 3) Turn the small **FMS** Knob clockwise to select BARO or RAD ALT.
- 4) Press the **ENT** Key.
- 5) Use the small **FMS** Knob to enter the desired altitude.
- 6) Press the **ENT** Key.
- 7) To remove the window, press the **CLR** Key or the **TMR/REF** Softkey.

TESTING THE RADAR ALTIMETER

- 1) Select the AUX-SYSTEM STATUS Page on the MFD.
- 2) Select the **RA TEST** Softkey. The Radar Altitude window displays 50 feet, indicating a properly functioning system.
- 3) Selecting the **RA TEST** Softkey again, or exiting the System Status Page cancels the test.

DISPLAYING WIND DATA

- 1) Press the **PFD** Softkey.
- 2) Press the **WIND** Softkey to display wind data below the Selected Heading.
- 3) Press one of the **OPTN** softkeys to change how wind data is displayed.
- 4) To remove the Wind Data Window, press the **OFF** Softkey.

Flight Instruments

Nav/Com/XPDR/Audio

AFCS

GPS Nav

Flight Planning

Procedures

Hazard Avoidance

Additional Features

Annun/Alerts

Appendix

Index

Blank Page

NAV/COM/TRANSPONDER/AUDIO PANEL

ADF TUNING (OPTIONAL)

Tune the ADF using the remote ADF control head.

DME TUNING

- 1) Press the **DME** Softkey.
- 2) Turn the large **FMS** to select the DME source field.
- 3) Turn the small **FMS** Knob to select the desired Nav radio.
- 4) Press the **ENT** Key to complete the selection.

ENTER A TRANSPONDER CODE

- 1) Press the **XPDR** Softkey to display the transponder mode selection softkeys.
- 2) Press the **XPDR1** or **XPDR2** Softkey to select the active transponder.
- 3) Press the **CODE** Softkey to display the transponder code selection softkeys, for digit entry.
- 4) Press the digit softkeys to enter the code in the code field. When entering the code, the next key in sequence must be pressed within 10 seconds, or the entry is cancelled and restored to the previous code. Five seconds after the fourth digit has been entered, the transponder code becomes active.

ACTIVATE ADS-B TRANSMIT

- 1) Press the **XPDR** Softkey to display the transponder mode selection softkeys.
- 2) Press the **ADS-B TX** Softkey to enable transmission of three-dimensional aircraft position and aircraft heading.
- 3) Press the **ADS-B TX** Softkey again to disable transmission.

SELECTING A COM RADIO

Transmit/Receive

Press the **COM1 MIC**, **COM2 MIC**, or **COM3 MIC** Key (optional COM, if installed) on the audio panel.

Receive Only

Press the **COM1**, **COM2**, or **COM3** Key (optional COM, if installed) on the audio panel.

SELECTING A NAV RADIO

- 1) Press the **CDI** Softkey to select NAV1 (VOR1/LOC1) or NAV2 (VOR2/LOC2).
- 2) Pressing the **NAV1**, **NAV2**, **DME**, or **ADF** Key on the audio panel selects and deselects the navigation radio audio source. All radio keys can be selected individually or together.

NAV/COM TUNING

- 1) Press the small tuning knob to select the desired radio for tuning. A light blue box highlights the radio frequency to be tuned.
- 2) Turn the respective tuning knobs to enter the desired frequency into the standby frequency field. The large knob enters MHz and the small knob enters kHz.
- 3) Press the **Frequency Transfer** Key to place the frequency into the active frequency field.

INTERCOM

Pressing the **INTR COM** Key on either Audio Panel selects and deselects the intercom on both Audio Panels. The annunciator is lit when the intercom is active. The intercom connects the pilot and copilot together. Either the pilot or copilot may select or deselect the intercom.

The **CABIN** Key initiates two way communication between the pilot or copilot and the passengers in the cabin. The annunciator is lit when the cabin intercom is active on either Audio Panel.

The **MAN SQ** Key allows either automatic or manual control of the intercom squelch setting. Pressing the **MAN SQ** Key enables manual squelch control, indicated by the MAN SQ annunciator.

During manual squelch operation, pressing the **ICS** Knob switches between volume and squelch adjustment, lighting the associated annunciator beneath the knob. When the MAN SQ annunciator is lit, the **ICS** Knob controls both volume and squelch. When the MAN SQ annunciator is extinguished, the **ICS** Knob controls only volume.

PASSENGER ADDRESS (PA) SYSTEM

A passenger address system is provided by pressing the **PA** Key to deliver messages to the passengers. The message is heard by the other pilot on the headset only if the **PA** Key is enabled on both audio panels. PA messages are one way from the flight deck to the passengers.

CLEARANCE RECORDER AND PLAYER



NOTE: *Pressing the play key on the pilot's Audio Panel plays recorded audio to the Pilot. Pressing the play key on the Copilot's Audio Panel plays recorded audio to the Copilot.*

Recorded COM audio is stored in separate memory blocks. Once 2.5 minutes of recording time have been reached, the recorder begins recording over the stored memory blocks, starting from the oldest block.

The **PLAY** Key controls the play function. The **PLAY** annunciator is illuminated to indicate when play is in progress. The **PLAY** annunciator extinguishes after playback is finished.

Pressing the **PLAY** Key once plays the latest recorded memory block and then returns to normal operation. Pressing the **PLAY** Key again during play of a memory block stops play. If a COM input signal is detected during play of a recorded memory block, play is halted.

Pressing the **PLAY** Key twice within one-half second while audio is playing plays the previous block of recorded audio. Each subsequent two presses of the **PLAY** Key within one-half second backtracks through the recorded memory blocks to reach and play any recorded block.

- Flight Instruments
- Nav/Com/XPDR/Audio
- AFCs
- GPS Nav
- Flight Planning
- Procedures
- Hazard Avoidance
- Additional Features
- Annun/Alerts
- Appendix
- Index

Flight
Instruments

Nav/Com/
XPDR/Audio

AFCS

GPS Nav

Flight
Planning

Procedures

Hazard
Avoidance

Additional
Features

Annun/Alerts

Appendix

Index

Blank Page

AUTOMATIC FLIGHT CONTROL SYSTEM



NOTE: If sensor information (other than attitude) required for a flight director mode becomes invalid or unavailable, the flight director automatically reverts to the default mode for that axis.



NOTE: If the attitude information required for the default flight director modes becomes invalid or unavailable, the autopilot automatically disengages.

FLIGHT DIRECTOR ACTIVATION

An initial press of a key listed in the following table (when the flight director is not active) activates the pilot-side flight director in the listed modes.

Control Pressed	Modes Selected			
	Lateral		Vertical	
FD Key	Roll Hold (default)	ROL	Pitch Hold (default)	PIT
AP Key	Roll Hold (default)	ROL	Pitch Hold (default)	PIT
CWS Button	Roll Hold (default)	ROL	Pitch Hold (default)	PIT
GA Switch	Takeoff (on ground)	TO	Takeoff (on ground)	TO
	Go Around (in air)	GA	Go Around (in air)	GA
ALT Key	Roll Hold (default)	ROL	Altitude Hold	ALT
VS Key	Roll Hold (default)	ROL	Vertical Speed	VS
VNV Key	Roll Hold (default)	ROL	Vertical Path Tracking*	VPTH
NAV Key	Navigation**	GPS	Pitch Hold (default)	PIT
		VOR		
		LOC		
BC Key	Backcourse***	BC	Pitch Hold (default)	PIT
APR Key	Approach**	GPS	Pitch Hold (default)	PIT
		VAPP	Glideslope	GP
		LOC	Glideslope	GS
HDG Key	Heading Select	HDG	Pitch Hold (default)	PIT

*Valid VNV flight plan must be entered before **VNV** Key press activates flight director.

The selected navigation receiver must have a valid VOR or LOC signal or active GPS course before **NAV or **APR** Key press activates flight director.

***The selected navigation receiver must have a valid LOC signal before **BC** Key press activates flight director.

VERTICAL MODES

Vertical Mode	Description	Control	Annunciation
Pitch Hold	Holds the current aircraft pitch attitude; may be used to climb/descend to the Selected Altitude	(default)	PIT
Selected Altitude Armed	AFCS armed to capture the altitude displayed in the Selected Altitude window	*	ALTS
Altitude Hold	Holds the current Altitude Reference	ALT Key	ALT nnnnn FT
Vertical Speed	Maintains the current aircraft vertical speed; may be used to climb/descend to the Selected Altitude	VS Key	VS nnnn FPM
Flight Level Change, IAS Hold	Maintains the current aircraft airspeed (in IAS or Mach) while the aircraft is climbing/descending to the Selected Altitude. Press the SPD Key to switch between IAS and MACH.	FLC Key	FLC nnn KT
Flight Level Change, Mach Hold			FLC M .nnn
VNAV	Captures and tracks the VNAV flight path	VNV Key	VPTH
VNAV Target Altitude Armed	AFCS armed to capture the altitude displayed in the VNAV Target Altitude window	**	ALTV
Glidepath	Captures and tracks the WAAS glidepath on approach	APR Key	GP
Glideslope	Captures and tracks the ILS glideslope on approach		GS
Takeoff (on ground)	Disengages the autopilot and commands a constant pitch angle and wings level in the air on the ground in preparation for takeoff	GA Switch	TO
Go Around (in air)	Disengages the autopilot and commands a constant pitch attitude and wings level in the air		GA

* ALTS armed automatically when PIT, VS, FLC, TO, or GA active, and under VPTH when Selected Altitude is to be captured instead of VNAV Target Altitude

** ALTV armed automatically under VPTH when VNAV Target Altitude is to be captured instead of Selected Altitude

LATERAL MODES

Lateral Mode	Description	Control	Annunciation
Roll Hold	Holds current aircraft roll attitude or rolls wings level, depending on commanded bank angle	(default)	ROL
Low Bank	Limits maximum commanded roll angle	BANK Key	*
Heading Select	Captures and tracks Selected Heading	HDG Key	HDG
Navigation, GPS Arm/ Capture/Track	Captures and tracks selected navigation source (GPS, VOR, LOC)	NAV Key	GPS
Navigation, VOR Enroute Arm/Capture/Track			VOR
Navigation, LOC Arm/ Capture/Track (No Glideslope)			LOC
Backcourse Arm/Capture/ Track	Captures and tracks a localizer signal for backcourse approaches	BC Key	BC
Approach, GPS Arm/ Capture/Track	Captures and tracks selected navigation source (GPS, VOR, LOC)	APR Key	GPS
Approach, VOR Arm/ Capture/Track			VAPP
Approach, ILS Arm/ Capture/Track (Glideslope Mode automatically armed)			LOC
Takeoff (on ground)	Disengages autopilot and commands a constant pitch angle and wings level in preparation for takeoff	GA Switch	TO
Go Around (in air)	Disengages autopilot and commands a constant pitch angle and wings level in the air		GA

* No annunciation appears in the AFCS Status Box. The acceptable bank angle range is indicated in green along the Roll Scale of the Attitude Indicator.

- Flight Instruments
- Nav/Com/XPR/Audio
- AFCS**
- GPS Nav
- Flight Planning
- Procedures
- Hazard Avoidance
- Additional Features
- Annun/Alerts
- Appendix
- Index

Flight Instruments

Nav/Com/XPDR/Audio

AFCS

GPS Nav

Flight Planning

Procedures

Hazard Avoidance

Additional Features

Annun/Alerts

Appendix

Index

Blank Page

GPS NAVIGATION

DIRECT-TO NAVIGATION

Direct-to Navigation from the MFD

- 1) Press the **Direct-to** (D➤) Key on the Control Unit.
- 2) Enter the waypoint identifier.
- 3) Press the **ENT** Key to confirm the identifier. The 'Activate?' field is highlighted.
- 4) If no altitude constraint or course is desired, press the **ENT** Key to activate. To enter an altitude constraint, proceed to step 5.
- 5) Turn the large **FMS** Knob to place the cursor over the 'VNV' altitude field.
- 6) Enter the desired altitude.
- 7) Press the **ENT** Key. If the waypoint entered is an airport, the option to select MSL or AGL is now displayed. If the waypoint is not an airport, proceed to step 9.
- 8) Turn the small **FMS** Knob to select 'MSL' or 'AGL'.
- 9) Press the **ENT** Key. The cursor is now flashing in the VNV offset distance field.
- 10) Enter the desired offset distance before (-) or after (+) the waypoint.
- 11) Press the **ENT** Key. The 'Activate?' field is highlighted.
- 12) Press the **ENT** Key to activate.

Direct-to Navigation from the PFD

- 1) Press the **Direct-to** Key (D➤) on the PFD.
- 2) Turn the large **FMS** Knob to place the cursor in the desired selection field.
- 3) Turn the small **FMS** Knob to begin selecting the desired identifier, location, etc.
- 4) Press the **ENT** Key.
- 5) The cursor is now flashing on 'ACTIVATE?'. If no altitude constraint or course is desired, press the **ENT** Key to activate. To enter an altitude constraint, proceed to step 6.
- 6) Turn the large **FMS** Knob to place the cursor over the 'ALT' altitude field.

- Flight Instruments
- Nav/Com/XPDR/Audio
- AFCs
- GPS Nav
- Flight Planning
- Procedures
- Hazard Avoidance
- Additional Features
- Annun/Alerts
- Appendix
- Index

- 7) Turn the small **FMS** Knob to enter the desired altitude.
- 8) Press the **ENT** Key. If the waypoint entered is an airport, the option to select MSL or AGL is now displayed. If the waypoint is not an airport, proceed to step 10.
- 9) Turn the small **FMS** Knob to select 'MSL' or 'AGL'.
- 10) Press the **ENT** Key. The cursor is placed in the 'OFFSET' offset distance field.
- 11) Turn the small **FMS** Knob to enter the desired target altitude offset from the selected Direct-to.
- 12) Press the **ENT** Key to highlight 'Activate?' or turn the large **FMS** Knob to highlight the 'CRS' field.
- 13) Turn the small **FMS** Knob to enter the desired course to the waypoint.
- 14) Press the **ENT** Key to highlight 'ACTIVATE?'.
- 15) Press the **ENT** again to activate the Direct-to.

ACTIVATE A STORED FLIGHT PLAN

- 1) Press the **FPL** Key on the Control Unit and turn the small **FMS** Knob to display the Flight Plan Catalog Page.
- 2) Press the **FMS** Knob to activate the cursor.
- 3) Turn the large **FMS** Knob to highlight the desired flight plan
- 4) Select the **ACTIVE** Softkey. The confirmation window is now displayed.
- 5) With 'OK' highlighted, press the **ENT** Key to activate the flight plan. To cancel the flight plan activation, turn the large **FMS** Knob to highlight 'CANCEL' and press the **ENT** Key.

ACTIVATE A FLIGHT PLAN LEG

- 1) From the Active Flight Plan Page, press the **FMS** Knob to activate the cursor and turn the large **FMS** Knob to highlight the desired waypoint.
- 2) Select the **ACT LEG** Softkey.
OR
Press the **MENU** Key, select the 'Activate Leg' option from the page menu and press the **ENT** Key. This step must be used when activating a leg from the PFD.
- 3) With 'Activate' highlighted, press the **ENT** Key.

STOP NAVIGATING A FLIGHT PLAN

- 1) Press the **FPL** Key on the Control Unit to display the Active Flight Plan Page.
- 2) Press the **MENU** Key to display the Page Menu Window.
- 3) Turn the large **FMS** Knob to highlight 'Delete Flight Plan' and press the **ENT** Key. With 'OK' highlighted, press the **ENT** Key to deactivate the flight plan. This will not delete the stored flight plan, only the active flight plan.

VERTICAL NAVIGATION (VNAV)

The navigation database only contains altitudes for procedures that call for “Cross at” altitudes. If the procedure states “Expect to cross at,” the altitude is not in the database. In this case the altitude may be entered manually.

ACTIVE FLIGHT PLAN			
KIXD / KDFW			
	DTK	DIS	ALT
KARLA	221°	11.7NM	13000FT
COVIE	221°	9.0NM	12400FT
LEMYN	220°	8.0NM	9900FT
Approach - KDFW-RNAV 17L GPs LPV			
RIVET iaf	259°	18.8NM	4000FT
DRAAK	176°	3.3NM	2000FT
INWOD	176°	3.2NM	3000FT
MENOL faf	176°	3.9NM	<u>2300FT</u>
RW17L map	176°	5.3NM	
990FT	174°	0.8NM	<u>990FT</u>
POLKE			

Large White Text

Large Light Blue Text

Small Light Blue Text

Small Light Blue Subdued Text

Small White Text with Altitude Restriction Bar



Cross AT or ABOVE 5,000 ft



Cross AT 2,300 ft



Cross AT or BELOW 3,000 ft

Altitudes associated with arrival and approach procedures are “auto-designated”. This means the system will automatically use the altitudes loaded with the arrival or approach for giving vertical flight path guidance outside the FAF. Note that these altitudes will be displayed as small light blue text.

Altitudes that have been designated for use in vertical navigation may also be made “non-designated” by placing the cursor over the desired altitude and pressing the **CLR** Key. The altitude is now displayed only as a reference. It will not be used to give flight path vertical guidance. Other displayed altitudes may change due to re-calculations or rendered invalid as a result of manually changing an altitude to a non-designated altitude.

	White Text	Light Blue Text	Light Blue Subdued Text
Large Text	Altitude calculated by the system estimating the altitude of the aircraft as it passes over the navigation point. This altitude is provided as a reference and is not designated to be used in determining vertical flight path guidance.	Altitude has been entered by the pilot. Altitude is designated for use in giving vertical flight path guidance. Altitude does not match the published altitude in navigation database or no published altitude exists.	The system cannot use this altitude in determining vertical flight path guidance.
Small Text	Altitude is not designated to be used in determining vertical flight path guidance. Altitude has been retrieved from the navigation database and is provided as a reference.	Altitude is designated for use in giving vertical flight path guidance. Altitude has been retrieved from the navigation database or has been entered by the pilot and matches a published altitude in the navigation database.	The system cannot use this altitude in determining vertical flight path guidance.

FLIGHT PLANNING

WEIGHT PLANNING

All procedures apply to the MFD and the Control Unit unless otherwise stated.

Entering Weight Parameters

The Weight Planning Page is displayed after system power-up. If it is necessary to return to this page, turn the large **FMS** Knob to select the 'AUX' page group. Turn the small **FMS** Knob to select the Weight Planning Page.

- 1) Select the **EMPTY WT** Softkey to place the cursor in the Basic Empty Weight field.
- 2) Enter the desired aircraft empty weight.
- 3) Press the **ENT** Key. The cursor is now over the 'PILOT & STORES' field.
- 4) Enter the desired weight of Pilot & Stores.
- 5) Press the **ENT** Key.
- 6) Continue repeating these steps until all desired weights have been entered.

Entering Fuel Parameters

- 1) Press the **FMS** Knob to activate the cursor.
- 2) Turn the large **FMS** Knob to place the cursor in the 'FUEL ON BOARD' field.
- 3) Turn the small **FMS** Knob to enter the desired fuel quantity.
- 4) Press the **ENT** Key. The cursor is now in the 'FUEL RESERVES' field.
- 5) Turn the small **FMS** Knob to enter the desired reserve fuel quantity.
- 6) Press the **FMS** Knob to remove the cursor.
- 7) Press the **ENT** Key.

TRIP PLANNING

- 1) Turn the large **FMS** Knob on the Control Unit to select the 'AUX' page group.
- 2) Turn the small **FMS** Knob to select the Trip Planning Page.
- 3) The current 'PAGE MODE' is displayed at the top of the page: 'AUTOMATIC' or 'MANUAL'. To change the page mode, select the **AUTO** or **MANUAL** Softkey.

- Flight Instruments
- Nav/Com/XPDR/Audio
- AFCs
- GPS Nav
- Flight Planning
- Procedures
- Hazard Avoidance
- Additional Features
- Annun/Alerts
- Appendix
- Index

- 4) For Direct-to planning:
 - a) Select the **WPTS** Softkey and verify that the starting waypoint field indicates 'P.POS' (present position).
 - b) If necessary, press the **MENU** Key and select 'Set WPT to Present Position' to display 'P.POS'.
 - c) Press the **ENT** Key and the flashing cursor moves to the ending waypoint field.
 - d) Enter the identifier of the ending waypoint and press the **ENT** Key to accept the waypoint.

Or:

For point-to-point planning:

- a) Enter the identifier of the starting waypoint.
- b) Once the waypoint's identifier is entered, press the **ENT** Key to accept the waypoint. The flashing cursor moves to the ending waypoint.
- c) Again, enter the identifier of the ending waypoint.
- d) Press the **ENT** Key to accept the waypoint.

Or:

For flight plan leg planning:

- a) Select the **FPL** Softkey (at the bottom of the display).
- b) Turn the small **FMS** Knob to select the desired flight plan (already stored in memory), by number.
- c) Turn the large **FMS** Knob to highlight the 'LEG' field.
- d) Turn the small **FMS** Knob to select the desired leg of the flight plan, or select 'CUM' to apply trip planning calculations to the entire flight plan. Selecting 'FPL 00' will display the active flight plan. If an active flight plan is selected, 'REM' will be an available option to display planning data for the remainder of the flight plan.

NOTE: *The page mode must be set to 'MANUAL' to perform the following steps.*

- 5) Turn the large **FMS** Knob to highlight the departure time (DEP TIME) field.

NOTE: *The departure time on the Trip Planning Page is used for preflight planning. Refer to the Utility Page for the actual flight departure time.*

- Flight Instruments
- Nav/Com/XPDR/Audio
- AFCs
- GPS Nav
- Flight Planning
- Procedures
- Hazard Avoidance
- Additional Features
- Annun/Alerts
- Appendix
- Index

- 6) Enter the departure time. Press the **ENT** Key when finished. Departure time may be entered in local or UTC time, depending upon system settings.
- 7) Enter the fuel flow. Press the **ENT** Key when finished. Note that in 'AUTOMATIC' page mode, fuel flow is provided by the system.
- 8) The flashing cursor moves to the fuel onboard field. Modify the fuel onboard. Press the **ENT** Key when finished. In 'AUTOMATIC' mode, fuel onboard is provided by the entry made on the Weight Planning Page.
- 9) The flashing cursor moves to the calibrated airspeed field. Enter a calibrated airspeed. Press the **ENT** Key when finished.

CREATE A NEW USER WAYPOINT DEFINED BY LATITUDE & LONGITUDE

- 1) Turn the large **FMS** Knob on the Control Unit to select the 'WPT' page group.
- 2) Turn the small **FMS** Knob to select the User WPT Information Page.
- 3) Press the **NEW** Softkey. A waypoint is created at the current aircraft position.
- 4) Enter the desired waypoint name.
- 5) Press the **ENT** Key.
- 6) The cursor is now in the 'WAYPOINT TYPE' field. If desired, the waypoint can be made temporary (deleted automatically when the system is turned off). If the waypoint is to remain in the system, proceed to step 7.
 - a) Turn the large **FMS** Knob one click to the left to highlight 'TEMPORARY'. This list is populated only when there is an active flight plan.
 - b) Press the **ENT** Key to place a check-mark in the box.
- 7) The cursor is now in the 'WAYPOINT TYPE' field. Turn the small **FMS** Knob to display a list waypoint types.
- 8) Turn the small **FMS** Knob to select LAT/LON (latitude and longitude).
- 9) Press the **ENT** Key.

- Flight Instruments
- Nav/Com/XPDR/Audio
- AFCs
- GPS Nav
- Flight Planning
- Procedures
- Hazard Avoidance
- Additional Features
- Annun/Alerts
- Appendix
- Index

CREATE A NEW USER WAYPOINT DEFINED BY RADIALS FROM OTHER WAYPOINTS

- 1) Turn the large **FMS** Knob on the Control Unit to select the 'WPT' page group.
 - 2) Turn the small **FMS** Knob to select the User WPT Information Page.
 - 3) Press the **NEW** Softkey. A waypoint is created at the current aircraft position.
 - 4) Enter the desired waypoint name.
 - 5) Press the **ENT** Key.
 - 6) The cursor is now in the 'WAYPOINT TYPE' field. If desired, the waypoint can be made temporary (deleted automatically when the system is turned off). If the waypoint is to remain in the system, proceed to step 7.
 - a) Turn the large **FMS** Knob one click to the left to highlight 'TEMPORARY'. This list is populated only when there is an active flight plan.
 - b) Press the **ENT** Key to place a check-mark in the box.
 - 7) The cursor is now in the 'WAYPOINT TYPE' field. Turn the small **FMS** Knob to display a list waypoint types.
 - 8) Turn the small **FMS** Knob to select RAD/RAD (radial/radial).
 - 9) Press the **ENT** Key.
 - 10) The cursor moves to the 'REFERENCE WAYPOINTS' field. With the first waypoint name highlighted, use the **FMS** Knobs to enter the desired waypoint name. Waypoints may also be selected as follows:
 - a) When a flight plan is active, turning the small **FMS** Knob to the left will display a list of the flight plan waypoints.
 - b) Turn the large **FMS** Knob to select the desired waypoint.
 - c) Press the **ENT** Key.
- Or:**
- a) Turn the small **FMS** Knob to the left. Initially, a flight plan waypoint list is displayed.
 - b) Turn the small **FMS** Knob to the right to display the 'NRST' waypoints to the aircraft's current position.
 - c) Turn the large **FMS** Knob to select the desired waypoint.
 - d) Press the **ENT** Key.

Or:

- a) Turn the small **FMS** Knob to the left. Initially, a flight plan waypoint list is displayed.
- b) Turn the small **FMS** Knob to the right to display the 'RECENT' waypoints.
- c) Turn the large **FMS** Knob to select the desired waypoint.
- d) Press the **ENT** Key.

Or:

- a) Turn the small **FMS** Knob to the left. Initially, a flight plan waypoint list is displayed.
 - b) Turn the small **FMS** Knob to the right to display the 'USER' waypoints.
 - c) Turn the large **FMS** Knob to select the desired waypoint.
 - d) Press the **ENT** Key.
- 11) Press the **ENT** Key. The cursor is displayed in the 'RAD' (radial) field. Enter the desired radial from the reference waypoint.
 - 12) Press the **ENT** Key.
 - 13) Repeat step 10 to enter the next waypoint name.
 - 14) Press the **ENT** Key. The cursor is displayed in the 'RAD' (radial) field for the second waypoint. Enter the desired radial from the reference waypoint.
 - 15) Press the **ENT** Key.
 - 16) Press the **FMS** Knob to remove the flashing cursor.

CREATE A NEW USER WAYPOINT DEFINED BY A RADIAL & DISTANCE FROM ANOTHER WAYPOINT

- 1) Turn the large **FMS** Knob on the MFD Control Unit to select the 'WPT' page group.
- 2) Turn the small **FMS** Knob to select the User WPT Information Page.
- 3) Press the **NEW** Softkey. A waypoint is created at the current aircraft position.
- 4) Enter the desired waypoint name.
- 5) Press the **ENT** Key.

- 6)** The cursor is now in the 'WAYPOINT TYPE' field. If desired, the waypoint can be made temporary (deleted automatically when the system is turned off). If the waypoint is to remain in the system, proceed to step 7.
- a)** Turn the large **FMS** Knob one click to the left to highlight 'TEMPORARY'. This list is populated only when there is an active flight plan.
 - b)** Press the **ENT** Key to place a check-mark in the box.
- 7)** The cursor is now in the 'WAYPOINT TYPE' field. Turn the small **FMS** Knob to display a list waypoint types.
- 8)** Turn the small **FMS** Knob to select RAD/DIS (radial/distance).
- 9)** Press the **ENT** Key.
- 10)** The cursor moves to the 'REFERENCE WAYPOINTS' field. With the first waypoint name highlighted, use the **FMS** Knobs to enter the desired waypoint name. Waypoints may also be selected as follows:
- a)** When a flight plan is active, turning the small **FMS** Knob to the left will display a list of the flight plan waypoints.
 - b)** Turn the large **FMS** Knob to select the desired waypoint.
 - c)** Press the **ENT** Key.
- Or:**
- a)** Turn the small **FMS** Knob to the left. Initially, a flight plan waypoint list is displayed.
 - b)** Turn the small **FMS** Knob to the right to display the 'NRST' waypoints to the aircraft's current position.
 - c)** Turn the large **FMS** Knob to select the desired waypoint.
 - d)** Press the **ENT** Key.
- Or:**
- a)** Turn the small **FMS** Knob to the left. Initially, a flight plan waypoint list is displayed.
 - b)** Turn the small **FMS** Knob to the right to display the 'RECENT' waypoints.
 - c)** Turn the large **FMS** Knob to select the desired waypoint.
 - d)** Press the **ENT** Key.

Or:

- a) Turn the small **FMS** Knob to the left. Initially, a flight plan waypoint list is displayed.
 - b) Turn the small **FMS** Knob to the right to display the 'USER' waypoints.
 - c) Turn the large **FMS** Knob to select the desired waypoint.
 - d) Press the **ENT** Key.
- 11) Press the **ENT** Key. The cursor is displayed in the 'RAD' (radial) field. Enter the desired radial from the reference waypoint.
 - 12) Press the **ENT** Key.
 - 13) The cursor is now displayed in the 'DIS' (distance) field. Enter the desired distance from the reference waypoint.
 - 14) Press the **ENT** Key.
 - 15) Press the **FMS** Knob to remove the flashing cursor.

DELETE A USER WAYPOINT

- 1) Turn the large **FMS** Knob to select the 'WPT' page group.
- 2) Turn the small **FMS** Knob to select the User WPT Information Page.
- 3) Press the **FMS** Knob to activate the cursor.
- 4) Turn the large **FMS** Knob to place the cursor in the 'USER WAYPOINT LIST' field.
- 5) Turn the small **FMS** Knob to highlight the desired waypoint.
- 6) Select the **DELETE** Softkey.
- 7) The message 'Would you like to delete the user waypoint?' is displayed. With 'YES' highlighted, press the **ENT** Key.

CREATE A NEW FLIGHT PLAN

Using the MFD

- 1) Press the **FPL** Key on the Control Unit.
- 2) Turn the small **FMS** Knob to display the Flight Plan Catalog Page.
- 3) Select the **NEW** Softkey to display a blank flight plan for the first empty storage location.

- Flight Instruments
- Nav/Com/XPDR/Audio
- AFCs
- GPS Nav
- Flight Planning
- Procedures
- Hazard Avoidance
- Additional Features
- Annun/Alerts
- Appendix
- Index

- 4) Turn the small **FMS** Knob to display the Waypoint Information Window.
- 5) Enter the identifier of the departure waypoint.
- 6) Press the **ENT** Key.
- 7) Repeat step number 4, 5, and 6 to enter the identifier for each additional flight plan waypoint.
- 8) When all waypoints have been entered, press the **FMS** Knob to return to the Flight Plan Catalog Page. The new flight plan is now in the list.

Using the PFD



NOTE: If a flight plan is active, an additional flight plan cannot be entered using the PFD.



NOTE: After the first leg is entered (using the PFD only) it is immediately activated.

- 1) Press the **FPL** Key on the PFD.
- 2) Press the **FMS** Knob to activate the cursor.
- 3) Turn the small **FMS** Knob to enter the first letter of the destination waypoint identifier.
- 4) Turn the large **FMS** Knob to the right to move the cursor to the next character position.
- 5) Repeat step 3 and 4 to spell out the rest of the waypoint identifier.
- 6) Press the **ENT** Key and the cursor is now ready for entering of the next flight plan waypoint.
- 7) Repeat steps 3 through 6 to enter the identifier for each additional flight plan waypoint.
- 8) Once all waypoints have been entered, press the **FMS** Knob to remove the cursor. The new flight plan is now active.

IMPORT A FLIGHT PLAN FROM AN SD CARD

- 1) Insert the SD card containing the flight plan in the top card slot on the MFD.
- 2) Press the **FPL** Key on the Control Unit to display the Active Flight Plan Page on the MFD.

- 3) Turn the small **FMS** Knob to select the Flight Plan Catalog Page.
- 4) Press the **FMS** Knob to activate the cursor.
- 5) Turn either **FMS** Knob to highlight an empty or existing flight plan.
- 6) Press the **IMPORT** Softkey.

If an empty flight plan is selected, a list of the available flight plans on the SD card will be displayed.

Or:

If an existing flight plan is selected, an 'Overwrite existing flight plan? OK or CANCEL' prompt is displayed. Press the **ENT** Key to choose to overwrite the selected flight plan and see a list of the available flight plans on the SD card. If overwriting the existing flight plan is not desired, select 'CANCEL' using the **FMS** Knob, press the **ENT** Key, select another existing or empty flight plan, and again press the **IMPORT** Softkey.

- 7) Turn the small **FMS** Knob to highlight the desired flight plan for importing.
- 8) Press the **ENT** Key.

INSERT A WAYPOINT IN THE ACTIVE FLIGHT PLAN

- 1) Press the **FPL** Key on the Control Unit to display the active flight plan.
- 2) Press the **FMS** Knob to activate the cursor.
- 3) Turn the large **FMS** Knob to highlight the desired flight plan waypoint. The new waypoint will be inserted before the highlighted waypoint.
- 4) Turn the small **FMS** Knob. The Waypoint Information Window is now displayed.
- 5) Enter the new flight plan waypoint by one of the following:
 - a) Enter the user waypoint identifier, facility, or city.
 - b) Press the **ENT** Key.

Or:

- a) Turn the small **FMS** Knob to the left. Initially, a flight plan waypoint list is displayed.
- b) Turn the small **FMS** Knob to the right to display the 'NRST' airport waypoints to the aircraft's current position.
- c) Turn the large **FMS** Knob to select the desired waypoint.
- d) Press the **ENT** Key.

Or:

- a) Turn the small **FMS** Knob to the left. Initially, a flight plan waypoint list is displayed.
- b) Turn the small **FMS** Knob to the right to display the 'RECENT' waypoints.
- c) Turn the large **FMS** Knob to select the desired waypoint.
- d) Press the **ENT** Key.

ENTER AN AIRWAY IN A FLIGHT PLAN

- 1) Press the **FPL** Key on the Control Unit.
- 2) Press the **FMS** Knob to activate the cursor (not required on the PFD).
- 3) Turn the large **FMS** Knob to highlight the waypoint after the desired airway entry point. If this waypoint is not a valid airway entry point, a valid entry point should be entered at this time.
- 4) Turn the small **FMS** Knob one click clockwise and press the **LD AIRWY** Softkey, or press the **MENU** Key and select "Load Airway" (required on the PFD). The Select Airway Page is displayed. The **LD AIRWY** Softkey or the "Load Airway" menu item is available only when an acceptable airway entry waypoint has been chosen (the waypoint ahead of the cursor position).
- 5) Turn the **FMS** Knob to select the desired airway from the list, and press the **ENT** Key. Low altitude airways are shown first in the list, followed by "all" altitude airways, and then high altitude airways.
- 6) Turn the **FMS** Knob to select the desired airway exit point from the list, and press the **ENT** Key. 'LOAD?' is highlighted.
- 7) Press the **ENT** Key. The system returns to editing the flight plan with the new airway inserted.

INVERT AN ACTIVE FLIGHT PLAN

- 1) Press the **FPL** Key to display the active flight plan.
- 2) Press the **MENU** Key to display the Page Menu.
- 3) Turn the large **FMS** Knob to highlight 'Invert Flight Plan'.
- 4) Press the **ENT** Key. The original flight plan remains intact in its flight plan catalog storage location.
- 5) With 'OK' highlighted, press the **ENT** Key to invert the flight plan.

REMOVE A DEPARTURE, ARRIVAL, APPROACH, OR AIRWAY FROM A FLIGHT PLAN

- 1) Press the **FPL** Key on the Control Unit to display the active flight plan. Press the **FMS** Knob to activate the cursor.

Or:

 - a) Turn the small **FMS** Knob to select the Flight Plan Catalog Page.
 - b) Press the **FMS** Knob to activate the cursor.
 - c) Turn the large **FMS** Knob to highlight the desired flight plan.
 - d) Select the **EDIT** Softkey.
- 2) Turn the large **FMS** Knob to highlight the title for the approach, departure, arrival, or airway to be deleted. Titles appear in white directly above the procedure's waypoints.
- 3) Press the **CLR** Key to display a confirmation window.
- 4) With 'OK' highlighted, press the **ENT** Key to remove the selected procedure or airway.

STORE A FLIGHT PLAN

- 1) After creating a flight plan on either the PFD or MFD, it may be saved by pressing the **MENU** Key.
- 2) Turn the large **FMS** Knob to highlight 'Store Flight Plan' and press the **ENT** Key.
- 3) With 'OK' highlighted, press the **ENT** Key to store the flight plan.

EDIT A STORED FLIGHT PLAN

- 1) Press the **FPL** Key on the Control Unit and turn the small **FMS** Knob to display the Flight Plan Catalog Page.
- 2) Press the **FMS** Knob to activate the cursor.
- 3) Turn the large **FMS** Knob to highlight the desired flight plan.
- 4) Select the **EDIT** Softkey.
- 5) Turn the large **FMS** Knob to place the cursor in the desired location.
- 6) Enter the changes, then press the **ENT** Key.
- 7) Press the **FMS** Knob to return to the Flight Plan Catalog Page.

- Flight Instruments
- Nav/Com/XPDR/Audio
- AFCs
- GPS Nav
- Flight Planning
- Procedures
- Hazard Avoidance
- Additional Features
- Annun/Alerts
- Appendix
- Index

DELETE A WAYPOINT FROM THE FLIGHT PLAN

- 1) Press the **FPL** Key to display the active flight plan. Press the **FMS** Knob to activate the cursor.
Or:
 - a) Turn the small **FMS** Knob to select the Flight Plan Catalog Page.
 - b) Press the **FMS** Knob to activate the cursor.
 - c) Turn the large **FMS** Knob to highlight the desired flight plan.
 - d) Select the **EDIT** Softkey.
- 2) Turn the large **FMS** Knob to highlight the waypoint to be deleted.
- 3) Press the **CLR** Key to display a 'REMOVE (Wpt Name)?' confirmation window.
- 4) With 'OK' highlighted, press the **ENT** Key to remove the waypoint. To cancel the delete request, turn the large **FMS** Knob to highlight 'CANCEL' and press the **ENT** Key.
- 5) Once all changes have been made, press the **FMS** Knob to remove the cursor.

INVERT AND ACTIVATE A STORED FLIGHT PLAN

- 1) Press the **FPL** Key on the Control Unit.
- 2) Turn the small **FMS** Knob to select the Flight Plan Catalog Page.
- 3) Press the **FMS** Knob to activate the cursor.
- 4) Turn the large **FMS** Knob to highlight the desired flight plan.
- 5) Select the **INVERT** Softkey. 'Invert and activate stored flight plan?' will be displayed.
- 6) With 'OK' highlighted, press the **ENT** Key. The selected flight plan is now inverted and activated. The original flight plan remains intact in its flight plan catalog storage location.

COPY A FLIGHT PLAN

- 1) Press the **FPL** Key on the Control Unit.
- 2) Turn the small **FMS** Knob to select the Flight Plan Catalog Page.
- 3) Press the **FMS** Knob to activate the cursor.

- 4) Turn the large **FMS** Knob to highlight the flight plan to be copied.
- 5) Select the **COPY** Softkey. A 'Copy to flight plan #' confirmation window is displayed.
- 6) With 'OK' highlighted, press the **ENT** Key to copy the flight plan. To cancel, turn the large **FMS** Knob to highlight 'CANCEL' and press the **ENT** Key.

DELETE A FLIGHT PLAN

- 1) Press the **FPL** Key on the Control Unit.
- 2) Turn the small **FMS** Knob to select the Flight Plan Catalog Page.
- 3) Press the **FMS** Knob to activate the cursor.
- 4) Turn the large **FMS** Knob to highlight the flight plan to be deleted.
- 5) Select the **DELETE** Softkey. A 'Delete flight plan #' confirmation window is displayed.
- 6) With 'OK' highlighted, press the **ENT** Key to delete the flight plan. To cancel, turn the large **FMS** Knob to highlight 'CANCEL' and press the **ENT** Key.

GRAPHICAL FLIGHT PLAN CREATION

- 1) Press the **FPL** Key on the Control Unit to display the Active Flight Plan Page.
- 2) Press the **Joystick** to activate the map pointer. Use the **Joystick** to move the pointer to the desired point on the map to be inserted as a waypoint in the flight plan.
- 3) The default insertion point is at the end of the flight plan. If the selected waypoint is to be placed anywhere other than the end of the flight plan, press the **FMS** Knob to activate the cursor. Waypoints are inserted *ABOVE* the cursor. Turn the large **FMS** Knob to select the desired insertion point.
- 4) Select the **LD WPT** Softkey. The selected waypoint will be inserted at the selected point. The default user waypoint naming is USR000, USR001, USR002, and so on.
- 5) To change the user waypoint name, follow the procedure for modifying a user waypoint.

EXPORT A FLIGHT PLAN TO AN SD CARD

- 1) Insert the SD card into the top card slot on the MFD.
- 2) Press the **FPL** Key on the Control Unit to display the Active Flight Plan Page on the MFD.

- Flight Instruments
- Nav/Com/XPDR/Audio
- AFCs
- GPS Nav
- Flight Planning
- Procedures
- Hazard Avoidance
- Additional Features
- Annun/Alerts
- Appendix
- Index

- 3) Turn the small **FMS** Knob to select the Flight Plan Catalog Page.
- 4) Press the **FMS** Knob to activate the cursor.
- 5) Turn the large **FMS** Knob to highlight the flight plan to be exported.
- 6) Press the **EXPORT** Softkey.
- 7) Press the **ENT** Key to confirm the export.

PROCEDURES

LOAD AND ACTIVATE A DEPARTURE PROCEDURE

- 1) Press the **PROC** Key.
- 2) Turn the large **FMS** Knob to highlight 'SELECT DEPARTURE'.
- 3) Press the **ENT** Key. The cursor is displayed in the 'DEPARTURE' field with a list of available departures.
- 4) Turn the large **FMS** Knob to highlight the desired departure.
- 5) Press the **ENT** Key. A list of runways may be displayed for the departure. If so, turn either **FMS** Knob to select the desired runway.
- 6) Press the **ENT** Key. The cursor is displayed in the 'TRANSITION' field with a list of available transitions.
- 7) Turn the large **FMS** Knob to highlight the desired transition.
- 8) Press the **ENT** Key.
- 9) With 'LOAD?' highlighted, press the **ENT** Key. The departure will be active when the flight plan is active.

ACTIVATE A DEPARTURE LEG

- 1) Press the **FPL** Key to display the active flight plan.
- 2) Press the **FMS** Knob to activate the cursor.
- 3) Turn the large **FMS** Knob to highlight the desired waypoint within the departure.
- 4) Select the **ACT LEG** Softkey. A confirmation window showing the selected leg will be displayed.
- 5) With 'ACTIVATE' highlighted, press the **ENT** Key.

LOAD AN ARRIVAL PROCEDURE

- 1) Press the **PROC** Key.
- 2) Turn the large **FMS** Knob to highlight 'SELECT ARRIVAL'.
- 3) Press the **ENT** Key. The cursor is displayed in the 'ARRIVAL' field with a list of available arrivals.
- 4) Turn the large **FMS** Knob to highlight the desired arrival.

- 5) Press the **ENT** Key. A list of transitions is displayed for the selected arrival.
- 6) Turn either **FMS** Knob to select the desired transition.
- 7) Press the **ENT** Key. A list of runways is displayed for the selected arrival.
- 8) Turn the large **FMS** Knob to highlight the desired runway.
- 9) Press the **ENT** Key.
- 10) With 'LOAD?' highlighted, press the **ENT** Key.
- 11) The arrival will become part of the active flight plan.

ACTIVATE AN ARRIVAL LEG

- 1) Press the **FPL** Key on the Control Unit to display the active flight plan.
- 2) Press the **FMS** Knob to activate the cursor.
- 3) Turn the large **FMS** Knob to highlight the desired waypoint within the arrival.
- 4) Select the **ACT LEG** Softkey. A confirmation window showing the selected leg is displayed.
- 5) With 'ACTIVATE' highlighted, press the **ENT** Key.

LOAD AND/OR ACTIVATE AN APPROACH PROCEDURE



NOTE: *If certain GPS parameters (WAAS, RAIM, etc.) are not available, some published approach procedures for the desired airport may not be displayed in the list of available approaches.*

- 1) Press the **PROC** Key.
- 2) Turn the large **FMS** Knob to highlight 'SELECT APPROACH'.
- 3) Press the **ENT** Key. A list of available approaches for the destination airport is displayed.
- 4) Turn either **FMS** Knob to highlight the desired approach.
- 5) Press the **ENT** Key. A list of available transitions for the selected approach procedure is now displayed.
- 6) Turn either **FMS** Knob to select the desired transition. The "Vectors" option assumes vectors will be received to the final course segment of the approach and will provide navigation guidance relative to the final approach course.

- 7) Press the **ENT** Key. The cursor moves to the MINIMUMS field.
- 8) If desired, the DA/MDA for the selected approach procedure may be entered and displayed on the PFD. Turn the small **FMS** Knob in the direction of the green arrow to change the display from OFF to BARO.
- 9) Press the **ENT** Key. The cursor moves to the altitude field. Turn the small **FMS** Knob to enter the published DA/MDA for the selected approach procedure.
- 10) Press the **ENT** Key. 'LOAD? or ACTIVATE?' is now displayed with 'LOAD?' highlighted.
- 11) Turn the large **FMS** Knob to select either 'LOAD?' or 'ACTIVATE?'.
Selecting 'LOAD?' enters the selected approach procedure into the active flight plan, but is not currently active. Selecting 'ACTIVATE?' enters the selected approach procedure into the active flight plan and is immediately activated.
- 12) Press the **ENT** Key.

ACTIVATE AN APPROACH IN THE ACTIVE FLIGHT PLAN

- 1) Press the **PROC** Key.
- 2) Turn the large **FMS** Knob to highlight 'ACTIVATE APPROACH'.
- 3) Press the **ENT** Key.

ACTIVATE A VECTOR TO FINAL APPROACH FIX

- 1) Press the **PROC** Key.
- 2) Turn the large **FMS** Knob to highlight 'ACTIVATE VECTOR-TO-FINAL'.
- 3) Press the **ENT** Key.
- 4) The final approach course becomes the active leg.

ACTIVATE A MISSED APPROACH IN THE ACTIVE FLIGHT PLAN

- 1) Press the **PROC** Key.
- 2) Turn the large **FMS** Knob to highlight 'ACTIVATE MISSED APPROACH'.
- 3) Press the **ENT** Key. A confirmation window will be displayed.
- 4) With 'ACTIVATE' highlighted, press the **ENT** Key.

Or:

Press the go-around button.

Flight Instruments

Nav/Com/XPDR/Audio

AFCs

GPS Nav

Flight Planning

Procedures

Hazard Avoidance

Additional Features

Annun/Alerts

Appendix

Index

Blank Page

HAZARD AVOIDANCE

CUSTOMIZING THE HAZARD DISPLAYS ON THE NAVIGATION MAP

- 1) With the Navigation Map Page displayed, press the **MENU** Key to display the Navigation Map Page Menu. The cursor flashes on the 'Map Setup' option.
- 2) Press the **ENT** Key. The Map Setup Menu is displayed. Turn the small **FMS** Knob to select 'Weather' to customize the display of weather features. Select 'Traffic' to customize the display of traffic.
- 3) Press the small **FMS** Knob to return to the Navigation Map Page.

STORMSCOPE® (OPTIONAL)



WARNING: *The Stormscope system is not intended to be used for hazardous thunderstorm penetration. Weather information on the G1000 MFD is approved for weather avoidance only. Refer to the WX-500 Pilot's Guide for detailed operation.*

Displaying Stormscope Lightning Data on the Navigation Map Page

- 1) Press the **MAP** Softkey.
- 2) Press the **STRMSCP** Softkey. Press the **STRMSCP** Softkey again to remove Stormscope Lightning Data from the Navigation Map Page.

Lightning Age	Symbol
Strike is less than 6 seconds old	
Strike is between 6 and 60 seconds old	
Strike is between 1 and 2 minutes old	
Strike is between 2 and 3 minutes old	

Select 'Cell' or 'Strike' as the Stormscope Lightning Mode

- 1) With the Weather Group selected, press the **ENT** Key. The cursor flashes on 'STRMSCP LTNG'.
- 2) Turn the large **FMS** Knob to select 'STRMSCP MODE'.

- 3) Turn the small **FMS** Knob to display the 'Cell/Strike' window.
- 4) Turn either **FMS** Knob to select 'Cell' or 'Strike'. Press the **ENT** Key.
- 5) Push the **FMS** Knob to return to the Navigation Map Page.

Clear Stormscope Lightning Data from the Navigation Map Page

- 1) Press the **MENU** Key (with the Navigation Map Page displayed).
- 2) Turn either **FMS** Knob to highlight the 'Clear Stormscope® Lightning' field and press the **ENT** Key.



NOTE: *If heading input is lost, strikes and/or cells must be cleared manually after the execution of each turn. This is to ensure that the strike and/or cell positions are depicted accurately in relation to the nose of the aircraft.*

Stormscope Page

- 1) Turn the large **FMS** Knob until the Map Page group is selected.
- 2) Turn the small **FMS** Knob select the Stormscope Page.

Change the Stormscope Lightning Mode Between 'Cell' and 'Strike'

- 1) Select the Stormscope Page.
- 2) Press the **MODE** Softkey. The **CELL** and **STRIKE** Softkeys are displayed. Press the **CELL** Softkey to display 'CELL' data or press the **STRIKE** Softkey to display 'STRIKE' data. 'CELL' or 'STRIKE' is displayed in the mode box located in the upper left corner of the Stormscope Page.



NOTE: *"Cell mode" uses a clustering program to identify clusters of electrical activity that indicate cells.*

Change the Viewing Mode Between 360° and 120°

- 1) Select the Stormscope Page.
- 2) Press the **VIEW** Softkey. The **360** and **ARC** Softkeys are displayed. Press the **360** Softkey to display a 360° viewing area or press the **ARC** Softkey to display a 120° viewing area.

Press the **CLEAR** Softkey to remove all Stormscope lightning data from the display.

XM WEATHER (OPTIONAL)



WARNING: Use of XM weather for hazardous weather penetration is not recommended. Weather information provided by XM Radio Service is approved only for weather avoidance, not penetration.

Displaying XM Weather on the Navigation Map Page

- 1) Press the **MAP** Softkey.
- 2) Press the **NEXRAD** or **XM LTNG** Softkey to display the desired weather. Press the applicable softkey again to remove weather data from the Navigation Map Page.

Display METAR and TAF information on the Airport Information Page

- 1) Turn the large **FMS** Knob to select the WPT Page Group.
- 2) Turn the small **FMS** Knob to select the Airport Information Page.
- 3) Select the **WX** Softkey to display METAR and TAF text (METAR and TAF information is updated every 12 minutes).

Displaying Weather on the Weather Data Link Page

- 1) Turn the large **FMS** Knob to select the Map Page Group.
- 2) Turn the small **FMS** Knob to select the Weather Data Link Page.
- 3) Select the available softkeys to select the desired XM weather product.
- 4) Select the **LEGEND** Softkey to view the legends for the selected products. If necessary, turn either **FMS** Knob to scroll through the list. Press the small **FMS** Knob or the **ENT** Key to return to the map.

Map Panning Information – Weather Data Link Page

- 1) Push in the **Joystick** to display the panning arrow.
 - 2) Move the **Joystick** to place the panning arrow on AIRMETS, TFRs, METARs, or SIGMETs.
 - 3) Press the **ENT** Key to display pertinent information for the selected product.
- Note that pressing the **ENT** Key when panning over an AIRMET or a SIGMET displays an information box that shows the text of the report. Panning over an airport with METAR information does not display more

information but allows the user to press the **ENT** Key and select that Airport’s Information Page to display the text of the report. Pressing the **ENT** Key when panning over a TFR displays TFR specific information.

Weather Products and Symbols

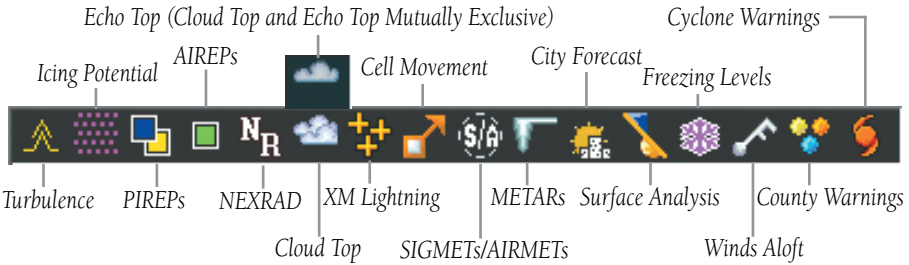

TRAFFIC SYSTEMS

- If Traffic information Service (TIS) is configured, a **STANDBY**, **OPERATE**, and **TNA MUTE** Softkey will be displayed.
- If a Traffic Advisory System (TAS) is configured, a **STANDBY**, **OPERATE**, **TEST**, and **ALT MODE** Softkey will be displayed.

Traffic Symbol	Description
	Non-Threat Traffic (intruder is beyond 5 nm and greater than 1200’ vertical separation)
	Proximity Advisory (PA)(TAS only, not available with TIS) (intruder is within 5 nm and less than 1200’ vertical separation)
	Traffic Advisory (TA) (closing rate, distance, and vertical separation meet TA criteria)
	Traffic Advisory Off Scale

Traffic Symbol Description

Traffic Information Service (TIS)



NOTE: If the G1000 is configured to use an optional Traffic Advisory System (TAS), TIS is not available for use.



NOTE: Traffic Information Service (TIS) is only available when the aircraft is within the service volume of a TIS capable terminal radar site.

Displaying Traffic on the Traffic Map Page

- 1) Turn the large **FMS** Knob to select the Map Page Group.
- 2) Turn the small **FMS** Knob to select the Traffic Map Page.
- 3) Select the **OPERATE** Softkey to begin displaying traffic. 'OPERATING' is displayed in the Traffic Mode field.
- 4) Select the **STANDBY** Softkey to place the system in the Standby Mode. 'STANDBY' will be displayed in the Traffic Mode field.
- 5) Rotate the **Joystick** clockwise to display a larger area or rotate counter-clockwise to display a smaller area.

Displaying Traffic on the Navigation Map

- 1) Ensure TIS is operating. With the Navigation Map displayed, press the **MAP** Softkey.
- 2) Select the **TRAFFIC** Softkey. Traffic will now be displayed on the map.

Traffic Advisory System (TAS) (Optional)

System Self Test

- 1) Set the range to 2/6 nm.
- 2) Press the **STANDBY** Softkey.
- 3) Press the **TEST** Softkey.
- 4) Self test will take approximately eight seconds to complete. When completed successfully, traffic symbols will be displayed and a voice alert appropriate for the installed system will be heard indicating the test passed (see Annunciations & Alerts section). If the self test fails, the system will revert to Standby Mode and a voice alert appropriate for the installed system will be heard indicating the test failed.

Displaying Traffic on the Traffic Map Page

- 1) Turn the large **FMS** Knob to select the Map Page Group.
- 2) Turn the small **FMS** Knob to select the second rectangular page icon.

- 3) Press the **OPERATE** Softkey to begin displaying traffic. 'OPERATING' is displayed in the Traffic Mode field.
- 4) Press the **ALT MODE** Softkey to change the altitude display volume. Select the desired altitude volume by pressing the **BELOW, NORMAL, ABOVE,** or **UNREST** (unrestricted) Softkey. The selection is displayed in the Altitude Mode field.
- 5) Press the **STANDBY** Softkey to place the system in the Standby Mode. 'STANDBY' will be displayed in the Traffic Mode field.
- 6) Rotate the **Joystick** clockwise to display a larger area or rotate counter-clockwise to display a smaller area.

Displaying Traffic on the Navigation Map

- 1) With the Navigation Map displayed, press the **MAP** Softkey.
- 2) Press the **TRAFFIC** Softkey. Traffic will now be displayed on the map.

TERRAIN AWARENESS & WARNING SYSTEM (TAWS) DISPLAY



NOTE: Terrain data is not displayed when the aircraft latitude is greater than 75 degrees north or 60 degrees south.



NOTE: TAWS operation is only available when the G1000 is configured for a TAWS-B installation.

Manual System Test

- 1) While the TAWS Page is displayed, press the **MENU** Key.
- 2) Turn the small **FMS** Knob to select 'Test TAWS System'.
- 3) Press the **ENT** Key. During the test 'TAWS TEST' is displayed in the center of the TAWS Page.

When all is in working order, "TAWS System Test, OK" will be heard.

Display Terrain on the TAWS Page

- 1) Turn the large **FMS** Knob to select the Map Page Group.
- 2) Turn the small **FMS** Knob to select the TAWS Page.
- 3) If desired, select the **VIEW** Softkey to access the **ARC** and **360** softkeys. When the **ARC** Softkey is selected, a radar-like 120° view is displayed. Select the **360** Softkey to return to the 360° default display.

- 4) Rotate the **Joystick** clockwise to display a larger area or rotate counter-clockwise to display a smaller area.

Color	Terrain/Obstacle Location
Red	Terrain/Obstacle above or within 100' below current aircraft altitude.
Yellow	Terrain/Obstacle between 100' and 1000' below current aircraft altitude.
Black	Terrain/Obstacle is more than 1000' below aircraft altitude.

Enable/Disable Aviation Data

- 1) While the TAWS Page is displayed, press the **MENU** Key.
- 2) Turn the small **FMS** Knob to select "Show (or Hide) Aviation Data".
- 3) Press the **ENT** Key.

TAWS Inhibit

Inhibit TAWS

While the TAWS Page is displayed, press the **INHIBIT** Softkey.

Or:

- 1) Press the **MENU** Key.
- 2) Turn the small **FMS** Knob to select 'Inhibit TAWS'.
- 3) Press the **ENT** Key.

Enable TAWS

While the TAWS Page is displayed, press the **INHIBIT** Softkey.

Or:

- 1) While the TAWS Page is displayed, press the **MENU** Key.
- 2) Turn the small **FMS** Knob to select 'Enable TAWS'.
- 3) Press the **ENT** Key.



NOTE: If TAWS alerts are inhibited when the Final Approach Fix is the active waypoint in a GPS WAAS approach, a **LOW ALT** annunciation may appear on the PFD next to the altimeter if the current aircraft altitude is at least 164 feet below the prescribed altitude at the Final Approach Fix.

AIRBORNE COLOR WEATHER RADAR



WARNING: Begin transmitting only when it is safe to do so. If it is desired to transmit while the aircraft is on the ground, no personnel or objects should be within 11 feet of the antenna.



CAUTION: In Standby Mode, the antenna is parked at the center line. It is always a good idea to put the radar in Standby Mode before taxiing the aircraft to prevent the antenna from bouncing on the bottom stop and possibly causing damage to the radar assembly.

Displaying Weather on the Weather Radar Page

- 1) Turn the large **FMS** Knob to select the Map Page Group.
- 2) Turn the small **FMS** Knob to select the Weather Radar Page.
- 3) Select the **MODE** Softkey.
- 4) If the aircraft is on the ground, select the **STANDBY** Softkey to initiate the one minute warm-up period. After the warm-up is complete, the radar will enter the Standby Mode. After the aircraft is airborne, select the **WEATHER** Softkey.

Or:

If the aircraft is already airborne, select the **WEATHER** or **GROUND** Softkey. The one-minute warm-up period will be initiated, after which the radar will begin transmitting. The horizontal scan is initially displayed.

- 5) Turn the **Joystick** to select the desired range.
- 6) If desired, select the **VERTICAL** Softkey for vertical scanning.

Adjusting Antenna Tilt

Move the **Joystick** up or down to adjust the tilt of the antenna up or down. Monitor the displayed tilt value in the TILT field.

When scanning vertically, a Tilt Line may be displayed to aid in positioning the tilt of the antenna. If the Tilt Line is not displayed, perform the following steps:

- 1) Press the **MENU** Key
- 2) Turn the large **FMS** Knob to select 'Show Tilt Line'.
- 3) Press the **ENT** Key.

Adjusting Antenna Bearing

Move the **Joystick** right or left to adjust the azimuth position of the antenna right or left. Monitor the displayed bearing value in the BEARING field.

When scanning horizontally, a Bearing Line may be displayed to aid in positioning the antenna for the vertical scan. If the Bearing Line is not displayed, perform the following steps:

- 1) Press the **MENU** Key
- 2) Turn the large **FMS** Knob to select 'Show Bearing Line'.
- 3) Press the **ENT** Key.

Vertically Scan a Storm Cell

- 1) While in the Horizontal Scan view, move the **Joystick** to place the Bearing Line on the desired storm cell, or other area, to be vertically scanned.
- 2) Select the **VERTICAL** Softkey. A vertical 'slice' of the selected area will now be displayed.
- 3) Move the **Joystick** right or left to move the scanned "slice" a few degrees right or left.
- 4) Turn the **Joystick** to adjust the range.
- 5) To select a new area to be vertically scanned, select the **HORIZON** Softkey to return to the Horizontal Scan view and repeat the previous steps.

Adjusting Gain



WARNING: Changing the gain in Weather Mode will cause precipitation intensity to be displayed as a color not representative of the true intensity. Remember to return the gain setting to 'Calibrated' for viewing the actual intensity of precipitation.

- 1) Select the **GAIN** Softkey to activate the cursor in the 'GAIN' field.
- 2) Turn the small **FMS** Knob to adjust the gain for the desirable level. The gain setting is visible in the gain field as a movable horizontal bar in a flashing box. The line pointer is a reference depicting the calibrated position.
- 3) Press the **FMS** Knob to remove the cursor.
- 4) Select the **GAIN** Softkey again to recalibrate the gain. 'CALIBRATED' will be displayed in the 'GAIN' field.

- Flight Instruments
- Nav/Com/XPDR/Audio
- AFCs
- GPS Nav
- Flight Planning
- Procedures
- Hazard Avoidance
- Additional Features
- Annun/Alerts
- Appendix
- Index

Ground Mapping

- 1) Select the **MODE** Softkey.
- 2) Select the **GROUND** Softkey to place the radar in Ground Map Mode.
- 3) Select the **BACK** Softkey.

Sector Scan

- 1) While in the Horizontal Scan Mode, move the **Joystick** right or left to place the Bearing Line in the desired position. The location of the Bearing Line will become the center point of the Sector Scan.
- 2) Press the **FMS** Knob to display the cursor.
- 3) Turn the large **FMS** Knob to place the cursor in the SECTOR SCAN field.
- 4) Turn the small **FMS** Knob to select FULL, 60°, 40°, or 20° scan.
- 5) If desired, readjust the Bearing Line with the **Joystick** to change the center of the Sector Scan.
- 6) Press the **FMS** Knob to remove the cursor.

Antenna Stabilization

- 1) To activate or deactivate the antenna stabilization, select the **MODE** Softkey.
- 2) Select the **STAB ON** Softkey to activate antenna stabilization or select the **STAB OFF** Softkey to deactivate. The current stabilization condition is shown in the upper right of the weather radar display.

Weather Attenuated Color Highlight (WATCH®)

To activate or deactivate the WATCH® feature, select the **WATCH** Softkey. This feature is only available in the Horizontal Scan Mode.

Weather Alert

To activate or deactivate Weather Alert, select the **WX ALRT** Softkey. Activating and deactivating will also enable or inhibit the alert on the PFD.

Automatic Standby

When the weather radar system is in the Weather or Ground Map Mode, upon landing the system will automatically switch to Standby Mode.

ADDITIONAL FEATURES

SYNTHETIC VISION



WARNING: Use appropriate primary systems for navigation, and for terrain, obstacle, and traffic avoidance. SVS is intended as an aid to situational awareness only and may not provide either the accuracy or reliability upon which to solely base decisions and/or plan maneuvers to avoid terrain, obstacles, or traffic.

Synthetic Vision System (SVS) functionality is offered as an optional enhancement to the G1000 system.

SVS is primarily comprised of a computer-generated forward-looking, attitude aligned view of the topography immediately in front of the aircraft from the pilot's perspective. SVS information is shown on the primary flight display (PFD).

In addition to SVS enhancement to the PFD, the following features have been added to the PFD:

- Pathways
- Flight Path Marker
- Horizon Heading Marks
- Terrain and Obstacle Alerting
- Three-dimensional Traffic
- Airport Signs
- Runway Display

Displaying SVS Terrain

- 1) Press the **PFD** Softkey.
- 2) Press the **SYN VIS** Softkey.
- 3) Press the **SYN TERR** Softkey.
- 4) Press the **BACK** Softkey to return to the previous page.

Displaying Pathways

- 1) Press the **PFD** Softkey.
- 2) Press the **SYN VIS** Softkey.
- 3) If not already enabled, press the **SYN TERR** Softkey.
- 4) Press the **PATHWAY** Softkey.
- 5) Press the **BACK** Softkey to return to the previous page.

Displaying Heading on the Horizon

- 1) Press the **PFD** Softkey.
- 2) Press the **SYN VIS** Softkey.
- 3) If not already enabled, press the **SYN TERR** Softkey.
- 4) Press the **HRZN HDG** Softkey.
- 5) Press the **BACK** Softkey to return to the previous page.

Displaying Airport Signs

- 1) Press the **PFD** Softkey.
- 2) Press the **SYN VIS** Softkey.
- 3) If not already enabled, press the **SYN TERR** Softkey.
- 4) Press the **APTSIGNS** Softkey.
- 5) Press the **BACK** Softkey to return to the previous page.

TERMINAL PROCEDURE CHARTS



NOTE: *With the availability of SafeTaxi®, ChartView, or FliteCharts® in electronic form, it is still advisable to carry another source of charts on-board the aircraft.*

SafeTaxi®

SafeTaxi® is an enhanced feature that gives greater map detail as the map range is adjusted in on the airport. The airport display on the map reveals runways with numbers, taxiways identifiers, and airport landmarks including ramps, buildings, control towers, and other prominent features. Resolution is greater at lower map ranges. The aircraft symbol provides situational awareness while taxiing.

Pressing the DCLTR Softkey (declutter) once removes the taxiway markings and airport identification labels. Pressing the DCLTR Softkey twice removes VOR station ID, the VOR symbol, and intersection names if within the airport plan view. Pressing the DCLTR Softkey a third time removes the airport runway layout, unless the airport in view is part of an active route structure. Pressing the DCLTR Softkey again cycles back to the original map detail.

The SafeTaxi database contains detailed airport diagrams for selected airports. These diagrams aid in following ground control instructions by accurately displaying the aircraft position on the map in relation to taxiways, ramps, runways, terminals, and services. This database is updated on a 56-day cycle.

ChartView

ChartView resembles the paper version of Jeppesen terminal procedures charts. The charts are displayed in full color with high-resolution. The MFD depiction shows the aircraft position on the moving map in the plan view of most approach charts and on airport diagrams.

The ChartView database is updated on a 14-day cycle. If the ChartView database is not updated within 70 days of the expiration date, ChartView will no longer function.

FliteCharts®

FliteCharts® resemble the paper version of National Aeronautical Charting Office (NACO) terminal procedures charts. The charts are displayed with high-resolution and in color for applicable charts. Current aircraft position is not displayed on FliteCharts.

The FliteCharts database contains procedure charts for the United States only. This database is updated on a 28-day cycle. If not updated within 180 days of the expiration date, FliteCharts will no longer function.

View Charts from the Navigation Map Page

- 1) Press the **SHW CHRT** Softkey when displayed.

Or:

Move the map pointer to point to a desired point on the map and press the **SHW CHRT** Softkey.

- 2) Select the **DP, STAR, APR, WX,** and **NOTAM** softkeys to access charts for departures, arrivals, approaches, weather and NOTAMs. Note that NOTAMS are only available with ChartView.
- 3) Press the **GO BACK** Softkey to return to the previous page.

View Charts from the Active Flight Plan Page

- 1) While viewing the Active Flight Plan Page, press the **FMS** Knob to activate the cursor.
- 2) Turn the large **FMS** Knob to select the departure airport, destination airport, departure, arrival, or approach.
- 3) Press the **SHW CHRT** Softkey. The appropriate chart will be displayed, if available for the item selected.
- 4) Press the **GO BACK** Softkey to return to the previous page.

Change Day/Night View

- 1) While viewing a chart press the **MENU** Key to display the Page Menu OPTIONS.
- 2) Turn the large **FMS** Knob to highlight the 'Chart Setup' Menu Option and press the **ENT** Key.
- 3) Turn the large **FMS** Knob to move between the 'FULL SCREEN' and 'COLOR SCHEME' Options.
- 4) Turn the small **FMS** Knob to choose between the 'On' and 'Off' Full Screen Options.
- 5) Turn the small **FMS** Knob to choose between 'Day', 'Auto', and 'Night' Options.
- 6) In Auto Mode, turn the large **FMS** Knob to select the percentage field and change percentage with the small **FMS** Knob. The percentage of change is the day/night crossover point based on backlighting intensity.
- 7) Press the **FMS** Knob when finished to remove the Chart Setup Menu.

XM® RADIO ENTERTAINMENT

The XM® Radio Page provides information and control of the audio entertainment features of the XM Satellite Radio.

Selecting the XM Radio Page

- 1) Turn the large **FMS** Knob to select the Auxiliary Page Group.
- 2) Turn the small **FMS** Knob to select the displayed AUX - XM Information Page.
- 3) Press the **RADIO** Softkey to show the XM Radio Page where audio entertainment is controlled.

Active Channel and Channel List

The Active Channel Box on the XM Radio Page displays the currently selected channel. The Channels List Box of the XM Radio Page shows a list of the available channels for the selected category.

Selecting a Category

The Category Box of the XM Radio Page displays the currently selected category of audio.

- 1) Select the **CATGRY** Softkey on the XM Radio Page.
- 2) Press the **CAT +** and **CAT -** Softkeys to cycle through the categories.

Or:

Turn the small **FMS** Knob to display the 'Categories' list. Highlight the desired category with the small **FMS** Knob.

- 3) Press the **ENT** Key.

Select an Available Channel within the Selected Category

- 1) While on the XM Radio Page, press the **CHNL** Softkey.
- 2) Press the **CH +** Softkey to go up through the list in the Channel Box, or move down the list with the **CH -** Softkey.

Or:

Press the **FMS** Knob to highlight the channel list and turn the large **FMS** Knob to scroll through the channels.

- 3) With the desired channel highlighted, press the **ENT** Key.

Entering a Channel Directly

- 1) While on the XM Radio Page, press the **CHNL** Softkey.
- 2) Press the **DIR CH** Softkey. The channel number in the Active Channel Box will be highlighted.
- 3) Press the numbered softkeys located on the bottom of the display to directly select the desired channel number.
- 4) Press the **ENT** Key to activate the selected channel.

Assigning Channel Presets

Up to 15 channels from any category can be assigned a preset number.

- 1) On the XM Radio Page, with the desired channel active, press the **PRESETS** Softkey to access the first five preset channels (**PS1 - PS5**).
- 2) Press the **MORE** Softkey to access the next five channels (**PS6 - PS10**), and again to access the last five channels (**PS11 - PS15**). Pressing the **MORE** Softkey repeatedly cycles through the preset channels.

- 3) Press any one of the (**PS1 - PS15**) softkeys to assign a number to the active channel.
- 4) Press the **SET** Softkey on the desired channel number to save the channel as a preset.

Adjusting Volume

Radio volume is controlled at each passenger station.

Flight Instruments

Nav/Com/XPDR/Audio

AFCs

GPS Nav

Flight Planning

Procedures

Hazard Avoidance

Additional Features

Annun/Alerts

Appendix

Index

ANNUNCIATIONS & ALERTS

ADVISORY ANNUNCIATIONS

Annunciation Window Text	Alerts Window Text
AVN FAN 1 FAIL	Avionics cooling fan #1 is inoperative.
AVN FAN 2 FAIL	Avionics cooling fan #2 is inoperative.
PFD 1 FAN FAIL	PFD #1 cooling fan is inoperative.
PFD 2 FAN FAIL	PFD #2 cooling fan is inoperative.
MFD FAN FAIL	MFD cooling fan is inoperative..
WOW FAULT	Miscompare between weight on wheels inputs.
WOW INVALID	Weight on wheels inputs invalid.

COMPARATOR ANNUNCIATIONS

Comparator Window Text	Condition
ALT MISCOMP	Difference in altitude sensors is ≥ 200 ft.
IAS MISCOMP	If both airspeed sensors detect < 35 knots, this is inhibited.
	If either airspeed sensor detects ≥ 35 knots, and the difference in sensors is > 10 kts.
HDG MISCOMP	If either airspeed sensor detects ≥ 80 knots, and the difference in sensors is > 7 kts.
	Difference in heading sensors is > 6 degrees.
PIT MISCOMP	Difference in pitch sensors is > 5 degrees.
ROL MISCOMP	Difference in roll sensors is > 6 degrees.
ALT NO COMP	No data from one or both altitude sensors.
IAS NO COMP	No data from one or both airspeed sensors.
HDG NO COMP	No data from one or both heading sensors.
PIT NO COMP	No data from one or both pitch sensors.
ROL NO COMP	No data from one or both roll sensors..







- Flight Instruments
- Nav/Com/XPDR/Audio
- AFCs
- GPS Nav
- Flight Planning
- Procedures
- Hazard Avoidance
- Additional Features
- Annunciations/Alerts
- Appendix
- Index

REVERSIONARY SENSOR ANNUNCIATIONS











Reversionary Sensor Window Text	Condition
BOTH ON ADC1	Both PFDs are displaying data from the number one Air Data Computer.
BOTH ON ADC2	Both PFDs are displaying data from the number two Air Data Computer.
BOTH ON AHRS1	Both PFDs are displaying data from the number one Attitude & Heading Reference System.
BOTH ON AHRS2	Both PFDs are displaying data from the number two Attitude & Heading Reference System.
BOTH ON GPS1	Both PFDs are displaying data from the number one GPS receiver.
BOTH ON GPS2	Both PFDs are displaying data from the number two GPS receiver.
USING ADC1	PFD2 is displaying data from the #1 Air Data Computer.
USING ADC2	PFD1 is displaying data from the #2 Air Data Computer.
USING AHRS1	PFD2 is displaying data from the #1 AHRS.
USING AHRS2	PFD1 is displaying data from the #2 AHRS.
USING GPS1	PFD2 is displaying data from the #1 GPS.
USING GPS2	PFD1 is displaying data from the #2 GPS.

AFCS ALERTS

Condition	Annunciation	Description
Pitch Failure		Pitch axis control failure.
Roll Failure		Roll axis control failure.
Pitch Trim Axis Control Failure		If annunciated when AP is engaged, a failure has occurred in the pitch trim system.
Yaw Damper Failure		YD control failure.
System Failure		AP and MET are unavailable. FD may still be available.
Elevator Mistrim Up		A condition has developed causing the pitch servo to provide a sustained force in the nose up direction.
Elevator Mistrim Down		A condition has developed causing the pitch servo to provide a sustained force in the nose down direction.

Condition	Annunciation	Description
Aileron Mistrim Left		A condition has developed causing the roll servo to provide a sustained left force.
Aileron Mistrim Right		A condition has developed causing the roll servo to provide a sustained right force.
Rudder Mistrim Left		A condition has developed causing the yaw servo to provide a sustained force.
Rudder Mistrim Right		A condition has developed causing the yaw servo to provide a sustained force.
Preflight Test		Performing preflight system test. Upon completion of the test, the aural alert will be heard.
		Preflight system test has failed.

TAWS ALERTS

Alert Type	PFD/MFD TAWS-B Page Annunciation	MFD Pop-Up Alert	Aural Message
Excessive Descent Rate Warning (EDR)			"Pull Up"
Reduced Required Terrain Clearance Warning (RTC)		 or 	"Terrain, Terrain; Pull Up, Pull Up" or "Terrain Ahead, Pull Up; Terrain Ahead, Pull Up"
Imminent Terrain Impact Warning (ITI)		 or 	Terrain Ahead, Pull Up; Terrain Ahead, Pull Up" or "Terrain, Terrain; Pull Up, Pull Up"
Reduced Required Obstacle Clearance Warning (ROC)		 or 	"Obstacle, Obstacle; Pull Up, Pull Up" or "Obstacle Ahead, Pull Up; Obstacle Ahead, Pull Up"

	Alert Type	PFD/MFD TAWS-B Page Annunciation	MFD Pop-Up Alert	Aural Message
Flight Instruments	Imminent Obstacle Impact Warning (IOI)	PULL UP	OBSTACLE AHEAD - PULL-UP	"Obstacle Ahead, Pull Up; Obstacle Ahead, Pull Up" or "Obstacle, Obstacle; Pull Up, Pull Up"
Nav/Com/XPDR/Audio			or OBSTACLE - PULL-UP	
AFCs	Reduced Required Terrain Clearance Caution (RTC)	TERRAIN	CAUTION - TERRAIN or TERRAIN AHEAD	"Caution, Terrain; Caution, Terrain" or "Terrain Ahead; Terrain Ahead"
GPS Nav	Imminent Terrain Impact Caution (ITI)	TERRAIN	TERRAIN AHEAD	"Terrain Ahead; Terrain Ahead" or "Caution, Terrain; Caution, Terrain"
Flight Planning			or CAUTION - TERRAIN	
Procedures	Reduced Required Obstacle Clearance Caution (ROC)	TERRAIN	CAUTION - OBSTACLE or OBSTACLE AHEAD	"Caution, Obstacle; Caution, Obstacle" or "Obstacle Ahead; Obstacle Ahead"
Hazard Avoidance	Imminent Obstacle Impact Caution (IOI)	TERRAIN	OBSTACLE AHEAD or CAUTION - OBSTACLE	"Obstacle Ahead; Obstacle Ahead" or "Caution, Obstacle; Caution, Obstacle"
Additional Features	Premature Descent Alert Caution (PDA)	TERRAIN	TOO LOW - TERRAIN	"Too Low, Terrain"
Annun/Alerts	Altitude Callout "500"	None	None	"Five-Hundred"
Appendix	Excessive Descent Rate Caution (EDR)	TERRAIN	SINK RATE	"Sink Rate"
	Negative Climb Rate Caution (NCR)	TERRAIN	DON'T SINK or TOO LOW - TERRAIN	"Don't Sink" or "Too Low, Terrain"
Index				

TAWS System Status Annunciations

Alert Type	PFD/MFD TAWS-B Page Annunciation	MFD Pop-Up Alert	Aural Message
TAWS System Test Fail	TAWS FAIL	None	"TAWS System Failure"
TAWS Alerting is disabled	TAWS INH	None	None
No GPS position or excessively degraded GPS signal	TAWS N/A	None	"TAWS Not Available" "TAWS Available" will be heard when sufficient GPS signal is re-established.
System Test in progress	TAWS TEST	None	None
System Test pass	None	None	Chime

AURAL ALERTS

Aural Alert	Description
"Minimums"	The aircraft has descended below the preset minimum descent altitude or decision altitude.
"Vertical track"	The aircraft is one minute from Top of Descent. Issued only when vertical navigation is enabled.
"Traffic"	Played when a Traffic Advisory (TA) is issued with the TIS system.
"Traffic Not Available"	The aircraft is outside the Traffic Information Service (TIS) coverage area.
"Traffic, Traffic"	Played when first Traffic Advisory (TA) is issued with an optional TAS system. "Traffic" for each subsequent TA.
"Traffic Advisory System Test Passed"	Played when the optional KTA 870 or Skywatch HP TAS system passes a pilot-initiated self test.
"Traffic Advisory System Test Failed"	Played when the optional KTA 870 or Skywatch HP TAS system fails a pilot-initiated self test.
"Skywatch System Test Passed"	Played when the optional SKY497 TAS system passes a pilot-initiated self test (optional).
"Skywatch System Test Failed"	Played when the optional SKY497 TAS system fails a pilot-initiated self test (optional).

MFD & PFD MESSAGE ADVISORIES

Message	Comments
DATA LOST – Pilot stored data was lost. Recheck settings.	The pilot profile data was lost. System reverts to default pilot profile and settings. The pilot may reconfigure the MFD & PFDs with preferred settings, if desired.
XTALK ERROR – A flight display crosstalk error has occurred.	The MFD and PFDs are not communicating with each other. The system should be serviced.
PFD1 SERVICE – PFD1 needs service. Return unit for repair.	The PFD and/or MFD self-test has detected a problem. The system should be serviced.
PFD2 SERVICE – PFD2 needs service. Return unit for repair.	
MFD1 SERVICE – MFD1 needs service. Return unit for repair.	
MANIFEST – PFD1 software mismatch, communication halted.	The PFD and/or MFD has incorrect software installed. The system should be serviced.
MANIFEST – PFD2 software mismatch, communication halted.	
MANIFEST – MFD1 software mismatch, communication halted.	
PFD1 CONFIG – PFD1 config error. Config service req'd.	The PFD configuration settings do not match backup configuration memory. The system should be serviced.
PFD2 CONFIG – PFD2 config error. Config service req'd.	
MFD1 CONFIG – MFD1 config error. Config service req'd.	The MFD configuration settings do not match backup configuration memory. The system should be serviced.
SW MISMATCH – GDU software version mismatch. Xtalk is off.	The MFD and PFDs have different software versions installed. The system should be serviced.

MFD & PFD MESSAGE ADVISORIES (CONT.)

Message	Comments
PFD1 COOLING – PFD1 has poor cooling. Reducing power usage.	The PFD and/or MFD is overheating and is reducing power consumption by dimming the display. If problem persists, the system should be serviced.
PFD2 COOLING – PFD2 has poor cooling. Reducing power usage.	
MFD1 COOLING – MFD1 has poor cooling. Reducing power usage.	
PFD1 KEYSTK – PFD1 [key name] Key is stuck.	A key is stuck on the PFD and/or MFD bezel. Attempt to free the stuck key by pressing it several times. The system should be serviced if the problem persists.
PFD2 KEYSTK – PFD2 [key name] Key is stuck.	
MFD1 KEYSTK – MFD [key name] Key is stuck.	
CNFG MODULE – PFD1 configuration module is inoperative.	The PFD1 configuration module backup memory has failed. The system should be serviced.
PFD1 VOLTAGE – PFD1 has low voltage. Reducing power usage	The PFD1 voltage is low. The system should be serviced.
PFD2 VOLTAGE – PFD2 has low voltage. Reducing power usage	The PFD2 voltage is low. The system should be serviced.
MFD1 VOLTAGE – MFD1 has low voltage. Reducing power usage	The MFD voltage is low. The system should be serviced.

DATABASE MESSAGE ADVISORIES

Message	Comments
MFD1 DB ERR – MFD1 aviation database error exists.	The MFD and/or PFD detected a failure in the aviation database. Attempt to reload the aviation database. If problem persists, the system should be serviced.
PFD1 DB ERR – PFD1 aviation database error exists.	
PFD2 DB ERR – PFD2 aviation database error exists.	

- Flight Instruments
- Nav/Com/XPDR/Audio
- AFCs
- GPS Nav
- Flight Planning
- Procedures
- Hazard Avoidance
- Additional Features
- Annunciations
- Appendix
- Index

DATABASE MESSAGE ADVISORIES (CONT.)

Message	Comments
MFD1 DB ERR – MFD1 basemap database error exists.	The MFD and/or PFD detected a failure in the basemap database.
PFD1 DB ERR – PFD1 basemap database error exists.	
PFD2 DB ERR – PFD2 basemap database error exists.	
MFD1 DB ERR – MFD1 terrain database error exists.	The MFD and/or PFD detected a failure in the terrain database. Ensure that the terrain card is properly inserted in display. Replace terrain card. If problem persists, the system should be serviced.
PFD1 DB ERR – PFD1 terrain database error exists.	
PFD2 DB ERR – PFD2 terrain database error exists.	
MFD1 DB ERR – MFD1 terrain database missing.	The terrain database is present on another LRU, but is missing on the specified LRU.
PFD1 DB ERR – PFD1 terrain database missing.	
PFD2 DB ERR – PFD2 terrain database missing.	
MFD1 DB ERR – MFD1 obstacle database error exists.	The MFD and/or PFD detected a failure in the obstacle database. Ensure that the data card is properly inserted. Replace data card. If problem persists, the system should be serviced.
PFD1 DB ERR – PFD1 obstacle database error exists.	
PFD2 DB ERR – PFD2 obstacle database error exists.	
MFD1 DB ERR – MFD1 obstacle database missing.	The obstacle database is present on another LRU, but is missing on the specified LRU.
PFD1 DB ERR – PFD1 obstacle database missing.	
PFD2 DB ERR – PFD2 obstacle database missing.	

DATABASE MESSAGE ADVISORIES (CONT.)

Message	Comments
MFD1 DB ERR – MFD1 airport terrain database error exists.	The MFD and/or PFD detected a failure in the airport terrain database. Ensure that the data card is properly inserted. Replace data card. If problem persists, the system should be serviced.
PFD1 DB ERR – PFD1 airport terrain database error exists.	
PFD2 DB ERR – PFD2 airport terrain database error exists.	
MFD1 DB ERR – MFD1 airport terrain database missing.	The airport terrain database is present on another LRU, but is missing on the specified LRU.
PFD1 DB ERR – PFD1 airport terrain database missing.	
PFD2 DB ERR – PFD2 airport terrain database missing.	
MFD1 DB ERR – MFD1 Safe Taxi database error exists.	The MFD and/or PFD detected a failure in the Safe Taxi database. Ensure that the data card is properly inserted. Replace data card. If problem persists, the system should be serviced.
PFD1 DB ERR – PFD1 Safe Taxi database error exists.	
PFD2 DB ERR – PFD2 Safe Taxi database error exists.	
MFD1 DB ERR – MFD1 Chartview database error exists.	The MFD and/or PFDs detected a failure in the ChartView database (optional feature). Ensure that the data card is properly inserted. Replace data card. If problem persists, the system should be serviced.
MFD1 DB ERR – MFD1 FliteCharts database error exists.	The MFD and/or PFDs detected a failure in the FliteCharts database (optional feature). Ensure that the data card is properly inserted. Replace data card. If problem persists, the system should be serviced.
DB MISMATCH – Aviation database version mismatch. Xtalk is off.	The PFDs and MFD have different aviation database versions installed. Crossfill is off. Install correct aviation database version in all displays.

- Flight Instruments
- Nav/Com/XPDR/Audio
- AFCs
- GPS Nav
- Flight Planning
- Procedures
- Hazard Avoidance
- Additional Features
- Annunciations/Alerts
- Appendix
- Index

DATABASE MESSAGE ADVISORIES (CONT.)

Message	Comments
DB MISMATCH – Aviation database type mismatch. Xtalk is off.	The PFDs and MFD have different aviation database types installed (Americas, European, etc.). Crossfill is off. Install correct aviation database type in all displays.
DB MISMATCH – Terrain database version mismatch.	The PFDs and MFD have different terrain database versions installed. Install correct terrain database version in all displays.
DB MISMATCH – Terrain database type mismatch.	The PFDs and MFD have different terrain database types installed. Install correct terrain database type in all displays.
DB MISMATCH – Obstacle database version mismatch.	The PFDs and MFD have different obstacle database versions installed. Install correct obstacle database version in all displays.
DB MISMATCH – Airport Terrain database mismatch.	The PFDs and MFD have different airport terrain databases installed. Install correct airport terrain database in all displays.

GMA 1347D MESSAGE ADVISORIES

Message	Comments
GMA1 FAIL – GMA1 is inoperative.	The audio panel self-test has detected a failure. The audio panel is unavailable. The system should be serviced.
GMA2 FAIL – GMA2 is inoperative.	
GMA XTALK – GMA crosstalk error has occurred.	An error has occurred in transferring data between the two GMAs. The system should be serviced.
GMA1 CONFIG – GMA1 config error. Config service req'd.	The audio panel configuration settings do not match backup configuration memory. The system should be serviced.
GMA2 CONFIG – GMA2 config error. Config service req'd.	

GMA 1347D MESSAGE ADVISORIES (CONT.)

Message	Comments
MANIFEST – GMA1 software mismatch, communication halted.	The audio panel has incorrect software installed. The system should be serviced.
MANIFEST – GMA2 software mismatch, communication halted.	
GMA1 SERVICE – GMA1 needs service. Return unit for repair.	The audio panel self-test has detected a problem in the unit. Certain audio functions may still be available, and the audio panel may still be usable. The system should be serviced when possible.
GMA2 SERVICE – GMA2 needs service. Return unit for repair.	

GIA 63W MESSAGE ADVISORIES

Message	Comments
GIA1 CONFIG – GIA1 config error. Config service req'd.	The GIA1 and/or GIA2 configuration settings do not match backup configuration memory. The system should be serviced.
GIA2 CONFIG – GIA2 config error. Config service req'd.	
GIA1 CONFIG – GIA1 audio config error. Config service req'd.	The GIA1 and/or GIA2 have an error in the audio configuration. The system should be serviced.
GIA2 CONFIG – GIA2 audio config error. Config service req'd.	
GIA1 COOLING – GIA1 temperature too low.	The GIA1 and/or GIA2 temperature is too low to operate correctly. Allow units to warm up to operating temperature.
GIA2 COOLING – GIA2 temperature too low.	
GIA1 COOLING – GIA1 over temperature.	The GIA1 and/or GIA2 temperature is too high. If problem persists, the system should be serviced.
GIA2 COOLING – GIA2 over temperature.	
GIA1 SERVICE – GIA1 needs service. Return the unit for repair.	The GIA1 and/or GIA2 self-test has detected a problem in the unit. The system should be serviced.
GIA2 SERVICE – GIA2 needs service. Return the unit for repair.	

- Flight Instruments
- Nav/Com/XPDR/Audio
- AFCs
- GPS Nav
- Flight Planning
- Procedures
- Hazard Avoidance
- Additional Features
- Annun/Alerts
- Appendix
- Index

GIA 63W MESSAGE ADVISORIES (CONT.)

Message	Comments
HW MISMATCH – GIA hardware mismatch. GIA1 communication halted.	A GIA mismatch has been detected, where only one is WAAS capable.
HW MISMATCH – GIA hardware mismatch. GIA2 communication halted.	
MANIFEST – GIA1 software mismatch, communication halted.	The GIA1 and/or GIA 2 has incorrect software installed. The system should be serviced.
MANIFEST – GIA2 software mismatch, communication halted.	
MANIFEST – GFC software mismatch, communication halted.	Incorrect servo software is installed, or gain settings are incorrect.
COM1 TEMP – COM1 over temp. Reducing transmitter power.	The system has detected an over temperature condition in COM1 and/or COM2. The transmitter is operating at reduced power. If the problem persists, the system should be serviced.
COM2 TEMP – COM2 over temp. Reducing transmitter power.	
COM1 SERVICE – COM1 needs service. Return unit for repair.	The system has detected a failure in COM1 and/or COM2. COM1 and/or COM2 may still be usable. The system should be serviced when possible.
COM2 SERVICE – COM2 needs service. Return unit for repair.	
COM1 PTT – COM1 push-to-talk key is stuck.	The COM1 and/or COM2 external push-to-talk switch is stuck in the enable (or “pressed”) position. Press the PTT switch again to cycle its operation. If the problem persists, the system should be serviced.
COM2 PTT – COM2 push-to-talk key is stuck.	
COM1 RMT XFR – COM1 remote transfer key is stuck.	The COM1 and/or COM2 transfer switch is stuck in the enabled (or “pressed”) position. Press the transfer switch again to cycle its operation. If the problem persists, the system should be serviced.
COM2 RMT XFR – COM2 remote transfer key is stuck.	
LOI – GPS integrity lost. Crosscheck with other NAVS.	GPS integrity is insufficient for the current phase of flight.

GIA 63W MESSAGE ADVISORIES (CONT.)

Message	Comments
GPS NAV LOST – Loss of GPS navigation. Insufficient satellites.	Loss of GPS navigation due to insufficient satellites.
GPS NAV LOST – Loss of GPS navigation. Position error.	Loss of GPS navigation due to position error.
GPS NAV LOST – Loss of GPS navigation. GPS fail.	Loss of GPS navigation due to GPS failure.
ABORT APR – Loss of GPS navigation. Abort approach.	Abort approach due to loss of GPS navigation.
APR DWNGRADE – Approach downgraded.	Vertical guidance generated by WAAS is unavailable, use LNAV only minimums.
TRUE APR – True north approach. Change HDG reference to TRUE.	Displayed after passing the first waypoint of a true north approach when the nav angle is set to 'AUTO'.
GPS1 SERVICE – GPS1 needs service. Return unit for repair.	A failure has been detected in the GPS1 and/or GPS2 receiver. The receiver may still be available. The system should be serviced.
GPS2 SERVICE – GPS2 needs service. Return unit for repair.	
NAV1 SERVICE – NAV1 needs service. Return unit for repair.	A failure has been detected in the NAV1 and/or NAV2 receiver. The receiver may still be available. The system should be serviced.
NAV2 SERVICE – NAV2 needs service. Return unit for repair.	
NAV1 RMT XFR – NAV1 remote transfer key is stuck.	The remote NAV1 and/or NAV2 transfer switch is stuck in the enabled (or "pressed") state. Press the transfer switch again to cycle its operation. If the problem persists, the system should be serviced.
NAV2 RMT XFR – NAV2 remote transfer key is stuck.	
G/S1 FAIL – G/S1 is inoperative.	A failure has been detected in glideslope receiver 1 and/or receiver 2. The system should be serviced.
G/S2 FAIL – G/S2 is inoperative.	

- Flight Instruments
- Nav/Com/XPDR/Audio
- AFCS
- GPS Nav
- Flight Planning
- Procedures
- Hazard Avoidance
- Additional Features
- Annun/Alerts
- Appendix
- Index

GIA 63W MESSAGE ADVISORIES (CONT.)

Message	Comments
G/S1 SERVICE – G/S1 needs service. Return unit for repair.	A failure has been detected in glideslope receiver 1 and/or receiver 2. The receiver may still be available. The system should be serviced when possible.
G/S2 SERVICE – G/S2 needs service. Return unit for repair.	

GEA 71 MESSAGE ADVISORIES

Message	Comments
GEA1 CONFIG – GEA1 config error. Config service req'd.	The GEA1 configuration settings do not match those of backup configuration memory. The system should be serviced.
GEA2 CONFIG – GEA2 config error. Config service req'd.	The GEA2 configuration settings do not match those of backup configuration memory. The system should be serviced.
MANIFEST – GEA1 software mismatch, communication halted.	The #1 GEA 71 has incorrect software installed. The system should be serviced.
MANIFEST – GEA2 software mismatch, communication halted.	The #2 GEA 71 has incorrect software installed. The system should be serviced.

GTX 33 MESSAGE ADVISORIES

Message	Comments
XPDR1 CONFIG – XPDR1 config error. Config service req'd.	The transponder configuration settings do not match those of backup configuration memory. The system should be serviced.
XPDR2 CONFIG – XPDR2 config error. Config service req'd.	The transponder configuration settings do not match those of backup configuration memory. The system should be serviced.
MANIFEST – GTX1 software mismatch, communication halted.	The transponder has incorrect software installed. The system should be serviced.
MANIFEST – GTX2 software mismatch, communication halted.	The transponder has incorrect software installed. The system should be serviced.

GTX 33 MESSAGE ADVISORIES (CONT.)

Message	Comments
XPDR1 SRVC – XPDR1 needs service. Return unit for repair.	The #1 transponder should be serviced when possible.
XPDR2 SRVC – XPDR2 needs service. Return unit for repair.	The #2 transponder should be serviced when possible.
XPDR1 FAIL – XPDR1 is inoperative.	There is no communication with the #1 transponder.
XPDR2 FAIL – XPDR2 is inoperative.	There is no communication with the #2 transponder.

GRS 77 MESSAGE ADVISORIES

Message	Comments
AHRS1 TAS – AHRS1 not receiving valid airspeed.	The #1 AHRS is not receiving true airspeed from the air data computer. The AHRS relies on GPS information to augment the lack of airspeed. The system should be serviced.
AHRS2 TAS – AHRS2 not receiving valid airspeed.	The #2 AHRS is not receiving true airspeed from the air data computer. The AHRS relies on GPS information to augment the lack of airspeed. The system should be serviced.
AHRS1 GPS – AHRS1 using backup GPS source.	The #1 AHRS is using the backup GPS path. Primary GPS path has failed. The system should be serviced when possible.
AHRS2 GPS – AHRS2 using backup GPS source.	The #2 AHRS is using the backup GPS path. Primary GPS path has failed. The system should be serviced when possible.
AHRS1 GPS – AHRS1 not receiving any GPS information.	The #1 AHRS is not receiving any or any useful GPS information. Check AFMS limitations. The system should be serviced.
AHRS2 GPS – AHRS2 not receiving any GPS information.	The #2 AHRS is not receiving any or any useful GPS information. Check AFMS limitations. The system should be serviced.

Flight Instruments
 Nav/Com/XPDR/Audio
 AFCS
 GPS Nav
 Flight Planning
 Procedures
 Hazard Avoidance
 Additional Features
 Annun/Alerts
 Appendix
 Index

GRS 77 MESSAGE ADVISORIES (CONT.)

Message	Comments
AHRS1 GPS – AHRS1 not receiving backup GPS information.	The #1 AHRS is not receiving backup GPS information. The system should be serviced.
AHRS2 GPS – AHRS2 not receiving backup GPS information.	The #2 AHRS is not receiving backup GPS information. The system should be serviced.
AHRS1 GPS – AHRS1 operating exclusively in no-GPS mode.	The #1 AHRS is operating exclusively in no-GPS mode. The system should be serviced.
AHRS2 GPS – AHRS2 operating exclusively in no-GPS mode.	The #2 AHRS is operating exclusively in no-GPS mode. The system should be serviced.
AHRS MAG DB – AHRS magnetic model database version mismatch.	The #1 AHRS and #2 AHRS magnetic model database versions do not match.
AHRS1 SRVC – AHRS1 Magnetic-field model needs update.	The #1 AHRS earth magnetic field model is out of date. Update magnetic field model when practical.
AHRS2 SRVC – AHRS2 Magnetic-field model needs update.	The #2 AHRS earth magnetic field model is out of date. Update magnetic field model when practical.
GEO LIMITS – AHRS1 too far North/South, no magnetic compass.	The aircraft is outside geographical limits for approved AHRS operation. Heading is flagged as invalid.
GEO LIMITS – AHRS2 too far North/South, no magnetic compass.	
MANIFEST – GRS1 software mismatch, communication halted.	The #1 AHRS has incorrect software installed. The system should be serviced.
MANIFEST – GRS2 software mismatch, communication halted.	The #2 AHRS has incorrect software installed. The system should be serviced.

Flight Instruments

Nav/Com/XPDR/Audio

AFCs

GPS Nav

Flight Planning

Procedures

Hazard Avoidance

Additional Features

Annun/Alerts

Appendix

Index

GMU 44 MESSAGE ADVISORIES

Message	Comments
HDG FAULT – AHRS1 magnetometer fault has occurred.	A fault has occurred in the #1 GMU 44. Heading is flagged as invalid. The AHRS uses GPS for backup mode operation. The system should be serviced.
HDG FAULT – AHRS2 magnetometer fault has occurred.	A fault has occurred in the #2 GMU 44. Heading is flagged as invalid. The AHRS uses GPS for backup mode operation. The system should be serviced.
MANIFEST – GMU1 software mismatch, communication halted.	The GMU 44 has incorrect software installed. The system should be serviced.
MANIFEST – GMU2 software mismatch, communication halted.	

GDL 69A MESSAGE ADVISORIES

Message	Comments
GDL69 CONFIG – GDL 69 config error. Config service req'd.	GDL 69 configuration settings do not match those of backup configuration memory. The system should be serviced.
GDL69 FAIL – GDL 69 has failed.	A failure has been detected in the GDL 69. The receiver is unavailable. The system should be serviced.
MANIFEST – GDL software mismatch, communication halted.	The GDL 69 has incorrect software installed. The system should be serviced.

- Flight Instruments
- Nav/Com/XPDR/Audio
- AFCs
- GPS Nav
- Flight Planning
- Procedures
- Hazard Avoidance
- Additional Features
- Annunciations/Alerts
- Appendix
- Index

GWX 68 ALERT MESSAGES

Message	Comments
GWX CONFIG – GWX config error. Config service req'd.	GWX 68 configuration settings do not match those of the GDU configuration. The system should be serviced.
GWX FAIL – GWX is inoperative.	The GDU is not receiving status packet from the GWX 68 or the GWX 68 is reporting a fault. The GWX 68 radar system should be serviced.
GWX SERVICE – GWX needs service. Return unit for repair.	A failure has been detected in the GWX 68. The GWX 68 may still be usable.
MANIFEST – GWX software mismatch, communication halted.	The GWX 68 has incorrect software installed. The system should be serviced.
WX ALERT – Possible severe weather ahead.	Possible severe weather detected within +/- 10 degrees of the aircraft heading at a range of 80 to 320 nm.

GDC 74B MESSAGE ADVISORIES

Message	Comments
ADC1 ALT EC – ADC1 altitude error correction is unavailable.	GDC1 or GDC2 is reporting that the altitude error correction is unavailable.
ADC2 ALT EC – ADC2 altitude error correction is unavailable.	
ADC1 AS EC – ADC1 airspeed error correction is unavailable.	GDC1 or GDC2 is reporting that the airspeed error correction is unavailable.
ADC2 AS EC – ADC2 airspeed error correction is unavailable.	
MANIFEST – GDC1 software mismatch, communication halted.	The GDC 74B has incorrect software installed. The system should be serviced.
MANIFEST – GDC2 software mismatch, communication halted.	

GCU 477 MESSAGE ADVISORIES

Message	Comments
GCU CNFG – GCU Config error. Config service req'd.	GCU 477 configuration settings do not match those of backup configuration memory. The G1000 system should be serviced.
GCU FAIL – GCU is inoperative.	A failure has been detected in the GCU 477. The GCU 477 is unavailable.
MANIFEST – GCU software mismatch, communication halted.	The GCU 477 has incorrect software installed. The G1000 system should be serviced.
GCU KEYSTK – GCU [key name] Key is stuck.	A key is stuck on the GCU 477 bezel. Attempt to free the stuck key by pressing it several times. The G1000 system should be serviced if the problem persists.

GMC 710 MESSAGE ADVISORIES

Message	Comments
GMC CONFIG – GMC Config error. Config service req'd.	Error in the configuration of the GMC 710.
GMC FAIL – GMC is inoperative.	A failure has been detected in the GMC 710. The GMC 710 is unavailable.
MANIFEST – GMC software mismatch. Communication halted.	The GMC 710 has incorrect software installed. The system should be serviced.
GMC KEYSTK – GMC [key name] Key is stuck.	A key is stuck on the GMC 710 bezel. Attempt to free the stuck key by pressing it several times. The system should be serviced if the problem persists.

- Flight Instruments
- Nav/Com/XPDR/Audio
- AFCs
- GPS Nav
- Flight Planning
- Procedures
- Hazard Avoidance
- Additional Features
- Annun/Alerts
- Appendix
- Index

MISCELLANEOUS MESSAGE ADVISORIES

Message	Comments
FPL WPT LOCK – Flight plan waypoint is locked.	Upon power-up, the system detects that a stored flight plan waypoint is locked. This occurs when an aviation database update eliminates an obsolete waypoint. The flight plan cannot find the specified waypoint and flags this message. This can also occur with user waypoints in a flight plan that is deleted. Remove the waypoint from the flight plan if it no longer exists in any database, Or update the waypoint name/identifier to reflect the new information.
FPL WPT MOVE – Flight plan waypoint moved.	The system has detected that a waypoint coordinate has changed due to a new aviation database update. Verify that stored flight plans contain correct waypoint locations.
TIMER EXPIRD – Timer has expired.	The system notifies the pilot that the timer has expired.
DB CHANGE – Database changed. Verify user modified procedures.	This occurs when a stored flight plan contains procedures that have been manually edited. This alert is issued only after an aviation database update. Verify that the user-modified procedures in stored flight plans are correct and up to date.
DB CHANGE – Database changed. Verify stored airways.	This occurs when a stored flight plan contains an airway that is no longer consistent with the aviation database. This alert is issued only after an aviation database update. Verify use of airways in stored flight plans and reload airways as needed.

MISCELLANEOUS MESSAGE ADVISORIES (CONT.)

Message	Comments
LOCKED FPL – Cannot navigate locked flight plan.	This occurs when the pilot attempts to activate a stored flight plan that contains locked waypoint. Remove locked waypoint from flight plan. Update flight plan with current waypoint.
WPT ARRIVAL – Arriving at waypoint -[xxxx]	Arriving at waypoint [xxxx], where [xxxx] is the waypoint name.
STEEP TURN – Steep turn ahead.	A steep turn is 15 seconds ahead. Prepare to turn.
INSIDE ARSPC – Inside airspace.	The aircraft is inside the airspace.
ARSPC AHEAD – Airspace ahead less than 10 minutes.	Special use airspace is ahead of aircraft. The aircraft will penetrate the airspace within 10 minutes.
ARSPC NEAR – Airspace near and ahead.	Special use airspace is near and ahead of the aircraft position.
ARSPC NEAR – Airspace near – less than 2 nm.	Special use airspace is within 2 nm of the aircraft position.
APR INACTV – Approach is not active.	The system notifies the pilot that the loaded approach is not active. Activate approach when required.
SLCT FREQ – Select appropriate frequency for approach.	The system notifies the pilot to load the approach frequency for the appropriate NAV receiver. Select the correct frequency for the approach.
SLCT NAV – Select NAV on CDI for approach.	The system notifies the pilot to set the CDI to the correct NAV receiver. Set the CDI to the correct NAV receiver.
PTK FAIL – Parallel track unavailable: bad geometry.	Bad parallel track geometry.
PTK FAIL – Parallel track unavailable: invalid leg type.	Invalid leg type for parallel offset.

- Flight Instruments
- Nav/Com/XPDR/Audio
- AFCS
- GPS Nav
- Flight Planning
- Procedures
- Hazard Avoidance
- Additional Features
- Annunciations/Alerts
- Appendix
- Index

MISCELLANEOUS MESSAGE ADVISORIES (CONT.)

Message	Comments
PTK FAIL – Parallel track unavailable: past IAF.	IAF waypoint for parallel offset has been passed.
UNABLE V WPT – Can't reach current vertical waypoint.	The current vertical waypoint can not be reached within the maximum flight path angle and vertical speed constraints. The system automatically transitions to the next vertical waypoint.
VNV – Unavailable. Unsupported leg type in flight plan.	The lateral flight plan contains a procedure turn, vector, or other unsupported leg type prior to the active vertical waypoint. This prevents vertical guidance to the active vertical waypoint.
VNV – Unavailable. Excessive track angle error.	The current track angle error exceeds the limit, causing the vertical deviation to go invalid.
VNV – Unavailable. Excessive crosstrack error.	The current crosstrack exceeds the limit, causing vertical deviation to go invalid.
VNV – Unavailable. Parallel course selected.	A parallel course has been selected, causing the vertical deviation to go invalid.
NO WGS84 WPT – Non WGS 84 waypoint for navigation -[xxxx]	The selected waypoint [xxxx] does not use the WGS 84 datum. Cross-check position with alternate navigation sources.
TRAFFIC FAIL – Traffic device has failed.	The system is no longer receiving data from the traffic system. The traffic device should be serviced.
STRMSCP FAIL – Stormscope has failed.	Stormscope has failed. The G1000™ system should be serviced.
FAILED PATH – A data path has failed.	A data path connected to the GDU or the GIA 63/W has failed.

Flight Instruments
Nav/Com/XPDR/Audio
AFCS
GPS Nav
Flight Planning
Procedures
Hazard Avoidance
Additional Features
Annun/Alerts
Appendix
Index

MISCELLANEOUS MESSAGE ADVISORIES (CONT.)

Message	Comments
MAG VAR WARN – Large magnetic variance. Verify all course angles.	The GDU’s internal model cannot determine the exact magnetic variance for geographic locations near the magnetic poles. Displayed magnetic course angles may differ from the actual magnetic heading by more than 2°.
SVS – SVS DISABLED: Out of available terrain region.	Synthetic Vision is disabled because the aircraft is not within the boundaries of the installed terrain database.
SVS – SVS DISABLED: Terrain DB resolution too low.	Synthetic Vision is disabled because a terrain database of sufficient resolution (9 arc-second or better) is not currently installed.
SCHEDULER [#] – <message>.	Message criteria entered by the user.

- Flight Instruments
- Nav/Comm/XPDR/Audio
- AFCs
- GPS Nav
- Flight Planning
- Procedures
- Hazard Avoidance
- Additional Features
- Annun/Alerts
- Appendix
- Index

Flight Instruments

Nav/Com/XPDR/Audio

AFCs

GPS Nav

Flight Planning

Procedures

Hazard Avoidance

Additional Features

Annun/Alerts

Appendix

Index

Blank Page

APPENDIX

PFD SOFTKEY MAP

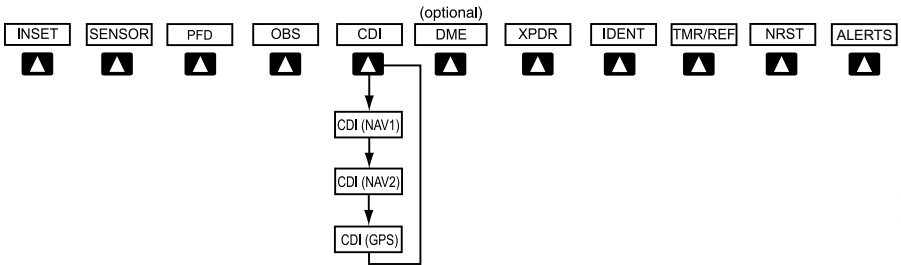

Top Level PFD Softkeys

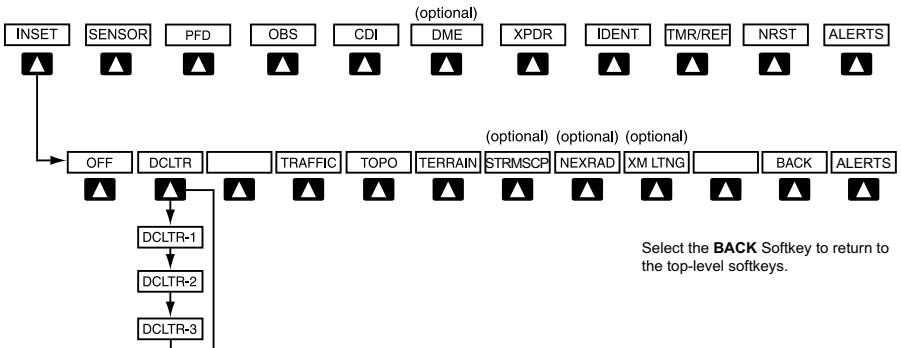

Inset Map Softkeys

INSET		Displays Inset Map in PFD lower left corner
	OFF	Removes Inset Map
	DCLTR (3)	Selects desired amount of map detail; cycles through declutter levels: DCLTR (No Declutter): All map features visible DCLTR-1: Declutters land data DCLTR-2: Declutters land and SUA data DCLTR-3: Removes everything except the active flight plan

Flight Instruments	TRAFFIC	Displays traffic information on Inset Map
	TOPO	Displays topographical data (e.g., coast-lines, terrain, rivers, lakes) and elevation scale on Inset Map
Nav/Com/XPDR/Audio	TERRAIN	Displays terrain information on Inset Map
AFCs	STRMSCP	Press to display the Stormscope lightning data on the Inset Map (within a 200 nm radius of the aircraft)
	NEXRAD	Displays NEXRAD weather and coverage information on Inset Map (optional feature)
GPS Nav	XM LTNG	Displays XM lightning information on Inset Map (optional feature)

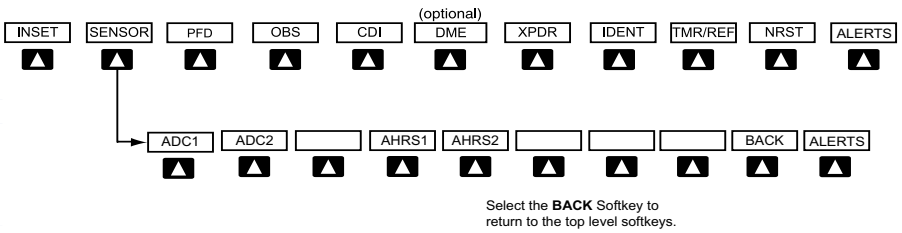

Sensor Softkeys

Additional Features	SENSOR	Displays softkeys for selecting the #1 and #2 AHRs and Air Data Computers
	ADC1	Selects the #1 Air Data Computer
	ADC2	Selects the #2 Air Data Computer
Annun/Alerts	AHRs1	Selects the #1 AHRs
	AHRs2	Selects the #2 AHRs

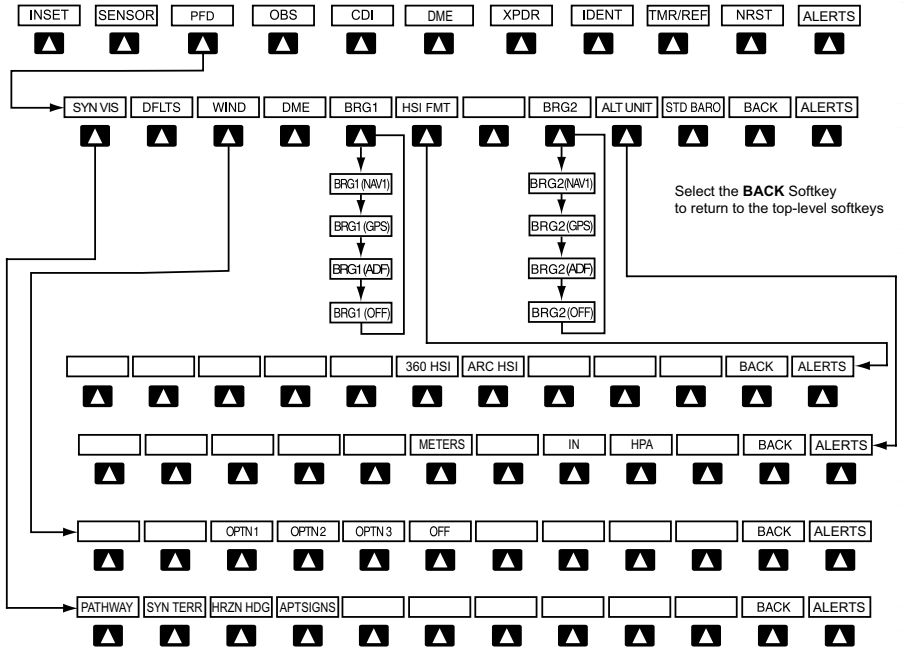

PFD Configuration Softkeys

PFD			Displays second-level softkeys for additional PFD configurations
	SYN VIS		Displays the softkeys for enabling or disabling Synthetic Vision features
		PATHWAY	Displays rectangular boxes representing the horizontal and vertical flight path of the active flight plan
		SYN TERR	Enables synthetic terrain depiction
		HRZN HDG	Displays compass heading along the Zero-Pitch line
		APTSIGNS	Displays position markers for airports within approximately 15 nm of the current aircraft position. Airport identifiers are displayed when the airport is within approximately 9 nm.

Flight Instruments	DFLTS		Resets PFD to default settings, including changing units to standard
Nav/Com/XPDR/Audio	WIND		Displays softkeys to select wind data parameters
		OPTN 1	Total direction and speed
		OPTN 2	
AFCs		OPTN 3	Longitudinal and lateral components
		OFF	Information not displayed
	DME		Displays the DME Information Window
GPS Nav	BRG1		Cycles the Bearing 1 Information Window through NAV1 or GPS/waypoint identifier and GPS-derived distance information, and ADF/frequency.
Flight Planning	HSI FRMT		Displays the HSI formatting softkeys
		360 HSI	Displays the HSI in a 360 degree format
Procedures		ARC HSI	Displays the HSI in an arc format
	BRG2		Cycles the Bearing 2 Information Window through NAV2 or GPS/waypoint identifier and GPS-derived distance information, and ADF/frequency.
Hazard Avoidance	ALT UNIT		Displays softkeys for setting the altimeter and BARO settings to metric units
Additional Features		METERS	When enabled, displays altimeter in meters
Annun/Alerts		IN	Press to display the BARO setting as inches of mercury
		HPA	Press to display the BARO setting as hectopascals
Appendix	STD BARO		Sets barometric pressure to 29.92 in Hg (1013 hPa)

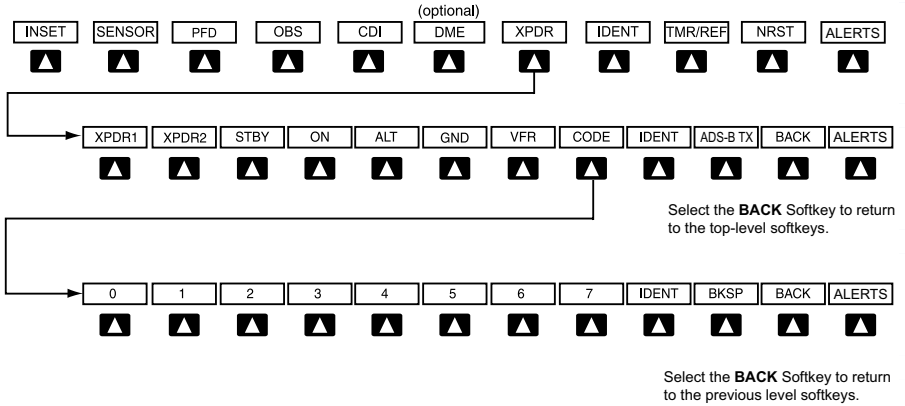

Transponder Softkeys

XPDR		Displays transponder mode selection softkeys
	XPDR1	Selects the #1 transponder as active
	XPDR2	Selects the #2 transponder as active
	STBY	Selects Standby Mode (transponder does not reply to any interrogations)
	ON	Selects Mode A (transponder replies to interrogations)
	ALT	Selects Mode C – Altitude Reporting Mode (transponder replies to identification and altitude interrogations)
	GND	Manually selects Ground Mode, the transponder does not allow Mode A and Mode C replies, but it does permit acquisition squitter and replies to discretely addressed Mode S interrogations.

Flight Instruments	VFR		Automatically enters the VFR code (1200 in the U.S.A. only)
Nav/Com/XPDR/Audio	CODE		Displays transponder code selection soft-keys 0-7
		0 — 7	Use numbers to enter code
		BKSP	Removes numbers entered, one at a time
AFCs	IDENT		Activates the Special Position Identification (SPI) pulse for 18 seconds, identifying the transponder return on the ATC screen
GPS Nav	ADS-B TX		Activates/deactivates transmission of the aircraft's three-dimensional position and aircraft heading for reception by ADS-B systems.
Flight Planning	TMR/REF		Displays Timer/References Window
	NRST		Displays Nearest Airports Window
Procedures	ALERT		Displays Alerts Window

MFD SOFTKEY MAP

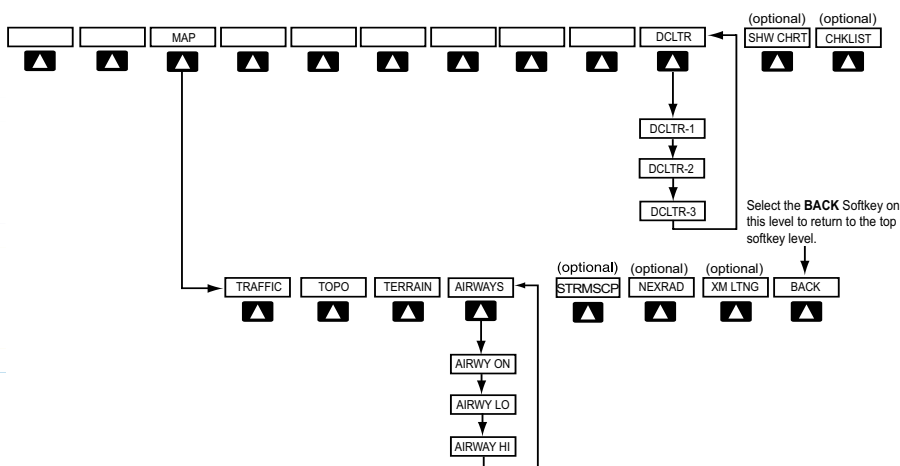

MFD Softkeys

MAP		Enables second-level Navigation Map softkeys	Flight Instruments
	TRAFFIC	Displays traffic information on Navigation Map	Nav/Com/XPDR/Audio
	TOPO	Displays topographical data (e.g., coastlines, terrain, rivers, lakes) and elevation scale on Navigation Map	AFCS
	TERRAIN	Displays terrain information on Navigation Map	GPS Nav
	AIRWAYS	Displays airways on the map; cycles through the following: AIRWAYS: No airways are displayed AIRWY ON: All airways are displayed AIRWY LO: Only low altitude airways are displayed AIRWY HI: Only high altitude airways are displayed	Flight Planning
	STRMSCP	Displays Stormscope weather and coverage information on Navigation Map (optional feature)	Procedures
	NEXRAD	Displays NEXRAD weather and coverage information on Navigation Map (optional feature)	Hazard Avoidance
	XM LTNG	Displays XM lightning information on Navigation Map (optional feature)	Additional Features
	BACK	Returns to top-level softkeys	Annun/Alerts
DCLTR (3)		Selects desired amount of map detail; cycles through declutter levels: DCLTR (No Declutter): All map features visible DCLTR-1: Declutters land data DCLTR-2: Declutters land and SUA data DCLTR-3: Removes everything except the active flight plan	Appendix
SHW CHRT		When available, displays optional airport and terminal procedure charts	Index
CHKLIST		When available, displays optional checklists	

Flight Instruments

Nav/Com/XPDR/Audio

AFCS

GPS Nav

Flight Planning

Procedures

Hazard Avoidance

Additional Features

Annun/Alerts

Appendix

Index

Blank Page

A

Activate a flight plan 14
 Active Channel 48
 ADF 5, 6, 78
 ADS-B 80
 AHRS 65, 66, 67, 69
 Air Data Computer 52
 Airport Signs 45, 46
 Airways 81
 Alert messages 68
 ALT 40
 Altitude mode 40
 Altitude volume 40
 Antenna stabilization 44
 Antenna tilt 42
 AP 52
 Attitude & Heading Reference System
 52
 Audio panel controls
 NAV1, NAV2 6

B

Barometric Altitude Minimums 3
 Barometric pressure 78
 Bearing line 43, 44

C

CDI 1, 2, 6, 71
 Cell 35, 36
 Cell mode 36
 Channel Presets 49
 ChartView 46, 47
 Code selection softkeys 5
 COM 5, 6

D

Database Updates 81
 DCLTR Softkey 46

Declutter 75, 81
 Direct-to 13
 DME 5, 6

E

Edit a flight plan 27

F

FD 52
 Flight Director 9
 Flight path marker 45
 FliteCharts® 46, 47
 Frequency Transfer 6

G

Gain 43

H

HF 5, 6
 Horizon heading 45
 Horizontal scan 43

I

Inhibit 41
 Inhibit TAWS 41
 Inset Map 75, 76
 IOI 54

J

Jeppesen 47

L

Lightning 35, 36, 76

M

Map panning 37
 Message advisories 56 – 67, 69 – 73
 MET 52

Flight Instruments

Nav/Com/XPDR/Audio

AFCS

GPS Nav

Flight Planning

Procedures

Hazard Avoidance

Additional Features

Annun/Alerts

Appendix

Index

METAR 37
Minimums 55
MISCOMP 51
Mistrim 52, 53
Mode S 79
Mode selection softkeys 5
Multi Function Display (MFD)
Softkeys 80

N

NACO 47
NAV 6
NAV1 2, 6
NAV2 6
Navigation database 15, 16
NEXRAD 37, 38, 76, 81

O

OBS 2
Obstacles 60, 62
Overspeed Protection 10

P

Pathways 45
PIT 51

R

RADIO softkey 48
ROC 53, 54

S

SafeTaxi® 46
Sector scan 44
Sensor 52
STAB 44
Standby 42
Store Flight Plan 27
Stormscope lightning data 35, 36, 76

Strike 35
Strike mode 36
SVS 45, 73
SVS Terrain 45
Synthetic Vision System 45

T

TA 55
TAF 37
TAS 39, 40, 65
TAWS 40, 41, 53, 55
TAWS-B 40
Terrain 40, 60, 76, 81
Tilt line 42
Timer 70
Topographical data 76, 81
Traffic 35, 39, 76, 81
Traffic advisory 38
Traffic Advisory 55
Traffic map page 39, 40
Transponder 5, 79, 80

V

Vertical speed guidance 16
Vertical track 55
VNV 13, 72
Vspeed 2

W

WAAS 62
WATCH® 44
Weather Attenuated Color Highlight 44
Weather data link page 37
Weather radar 42
Wind data 78

X

- XM lightning 76, 81
- XM weather 37
- XPDR Softkey 5

Flight Instruments

Nav/Com/XPDR/Audio

AFCS

GPS Nav

Flight Planning

Procedures

Hazard Avoidance

Additional Features

Annun/Alerts

Appendix

Index

Flight Instruments

Nav/Com/XPDR/Audio

AFCs

GPS Nav

Flight Planning

Procedures

Hazard Avoidance

Additional Features

Annun/Alerts

Appendix

Index

Blank Page



GARMIN®



Garmin International, Inc.
1200 East 151st Street
Olathe, KS 66062, U.S.A.
p: 913.397.8200 f: 913.397.8282

Garmin AT, Inc.
2345 Turner Road SE
Salem, OR 97302, U.S.A.
p: 503.391.3411 f: 503.364.2138

Garmin (Europe) Ltd
Liberty House, Bulls Copse Road
Hounslow Business Park
Southampton, SO40 9RB, U.K.
p: 44/0870.8501241 f: 44/0870.8501251

Garmin Corporation
No. 68, Jangshu 2nd Road
Shijr, Taipei County, Taiwan
p: 886/2.2642.9199 f: 886/2.2642.9099

www.garmin.com