

# **GA-G41MT-USB3**

# **GA-G41MT-D3V**

LGA775 socket motherboard for Intel® Core™ processor family/  
Intel® Pentium® processor family/Intel® Celeron® processor family

## **User's Manual**

Rev. 1301

12ME-41MTD3V-1301R

## Declaration of Conformity

We, Manufacturer/Importer

G.B.T. Technology Trading GmbH

Bültenkopff 16, 22647 Hamburg, Germany

declare that the product

GA-G41MT-USB3/G4-41MT-D3V

(reference to the specification under which conformity is declared)  
in accordance with 2004/108/EC EMC Directive

- |  |  |  |   |
|--|--|--|---|
| <input type="checkbox"/> EN 55011            | Limits and methods of measurement of radio disturbance characteristics of household appliances, information technology equipment and similar electrical high frequency equipment | <input checked="" type="checkbox"/> EN 61000-3-2 | Disturbances in supply systems caused by household appliances and similar electrical equipment "Voltage fluctuations" |
| <input type="checkbox"/> EN 55013            | Limits and methods of measurement of radio disturbance characteristics of broadcast receivers and associated equipment   | <input checked="" type="checkbox"/> EN 61000-3-3 | Disturbances in supply systems caused by household appliances and similar electrical equipment "Voltage fluctuations" |
| <input type="checkbox"/> EN 55014-1          | Limits and methods of measurement of radio disturbance characteristics of portable tools and similar electrical apparatus  | <input checked="" type="checkbox"/> EN 50074     | Information Technology equipment/immunity characteristics/limits and methods of measurement                           |
| <input type="checkbox"/> EN 55015            | Limits and methods of measurement of radio disturbance characteristics of fluorescent lamps and luminaires   | <input type="checkbox"/> EN 50082-1              | Generic immunity standard Part 1: Residential, commercial and light industry  |
| <input type="checkbox"/> EN 55020            | Immunity from radio interference of broadcast receivers and associated equipment   | <input type="checkbox"/> EN 50082-2              | Generic immunity standard Part 2: Industrial environment  |
| <input checked="" type="checkbox"/> EN 55022 | Limits and methods of measurement of radio disturbance characteristics of information technology equipment   | <input type="checkbox"/> EN 55014-2              | Immunity requirements for household appliances tools and similar apparatus  |
| <input type="checkbox"/> DIN VDE 0855        | Colored distribution systems; Equipment for receiving and/or distribution from Part 10   | <input type="checkbox"/> EN 50091-2              | EMC requirements for uninterruptible power systems (UPS)  |
| <input type="checkbox"/> Part 10             |  |  |   |
| <input type="checkbox"/> Part 15             |  |  |   |
- CE marking
- (CE conformity marking)
- 
- The manufacturer also declares the conformity of above mentioned product with the actual relevant safety standards in accordance with LVD 2006/95/EC
- |                                   |   |  |  |
|-----------------------------------|---|--|--|
| <input type="checkbox"/> EN 60085 | Safety requirements for mains operated electronic and related apparatus for household and similar general use | <input checked="" type="checkbox"/> EN 60950 | Safety for information technology equipment including information business equipment |
| <input type="checkbox"/> EN 60335 | Safety of household and similar electrical appliances   | <input type="checkbox"/> EN 50091-1          | General and Safety requirements for uninterruptible power systems (UPS)              |
- Manufacturer/Importer
- Signature: Timmy Huang
- Name: Timmy Huang

(Stamp)

Date: Feb. 25, 2011

## DECLARATION OF CONFORMITY

Per FCC Part 2 Section 2.1077(a)



Responsible Party Name: G.B.T. INC. (U.S.A)

Address: 17358 Railroad Street

City of Industry, CA 91748

Phone/Fax No: (818) 854-9336/ (818) 854-9339

hereby declares that the product

Product Name: **Motherboard**

Model Number: GA-G41MT-USB3/  
GA-G41MT-D3V

Conforms to the following specifications:

FCC Part 15, Subpart B, Section 15.107(a) and Section 15.109

(a), Class B Digital Device

### Supplementary Information:

This device complies with part 15 of the FCC Rules. Operation is subject to the following two conditions: (1) This device may not cause harmful and (2) this device must accept any interference received, including that may cause undesired operation.

Representative Person's Name: ERIC LU

Signature: Eric Lu

Date: Feb. 25, 2011

## **Copyright**

© 2011 GIGA-BYTE TECHNOLOGY CO., LTD. All rights reserved.

The trademarks mentioned in this manual are legally registered to their respective owners.

## **Disclaimer**

Information in this manual is protected by copyright laws and is the property of GIGABYTE.

Changes to the specifications and features in this manual may be made by GIGABYTE without prior notice. No part of this manual may be reproduced, copied, translated, transmitted, or published in any form or by any means without GIGABYTE's prior written permission.

- In order to assist in the use of this product, carefully read the User's Manual.
- For product-related information, check on our website at: <http://www.gigabyte.com>

## **Identifying Your Motherboard Revision**

The revision number on your motherboard looks like this: "REV: X.X." For example, "REV: 1.0" means the revision of the motherboard is 1.0. Check your motherboard revision before updating motherboard BIOS, drivers, or when looking for technical information.

Example:

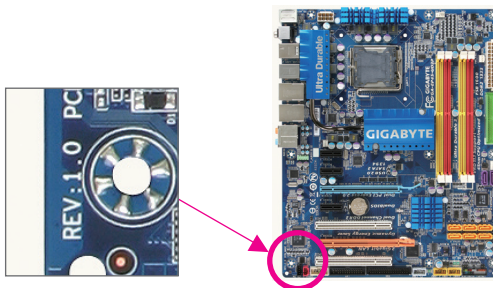

# Table of Contents

GA-G41MT-USB3/GA-G41MT-D3V Motherboard Layout .....	5
Chapter 1 Hardware Installation .....	6
1-1 Installation Precautions .....	6
1-2 Product Specifications .....	7
1-3 Installing the CPU and CPU Cooler .....	9
1-4 Installing the Memory .....	10
1-5 Installing an Expansion Card .....	10
1-6 Back Panel Connectors .....	11
1-7 Internal Connectors .....	12
Chapter 2 BIOS Setup .....	19
2-1 Startup Screen .....	19
2-2 The Main Menu .....	19
2-3 MB Intelligent Tweaker(M.I.T.) .....	20
2-4 Standard CMOS Features .....	26
2-5 Advanced BIOS Features .....	27
2-6 Advanced Chipset Features .....	29
2-7 Integrated Peripherals .....	30
2-8 Power Management Setup .....	31
2-9 PnP/PCI Configurations .....	33
2-10 PC Health Status .....	33
2-11 Load Fail-Safe Defaults .....	34
2-12 Load Optimized Defaults .....	35
2-13 Set Supervisor/User Password .....	35
2-14 Save & Exit Setup .....	36
2-15 Exit Without Saving .....	36
Chapter 3 Drivers Installation .....	37
3-1 Installing Chipset Drivers .....	37

# GA-G41MT-USB3/GA-G41MT-D3V Motherboard Layout

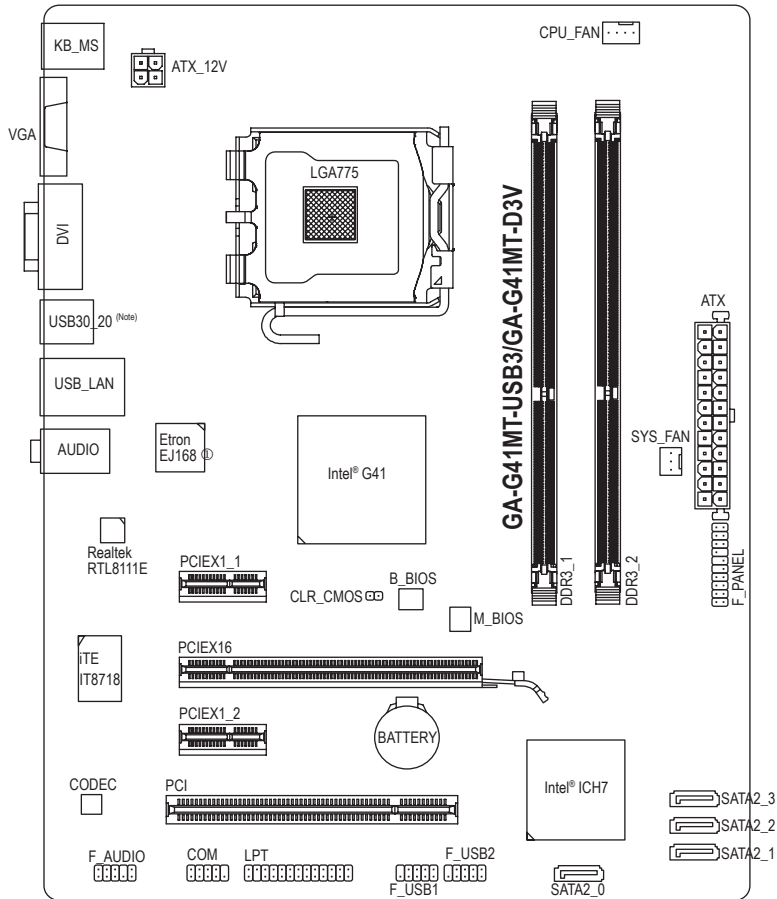

## Box Contents

- GA-G41MT-USB3 or GA-G41MT-D3V motherboard
- Motherboard driver disk
- User's Manual
- Two SATA cables
- I/O Shield

The box contents above are for reference only and the actual items shall depend on the product package you obtain.

(Note) Only the GA-G41MT-USB3 supports USB 3.0.

① Only for GA-G41MT-USB3.











# Chapter 1 Hardware Installation

## 1-1 Installation Precautions

The motherboard contains numerous delicate electronic circuits and components which can become damaged as a result of electrostatic discharge (ESD). Prior to installation, carefully read the user's manual and follow these procedures:

- Prior to installation, do not remove or break motherboard S/N (Serial Number) sticker or warranty sticker provided by your dealer. These stickers are required for warranty validation.
- Always remove the AC power by unplugging the power cord from the power outlet before installing or removing the motherboard or other hardware components.
- When connecting hardware components to the internal connectors on the motherboard, make sure they are connected tightly and securely.
- When handling the motherboard, avoid touching any metal leads or connectors.
- It is best to wear an electrostatic discharge (ESD) wrist strap when handling electronic components such as a motherboard, CPU or memory. If you do not have an ESD wrist strap, keep your hands dry and first touch a metal object to eliminate static electricity.
- Prior to installing the motherboard, please have it on top of an antistatic pad or within an electrostatic shielding container.
- Before unplugging the power supply cable from the motherboard, make sure the power supply has been turned off.
- Before turning on the power, make sure the power supply voltage has been set according to the local voltage standard.
- Before using the product, please verify that all cables and power connectors of your hardware components are connected.
- To prevent damage to the motherboard, do not allow screws to come in contact with the motherboard circuit or its components.
- Make sure there are no leftover screws or metal components placed on the motherboard or within the computer casing.
- Do not place the computer system on an uneven surface.
- Do not place the computer system in a high-temperature environment.
- Turning on the computer power during the installation process can lead to damage to system components as well as physical harm to the user.
- If you are uncertain about any installation steps or have a problem related to the use of the product, please consult a certified computer technician.

## 1-2 Product Specifications

 CPU	<ul style="list-style-type: none"> <li>Support for an Intel® Core™ 2 Extreme processor/ Intel® Core™ 2 Quad processor/ Intel® Core™ 2 Duo processor/ Intel® Pentium® processor/ Intel® Celeron® processor in the LGA775 package (Go to GIGABYTE's website for the latest CPU support list.)</li> <li>L2 cache varies with CPU</li> </ul>
 Front Side Bus	<ul style="list-style-type: none"> <li>1333(O.C.)/1066/800 MHz FSB</li> </ul>
 Chipset	<ul style="list-style-type: none"> <li>North Bridge: Intel® G41 Express Chipset</li> <li>South Bridge: Intel® ICH7</li> </ul>
 Memory	<ul style="list-style-type: none"> <li>2 x 1.5V DDR3 DIMM sockets supporting up to 8 GB of system memory           <ul style="list-style-type: none"> <li>* Due to Windows 32-bit operating system limitation, when more than 4 GB of physical memory is installed, the actual memory size displayed will be less than 4 GB.</li> </ul> </li> <li>Dual channel memory architecture</li> <li>Support for DDR3 1333(O.C.)/1066/800 MHz memory modules (Go to GIGABYTE's website for the latest supported memory speeds and memory modules.)</li> </ul>
 Onboard Graphics	<ul style="list-style-type: none"> <li>Integrated in the Chipset:           <ul style="list-style-type: none"> <li>1 x D-Sub port</li> <li>1 x DVI-D port, supporting a maximum resolution of 1920x1200               <ul style="list-style-type: none"> <li>* The DVI-D port does not support D-Sub connection by adapter.</li> </ul> </li> </ul> </li> </ul>
 Audio	<ul style="list-style-type: none"> <li>Realtek ALC889 codec</li> <li>High Definition Audio</li> <li>2/4/5.1/7.1-channel           <ul style="list-style-type: none"> <li>* To configure 7.1-channel audio, you have to use an HD front panel audio module and enable the multi-channel audio feature through the audio driver.</li> </ul> </li> </ul>
 LAN	<ul style="list-style-type: none"> <li>1 x Realtek RTL8111E chip (10/100/1000 Mbit)</li> </ul>
 Expansion Slots	<ul style="list-style-type: none"> <li>1 x PCI Express x16 slot, running at x16</li> <li>2 x PCI Express x1 slots</li> <li>1 x PCI slot</li> </ul>
 Storage Interface	<ul style="list-style-type: none"> <li>South Bridge:           <ul style="list-style-type: none"> <li>4 x SATA 3Gb/s connectors supporting up to 4 SATA 3Gb/s devices</li> </ul> </li> </ul>
 USB	<ul style="list-style-type: none"> <li>South Bridge:           <ul style="list-style-type: none"> <li>Up to 6 USB 2.0/1.1 ports (2 on the back panel, 4 via the USB brackets connected to the internal USB headers)<sup>①</sup></li> <li>Up to 8 USB 2.0/1.1 ports (4 on the back panel, 4 via the USB brackets connected to the internal USB headers)<sup>②</sup></li> </ul> </li> <li>Etron EJ168 chips:<sup>①</sup> <ul style="list-style-type: none"> <li>Up to 2 USB 3.0/2.0 ports on the back panel<sup>①</sup></li> </ul> </li> </ul>
 Internal Connectors	<ul style="list-style-type: none"> <li>1 x 24-pin ATX main power connector</li> <li>1 x 4-pin ATX 12V power connector</li> <li>4 x SATA 3Gb/s connectors</li> </ul>

① Only for GA-G41MT-USB3.





② Only for GA-G41MT-D3V.

	Internal Connectors	<ul style="list-style-type: none"> <li>◆ 1 x CPU fan header</li> <li>◆ 1 x system fan header</li> <li>◆ 1 x front panel header</li> <li>◆ 1 x front panel audio header</li> <li>◆ 2 x USB 2.0/1.1 headers</li> <li>◆ 1 x serial port header</li> <li>◆ 1 x parallel port</li> <li>◆ 1 x clearing CMOS jumper</li> </ul>
	Back Panel Connectors	<ul style="list-style-type: none"> <li>◆ 1 x PS/2 keyboard port</li> <li>◆ 1 x PS/2 mouse port</li> <li>◆ 1 x D-Sub port</li> <li>◆ 1 x DVI-D port</li> <li>◆ 4 x USB 2.0/1.1 ports②</li> <li>◆ 2 x USB 2.0/1.1 ports①</li> <li>◆ 2 x USB 3.0/2.0 ports①</li> <li>◆ 1 x RJ-45 port</li> <li>◆ 3 x audio jacks (Line In/Line Out/Microphone)</li> </ul>
	I/O	<ul style="list-style-type: none"> <li>◆ iTE IT8718</li> </ul>
	Hardware Monitor	<ul style="list-style-type: none"> <li>◆ System voltage detection</li> <li>◆ CPU temperature detection</li> <li>◆ CPU/System fan speed detection</li> <li>◆ CPU overheating warning</li> <li>◆ CPU/System fan fail warning</li> <li>◆ CPU fan speed control <ul style="list-style-type: none"> <li>* Whether the CPU fan speed control function is supported will depend on the CPU cooler you install.</li> </ul> </li> </ul>
	BIOS	<ul style="list-style-type: none"> <li>◆ 2 x 8 Mbit flash</li> <li>◆ Use of licensed AWARD BIOS</li> <li>◆ Support for DualBIOS™</li> <li>◆ PnP 1.0a, DMI 2.0, SM BIOS 2.4, ACPI 1.0b</li> </ul>
	Unique Features	<ul style="list-style-type: none"> <li>◆ Support for @BIOS</li> <li>◆ Support for Q-Flash</li> <li>◆ Support for Xpress BIOS Rescue</li> <li>◆ Support for Download Center</li> <li>◆ Support for Xpress Install</li> <li>◆ Support for Xpress Recovery2</li> <li>◆ Support for EasyTune <ul style="list-style-type: none"> <li>* Available functions in EasyTune may differ by motherboard model.</li> </ul> </li> <li>◆ Support for Easy Energy Saver <ul style="list-style-type: none"> <li>* Due to the hardware limitation, you must install the Intel®Core™2 Extreme/ Core™2 Quad/ Core™2 Duo/Pentium Dual-Core/Celeron Dual-Core/ Celeron 400 Series CPU to enable support for Easy Energy Saver.</li> </ul> </li> <li>◆ Support for Smart Recovery</li> </ul>

① Only for GA-G41MT-USB3.

② Only for GA-G41MT-D3V.



 Unique Features	<ul style="list-style-type: none"> <li>◆ Support for ON/OFF Charge</li> <li>◆ Support for Q-Share</li> </ul>
 Bundled Software	<ul style="list-style-type: none"> <li>◆ Norton Internet Security (OEM version)</li> </ul>
 Operating System	<ul style="list-style-type: none"> <li>◆ Support for Microsoft® Windows 7/Vista/XP</li> </ul>
 Form Factor	<ul style="list-style-type: none"> <li>◆ Micro ATX Form Factor; 24.4cm x 19.4cm</li> </ul>

\* GIGABYTE reserves the right to make any changes to the product specifications and product-related information without prior notice.

## 1-3 Installing the CPU and CPU Cooler



Read the following guidelines before you begin to install the CPU:

- Make sure that the motherboard supports the CPU.  
(Go to GIGABYTE's website for the latest CPU support list.)
- Always turn off the computer and unplug the power cord from the power outlet before installing the CPU to prevent hardware damage.
- Locate the pin one of the CPU. The CPU cannot be inserted if oriented incorrectly. (Or you may locate the notches on both sides of the CPU and alignment keys on the CPU socket.)
- Apply an even and thin layer of thermal grease on the surface of the CPU.
- Do not turn on the computer if the CPU cooler is not installed, otherwise overheating and damage of the CPU may occur.
- Set the CPU host frequency in accordance with the CPU specifications. It is not recommended that the system bus frequency be set beyond hardware specifications since it does not meet the standard requirements for the peripherals. If you wish to set the frequency beyond the standard specifications, please do so according to your hardware specifications including the CPU, graphics card, memory, hard drive, etc.

### Installing the CPU

- A. Locate the alignment keys on the motherboard CPU socket and the notches on the CPU.

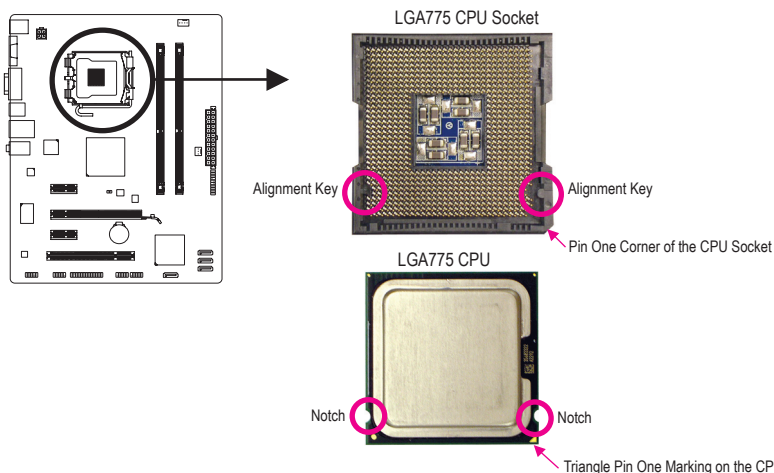

## 1-4 Installing the Memory



Read the following guidelines before you begin to install the memory:

- Make sure that the motherboard supports the memory. It is recommended that memory of the same capacity, brand, speed, and chips be used.  
(Go to GIGABYTE's website for the latest supported memory speeds and memory modules.)
- Always turn off the computer and unplug the power cord from the power outlet before installing the memory to prevent hardware damage.
- Memory modules have a foolproof design. A memory module can be installed in only one direction. If you are unable to insert the memory, switch the direction.

### Dual Channel Memory Configuration

This motherboard provides two DDR3 memory sockets and supports Dual Channel Technology. After the memory is installed, the BIOS will automatically detect the specifications and capacity of the memory. Enabling Dual Channel memory mode will double the original memory bandwidth.

The two DDR3 memory sockets are divided into two channels and each channel has one memory socket as following:

▶▶ Channel 0: DDR3\_1

▶▶ Channel 1: DDR3\_2

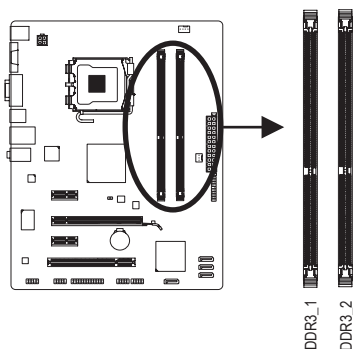

Due to chipset limitations, read the following guidelines before installing the memory in Dual Channel mode.

1. Dual Channel mode cannot be enabled if only one DDR3 memory module is installed.
2. When enabling Dual Channel mode with two memory modules, it is recommended that memory of the same capacity, brand, speed, and chips be used.

## 1-5 Installing an Expansion Card



Read the following guidelines before you begin to install an expansion card:

- Make sure the motherboard supports the expansion card. Carefully read the manual that came with your expansion card.
- Always turn off the computer and unplug the power cord from the power outlet before installing an expansion card to prevent hardware damage.

## 1-6 Back Panel Connectors

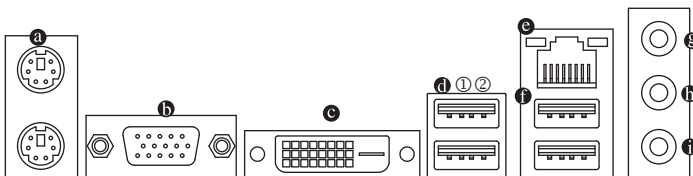

### a PS/2 Keyboard and PS/2 Mouse Port

Use the upper port (green) to connect a PS/2 mouse and the lower port (purple) to connect a PS/2 keyboard.

### b D-Sub Port

The D-Sub port supports a 15-pin D-Sub connector. Connect a monitor that supports D-Sub connection to this port.

### c DVI-D Port <sup>(Note)</sup>

The DVI-D port conforms to the DVI-D specification and supports a maximum resolution of 1920x1200 (the actual resolutions supported depend on the monitor being used). Connect a monitor that supports DVI-D connection to this port.

### d USB 3.0/2.0 Port <sup>①</sup>

The USB 3.0 port supports the USB 3.0 specification and is compatible to the USB 2.0/1.1 specification. Use this port for USB devices such as a USB keyboard/mouse, USB printer, USB flash drive and etc.

### e USB 2.0/1.1 Port <sup>②</sup>

The USB port supports the USB 2.0/1.1 specification. Use this port for USB devices such as a USB keyboard/mouse, USB printer, USB flash drive and etc.

### e RJ-45 LAN Port

The Gigabit Ethernet LAN port provides Internet connection at up to 1 Gbps data rate. The following describes the states of the LAN port LEDs.

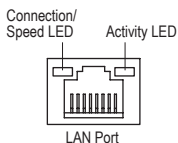

Connection/Speed LED:

State	Description
Orange	1 Gbps data rate
Green	100 Mbps data rate
Off	10 Mbps data rate

Activity LED:

State	Description
Blinking	Data Transmission or receiving is occurring
Off	No data transmission or receiving is occurring

### f USB 2.0/1.1 Port

The USB port supports the USB 2.0/1.1 specification. Use this port for USB devices such as a USB keyboard/mouse, USB printer, USB flash drive and etc.



- When removing the cable connected to a back panel connector, first remove the cable from your device and then remove it from the motherboard.
- When removing the cable, pull it straight out from the connector. Do not rock it side to side to prevent an electrical short inside the cable connector.

① Only for GA-G41MT-USB3.

② Only for GA-G41MT-D3V.

(Note) The DVI-D port does not support D-Sub connection by adapter.

⑨ **Line In Jack (Blue)**

The default line in jack. Use this audio jack for line in devices such as an optical drive, walkman, etc.

⑩ **Line Out Jack (Green)**

The default line out jack. Use this audio jack for a headphone or 2-channel speaker. This jack can be used to connect front speakers in a 4/5.1/7.1-channel audio configuration.

⑪ **Mic In Jack (Pink)**

The default Mic in jack. Microphones must be connected to this jack.



To configure 7.1-channel audio, you have to use an HD front panel audio module and enable the multi-channel audio feature through the audio driver.

## 1-7 Internal Connectors

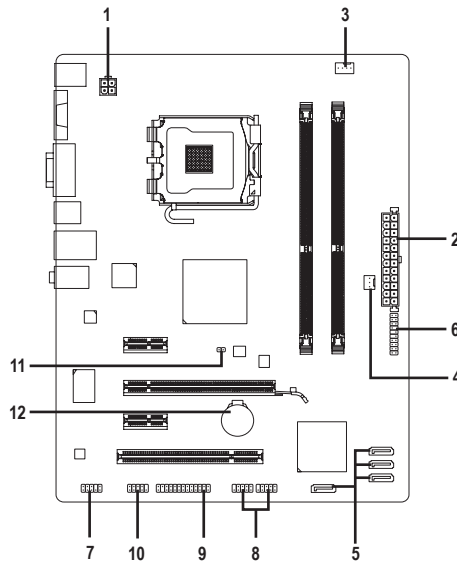

1) ATX_12V	7) F_AUDIO
2) ATX	8) F_USB1/F_USB2
3) CPU_FAN	9) LPT
4) SYS_FAN	10) COM
5) SATA2_0/1/2/3	11) CLR_CMOS
6) F_PANEL	12) BATTERY



Read the following guidelines before connecting external devices:

- First make sure your devices are compliant with the connectors you wish to connect.
- Before installing the devices, be sure to turn off the devices and your computer. Unplug the power cord from the power outlet to prevent damage to the devices.
- After installing the device and before turning on the computer, make sure the device cable has been securely attached to the connector on the motherboard.

## 1/2) ATX\_12V/ATX (2x2 12V Power Connector and 2x12 Main Power Connector)

With the use of the power connector, the power supply can supply enough stable power to all the components on the motherboard. Before connecting the power connector, first make sure the power supply is turned off and all devices are properly installed. The power connector possesses a foolproof design. Connect the power supply cable to the power connector in the correct orientation. The 12V power connector mainly supplies power to the CPU. If the 12V power connector is not connected, the computer will not start.



To meet expansion requirements, it is recommended that a power supply that can withstand high power consumption be used (500W or greater). If a power supply is used that does not provide the required power, the result can lead to an unstable or unbootable system.

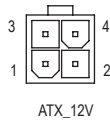
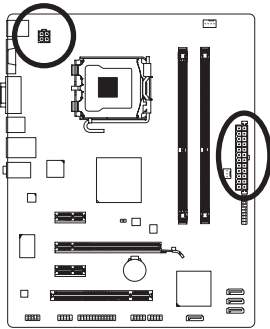

ATX\_12V:

Pin No.	Definition
1	GND
2	GND
3	+12V
4	+12V

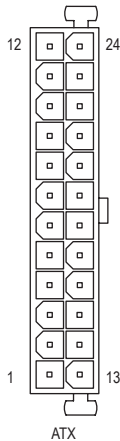

ATX:

Pin No.	Definition	Pin No.	Definition
1	3.3V	13	3.3V
2	3.3V	14	-12V
3	GND	15	GND
4	+5V	16	PS_ON (soft On/Off)
5	GND	17	GND
6	+5V	18	GND
7	GND	19	GND
8	Power Good	20	-5V
9	5VSB (stand by +5V)	21	+5V
10	+12V	22	+5V
11	+12V (Only for 2x12-pin ATX)	23	+5V (Only for 2x12-pin ATX)
12	3.3V (Only for 2x12-pin ATX)	24	GND (Only for 2x12-pin ATX)

### 3/4) CPU\_FAN/SYS\_FAN (Fan Headers)

The motherboard has a 4-pin CPU fan header (CPU\_FAN) and a 3-pin (SYS\_FAN) system fan header. Most fan headers possess a foolproof insertion design. When connecting a fan cable, be sure to connect it in the correct orientation (the black connector wire is the ground wire). The motherboard supports CPU fan speed control, which requires the use of a CPU fan with fan speed control design. For optimum heat dissipation, it is recommended that a system fan be installed inside the chassis.

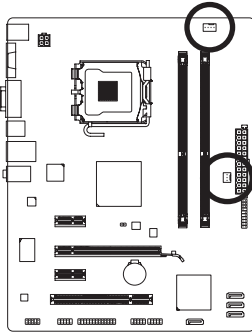

CPU\_FAN:

Pin No.	Definition
1	GND
2	+12V
3	Sense
4	Speed Control

SYS\_FAN:

Pin No.	Definition
1	GND
2	+12V
3	Sense



- Be sure to connect fan cables to the fan headers to prevent your CPU and system from overheating. Overheating may result in damage to the CPU or the system may hang.
- These fan headers are not configuration jumper blocks. Do not place a jumper cap on the headers.

### 5) SATA2\_0/1/2/3 (SATA 3Gb/s Connectors)

The SATA connectors conform to SATA 3Gb/s standard and are compatible with SATA 1.5Gb/s standard. Each SATA connector supports a single SATA device.

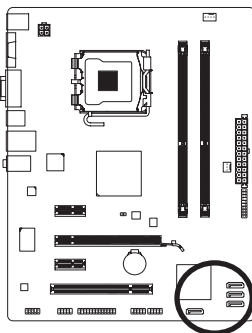

Pin No.	Definition
1	GND
2	TXP
3	TXN
4	GND
5	RXN
6	RXP
7	GND

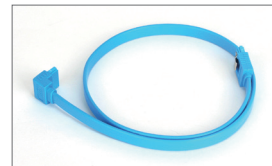

Please connect the L-shaped end of the SATA cable to your SATA hard drive.

## 6) F\_PANEL (Front Panel Header)

Connect the power switch, reset switch, speaker and system status indicator on the chassis front panel to this header according to the pin assignments below. Note the positive and negative pins before connecting the cables.

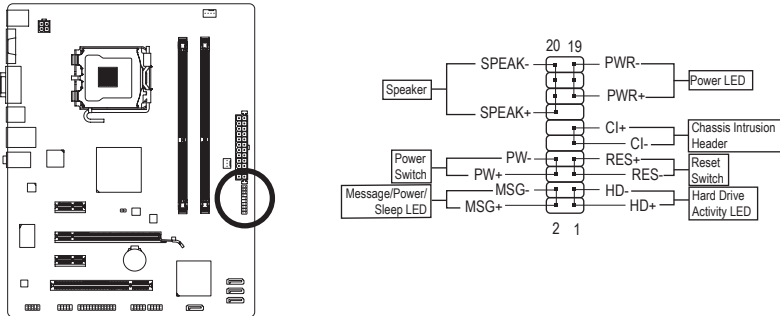

- **MSG/PWR (Message/Power/Sleep LED):**

System Status	LED	Connects to the power status indicator on the chassis front panel. The LED is on when the system is operating. The LED keeps blinking when the system is in S1 sleep state. The LED is off when the system is in S3/S4 sleep state or powered off (S5).
S0	On	
S1	Blinking	
S3/S4/S5	Off	

- **PW (Power Switch):**

Connects to the power switch on the chassis front panel. You may configure the way to turn off your system using the power switch (refer to Chapter 2, "BIOS Setup," "Power Management Setup," for more information).

- **SPEAK (Speaker):**

Connects to the speaker on the chassis front panel. The system reports system startup status by issuing a beep code. One single short beep will be heard if no problem is detected at system startup. If a problem is detected, the BIOS may issue beeps in different patterns to indicate the problem.

- **HD (Hard Drive Activity LED)**

Connects to the hard drive activity LED on the chassis front panel. The LED is on when the hard drive is reading or writing data.

- **RES (Reset Switch):**

Connects to the reset switch on the chassis front panel. Press the reset switch to restart the computer if the computer freezes and fails to perform a normal restart.

- **CI (Chassis Intrusion Header):**

Connects to the chassis intrusion switch/sensor on the chassis that can detect if the chassis cover has been removed. This function requires a chassis with a chassis intrusion switch/sensor.



The front panel design may differ by chassis. A front panel module mainly consists of power switch, reset switch, power LED, hard drive activity LED, speaker and etc. When connecting your chassis front panel module to this header, make sure the wire assignments and the pin assignments are matched correctly.

## 7) F\_AUDIO (Front Panel Audio Header)

The front panel audio header supports Intel High Definition audio (HD) and AC'97 audio. You may connect your chassis front panel audio module to this header. Make sure the wire assignments of the module connector match the pin assignments of the motherboard header. Incorrect connection between the module connector and the motherboard header will make the device unable to work or even damage it.

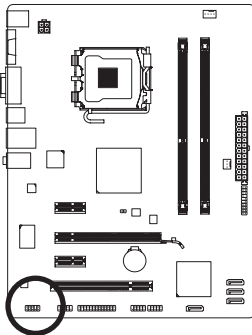

For HD Front Panel Audio:

Pin No.	Definition
1	MIC2_L
2	GND
3	MIC2_R
4	-ACZ_DET
5	LINE2_R
6	GND
7	FAUDIO_JD
8	No Pin
9	LINE2_L
10	GND

For AC'97 Front Panel Audio:

Pin No.	Definition
1	MIC
2	GND
3	MIC Power
4	NC
5	Line Out (R)
6	NC
7	NC
8	No Pin
9	Line Out (L)
10	NC



- The front panel audio header supports HD audio by default.
- Audio signals will be present on both of the front and back panel audio connections simultaneously.
- Some chassis provide a front panel audio module that has separated connectors on each wire instead of a single plug. For information about connecting the front panel audio module that has different wire assignments, please contact the chassis manufacturer.

## 8) F\_USB1/F\_USB2 (USB Headers)

The headers conform to USB 2.0/1.1 specification. Each USB header can provide two USB ports via an optional USB bracket. For purchasing the optional USB bracket, please contact the local dealer.

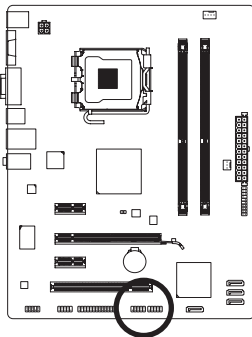

Pin No.	Definition
1	Power (5V)
2	Power (5V)
3	USB DX-
4	USB DY-
5	USB DX+
6	USB DY+
7	GND
8	GND
9	No Pin
10	NC



- Do not plug the IEEE 1394 bracket (2x5-pin) cable into the USB header.
- Prior to installing the USB bracket, be sure to turn off your computer and unplug the power cord from the power outlet to prevent damage to the USB bracket.



## 9) LPT (Parallel Port Header)

The LPT header can provide one parallel port via an optional LPT port cable. For purchasing the optional LPT port cable, please contact the local dealer.

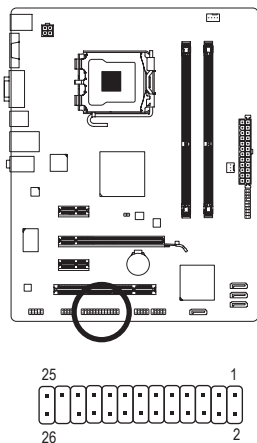

Pin No.	Definition	Pin No.	Definition
1	STB-	14	GND
2	AFD-	15	PD6
3	PD0	16	GND
4	ERR-	17	PD7
5	PD1	18	GND
6	INIT-	19	ACK-
7	PD2	20	GND
8	SLIN-	21	BUSY
9	PD3	22	GND
10	GND	23	PE
11	PD4	24	No Pin
12	GND	25	SLCT
13	PD5	26	GND

## 10) COM (Serial Port Header)

The COM header can provide one serial port via an optional COM port cable. For purchasing the optional COM port cable, please contact the local dealer.

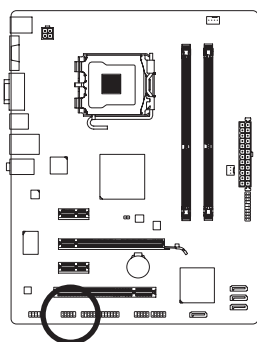

Pin No.	Definition
1	NDCD-
2	NSIN
3	NSOUT
4	NDTR-
5	GND
6	NDSR-
7	NRTS-
8	NCTS-
9	NRI-
10	No Pin

## 11) CLR\_CMOS (Clearing CMOS Jumper)

Use this jumper to clear the CMOS values (e.g. date information and BIOS configurations) and reset the CMOS values to factory defaults. To clear the CMOS values, place a jumper cap on the two pins to temporarily short the two pins or use a metal object like a screwdriver to touch the two pins for a few seconds.

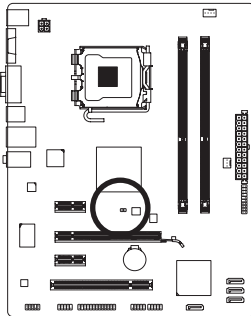

 Open: Normal

 Short: Clear CMOS Values



- Always turn off your computer and unplug the power cord from the power outlet before clearing the CMOS values.
- After clearing the CMOS values and before turning on your computer, be sure to remove the jumper cap from the jumper. Failure to do so may cause damage to the motherboard.
- After system restart, go to BIOS Setup to load factory defaults (select **Load Optimized Defaults**) or manually configure the BIOS settings (refer to Chapter 2, "BIOS Setup," for BIOS configurations).

## 12) BATTERY

The battery provides power to keep the values (such as BIOS configurations, date, and time information) in the CMOS when the computer is turned off. Replace the battery when the battery voltage drops to a low level, or the CMOS values may not be accurate or may be lost.

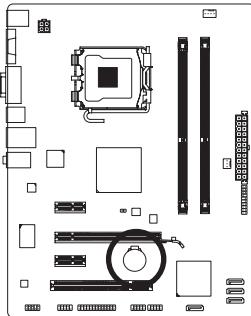

You may clear the CMOS values by removing the battery:

1. Turn off your computer and unplug the power cord.
2. Gently remove the battery from the battery holder and wait for one minute. (Or use a metal object like a screwdriver to touch the positive and negative terminals of the battery holder, making them short for 5 seconds.)
3. Replace the battery.
4. Plug in the power cord and restart your computer.



- Always turn off your computer and unplug the power cord before replacing the battery.
- Replace the battery with an equivalent one. Danger of explosion if the battery is replaced with an incorrect model.
- Contact the place of purchase or local dealer if you are not able to replace the battery by yourself or uncertain about the battery model.
- When installing the battery, note the orientation of the positive side (+) and the negative side (-) of the battery (the positive side should face up).
- Used batteries must be handled in accordance with local environmental regulations.

# Chapter 2 BIOS Setup

To access the BIOS Setup program, press the <Delete> key during the POST when the power is turned on. To see more advanced BIOS Setup menu options, you can press <Ctrl> + <F1> in the main menu of the BIOS Setup program.

To upgrade the BIOS, use either the GIGABYTE Q-Flash or @BIOS utility.

- Q-Flash allows the user to quickly and easily upgrade or back up BIOS without entering the operating system.
- @BIOS is a Windows-based utility that searches and downloads the latest version of BIOS from the Internet and updates the BIOS.



- Because BIOS flashing is potentially risky, if you do not encounter problems using the current version of BIOS, it is recommended that you not flash the BIOS. To flash the BIOS, do it with caution. Inadequate BIOS flashing may result in system malfunction.
- It is recommended that you not alter the default settings (unless you need to) to prevent system instability or other unexpected results. Inadequately altering the settings may result in system's failure to boot. If this occurs, try to clear the CMOS values and reset the board to default values. (Refer to the "Load Optimized Defaults" section in this chapter or introductions of the battery/clearing CMOS jumper in Chapter 1 for how to clear the CMOS values.)

## 2-1 Startup Screen

The following screens may appear when the computer boots.

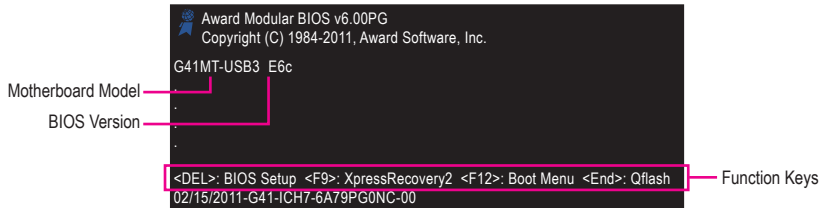

## 2-2 The Main Menu

Once you enter the BIOS Setup program, the Main Menu (as shown below) appears on the screen. Use arrow keys to move among the items and press <Enter> to accept or enter a sub-menu.

**(Sample BIOS Version:GA-G41MT-USB3 E6c)**

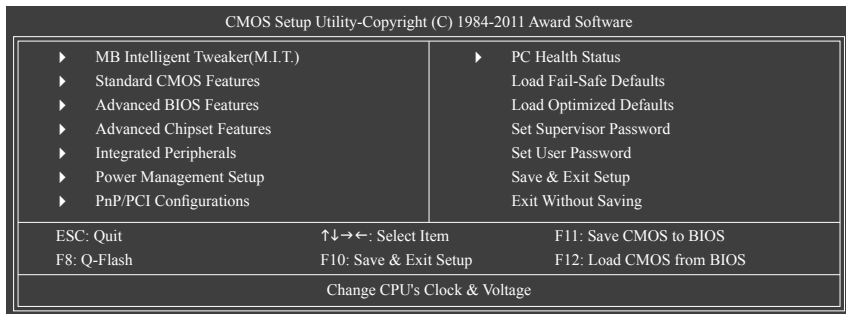



- If you do not find the settings you want in the Main Menu or a submenu, press <Ctrl>+<F1> to access more advanced options.
- When the system is not stable as usual, select the **Load Optimized Defaults** item to set your system to its defaults.
- The BIOS Setup menus described in this chapter are for reference only and may differ by BIOS version.

## ■ The Functions of the <F11> and <F12> keys (For the Main Menu Only)

### ▶ F11: Save CMOS to BIOS

This function allows you to save the current BIOS settings to a profile. You can create up to 8 profiles (Profile 1-8) and name each profile. First enter the profile name (to erase the default profile name, use the SPACE key) and then press <Enter> to complete.

### ▶ F12: Load CMOS from BIOS

If your system becomes unstable and you have loaded the BIOS default settings, you can use this function to load the BIOS settings from a profile created before, without the hassles of reconfiguring the BIOS settings. First select the profile you wish to load, then press <Enter> to complete.

## 2-3 MB Intelligent Tweaker(M.I.T.)

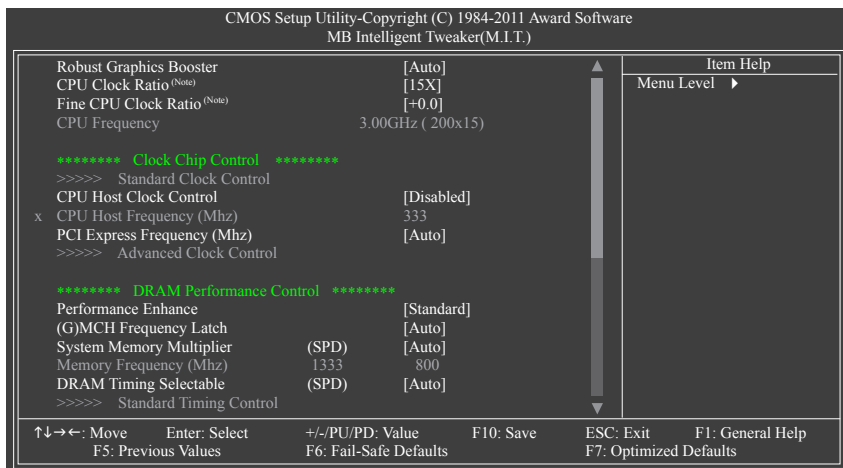

(Note) This item appears only if you install a CPU that supports this feature.

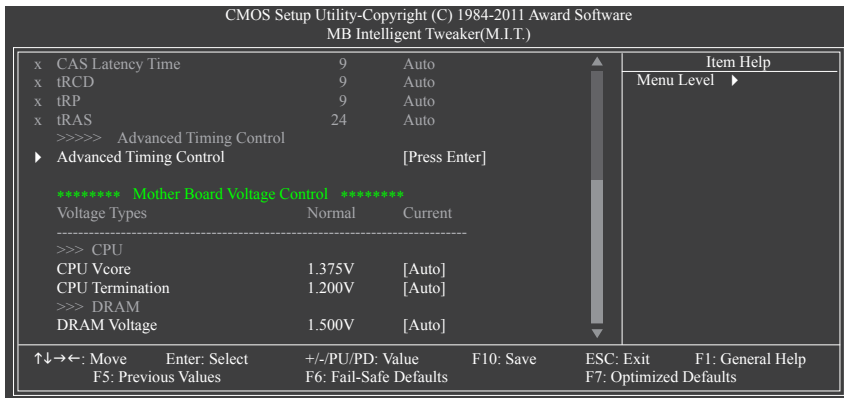

Whether the system will work stably with the overclock/overvoltage settings you made is dependent on your overall system configurations. Incorrectly doing overclock/overvoltage may result in damage to CPU, chipset, or memory and reduce the useful life of these components. This page is for advanced users only and we recommend you not to alter the default settings to prevent system instability or other unexpected results. (Inadequately altering the settings may result in system's failure to boot. If this occurs, clear the CMOS values and reset the board to default values.)

### 🔓 Robust Graphics Booster

Robust Graphics Booster (R.G.B.) helps to enhance the performance of the graphics chip and memory. **Auto** allows the BIOS to automatically set the R.G.B. mode based on system configurations. Options are: Auto (default), Fast, Turbo.

### 🔓 CPU Clock Ratio <sup>(Note)</sup>

Allows you to alter the clock ratio for the installed CPU.  
The item is present only if a CPU with unlocked clock ratio is installed.

### 🔓 Fine CPU Clock Ratio <sup>(Note)</sup>

Allows you to increase clock ratio by 0.5 for the installed CPU.  
The item is present only if a CPU with unlocked clock ratio is installed.

### 🔓 CPU Frequency

Displays the current operating CPU frequency.

### \*\*\*\*\* Clock Chip Control \*\*\*\*\*

#### >>>> Standard Clock Control

### 🔓 CPU Host Clock Control

Enables or disables the control of CPU host clock. **Enabled** will allow the **CPU Host Frequency** item below to be configurable. Note: If your system fails to boot after overclocking, please wait for 20 seconds to allow for automated system reboot, or clear the CMOS values to reset the board to default values. (Default: Disabled)

(Note) This item appears only if you install a CPU that supports this feature.

### ☞ CPU Host Frequency (Mhz)

Allows you to manually set the CPU host frequency. The adjustable range is from 100 MHz to 1200 MHz. This item is configurable only if the **CPU Host Clock Control** option is enabled.

**Important:** It is highly recommended that the CPU frequency be set in accordance with the CPU specifications.

### ☞ PCI Express Frequency (Mhz)

Allows you to manually set the PCIe clock frequency. The adjustable range is from 90 MHz to 150 MHz. **Auto** sets the PCIe clock frequency to standard 100 MHz. (Default: Auto)

## \*\*\*\*\* DRAM Performance Control \*\*\*\*\*

### ☞ Performance Enhance

Allows the system to operate at three different performance levels.

- ▶▶ Standard Lets the system operate at its basic performance level. (Default)
- ▶▶ Turbo Lets the system operate at its good performance level.
- ▶▶ Extreme Lets the system operate at its best performance level.

### ☞ (G)MCH Frequency Latch

Allows you to fix the chipset frequency at system bootup. Options for adjusting memory multiplier below may differ according to the fixed frequency. Options are: Auto (default), 200MHz, 266MHz, 333MHz.

### ☞ System Memory Multiplier (SPD)

Allows you to set the system memory multiplier. Options are dependent on CPU FSB and the **(G)MCH Frequency Latch** settings. **Auto** sets memory multiplier according to memory SPD data. (Default: Auto)

### ☞ Memory Frequency (Mhz)

The first memory frequency value is the normal operating frequency of the memory being used; the second is the memory frequency that is automatically adjusted according to the **CPU Host Frequency (Mhz)** and **System Memory Multiplier** settings.

### ☞ DRAM Timing Selectable (SPD)

**Manual** allows all DRAM timing control items below to be configurable. Options are: Auto (default), Manual.

## >>>>> Standard Timing Control

### ☞ CAS Latency Time

Options are: Auto (default), 4~11.

### ☞ tRCD

Options are: Auto (default), 1~15.

### ☞ tRP

Options are: Auto (default), 1~15.

### ☞ tRAS

Options are: Auto (default), 1~63.

(Note) This item appears only if you install a CPU that supports this feature.

## >>>> Advanced Timing Control

### ⌂ Advanced Timing Control

CMOS Setup Utility-Copyright (C) 1984-2011 Award Software			Advanced Timing Control		
x	tRRD	Auto			Item Help Menu Level ▶▶
x	tWTR	Auto			
x	tWR	Auto			
x	tRFC	Auto			
x	tRTP	Auto			
x	Command Rate (CMD)	Auto			
>>>> Channel A					
▶	Channel A Timing Settings		[Press Enter]		
▶	Channel A Driving Settings		[Press Enter]		
>>>> Channel B					
▶	Channel B Timing Settings		[Press Enter]		
▶	Channel B Driving Settings		[Press Enter]		
↑↓→←: Move		Enter: Select	+/-/PU/PD: Value	F10: Save	ESC: Exit
F5: Previous Values		F6: Fail-Safe Defaults	F7: Optimized Defaults	F1: General Help	

#### ⌂ tRRD

Options are: Auto (default), 1~15.

#### ⌂ tWTR

Options are: Auto (default), 1~31.

#### ⌂ tWR

Options are: Auto (default), 1~31.

#### ⌂ tRFC

Options are: Auto (default), 1~255.

#### ⌂ tRTP

Options are: Auto (default), 1~15.

#### ⌂ Command Rate(CMD)

Options are: Auto (default), 1~3.

## >>>> Channel A/B

### ⌂ Channel A/B Timing Settings

CMOS Setup Utility-Copyright (C) 1984-2011 Award Software			Channel A/B Timing Settings		
x	Static tRead Value	Auto			Item Help Menu Level ▶▶▶
x	tRD Phase0 Adjustment	Auto			
x	tRD Phase1 Adjustment	Auto			
x	tRD Phase2 Adjustment	Auto			
x	tRD Phase3 Adjustment	Auto			
x	Trd2rd(Different Rank)	Auto			
x	Twr2wr(Different Rank)	Auto			
x	Twr2rd(Different Rank)	Auto			
x	Trd2wr(Same/Diff Rank)	Auto			
x	DIMM1 Clock Skew Control	Auto			
x	DIMM2 Clock Skew Control	Auto			
x	DDR Write Leveling	Auto			
x	DDR Write Training	Auto			
↑↓→←: Move		Enter: Select	+/-/PU/PD: Value	F10: Save	ESC: Exit
F5: Previous Values		F6: Fail-Safe Defaults	F7: Optimized Defaults	F1: General Help	

☞ **Static tRead Value**

Options are: Auto (default), 1~15.

☞ **tRD Phase0 Adjustment**

Options are: Auto (default), 0-Normal, 1-Advanced.

☞ **tRD Phase1 Adjustment**

Options are: Auto (default), 0-Normal, 1-Advanced.

☞ **tRD Phase2 Adjustment**

Options are: Auto (default), 0-Normal, 1-Advanced.

☞ **tRD Phase3 Adjustment**

Options are: Auto (default), 0-Normal, 1-Advanced.

☞ **Trd2rd(Different Rank)**

Options are: Auto (default), 1~15.

☞ **Twr2wr(Different Rank)**

Options are: Auto (default), 1~15.

☞ **Twr2rd(Different Rank)**

Options are: Auto (default), 1~15.

☞ **Trd2wr(Same/Diff Rank)**

Options are: Auto (default), 1~15.

☞ **DIMM1 Clock Skew Control**

Options are: Auto (default), +800ps~-700ps.

☞ **DIMM2 Clock Skew Control**

Options are: Auto (default), +800ps~-700ps.

☞ **DDR Write Leveling**

Allows you to determine whether to fine-tune memory parameters to enhance memory compatibility.

- ▶▶ Auto Lets the BIOS decide whether to enable this function. (Default)
- ▶▶ Enabled Enables this function to enhance memory compatibility.
- ▶▶ Disabled Disables this function.

☞ **DDR Write Training**

Allows you to determine whether to fine-tune memory parameters to enhance memory compatibility.

- ▶▶ Auto Lets the BIOS decide whether to enable this function. (Default)
- ▶▶ Enabled Enables this function to enhance memory compatibility.
- ▶▶ Disabled Disables this function.



## ☞ Channel A/B Driving Settings

CMOS Setup Utility-Copyright (C) 1984-2011 Award Software		
Channel A/B Driving Settings		
x Driving Strength Profile	Auto	Item Help Menu Level ▶▶▶
x Data Driving Pull-Up Level	Auto	
x Cmd Driving Pull-Up Level	Auto	
x Ctrl Driving Pull-Up Level	Auto	
x Clk Driving Pull-Up Level	Auto	
x Data Driving Pull-Down Lev	Auto	
x Cmd Driving Pull-Down Lev	Auto	
x Ctrl Driving Pull-Down Lev	Auto	
x Clk Driving Pull-Down Lev	Auto	
↑↓→←: Move	Enter: Select	+/-/PU/PD: Value
F5: Previous Values		F6: Fail-Safe Defaults
		F10: Save
		ESC: Exit
		F1: General Help
		F7: Optimized Defaults

### ☞ Driving Strength Profile

Options are: Auto (default).

### ☞ Data Driving Pull-Up Level

Options are: Auto (default), +8~-7.

### ☞ Cmd Driving Pull-Up Level

Options are: Auto (default), +8~-7.

### ☞ Ctrl Driving Pull-Up Level

Options are: Auto (default), +8~-7.

### ☞ Clk Driving Pull-Up Level

Options are: Auto (default), +8~-7.

### ☞ Data Driving Pull-Down Level

Options are: Auto (default), +8~-7.

### ☞ Cmd Driving Pull-Down Level

Options are: Auto (default), +8~-7.

### ☞ Ctrl Driving Pull-Down Level

Options are: Auto (default), +8~-7.

### ☞ Clk Driving Pull-Down Level

Options are: Auto (default), +8~-7.

## \*\*\*\*\* Mother Board Voltage Control \*\*\*\*\*

### >>> CPU

#### ☞ CPU Vcore

The default is Auto.

#### ☞ CPU Termination

The default is Auto.

### >>> DRAM

#### ☞ DRAM Voltage

The default is Auto.

## 2-4 Standard CMOS Features

CMOS Setup Utility-Copyright (C) 1984-2011 Award Software		Item Help
Standard CMOS Features		Menu Level ▶
Date (mm:dd:yy)	Thu, Feb 17 2011	
Time (hh:mm:ss)	22:31:24	
▶ IDE Channel 0 Master	[None]	
▶ IDE Channel 0 Slave	[None]	
▶ IDE Channel 1 Master	[None]	
▶ IDE Channel 1 Slave	[None]	
Halt On	[All, But Keyboard]	
Base Memory	640K	
Extended Memory	988M	
Total Memory	990M	

↑↓→←: Move    Enter: Select    +/-/PU/PD: Value    F10: Save    ESC: Exit    F1: General Help  
                   F5: Previous Values    F6: Fail-Safe Defaults    F7: Optimized Defaults

### ☞ Date (mm:dd:yy)

Sets the system date.

### ☞ Time (hh:mm:ss)

Sets the system time.

### ☞ IDE Channel 0, 1 Master/Slave

#### ▶▶ IDE Channel 0/1 Master/Slave, Extended IDE Drive

Configure your SATA devices by using one of the three methods below:

- Auto      Lets the BIOS automatically detect SATA devices during the POST. (Default)
- None      If no SATA devices are used, set this item to **None** so the system will skip the detection of the device during the POST for faster system startup.
- Manual    Allows you to manually enter the specifications of the hard drive when the hard drive access mode is set to **CHS**. (For **IDE Channel 0 Master/Slave** only.)

#### ▶▶ Access Mode    Sets the hard drive access mode. (Default: Auto)

The following fields display your hard drive specifications. If you wish to enter the parameters manually, refer to the information on the hard drive.

- ▶▶ Capacity      Approximate capacity of the currently installed hard drive.
- ▶▶ Cylinder        Number of cylinders.
- ▶▶ Head            Number of heads.
- ▶▶ Precomp        Write precompensation cylinder.
- ▶▶ Landing Zone    Landing zone.
- ▶▶ Sector          Number of sectors.

### ☞ Halt On

Allows you to determine whether the system will stop for an error during the POST.

Options are: "All Errors," "No Errors," "All, But Keyboard" (default).

### ☞ Memory

These fields are read-only and are determined by the BIOS POST.

## 2-5 Advanced BIOS Features

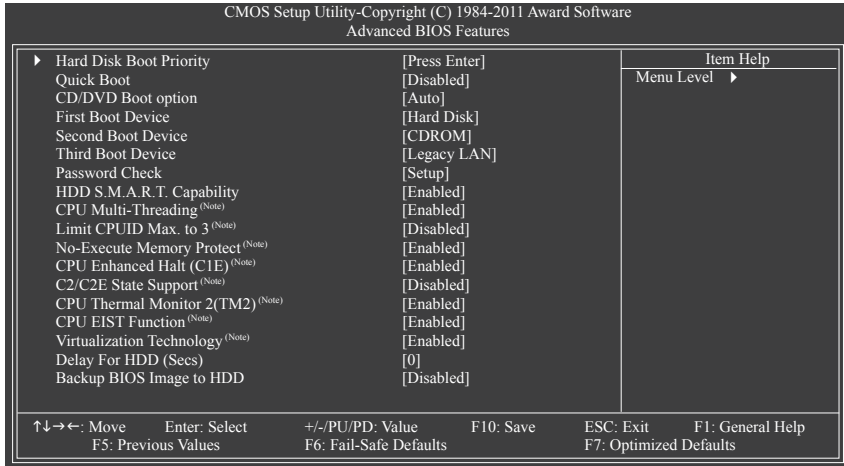

### ☞ Hard Disk Boot Priority

Specifies the sequence of loading the operating system from the installed hard drives.

### ☞ Quick Boot

Enables or disables the quick boot function to speed up the system boot-up process to shorten the waiting time for entering the operating system and to deliver greater efficiency for daily use. (Default: Disabled)

### ☞ CD/DVD Boot Option

Set this item to **EFI** if you want to install the operating system to a hard drive larger than 2.2 TB. Make sure the operating system to be installed supports booting from a GPT partition, such as Windows 7 64-bit and Windows Server 2003 64-bit. **Auto** lets the BIOS automatically configure this setting depending on the hard drive you install. (Default: Auto)

### ☞ First/Second/Third Boot Device

Specifies the boot order from the available devices.

### ☞ Password Check

Specifies whether a password is required every time the system boots, or only when you enter BIOS Setup. After configuring this item, set the password(s) under the **Set Supervisor/User Password** item in the BIOS Main Menu.

- ▶▶ Setup      A password is only required for entering the BIOS Setup program. (Default)
- ▶▶ System     A password is required for booting the system and for entering the BIOS Setup program.

### ☞ HDD S.M.A.R.T. Capability

Enables or disables the S.M.A.R.T. (Self Monitoring and Reporting Technology) capability of your hard drive. This feature allows your system to report read/write errors of the hard drive and to issue warnings when a third party hardware monitor utility is installed. (Default: Enabled)

(Note) This item is present only if you install a CPU that supports this feature. For more information about Intel CPUs' unique features, please visit Intel's website.

### ☞ **CPU Multi-Threading** <sup>(Note)</sup>

Allows you to determine whether to enable all CPU cores and multi-threading function when using an Intel CPU that supports multi-core technology. This feature only works for operating systems that support multi-processor mode.

- ▶▶ Enabled Enables all CPU cores and multi-threading capability. (Default)
- ▶▶ Disabled Enables only one CPU core.

### ☞ **Limit CPUID Max. to 3** <sup>(Note)</sup>

Allows you to determine whether to limit CPUID maximum value. Set this item to **Disabled** for Windows XP operating system; set this item to **Enabled** for legacy operating system such as Windows NT4.0. (Default: Disabled)

### ☞ **No-Execute Memory Protect** <sup>(Note)</sup>

Enables or disables Intel Execute Disable Bit function. This function may enhance protection for the computer, reducing exposure to viruses and malicious buffer overflow attacks when working with its supporting software and system. (Default: Enabled)

### ☞ **CPU Enhanced Halt (C1E)** <sup>(Note)</sup>

Enables or disables Intel CPU Enhanced Halt (C1E) function, a CPU power-saving function in system halt state. When enabled, the CPU core frequency and voltage will be reduced during system halt state to decrease power consumption. (Default: Enabled)

### ☞ **C2/C2E State Support** <sup>(Note)</sup>

Allows you to determine whether to let the CPU enter C2/C2E mode in system halt state. When enabled, the CPU core frequency and voltage will be reduced during system halt state to decrease power consumption. (Default: Disabled)

### ☞ **CPU Thermal Monitor 2 (TM2)** <sup>(Note)</sup>

Enables or disables Intel CPU Thermal Monitor (TM2) function, a CPU overheating protection function. When enabled, the CPU core frequency and voltage will be reduced when the CPU is overheated. (Default: Enabled)

### ☞ **CPU EIST Function** <sup>(Note)</sup>

Enables or disables Enhanced Intel SpeedStep Technology (EIST). Depending on CPU loading, Intel EIST technology can dynamically and effectively lower the CPU voltage and core frequency to decrease average power consumption and heat production. (Default: Enabled)

### ☞ **Virtualization Technology** <sup>(Note)</sup>

Enables or disables Intel Virtualization Technology. Virtualization enhanced by Intel Virtualization Technology will allow a platform to run multiple operating systems and applications in independent partitions. With virtualization, one computer system can function as multiple virtual systems. (Default: Enabled)

### ☞ **Delay For HDD (Secs)**

Allows you to set a delay time for the BIOS to initialize the hard drive as the system boots up. The adjustable range is from 0 to 15 seconds. (Default: 0)

### ☞ **Backup BIOS Image to HDD**

Allows the system to copy the BIOS image file to the hard drive. If the system BIOS is corrupted, it will be recovered from this image file. (Default: Disabled)

(Note) This item is present only if you install a CPU that supports this feature. For more information about Intel CPUs' unique features, please visit Intel's website.

## 2-6 Advanced Chipset Features

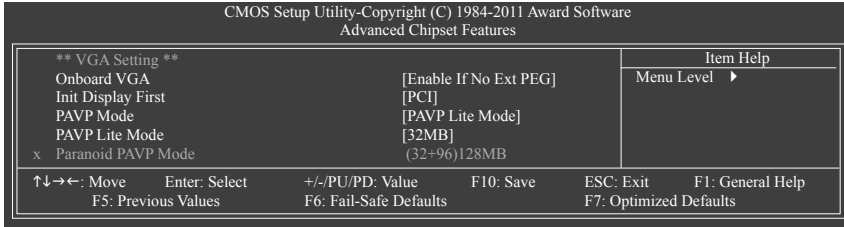

### Onboard VGA

Enables or disables the onboard graphics function.

▶▶ Enable If No Ext PEG

Activates the onboard graphics only if no PCI Express graphics card is installed. (Default)

▶▶ Always Enable

Always activates the onboard graphics, whether or not a PCI Express card is installed. If you wish to set up a dual view configuration, set this item to **Always Enable**.

### Init Display First

Specifies the first initiation of the monitor display from the installed PCI graphics card, PCI Express graphics card or the onboard graphics.

▶▶ PCI                Sets the PCI graphics card as the first display. (Default)

▶▶ Onboard           Sets the onboard graphics as the first display.

▶▶ PEG                Sets the PCI Express graphics card as the first display.

### PAVP Mode

Enables or disables PAVP mode. Enable this function if you wish to playback HDCP contents. PAVP mode can support increased content protection and robustness requirements for premium content playback (e.g. Blu-ray disc).

▶▶ Disabled           Disables this function.

▶▶ PAVP Lite Mode Specifies the buffer memory size for the encryption of compressed video. (Default)

▶▶ Paranoid PAVP Reserves 96 MB of system memory during boot. This memory is not seen by the operating system and not available to any user application. Aero (DWM) in Windows Vista will always be turned off in this mode.

### PAVP Lite Mode

This item is configurable only if the **PAVP Mode** option is set to **PAVP Lite Mode**.

Options are: 32MB (default), 48MB, 64MB, 128MB and 256MB.

### Paranoid PAVP Mode

This item is configurable only if the **PAVP Mode** option is set to **Paranoid PAVP**.

Options are: (32+96)128MB (default), (48+96) Round to 160MB, (64+96)160MB, (128+96)224MB and (256+96)352MB.

The table below shows the supported features of the PAVP Lite and Paranoid PAVP modes.

Feature	PAVP Lite	Paranoid PAVP
Compressed video buffer is encrypted	Yes	Yes
Hardware 128-bit AES decryption	Yes	Yes
Protected memory (96 MB reserved during boot)	No	Yes

## 2-7 Integrated Peripherals

CMOS Setup Utility-Copyright (C) 1984-2011 Award Software		
Integrated Peripherals		
Azalia Codec	[Auto]	Item Help
Onboard H/W LAN	[Enabled]	Menu Level ▶
▶ SMART LAN	[Press Enter]	
Onboard LAN Boot ROM	[Disabled]	
Onboard USB3.0 Controller <sup>①</sup>	[Enabled]	
Onboard Serial Port 1	[3F8/IRQ4]	
Onboard Parallel Port	[378/IRQ7]	
Parallel Port Mode	[SPP]	
USB 1.0 Controller	[Enabled]	
USB 2.0 Controller	[Enabled]	
USB Keyboard Support	[Disabled]	
USB Mouse Support	[Disabled]	
USB Storage Function	[Enabled]	
↑↓→←: Move    Enter: Select    +/-/PU/PD: Value    F10: Save    ESC: Exit    F1: General Help F5: Previous Values    F6: Fail-Safe Defaults    F7: Optimized Defaults		

### ☞ Azalia Codec

Enables or disables the onboard audio function. (Default: Auto)

If you wish to install a 3rd party add-in audio card instead of using the onboard audio, set this item to **Disabled**.

### ☞ Onboard H/W LAN

Enables or disables the onboard LAN function. (Default: Enabled)

If you wish to install a 3rd party add-in network card instead of using the onboard LAN, set this item to **Disabled**.

### ☞ SMART LAN (LAN Cable Diagnostic Function)

CMOS Setup Utility-Copyright (C) 1984-2011 Award Software		
SMART LAN		
Start detecting at Port.....		Item Help
Part1-2 Status = Open / Length = 0m		Menu Level ▶▶
Part3-6 Status = Open / Length = 0m		
Part4-5 Status = Open / Length = 0m		
Part7-8 Status = Open / Length = 0m		
↑↓→←: Move    Enter: Select    +/-/PU/PD: Value    F10: Save    ESC: Exit    F1: General Help F5: Previous Values    F6: Fail-Safe Defaults    F7: Optimized Defaults		

This motherboard incorporates cable diagnostic feature designed to detect the status of the attached LAN cable. This feature will detect cabling issue and report the approximate distance to the fault or short

### ☞ Onboard LAN Boot ROM

Allows you to decide whether to activate the boot ROM integrated with the onboard LAN chip. (Default: Disabled)

### ☞ Onboards USB3.0 Controller (Etron EJ168 USB Controller, USB 3.0/2.0 ports on the back panel)<sup>①</sup>

Enables or disables the Etron EJ168 USB controller. (Default: Enabled)

### ☞ Onboard Serial Port 1

Enables or disables the first serial port and specifies its base I/O address and corresponding interrupt. Options are: Auto, 3F8/IRQ4 (default), 2F8/IRQ3, 3E8/IRQ4, 2E8/IRQ3, Disabled.

<sup>①</sup> Only for GA-G41MT-USB3.

### Onboard Parallel Port

Enables or disables the onboard parallel port (LPT) and specifies its base I/O address and corresponding interrupt. Options are: 378/IRQ7 (default), 278/IRQ5, 3BC/IRQ7, Disabled.

### Parallel Port Mode

Selects an operating mode for the onboard parallel (LPT) port. Options are: SPP (Standard Parallel Port) (default), EPP (Enhanced Parallel Port), ECP (Extended Capabilities Port), ECP+EPP.

### USB 1.0 Controller

Enables or disables the integrated USB 1.0 controller. (Default: Enabled)

**Disabled** will turn off all of the USB functionalities below.

### USB 2.0 Controller

Enables or disables the integrated USB 2.0 controller. (Default: Enabled)

### USB Keyboard Function

Allows USB keyboard to be used in MS-DOS. (Default: Disabled)

### USB Mouse Function

Allows USB mouse to be used in MS-DOS. (Default: Disabled)

### USB Storage Function

Determines whether to detect USB storage devices, including USB flash drives and USB hard drives during the POST. (Default: Enabled)

## 2-8 Power Management Setup

CMOS Setup Utility-Copyright (C) 1984-2011 Award Software		Item Help
Power Management Setup		Menu Level ▶
ACPI Suspend Type	[S3(STR)]	
Soft-Off by PWR-BTTN	[Instant-Off]	
PME Event Wake Up	[Enabled]	
Power On by Ring	[Enabled]	
Resume by Alarm	[Disabled]	
x Date (of Month) Alarm	Everyday	
x Time (hh:mm:ss) Alarm	0 : 0 : 0	
HPET Support <sup>(Note)</sup>	[Enabled]	
HPET Mode <sup>(Note)</sup>	[32-bit mode]	
Power On By Mouse	[Disabled]	
Power On By Keyboard	[Disabled]	
x KB Power ON Password	Enter	
AC Back Function	[Soft-Off]	
ErP Support	[Disabled]	

↑↓→←: Move    Enter: Select    +/-/PU/PD: Value    F10: Save    ESC: Exit    F1: General Help  
F5: Previous Values    F6: Fail-Safe Defaults    F7: Optimized Defaults

### ACPI Suspend Type

Specifies the ACPI sleep state when the system enters suspend.

- ▶▶ S1(POS)    Enables the system to enter the ACPI S1 (Power on Suspend) sleep state.  
In S1 sleep state, the system appears suspended and stays in a low power mode.  
The system can be resumed at any time.
- ▶▶ S3(STR)    Enables the system to enter the ACPI S3 (Suspend to RAM) sleep state (default).  
In S3 sleep state, the system appears to be off and consumes less power than in the S1 state. When signaled by a wake-up device or event, the system resumes to its working state exactly where it was left off.

(Note) Supported on Windows 7/Vista operating system only.

### ☞ **Soft-Off by PWR-BTTN**

Configures the way to turn off the computer in MS-DOS mode using the power button.

- ▶▶ **Instant-Off** Press the power button and then the system will be turned off instantly. (Default)
- ▶▶ **Delay 4 Sec.** Press and hold the power button for 4 seconds to turn off the system. If the power button is pressed for less than 4 seconds, the system will enter suspend mode.

### ☞ **PME Event Wake Up**

Allows the system to be awakened from an ACPI sleep state by a wake-up signal from a PCI or PCIe device. Note: To use this function, you need an ATX power supply providing at least 1A on the +5VSB lead. (Default: Enabled)

### ☞ **Power On by Ring**

Allows the system to be awakened from an ACPI sleep state by a wake-up signal from a modem that supports wake-up function. (Default: Enabled)

### ☞ **Resume by Alarm**

Determines whether to power on the system at a desired time. (Default: Disabled)

If enabled, set the date and time as following:

- ▶▶ **Date (of Month) Alarm:** Turn on the system at a specific time on each day or on a specific day in a month.
- ▶▶ **Time (hh: mm: ss) Alarm:** Set the time at which the system will be powered on automatically.

Note: When using this function, avoid inadequate shutdown from the operating system or removal of the AC power, or the settings may not be effective.

### ☞ **HPET Support** <sup>(Note)</sup>

Enables or disables High Precision Event Timer (HPET) for Windows 7/Vista operating system. (Default: Enabled)

### ☞ **HPET Mode** <sup>(Note)</sup>

Allows you to select the HPET mode for your Windows 7/Vista operating system. This item is configurable only if the **HPET Support** is set to **Enabled**. (Default: 32-bit mode)

### ☞ **Power On By Mouse**

Allows the system to be turned on by a PS/2 mouse wake-up event. (Default: Disabled)

Note: To use this function, you need an ATX power supply providing at least 1A on the +5VSB lead.

### ☞ **Power On By Keyboard**

Allows the system to be turned on by a PS/2 keyboard wake-up event. (Default: Disabled)

Note: you need an ATX power supply providing at least 1A on the +5VSB lead.

- ▶▶ **Password** Set a password with 1~5 characters to turn on the system.
- ▶▶ **Keyboard 98** Press POWER button on the Windows 98 keyboard to turn on the system.

### ☞ **KB Power ON Password**

Set the password when **Power On by Keyboard** is set to **Password**. Press <Enter> on this item and set a password with up to 5 characters and then press <Enter> to accept. To turn on the system, enter the password and press <Enter>.

Note: To cancel the password, press <Enter> on this item. When prompted for the password, press <Enter> again without entering the password to clear the password settings.

(Note) Supported on Windows 7/Vista operating system only.



## AC Back Function

Determines the state of the system after the return of power from an AC power loss.

- ▶▶ Soft-Off The system stays off upon the return of the AC power. (Default)
- ▶▶ Full-On The system is turned on upon the return of the AC power.
- ▶▶ Memory The system returns to its last known awake state upon the return of the AC power.

## ErP Support

Determines whether to let the system consume less than 1W power in S5 (shutdown) state. (Default: Disabled) Note: When this item is set to Enabled, the following four functions will become unavailable: PME event wake up, power on by mouse, power on by keyboard, and wake on LAN.

## 2-9 PnP/PCI Configurations

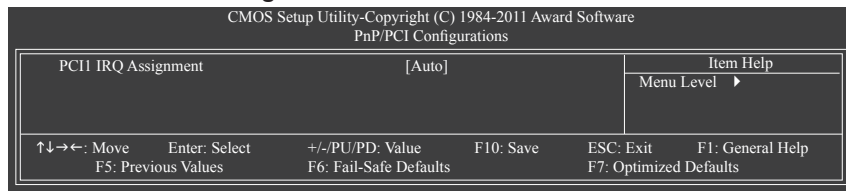

### PCI1 IRQ Assignment

- ▶▶ Auto BIOS auto-assigns IRQ to the first PCI slot. (Default)
- ▶▶ 3,4,5,7,9,10,11,12,14,15 Assigns IRQ 3,4,5,7,9,10,11,12,14,15 to the first PCI slot.

## 2-10 PC Health Status

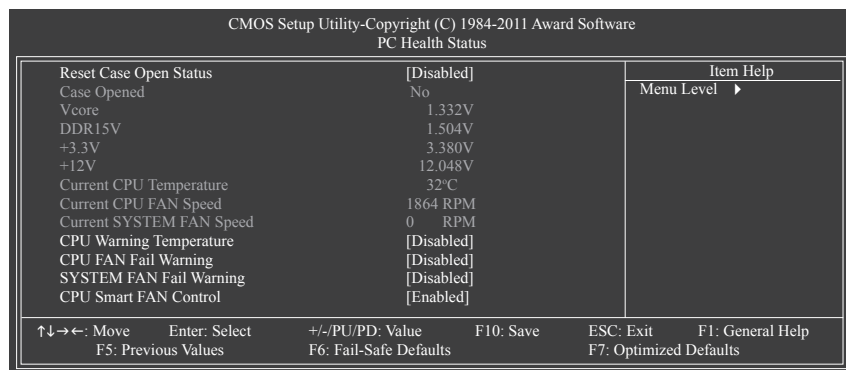

### Reset Case Open Status

Keeps or clears the record of previous chassis intrusion status. **Enabled** clears the record of previous chassis intrusion status and the **Case Opened** field will show "No" at next boot. (Default: Disabled)

### Case Opened

Displays the detection status of the chassis intrusion detection device attached to the motherboard CI header. If the system chassis cover is removed, this field will show "Yes", otherwise it will show "No". To clear the chassis intrusion status record, set **Reset Case Open Status** to **Enabled**, save the settings to the CMOS, and then restart your system.

☞ **Current Voltage(V) Vcore/DDR15V/+3.3V/+12V**

Displays the current system voltages.

☞ **Current CPU Temperature**

Displays current CPU temperature.

☞ **Current CPU/SYSTEM FAN Speed (RPM)**

Displays current CPU/system fan speed.

☞ **CPU Warning Temperature**

Sets the warning threshold for CPU temperature. When CPU temperature exceeds the threshold, BIOS will emit warning sound. Options are: Disabled (default), 60°C/140°F, 70°C/158°F, 80°C/176°F, 90°C/194°F.

☞ **CPU/SYSTEM FAN Fail Warning**

Allows the system to emit warning sound if the CPU/system fan is not connected or fails. Check the fan condition or fan connection when this occurs. (Default: Disabled)

☞ **CPU Smart FAN Control**

Enables or disables the CPU fan speed control function. **Enabled** allows the CPU fan to run at different speed according to the CPU temperature. You can adjust the fan speed with EasyTune based on system requirements. If disabled, CPU fan runs at full speed. (Default: Enabled)

## 2-11 Load Fail-Safe Defaults

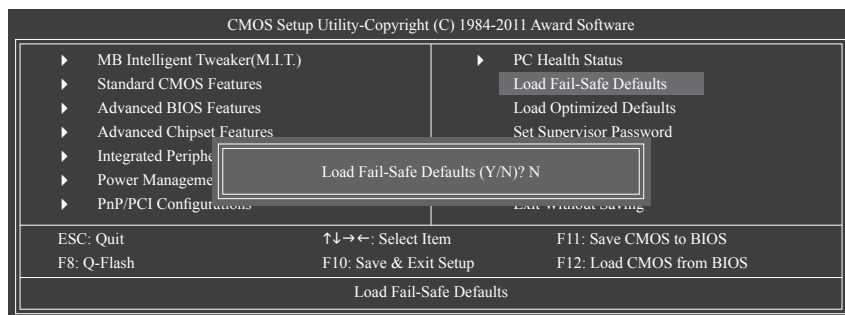

Press <Enter> on this item and then press the <Y> key to load the safest BIOS default settings.

In case system instability occurs, you may try to load Fail-Safe defaults, which are the safest and most stable BIOS settings for the motherboard.

## 2-12 Load Optimized Defaults

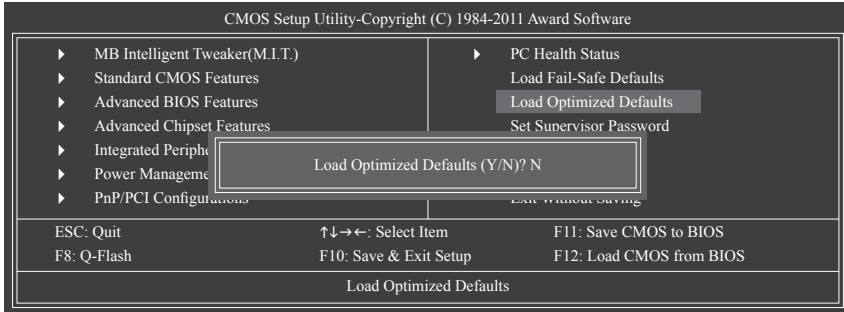

Press <Enter> on this item and then press the <Y> key to load the optimal BIOS default settings.

The BIOS defaults settings help the system to operate in optimum state. Always load the Optimized defaults after updating the BIOS or after clearing the CMOS values.

## 2-13 Set Supervisor/User Password

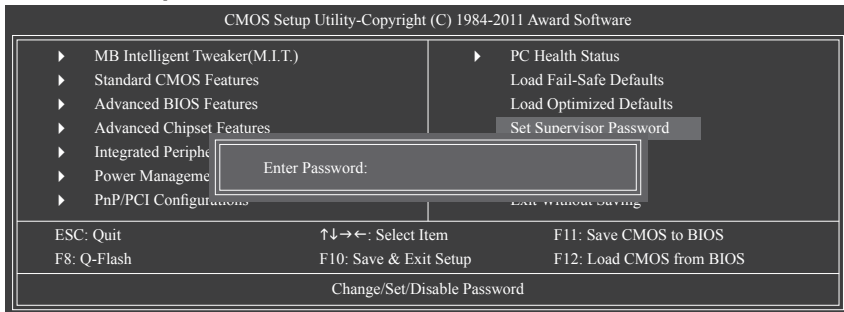

Press <Enter> on this item and type the password with up to 8 characters and then press <Enter>. You will be requested to confirm the password. Type the password again and press <Enter>.

The BIOS Setup program allows you to specify two separate passwords:

### ☞ Supervisor Password

When a system password is set and the **Password Check** item in **Advanced BIOS Features** is set to **Setup**, you must enter the supervisor password for entering BIOS Setup and making BIOS changes.

When the **Password Check** item is set to **System**, you must enter the supervisor password (or user password) at system startup and when entering BIOS Setup.

### ☞ User Password

When the **Password Check** item is set to **System**, you must enter the supervisor password (or user password) at system startup to continue system boot. In BIOS Setup, you must enter the supervisor password if you wish to make changes to BIOS settings. The user password only allows you to view the BIOS settings but not to make changes.

To clear the password, press <Enter> on the password item and when requested for the password, press <Enter> again. The message "PASSWORD DISABLED" will appear, indicating the password has been cancelled.

## 2-14 Save & Exit Setup

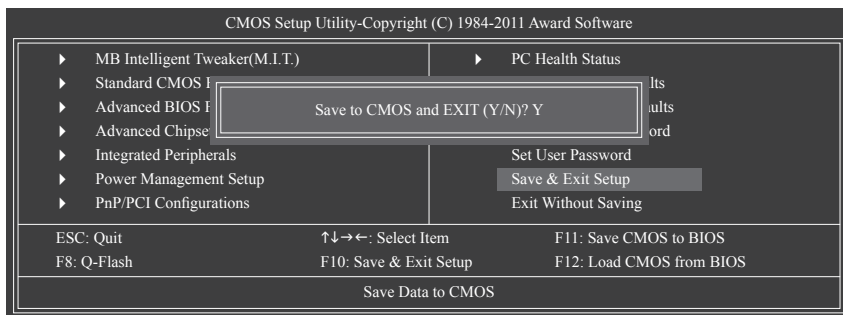

Press <Enter> on this item and press the <Y> key. This saves the changes to the CMOS and exits the BIOS Setup program. Press <N> or <Esc> to return to the BIOS Setup Main Menu.

## 2-15 Exit Without Saving

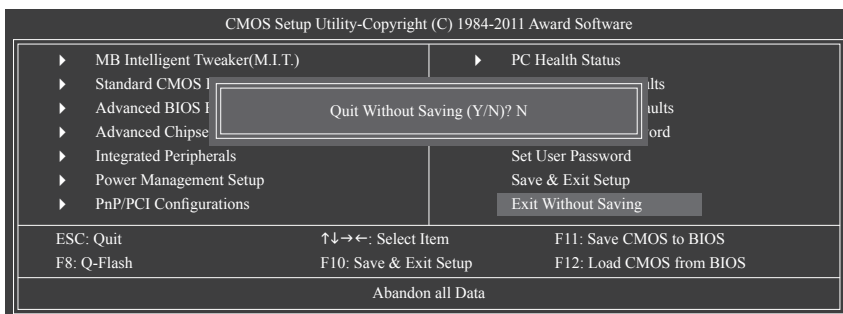

Press <Enter> on this item and press the <Y> key. This exits the BIOS Setup without saving the changes made in BIOS Setup to the CMOS. Press <N> or <Esc> to return to the BIOS Setup Main Menu.

## Chapter 3 Drivers Installation



- Before installing the drivers, first install the operating system.
- After installing the operating system, insert the motherboard driver disk into your optical drive. The driver Autorun screen is automatically displayed which looks like that shown in the screen shot below. (If the driver Autorun screen does not appear automatically, go to My Computer, double-click the optical drive and execute the **Run.exe** program.)

### 3-1 Installing Chipset Drivers

After inserting the driver disk, "Xpress Install" will automatically scan your system and then list all the drivers that are recommended to install. You can click the **Install All** button and "Xpress Install" will install all the recommended drivers. Or click **Install Single Items** to manually select the drivers you wish to install.

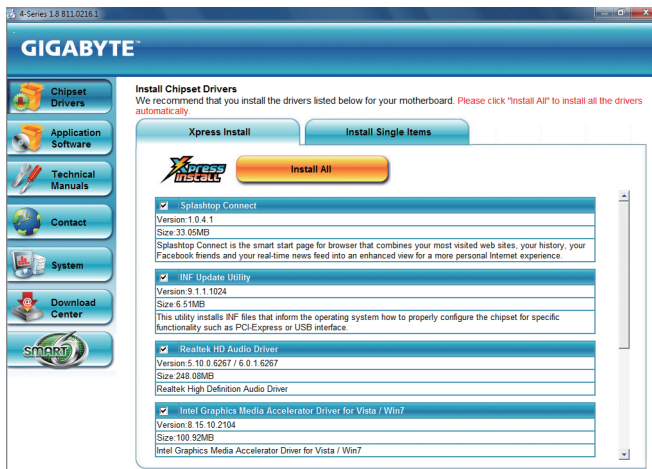







## Contact Us

---

### GIGA-BYTE TECHNOLOGY CO., LTD.

Address: No.6, Bao Chiang Road, Hsin-Tien Dist., New Taipei City 231, Taiwan

TEL: +886-2-8912-4000, FAX: +886-2-8912-4003

Tech. and Non-Tech. Support (Sales/Marketing) : <http://ggts.gigabyte.com.tw>

WEB address (English): <http://www.gigabyte.com>

WEB address (Chinese): <http://www.gigabyte.tw>

---

You may go to the GIGABYTE website, select your language in the language list on the top right corner of the website.

- **GIGABYTE Global Service System**



To submit a technical or non-technical (Sales/Marketing) question, please link to:

<http://ggts.gigabyte.com.tw>

Then select your language to enter the system.