

Advancing the Science of Sealing™

Garlock Metallic Gasket Technical Manual



Garlock
SEALING TECHNOLOGIES®

an EnPro Industries company

Garlock Metallic Gaskets

Garlock Metallic Gaskets, a division of Garlock Sealing Technologies, manufactures spiral wound, metal clad, solid metal and metal core gaskets at its facility in Houston, Texas. This facility is registered to ISO-9001.

In recent years, Garlock Metallic Gaskets has introduced some of the industry's most innovative production methods and products. For example, the CONTROLLED DENSITY™ process for spiral wound gaskets ensures a high tightness level at a lower bolt stress. The TANDEM SEAL™ combines chemical resistance and fire safety in a single gasket. The Garlock EDGE® gasket seals at lower bolt stress while virtually eliminating the problem of inward buckling. Garlock Metallic Gaskets is also known for excellence in material and product quality as well as its outstanding customer service.

This catalog is provided for customer information and convenience. However, Garlock Metallic Gaskets applications engineers and customer service personnel are also on hand to assist you with your application requirements and technical questions. Please give us a call at 800-972-7638. We are here to serve you.



CONTROLLED DENSITY™, TANDEM SEAL™, STABL-LOCK™ and G.E.T.™ are trademarks of Garlock Inc.
EDGE®, GRAPHONIC®, FLEXSEAL® and TEPHONIC® are registered trademarks of Garlock Inc.

Contents

Metallic Gasket Styles

Gasket Selection	D-2
Spiral Wound Gaskets.....	D-3
Performance Metrics.....	D-4
The Garlock EDGE® Gasket	D-5
HEAT SHIELD™ Gasket.....	D-6
TANDEM SEAL™ Gasket.....	D-7
FLEXSEAL® Family.....	D-8
RW, RWI, SW (For ASME flanges)	D-8
MC, MCR (For boiler manholes)	D-9
HH (For boiler handholes).....	D-10
RW-RJ, RWI-RJ (For ring joint flanges)	D-11
LMF (For large male/female flanges)	D-12
LTG (For large tongue and groove flanges) .	D-12
STG (For small tongue and groove flanges)	D-12
Exchanger and Vessel Gaskets.....	D-13
Heat Exchanger Gasket Configurations.....	D-13
600 Series Metal-Clad Gaskets	D-14
GRAPHONIC® Metallic Gasket	D-16
Garlock Kammprofile Gasket	D-17

Engineering Data

Factors Affecting Gasket Performance	D-18
Material Temperature Limits.....	D-19
Thickness and Tolerances	D-19
Flange Types	D-20
Recommended Flange Finish	D-21
Maximum Bore.....	D-22
Gasket Dimensions.....	D-23
Effective Gasket Seating Width	D-32
Gasket Factors M and Y	D-33
Calculating Load Requirements.....	D-34
Torque Tables.....	D-35
Flange and Bolt Dimensions	D-41
Gasket Installation	D-42
Troubleshooting Leaking Joints	D-43
Ordering Guide	D-44
Application Data Form	D-45

Gasket Selection

Spiral Wound Gaskets

One of the best all-around seals, the spiral wound gasket offers a low-cost solution that has the ability to handle temperature and pressure fluctuations. Multiple plies of metal and filler in the spiral create a barrier that reduces the possibility of leaks.

Other Metal Gaskets

Garlock manufactures a wide variety of double-jacketed, spiral-wound, metal-clad and solid metal gaskets for heat exchanger and coker applications. GRAPHONIC® and Kamprofile gaskets are also available in heat exchanger configurations.

Temperature and Chemical Considerations

Be certain that the gasket you order is as resistant as possible to the media and temperature involved. Check the chemical compatibility of the metal as well as the filler material for the media to be sealed. As a general rule, the metal used in either the spiral winding or double-jacketed gasket should be similar to the flange material.

The compressibility of flexible graphite makes it an excellent filler material for metallic gaskets. Flexible graphite may be used in services with temperatures up to 950°F (485°C), though it should not be used with strong oxidizers such as nitric or sulfuric acid.

PTFE filler material provides excellent chemical resistance at temperatures below 500°F (260°C). In accordance with ASME B16.20, an inner ring is required when using conventional PTFE filler materials, in order to protect the winding from radial buckling.

See page D-19 for the temperature limits of common metals and filler materials.

Operating Pressure

Operating pressures have a direct effect on the construction and selection of metallic gaskets. Higher pressures raise the potential for gasket blowout, while lower pressure applications require a gasket design that seals under lower bolt loads.

Garlock gaskets suitable for high pressure include:

- Kamprofile gaskets
- Spiral wound gaskets with inner ring
- Solid metal gaskets

Low pressure gaskets include:

- GRAPHONIC® gaskets
- Garlock Kamprofile gaskets
- The Garlock EDGE® gasket

WARNING:

Properties/applications shown throughout this brochure are typical. Your specific application should not be undertaken without independent study and evaluation for suitability. For specific application recommendations consult Garlock. Failure to select the proper sealing products could result in property damage and/or serious personal injury.

Performance data published in this brochure has been developed from field testing, customer field reports and/or in-house testing.

While the utmost care has been used in compiling this brochure, we assume no responsibility for errors. Specifications subject to change without notice. This edition cancels all previous issues. Subject to change without notice.

Spiral Wound Gaskets

Manufactured in Accordance with ASME B16.20

Spiral wound gaskets—made with an alternating combination of formed metal wire and soft filler materials—form a very effective seal when compressed between two flanges. A v-shaped crown centered in the metal strip acts as a spring, giving gaskets greater resiliency under varying conditions. Filler and wire material can be changed to accommodate different chemical compatibility requirements. Fire safety can be assured by choosing flexible graphite as the filler material. If the load available to compress a gasket is limited, gasket construction and dimensions can be altered to provide an effective seal.

A spiral wound gasket may include a centering ring, an inner ring or both. The outer centering ring centers the gasket within the flange and acts as a compression limiter, while the inner ring provides additional radial strength. The inner ring also reduces flange erosion and protects the sealing element.

Resiliency and strength make spiral wound gaskets an ideal choice under a variety of conditions and applications. Widely used throughout refineries and chemical processing plants, spiral wound gaskets are also effective for power generation, pulp and paper, aerospace, and a variety of valve and specialty applications.

The spiral wound gasket industry is currently adapting to a change in the specification covering spiral wound gaskets. Previously API 601, the new specification is ASME B16.20. These specifications are very similar. Garlock metallic gaskets are manufactured in accordance with the guidelines set forth in the ASME B16.20 specifications.

Gasket Identification Markings Required by ASME B16.20

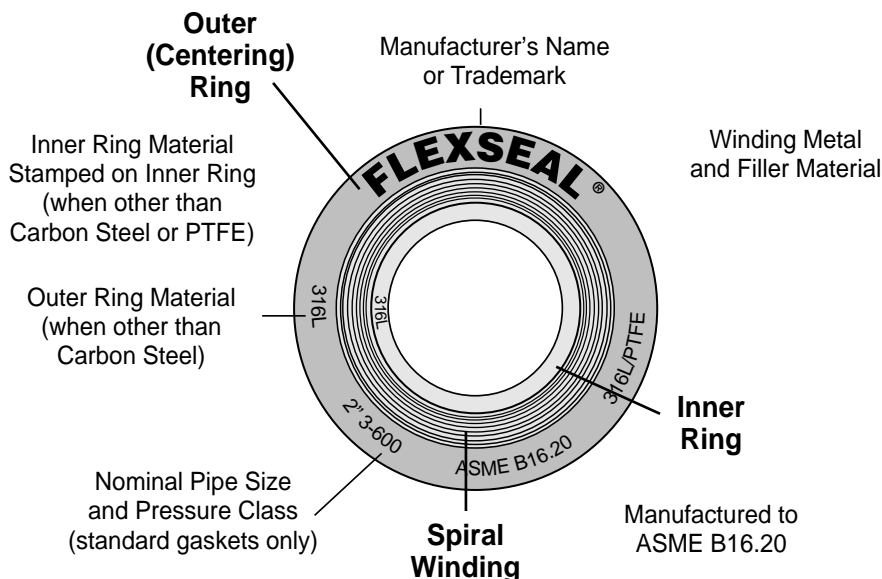

Performance Metrics

Controlled Density™ Process

- Garlock manufacturing process ensures optimum filler density across the gasket winding to achieve consistent compression and superior sealability
- High tightness level achieved with minimal compressive load, for longer-lasting seal
- All SW gaskets manufactured in accordance with the guidelines set forth in the ASME B16.20 specifications



ROTT Test and Results

ROTT Test

- **Purpose:** Determine room temperature sealing capabilities, by measuring the sealability of a gasket at incremental gasket stress values
- **Sample used:** Two 304 SS and flexible graphite-filled 4" Class 150 ASME B16.20 spiral wound gaskets
- **Procedure:** The leak rate is measured during the loading and unloading cycles, and a tightness curve is generated.*

Test Results

- When compared with other spiral wound gaskets, the Garlock metallic gasket was able to achieve equivalent tightness at a lower load in all tightness parameter values.
- During stress cycling, the performance of the Garlock metallic gasket gaskets was excellent, compared with other spiral wound gaskets.

Gasket Style and Material	Gasket Factor "M"	Gasket Factor "Y" (psi)
Traditional spiral wound gasket—304 SS and flexible graphite	3.00	10,000
Garlock spiral wound gasket	3.00	7,500

Gasket Material	Gasket Constant Gb (psi)	Gasket Constant 'a'	Gasket Constant Gs (psi)	Stress Req'd for Tightness of 100 (psi)	Stress Req'd for Tightness of 1000 (psi)	Stress Req'd for Tightness of 10,000 (psi)
Garlock flexible graphite-filled spiral wound gasket (ASME B16.20)	627	0.35	6.22	3,140	7,040	11,430
Flexible graphite spiral wound gasket	2,300	0.237	13	6,851	11,823	20,405
PTFE-filled spiral wound gasket	4,500	0.14	70	8,575	11,836	16,339
Foil-reinforced flexible graphite sheet	816	0.377	0.066	4,631	11,033	26,284
Garlock GRAPHONIC® gasket	315	0.36	1.857	1,653	3,787	8,676
"Low stress" spiral wound type gasket, flexible graphite filled	598	0.385	0.03	3,520	8,540	14,570
Garlock Kammprofile gasket	368	0.4	0.28	2,324	5,838	14,664

Comparison of Seating Requirements

* Gb = stress at which seal is initiated; "a" = the slope of the log/log tightness curve; Gs = intersection of the unload curve with the vertical axis (Tp1)

Note: For a 5" OD gasket at 800 psig, Tp100 = 102ml/min. leakage, Tp1,000 = 1.02ml/min. leakage, Tp10,000 = 0.01 ml/min. leakage.

The Garlock EDGE®

Benefits

Requires lower seating stress

- Seals at lower stress than conventional gaskets without an inner ring
- Eliminates flange damage caused by overtightening
- Relief ports allow tighter seal at lower loads

Eliminates radial buckling

- STABL-LOCK™ inner wrap construction prevents sealing element from flowing into and contaminating process stream

Tightest seal

- Modified guide ring ensures contact centered on raised face flange surfaces*

Multiple applications

- Dual flange (DF) design accommodates both 150 and 300 lb flanges—reduces inventory costs
- Select from a wide variety of metallic and filler materials with a full range of temperature capabilities**

* Contact Garlock Engineering when using the EDGE® gasket on lap joint flanges with substandard backing rings.

** See chart on page D-19.

Compare

Standard spiral wound gasket shows excessive inward buckling

The patented Garlock EDGE® spiral wound gasket is designed to reduce inward buckling

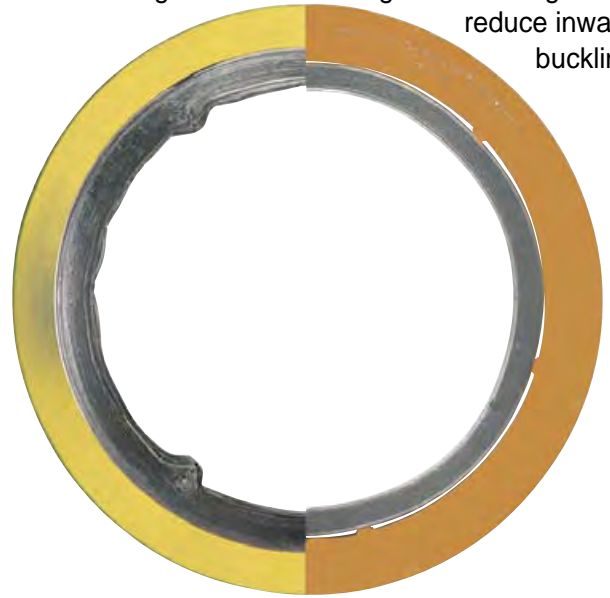

Gasket Style and Material	"M"	"Y" (psi)	Gb (psi)	"a"	Gs (psi)
Garlock EDGE® with 304 stainless and flexible graphite filler	2.00	5,000	793	0.4	0.31

Dual Flange (DF) Design

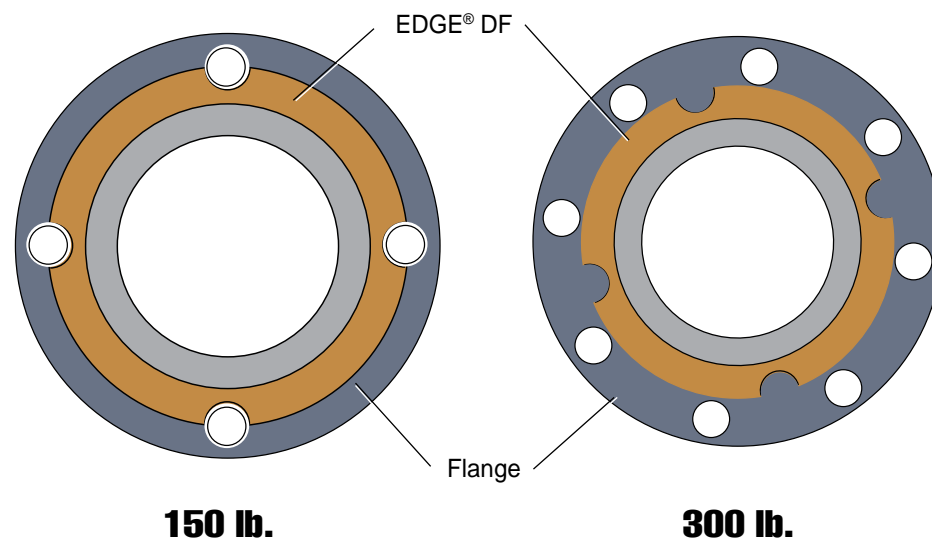

WARNING:

Properties/applications shown throughout this brochure are typical. Your specific application should not be undertaken without independent study and evaluation for suitability. For specific application recommendations consult Garlock. Failure to select the proper sealing products could result in property damage and/or serious personal injury.

Performance data published in this brochure has been developed from field testing, customer field reports and/or in-house testing.

While the utmost care has been used in compiling this brochure, we assume no responsibility for errors. Specifications subject to change without notice. This edition cancels all previous issues. Subject to change without notice.

HEAT SHIELD™ Gasket

Benefits

Outstanding fire resistance

- Combination of graphite filler and mica layers give superior fire safety

Ideal for oxidizing environments

- Layers of pure mica protect graphite filler and resist oxidation
- Good choice for plant steam drums, hydrocarbon catcrackers, hydrogen units, and exhaust manifolds

Seals with lower bolt loads

- Relief tab design provides solid seating of centering ring face
- Withstands bolt load loss caused by thermal cycling
- Inner wrap construction eliminates radial buckling
- Prevents catastrophic failure and potential damage to downstream equipment due to wire unraveling



Construction

- Heat-resistant graphite filler
- Heat- and oxidation-resistant pure mica filler
- Spiral-wound wires, of a choice of commercially available metals
- Rings of any standard metal, including INCONEL* X750

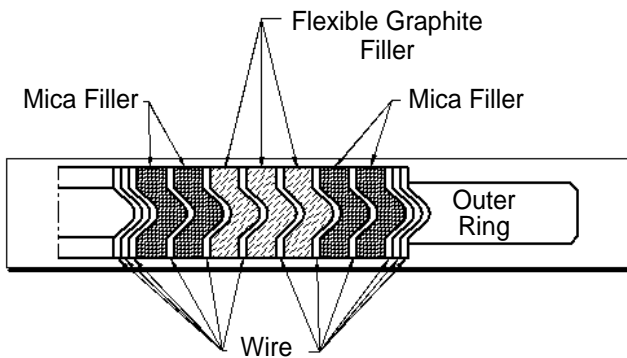

Specifications

Temperature, max.: 1250°F (677°C)
 Flange class: 150 to 600 lb.
 Pipe diameters: 2" to 24"; specials available

Gasket Style and Material	Gasket Factor "M"	Gasket Factor "Y" (psi)
Traditional spiral wound gasket—304 SS and flexible graphite	3.00	10,000
Garlock spiral wound gasket	3.00	7,500

WARNING:

Properties/applications shown throughout this brochure are typical. Your specific application should not be undertaken without independent study and evaluation for suitability. For specific application recommendations consult Garlock. Failure to select the proper sealing products could result in property damage and/or serious personal injury. Performance data published in this brochure has been developed from field testing, customer field reports and/or in-house testing.

While the utmost care has been used in compiling this brochure, we assume no responsibility for errors. Specifications subject to change without notice. This edition cancels all previous issues. Subject to change without notice.

* INCONEL is a registered trademark of Inco Alloys International, Inc.

TANDEM SEAL™*

Benefits

Chemical-resistant and fire-safe

- PTFE envelope withstands aggressive chemicals and corrosive media
- Fire-safe—passed independent fire tests
- Two sealing elements significantly reduce corrosion and bacterial contamination of flanges
- Seals to the ID of the pipe bore
- Specify pipe schedule when ordering

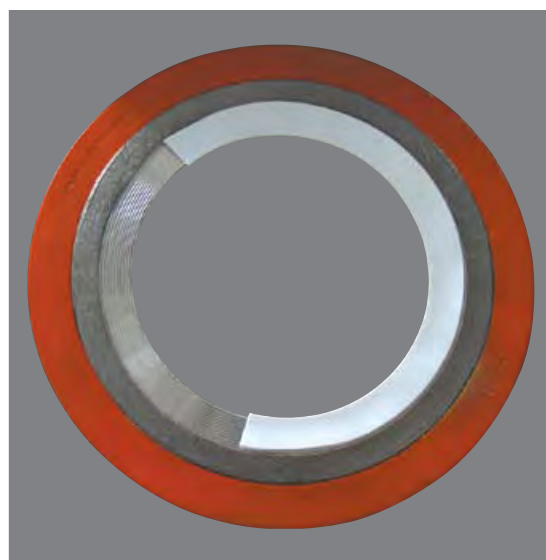

Seal Comparison

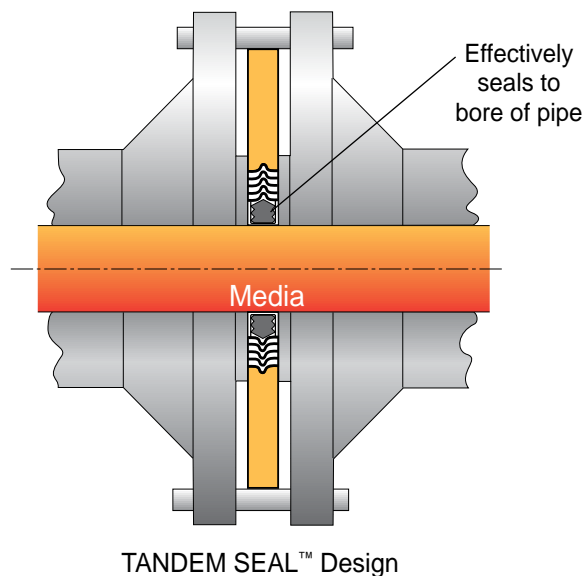
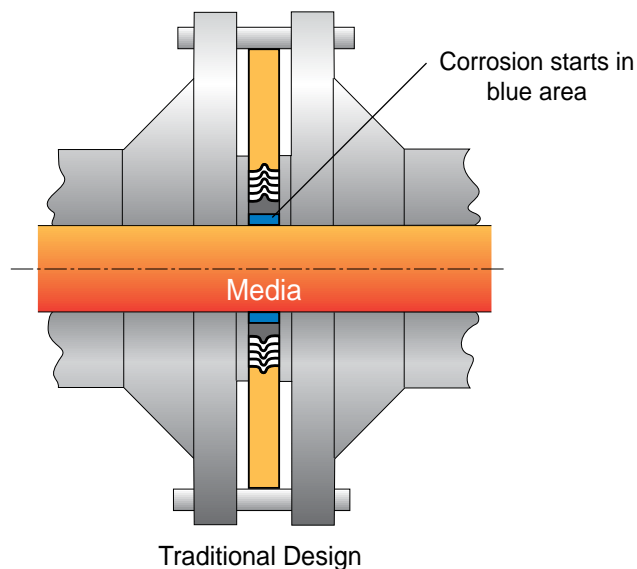

Standard Construction

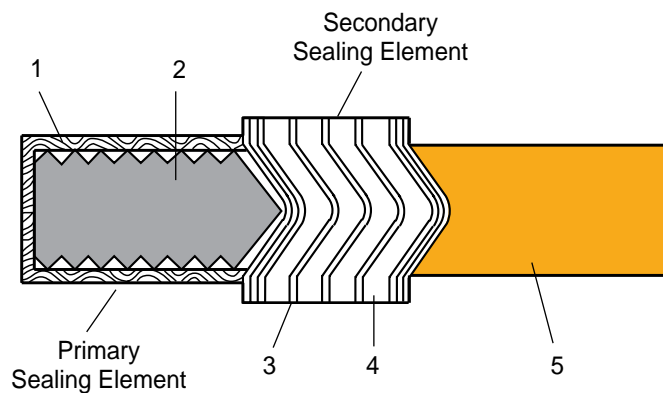

1. PTFE envelope
2. Profiled inner ring
3. Metal windings
4. Filler material
5. Outer guide ring

* Patent No. 5511797

FLEXSEAL® RW, RWI and SW Gaskets

Advantages

- Durable; easy installation and removal
- Seals pressures to flange ratings, in accordance with ASME B16.5
- Suitable for temperatures from cryogenic to 2,000°F (1,093°C)*
- Guide ring simplifies centering of sealing element on the flange face
- Designed solutions accommodate a variety of conditions by combining various metals and filler materials

Style RW

- General purpose gasket suitable for flat face and raised face flanges up to Class 2500**
- Centering ring accurately locates the gasket on the flange face, provides additional radial strength, and acts as a compression limiter
- Spiral winding (sealing element) consists of preformed metal and soft filler material

Style RWI

- Suitable for flat face and raised face flanges up to Class 2500**
- Recommended for higher pressure applications, for use with PTFE fillers, and when delineated by ASME B16.20
- Inner ring acts as compression limiter and protects sealing elements from process media attack

Style SW

- Suitable for tongue and groove, male-female, or groove-to-flat face flanges†
- Spiral winding only, containing preformed metal and soft filler material
- Also available with inner rings—Style SWI

Ordering Information

RW/RWI

When ordering specify:

- Nominal pipe size and pressure rating or specific gasket dimensions
- Winding and filler materials
- Centering and/or inner compression ring material

SW

When ordering, specify:

- O.D. and I.D. dimensions (and tolerance, if other than standard—see page D-19)
- Thickness of gasket
- Winding and filler material
- Inner ring material, if required (Style SWI)
- Pressure rating

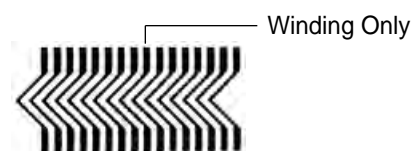
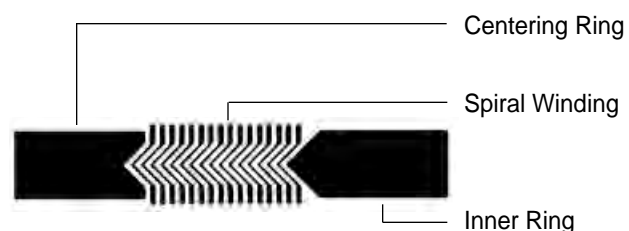
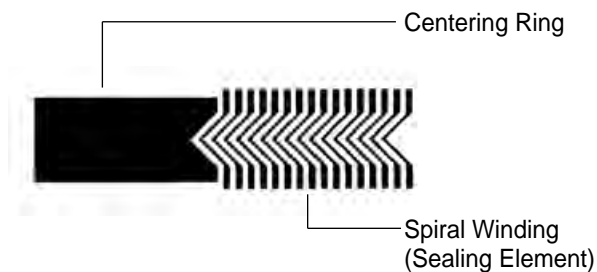

* Consult Garlock Engineering for material recommendations above 950°F (510°C)

** Depending on gasket size, an inner ring is recommended for applications above Class 600, due to the high available bolt load. See also Note 1, page D-22.

† This design does not have a compression limiter.

Note: For M & Y factors, see page D-33.
For ROTT Test results, see page D-4.

FLEXSEAL® MC and MCR Gaskets

For Manhole Cover Assemblies MC Gasket (manhole cover)

- Spiral winding only, containing preformed metal and soft filler material

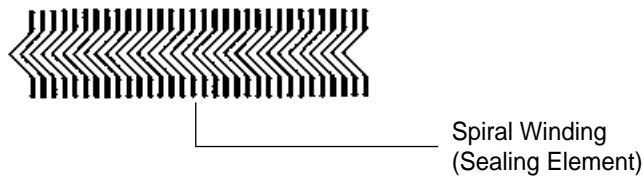

MCR Gasket (manhole cover with centering ring)

- Centering ring accurately locates the gasket on the flange face, provides additional radial strength, and acts as a compression limiter
- Spiral winding (sealing element) consists of preformed metal and soft filler material

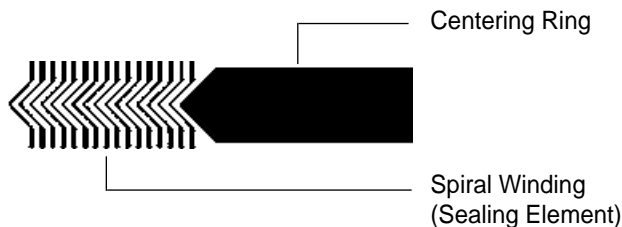

Ordering Information

When ordering, specify:

- Make and model of boiler and/or equipment if available (See chart page D-10)
- Gasket style and configuration
- Dimensions of gasket (thickness, flange seating width, and shape)
- Maximum operating pressure and temperature
- Type of metal and filler materials

WARNING:

Properties/applications shown throughout this brochure are typical. Your specific application should not be undertaken without independent study and evaluation for suitability. For specific application recommendations consult Garlock. Failure to select the proper sealing products could result in property damage and/or serious personal injury.

MC and MCR Configurations

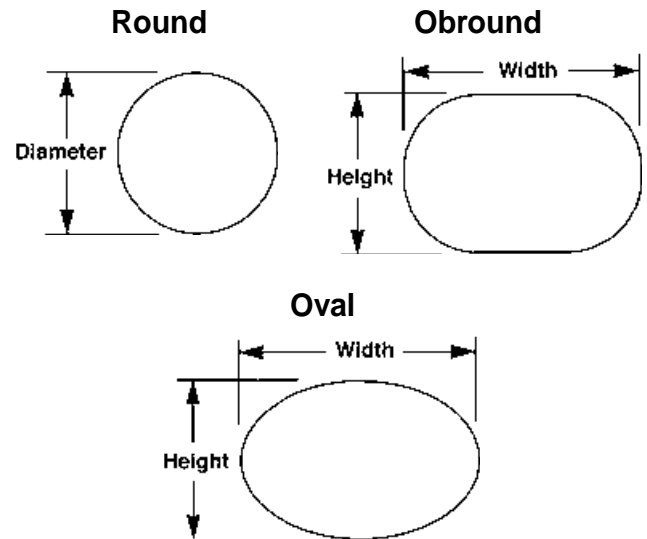

Style	Nominal I.D. Dimensions (Inches)	Thickness (Inches)	Flange Width (Inches)
MC Oval	11 x 15	0.175	3/4
MC Oval	11 x 15	0.175	15/16
MC Oval	11 x 15	0.175	1-1/4
MC Oval	12 x 16	0.250	15/16
MCR Oval	12 x 16	0.250	13/16
MC Oval	12 x 16	0.175	3/4
MC Oval	12 x 16	0.175	15/16
MC Oval	12 x 16	0.175	1-1/4
MC Oval	12 x 16	0.250	1-1/4
MC Round	16-1/16	0.175	3/4

Dimensions of MC and MCR Gaskets

Notes:

1. For pitted and rough flange surfaces, specify a gasket thickness of 0.250".
2. Orders for special cover assemblies should be accompanied by a dimensional drawing showing the minimum width of seating surfaces and other essential dimensions.
3. Style MC oval and obround gaskets are available in 0.175" and 0.250" thickness and in varying widths as shown above.
4. Orders for non-standard gaskets should also include a sketch or drawing of the cover assembly with all dimensions shown.

Performance data published in this brochure has been developed from field testing, customer field reports and/or in-house testing.

While the utmost care has been used in compiling this brochure, we assume no responsibility for errors. Specifications subject to change without notice. This edition cancels all previous issues. Subject to change without notice.

FLEXSEAL® HH Gaskets

For Boiler Handhole and Tubecap Assemblies

- Fits most standard boilers (specify maximum operating pressure when ordering)
- Available in thicknesses of 0.125" (special), 0.175" (standard) and 0.250" (special—for pitted surfaces)

Style HH Configurations

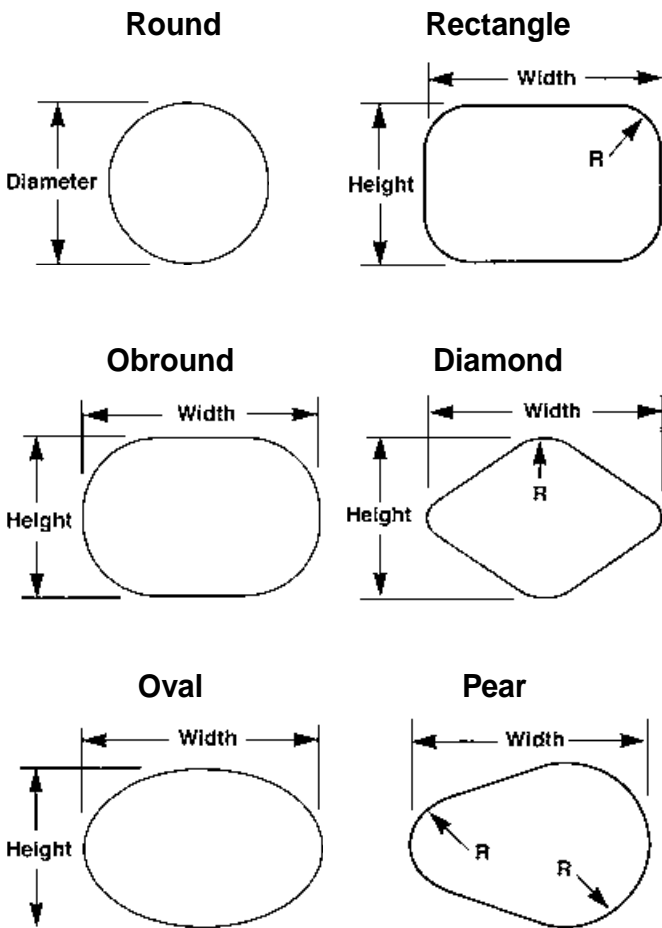

WARNING:

Properties/applications shown throughout this brochure are typical. Your specific application should not be undertaken without independent study and evaluation for suitability. For specific application recommendations consult Garlock. Failure to select the proper sealing products could result in property damage and/or serious personal injury.

Performance data published in this brochure has been developed from field testing, customer field reports and/or in-house testing.

While the utmost care has been used in compiling this brochure, we assume no responsibility for errors. Specifications subject to change without notice. This edition cancels all previous issues. Subject to change without notice.

Boiler Gasket Dimensions

Manufacturer and Model No.	Shape	Nominal I.D. Dimensions (Inches)	Flange Width (Inches)
Babcock and Wilcox #40 (207)	Diamond	3-3/8 x 3-3/4	3/16
#48 (208)	Oval	3-13/16 x 4-3/4	7/32
#24 (211)	Oval	4-1/2 x 5-1/2	7/32
#47	Round	2-1/32	3/16
#70	Round	3-9/32	3/16
#28 (212)	Rectangle	4-13/16 x 5	7/32
Badenhausen (See Riley Stoker)			
Cleaver-Brooks	Obround	3-9/32 x 4-17/32	3/8
Combustion Engr. 29N-L839	Diamond	3-3/8 x 4-1/4	1/4
4N-L740	Round	3-1/8	1/4
5N-L902	Round	3-5/8	1/4
Foster Wheeler 2 3/4 (1003)	Obround	2-25/32 x 3-13/32	7/32
3 15/16 (1005)	Oval	4-3/16 x 5-3/16	5/16
Heine	Round	3-5/8	3/8
Keeler	Obround	3 x 4	3/8
Oilfield	Oval	3 x 4	3/8
	Oval	3-1/2 x 4-1/2	3/8
Riley Stoker W-C2	Obround	3-23/32 x 5-23/32	11/32
Springfield	Oval	3-17/32 x 4-17/32	5/16
Union	Oval	3 x 4	3/8
	Pear	4-1/4 x 5-1/4	3/8
Vogt	Oval	4-1/4 x 5-1/8	7/32 (new)
Wickes			
D2300	Pear	4-1/8 x 5-1/8	9/32
D2301	Oval	3 x 4	5/16
	Oval	3-1/2 x 4-1/2	5/16

Ordering Information

When ordering, specify:

- Make and model of boiler and/or equipment, if available
- Gasket style and configuration
- Dimensions of gasket (thickness, flange seating width, and shape)
- Maximum operating pressure and temperature
- Type of metal and filler materials

FLEXSEAL® RW-RJ, RWI-RJ Gaskets

For Replacement of Ring Joint Gaskets

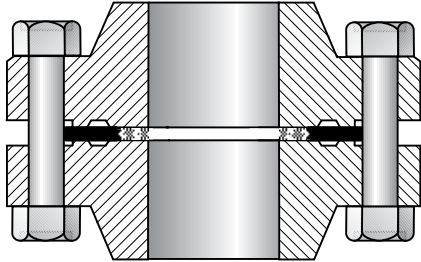

- Ideal replacement for solid metal oval or octagonal API ring joint gaskets (RTJ)
- Saves cost of flange replacement when gasket groove is badly worn
- Fast and easy installation—requires only a 3/16" flange separation (ring joint gasket may require as much as 3/4")
- Wide variety of metal and filler materials have a full range of temperature and pressure capabilities
- RW-RJ gaskets not stocked, but can be special-ordered; RWI-RJ gaskets available on request.

Nominal Pipe Size (Inches)	150 psi			300 psi			400 psi		
	Gasket I.D.	Gasket O.D.	Ring O.D.	Gasket I.D.	Gasket O.D.	Ring O.D.	Gasket I.D.	Gasket O.D.	Ring O.D.
1/2	—	—	—	9/16	1-1/16	2-1/8	9/16	1-1/16	2-1/8
3/4	—	—	—	13/16	1-5/16	2-5/8	13/16	1-5/16	2-5/8
1	1-1/8*	1-5/8*	2-5/8*	1-1/16	1-5/8	2-7/8	1-1/16	1-5/8	2-7/8
1-1/4	1-3/8*	1-7/8*	3*	1-5/16	2	3-1/4	1-5/16	2	3-1/4
1-1/2	1-5/8*	2-1/4*	3-3/8*	1-9/16	2-3/8	3-3/4	1-9/16	2-3/8	3-3/4
2	2-1/8*	2-7/8*	4-1/8*	2-1/8	2-3/4	4-3/8	2-1/8	2-3/4	4-3/8
2-1/2	2-3/4	3-5/16*	4-7/8*	2-3/4	3-5/16	5-1/8	2-3/4	3-5/16	5-1/8
3	3-5/16*	3-15/16*	5-3/8*	3-5/16	3-15/16	5-7/8	3-5/16	3-15/16	5-7/8
4	4-5/16*	5-3/16*	6-7/8*	4-5/16	5-3/16	7-1/8	4-5/16	5-3/16	7
5	5-5/16*	6-3/16*	7-3/4*	5-5/16	6-7/16	8-1/2	5-5/16	6-7/16	8-3/8
6	6-5/16*	7-3/16*	8-3/4*	6-7/16	7-5/8	9-7/8	6-7/16	7-5/8	9-3/4
8	8-1/4*	9-3/16*	11*	8-1/4	9-15/16	12-1/8	8-1/4	9-15/16	12
10	10-5/16*	11-7/16*	13-3/8*	10-5/16	12	14-1/4	10-5/16	12	14-1/8
12	12-3/16*	13-9/16*	16-1/8*	12-7/8†	14-1/4†	16-5/8†	12-7/8†	14-1/4†	16-1/2†
14	13-7/16*	14-15/16*	17-3/4*	14-1/4†	15-3/4†	19-1/8†	14-1/4†	15-3/4†	19†
16	15-5/16*	16-15/16*	20-1/4*	16-1/4†	17-3/4†	21-1/4†	16-1/4†	17-3/4†	21-1/8†
18	17-1/4*	19*	21-5/8*	18-1/4†	20-1/4†	23-1/2†	18-1/4†	20-1/4†	23-3/8†
20	19-1/8*	21-1/8*	23-7/8*	20-1/4†	22-3/16†	25-3/4†	20-1/4†	22-3/16†	25-1/2†
24	23*	25-1/4*	28-1/4*	24-1/4†	26-5/16†	30-1/2†	24-1/4†	26-5/16†	30-1/4†

Nominal Pipe Size (Inches)	600 psi			900 psi			1500 psi		
	Gasket I.D.	Gasket O.D.	Ring O.D.	Gasket I.D.	Gasket O.D.	Ring O.D.	Gasket I.D.	Gasket O.D.	Ring O.D.
1/2	9/16	1-1/16	2-1/8	9/16*	1-1/16*	2-1/2*	9/16*	1-1/16*	2-1/2*
3/4	13/16	1-5/16	2-5/8	13/16*	1-3/8*	2-3/4*	13/16*	1-3/8*	2-3/4*
1	1-1/16	1-5/8	2-7/8	1-1/16*	1-5/8*	3-1/8*	1-1/16*	1-5/8*	3-1/8*
1-1/4	1-5/16	2	3-1/4	1-5/16*	2*	3-1/2*	1-5/16*	2*	3-1/2*
1-1/2	1-9/16	2-3/8	3-3/4	1-9/16*	2-3/8*	3-7/8*	1-9/16*	2-3/8*	3-7/8*
2	2-1/8	2-3/4	4-3/8	2-1/4*	3-1/4*	5-5/8*	2-1/4*	3-1/4*	5-5/8*
2-1/2	2-3/4	3-5/16	5-1/8	2-9/16*	3-5/8*	6-1/2*	2-9/16*	3-5/8*	6-1/2*
3	3-5/16	3-15/16	5-7/8	3-3/16*	4-3/16*	6-5/8*	3-3/16*	4-11/16*	6-7/8*
4	4-5/16	5-3/16	7-5/8	4-1/16*	5-3/16*	8-1/8*	4-1/16*	5-11/16*	8-1/4*
5	5-5/16	6-7/16	9-1/2	5-5/16	6-7/16	9-3/4	5-1/16*	6-15/16*	10*
6	6-7/16	7-5/8	10-1/2	6-5/16	7-5/8	11-3/8	6*	7-9/16*	11-1/8*
8	8-1/4	9-15/16	12-5/8	8-1/4	9-15/16	14-1/8	7-7/8*	9-3/4*	13-7/8*
10	10-5/16	12	15-3/4	10-5/16	12	17-1/8	9-13/16*	11-7/8*	17-1/8*
12	12-7/8†	14-1/4†	18†	12-7/8	14-1/4	19-5/8	11-15/16*	13-13/16*	20-1/2*
14	14-1/4†	15-3/4†	19-3/8†	13-13/16	15-9/16	20-1/2	13-7/16	15-3/16	22-3/4
16	16-1/4†	17-3/4†	22-1/4†	15-9/16	17-9/16	22-5/8	15	17	25-1/4
18	18-1/4†	20-1/4†	23-3/8†	17-11/16	19-15/16	25-1/8	17-1/4	19-1/2	27-3/4
20	20-1/4†	22-3/16†	26-7/8†	19-11/16	21-15/16	27-1/2	19-3/16	21-7/16	29-3/4
24	24-1/4†	26-5/16†	31-1/8†	23-3/16	25-15/16	33	23	25-1/2	35-1/2

Dimensions for weld neck type flanges having a pipe bore equal to that of schedule 40 pipe and heavier, but not for slip-on flanges; except:

† Both charts: suitable for slip-on and weld neck type flanges

* Top chart: for weld neck type flanges having a pipe bore equal to that of schedule 40 pipe. Not for slip-on flanges.

* Bottom chart: for schedule 80 pipe and heavier.

FLEXSEAL® LMF, LTG and STG Gaskets

For Male-Female, Tongue and Groove Flanges

- Spiral winding of preformed metal and soft filler material—for use where no space is provided for a compression guide ring
- Inner diameter of windings is reinforced with several plies of metal without filler to give greater stability
- Style LMF — large male-female flanges
Style LTG — large tongue and groove flanges
Style STG — small tongue and groove flanges

Applications

- Valves
- Pumps
- Flanges
- Heat exchangers
- Vessels

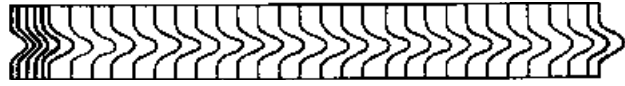

Cross Sectional View of Winding

Ordering Information

When ordering, specify:

- Nominal pipe size
- Pressure rating
- Winding materials (304 SS is standard, filler material must be specified)
- Thickness of winding (0.125" is standard)

Style LMF Gasket Dimensions

Nominal Pipe Size (Inches)	150 - 1500 psi		Nominal Pipe Size (Inches)	2500 psi	
	I.D. (Inches)	O.D. (Inches)		I.D. (Inches)	O.D. (Inches)
1/4	1/2	1	1/2	13/16	1-3/8
1/2	1	1-3/8	3/4	1-1/16	1-11/16
3/4	1-5/16	1-11/16	1	1-1/4	2
1	1-1/2	2	1-1/4	1-5/8	2-1/2
1-1/4	1-7/8	2-1/2	1-1/2	1-7/8	2-7/8
1-1/2	2-1/8	2-7/8	2	2-3/8	3-5/8
2	2-7/8	3-5/8	2-1/2	3	4-1/8
2-1/2	3-3/8	4-1/8	3	3-3/4	5
3	4-1/4	5	3-1/2	—	—
3-1/2	4-3/4	5-1/2	4	4-3/4	6-3/16
4	5-3/16	6-3/16	5	5-3/4	7-5/16
4-1/2	5-11/16	6-3/4	6	6-3/4	8-1/2
5	6-5/16	7-5/16	8	8-3/4	10-5/8
6	7-1/2	8-1/2	10	10-3/4	12-3/4
8	9-3/8	10-5/8	12	13	15
10	11-1/4	12-3/4			
12	13-1/2	15			
14	14-3/4	16-1/4			
16	17	18-1/2			
18	19-1/4	21			
20	21	23			
24	25-1/4	27-1/4			

Style LTG Dimensions

Nominal Pipe Size (Inches)	150 - 2500 psi	
	I.D. (Inches)	O.D. (Inches)
1/2	1	1-3/8
3/4	1-5/16	1-11/16
1	1-1/2	2
1-1/4	1-7/8	2-1/2
1-1/2	2-1/8	2-7/8
2	2-7/8	3-5/8
2-1/2	3-3/8	4-1/8
3	4-1/4	5
3-1/2	4-3/4	5-1/2
4	5-3/16	6-3/16
5	6-5/16	7-5/16
6	7-1/2	8-1/2
8	9-3/8	10-5/8
10	11-1/4	12-3/4
12	13-1/2	15
14	14-3/4	16-1/4
16	17	18-1/2
18	19-1/4	21
20	21	23
24	25-1/4	27-1/4

Style STG Dimensions

Nominal Pipe Size (Inches)	150 - 2500 psi	
	I.D. (Inches)	O.D. (Inches)
1/2	1	1-3/8
3/4	1-5/16	1-11/16
1	1-1/2	1-7/8
1-1/4	1-7/8	2-1/4
1-1/2	2-1/8	2-1/2
2	2-7/8	3-1/4
2-1/2	3-3/8	3-3/4
3	4-1/4	4-5/8
3-1/2	4-3/4	5-1/8
4	5-3/16	5-11/16
5	6-5/16	6-13/16
6	7-1/2	8
8	9-3/8	10
10	11-1/4	12
12	13-1/2	14-1/4
14	14-3/4	15-1/2
16	16-3/4	17-5/8
18	19-1/4	20-1/8
20	21	22
24	25-1/4	26-1/4

WARNING:

Properties/applications shown throughout this brochure are typical. Your specific application should not be undertaken without independent study and evaluation for suitability. For specific application recommendations consult Garlock. Failure to select the proper sealing products could result in property damage and/or serious personal injury.

Performance data published in this brochure has been developed from field testing, customer field reports and/or in-house testing.

While the utmost care has been used in compiling this brochure, we assume no responsibility for errors. Specifications subject to change without notice. This edition cancels all previous issues. Subject to change without notice.

Exchanger and Vessel Gaskets

Garlock manufactures a wide variety of solid metal, metal clad, and metal core gaskets. Among the most requested styles are double-jacketed gaskets, Kamm-profile, corrugated gaskets, and solid metal gaskets, all available in a choice of metals and filler materials.

Custom configurations of heat exchanger gaskets are also available. Spiral windings can be designed with or without partitions welded to the winding, or inner and outer rings with welded partitions. Contact Garlock for all of your heat exchanger and vessel gasket needs.

Garlock Heat Exchanger Gasket Configurations

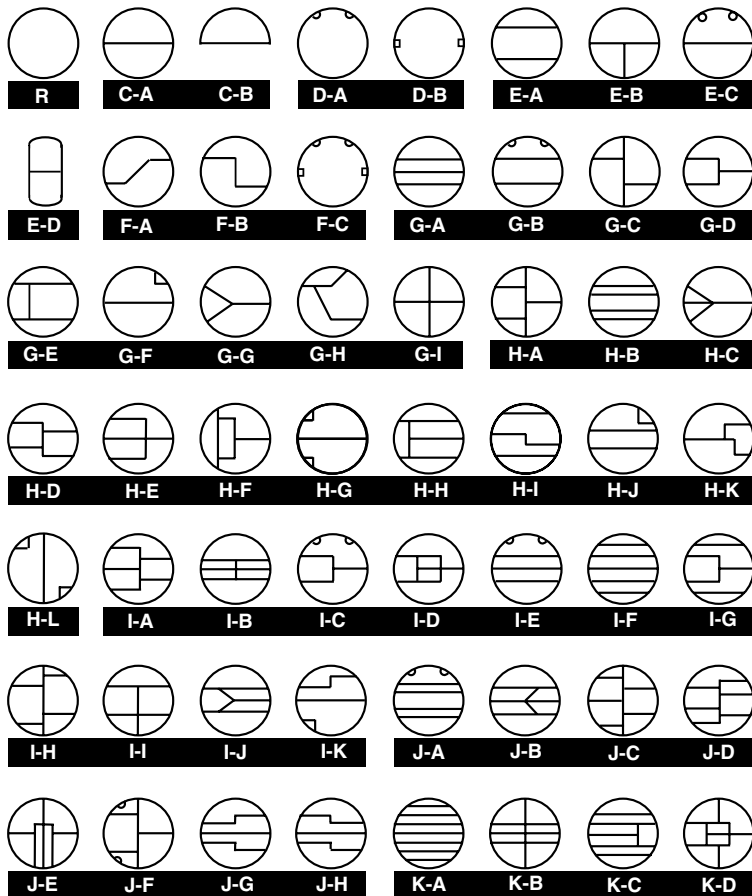

Tolerances

Gasket Outside Diameter	Inside Diameter Tolerance	Outside Diameter Tolerance
Up to 6"	+1/32" / -0	+0 / -1/32"
6" to 60"	+1/16" / -0	+0 / -1/16"
60" and above	+3/32" / -0	+0 / -3/32"

Thickness: $\pm 1/64"$
 Rib Width: $\pm 1/64"$

Radii: $\pm 1/16"$
 Rib Location: $\pm 1/16"$

Gasket Widths

Gasket Diameter	Minimum Width (Gasket and Ribs)	Maximum Width
Up to 12"	3/16"	*
Over 12"	1/4"	*

* **Note:** There is no maximum width for heat exchanger gaskets.

Series 600 Metal-Clad Gaskets

Gasket Styles

Style 600—Corrugated Solid Metal

A plain, all-metal corrugated gasket for use in low pressure applications that require a thin line contact because of space or weight limitations. Corrugated gaskets are a versatile sealing element where the available bolt loads are low.



Style 606—Solid Metal with Flexible Graphite Covering

A solid metal gasket covered with a layer of flexible graphite. This covering layer seals at a low load and fills voids and imperfections in the flange.

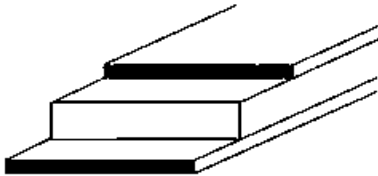

Style 620—Single-Jacketed

Generally used where the radial dimensions of the equipment sealing surfaces only allow space for a narrow width seal. Single-jacketed gaskets are constructed as shown above. The metal jacket reinforces the soft sealing material.

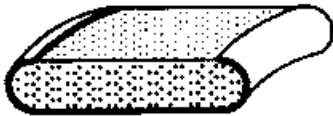

Style 623—Double-Jacketed

The double-jacketed gasket has good compressibility and resilience and is the most popular metal-clad gasket manufactured.

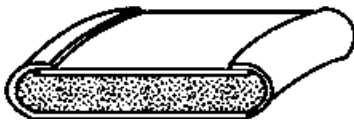

Style 624—Single-Jacketed Overlap

Construction of this gasket offers more filler protection than the standard single-jacketed design. Although constructed like a single-jacketed gasket, it has the added benefit of totally encasing the filler material.

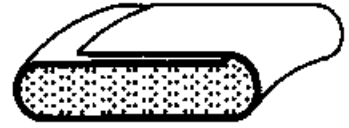

Style 626—Double-Jacketed Corrugated

Concentric corrugated sealing element totally encapsulates the soft filler material. The corrugations give improved resilience in applications where thermocycling is a problem.



Style 627—Double Shell

The double shell on this gasket allows greater hoop strength and rigidity with the addition of a completely overlapping inner seal. This gasket will withstand higher compressive loads common in high pressure applications.

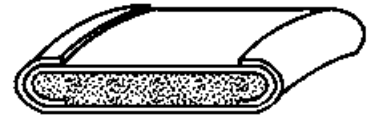

Style 629—Double-Jacketed Corrugated with Corrugated Metal Filler

The metal filler in Style 629 has greater resilience to problems resulting from thermocycling. The temperature limits of this gasket are governed only by the metal selected.



Series 600 Gasket Styles

Style 631—Two-Piece French-Type

Garlock Style 631 is ideal for narrow circular applications that require a positive unbroken metal gasket line across the full width of the flange. The filler is exposed on the OD. This gasket is also available in one, two, and three-piece constructions.



Style 635—Selected Metal and CERAFELT®*

This gasket is designed to be used in light-weight flanges. The thick compressible layer of CERAFELT® is shielded on the ID with a metallic barrier. Style 635 is commonly used in applications with very hot gases and low pressures.

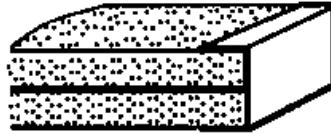

Style 640—Solid Metal

This gasket offers extremely tight sealing, high mechanical strength, and good resistance to temperature, corrosion and pressure. Bolting stress and flange surface finish are key to the performance of this design.



Style 641—Solid Metal Profile

Profile gaskets combine the desirable qualities of a solid metal gasket with the advantages of a reduced area of contact, thereby reducing the bolt stress required to effect a seal. This gasket has the same advantages of strength, heat conductivity, and resistance to temperature, pressure and corrosion as Garlock Style 640.



Style 642—Grooved Metal

See Kammprofile, page D-17.

Styles 644 and 645—Single- and Double-Jacketed Profile

Metal-jacketed profile gaskets employ the same principle of reduced contact area while protecting the flange faces from damage due to scoring. This gasket can be manufactured in one of two designs—either single-jacketed (Style 644) or double-jacketed (Style 645).



CERAFELT® is a registered trademark of Thermal Ceramics.

WARNING:

Properties/applications shown throughout this brochure are typical. Your specific application should not be undertaken without independent study and evaluation for suitability. For specific application recommendations consult Garlock. Failure to select the proper sealing products could result in property damage and/or serious personal injury.

Performance data published in this brochure has been developed from field testing, customer field reports and/or in-house testing.

While the utmost care has been used in compiling this brochure, we assume no responsibility for errors. Specifications subject to change without notice. This edition cancels all previous issues. Subject to change without notice.

GRAPHONIC® Metallic Gasket

The superior technology of the GRAPHONIC® family of gaskets ensures excellent sealing performance and reliability, even in the most difficult applications. Each of the three styles combines a corrugated metal core with a compressible sealing element of various materials, for resistance to a wide range of harsh conditions, including extreme temperature, corrosive chemicals, and thermal cycling.

Applications

- Valves
- Pumps
- Flanges
- Heat exchangers
- Vessels

GRAPHONIC® Gasket

With flexible graphite sealing element

- Accommodates a wide range of temperatures
- Seals effectively during thermal cycling
- Fire safe—withstood API and FITT fire tests
- Chemically resistant
- Long service life

TEPHONIC® Gasket

With ePTFE sealing element

- Chemically inert
- Forms a tight seal under low bolt load
- Conforms to minor sealing surface imperfections
- Withstands temperatures to 500°F (260°C)

G.E.T.™ Gasket

With graphite and ePTFE sealing element

- Combines fire safety with chemical resistance
- Conforms to minor sealing surface imperfections
- Rigid yet compressible



Construction

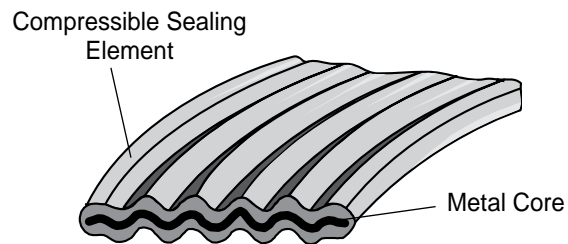

Standard Metals

- 316L Stainless

Also Available

- 304 Stainless
- Carbon steel
- INCONEL® 600
- INCONEL® 625
- INCOLOY® 800
- INCOLOY® 825
- HASTELLOY® C276
- MONEL® 400

Sealing Elements

- Flexible graphite
- ePTFE
- Combination graphite and ePTFE

Engineering Data

	GRAPHONIC®	TEPHONIC® and G.E.T.™
Temperature, Minimum:	-400°F (-240°C)	-400°F (-240°C)
Max. in atmosphere:	850°F (454°C)	500°F (260°C)
Max. in steam:	1,200°F (650°C)	500°F (260°C)
Max. continuous:	850°F (454°C)	500°F (260°C)
Pressure, max.:	1,000 psig (70 bar)	
P x T, max.		
1/16" thickness:	1,000,000 (35,000)†	
1/8" thickness:	350,000 (12,000)	

† P x T max. = psig x °F (bar x °C)

Note: When approaching maximum temperatures, consult the Garlock Metallic Gasket Engineering Dept. at **1-800-972-7638** or **1-281-459-7200**.

INCONEL® is a registered trademark of Inco Alloys International, Inc.
INCOLOY® is a registered trademark of Inco Alloys International, Inc.
HASTELLOY® is a registered trademark of Haynes International.
MONEL® is a registered trademark of International Nickel.

Garlock Kammprofile Gasket

Benefits

- Accommodates standard ASME flanges as well as weaker and non-circular flanges
- Seals less-than-perfect flanges
- Handles pressures from vacuum to Class 2500
- Performance replacement for jacketed heat exchanger gaskets

Applications

- Valves
- Pumps
- Flanges
- Heat exchangers
- Vessels

Serrated solid metal core

- Solid metal core resists cold flow, overcompression and blowout
- Rigid core provides exceptional stability, even in large sizes, and facilitates handling and installation
- Available in wide variety of metals

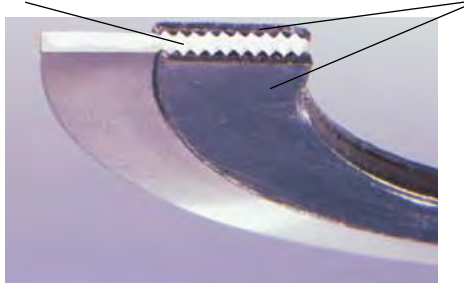

Soft, deformable sealing material

- Under compression, fills seating surface imperfections to form a tight, metal-to-metal connection
- Seals under low stress—ideal for weaker flanges
- Withstands extreme fluctuations in temperatures and pressures

Style Selection Guide

Garlock Kammprofile Styles	Construction		Centering Ring		Flange			
	Parallel Root	Convex Root	Integral	Floating	Male/Female	Tongue/Groove	Flat Face	Raised Face
642 A	●				●	●		●
642 AR	●		●				●	●
642 AR2	●			●			●	●
642 AC		●			●	●		●
642 ARC		●	●				●	●
642 ARC2		●		●			●	●

- **Parallel root core** is standard design
- **Convex root core** compensates for weaker flanges and resulting flange rotation
- **Integral centering ring** ensures optimum gasket positioning
- **Floating centering ring** allows for expansion and contraction during thermal cycling

Gasket Style	Gasket Factor "M"	Gasket Factor "Y" (psi)
Kammprofile gasket	4.00	1,000

WARNING:

Properties/applications shown throughout this brochure are typical. Your specific application should not be undertaken without independent study and evaluation for suitability. For specific application recommendations consult Garlock. Failure to select the proper sealing products could result in property damage and/or serious personal injury.

Performance data published in this brochure has been developed from field testing, customer field reports and/or in-house testing.

While the utmost care has been used in compiling this brochure, we assume no responsibility for errors. Specifications subject to change without notice. This edition cancels all previous issues. Subject to change without notice.

Factors Affecting Gasket Performance

A gasket is any deformable material which, when clamped between essentially stationary faces, prevents the passage of media across the gasketed connection.

Compressing the gasket material causes the material to flow into the imperfections of the sealing areas and effect a seal. This seal prevents the escape of the contained media. In order to maintain this condition, sufficient load must be applied to the connection to oppose the hydrostatic end force created by the internal pressure of the system.

Gasket performance depends on a number of factors, including:

1. **Gasket Metal and Filler Material:** The materials must withstand the effects of:
 - a. **Temperature:** Temperature can adversely affect mechanical and chemical properties of the gasket, as well as physical characteristics such as oxidation and resilience.
 - b. **Pressure:** The media or internal piping pressure can blow out the gasket across the flange face.
 - c. **Media:** The gasket materials must be resistant to corrosive attack from the media.
2. **Joint Design:** The force holding the two flanges together must be sufficient to prevent flange separation caused by hydrostatic end force, resulting from the pressure in the entire system.
3. **Proper Bolt Load:** If the bolt load is insufficient to deform the gasket, or is so excessive that it crushes the gasket, a leak will occur.
4. **Surface Finish:** If the surface finish is not suitable for the gasket, a seal will not be effected.

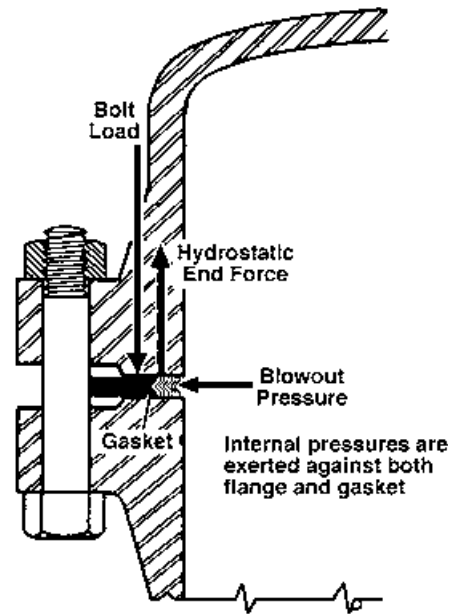

Forces Acting on a Gasket

WARNING:

Properties/applications shown throughout this brochure are typical. Your specific application should not be undertaken without independent study and evaluation for suitability. For specific application recommendations consult Garlock. Failure to select the proper sealing products could result in property damage and/or serious personal injury.

Performance data published in this brochure has been developed from field testing, customer field reports and/or in-house testing.

While the utmost care has been used in compiling this brochure, we assume no responsibility for errors. Specifications subject to change without notice. This edition cancels all previous issues. Subject to change without notice.

Spiral Wound Specifications

Temperature Limits for Common Metals

Material	Minimum		Maximum		Abbreviation
	°F	°C	°F	°C	
304 Stainless Steel	-320	-195	1,400	760	304
316L Stainless Steel	-150	-100	1,400	760	316L
317L Stainless Steel	-150	-100	1,400	760	317L
321 Stainless Steel	-320	-195	1,400	760	321
347 Stainless Steel	-320	-195	1,700	925	347
Carbon Steel	-40	-40	1,000	540	CRS
20Cb-3 (Alloy 20)	-300	-185	1,400	760	A-20
HASTELLOY® B 2	-300	-185	2,000	1,090	HAST B
HASTELLOY® C 276	-300	-185	2,000	1,090	HAST C
INCOLOY® 800	-150	-100	1,600	870	IN 800
INCOLOY® 825	-150	-100	1,600	870	IN 825
INCONEL® 600	-150	-100	2,000	1,090	INC 600
INCONEL® 625	-150	-100	2,000	1,090	INC 625
INCONEL® X750	-150	-100	2,000	1,090	INX
MONEL® 400	-200	-130	1,500	820	MON
Nickel 200	-320	-195	1,400	760	NI
Titanium	-320	-195	2,000	1,090	TI

Guide Ring Color Code*
Yellow
Green
Maroon
Turquoise
Blue
Silver
Black
Brown
Beige
White
White
Gold
Gold
No Color
Orange
Red
Purple

Temperature Limits for Filler Material

Material	Minimum		Maximum COT		Abbreviation
	°F	°C	°F	°C	
Ceramic†	-350	-212	2,000	1,090	CER
Flexible Graphite	-350	-212	950	510	F.G.
PTFE	-400	-240	500	260	PTFE
Verdicarb (Mica Graphite)	-350	-212	350	175	VC

Stripe Color Code*
Light Green
Gray
White
Pink

Standard Tolerances

For windings

Gasket Diameter	ID	OD
Up to 1"	" +1/64" -0	" +0 -1/32"
1" to 24"	" +1/32" -0	" +0 -1/32"
24" to 36"	" +3/64" -0	" +0 -1/16"
36" to 60"	" +1/16" -0	" +0 -1/16"
60" and above	" +3/32" -0	" +0 -3/32"

For spiral wound gaskets not otherwise specified.

Gasket Thickness Tolerance		Width Limits		Compressed Thickness
Thickness	Tolerance	Minimum	Maximum	
0.125"***	±0.005"	3/16"	1"††	0.090 - 0.100"
0.175"***	±0.005"	1/4"	1-1/2"††	0.125 - 0.135"
0.250"***	±0.005"	5/16"	1-1/2"††	0.180 - 0.200"
0.285"***	±0.005"	5/16"	1-1/2"††	0.200 - 0.220"

Available Thicknesses

Winding	Ring(s) Inner & Outer
0.125"	3/32"
0.175"	1/8"
0.250"	3/16"
0.285"	3/16"

Note:

Thickness tolerance is ±0.005" on all gaskets, except +0.010" -0.005" on gaskets with:

- Less than 1" ID and greater than 26" ID
- PTFE filler
- Flange widths of 1" or greater

* ASME B 16.20 standard

† Contact Garlock Engineering when selecting this material.

** Measured across the metallic portion of the gasket not including the filler, which may protrude slightly.

†† Spiral wound gaskets can be made to large maximum widths if required. Call Garlock for details.

HASTELLOY® is a registered trademark of Haynes International.
INCOLOY® and INCONEL® are registered trademarks of Inco Alloys International, Inc.

MONEL® is a registered trademark of International Nickel.

Flange Types

Flat Face

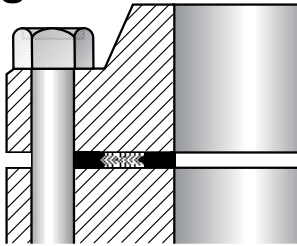

Unconfined Gasket

- Mating faces of both flanges are flat
- Gasket may be ring type, or full face, which covers the entire face both inside and outside the bolts

Raised Face

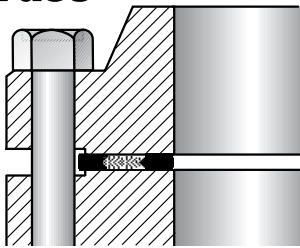

Unconfined Gasket

- Flange sealing surface is reduced to achieve higher seating stress
- Gasket is usually ring type, contained entirely within bolts

Ring Joint

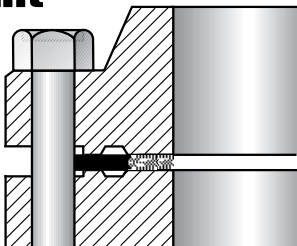

Also Called "API Joint" or "RTJ"

- Both flange faces have matching flat-bottomed grooves with sides tapered from the vertical at 23°
- Gasket seats on flat section of flange between bore and ring joint groove
- Garlock spiral wound gaskets can replace solid metal ring gaskets

Male-Female

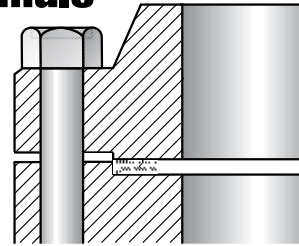

Semi-Confined Gasket

- Depth of female (recessed) face normally equal to or less than height of male (raised) face, to prevent metal-to-metal contact during gasket compression
- Recessed O.D. normally is not more than 1/16" larger than the O.D. of the male face
- Joint must be pried apart for disassembly

Tongue and Groove

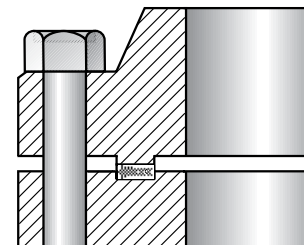

Fully Confined Gasket

- Groove depth is equal to or less than tongue height
- Groove usually not over 1/16" wider than tongue
- Gasket dimensions will match tongue dimensions
- Joint must be pried apart for disassembly

Groove to Flat

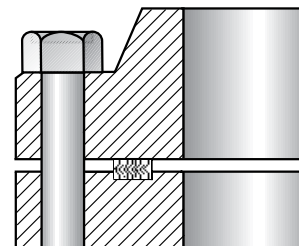

Fully Confined Gasket

- One flange face is flat, the other is recessed
- For applications requiring accurate control of gasket compression
- Only resilient gaskets are recommended—spiral wound, hollow metal O-ring, pressure-actuated, and metal-jacketed gaskets

Gasket Selection By Flange Type

	RW	RWI	EDGE®	TANDEM	SW	MC	MCR	HH	RW-RJ	RWI-RJ	LMF	LTG	STG	HEAT SHIELD™
Flat Face	■	■	■	■		■	■	■						■
Raised Face	■	■	■	■			■							■
Ring Joint									■	■				
Male-Female					■	■					■	■	■	
Tongue-&-Groove					■	■						■	■	
Groove-to-Flat					■	■								

Flange Surface Finish

The surface finish of a flange is described as follows:

Roughness

- Average of peaks and valleys measured from mid-line of flange surface (in millionths of an inch)
- Expressed as rms (root mean square) or AA (arithmetic average) or AARH (arithmetic average roughness height)

Lay

- The direction of the predominant surface-roughness pattern
- Example: multidirectional, phonographic spiral serrations, etc.

Waviness

- The departure from overall flatness
- Measured in thousandths or fractions of an inch

Recommended Values

Spiral Wound Gaskets	125-250 rms
GRAPHONIC® Gaskets	125-250 rms
Kammprofile Gaskets	125-250 rms
Jacketed or Metal Clad Gaskets	63-80 rms
Solid Metal Gaskets	63-80 rms

Note:

These values are suggested only and not mandatory; however they are based upon the best cross-section of successful design experience currently available.

WARNING:

Properties/applications shown throughout this brochure are typical. Your specific application should not be undertaken without independent study and evaluation for suitability. For specific application recommendations consult Garlock. Failure to select the proper sealing products could result in property damage and/or serious personal injury.

Performance data published in this brochure has been developed from field testing, customer field reports and/or in-house testing.

While the utmost care has been used in compiling this brochure, we assume no responsibility for errors. Specifications subject to change without notice. This edition cancels all previous issues. Subject to change without notice.

Maximum Flange Bore for FLEXSEAL® Gaskets

Flange Size (NPS)	Pressure Class							
	75	150	300	400	600	900 ¹	1500 ¹	2500 ¹
1/2"	No recommendation in 75 lb. flanges	Weld-neck only ²			Weld-neck only ²			
3/4"					Weld-neck only ²			
1"		Slip-on ³ Weld-neck ²		No flanges. Use Class 600	Slip-on ³ Weld-neck ²	No flanges. Use Class 1500		Weld-neck only ²
1 1/4"					Slip-on ³ Weld-neck, any bore			
1 1/2"		Slip-on, Weld-neck, any bore			Slip-on ³ Weld-neck, any bore			Weld-neck with Standard wall bore (includes nozzle ⁴ but excludes Slip-on)
2"					Slip-on, Weld-neck, any bore			
2 1/2"		Slip-on, Weld-neck, any bore			Slip-on, Weld-neck, any bore			Weld-neck w/ Schedule 60 bore
3"					Slip-on, Weld-neck, any bore			
4"		Slip-on, Weld-neck, any bore			Weld-neck with Schedule 10S bore described in ASME B36.19M (includes nozzle ⁴ but excludes Slip-on)			Weld-neck w/ Schedule 80 bore
6"								
8"		Slip-on, Weld-neck, any bore			Weld-neck with Schedule 10 bore described in ASME B36.10M (excludes nozzle ⁴ and Slip-on ⁵)			No flanges
10"								
12"		Slip-on, Weld-neck, any bore			Weld-neck with Schedule 10 bore described in ASME B36.10M (excludes nozzle ⁴ and Slip-on ⁵)		Weld-neck w/ Standard wall bore (excludes nozzle and Slip-on)	No flanges
14"							Slip-on, Weld-neck, any bore	
16"	Slip-on, Weld-neck, any bore			Weld-neck with Schedule 10 bore described in ASME B36.10M (excludes nozzle ⁴ and Slip-on ⁵)		Weld-neck w/ Standard wall bore (excludes nozzle and Slip-on)	No flanges	
18"						Slip-on, Weld-neck, any bore		
20"	Slip-on, Weld-neck, any bore			Weld-neck with Schedule 10 bore described in ASME B36.10M (excludes nozzle ⁴ and Slip-on ⁵)		Weld-neck w/ Standard wall bore (excludes nozzle and Slip-on)	No flanges	
24"						Slip-on, Weld-neck, any bore		
	Slip-on, Weld-neck, any bore			Weld-neck with Schedule 10 bore described in ASME B36.10M (excludes nozzle ⁴ and Slip-on ⁵)		Weld-neck w/ Standard wall bore (excludes nozzle and Slip-on)	No flanges	
						Slip-on, Weld-neck, any bore		
	Slip-on, Weld-neck, any bore			Weld-neck with Schedule 10 bore described in ASME B36.10M (excludes nozzle ⁴ and Slip-on ⁵)		Weld-neck w/ Standard wall bore (excludes nozzle and Slip-on)	No flanges	
						Slip-on, Weld-neck, any bore		
	Slip-on, Weld-neck, any bore			Weld-neck with Schedule 10 bore described in ASME B36.10M (excludes nozzle ⁴ and Slip-on ⁵)		Weld-neck w/ Standard wall bore (excludes nozzle and Slip-on)	No flanges	
						Slip-on, Weld-neck, any bore		
	Slip-on, Weld-neck, any bore			Weld-neck with Schedule 10 bore described in ASME B36.10M (excludes nozzle ⁴ and Slip-on ⁵)		Weld-neck w/ Standard wall bore (excludes nozzle and Slip-on)	No flanges	
						Slip-on, Weld-neck, any bore		
	Slip-on, Weld-neck, any bore			Weld-neck with Schedule 10 bore described in ASME B36.10M (excludes nozzle ⁴ and Slip-on ⁵)		Weld-neck w/ Standard wall bore (excludes nozzle and Slip-on)	No flanges	
						Slip-on, Weld-neck, any bore		

Notes:

1. Inner rings should be used for Class 900 gaskets, NPS 24; Class 1500 gaskets, NPS 12 thru NPS 24; and Class 2500 gaskets, NPS 4 thru 12 (see ASME B16.5, 3.2.5). These inner rings may extend into the pipe bore a maximum of 0.06" (1.5 mm) under the worst combination or maximum bore, eccentric installation, and additive tolerances. Purchaser should specify inner ring material.
2. In these sizes the gasket is suitable for a weld-neck flange with a standard wall bore, if the gasket and the flange are assembled concentrically. This also applies to a nozzle. It is the user's responsibility to determine if the gasket is satisfactory for the flange of any larger bore.
3. Gaskets in these sizes are suitable for slip-on flanges only if the gaskets and flanges are assembled concentrically.
4. A nozzle is a long welded neck; the bore equals the flange NPS.
5. An NPS 24 gasket is suitable for nozzles.

WARNING:

Properties/applications shown throughout this brochure are typical. Your specific application should not be undertaken without independent study and evaluation for suitability. For specific application recommendations consult Garlock. Failure to select the proper sealing products could result in property damage and/or serious personal injury.

Performance data published in this brochure has been developed from field testing, customer field reports and/or in-house testing.

While the utmost care has been used in compiling this brochure, we assume no responsibility for errors. Specifications subject to change without notice. This edition cancels all previous issues. Subject to change without notice.

Styles RW, RWI Dimensions 1/4" to 24" Flanges

ASME B16.20 Gaskets for ASME B16.5 Flanges

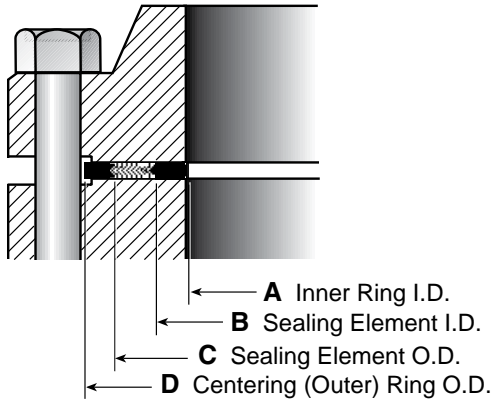

Class 150

Size NPS	Inner Ring	Sealing Element		Outer Ring
	Inside (A) Diameter	Inside (B) Diameter	Outside (C) Diameter	Outside (D) Diameter
1/4*	—	0.50	0.88	1.75
1/2	0.56	0.75	1.25	1.88
3/4	0.81	1.00	1.56	2.25
1	1.06	1.25	1.88	2.63
1-1/4	1.50	1.88	2.38	3.00
1-1/2	1.75	2.13	2.75	3.38
2	2.19	2.75	3.38	4.13
2-1/2	2.62	3.25	3.88	4.88
3	3.19	4.00	4.75	5.38
3-1/2*	—	4.50	5.25	6.38
4	4.19	5.00	5.88	6.88
4-1/2*	—	5.50	6.50	7.00
5	5.19	6.13	7.00	7.75
6	6.19	7.19	8.25	8.75
8	8.50	9.19	10.38	11.00
10	10.56	11.31	12.50	13.38
12	12.50	13.38	14.75	16.13
14	13.75	14.63	16.00	17.75
16	15.75	16.63	18.25	20.25
18	17.69	18.69	20.75	21.63
20	19.69	20.69	22.75	23.88
24	23.75	24.75	27.00	28.25

* ASME B16.20 does not include dimensions for NPS 1/4, 3-1/2 or 4-1/2, or Class 400 flanges up to NPS 3 and Class 900 flanges up to NPS 2-1/2. Dimensions in inches.

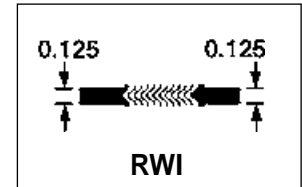
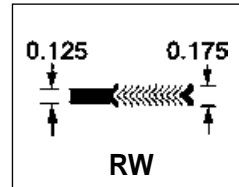

Class 300

Size NPS	Inner Ring	Sealing Element		Outer Ring
	Inside (A) Diameter	Inside (B) Diameter	Outside (C) Diameter	Outside (D) Diameter
1/4*	—	0.50	0.88	1.75
1/2	0.56	0.75	1.25	2.13
3/4	0.81	1.00	1.56	2.63
1	1.06	1.25	1.88	2.88
1-1/4	1.50	1.88	2.38	3.25
1-1/2	1.75	2.13	2.75	3.75
2	2.19	2.75	3.38	4.38
2-1/2	2.62	3.25	3.88	5.13
3	3.19	4.00	4.75	5.88
3-1/2*	—	4.50	5.25	6.50
4	4.19	5.00	5.88	7.13
4-1/2*	—	5.50	6.50	7.75
5	5.19	6.13	7.00	8.50
6	6.19	7.19	8.25	9.88
8	8.50	9.19	10.38	12.13
10	10.56	11.31	12.50	14.25
12	12.50	13.38	14.75	16.63
14	13.75	14.63	16.00	19.13
16	15.75	16.63	18.25	21.25
18	17.69	18.69	20.75	23.50
20	19.69	20.69	22.75	25.75
24	23.75	24.75	27.00	30.50

Notes:

1. Inner rings are required for all PTFE gaskets and for Class 900 gaskets, NPS 24; Class 1500 gaskets, NPS 12 through NPS 24; and Class 2500 gaskets, NPS 4 through NPS 12 (see ASME B16.20 code, 3.2.5).
2. The gasket outside diameter tolerance for NPS 1/2 through NPS 8 is ± 0.03 "; for NPS 10 through NPS 24, $+0.06$ ", -0.03 ".
3. The gasket inside diameter tolerance for NPS 1/2 through NPS 8 is ± 0.016 "; for NPS 10 through NPS 24, ± 0.03 ".
4. The centering ring outside diameter tolerance is ± 0.03 ".
5. There are no Class 400 flanges in NPS 1/2 through NPS 3 (use Class 600), Class 900 flanges in NPS 1/2 through NPS 2-1/2 (use Class 1500), or Class 2500 flanges NPS 14 and larger.

Styles RW, RWI Dimensions 1/4" to 24" Flanges

Class 400

Size NPS	Inner Ring	Sealing Element		Outer Ring
	Inside (A) Diameter	Inside (B) Diameter	Outside (C) Diameter	Outside (D) Diameter
1/4*	—	0.50	0.88	1.75
1/2*	—	0.75	1.25	2.13
3/4*	—	1.00	1.56	2.63
1*	—	1.25	1.88	2.88
1-1/4*	—	1.88	2.38	3.25
1-1/2*	—	2.13	2.75	3.75
2*	—	2.75	3.38	4.38
2-1/2*	—	3.25	3.88	5.13
3*	—	4.00	4.75	5.88
3-1/2*	—	4.13	5.25	6.38
4	4.04	4.75	5.88	7.00
4-1/2*	—	5.31	6.50	7.63
5	5.05	5.81	7.00	8.38
6	6.10	6.88	8.25	9.75
8	8.10	8.88	10.38	12.00
10	10.05	10.81	12.50	14.13
12	12.10	12.88	14.75	16.50
14	13.50	14.25	16.00	19.00
16	15.35	16.25	18.25	21.13
18	17.25	18.50	20.75	23.38
20	19.25	20.50	22.75	25.50
24	23.25	24.75	27.00	30.25

Class 600

Size NPS	Inner Ring	Sealing Element		Outer Ring
	Inside (A) Diameter	Inside (B) Diameter	Outside (C) Diameter	Outside (D) Diameter
1/4*	—	0.50	0.88	1.75
1/2	0.56	0.75	1.25	2.13
3/4	0.81	1.00	1.56	2.63
1	1.06	1.25	1.88	2.88
1-1/4	1.50	1.88	2.38	3.25
1-1/2	1.75	2.13	2.75	3.75
2	2.19	2.75	3.38	4.38
2-1/2	2.62	3.25	3.88	5.13
3	3.19	4.00	4.75	5.88
3-1/2*	—	4.13	5.25	6.38
4	4.04	4.75	5.88	7.63
4-1/2*	—	5.31	6.50	8.25
5	5.05	5.81	7.00	9.50
6	6.10	6.88	8.25	10.50
8	8.10	8.88	10.38	12.63
10	10.05	10.81	12.50	15.75
12	12.10	12.88	14.75	18.00
14	13.50	14.25	16.00	19.38
16	15.35	16.25	18.25	22.25
18	17.25	18.50	20.75	24.13
20	19.25	20.50	22.75	26.88
24	23.25	24.75	27.00	31.13

Class 900

Size NPS	Inner Ring	Sealing Element		Outer Ring
	Inside (A) Diameter	Inside (B) Diameter	Outside (C) Diameter	Outside (D) Diameter
1/2*	—	0.75	1.25	2.50
3/4*	—	1.00	1.56	2.75
1*	—	1.25	1.88	3.13
1-1/4*	—	1.56	2.38	3.50
1-1/2*	—	1.88	2.75	3.88
2*	—	2.31	3.38	5.63
2-1/2*	—	2.75	3.88	6.50
3	3.10	3.75	4.75	6.63
3-1/2*	—	4.13	5.25	7.50
4	4.04	4.75	5.88	8.13
4-1/2*	—	5.31	6.50	9.38
5	5.05	5.81	7.00	9.75
6	6.10	6.88	8.25	11.38
8	7.75	8.75	10.13	14.13
10	9.69	10.88	12.25	17.13
12	11.50	12.75	14.50	19.63
14	12.63	14.00	15.75	20.50
16	14.75	16.25	18.00	22.63
18	16.75	18.25	20.50	25.13
20	19.00	20.50	22.50	27.50
24	23.25 (5)	24.75	26.75	33.00

* ASME B16.20 does not include dimensions for NPS 1/4, 3-1/2 or 4-1/2, or Class 400 flanges up to NPS 3 and Class 900 flanges up to NPS 2-1/2. Dimensions in inches.

Notes:

1. Inner rings are required for all PTFE gaskets and for Class 900 gaskets, NPS 24; Class 1500 gaskets, NPS 12 through NPS 24; and Class 2500 gaskets, NPS 4 through NPS 12 (see ASME B16.20 code, 3.2.5).
2. The gasket outside diameter tolerance for NPS 1/2 through NPS 8 is ± 0.03 "; for NPS 10 through NPS 24, $+0.06$ ", -0.03 ".
3. The gasket inside diameter tolerance for NPS 1/2 through NPS 8 is ± 0.016 "; for NPS 10 through NPS 24, ± 0.03 ".
4. The centering ring outside diameter tolerance is ± 0.03 ".
5. There are no Class 400 flanges in NPS 1/2 through NPS 3 (use Class 600), Class 900 flanges in NPS 1/2 through NPS 2-1/2 (use Class 1500), or Class 2500 flanges NPS 14 and larger.

Styles RW, RWI Dimensions 1/4" to 24" Flanges

ASME B16.20 Gaskets for ASME B16.5 Flanges

Class 1500

Size NPS	Inner Ring	Sealing Element		Outer Ring
	Inside (A) Diameter	Inside (B) Diameter	Outside (C) Diameter	Outside (D) Diameter
1/2	0.56	0.75	1.25	2.50
3/4	0.81	1.00	1.56	2.75
1	1.06	1.25	1.88	3.13
1-1/4	1.31 (4)	1.56	2.38	3.50
1-1/2	1.63 (4)	1.88	2.75	3.88
2	2.06 (4)	2.31	3.38	5.63
2-1/2	2.50 (4)	2.75	3.88	6.50
3	3.10	3.63	4.75	6.88
3-1/2*	—	4.13	5.25	7.38
4	3.85	4.63	5.88	8.25
4-1/2*	—	5.31	6.50	9.13
5	4.90	5.63	7.00	10.00
6	5.80	6.75	8.25	11.13
8	7.75	8.50	10.13	13.88
10	9.69	10.50	12.25	17.13
12	11.50 (5)	12.75	14.50	20.50
14	12.63 (5)	14.25	15.75	22.75
16	14.50 (5)	16.00	18.00	25.25
18	16.75 (5)	18.25	20.50	27.75
20	18.75 (5)	20.25	22.50	29.75
24	22.75 (5)	24.25	26.75	35.50

Class 2500

Size NPS	Inner Ring	Sealing Element		Outer Ring
	Inside (A) Diameter	Inside (B) Diameter	Outside (C) Diameter	Outside (D) Diameter
1/2	0.56	0.75	1.25	2.75
3/4	0.81	1.00	1.56	3.00
1	1.06	1.25	1.88	3.38
1-1/4	1.31 (4)	1.56	2.38	4.13
1-1/2	1.63 (4)	1.88	2.75	4.63
2	2.06 (4)	2.31	3.38	5.75
2-1/2	2.50 (4)	2.75	3.88	6.63
3	3.10	3.63	4.75	7.75
4	3.85 (5)	4.63	5.88	9.25
5	4.90 (5)	5.63	7.00	11.00
6	5.80 (5)	6.75	8.25	12.50
8	7.75 (5)	8.50	10.13	15.25
10	9.69 (5)	10.63	12.25	18.75
12	11.50 (5)	12.50	14.50	21.63

* ASME B16.20 does not include dimensions for NPS 1/4, 3-1/2 or 4-1/2, or Class 400 flanges up to NPS 3 and Class 900 flanges up to NPS 2-1/2.
Dimensions in inches.

Notes:

1. Inner rings are required for all PTFE gaskets and for Class 900 gaskets, NPS 24; Class 1500 gaskets, NPS 12 through NPS 24; and Class 2500 gaskets, NPS 4 through NPS 12 (see ASME B16.20 code, 3.2.5).
2. The gasket outside diameter tolerance for NPS 1/2 through NPS 8 is ± 0.03 "; for NPS 10 through NPS 24, $+0.06$ ", -0.03 ".
3. The gasket inside diameter tolerance for NPS 1/2 through NPS 8 is ± 0.016 "; for NPS 10 through NPS 24, ± 0.03 ".
4. The centering ring outside diameter tolerance is ± 0.03 ".
5. There are no Class 400 flanges in NPS 1/2 through NPS 3 (use Class 600), Class 900 flanges in NPS 1/2 through NPS 2-1/2 (use Class 1500), or Class 2500 flanges NPS 14 and larger.

WARNING:

Properties/applications shown throughout this brochure are typical. Your specific application should not be undertaken without independent study and evaluation for suitability. For specific application recommendations consult Garlock. Failure to select the proper sealing products could result in property damage and/or serious personal injury.

Performance data published in this brochure has been developed from field testing, customer field reports and/or in-house testing.

While the utmost care has been used in compiling this brochure, we assume no responsibility for errors. Specifications subject to change without notice. This edition cancels all previous issues. Subject to change without notice.

Styles RW, RWI Dimensions 22-60" Series A Flanges

ASME B16.20 Gaskets for ASME B16.47 Series A Flanges (MSS SP-44)

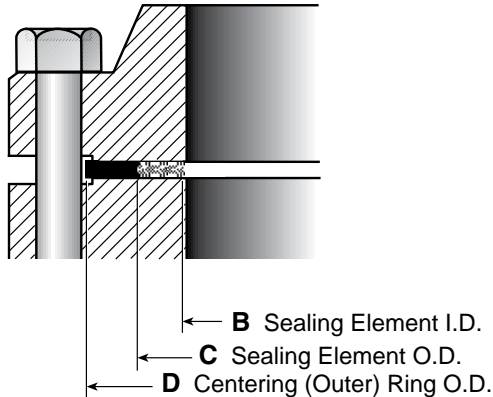

Class 150

Size NPS	Inner Ring	Sealing Element		Outer Ring
	Inside (A) Diameter	Inside (B) Diameter	Outside (C) Diameter	Outside (D) Diameter
22*	—	22.75	24.00	26.00
26	25.75	26.50	27.75	30.50
28	27.75	28.50	29.75	32.75
30	29.75	30.50	31.75	34.75
32	31.75	32.50	33.88	37.00
34	33.75	34.50	35.88	39.00
36	35.75	36.50	38.13	41.25
38	37.75	38.50	40.13	43.75
40	39.75	40.50	42.13	45.75
42	41.75	42.50	44.25	48.00
44	43.75	44.50	46.38	50.25
46	45.75	46.50	48.38	52.25
48	47.75	48.50	50.38	54.50
50	49.75	50.50	52.50	56.50
52	51.75	52.50	54.50	58.75
54	53.50	54.50	56.50	61.00
56	55.50	56.50	58.50	63.25
58	57.50	58.50	60.50	65.50
60	59.50	60.50	62.50	67.50

Class 300

Size NPS	Inner Ring	Sealing Element		Outer Ring
	Inside (A) Diameter	Inside (B) Diameter	Outside (C) Diameter	Outside (D) Diameter
22*	—	22.75	24.75	27.75
26	25.75	27.00	29.00	32.88
28	27.75	29.00	31.00	35.38
30	29.75	31.25	33.25	37.50
32	31.75	33.50	35.50	39.63
34	33.75	35.50	37.50	41.63
36	35.75	37.63	39.63	44.00
38	37.50	38.50	40.00	41.50
40	39.50	40.25	42.13	43.88
42	41.50	42.25	44.13	45.88
44	43.50	44.50	46.50	48.00
46	45.38	46.38	48.38	50.13
48	47.63	48.63	50.63	52.13
50	49.00	51.00	53.00	54.25
52	52.00	53.00	55.00	56.25
54	53.25	55.25	57.25	58.75
56	55.25	57.25	59.25	60.75
58	57.00	59.50	61.50	62.75
60	60.00	61.50	63.50	64.75

Class 400

Size NPS	Inner Ring	Sealing Element		Outer Ring
	Inside (A) Diameter	Inside (B) Diameter	Outside (C) Diameter	Outside (D) Diameter
22*	—	22.75	24.75	27.63
26	26.00	27.00	29.00	32.75
28	28.00	29.00	31.00	35.13
30	29.75	31.25	33.25	37.25
32	32.00	33.50	35.50	39.50
34	34.00	35.50	37.50	41.50
36	36.13	37.63	39.63	44.00
38	37.50	38.25	40.25	42.25
40	39.38	40.38	42.38	44.38
42	41.38	42.38	44.38	46.38
44	43.50	44.50	46.50	48.50
46	46.00	47.00	49.00	50.75
48	47.50	49.00	51.00	53.00
50	49.50	51.00	53.00	55.25
52	51.50	53.00	55.00	57.25
54	53.25	55.25	57.25	59.75
56	55.25	57.25	59.25	61.75
58	57.25	59.25	61.25	63.75
60	59.75	61.75	63.75	66.25

Notes:

1. Inner rings are required for all PTFE gaskets and for Class 900 gaskets, NPS 26 through NPS 48 (see ASME B16.20 code, 3.2.5).
2. The gasket inside diameter tolerance for NPS 26 through NPS 34 is ± 0.03 "; for NPS 36 through NPS 60 is ± 0.05 ".
3. The gasket outside diameter tolerance for NPS 26 through NPS 60 is ± 0.06 ".
4. The centering ring outside diameter tolerance is ± 0.03 ".
5. There are no Class 900 flanges in NPS 50 and larger.

Styles RW, RWI Dimensions 22-60" Series A Flanges

ASME B16.20 Gaskets for ASME B16.47 Series A Flanges (MSS SP-44)

Class 600

Size NPS	Inner Ring	Sealing Element		Outer Ring
	Inside (A) Diameter	Inside (B) Diameter	Outside (C) Diameter	Outside (D) Diameter
22*	—	22.75	24.75	28.88
26	25.50	27.00	29.00	34.13
28	27.50	29.00	31.00	36.00
30	29.75	31.25	33.25	38.25
32	32.00	33.50	35.50	40.25
34	34.00	35.50	37.50	42.25
36	36.13	37.63	39.63	44.50
38	37.50	39.00	41.00	43.50
40	39.75	41.25	43.25	45.50
42	42.00	43.50	45.50	48.00
44	43.75	45.75	47.75	50.00
46	45.75	47.75	49.75	52.25
48	48.00	50.00	52.00	54.75
50	50.00	52.00	54.00	57.00
52	52.00	54.00	56.00	59.00
54	54.25	56.25	58.25	61.25
56	56.25	58.25	60.25	63.50
58	58.00	60.50	62.50	65.50
60	60.25	62.75	64.75	68.25

Class 900

Size NPS	Inner Ring	Sealing Element		Outer Ring
	Inside (A) Diameter	Inside (B) Diameter	Outside (C) Diameter	Outside (D) Diameter
22*	—	24.25	27.00	33.00
26	26.00	27.00	29.00	34.75 ⁽¹⁾
28	28.00	29.00	31.00	37.25 ⁽¹⁾
30	30.25	31.25	33.25	39.75 ⁽¹⁾
32	32.00	33.50	35.50	42.25 ⁽¹⁾
34	34.00	35.50	37.50	44.75 ⁽¹⁾
36	36.25	37.75	39.75	47.25 ⁽¹⁾
38	39.75	40.75	42.75	47.25 ⁽¹⁾
40	41.75	43.25	45.25	49.25 ⁽¹⁾
42	43.75	45.25	47.25	51.25 ⁽¹⁾
44	45.50	47.50	49.50	53.88 ⁽¹⁾
46	48.00	50.00	52.00	56.50 ⁽¹⁾
48	50.00	52.00	54.00	58.50 ⁽¹⁾

Notes:

1. Inner rings are required for all PTFE gaskets and for Class 900 gaskets, NPS 26 through NPS 48 (see ASME B16.20 code, 3.2.5).
2. The gasket inside diameter tolerance for NPS 26 through NPS 34 is ± 0.03 "; for NPS 36 through NPS 60 is ± 0.05 ".
3. The gasket outside diameter tolerance for NPS 26 through NPS 60 is ± 0.06 ".
4. The centering ring outside diameter tolerance is ± 0.03 ".
5. There are no Class 900 flanges in NPS 50 and larger.

WARNING:

Properties/applications shown throughout this brochure are typical. Your specific application should not be undertaken without independent study and evaluation for suitability. For specific application recommendations consult Garlock. Failure to select the proper sealing products could result in property damage and/or serious personal injury.

Performance data published in this brochure has been developed from field testing, customer field reports and/or in-house testing.

While the utmost care has been used in compiling this brochure, we assume no responsibility for errors. Specifications subject to change without notice. This edition cancels all previous issues. Subject to change without notice.

Styles RW, RWI Dimensions 26-60" Series B Flanges

ASME B16.20 Gaskets for ASME B16.47 Series B Flanges (API-605)

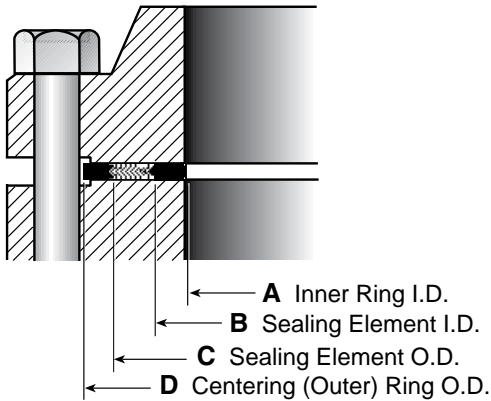

Notes:

1. Inner rings are required for all PTFE gaskets and for Class 900 gaskets, NPS 26 through NPS 48 (see ASME B16.20 code, 3.2.5).
2. The gasket inside diameter tolerance for NPS 26 through NPS 34 is ± 0.03 "; for NPS 36 through NPS 60 is ± 0.05 ".
3. The gasket outside diameter tolerance for NPS 26 through NPS 60 is ± 0.06 ".
4. The centering ring outside diameter tolerance is ± 0.03 ".
5. There are no Class 900 flanges in NPS 50 and larger.

Class 75

Large Diameter Weld Neck Flanges

Size NPS	Sealing Element		Outer Ring
	Inside (B) Diameter	Outside (C) Diameter	Outside (D) Diameter
26	26.25	27.00	27.88
28	28.25	29.13	29.88
30	30.25	31.13	31.88
32	32.25	33.13	33.88
34	34.25	35.13	35.88
36	36.25	37.25	38.31
38	38.25	39.31	40.31
40	40.25	41.31	42.31
42	42.25	43.25	44.31
44	44.25	45.50	46.50
46	46.25	47.50	48.50
48	48.38	49.50	50.50
50	50.25	51.50	52.50
52	52.38	53.63	54.63
54	54.38	55.63	56.63
56	56.50	57.88	58.88
58	58.50	59.88	60.88
60	60.50	61.75	62.88

Class 150

Size NPS	Inner Ring	Sealing Element		Outer Ring
	Inside (A) Diameter	Inside (B) Diameter	Outside (C) Diameter	Outside (D) Diameter
26	25.75	26.50	27.50	28.56
28	27.75	28.50	29.50	30.56
30	29.75	30.50	31.50	32.56
32	31.75	32.50	33.50	34.69
34	33.75	34.50	35.75	36.81
36	35.75	36.50	37.75	38.88
38	37.75	38.37	39.75	41.13
40	39.75	40.25	41.88	43.13
42	41.75	42.50	43.88	45.13
44	43.75	44.25	45.88	47.13
46	45.75	46.50	48.19	49.44
48	47.75	48.50	50.00	51.44
50	49.75	50.50	52.19	53.44
52	51.75	52.50	54.19	55.44
54	53.75	54.50	56.00	57.63
56	56.00	56.88	58.18	59.63
58	58.19	59.07	60.19	62.19
60	60.44	61.31	62.44	64.19

Class 300

Size NPS	Inner Ring	Sealing Element		Outer Ring
	Inside (A) Diameter	Inside (B) Diameter	Outside (C) Diameter	Outside (D) Diameter
26	25.75	26.50	28.00	30.38
28	27.75	28.50	30.00	32.50
30	29.75	30.50	32.00	34.88
32	31.75	32.50	34.00	37.00
34	33.75	34.50	36.00	39.13
36	35.75	36.50	38.00	41.25
38	38.25	39.75	41.25	43.25
40	40.25	41.75	43.25	45.25
42	42.75	43.75	45.25	47.25
44	44.25	45.75	47.25	49.25
46	46.38	47.88	49.38	51.88
48	48.50	49.75	51.63	53.88
50	49.88	51.88	53.38	55.88
52	51.88	53.88	55.38	57.88
54	53.75	55.25	57.25	60.25
56	56.25	58.25	60.00	62.75
58	58.44	60.44	61.94	65.19
60	61.31	62.56	64.19	67.19

Styles RW, RWI Dimensions 26-60" Series B Flanges

ASME B16.20 Gaskets for ASME B16.47 Series B Flanges (API-605)

Class 400

Size NPS	Inner Ring	Sealing Element		Outer Ring
	Inside (A) Diameter	Inside (B) Diameter	Outside (C) Diameter	Outside (D) Diameter
26	25.75	26.25	27.50	29.38
28	27.63	28.13	29.50	31.50
30	29.63	30.13	31.75	33.75
32	31.50	32.00	33.88	35.88
34	33.50	34.13	35.88	37.88
36	35.38	36.13	38.00	40.25
38	37.50	38.25	40.25	42.25
40	39.38	40.38	42.38	44.38
42	41.38	42.38	44.38	46.38
44	43.50	44.50	46.50	48.50
46	46.00	47.00	49.00	50.75
48	47.50	49.00	51.00	53.00
50	49.50	51.00	53.00	55.25
52	51.50	53.00	55.00	57.25
54	53.25	55.25	57.25	59.75
56	55.25	57.25	59.25	61.75
58	57.25	59.25	61.25	63.75
60	59.75	61.75	63.75	66.25

Class 600

Size NPS	Inner Ring	Sealing Element		Outer Ring
	Inside (A) Diameter	Inside (B) Diameter	Outside (C) Diameter	Outside (D) Diameter
26	25.38	26.13	28.13	30.13
28	27.25	27.75	29.75	32.25
30	29.63	30.63	32.63	34.63
32	31.25	32.75	34.75	36.75
34	33.50	35.00	37.00	39.25
36	35.50	37.00	39.00	41.25
38	37.50	39.00	41.00	43.50
40	39.75	41.25	43.25	45.50
42	42.00	43.50	45.50	48.00
44	43.75	45.75	47.75	50.00
46	45.75	47.75	49.75	52.25
48	48.00	50.00	52.00	54.75
50	50.00	52.00	54.00	57.00
52	52.00	54.00	56.00	59.00
54	54.25	56.25	58.25	61.25
56	56.25	58.25	60.25	63.50
58	58.00	60.50	62.50	65.50
60	60.25	62.75	64.75	68.25

Class 900

Size NPS	Inner Ring	Sealing Element		Outer Ring
	Inside (A) Diameter	Inside (B) Diameter	Outside (C) Diameter	Outside (D) Diameter
26	26.25 ⁽¹⁾	27.25	29.50	33.00
28	28.25 ⁽¹⁾	29.25	31.50	35.50
30	30.75 ⁽¹⁾	31.75	33.75	37.75
32	33.00 ⁽¹⁾	34.00	36.00	40.00
34	35.25 ⁽¹⁾	36.25	38.25	42.25
36	36.25 ⁽¹⁾	37.25	39.25	44.25
38	39.75 ⁽¹⁾	40.75	42.75	47.25
40	41.75 ⁽¹⁾	43.25	45.25	49.25
42	43.75 ⁽¹⁾	45.25	47.25	51.25
44	45.50 ⁽¹⁾	47.50	49.50	53.88
46	48.00 ⁽¹⁾	50.00	52.00	56.50
48	50.00 ⁽¹⁾	52.00	54.00	58.50

Notes:

1. Inner rings are required for all PTFE gaskets and for Class 900 gaskets, NPS 26 through NPS 48 (see ASME B16.20 code, 3.2.5).
2. The gasket inside diameter tolerance for NPS 26 through NPS 34 is ± 0.03 "; for NPS 36 through NPS 60 is ± 0.05 ".
3. The gasket outside diameter tolerance for NPS 26 through NPS 60 is ± 0.06 ".
4. The centering ring outside diameter tolerance is ± 0.03 ".
5. There are no Class 900 flanges in NPS 50 and larger.

WARNING:

Properties/applications shown throughout this brochure are typical. Your specific application should not be undertaken without independent study and evaluation for suitability. For specific application recommendations consult Garlock. Failure to select the proper sealing products could result in property damage and/or serious personal injury.

Performance data published in this brochure has been developed from field testing, customer field reports and/or in-house testing.

While the utmost care has been used in compiling this brochure, we assume no responsibility for errors. Specifications subject to change without notice. This edition cancels all previous issues. Subject to change without notice.

Style RW Dimensions Other Large Diameter Flanges, 26-96"

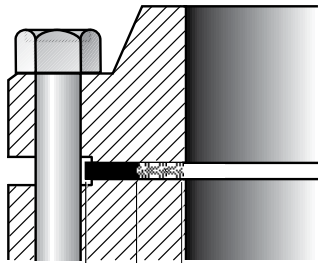

← B Sealing Element I.D.
← C Sealing Element O.D.
← D Centering (Outer) Ring O.D.

Class 75 Slip-On and Blind

Size NPS	Sealing Element		Outer Ring
	Inside (B) Diameter	Outside (C) Diameter	Outside (D) Diameter
26	27.00	28.25	30.13
28	29.00	30.25	32.13
30	31.00	32.25	34.13
32	33.13	34.38	36.38
34	35.13	36.50	38.38
36	37.13	38.50	40.38
42	43.25	44.75	46.63
48	49.25	50.88	52.63
54	55.38	57.75	59.13
60	61.38	63.38	65.13
66	67.50	69.50	71.75
72	73.50	75.50	77.75

Class 75 Weld Neck and Blind

Size NPS	Sealing Element		Outer Ring
	Inside (B) Diameter	Outside (C) Diameter	Outside (D) Diameter
26	26.50	27.75	28.75
28	28.50	29.75	30.75
30	30.50	31.75	32.75
32	32.50	33.75	35.13
34	34.50	35.88	37.13
36	36.50	37.88	39.13
42	42.50	44.00	45.63
48	48.50	50.13	51.63
54	54.50	56.38	57.88
60	60.50	62.50	63.88
66	66.50	68.50	70.25
72	72.50	74.50	76.25

Class 125

Size NPS	Sealing Element		Outer Ring
	Inside (B) Diameter	Outside (C) Diameter	Outside (D) Diameter
22	22.75	24.00	26.00
26	26.50	27.75	30.50
28	28.50	29.75	32.75
30	30.50	31.75	34.75
32	32.50	33.88	37.00
34	34.50	35.88	39.00
36	36.50	38.13	41.25
38	38.50	40.13	43.75
40	40.50	42.13	45.75
42	42.50	44.25	48.00
44	44.50	46.38	50.25
46	46.50	48.38	52.25
48	48.50	50.38	54.50
50	50.50	52.50	56.50
52	52.50	54.50	58.75
54	54.50	56.50	61.00
60	60.50	62.50	67.50
66	71.00	72.75	74.25
72	77.50	79.25	80.75
84	90.25	92.00	93.50
96	103.00	104.75	106.25

Style RW Dimensions Other Large Diameter Flanges, 26-96"

Class 175

Size NPS	Sealing Element		Outer Ring
	Inside (B) Diameter	Outside (C) Diameter	Outside (D) Diameter
26	26.50	27.75	29.13
28	28.50	29.75	31.13
30	30.50	31.75	33.38
32	32.50	33.75	35.38
34	34.50	35.88	37.50
36	36.50	37.88	39.50
38	38.50	39.88	41.50
40	40.50	42.00	43.50
42	42.50	44.00	45.88
44	44.50	46.00	47.88
46	46.50	48.00	49.88
48	48.50	50.13	51.88
50	50.50	52.25	53.88
52	52.50	54.38	56.13
54	54.50	56.75	58.13
60	60.50	62.50	64.13
66	67.88	68.88	70.13
72	73.38	75.13	76.63
84	87.00	88.75	90.25
96	99.00	100.75	102.25

Class 250

Size NPS	Sealing Element		Outer Ring
	Inside (B) Diameter	Outside (C) Diameter	Outside (D) Diameter
26	26.50	27.75	32.75
28	28.50	29.75	35.25
30	30.50	31.75	37.50
32	32.50	33.88	39.75
34	34.50	35.88	41.75
36	36.50	38.13	44.00
38	38.50	40.13	46.00
40	40.50	42.13	48.25
42	42.50	44.25	50.75
44	44.50	46.38	53.00
46	46.50	48.38	55.25
48	48.50	50.38	58.75

Class 350

Size NPS	Sealing Element		Outer Ring
	Inside (B) Diameter	Outside (C) Diameter	Outside (D) Diameter
26	26.50	27.75	29.63
28	28.50	29.75	31.63
30	30.50	31.75	33.88
32	32.50	33.88	35.88
34	34.50	35.88	37.88
36	36.50	38.13	40.38
38	38.50	40.13	42.38
40	40.50	42.13	44.38
42	42.50	44.25	46.63
44	44.50	46.38	49.00
46	46.50	48.38	51.00
48	48.50	50.38	53.00
52	52.50	54.50	57.38
54	54.50	56.50	59.38
60	60.50	62.50	65.38
66	66.50	68.50	72.50
72	72.25	77.00	78.50
84	88.38	90.13	91.63
96	100.75	102.50	104.00





WARNING:

Properties/applications shown throughout this brochure are typical. Your specific application should not be undertaken without independent study and evaluation for suitability. For specific application recommendations consult Garlock. Failure to select the proper sealing products could result in property damage and/or serious personal injury.

Performance data published in this brochure has been developed from field testing, customer field reports and/or in-house testing.

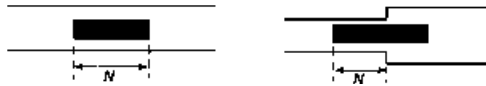
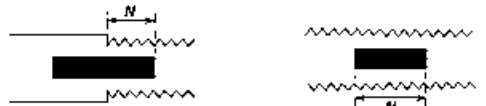
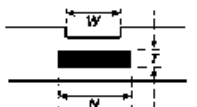
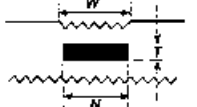
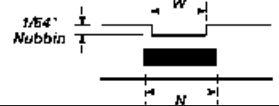
While the utmost care has been used in compiling this brochure, we assume no responsibility for errors. Specifications subject to change without notice. This edition cancels all previous issues. Subject to change without notice.

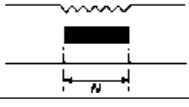
Effective Gasket Seating Width

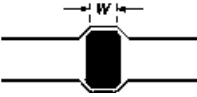
Flange and Gasket Diagram	Basic Gasket Seating Width, B_0	
	Column 1 (Solid flat metal and ring joint gaskets)	Column 2 (Spiral wound, metal jacketed, corrugated metal, grooved metal gaskets)
1a 	$\frac{N}{2}$	$\frac{N}{2}$
1b* 		
1c  $W \leq N$	$\frac{W+T}{2}, \left[\frac{W+N}{4} \text{ max.} \right]$	$\frac{W+T}{2}, \left[\frac{W+N}{4} \text{ max.} \right]$
1d*  $W \leq N$		
2  $W \leq N$	$\frac{W+N}{4}$	$\frac{W+3N}{8}$
3  $W \leq N$	$\frac{N}{4}$	$\frac{3N}{8}$
4* 	$\frac{3N}{8}$	$\frac{7N}{16}$
5* 	$\frac{N}{4}$	$\frac{3N}{8}$
6 	$\frac{W}{8}$	

N = Width of gasket

W = Width of contact area
(raised face or serrations)

T = Thickness of gasket

B_0 = Basic seating width of gasket

B_1 = Effective seating width of gasket

$$B_1 = B_0 \text{ if } B_0 \leq 1/4'';$$

$$B_1 = (\sqrt{B_0})/2 \text{ if } B_0 > 1/4''$$

H_G = Gasket load reaction force

G = Diameter of gasket load reaction force

h_G = Distance from G to bolt circle diameter

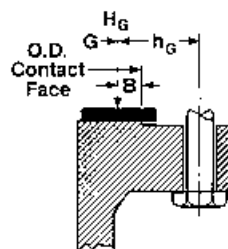

For $B_0 > 1/4''$

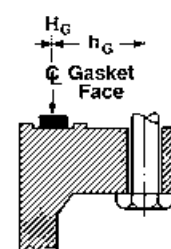

For $B_0 \leq 1/4''$

Gasket Factors "M" and "Y"

"M" and "Y" data are to be used for flange designs only as specified in the ASME Boiler and Pressure Vessel Code Division 1, Section VIII, Appendix 2. They are not meant to be used as gasket seating stress values in actual service. Our bolt torque tables give that information and should be used as such.

"M" - Maintenance Factor

A factor that provides the additional preload needed in the flange fasteners to maintain the compressive load on a gasket after internal pressure is applied to a joint.











$$M = (W - A_2P) / A_1P$$

Where: W = Total Fastener force (lb. or N)
 A_2 = Inside area of gasket (in.² or mm²)
 P = Test pressure (psig or N/mm²)
 A_1 = Gasket area (in.² or mm²)

"Y" - Minimum Design Seating Stress

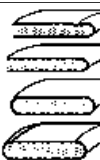
The minimum compressive stress in pounds per square inch (or bar) on the contact area of the gasket that is required to provide a seal at an internal pressure of 2 psig (0.14 bar).

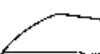
$$Y = W / A_1$$

Gasket Design	Gasket Material	Gasket Factor "M"	Min. Design Seating Stress "Y" (psi)
Spiral wound metal, non-asbestos filled 	Stainless steel or MONEL®	3.00	10,000
Garlock CONTROLLED DENSITY® flexible graphite-filled spiral wound 	Stainless steel or MONEL®	3.00	7,500
Garlock EDGE® 	Stainless steel or MONEL®	2.00	5,000
Garlock GRAPHONIC® 	Stainless steel and flexible graphite Liquid service:	2.00 (1/16") 9.00 (1/8") 2.00	2,000 (1/16") 3,000 (1/8") 900
Corrugated metal, non-asbestos or Corrugated metal-jacketed, non-asbestos filled 	Soft aluminum Soft copper or brass Iron or soft steel MONEL® or 4%-6% chrome Stainless steel	2.50 2.75 3.00 3.25 3.50	2,900 3,700 4,500 5,500 6,500
Corrugated metal 	Soft aluminum Soft copper or brass Iron or soft steel MONEL® or 4%-6% chrome Stainless steel	2.75 3.00 3.25 3.50 3.75	3,700 4,500 5,500 6,500 7,600
Flat metal-jacketed, non-asbestos filled 	Soft aluminum Soft copper or brass Iron or soft steel MONEL® 4%-6% chrome Stainless steel	3.25 3.50 3.75 3.50 3.75 3.75	5,500 6,500 7,600 8,000 9,000 9,000
Grooved metal 	Soft aluminum Soft copper or brass Iron or soft steel MONEL® or 4%-6% chrome Stainless steel	3.25 3.50 3.75 3.75 4.25	5,500 6,500 7,600 9,000 10,100
Solid flat metal 	Soft aluminum Soft copper or brass Iron or soft steel MONEL® or 4%-6% chrome Stainless steel	4.00 4.75 5.50 6.00 6.50	8,800 13,000 18,000 21,800 26,000
Ring joint 	Iron or soft steel MONEL® or 4%-6% chrome Stainless steel	5.50 6.00 6.50	18,000 21,800 26,000

This table lists many commonly used gasket materials and contact facings with suggested design values of "M" and "Y" that generally have proven satisfactory in actual service when using effective gasket seating width B_1 , described in the formula on page D-32. The design values and other details given in this table are suggested only and are not mandatory.

MONEL® is a registered trademark of International Nickel.

Calculating Load Requirements

Two formulas that define the minimum load required to effect a seal on a particular gasket are Wm1 and Wm2. When these formulas have been calculated, the larger load of the two is the load necessary to effect a seal.

Let:

$\pi = 3.14$

P = Maximum internal pressure

M = Gasket factor "M" defined on page D-33.
(M = 3 for spiral wound gaskets)

Y = Seating stress "Y" defined on page D-33.
(Y = 10,000 psi for spiral wound gaskets)

N = Basic width of a gasket per chart on page D-32.
(For raised face flanges see diagram 1a)

B_0 = Basic seating width of a gasket per chart on page D-32. (For raised face flanges, $B_0 = N/2$)

B_1 = Effective seating width of a gasket; must be determined.

ID = Inside diameter of gasket

OD = Outside diameter of gasket
For gaskets where the raised face is smaller than the OD of the gasket face, the OD is equal to the outer diameter of the raised face.

Find:

ID = _____

OD = _____

Given the ID and OD, find the value of N. Then define B_0 in terms of N (See page D-32):

N = _____

B_0 = _____

Determine if B_0 is greater or less than 1/4", then find B_1 :

If $B_0 \leq 1/4"$, then $B_1 = B_0$;

If $B_0 > 1/4"$, then $B_1 = (\sqrt{B_0})/2$

$B_1 =$ _____

Using B_1 , determine G:

$G = OD - [(B_1)(2)]$

Now, insert these values in the final equations to determine minimum required load:

Wm1 = $[\pi (P)(G^2)/4] + [2(B_1)(\pi)(G)(M)(P)]$
Wm2 = $\pi (B_1)(G)(Y)$

When Wm1 and Wm2 have been calculated, the larger of the two numbers is the minimum load required to seat a gasket. In most cases the available bolt load in a connection is greater than the minimum load on the gasket. If not, higher bolt stresses or changes in the gasket design are required for an effective seal.

Note:

Flange design code suggestions for low pressure applications calling for minimum seating stress (Y value) are sometimes inadequate to seat the gasket because the bolting and flange rigidity are insufficient to effect a proper seal. Care should be taken to ensure that flange conditions provide a suitable seating surface. For internal pressures to be contained, flange rotation and sufficient residual loads must also be considered in the flange design.

Torque Tables

These tables were developed to be used with Garlock spiral wound gaskets. They are to be used only as a general guide. They should not be considered to contain absolute values due to the large number of uncontrollable variables involved with bolted joints. If there is doubt as to the proper torque value to use, we suggest that the maximum value be used.

All bolt torque values are based upon the use of new nuts (ASTM A194, GR 2H) and new bolts (ASTM A193, GR B7) of proper design, acceptable quality and approved materials of construction as well as metallurgy. It is also required that two hardened steel washers be used under the head of each nut and that a non-metallic based lubricant (i.e. oil and graphite) be used on the nuts, bolts and washers.

The flanges are assumed to be in good condition and in compliance with ASME B16.5 specifications. Special attention should be given to seating surface finish and flatness.

Only torque wrenches that have been calibrated should be used. The proper bolt tightening pattern must be followed (see installation section on page D-42 for proper bolting pattern) with the desired ultimate torque value arrived at in a minimum of three equal increments. All bolts in the flange should then be checked in consecutive order in a counterclockwise direction.

The contact dimensions listed are taken from the ID and OD of the windings, which are different from the ASME ring gasket dimensions.

No provisions have been made in these tables to account for vibration effects on the bolts. These tables are based on ambient conditions, without compensation for elevated temperatures. If conditions different from these exist, we suggest that further analysis be performed to determine the appropriate torque values.

WARNING:

Properties/applications shown throughout this brochure are typical. Your specific application should not be undertaken without independent study and evaluation for suitability. For specific application recommendations consult Garlock. Failure to select the proper sealing products could result in property damage and/or serious personal injury.

Performance data published in this brochure has been developed from field testing, customer field reports and/or in-house testing.

While the utmost care has been used in compiling this brochure, we assume no responsibility for errors. Specifications subject to change without notice. This edition cancels all previous issues. Subject to change without notice.

Torque Tables

For Spiral Wound Gaskets, ASME B16.5

Class 150

Nom. Pipe Size (inches)	Gsk. ID Contact (inches)	Gsk. OD Contact (inches)	Gsk. Area Contact (Sq. in.)	No. of Bolts	Size of Bolts (inches)	Max. Torque per Bolts @ 60 ksi Bolt Stress (ft lb)	Comp. per Bolt @ 60K (ft lb)	Max. Gsk. Comp. Available (psi)	Min. Gsk. Comp. Recomm. (psi)	Minimum Torque per Bolt (ft lb)	Max. Gsk. Comp. Recomm. Avail. (psi)	Prefer'd Torque (ft lb)
0.5	0.75	1.25	0.79	4	0.50	60	7,560	38,503	10,000	16	30,000	47
0.75	1.00	1.56	1.13	4	0.50	60	7,560	26,712	10,000	22	26,712	60
1	1.25	1.88	1.53	4	0.50	60	7,560	19,713	10,000	30	19,713	60
1.25	1.88	2.38	1.67	4	0.50	60	7,560	18,119	10,000	33	18,119	60
1.5	2.13	2.75	2.39	4	0.50	60	7,560	12,637	10,000	47	12,637	60
2	2.75	3.38	3.01	4	0.63	120	12,120	16,125	10,000	74	16,125	120
2.5	3.25	3.88	3.50	4	0.63	120	12,120	13,861	10,000	87	13,861	120
3	4.00	4.75	5.15	4	0.63	120	12,120	9,406	9,406	120	9,406	120
4	5.00	5.88	7.47	8	0.63	120	12,120	12,974	10,000	92	12,974	120
5	6.13	7.00	9.02	8	0.75	200	18,120	16,071	10,000	124	16,071	200
6	7.19	8.25	12.88	8	0.75	200	18,120	11,253	10,000	178	11,253	200
8	9.19	10.38	18.25	8	0.75	200	18,120	7,945	7,945	200	7,945	200
10	11.31	12.50	22.21	12	0.88	320	25,140	13,584	10,000	236	13,584	320
12	13.38	14.75	30.37	12	0.88	320	25,140	9,933	9,933	320	9,933	320
14	14.63	16.00	33.07	12	1.00	490	33,060	11,995	10,000	408	11,995	490
16	16.63	18.25	44.51	16	1.00	490	33,060	11,884	10,000	412	11,884	490
18	18.69	20.75	63.88	16	1.13	710	43,680	10,940	10,000	649	10,940	710
20	20.69	22.75	70.36	20	1.13	710	43,680	12,415	10,000	572	12,415	710
24	24.75	27.00	91.45	20	1.25	1,000	55,740	12,190	10,000	820	12,190	1,000

Class 300

Nom. Pipe Size (inches)	Gsk. ID Contact (inches)	Gsk. OD Contact (inches)	Gsk. Area Contact (Sq. in.)	No. of Bolts	Size of Bolts (inches)	Max. Torque per Bolts @ 60 ksi Bolt Stress (ft lb)	Comp. per Bolt @ 60K (ft lb)	Max. Gsk. Comp. Available (psi)	Min. Gsk. Comp. Recomm. (psi)	Minimum Torque per Bolt (ft lb)	Max. Gsk. Comp. Recomm. Avail. (psi)	Prefer'd Torque (ft lb)
0.5	0.75	1.25	0.79	4	0.50	60	7,560	38,522	10,000	16	30,000	47
0.75	1.00	1.56	1.13	4	0.63	120	12,120	43,079	10,000	28	30,000	84
1	1.25	1.88	1.55	4	0.63	120	12,120	31,319	10,000	38	30,000	115
1.25	1.88	2.38	1.67	4	0.63	120	12,120	28,994	10,000	41	28,994	120
1.5	2.13	2.75	2.38	4	0.75	200	18,120	30,517	10,000	66	30,000	197
2	2.75	3.38	3.03	8	0.63	120	12,120	31,983	10,000	38	30,000	113
2.5	3.25	3.88	3.53	8	0.75	200	18,120	41,110	10,000	49	30,000	146
3	4.00	4.75	5.15	8	0.75	200	18,120	28,139	10,000	71	28,139	200
4	5.00	5.88	7.52	8	0.75	200	18,120	19,287	10,000	104	19,287	200
5	6.13	7.00	8.97	8	0.75	200	18,120	16,166	10,000	124	16,166	200
6	7.19	8.25	12.85	12	0.75	200	18,120	16,925	10,000	118	16,925	200
8	9.19	10.38	18.28	12	0.88	320	25,140	16,502	10,000	194	16,502	320
10	11.31	12.50	22.24	16	1.00	490	33,060	23,782	10,000	206	23,782	490
12	13.38	14.75	30.25	16	1.13	710	43,680	23,102	10,000	307	23,102	710
14	14.63	16.00	32.94	20	1.13	710	43,680	26,520	10,000	268	26,520	710
16	16.63	18.25	44.36	20	1.25	1,000	55,740	25,133	10,000	398	25,133	1,000
18	18.69	20.75	63.78	24	1.25	1,000	55,740	20,975	10,000	477	20,975	1,000
20	20.69	22.75	70.25	24	1.25	1,000	55,740	19,044	10,000	525	19,044	1,000
24	24.75	27.00	91.40	24	1.50	1,600	84,300	22,135	10,000	723	22,135	1,600

Tables are based on the use of bolts with a yield strength of 100,000 psi.

Torque Tables

For Spiral Wound Gaskets, ASME B16.5

Class 400

Nom. Pipe Size (inches)	Gsk. ID Contact (inches)	Gsk. OD Contact (inches)	Gsk. Area Contact (Sq. in.)	No. of Bolts	Size of Bolts (inches)	Max. Torque per Bolts @ 60 ksi Bolt Stress (ft lb)	Comp. per Bolt @ 60K (ft lb)	Max. Gsk. Comp. Available (psi)	Min. Gsk. Comp. Recomm. (psi)	Minimum Torque per Bolt (ft lb)	Max. Gsk. Comp. Recomm. Avail. (psi)	Prefer'd Torque (ft lb)
4	4.75	5.88	9.43	8	0.88	320	25,140	21,329	10,000	150	21,329	320
5	5.81	7.00	11.97	8	0.88	320	25,140	16,807	10,000	190	16,807	320
6	6.88	8.25	16.27	12	0.88	320	25,140	18,540	10,000	173	18,540	320
8	8.88	10.38	22.68	12	1.00	490	33,060	17,493	10,000	280	17,493	490
10	10.81	12.50	30.92	16	1.13	710	43,680	22,600	10,000	314	22,600	710
12	12.88	14.75	40.56	16	1.25	1,000	55,740	21,988	10,000	455	21,988	1,000
14	14.25	16.00	41.56	20	1.25	1,000	55,740	26,826	10,000	373	26,826	1,000
16	16.25	18.25	54.17	20	1.38	1,360	69,300	25,588	10,000	531	25,588	1,360
18	18.50	20.75	69.33	24	1.38	1,360	69,300	23,991	10,000	567	23,991	1,360
20	20.50	22.75	76.39	24	1.50	1,600	84,300	26,485	10,000	604	26,485	1,600
24	24.75	27.00	91.40	24	1.75	3,000	118,800	31,194	10,000	962	30,000	2,885

Class 600

Nom. Pipe Size (inches)	Gsk. ID Contact (inches)	Gsk. OD Contact (inches)	Gsk. Area Contact (Sq. in.)	No. of Bolts	Size of Bolts (inches)	Max. Torque per Bolts @ 60 ksi Bolt Stress (ft lb)	Comp. per Bolt @ 60K (ft lb)	Max. Gsk. Comp. Available (psi)	Min. Gsk. Comp. Recomm. (psi)	Minimum Torque per Bolt (ft lb)	Max. Gsk. Comp. Recomm. Avail. (psi)	Prefer'd Torque (ft lb)
0.5	0.75	1.25	0.79	4	0.50	60	7,560	38,522	10,000	16	30,000	47
0.75	1.00	1.56	1.13	4	0.63	120	12,120	43,079	10,000	28	30,000	84
1	1.25	1.88	1.55	4	0.63	120	12,120	31,319	10,000	38	30,000	115
1.25	1.88	2.38	1.67	4	0.63	120	12,120	28,994	10,000	41	28,994	120
1.5	2.13	2.75	2.38	4	0.75	200	18,120	30,517	10,000	66	30,000	197
2	2.75	3.38	3.03	8	0.63	120	12,120	31,983	10,000	38	30,000	113
2.5	3.25	3.88	3.53	8	0.75	200	18,120	41,110	10,000	49	30,000	146
3	4.00	4.75	5.15	8	0.75	200	18,120	28,139	10,000	71	28,139	200
4	4.75	5.88	9.43	8	0.88	320	25,140	21,329	10,000	150	21,329	320
5	5.81	7.00	11.97	8	1.00	490	33,060	22,102	10,000	222	22,102	490
6	6.88	8.25	16.27	12	1.00	490	33,060	24,381	10,000	201	24,381	490
8	8.88	10.38	22.68	12	1.13	710	43,680	23,112	10,000	307	23,112	710
10	10.81	12.50	30.92	16	1.25	1,000	55,740	28,840	10,000	347	28,840	1,000
12	12.88	14.75	40.56	20	1.25	1,000	55,740	27,486	10,000	364	27,486	1,000
14	14.25	16.00	41.56	20	1.38	1,360	69,300	33,353	10,000	408	30,000	1,223
16	16.25	18.25	54.17	20	1.50	1,600	84,300	31,127	10,000	514	30,000	1,542
18	18.50	20.75	69.33	20	1.63	2,200	100,800	29,080	10,000	757	29,080	2,200
20	20.50	22.75	76.39	24	1.63	2,200	100,800	31,669	10,000	695	30,000	2,084
24	24.75	27.00	91.40	24	1.88	4,000	138,240	36,298	10,000	1,102	30,000	3,306

Tables are based on the use of bolts with a yield strength of 100,000 psi.

WARNING:

Properties/applications shown throughout this brochure are typical. Your specific application should not be undertaken without independent study and evaluation for suitability. For specific application recommendations consult Garlock. Failure to select the proper sealing products could result in property damage and/or serious personal injury.

Performance data published in this brochure has been developed from field testing,

customer field reports and/or in-house testing.

While the utmost care has been used in compiling this brochure, we assume no responsibility for errors. Specifications subject to change without notice. This edition cancels all previous issues. Subject to change without notice.

Torque Tables

For Spiral Wound Gaskets, ASME B16.5

Class 900

Nom. Pipe Size (inches)	Gsk. ID Contact (inches)	Gsk. OD Contact (inches)	Gsk. Area Contact (Sq. in.)	No. of Bolts	Size of Bolts (inches)	Max. Torque per Bolts @ 60 ksi Bolt Stress (ft lb)	Comp. per Bolt @ 60K (ft lb)	Max. Gsk. Comp. Available (psi)	Min. Gsk. Comp. Recomm. (psi)	Minimum Torque per Bolt (ft lb)	Preferred Torque (ft lb)
0.5	0.75	1.25	0.79	4	0.75	200	18,120	92,284	10,000	22	100
0.75	1.00	1.56	1.13	4	0.75	200	18,120	64,024	10,000	31	100
1	1.25	1.88	1.53	4	0.88	320	25,140	65,555	10,000	49	160
1.25	1.88	2.38	1.67	4	0.88	320	25,140	60,253	10,000	53	160
1.5	1.13	2.75	2.39	4	1.00	490	33,060	55,261	10,000	89	266
2	2.75	3.38	3.01	8	0.88	320	25,140	66,893	10,000	48	160
2.5	3.25	3.88	3.50	8	1.00	490	33,060	75,620	10,000	65	245
3	3.75	4.75	6.68	8	0.88	320	25,140	30,126	10,000	106	319
4	4.75	5.88	9.39	8	1.13	710	43,680	37,222	10,000	191	572
5	5.81	7.00	11.95	8	1.25	1,000	55,740	37,316	10,000	268	804
6	6.88	8.25	16.33	12	1.13	710	43,680	32,090	10,000	221	664
8	8.75	10.13	20.38	12	1.38	1,360	69,300	40,798	10,000	333	1,000
10	10.88	12.25	24.97	16	1.38	1,360	69,300	44,400	10,000	306	919
12	12.75	14.50	37.45	20	1.38	1,360	69,300	37,006	10,000	368	1,103
14	14.00	15.75	40.89	20	1.50	1,600	84,300	41,233	10,000	388	1,164
16	16.25	18.00	47.07	20	1.63	2,200	100,800	42,825	10,000	514	1,541
18	18.25	20.50	68.48	20	1.88	4,000	138,240	40,376	10,000	991	2,972
20	20.50	22.50	67.54	20	2.00	4,400	159,120	47,116	10,000	934	2,802
24	24.75	26.75	80.90	20	2.50	8,800	257,520	63,667	10,000	1,382	4,400

Class 1500

Nom. Pipe Size (inches)	Gsk. ID Contact (inches)	Gsk. OD Contact (inches)	Gsk. Area Contact (Sq. in.)	No. of Bolts	Size of Bolts (inches)	Max. Torque per Bolts @ 60 ksi Bolt Stress (ft lb)	Comp. per Bolt @ 60K (ft lb)	Max. Gsk. Comp. Available (psi)	Min. Gsk. Comp. Recomm. (psi)	Minimum Torque per Bolt (ft lb)	Preferred Torque (ft lb)
0.5	0.75	1.25	0.79	4	0.75	200	18,120	92,284	10,000	22	100
0.75	1.00	1.56	1.13	4	0.75	200	18,120	64,024	10,000	31	100
1	1.25	1.88	1.53	4	0.88	320	25,140	65,555	10,000	49	160
1.25	1.56	2.38	2.51	4	0.88	320	25,140	40,021	10,000	80	240
1.5	1.88	2.75	3.18	4	1.00	490	33,060	41,606	10,000	118	353
2	2.31	3.38	4.75	8	0.88	320	25,140	42,376	10,000	76	227
2.5	2.75	3.88	5.85	8	1.00	490	33,060	45,182	10,000	108	325
3	3.63	4.75	7.40	8	1.13	710	43,680	47,222	10,000	150	451
4	4.63	5.88	10.31	8	1.25	1,000	55,740	43,258	10,000	231	694
5	5.63	7.00	13.63	8	1.50	1,600	84,300	49,464	10,000	323	970
6	6.75	8.25	17.67	12	1.38	1,360	69,300	47,059	10,000	289	867
8	8.50	10.13	23.77	12	1.63	2,200	100,800	50,886	10,000	432	1,297
10	10.50	12.25	31.27	12	1.88	4,000	138,240	53,052	10,000	754	2,262
12	12.75	14.50	37.45	16	2.00	4,400	159,120	67,975	10,000	647	2,200
14	14.25	15.75	35.34	16	2.25	6,360	205,380	92,977	10,000	684	3,180
16	16.00	18.00	53.41	16	2.50	8,800	257,520	77,149	10,000	1,141	4,400
18	18.25	20.50	68.48	16	2.75	11,840	315,540	73,728	10,000	1,606	5,920
20	20.25	22.50	75.55	16	3.00	15,440	379,440	80,363	10,000	1,921	7,720
24	24.25	26.75	100.14	16	3.50	26,000	525,000	83,884	10,000	3,100	13,000

Tables are based on the use of bolts with a yield strength of 100,000 psi.

Torque Tables

For Spiral Wound Gaskets, ASME B16.5

Class 2500

Nom. Pipe Size (inches)	Gsk. ID Contact (inches)	Gsk. OD Contact (inches)	Gsk. Area Contact (Sq. in.)	No. of Bolts	Size of Bolts (inches)	Max. Torque per Bolts @ 60 ksi Bolt Stress (ft lb)	Comp. per Bolt @ 60K (ft lb)	Max. Gsk. Comp. Available (psi)	Min. Gsk. Comp. Recomm. (psi)	Minimum Torque per Bolt (ft lb)	Preferred Torque (ft lb)
0.5	0.75	1.25	0.79	4	0.75	200	18,120	92,284	10,000	22	100
0.75	1.00	1.56	1.13	4	0.75	200	18,120	64,024	10,000	31	100
1	1.25	1.88	1.53	4	0.88	320	25,140	65,555	10,000	49	160
1.25	1.56	2.38	2.51	4	1.00	490	33,060	52,629	10,000	93	279
1.5	1.88	2.75	3.18	4	1.13	710	43,680	54,971	10,000	129	387
2	2.31	3.38	4.75	8	1.00	490	33,060	55,725	10,000	88	264
2.5	2.75	3.88	5.85	8	1.13	710	43,680	59,696	10,000	119	357
3	3.63	4.75	7.40	8	1.25	1,000	55,740	60,260	10,000	166	500
4	4.63	5.88	10.31	8	1.50	1,600	84,300	65,423	10,000	245	800
5	5.63	7.00	13.63	8	1.75	3,000	118,800	69,708	10,000	430	1,500
6	6.75	8.25	17.67	8	2.00	4,400	159,120	72,035	10,000	611	2,200
8	8.50	10.13	23.77	12	2.00	4,400	159,120	80,323	10,000	548	2,200
10	10.63	12.25	29.19	12	2.50	8,800	257,520	105,849	10,000	831	4,400
12	12.50	14.50	42.41	12	2.75	11,840	315,540	89,280	10,000	1,326	5,920

Tables are based on the use of bolts with a yield strength of 100,000 psi.

WARNING:

Properties/applications shown throughout this brochure are typical. Your specific application should not be undertaken without independent study and evaluation for suitability. For specific application recommendations consult Garlock. Failure to select the proper sealing products could result in property damage and/or serious personal injury.

Performance data published in this brochure has been developed from field testing, customer field reports and/or in-house testing.

While the utmost care has been used in compiling this brochure, we assume no responsibility for errors. Specifications subject to change without notice. This edition cancels all previous issues. Subject to change without notice.

Torque to Stress Bolts

The torque required to produce a certain stress in bolting is dependent on several conditions, including:

- Diameter and number of threads on bolt
- Condition of nut bearing surfaces
- Lubrication of bolt threads and nut bearing surfaces.

The tables below reflect the results of many tests to determine the relation between torque and bolt stress. Values

are based on steel bolts that have been well-lubricated with a heavy graphite and oil mixture.

A non-lubricated bolt has an efficiency of about 50% of a well-lubricated bolt. Also, different lubricants produce results that vary from 50% to 100% of the tabulated stress figures.

For Alloy Steel Stud Bolts (Load in pounds on stud bolts when torque load is applied)

Nominal Diameter of Bolt (inches)	Number of Threads (per inch)	Diameter at Root of Thread (inches)	Area at Root of Thread (sq. inch)	Stress					
				30,000 psi		45,000 psi		60,000 psi	
				Torque (ft lbs)	Compression (lbs)	Torque (ft lbs)	Compression (lbs)	Torque (ft lbs)	Compression (lbs)
1/4	20	0.185	0.027	4	810	6	1215	8	1620
5/16	18	0.240	0.045	8	1350	12	2025	16	2700
3/8	16	0.294	0.068	12	2040	18	3060	24	4080
7/16	14	0.345	0.093	20	2790	30	4185	40	5580
1/2	13	0.400	0.126	30	3780	45	5670	60	7560
9/16	12	0.454	0.162	45	4860	68	7290	90	9720
5/8	11	0.507	0.202	60	6060	90	9090	120	12120
3/4	10	0.620	0.302	100	9060	150	13590	200	18120
7/8	9	0.731	0.419	160	12570	240	18855	320	25140
1	8	0.838	0.551	245	16530	368	24795	490	33060
1-1/8	8	0.963	0.728	355	21840	533	32760	710	43680
1-1/4	8	1.088	0.929	500	27870	750	41805	1000	55740
1-3/8	8	1.213	1.155	680	34650	1020	51975	1360	69300
1-1/2	8	1.338	1.405	800	42150	1200	63225	1600	84300
1-5/8	8	1.463	1.680	1100	50400	1650	75600	2200	100800
1-3/4	8	1.588	1.980	1500	59400	2250	89100	3000	118800
1-7/8	8	1.713	2.304	2000	69120	3000	103680	4000	138240
2	8	1.838	2.652	2200	79560	3300	119340	4400	159120
2-1/4	8	2.088	3.423	3180	102690	4770	154035	6360	205380
2-1/2	8	2.338	4.292	4400	128760	6600	193140	8800	257520
2-3/4	8	2.588	5.259	5920	157770	8880	236655	11840	315540
3	8	2.838	6.324	7720	189720	11580	264580	15440	379440

For Machine Bolts and Cold Rolled Steel Stud Bolts (Load in pounds on stud bolts when torque load is applied)

Nominal Diameter of Bolt (inches)	Number of Threads (per inch)	Diameter at Root of Thread (inches)	Area at Root of Thread (sq. inch)	Stress					
				7,500 psi		15,000 psi		30,000 psi	
				Torque (ft lbs)	Compression (lbs)	Torque (ft lbs)	Compression (lbs)	Torque (ft lbs)	Compression (lbs)
1/4	20	0.185	0.027	1	203	2	405	4	810
5/16	18	0.240	0.045	2	338	4	675	8	1350
3/8	16	0.294	0.068	3	510	6	1020	12	2040
7/16	14	0.345	0.093	5	698	10	1395	20	2790
1/2	13	0.400	0.126	8	945	15	1890	30	3780
9/16	12	0.454	0.162	12	1215	23	2340	45	4860
5/8	11	0.507	0.202	15	1515	30	3030	60	6060
3/4	10	0.620	0.302	25	2265	50	4530	100	9060
7/8	9	0.731	0.419	40	3143	80	6285	160	12570
1	8	0.838	0.551	62	4133	123	8265	245	16530
1-1/8	7	0.939	0.693	98	5190	195	10380	390	20760
1-1/4	7	1.064	0.890	137	6675	273	13350	545	26700
1-3/8	6	1.158	1.054	183	7905	365	15810	730	31620
1-1/2	6	1.283	1.294	219	9705	437	19410	875	38820
1-5/8	5-1/2	1.389	1.515	300	11363	600	22725	1200	45450
1-3/4	5	1.490	1.744	390	13080	775	26160	1550	52320
1-7/8	5	1.615	2.049	525	15368	1050	30735	2100	61470
2	4-1/2	1.711	2.300	563	17250	1125	34500	2250	69000

Flange and Bolt Dimensions

For Standard Flanges

NPS (inches)	150 psi				300 psi				400 psi				600 psi			
	Dia. of Flange (inches)	No. of Bolts	Dia. of Bolts (Inches)	Bolt Circle (Inches)	Dia. of Flange (Inches)	No. of Bolts	Dia. of Bolts (Inches)	Bolt Circle (Inches)	Dia. of Flange (Inches)	No. of Bolts	Dia. of Bolts (Inches)	Bolt Circle (Inches)	Dia. of Flange (Inches)	No. of Bolts	Dia. of Bolts (Inches)	Bolt Circle (Inches)
1/4	3-3/8	4	1/2	2-1/4	3-3/8	4	1/2	2-1/4	3-3/8	4	1/2	2-1/4	3-3/8	4	1/2	2-1/4
1/2	3-1/2	4	1/2	2-3/8	3-3/4	4	1/2	2-5/8	3-3/4	4	1/2	2-5/8	3-3/4	4	1/2	2-5/8
3/4	3-7/8	4	1/2	2-3/4	4-5/8	4	5/8	3-1/4	4-5/8	4	5/8	3-1/4	4-5/8	4	5/8	3-1/4
1	4-1/4	4	1/2	3-1/8	4-7/8	4	5/8	3-1/2	4-7/8	4	5/8	3-1/2	4-7/8	4	5/8	3-1/2
1-1/4	4-5/8	4	1/2	3-1/2	5-1/4	4	5/8	3-7/8	5-1/4	4	5/8	3-7/8	5-1/4	4	5/8	3-7/8
1-1/2	5	4	1/2	3-7/8	6-1/8	4	3/4	4-1/2	6-1/8	4	3/4	4-1/2	6-1/8	4	3/4	4-1/2
2	6	4	5/8	4-3/4	6-1/2	8	5/8	5	6-1/2	8	5/8	5	6-1/2	8	5/8	5
2-1/2	7	4	5/8	5-1/2	7-1/2	8	3/4	5-7/8	7-1/2	8	3/4	5-7/8	7-1/2	8	3/4	5-7/8
3	7-1/2	4	5/8	6	8-1/4	8	3/4	6-5/8	8-1/4	8	3/4	6-5/8	8-1/4	8	3/4	6-5/8
3-1/2	8-1/2	8	5/8	7	9	8	3/4	7-1/4	9	8	7/8	7-1/4	9	8	7/8	7-1/4
4	9	8	5/8	7-1/2	10	8	3/4	7-7/8	10	8	7/8	7-7/8	10-3/4	8	7/8	8-1/2
5	10	8	3/4	8-1/2	11	8	3/4	9-1/4	11	8	7/8	9-1/4	13	8	1	10-1/2
6	11	8	3/4	9-1/2	12-1/2	12	3/4	10-5/8	12-1/2	12	7/8	10-5/8	14	12	1	11-1/2
8	13-1/2	8	3/4	11-3/4	15	12	7/8	13	15	12	1	13	16-1/2	12	1-1/8	13-3/4
10	16	12	7/8	14-1/4	17-1/2	16	1	15-1/4	17-1/2	16	1-1/8	15-1/4	20	16	1-1/4	17
12	19	12	7/8	17	20-1/2	16	1-1/8	17-3/4	20-1/2	16	1-1/4	17-3/4	22	20	1-1/4	19-1/4
14	21	12	1	18-3/4	23	20	1-1/8	20-1/4	23	20	1-1/4	20-1/4	23-3/4	20	1-3/8	20-3/4
16	23-1/2	16	1	21-1/4	25-1/2	20	1-1/4	22-1/2	25-1/2	20	1-3/8	22-1/2	27	20	1-1/2	23-3/4
18	25	16	1-1/8	22-3/4	28	24	1-1/4	24-3/4	28	24	1-3/8	24-3/4	29-1/4	20	1-5/8	25-3/4
20	27-1/2	20	1-1/8	25	30-1/2	24	1-1/4	27	30-1/2	24	1-1/2	27	32	24	1-5/8	28-1/2
24	32	20	1-1/4	29-1/2	36	24	1-1/2	32	36	24	1-3/4	32	37	24	1-7/8	33

NPS (inches)	900 psi				1500 psi				2500 psi			
	Dia. of Flange (inches)	No. of Bolts	Dia. of Bolts (Inches)	Bolt Circle (Inches)	Dia. of Flange (Inches)	No. of Bolts	Dia. of Bolts (Inches)	Bolt Circle (Inches)	Dia. of Flange (Inches)	No. of Bolts	Dia. of Bolts (Inches)	Bolt Circle (Inches)
1/2	4-3/4	4	3/4	3-1/4	4-3/4	4	3/4	3-1/4	5-1/4	4	3/4	3-1/2
3/4	5-1/8	4	3/4	3-1/2	5-1/8	4	3/4	3-1/2	5-1/2	4	3/4	3-3/4
1	5-7/8	4	7/8	4	5-7/8	4	7/8	4	6-1/4	4	7/8	4-1/4
1-1/4	6-1/4	4	7/8	4-3/8	6-1/4	4	7/8	4-3/8	7-1/4	4	1	5-1/8
1-1/2	7	4	1	4-7/8	7	4	1	4-7/8	8	4	1-1/8	5-3/4
2	8-1/2	8	7/8	6-1/2	8-1/2	8	7/8	6-1/2	9-1/4	8	1	6-3/4
2-1/2	9-5/8	8	1	7-1/2	9-5/8	8	1	7-1/2	10-1/2	8	1-1/8	7-3/4
3	9-1/2	8	7/8	7-1/2	10-1/2	8	1-1/8	8	12	8	1-1/4	9
4	11-1/2	8	1-1/8	9-1/4	12-1/4	8	1-1/4	9-1/2	14	8	1-1/2	10-3/4
5	13-3/4	8	1-1/4	11	14-3/4	8	1-1/2	11-1/2	16-1/2	8	1-3/4	12-3/4
6	15	12	1-1/8	12-1/2	15-1/2	12	1-3/8	12-1/2	19	8	2	14-1/2
8	18-1/2	12	1-3/8	15-1/2	19	12	1-5/8	15-1/2	21-3/4	12	2	17-1/4
10	21-1/2	16	1-3/8	18-1/2	23	12	1-7/8	19	26-1/2	12	2-1/2	21-1/4
12	24	20	1-3/8	21	26-1/2	16	2	22-1/2	30	12	2-3/4	24-3/8
14	25-1/4	20	1-1/2	22	29-1/2	16	2-1/4	25				
16	27-3/4	20	1-5/8	24-1/2	32-1/2	16	2-1/2	27-3/4				
18	31	20	1-7/8	27	36	16	2-3/4	30-1/2				
20	33-3/4	20	2	29-1/2	38-3/4	16	3	32-3/4				
24	41	20	2-1/2	35-1/2	46	16	3-1/2	39				

WARNING:

Properties/applications shown throughout this brochure are typical. Your specific application should not be undertaken without independent study and evaluation for suitability. For specific application recommendations consult Garlock. Failure to select the proper sealing products could result in property damage and/or serious personal injury.

Performance data published in this brochure has been developed from field testing, customer field reports and/or in-house testing.

While the utmost care has been used in compiling this brochure, we assume no responsibility for errors. Specifications subject to change without notice. This edition cancels all previous issues. Subject to change without notice.

Gasket Installation

In a flanged connection, all components must be correct to achieve a seal. The most common cause of leaky gasketed joints is improper installation procedures.

Bolting Procedures

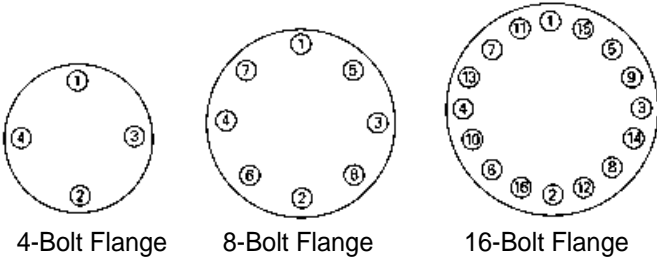

- Place the gasket on the flange surface to be sealed.
- Bring the opposing flange into contact with the gasket.
- Clean the bolts and lubricate them with a quality lubricant, such as an oil and graphite mixture.
- Place the bolts into the bolt holes.
- Finger-tighten the nuts.
- Follow the bolting sequence in the diagrams above.
- During the initial tightening sequence, do not tighten any bolts more than 30% of the recommended bolt stress. Doing so will cause cocking of the flange and the gasket will be crushed.
- Upon reaching the recommended torque requirements, do a clockwise bolt-to-bolt torque check to make certain that the bolts have been stressed evenly.
- Due to creep and stress relaxation, it is essential to prestress the bolts to ensure adequate stress load during operation.

Hydrostatic Testing Precautions

- If hydrostatic tests are to be performed at pressures higher than those for which the flange was rated, higher bolt pressures must be applied in order to get a satisfactory seal under the test conditions.

WARNING:

Properties/applications shown throughout this brochure are typical. Your specific application should not be undertaken without independent study and evaluation for suitability. For specific application recommendations consult Garlock. Failure to select the proper sealing products could result in property damage and/or serious personal injury.

Performance data published in this brochure has been developed from field testing, customer field reports and/or in-house testing.

While the utmost care has been used in compiling this brochure, we assume no responsibility for errors. Specifications subject to change without notice. This edition cancels all previous issues. Subject to change without notice.

- Use high-strength alloy bolts (ASTM B 193 Grade B7 is suggested) during the tests. They may be removed upon completion. Higher stress values required to seat the gasket during hydrostatic tests at higher than flange rated pressures may cause the standard bolts to be stressed beyond their yield points.
- Upon completion of hydrostatic testing, relieve all bolt stress by 50% of the allowable stress.
- Begin replacing the high-strength alloy bolts (suggested for test conditions) one by one with the standard bolts while maintaining stress on the gasket.
- After replacing all the bolts, follow the tightening procedure recommended in the bolting sequence diagrams.

Prestressing Bolts for Thermal Expansion

Bolts should be prestressed to compensate for thermal expansion as well as for relaxation, creep, hydrostatic end pressure and residual gasket loads.

A difference in the coefficient of thermal expansion between the materials of the flange and the bolts may change loads. In cases of serious thermal expansion, it may be necessary to apply a minimum of stress to the bolts and allow the pipe expansion to complete the compression of the gasket.

A gasket with a centering guide ring should be compressed to the guide ring. A gasket without a centering guide ring must be installed with precautions taken to prevent thermal expansion from crushing the gasket beyond its elastic limit.

Troubleshooting Leaking Joints

One of the best methods for determining the cause of joint leakage is the careful examination of the gasket where the leakage occurred.

Observation	Possible Remedies
Gasket badly corroded	<ul style="list-style-type: none"> • Select replacement material with improved corrosion resistance.
Gasket extruded excessively	<ul style="list-style-type: none"> • Select replacement material with better cold flow properties. • Select replacement material with better load capacity—i.e., more dense.
Gasket grossly crushed	<ul style="list-style-type: none"> • Select replacement material with better load carrying capacity. • Provide means to prevent crushing the gasket by use of a stop ring or redesign of flanges.
Gasket mechanically damaged due to overhang of raised face or flange bore.	<ul style="list-style-type: none"> • Review gasket dimensions to insure gaskets are proper size. • Make certain gaskets are properly centered in joint.
No apparent gasket compression achieved	<ul style="list-style-type: none"> • Select softer gasket material. • Select thicker gasket material. • Reduce gasket area to allow higher unit seating load.
Gasket substantially thinner on OD than ID due to excessive flange rotation or bending	<ul style="list-style-type: none"> • Alter gasket dimensions to move gasket reaction closer to bolts to minimize bending movement. • Provide stiffness to flange by means of back-up rings. • Select softer gasket material to lower required seating stresses. • Reduce gasket area to lower seating stresses.
Gasket unevenly compressed around circumference	<ul style="list-style-type: none"> • Make certain proper sequential bolt-up procedures are followed.
Gasket thickness varies periodically around circumference	<ul style="list-style-type: none"> • Provide reinforcing rings for flanges to better distribute bolt load. • Select gasket material with lower seating stress. • Provide additional bolts if possible to obtain better load distribution. • If flanges are warped, remachine or use softer gasket material.

Ordering Guide

RW, RWI Spiral Wound

When ordering, specify:

- Nominal pipe size or gasket dimensions, and pressure class
- Winding and filler materials
- Centering and/or inner compression ring material

SW Spiral Wound

When ordering, specify:

- OD and ID dimensions (and tolerance, if other than standard—see page D-19)
- Thickness of gasket
- Winding and filler material
- Inner ring material, if required (Style SWI)
- Pressure rating

HH, MC and MCR Manhole

When ordering, specify:

- Make and model of boiler and/or equipment if available (See chart page D-10)
- Gasket style and configuration
- Dimensions of gasket (thickness, flange seating width, and shape)
- Maximum operating pressure and temperature
- Type of metal and filler materials

Custom Gaskets

A spiral wound gasket can be made to almost any dimension required. Possible designs include multiple windings and rings, with combinations of different fillers or special winding materials and ring shapes. Describe your application or send us a drawing and we'll help you design the appropriate winding.

WARNING:

Properties/applications shown throughout this brochure are typical. Your specific application should not be undertaken without independent study and evaluation for suitability. For specific application recommendations consult Garlock. Failure to select the proper sealing products could result in property damage and/or serious personal injury.

Performance data published in this brochure has been developed from field testing, customer field reports and/or in-house testing.

While the utmost care has been used in compiling this brochure, we assume no responsibility for errors. Specifications subject to change without notice. This edition cancels all previous issues. Subject to change without notice.

Heat Exchanger

The size restrictions for heat exchanger gaskets depend only on the available sizes of the materials. Heat exchanger gaskets are commonly made in diameters up to 120", with rib widths up to 1-1/4" and thicknesses up to 1/4".

When ordering, specify:

- Style number
- Shape (Give configuration code, page D-13)
- Thickness
- Material (metal or metal and filler)

Plus specify (according to diagram below):

1. Outside diameter
2. Inside diameter
3. Rib width
4. Radius of rib
5. Bolt circle radius
6. Distance from center line of gasket to center line of ribs
7. Radius around bolt
8. Size and number of bolt holes

Note: In addition to the above information, drawings of your application are always helpful in proper dimensioning of gaskets.

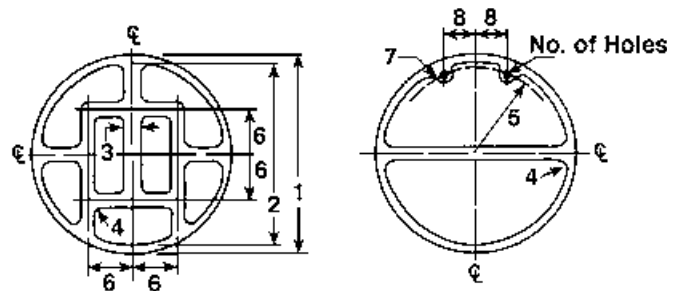

Application Data Form

Date _____

From _____

For: Garlock Metallic Gasketing Engineering

Title _____

Fax 1-281-458-0502

Company _____

Page: 1 of _____

Address _____

Drawing attached Yes No

Fax No. _____

Phone No. _____

E-mail Address _____

Application

Pipe Flange

Pumps – centrifugal/horizontal split case

Heat Exchanger

Flue Duct

Manway

Valve Bonnet

Compressor

Other _____

Service Conditions

Maximum Temperature _____ °F/°C

Continuous Operating Temperature _____ °F/°C

Internal Pressure _____ psig/bar

PSIG/bar Continuous Intermittent

Thermal Cycling _____ / 24 hours

Vibration Yes No

Other (specify) _____

Bolts

Grade _____

Diameter _____

Length _____

Number _____

Chemical Compatibility

Media _____

pH _____

Concentration _____

Liquid or Gas _____

Flange

Standard

Material _____

Size _____ Rating _____

Surface Finish _____ RMS

Phonographic Concentric

Face (raised, flat, tongue & groove, etc.) _____

Non-Standard

Material _____

I.D./O.D. _____

Flange Thickness _____

Bolt Circle Diameter _____

Surface Finish _____ RMS

Phonographic Concentric

Face (raised, flat, tongue & groove, etc.) _____

Comments: _____

Common Abbreviations Metric Conversions

SI - International Metric Standard
 Pa - Pascal
 psi - pounds per square inch
 psig - pounds per square inch gage
 oz - ounce
 g - gram
 lbf - pound force
 kgf - kilogram force

N - Newton
 in - inch
 ft - foot
 yd - yard
 m - meter
 gal - gallon
 l - liter

Prefixes

M (mega) = 1,000,000 = 10^6
 k (kilo) = 1,000 = 10^3
 c (centi) = 0.01 = 10^{-2}
 m (milli) = 0.001 = 10^{-3}
 u (micro) = 0.000001 = 10^{-6}

To Convert from:	To SI Units:	Multiply by:
Length		
mil	mm	0.0254
in	mm	25.4
in	cm	2.54
ft	m	0.3048
yd	m	0.9144
Weight		
oz	g	28.35
oz	kg	0.0283
lb	g	453.6
lb	kg	0.4536
lb	N	4.4482
Force		
lbf	N	4.448
kgf	N	9.8066
Area		
in ²	cm ²	6.4516
ft ²	m ²	0.0929
Pressure		
bar	psi	14.5
psi	Pa	6895
psi	kPa	6.89
psi	bar	0.069
psi	MPa	0.0069
N/m ²	Pa	1.00
N/mm ²	MPa	1.00
Torque		
in-lb	Nm	0.113
ft-lb	Nm	1.3558
Density		
oz/in ³	g/cm ³	1.73
g/cm ³	kg/m ³	1000
lb/ft ³	kg/m ³	16.02
lb/ft ³	g/cm ³	0.01602
Adhesion		
lb/in	kN/m	0.1751
Volume		
gal	l	3.7854
gal	m ³	0.0038

More than just great products...

Beyond offering you the widest available range of products for packing and sealing, Garlock enhances the value of its products with technical services and comprehensive training programs:

- ISO 9001:2000 registration for Industrial Gasketing, Industrial Packing, KLOZURE® Oil Seals, Bearing Protectors, and Mechanical Seals, Expansion Joints, Hydraulic Components, and Industrial Rubber Products.
- A global network of stocking Authorized Garlock Distributors.
- Factory sales representatives and applications engineers available for problem solving when and where it is needed.
- Toll-free 800 telephone and fax numbers for immediate product information.
- In-plant surveys of equipment and processes, providing the customer with recommendations to identify and eliminate sealing and packing problems before they start.
- The most sophisticated and most comprehensive test facilities available.
- Technical field seminars on all Garlock products.
- Factory-sponsored product training programs, including hands-on seminars, to ensure that Garlock representatives and their distributor personnel are the best in the industry.
- Technical Bulletins to keep you up-to-date on product enhancements and changes.

Customers who specify Garlock fluid sealing products get, at no extra cost, the high quality support needed to run a profitable operation.

AUTHORIZED REPRESENTATIVE

WARNING:

Properties/applications shown throughout this brochure are typical. Your specific application should not be undertaken without independent study and evaluation for suitability. For specific application recommendations consult Garlock. Failure to select the proper sealing products could result in property damage and/or serious personal injury.

Performance data published in this brochure has been developed from field testing, customer field reports and/or in-house testing.

While the utmost care has been used in compiling this brochure, we assume no responsibility for errors. Specifications subject to change without notice. This edition cancels all previous issues. Subject to change without notice.

GARLOCK is a registered trademark for packings, seals, gaskets, and other products of Garlock.

© Garlock Inc 2007. All rights reserved worldwide.

Garlock
SEALING TECHNOLOGIES®

an EnPro Industries company

Garlock Sealing Technologies
1666 Division Street
Palmyra, New York 14522 USA
1-315-597-4811
1-800-448-6688
Fax: 1-800-543-0598
1-315-597-3039

www.garlock.com

Other Garlock facilities are located in:

Columbia, SC, USA

Phone 1.803.783.1880
Fax 1.803.783.4279

São Paulo, Brazil

Phone 55.11.4352.6161
Fax 55.11.4352.8181

Saint-Étienne, France

Phone 33.4.7743.5100
Fax 33.4.7743.5151

Singapore

Phone 65.6285.9322
Fax 65.6284.5843

Houston, TX, USA

Phone 1.281.459.7200
Fax 1.281.458.0502

Sherbrooke, Canada

Phone 1.819.563.8080
Fax 1.819-563.5620

Neuss, Germany

Phone 49.2131.3490
Fax 49.2131.349.222

Shanghai, China

Phone 86.021.62789702
Fax 86.021.62787826

Sydney, Australia

Phone 61.2.9793.2511
Fax 61.2.9793.2544

W. Yorkshire, England

Phone 44.1422.313600
Fax 44.1422.313601

Mexico City, Mexico

Phone 52.555.567.7011
Fax 52.555.368.0418

Dubai, UAE

Phone 971.4.8833652
Fax 971.4.8833682