

GASOLINE VERSUS DIESEL

COMPARING CO₂ EMISSION LEVELS OF A MODERN
MEDIUM SIZE CAR MODEL UNDER LABORATORY
AND ON-ROAD TESTING CONDITIONS

Jan Dornoff and Felipe Rodríguez

ACKNOWLEDGMENTS

The authors thank the Joint Research Centre of the European Commission for conducting the vehicle tests, which were performed under the collaborative research agreement No. 34216. The authors thank also all internal and external reviewers of this report for their guidance and constructive comments, with special thanks to the Joint Research Centre of the European Commission and Peter Mock, John German, and Liuhanzi Yang of the International Council on Clean Transportation. Their review does not imply an endorsement, and any errors are the authors' own.

For additional information:
International Council on Clean Transportation Europe
Neue Promenade 6, 10178 Berlin
+49 (30) 847129-102

communications@theicct.org | www.theicct.org | [@TheICCT](https://twitter.com/TheICCT)

© 2019 International Council on Clean Transportation

Funding for this work was generously provided by the European Climate Foundation.

TABLE OF CONTENTS

Abbreviations	ii
Executive Summary	iii
1. Introduction	1
2. Methodology	3
2.1 Vehicle Selection.....	3
2.2 Vehicle On-Board Instrumentation	6
2.3 Laboratory Test Methodology.....	8
2.4 Real-World Driving Test Methodology	9
3. Results and Discussion	12
3.1 Laboratory Test Results.....	12
3.2 Real-World Driving Results	22
4. Conclusions and Policy Recommendations	29
References	32
Appendices	35
Appendix A: Extended list of test vehicle characteristics.....	35
Appendix B: Golf TSI technology—Working principles and their effects on CO ₂ emissions.....	36

ABBREVIATIONS

BDC	Bottom Dead Center
CA BTDC	Crank Angle Before Top Dead Center
DPF	Diesel Particulate Filter
CO ₂	Carbon Dioxide
CVS	Constant Volume Sampling system
DCT	Dual-clutch automated transmission
EGR	Exhaust Gas Recirculation
EFM	Exhaust Flow Meter
EUDC	Extra Urban Driving Cycle
GPF	Gasoline Particulate Filter
GPS	Global Positioning System
NEDC	New European Driving Cycle
NO _x	Nitrogen Oxides
NSC	NO _x Storage Catalyst
OBD	On-Board Diagnostic
PEMS	Portable Emissions Measurement System
RDE	Real Driving Emissions
TDC	Top Dead Center
THC	Total Hydrocarbons
TWC	Three Way Catalyst
VTG	Variable Turbine Geometry
VSP	Vehicle Specific Power
VW	Volkswagen
WLTC	Worldwide Harmonized Light Vehicles Test Cycle
WLTP	Worldwide Harmonized Light Vehicles Test Procedure

EXECUTIVE SUMMARY

In Europe, diesel engines used to be promoted as a clean and efficient vehicle technology that would play a key role in reducing carbon dioxide (CO₂) emissions in the transport sector. However, after the discovery of defeat devices in Volkswagen diesel engines and the ensuing revelations that the real-world NO_x emissions of many diesel vehicles largely exceed the effective emission limits, even recently purchased diesel cars are threatened by driving bans in a growing number of European cities.

As a consequence, the share of diesel vehicles among new car registrations in the EU decreased from a peak of 55% in 2011 to 44% in 2017 and continued to fall in 2018. Parts of the industry portray the diesel engine as being essential to meeting future CO₂ emission targets. However, although it is true that the diesel combustion process has an intrinsic efficiency advantage, a modern gasoline car can have the same or even lower CO₂ emission level than a comparable diesel car.

The release in late 2017 of a new generation of gasoline engines for Europe's most popular passenger car, the Volkswagen (VW) Golf, provided an excellent opportunity to compare modern gasoline and diesel engines side by side, under various laboratory as well as on-road driving conditions.

Two VW Golf vehicles were selected for testing, one diesel (Golf TDI) and one gasoline (Golf TSI) version. The key characteristics of both vehicles are summarized in Table ES 1.

Table ES 1. Key characteristics of the two test vehicles.

	 VW Golf TDI (diesel)	 VW Golf TSI (gasoline)
Model year	2016	2018
Emission standard	Euro 6b	Euro 6c
Engine	2.0l TDI Blue Motion Technology, 110 kW	1.5l TSI ACT Blue Motion, 96 kW
Transmission	Dual clutch, 6-speed	Dual clutch, 7-speed
Trim level	Comfortline	Comfortline
Mass of tested vehicle	1,420 kg	1,340 kg
0 - 80 km/h	6.2 seconds	6.2 seconds
0 - 100 km/h	8.6 seconds	9.1 seconds
Maximum speed	214 km/h	210 km/h
CO₂ (in NEDC)	117 g/km	113 g/km
List price in Dec 2017	29,475 euros	26,075 euros

Both vehicles were Euro 6 type approved prior to the introduction of the Worldwide Harmonized Light Vehicles Test Procedure (WLTP) and Real Driving Emissions (RDE) NO_x not-to-exceed limits in the EU. The Golf TDI was tested first and is of model year 2016; the Golf TSI is of model year 2018. It was verified, however, that the key characteristics of the TDI, and in particular the type-approval CO₂ emission level, did not change significantly between model years 2016 and 2018, thereby allowing for a direct comparison between vehicles.

The vehicles were selected with a focus on comparability from a consumer’s point of view, which meant similar maximum speed and acceleration power. Innovative CO₂ reduction technologies applied in the Golf TSI include cylinder deactivation, active coolant temperature control, camshaft phasing on both the inlet and outlet sides, advanced coasting function, as well as an alternative combustion cycle type—the Miller cycle—and a variable nozzle geometry turbocharger. Trim level and tires were chosen to be comparable for both vehicles. The diesel vehicle weighed about 80 kg more than the gasoline vehicle and its 2018 list price was about 3,400 euros higher.

For all tests performed under laboratory conditions, the gasoline powered Golf TSI showed lower CO₂ emissions than the comparable diesel powered Golf TDI (see Figure ES 1, left side). This also was observed for tests at lower ambient temperatures, where the CO₂ emissions were higher for both vehicles. The CO₂ emission benefit of the Golf TSI also prevailed for warm-start tests. A comparison of cold-start tests with tests started with a warm engine showed that the gasoline engine warms up considerably faster than the diesel engine. However, the gasoline engine performs a fuel intensive, rapid catalyst heat-up at the beginning of a cold-start test, which partly counteracts the CO₂ benefit of an engine that warms up more quickly.

Even though lower CO₂ emissions were measured for the Golf TSI during the real-world driving on public roads as well (see Figure ES 1, right side), the subsequent analysis of the driving dynamicity and ambient temperature effect on the test results suggests that both vehicles, when driven in the same manner under the same ambient conditions, have similar real-world CO₂ emissions, with a slight benefit for the Golf TSI. These findings also are supported by the CO₂ emission values reported by consumers on the independent German website Spritmonitor, which are on average lower for the Golf TSI than for the Golf TDI.

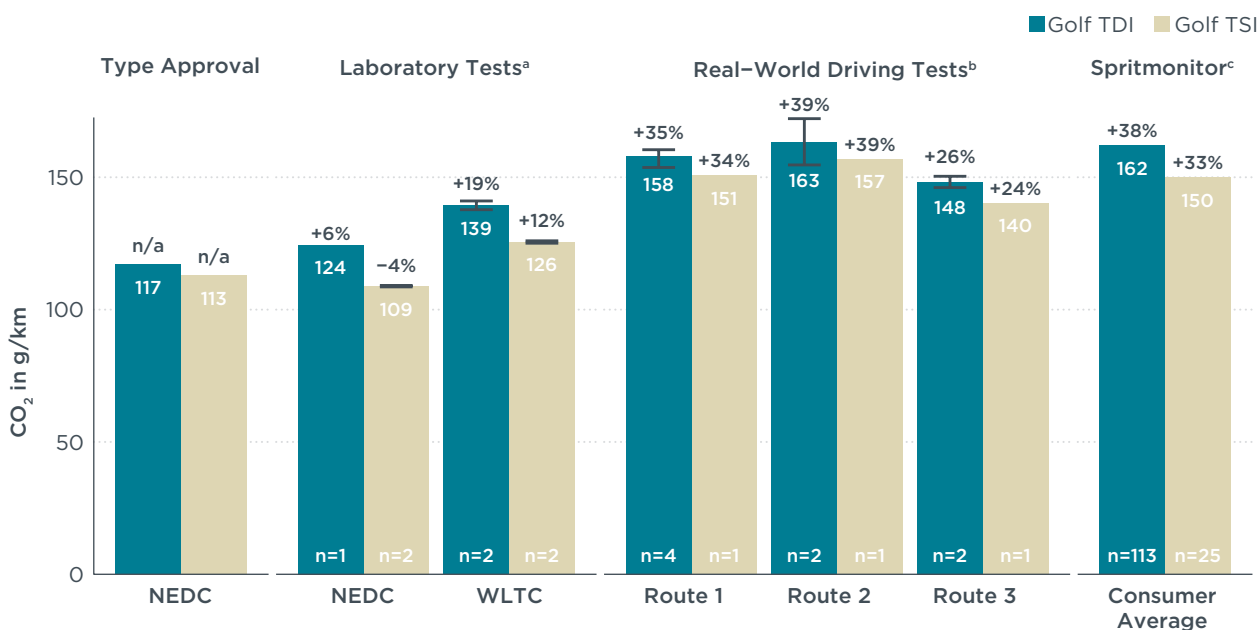

Figure ES 1. CO₂ emission levels of the Golf TDI and Golf TSI. Comparison of test results with declared type-approval values and consumer reported numbers (Spritmonitor). The error bars show the minimum to maximum range of results if multiple tests were performed. No error bar is shown if only one test was performed. The number of tests is shown at the bottom of each bar. The relationship of the CO₂ emission level to the type-approval value is shown above each bar.

^aThe tests shown were performed at 23 °C with cold engine at test start. ^bThe graph shows the real-world CO₂ emissions as measured, not corrected for effects of driving style or ambient temperature. When taking these effects into account, similar real-world CO₂ emissions are expected. ^cThe bar reflects the average reported CO₂ emissions for n different vehicles.

Summarized, the results of this vehicle testing project show that at least for the popular C-segment,¹ a modern gasoline vehicle can have the same or even lower CO₂ emissions than a comparable diesel version at a considerably lower price. This finding holds true not only for laboratory testing but also for on-road measurements under real-world driving conditions.

¹ C-segment refers to the medium family car size class in Europe and is comparable to the U.S. compact car class.

1. INTRODUCTION

Following the discovery of defeat devices in Volkswagen diesel engines and the subsequent revelations that the real-world NO_x emissions of most Euro 5 and Euro 6 diesel vehicles largely exceed the effective emission limits, consumers in Europe have been turning their backs on diesel vehicles. The average diesel share of newly registered passenger cars in the European Union (EU) declined from its 55% peak in 2011/2012 to 44% in 2017 (Mock, 2018).

Criticizing the EU's CO₂ regulation and similar measures for cars as too ambitious, industry representatives such as Bernhard Mattes, president of the German Association of the Automotive Industry (VDA), portray the diesel engine as being essential for further CO₂ emission reductions and the recent drop in diesel car sales as an excuse to delay further regulatory steps (Zeit Online, 2018; VDA, 2018). It is true that the diesel combustion process has an intrinsic efficiency advantage compared to conventional gasoline combustion. However, a modern gasoline car can have the same or even lower real-world CO₂ emission level than a comparable diesel car, for the following reasons:²

- » A lower level of fuel consumption does not necessarily correspond to a lower level of CO₂ emissions. For the fuel types used in this vehicle testing project,³ a diesel vehicle emits about 13% more CO₂ by mass per liter of fuel burned than a vehicle fueled with gasoline. Consequently, the fuel consumption, in liters per 100 kilometers (l/100 km), of a gasoline vehicle is higher than it is for a diesel vehicle to emit the same amount of CO₂.
- » Diesel engines are heavier than their gasoline counterparts. In the case of the vehicles tested as part of this project, the diesel configuration is 80 kg heavier.
- » Diesel engines historically possessed efficiency advantages over gasoline engines, but gasoline engines are gaining ground as a result of advanced technologies such as direct injection; turbocharging and downsizing; and variable valve timing.
- » Diesel engines require more complex technologies to meet the regulatory air pollutant emission limits, therefore making them more expensive and often more fuel-intensive. This reduces the potential for deploying CO₂ reduction technologies on a diesel vehicle compared to a gasoline vehicle of the same price.
- » The gap between type-approval and real-world CO₂ emissions is, on average, greater for diesel than for gasoline vehicles (Tietge et al., 2019).
- » Diesel engines show their largest CO₂ benefits in heavier and more powerful vehicles, thereby contributing to a rebound effect as more SUVs and other high-powered vehicles, with correspondingly higher CO₂ emission levels, are pushed on the market (Mock & Tietge, 2018).

The release in late 2017 of a new generation of gasoline engines for Europe's most popular passenger car, the VW Golf, provided an excellent opportunity to compare modern gasoline and diesel engines side by side, and to determine whether the diesel version would still have a CO₂ benefit, as was the case in the past. The official CO₂ emission levels of the VW Golf model equipped with these new gasoline engines, according to the manufacturer, are lower than those of the comparable diesel version (VW AG, 2017). To understand if this CO₂ benefit also prevails for conditions deviating from those considered during type approval, two VW Golf vehicles were tested—one powered by the new gasoline engine, the other powered by a diesel engine—also

² For more details, see Mock & Tietge, 2018

³ Market fuel E5 gasoline with maximum 5% ethanol content and B7 diesel with maximum 7% fatty acid methyl ester (FAME) were used in this project.

under real-world driving conditions. The vehicles were tested in two drive cycles in the laboratory at different ambient temperatures and coolant temperatures at test start. To assess the CO₂ emissions during real-world driving, tests were performed on three different routes on public roads.

The first section of this paper describes which vehicles were selected for the testing and why they were considered as suitable for a comparison of CO₂ emissions. Following that is an explanation of how the laboratory and real-world tests were conducted, and which measurements were performed. The test results are presented and discussed in the second section. The laboratory results are first compared with the type-approval CO₂ emissions and the effect of the ambient temperature on the CO₂ emissions is investigated. Next, the effect of a cold-start engine on the CO₂ emissions is discussed in detail. The CO₂ results of the tests performed on public roads are analyzed for comparability. In the third section, conclusions drawn from the test results are presented and derived policy recommendations are provided.

2. METHODOLOGY

2.1 VEHICLE SELECTION

Two C-segment vehicles were tested. Vehicle 1, shown in Figure 1, was a diesel powered Volkswagen Golf 2.0 TDI BlueMotion, referred to as the Golf TDI. Vehicle 2 was a gasoline powered Volkswagen Golf 1.5 TSI ACT BlueMotion, referred to as the Golf TSI and shown in Figure 2.

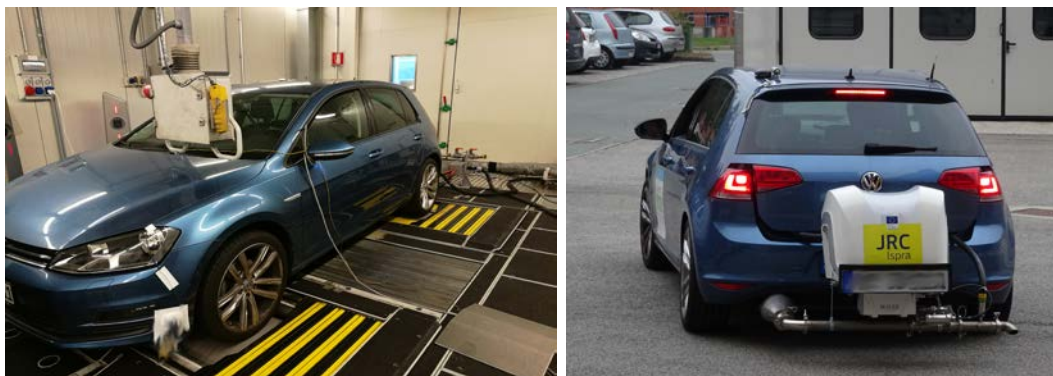

Figure 1. Golf TDI test vehicle, on chassis dynamometer and on the road with portable emissions measurement system (PEMS) installed.



Figure 2. Golf TSI test vehicle, on chassis dynamometer and on the road with portable emissions measurement system (PEMS) installed.

The characteristics of the tested Golf TDI and Golf TSI are shown in Table 1, with additional details in Appendix A. Both vehicles were rented for the testing periods. At the start of the test, the odometers showed approximately 24,000 km for the Golf TDI and 11,000 km for the Golf TSI. Considering the minimum run-in mileage for road load parameter determination of 3,000 km, defined in the WLTP regulation (EU) 2017/1151 (European Commission, 2017), no further power train run-in effects⁴ on the road load were therefore expected.

⁴ The power train of a new vehicle usually has an elevated driving resistance caused by friction in the bearings and gearbox. During the run-in phase, the friction lessens and finally stabilizes. That is when the run-in phase is considered completed.

Table 1. Golf TDI and Golf TSI test vehicle characteristics

Parameter	Unit	Golf TDI	Golf TSI
Manufacturer	-	Volkswagen	Volkswagen
Trade name	-	Golf	Golf
Variant trade name	-	2.0 TDI BlueMotion Technology	1.5 TSI ACT BlueMotion
Manufacturer type	-	Golf VII (VW type code: AU)	Golf VII (VW type code: AU)
Trim level	-	Comfortline	Comfortline
Date of first registration	-	May 2015	September 2017
Mileage at test start	km	~ 24,000	~11,000
Transmission type	-	Dual clutch transmission	Dual clutch transmission
Number of speeds	-	6	7
Powered axle(s)	-	Front	Front
Chassis type	-	Hatchback	Hatchback
Vehicle segment	-	C (Medium)	C (Medium)
Type-approval cycle	-	NEDC	NEDC
Emission standard	-	Euro 6b (W)	Euro 6c (ZD)
OBD standard	-	Euro 6-1	Euro 6-2
Mass in running order	kg	1,394	1,344
Mass of test vehicle (fuel tank full, excl. driver, excl. PEMS)	kg	Approx. 1,420	Approx. 1,340
Mass of test vehicle (fuel tank full, incl. driver, co-driver, and PEMS)	kg	1,660-1,680	1,600-1,620
Rated vehicle speed	km/h	214	210
Tire dimensions	-	225/40 R18	225/45 R17
Tire rolling resistance class	-	B	C
Fuel type	-	Diesel (mono-fuel)	Gasoline (mono-fuel)
Number of cylinders	-	4	4
Engine displacement	cm ³	1,968	1,498
Rated power at speed	kW	110 at 3,500–4,000 rpm	96 at 5,000–6,000 rpm
Rated torque at speed	Nm	340 at 1,750–3,000 rpm	200 at 1,400–4,000 rpm

Data sources: Certificates of conformity; Registration certificates; Demmelbauer-Ebner, Persigehl, Görke, & Werstat, 2017; VW AG, 2014, 2015, 2017, 2018)

The Golf TDI test vehicle was of model year 2016, whereas the Golf TSI was of model year 2018, requiring a comparison of the tested 2016 Golf TDI with its 2018 model year equivalent. The engine power and torque characteristics as well as the vehicle performance remained the same. The main difference identified was the dual clutch transmission (DCT) type, where the number of speeds changed from six to seven for the 2018 model. The declared CO₂ emissions of the 2018 Golf TDI model are 114–117 g/km compared to 117–119 g/km for the 2016 model year. The Golf TDI test vehicle had declared CO₂ emissions of 117 g/km, which is at the upper end of the range of the 2018 model. The certificate of conformity of the Golf TSI stated CO₂ emissions of 113 g/km, which is also the highest value declared for the 2018 model, ranging from 110–113 g/km (VW AG, 2015, 2017). A comparison of the 2016 model year Golf TDI and the 2018 model year Golf TSI is therefore reasonable.

Both vehicles had the same body type, were front wheel driven, and had similar transmissions and optional equipment. Tires of the same width were installed on both

vehicles. The rolling resistance of the Golf TDI tires was one efficiency class better than for the Golf TSI, whereas the rims of the Golf TDI were 1 inch larger.

The Golf TDI was tested first, in summer 2017, and was therefore the reference for the selection of the gasoline version, which was tested one year later in summer 2018. The new 1.5-liter gasoline engine is offered in a 96 kW and a 110 kW version. Table 2 shows the performance parameters of the tested Golf TDI and the two versions of the Golf TSI.

Table 2. Performance parameters of the tested model year 2016 Golf TDI and the two versions of the Golf 1.5 TSI, model year 2018

	Tested vehicle models		For comparison
	Golf TDI	Golf TSI 96kW	Golf TSI 110kW
Engine capacity (cm³)	1,968 ^c	1,498 ^c	1,498 ^b
Number of cylinders	4 ^c	4 ^c	4 ^b
Power (kW at rpm)	110 at 3,500–4,000 ^c	96 at 5,000–6,000 ^c	110 at 5,000–6,000 ^b
Torque (Nm at rpm)	340 at 1,750–3,000 ^c	200 at 1,400–4,000 ^c	250 at 1,500–3,500 ^b
Transmission type	DCT ^a	DCT ^b	DCT ^b
Number of speeds	6 ^a	7 ^b	7 ^b
Maximum speed (km/h)	214 ^c	210 ^c	216 ^b
0–80 km/h (s)	6.2 ^a	6.2 ^b	5.9 ^b
0–100 km/h (s)	8.6 ^a	9.1 ^b	8.3 ^b
Fuel urban (l/100km)	5.2 ^c	6.2 ^c	6.1–6.2 ^b
Fuel extra urban (l/100km)	4.0 ^c	4.2 ^c	4.2–4.3 ^b
Fuel combined (l/100km)	4.4 ^c	4.9 ^c	4.9–5.0 ^b
CO₂ urban (g/km)	140 ^c	142 ^c	n/a
CO₂ extra urban (g/km)	106 ^c	96 ^c	n/a
CO₂ combined (g/km)	117 ^c	113 ^c	112–114 ^b
List price in Dec. 2017 (Comfortline edition)	29,475 euros ^{b, d}	26,075 euros ^b	26,700 euros ^b

^aVW AG, 2015. ^bVW AG, 2017. ^cCertificate of conformity of the tested vehicle. ^dFor comparability, the price of the equivalent Golf TDI model in December 2017 is shown.

Although the peak power of the Golf TDI matches the 110 kW version of the Golf TSI, the performance of the Golf TDI in terms of acceleration and top speed falls between the 96 and 110 kW gasoline versions. Both Golf TSI versions have similar declared CO₂ emissions (113 vs. 112–114 g/km) but the 96 kW version deploys more advanced technologies with CO₂ saving potential, which are of particular interest for this research project, so that is the version that was tested.

The engine installed in the Golf TDI is a modern four-cylinder diesel engine with high-pressure common-rail fuel injection, variable turbine geometry (VTG) turbocharger, switchable coolant pump, cylinder pressure controlled combustion, and camshaft phasing (VW AG, 2014). The lean diesel combustion requires a complex and relatively expensive technology package to reduce NO_x emissions, on the one hand, while minimizing the detrimental effect of these measures on fuel consumption, soot formation, and drivability on the other. For that purpose, the engine also is equipped with an uncooled high-pressure and a cooled low-pressure exhaust gas recirculation (EGR) system for in-cylinder NO_x reduction, and an exhaust aftertreatment system consisting of a close coupled NO_x storage catalyst (NSC) and catalytically coated diesel particulate filter (DPF). The NSC requires frequent regeneration with rich exhaust gas to maintain its NO_x reduction efficiency. This regeneration occurred on the Golf TDI under

most conditions every 2 to 8 minutes. For the generation of the rich exhaust gas, the engine needs to be operated at very low efficiency, which increases the average fuel consumption. In addition, desulfurization of the NSC at a minimum exhaust temperature of 620°C with rich exhaust is performed at least every 1,000 km, usually in combination with a DPF regeneration, to restore the catalyst's NO_x storage capacity, further deteriorating the fuel economy (Neusser, Kahrstedt, Dorenkamp, & Jelden, 2013).

The gasoline engine uses direct fuel injection, cylinder deactivation, active coolant temperature control, and camshaft phasing on both the inlet and outlet side. The tested 96 kW version applies in addition an advanced coasting function as well as an alternative combustion cycle type—the Miller cycle—and a VTG turbocharger. The latter is a technology that is commonplace in modern diesel engines but a novelty on a mass production gasoline engine (VW AG, 2018). The working principles of the different technologies deployed in the Golf TSI and their effects on the CO₂ emissions are explained in Appendix B.

To reduce the gaseous pollutant emissions of the Golf TSI engine, an exhaust aftertreatment system consisting of a close-coupled three-way catalyst (TWC) and a second TWC in underfloor position is sufficient. The lower cost of this emission reduction system of the gasoline Golf allows a greater deployment of efficiency improving technologies while maintaining a considerable sales price advantage. Despite the extensive CO₂ reduction technology package in the Golf TSI, its list price is 3,400 euros lower than of the Golf TDI.

2.2 VEHICLE ON-BOARD INSTRUMENTATION

Prior to the testing program, the vehicles were equipped with on-board measurement instruments as shown in Figure 3. A data logger for automatic data acquisition was installed to record the engine signals available at the OBD interface, high speed GPS data, and the signals of installed probes. Due to the availability of measurement equipment, more signals were measured by probes on the Golf TSI than on the Golf TDI.

VW Golf TDI

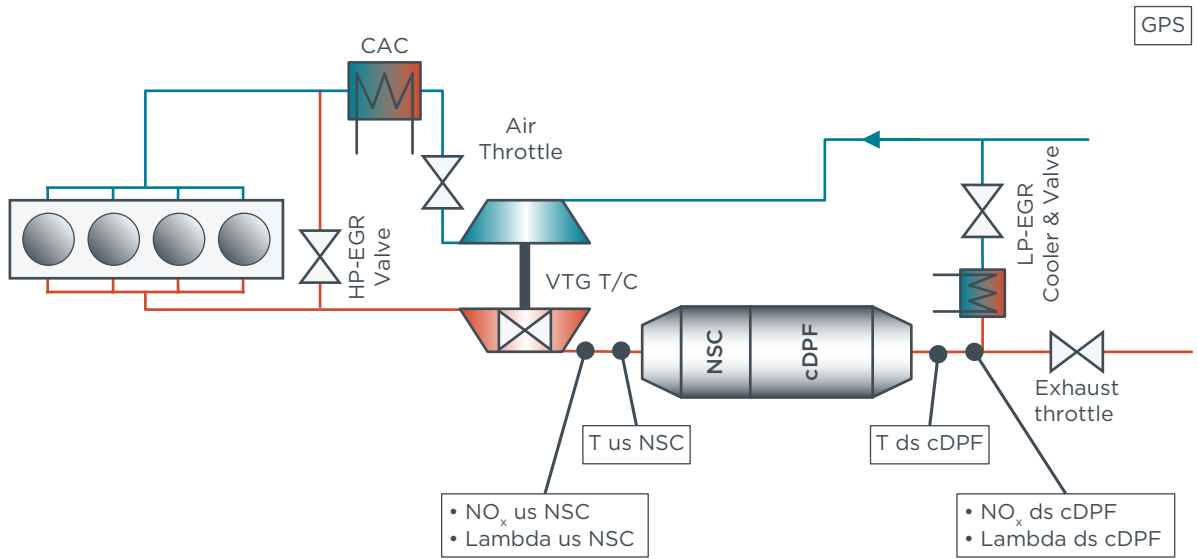

OBD Parameters

- Vehicle speed
- Engine speed
- Air mass flow
- Rail pressure
- Lambda upstream NSC
- Lambda downstream cDPF
- HP-EGR valve position
- LP-EGR valve position
- Intake manifold pressure
- Intake manifold temperature
- Ambient air temperature

VW Golf TSI

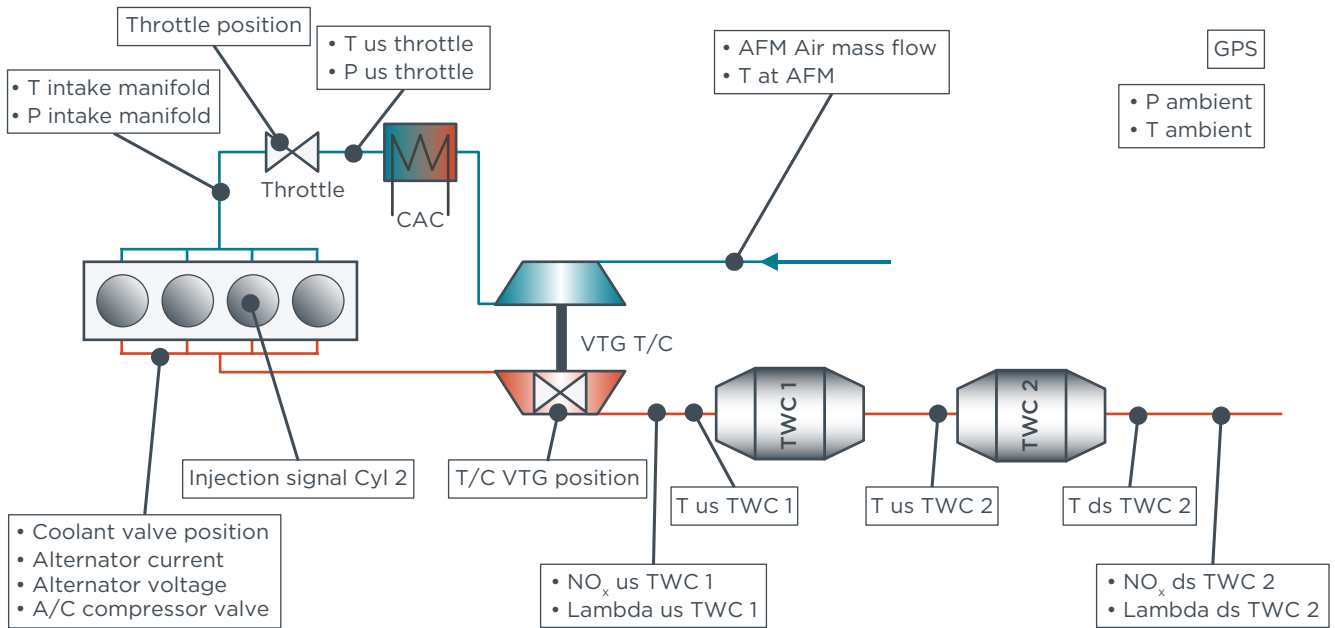

OBD Parameters:

- Vehicle speed
- Engine speed
- Lambda upstream TWC1
- Accelerator pedal position
- Coolant temperature
- Ignition timing advance

Abbreviations

- us: upstream
- ds: downstream
- P: Pressure
- T: Temperature
- cDPF: coated DPF
- Cyl: Cylinder
- CAC: Charge Air Cooler
- NSC: NO_x Storage Catalyst
- HP-EGR: High-Pressure Exhaust Gas Recirculation
- LP-EGR: Low-Pressure Exhaust Gas Recirculation
- VTG T/C: Variable Turbine Geometry turbo charger
- TWC: Three-Way-Catalyst
- AFM: Air Flow Meter
- A/C: Air Conditioning

Figure 3: Schematic of Golf TDI and Golf TSI test vehicle instrumentation. Boxed parameters show the recorded signals.

2.3 LABORATORY TEST METHODOLOGY

All chassis dynamometer tests were performed at the Vehicle Emissions Laboratory (VELA) of the European Commission Joint Research Centre (JRC) in Ispra, Italy.

The vehicle emission test cell was equipped with a four-wheel-drive single-roller test bench, air conditioning from -10°C to +35°C, a Horiba constant volume sampling (CVS) system, and Horiba MEXA 7100 and 7400 exhaust gas analyzers.

The on-board measurement equipment was active during the chassis dynamometer tests and recorded additional engine, ambient, and exhaust parameters.

Road load parameters

The road load parameters for the test vehicles were not available from the manufacturer and a determination by coastdown could not be performed in this project. The road load parameters for the New European Driving Cycle (NEDC) and Worldwide Harmonized Light Vehicles Test Procedure (WLTP) were therefore calculated based on the vehicle characteristics using the methodology described in Tsiakmakis, Fontaras, Cubito, et al. (2017). To account for the higher driving resistance at -7°C, the respective road load parameters were increased by 10% for this test.

For verification, the calculated WLTP road load parameters were compared with values provided by Volkswagen in the documentation of Real Driving Emissions (RDE) type-approval tests of similar vehicles. The Golf TDI parameters were compared to those of a Volkswagen Golf VII 2.0 TDI hatchback with a 110 kW engine, a 7-speed DCT, and 225/45 R17 tires. For the Golf TSI comparison, parameters were available for a VW Golf VII 1.5 TSI station wagon with a 110 kW engine, a 7-speed DCT, and 205/50 R17 tires. The comparison revealed that for both test vehicles, the parameters stated by the manufacturer are a bit lower than those used for the WLTP chassis dynamometer tests. However, the effect on the positive cycle energy demand, as defined in the WLTP regulation (EU) 2017/1151 (European Commission, 2017), is similar for both vehicles with a 3.8% higher energy demand for the Golf TDI and a 4.0% higher value for the Golf TSI (see Figure 4). Because the relative energy demand increase is relatively small and almost identical for both vehicles, the effect on the CO₂ emissions is assumed to be similar as well. A direct comparison of the WLTC test results is therefore justified.

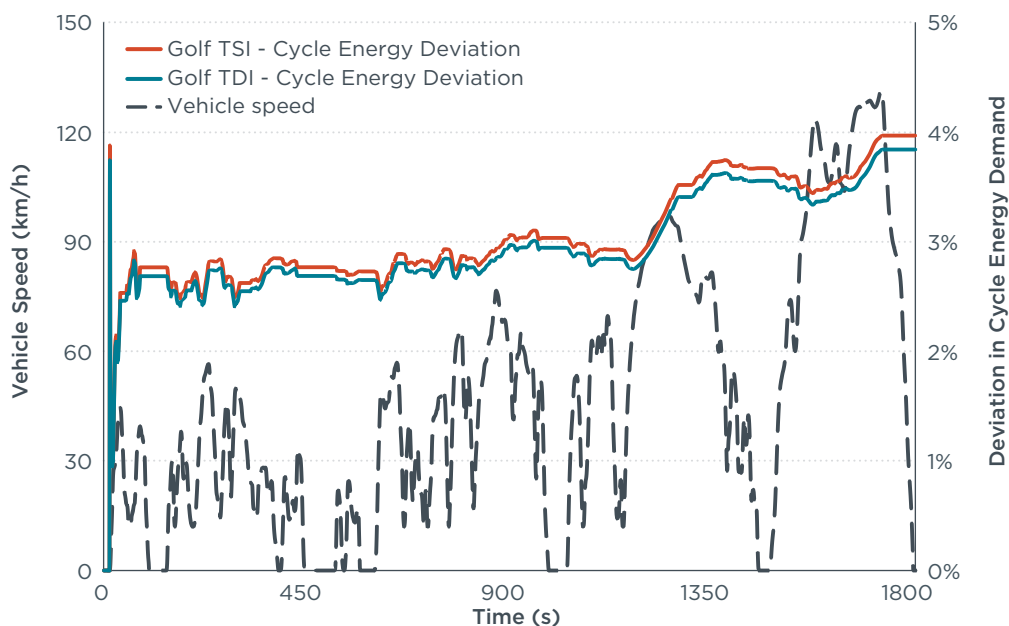

Figure 4. Relative deviation in positive cycle energy demand comparing the road load parameters used for testing with those stated by the manufacturer for comparable vehicles. The deviation is at a similar level for the Golf TDI and Golf TSI.

Test cycles

The Golf TDI and Golf TSI in NEDC⁵ and WLTC were tested with variations in the test parameters as shown in Table 3. The cold-start NEDC tests were performed according to the procedure defined in the UNECE Regulation 83 (UNECE, 2015) with the vehicle preconditioned in an EUDC⁶ cycle and the battery fully charged during the subsequent soak phase. For the cold-start WLTC test, the respective procedure defined in the WLTP regulation (European Commission, 2017) was followed. The battery was fully charged prior to the WLTC preconditioning cycle followed by a soak phase at test temperature with no additional battery charge. The warm-start tests were carried out 20 to 30 minutes after the respective cold-start tests. Due to budget constraints the -7°C WLTC and +30°C NEDC tests were performed only on the Golf TDI.

Conventional B7 diesel and E5 gasoline were used for all laboratory tests.

Table 3. Chassis dynamometer test types and number of tests performed with the Golf TDI and Golf TSI test vehicles

Cycle Type	Road loads	Ambient temp. (°C)	Coolant at test start	Golf TDI	Golf TSI
NEDC	NEDC	23	Cold	1	2
NEDC	NEDC	23	Warm	2	2
NEDC	NEDC	30	Cold	2	-
NEDC	NEDC	10	Cold	2	2
WLTC	WLTP	23	Cold	2	2
WLTC	WLTP	23	Warm	4	2
WLTC	WLTP	14	Cold	2	1
WLTC	WLTP + 10%	-7	Cold	1	-

2.4 REAL-WORLD DRIVING TEST METHODOLOGY

Because the focus of this paper is the comparison of the CO₂ emissions of the Golf TDI and Golf TSI, based on comparable tests for both vehicles, it is of less importance whether or not the real-world tests performed on public roads are compliant with the requirements of the RDE regulation. To avoid the need to distinguish between RDE and non-RDE compliant PEMS tests, and for better readability, the real-world tests from hereon are referred to as *real-world driving* tests.

Vehicle test equipment

For the emission measurement during the real-world driving tests, a portable emissions measurement system (PEMS) and an exhaust flow meter (EFM) were installed on the trailer hook of the vehicles. At the time the Golf TDI was tested, an AVL M.O.V.E GAS PEMS iS was available, which measures carbon monoxide, nitrogen monoxide, nitrogen dioxide, and carbon dioxide (CO₂) concentrations. The exhaust mass flow was determined by an AVL M.O.V.E EFM, which is based on the differential pressure flow metering method. The PEMS installation was complemented by a weather station that records ambient temperature, pressure, and humidity and a GPS sensor for geographical position, altitude, and vehicle speed determination. The complete measurement equipment added about 100 kg to the mass of the Golf TDI.

⁵ The New European Drive Cycle—NEDC—was used in the European Union for emission type approval until August 31, 2017. From that time the Worldwide Harmonized Light Vehicles Test Procedure—WLTP—is used for type approval. The Worldwide Harmonized Light Vehicles Test Cycle—WLTC—is the associated test cycle.

⁶ The NEDC consists of two phases. The Urban Driving Cycle was considered to represent urban driving and the second phase, the Extra Urban Driving Cycle—EUDC—to represent rural and motorway driving. The EUDC is used for preconditioning of the test vehicles in the NEDC test procedure.

In addition to the gas PEMS installed on the Golf TDI, a system to measure particulate number (PN) emissions of type AVL M.O.V.E PN PEMS iS was available when testing the Golf TSI. The total mass of the test equipment was therefore approximately 20 kg more than on the Golf TDI. The lower mass benefit of the Golf TSI was thereby reduced from 80 to 60 kg. Because the Golf TSI was tested second, this mass penalty could not be compensated for in the Golf TDI testing. The Golf TSI will therefore have a slight CO₂ penalty, compared to the Golf TDI in real-world driving tests. A co-driver accompanied the test driver in all tests performed with both vehicles. The approximate total vehicle test mass including measurement equipment and passengers was 1600–1620 kg for the Golf TSI and 1660–1680 kg for the Golf TDI.

The accuracy of the PEMS installation was verified on the chassis dynamometer according to the RDE regulation (EU) 2017/1151 through validation against standard laboratory equipment (European Commission, 2017).

As for the laboratory tests, B7 diesel and E5 gasoline were used for the real-world driving tests.

Routes

The real-world driving tests were performed on three different routes. The characteristics of those routes are listed in Table 4. Figure 5 shows the respective altitude profiles. Whereas Routes 1 and 2 comply with the route composition requirements of the RDE regulation (European Commission, 2017), Route 3 was designed with a focus on highway driving and is therefore not compliant with these requirements, both for the duration and the trip composition.

Table 4. Route characteristics of real-world driving routes

Characteristic	Requirement	Route 1	Route 2	Route 3
Duration (min)	90–120	approx. 100	approx. 110	approx. 135
Distance (km)	n/a	79	94	141
Urban share (%)	29–44	38	37	30
Rural share (%)	23–43	28	26	14
Motorway share (%)	23–43	34	37	56
Cumulative altitude gain (m/100 km)	< 1200	813	860	470
Altitude range (m)	< 1300	190–300	190–420	110–300



Figure 5: Real-world driving routes—altitude profiles

Test matrix

The real-world driving test program on Routes 1-3 is shown in Table 5. During all tests with both vehicles, the automatic transmission was set to the predominant gearshift mode D and the automatic air-conditioning mode was used. The Golf TDI was tested multiple times on each route whereas the Golf TSI project timeline allowed for only one test for each test type.

Table 5. Real-world driving—test matrix

Route	Golf TDI	Golf TSI
Route 1	4 tests at 28°C-32°C	1 test at -25°C
Route 2	1 test at 25°C-30°C 1 test at 30°C-35°C	1 test at -30°C
Route 3	1 test at 30°C-35°C 1 test at 25°C-30°C	1 test at 20°C-25°C

3. RESULTS AND DISCUSSION

3.1 LABORATORY TEST RESULTS

All chassis dynamometer results discussed in this chapter are based on the analysis results of the exhaust gas collected by the CVS system in a bag for each test cycle phase. The results have not been corrected for any influence of ambient temperature, change in battery charge level, or particulate filter regeneration. Laboratory tests, where a particulate filter regeneration occurred, were considered void and removed from the analysis.

Comparison to type-approval values

Both vehicles are type approved under the NEDC test procedure, for which the Golf TDI has a declared CO₂ emission value of 117 g/km and the Golf TSI of 113 g/km. NEDC measurement results are shown in the left-hand graph of Figure 6. Measurement of CO₂ emissions in the NEDC at 23°C resulted in 124 g/km for the Golf TDI test and 109 g/km in both tests performed with the Golf TSI. The difference between measured and declared CO₂ value of 7 g/km (+6.0 %) for the Golf TDI is at the lower end of the deviation that the European Commission expects from the exploitation of test flexibilities by the manufacturers (Tsiakmakis, Fontaras, Ciuffo, & Samaras, 2017). The results of the Golf TSI being 4 g/km (-3.5 %) below the manufacturer declared value could therefore indicate that the applied NEDC road load parameters are somewhat lower than the values used by the manufacturer for type approval.

In the WLTC tests performed at 23°C, the Golf TDI emitted 139 ± 2 g CO₂/km and the corresponding Golf TSI CO₂ emissions were 126 ± 1 g/km. This results in a WLTC to NEDC type-approval CO₂ emission ratio of 1.19 for the Golf TDI and 1.12 for the Golf TSI, which is in the range expected in Tsiakmakis, Fontaras, Ciuffo, et al. (2017).

Effect of ambient temperature

Additional NEDC and WLTC tests at 10°C and 14°C respectively were performed with both vehicles, which is to say at ambient temperatures deviating from type-approval conditions. NEDC tests at 30°C and a WLTC test at -7°C were performed only with the Golf TDI. The comparison of the cycle CO₂ emissions at different ambient temperatures is shown in Figure 6 as well.

The CO₂ emissions of the diesel vehicle are for all temperatures and in both test cycles higher than for the corresponding gasoline vehicle tests and decrease for both vehicles with increasing ambient temperature. This is expected, as lower ambient temperatures negatively affect the vehicle fuel efficiency, especially for cold-start tests. In cold-start tests, the friction in the power train increases and the engine coolant takes longer to warm up, hence at lower ambient temperatures the negative cold-start effects prevail longer. The increased air density at lower ambient temperatures also results in a higher air drag. The latter effect is taken into account only for the test at -7°C, where the respective road load parameter is increased by 10%.

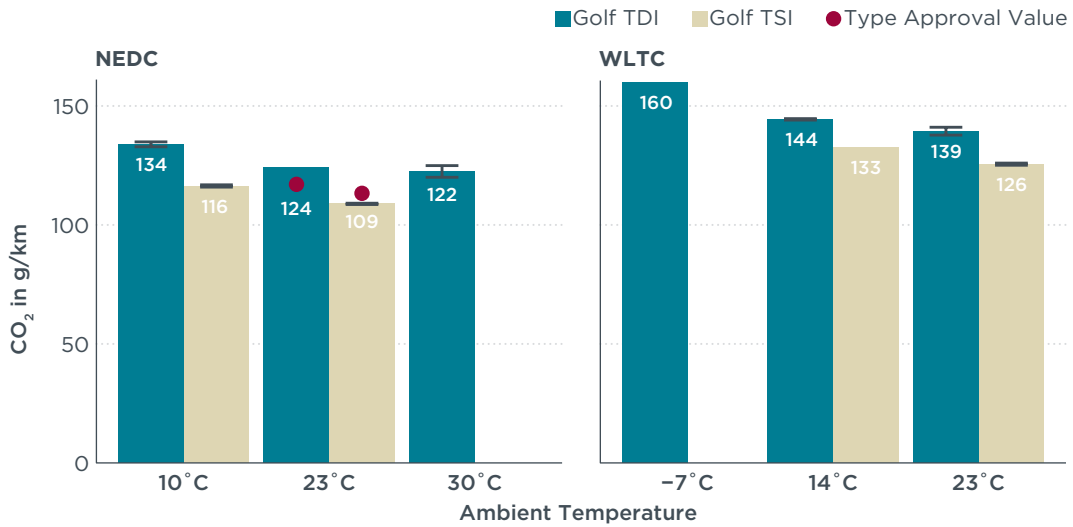

Figure 6: Effect of ambient temperature on cold-start WLTC- and NEDC-specific cycle CO₂ emissions. The error bars show the minimum to maximum range of results if multiple tests were performed. No error bar is shown if only one test was performed. The NEDC type-approval emissions are shown with red dots.

Effect of coolant temperature at test start

Lower coolant temperatures negatively affect the CO₂ emissions. This means a cold-started vehicle generates more CO₂ in the same test than a warm-started one. To investigate this effect for the tested vehicles, NEDC and WLTC tests were performed with both cold and warm engine coolant at test start. The results of these tests at 23°C are shown in Figure 7. The comparison shows that the CO₂ advantage of the Golf TSI remains also for the warm-start tests. The CO₂ penalty for a cold-start test in the NEDC is about 10 g/km for both vehicles. The penalty in the WLTC is approximately half of the respective NEDC value, which is mainly the consequence of the longer WLTC test duration⁷ and thereby the relatively lower impact of the cold start on the cycle average emissions.

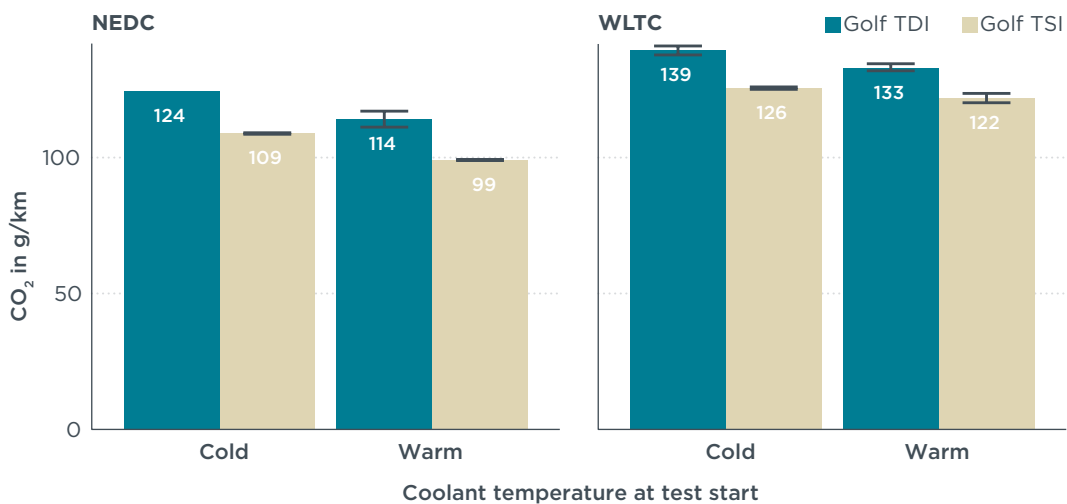

Figure 7. Effect of engine coolant temperature at test start on CO₂ emissions—Comparison of Golf TDI and Golf TSI in NEDC and WLTC tests at 23°C. The error bar shows the minimum to maximum range of results if multiple tests were performed. No error bar is shown if only one test was performed.

⁷ The WLTC takes 30 minutes, whereas the NEDC duration is only 20 minutes.

For a more detailed analysis, the CO₂ emissions of the different test cycle phases of cold- and warm-start NEDC and WLTC are shown in Figure 8. The CO₂ emission increasing effect of a cold start is clearly visible for the urban phase of the NEDC for both vehicles. In the extra urban phase, however, only the Golf TDI emissions are still notably higher for the cold-start test whereas the Golf TSI CO₂ emissions are almost at the same level as for a test with a warm-started engine. The WLTC test results show a similar trend. The Golf TDI CO₂ emissions during the low and medium phases are considerably increased for the cold-start test and reach the values of the warm-start test only in phase high and extra high. The cold start CO₂ emissions of the Golf TSI, on the other hand, already have almost stabilized at the level of the warm-start test after the low phase with only a small effect observed in the medium phase.

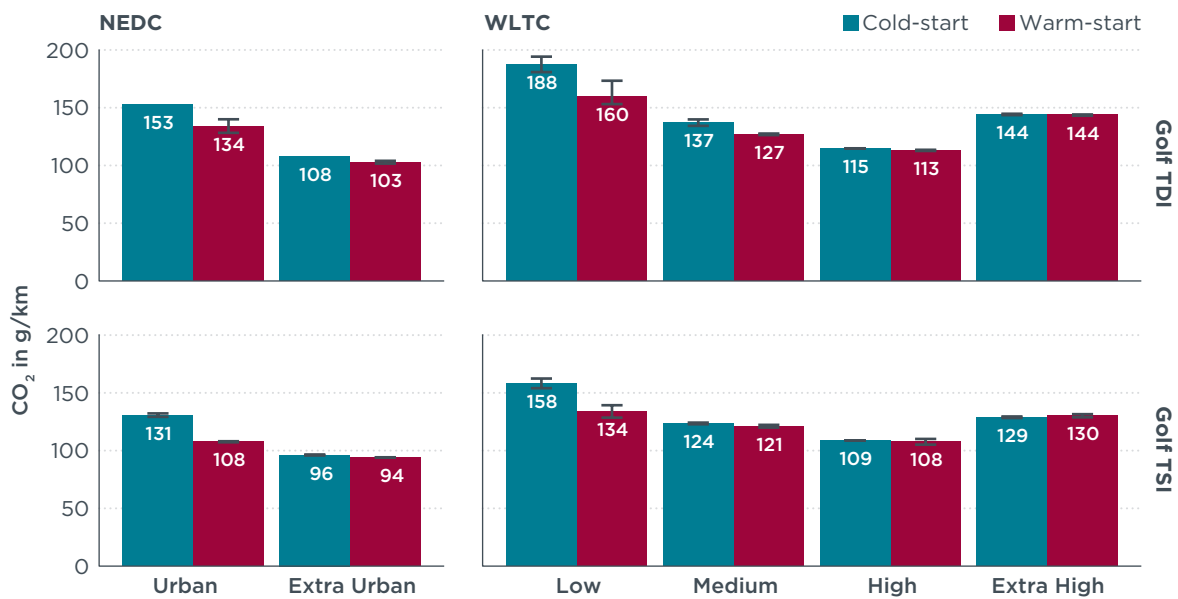

Figure 8. Comparison of phase CO₂ emission levels—Cold- versus warm-start NEDC and WLTC at 23°C. The error bar shows the minimum to maximum range of results if multiple tests were performed. No error bar is shown if only one test was performed.

Engine warm-up behavior. These observations can be explained by comparing the second-by-second coolant temperature profiles of the warm- and cold-start tests as shown in Figure 9 for the NEDC and Figure 10 for the WLTC. The figures also show the recorded vehicle speed signal and, for the Golf TSI only, the position of the rotary valve for coolant temperature control. This signal was recorded only on the Golf TSI. For the analysis, a coolant temperature of 80°C was assumed to be the threshold for the end of the cold start.

For the NEDC, shown in Figure 9, the Golf TDI coolant temperature reaches 80°C just before the end of the test after approximately 1,100 seconds but never reaches the level of the warm-start test. The gasoline engine of the Golf TSI, however, requires only about half the time to complete the warm-up and reaches the temperature profile of the warm-start test at the end of the urban phase.

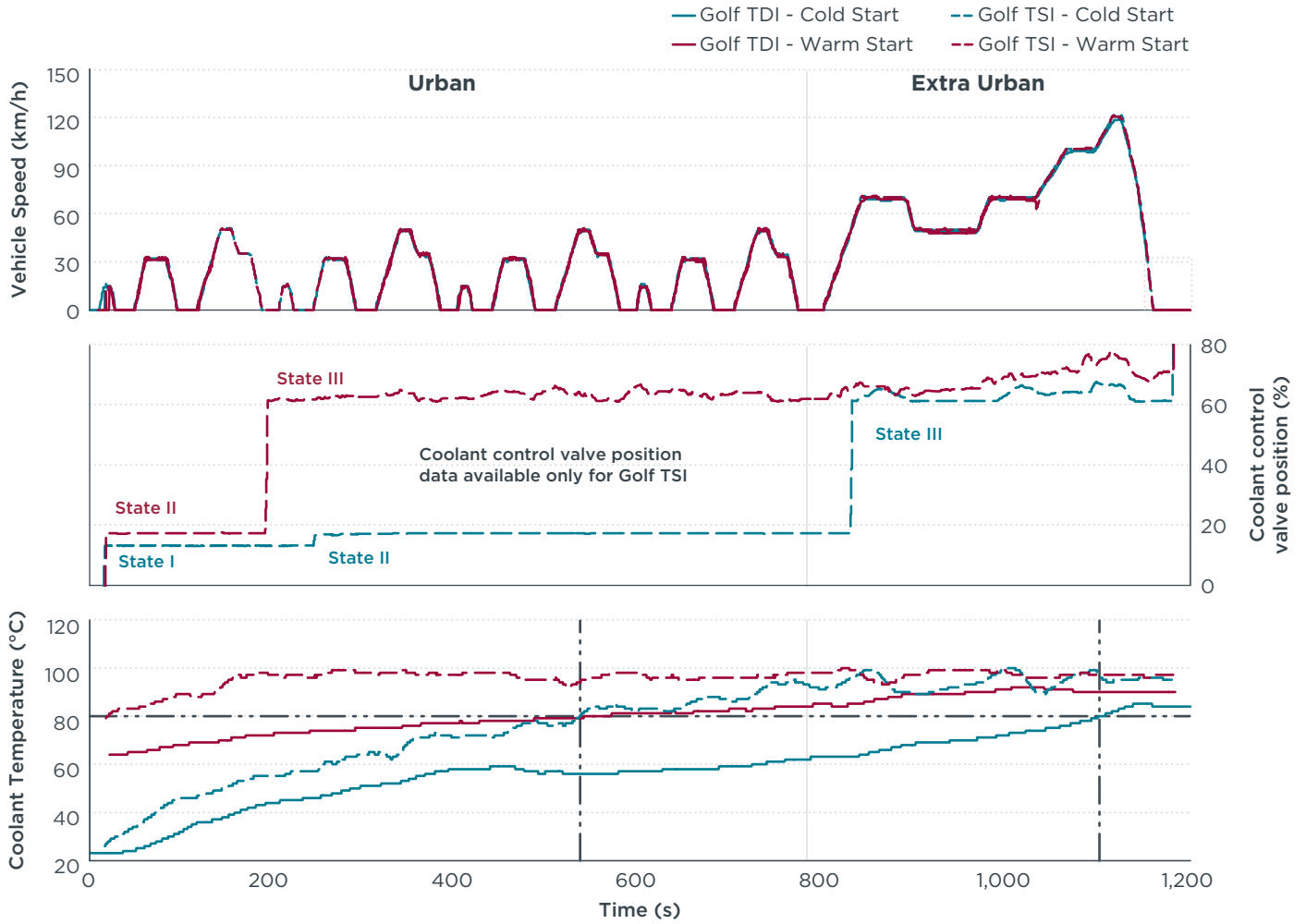

Figure 9. Coolant temperature of cold- versus warm-start NEDC at 23°C. The Golf TSI completes the engine warm-up within the urban phase whereas the Golf TDI requires approximately twice as long to reach the 80°C temperature threshold. The vertical bars in the bottom graph indicate the time needed to reach 80°C coolant temperature (horizontal line) for a cold-started Golf TDI and Golf TSI test respectively. The coolant control valve position information is available only for the Golf TSI.

The WLTC coolant temperature records in Figure 10 show that the Golf TSI engine reaches 80°C well within the low phase of the WLTC and the coolant temperature level of the warm-start test is reached early in the medium phase. The diesel engine coolant, however, reaches the warm-up threshold only toward the end of the medium phase and the level of the warm-start test not before well into the high phase.

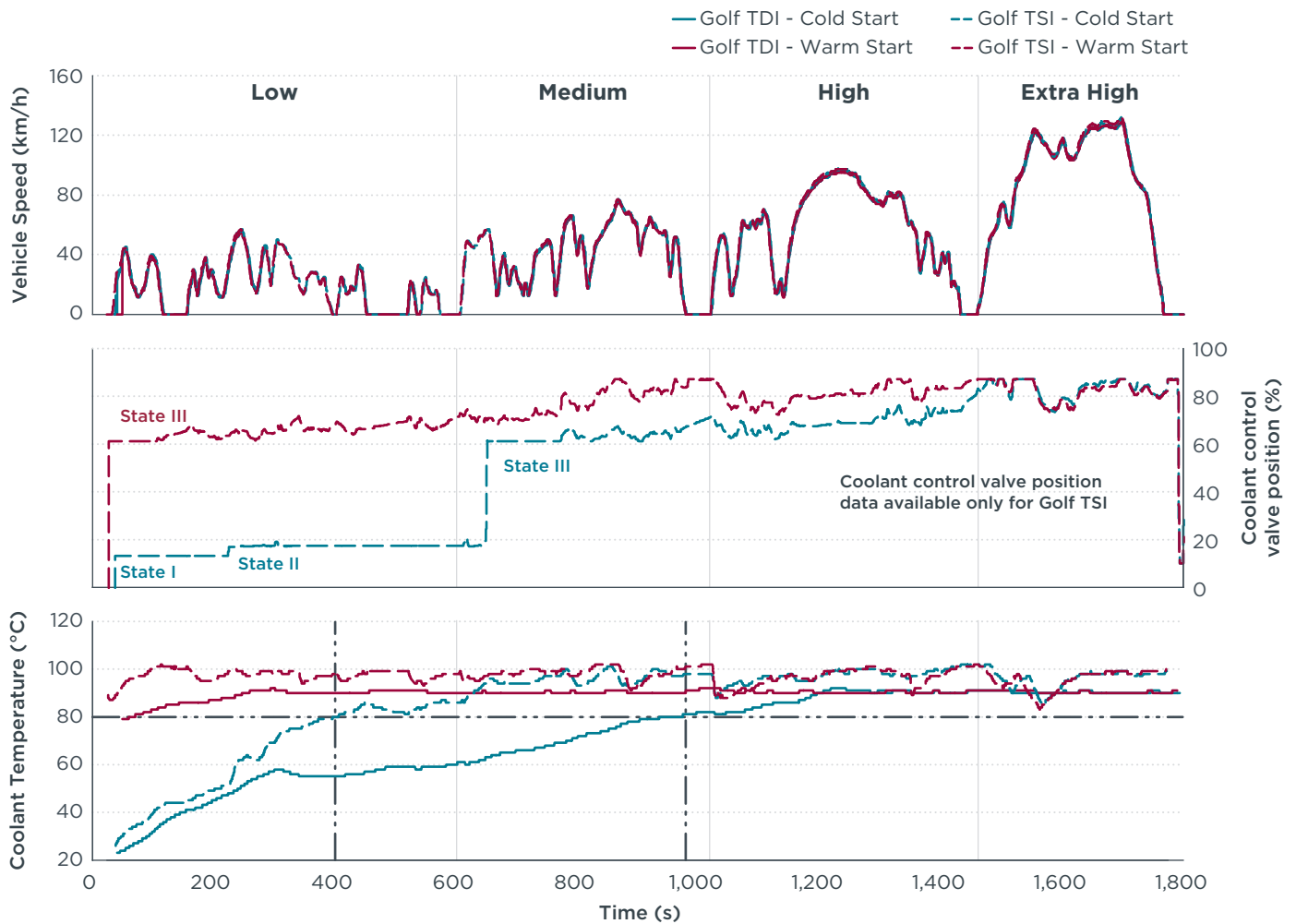

Figure 10: Coolant temperature of cold- versus warm-start WLTC at 23°C. The Golf TSI completes the engine warm-up within the low phase whereas the Golf TDI coolant temperature does not reach the warm-up threshold before the end of the medium phase. Coolant control valve data exist only for the Golf TSI. The vertical bars in the bottom graph indicate the time needed to reach 80°C coolant temperature (horizontal line) for a cold-started Golf TDI and Golf TSI test, respectively.

This large difference in engine coolant warm-up rate was anticipated to be primarily attributable to the higher heat capacity, better thermal efficiency, and lower combustion temperature of the larger displacement diesel engine, but also to the active coolant temperature control and the cylinder head integrated exhaust manifold of the Golf TSI. The coolant control valve position was recorded on the Golf TSI and is shown for the NEDC and WLTC in the middle graph of Figure 9 and Figure 10, respectively. With this information, the applied strategy can be analyzed. At cold start, the coolant temperature control is in State I. In this state, the coolant inside the engine is not circulated and consequently warms up very quickly. At a coolant temperature of approximately 50°C to 60°C, the system switches to State II, at which point the coolant is circulated through the engine, engine oil heat exchanger, and vehicle interior heater. When a temperature of 85°C to 95°C has been reached, the valve is used to actively control the coolant temperature relative to a setpoint by regulating the flow through the radiator (State III) (VW AG, 2018).

Golf TSI rapid catalyst warm-up strategy. Despite the faster engine warm-up of the Golf TSI, the relative CO₂ emission increase in the first phase of the NEDC between the cold- and warm-start tests at 23 °C is higher for the gasoline vehicle (21.3 % increase) than for

the diesel vehicle (14.2 % increase), as illustrated in Figure 8. This is likely attributable to the rapid catalyst heat up strategy applied by the Golf TSI engine, as shown in Figure 11. The graphs show a comparison of the first 100 seconds of the cold- and warm-start WLTC and NEDC, respectively, performed with the Golf TSI at 23°C. Even though the first seconds of engine data were not recorded, the rapid catalyst heat up strategy is still clearly discernible. For both test types, the ignition timing is significantly delayed for the cold-start tests, resulting in a retarded and thereby less efficient combustion. This raises the exhaust temperature at the inlet of the close-coupled TWC to 335°C but comes at the cost of considerably increased CO₂ emissions. The heat up is accompanied by an elevated engine idle speed of about 1,000 rpm and suspension of the engine start-stop system, as the NEDC test data show.

The data indicate that the catalyst heat up strategy is active only for approximately 40 seconds in the cold-start WLTC. During that period, the engine emits 43 g more CO₂ than during a warm-start test. In the case of NEDC testing, the observed heat up duration is approximately 60 seconds and the related CO₂ penalty is 67 g. At the end of the rapid heat up, the exhaust aftertreatment system has reached hydrocarbons light-off temperature.

No heat up strategy could be identified on the Golf TDI, but noting that fewer engine signals were measured for this vehicle, only a less detailed investigation was practical.

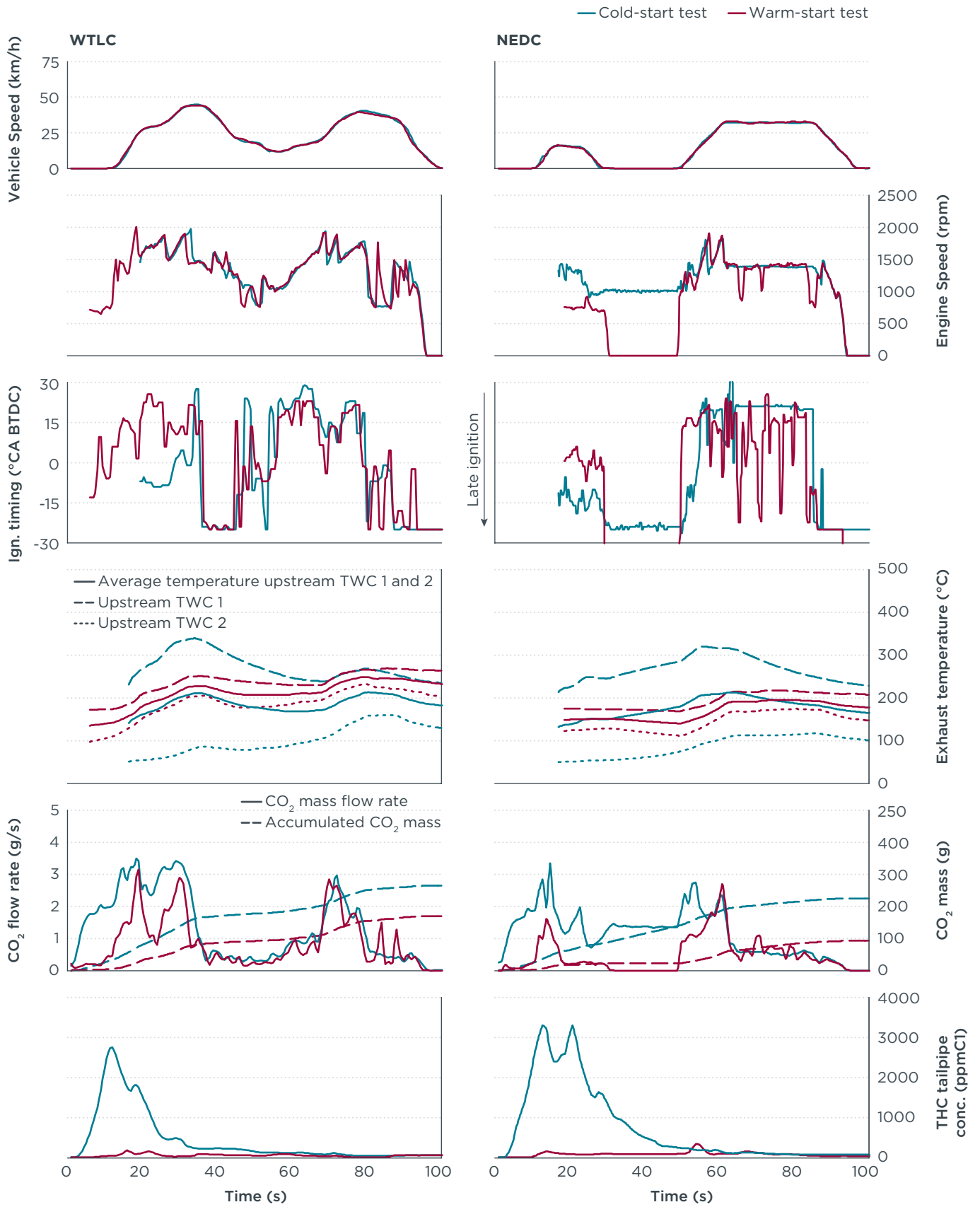

Figure 11. Golf TSI rapid catalyst heat up strategies in WLTC and NEDC at 23°C.

Alternator power demand. The CO₂ penalty due to the rapid catalyst heat up strategy as discussed above was observed only during the engine warm-up phase of the cold-start tests, but not for a warm-start test. Even without catalyst heat up, CO₂ emissions during a cold start are higher than for a warm engine because of increased friction and thermal losses. The total CO₂ emissions of cold-start tests were therefore expected to be higher by at least the CO₂ amount emitted during the catalyst heat up, compared to the respective warm-start test.

However, as shown for two WLTC tests in the second graph of Figure 12, the delta in CO₂ mass between the cold- and warm-start test at the end of the entire test is only 29 g, which is considerably lower than the 43 g at the end of the warm-up phase, i.e., after 40 seconds (see Figure 11).

The explanation for this unexpected observation can be found in the different alternator power demand for cold- and warm-start tests. The third graph of Figure 12 shows for two WLTC tests that during the cold-start test, the alternator is mainly actuated in the overrun⁸ phases, generating power with as little impact on fuel consumption as possible. In contrast, during the warm-start test, the alternator is activated continuously when the engine is running. The accumulated alternator energy output shown in the fourth graph of Figure 12 is thereby almost twice as high during a warm-start test than for a cold-start test. This behavior is repeatable and was also observed in NEDC tests. Reducing the engine load by not actuating the alternator results in lower cycle CO₂ emissions. However, the electric energy not produced by the alternator must be provided by the battery instead, which needs to be recharged in subsequent drive cycles, producing higher CO₂ emissions. The NEDC test procedure, which was used for the type approval of the Golf TSI, does not contain any mechanism to correct the type-approval CO₂ emissions for changes in the battery state of charge (Pavlovic, Ciuffo, Fontaras, Valverde, & Marotta, 2018). This loophole was closed in the WLTP by introducing a correction procedure, which contains a formula to calculate the battery energy change equivalent CO₂ mass (European Commission, 2017). This formula was used to approximate how much less CO₂ is emitted in a cold-start WLTC due to this difference in alternator actuation. For the WLTC tests compared in Figure 12, the difference in the measured alternator power is equivalent to a total of 82 g less CO₂ during the cold-start test than during the warm-start test, which is equivalent to 3.5 gCO₂/km. As the smaller CO₂ difference at the end of the entire test compared to the end of the catalyst heat up reveals, cold-start effects that increase fuel consumption—such as higher friction and heat losses, and even part of the CO₂ emission increase due to the rapid catalyst heat up—are compensated for by exploiting this loophole.

Further analysis must be performed to better understand the potential effects of such alternator operating strategy on the upcoming post-2020 CO₂ standards (European Union, 2019). For 2021, each manufacturer's CO₂ targets will be determined based on the ratio of its WLTP and NEDC fleet emissions in 2020 (Dornoff, Miller, Mock, & Tietge, 2018). Whereas the WLTP CO₂ emissions are corrected for changes in the battery charge level, the equivalent NEDC values are not. Depleting the battery more during the WLTP type-approval test will therefore increase the WLTP to NEDC CO₂ ratio and eventually inflate the manufacturer's CO₂ target for 2021 onward.

Because no alternator power measurements were performed for the Golf TDI, a similar analysis could not be performed. However, the exploitation of the battery discharge loophole is considered common practice for NEDC type approval (Pavlovic et al., 2016). Taking into account that both vehicles are from the same manufacturer, it was

⁸ Overrun is the state where the engine crankshaft is propelled during deceleration or downhill driving when it is connected through the driveshaft with the driven wheels.

considered likely that the Golf TDI engine shows a similar alternator operating strategy and therefore the decision was made not to correct the CO₂ emissions of the cold-start Golf TSI measurements by the procedure defined in the WLTP regulation.



Figure 12. Golf TSI alternator power generation in cold- and warm-start WLTC at 23 °C. Alternator energy equivalent CO₂ mass is approximately 82 g higher for the warm-start than for the cold-start test.

Effect of trip composition and duration. For short trips, the elevated CO₂ emissions of an engine cold start have a larger impact on the cycle CO₂ emissions whereas they are more leveled out in longer distance trips. A study by the Technical University Dresden on mobility in German cities reveals that many real-world vehicle trips are much shorter and driven at a significantly lower average speed than the WLTC (Ahrens, 2014). Therefore,

CO₂ emissions of the two test vehicles for a representative trip performed by urban citizens in Germany were estimated on the basis of the WLTC phase results. On average, such a trip has a length of 10–11 km, driven at an average speed of 28–33 km/h. A trip with these characteristics can be synthesized by concatenating the low phase and 1.5 times the medium WLTC phase. This results in a trip with a total distance of 10.2 km at an average speed of 29.7 km/h. For simplification, this trip from here on is called the *city trip*.

To determine which phase CO₂ emissions to consider for the calculation of the city trip emissions, the coolant temperature profiles shown in Figure 10 were taken in to account. The Golf TDI reaches 80°C at the end of the medium phase. Hence, the CO₂ emissions for the cold-start city trip were calculated with the WLTC cold start results of the low phase and 1.5 times the warm-start emissions of the medium phase. Considering that the Golf TDI does not reach the coolant temperature level of the warm-start test in the medium phase, the calculated CO₂ emissions are a bit lower than the values expected for a measurement in such a test on the chassis dynamometer. To account for this simplification, and recognizing that the Golf TSI reaches the coolant temperature level of the warm-start test very early in the medium phase, the Golf TSI CO₂ emissions of the cold-start city trip are calculated with the WLTC cold-start emissions of the low phase and 0.5 times of the medium phase plus the warm-start emissions of the medium phase. The CO₂ emissions of both vehicles for the equivalent warm-start city trip were calculated using the CO₂ emissions of the low phase and 1.5 times the medium phase of the warm-start WLTC.

The result of this analysis is shown in Figure 13. For a warm-start WLTC, the Golf TDI CO₂ emissions are on average 9.0% higher than for the Golf TSI. The difference between the two vehicles would be 9.6% in case of the city trip due to the shorter total distance and the different trip composition. Due to the longer warm-up of the Golf TDI, the difference in CO₂ emissions of the cold-start tests increases disproportionately from 10.3% for the WLTC to 13.0% for the city trip. This means that the CO₂ benefit of the gasoline powered vehicle would be even more pronounced on a shorter, cold-start trip, as for example this exemplarily analyzed WLTC-based city trip.

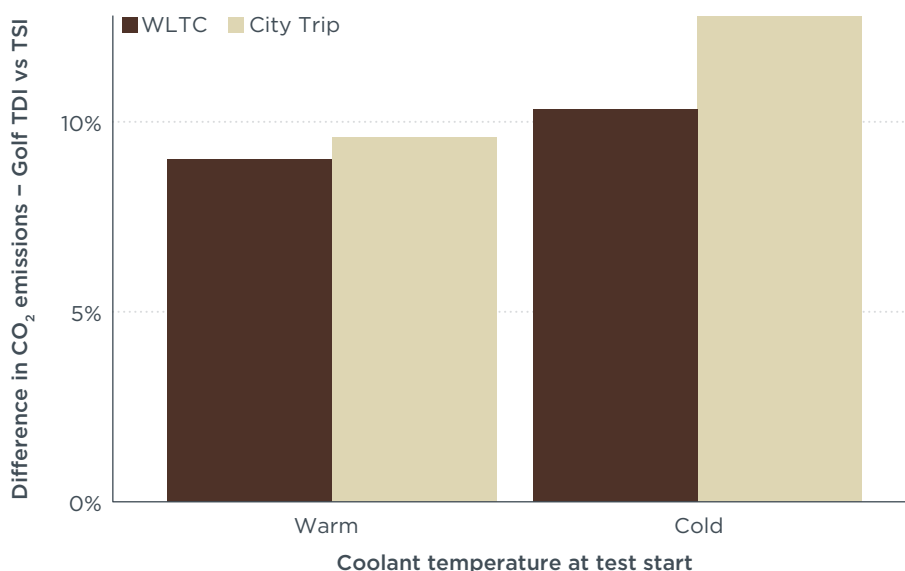

Figure 13. Comparison of the relative difference in cycle CO₂ emissions of the Golf TDI and Golf TSI for both a cold- and warm-start WLTC at 23 °C and a test with a representative duration and distance for trips performed by the German urban population.

3.2 REAL-WORLD DRIVING RESULTS

The CO₂ emission test results discussed in this section are based on the second-by-second CO₂ mass flow and vehicle speed data determined by the PEMS equipment. No normalization or weighting of the raw data were performed. For a detailed analysis, the measurement results were clustered depending on the vehicle speed at each data point. Those clusters are referred to as *urban* for vehicle speeds of 60 km/h or lower, *rural* for speeds above 60 and up to 90 km/h, and *motorway* above 90 km/h, as defined by the RDE regulation (European Commission, 2017).

It should be noted that the RDE test procedure was not developed with the intention to determine comparable CO₂ emissions. Whereas pollutant tailpipe emissions can be reduced relatively independent of the engine operating point by exhaust aftertreatment, CO₂ emissions are directly dependent on the power demanded from the engine during a drive cycle. They are therefore affected by route, driving style, traffic conditions, ambient conditions, payload, and use of auxiliaries.

To reduce the effect of those influencing factors in the real-world driving tests, the vehicles were tested on the same routes by the same drivers with the same type of PEMS equipment in the summer. The vehicles were supposed to be driven in a “normal” driving style, which meant floating with the traffic and avoiding strong accelerations and braking.

However, variations in ambient temperature and driving dynamicity, due to traffic and the subjectivity of driving style, cannot be eliminated entirely when testing under real-world conditions on public roads. For the interpretation of the real-world driving CO₂ emission results, the driving dynamicity is therefore analyzed in this section.

Results

For all real-world driving tests, higher average CO₂ emission levels were measured on the diesel vehicle compared to the gasoline vehicle. Figure 14 shows the CO₂ emissions for all real-world driving tests performed on the three routes listed in Table 5. The left column displays the average emissions of the entire tests whereas the right section shows the details for the three RDE speed regimes—urban, rural, and motorway. If multiple tests were performed on the same route, the bar reflects the average of all tests and the error bar shows the range of results.

During both tests performed with the Golf TDI on Route 3, the vehicle entered DPF regeneration mode at the same time that it entered the motorway. The regeneration performed in the first motorway section took 15 to 20 minutes. For the analysis, the CO₂ emissions during the DPF regeneration were removed and instead, the CO₂ emissions measured during the second highway section on Route 3 were used to estimate the total highway CO₂ emissions. This approach is expected to deliver a reasonable estimation as the same highway section is driven two times on Route 3 (see speed profile in Figure 15). The average emissions of the entire test were calculated by weighting the urban, rural, and motorway phase CO₂ results with the original distance shares of the uncorrected test.

As Figure 14 shows, the difference in total cycle CO₂ emissions between the Golf TDI and Golf TSI is in a similar range for all routes. However, the CO₂ emissions of both vehicles are higher on Route 1 and Route 2 than on Route 3. The Golf TDI results on Route 2 show a high test-to-test variation, especially in the urban section, reflected in the large range of the error bar.

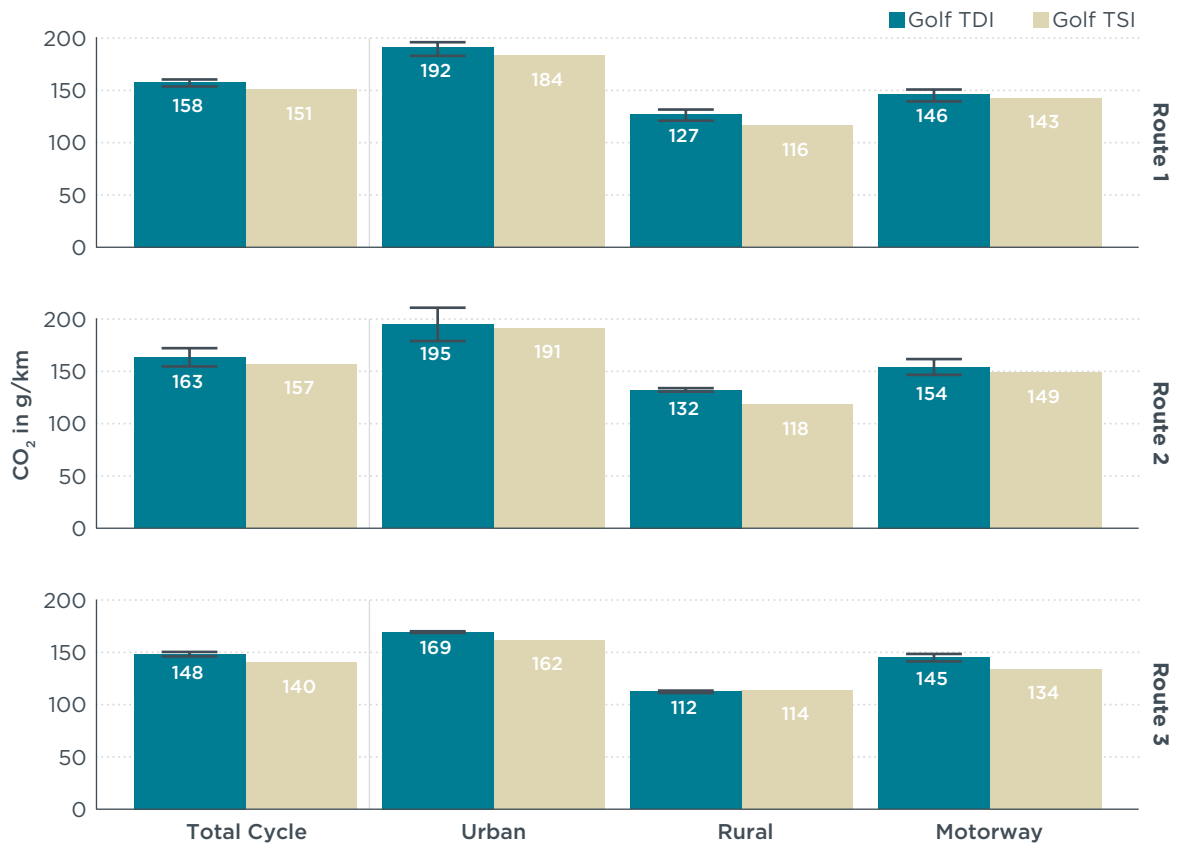

Figure 14. Real-world driving – CO₂ emissions of the Golf TDI and Golf TSI for tests performed on three different routes. The bars show the average value for all tests performed with the same vehicle on one route. The error bars show the minimum to maximum range of results if multiple tests were performed on one route. No error bar is shown if only one test was performed. The Golf TDI tests on Route 3 were corrected for the particulate filter regeneration.

Comparability

Figure 15 shows the recorded speed profiles of the two vehicles for all analyzed tests performed on the three routes. Overall, the speed profiles show good agreement except for the following instances. For one test with the Golf TDI on Route 1, the last phase was driven at a notably lower speed than for the other tests on the same route. However, the speed profile during this incident is similar to the one of the rural sections and the effect on the specific CO₂ emissions is relatively small, indicated by the low test-to-test variation shown in Figure 14.

On Route 3, the Golf TSI was driven at a higher speed at the end of the first and the beginning of the second highway phase and after 60 kilometers had to perform a heavy acceleration, from about 15 to 80 km/h, which did not occur in the Golf TDI tests.

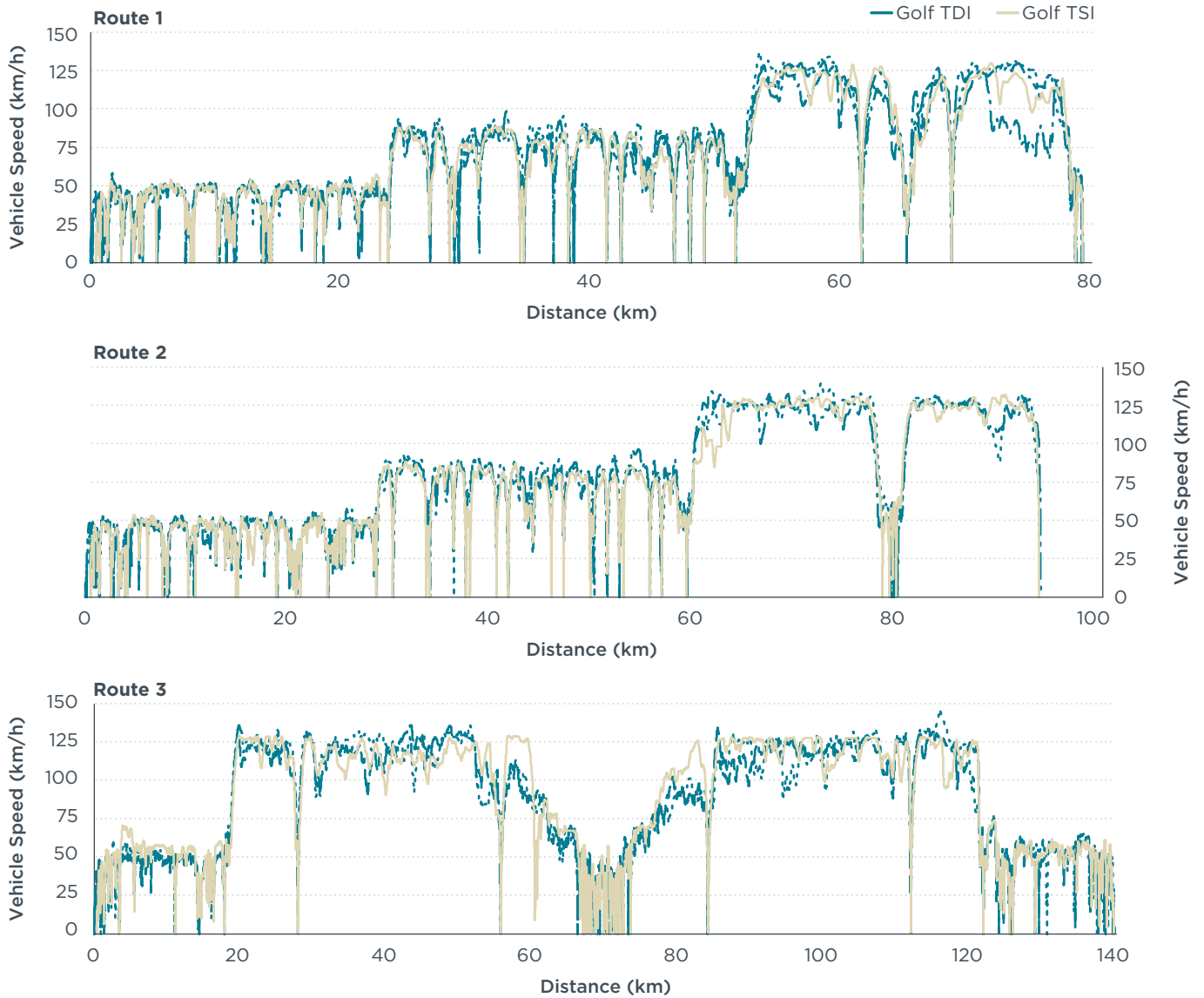

Figure 15. Speed profiles of tests performed with the Golf TDI and Golf TSI on Route 1, Route 2, and Route 3. Only one test on each route was performed with the Golf TSI. Multiple tests were performed on each route with the Golf TDI. These tests are distinguished by the line type.

Analysis of driving dynamicity. For a more detailed analysis of the driving dynamicity, the instantaneous vehicle specific power (VSP) was calculated (Jiménez-Palacios, 1999). VSP is a metric for the instantaneous power demand at the wheel per vehicle mass. The formula for VSP calculation was adapted using the VW Golf vehicle parameters as shown in Equation 1. By applying the same parameters for both vehicles, VSP is dependent only on route characteristics (road grade, g_{Road}) and driving style (vehicle speed, v_{veh} , and acceleration, a_{veh}) and therefore can be used to compare the driving style of the different real-world driving tests. The wind speed was not measured and was therefore set to zero. Meteorological data for the testing period reports a low average wind speed of 3 to 9 km/h and with only little variation in direction. The error made by not considering the wind speed effect is therefore considered negligible for the comparison. The road grade was calculated based on the GPS altitude signal following the procedure defined in (EU) 2018/1832 (European Commission, 2018).

$$VSP = v_{Veh} \times [i_{rot} \times a_{Veh} + 9.81 \times gr_{Road} + 9.81 \times c_R + \frac{1}{2} \times \frac{\rho_{Air} \times c_D \times A_{Front}}{m_{Veh}} \times (v_{Veh} + v_{Wind})^2] \quad (1)$$

where:

- i_{rot} is the rotational mass factor, set to 1.06
- v_{Veh} is the vehicle speed, in m/s
- a_{Veh} is the vehicle acceleration, in m/s²
- v_{Wind} is the longitudinal wind speed component, in m/s, set to 0
- c_R is the representative tire rolling resistance coefficient
- c_D is the representative aerodynamic resistance coefficient
- ρ_{Air} is the ambient air density, in kg/m³
- A_{Front} is the frontal surface of the vehicle, in m²
- m_{Veh} is the average vehicle mass, in kg
- gr_{Road} is the road grade, in m/m

The VSP values were calculated for each second and subsequently sorted in the same urban, rural, and motorway speed bins as the PEMS data. VSP values of zero or less were removed for the analysis.

To explain the effect of the VSP distribution on the CO₂ emission, Figure 16 shows exemplarily the average cumulative VSP distribution for the Golf TDI of the tests performed on all three routes. The lines represent the average VSP distribution of all tests performed on a route. A curve within each speed bin that is shifted toward higher VSP indicates a more dynamic driving style.

When comparing the Golf TDI VSP distribution to the related CO₂ emission results shown in Figure 14, the following observations can be made. The similarity of the VSP distribution in the urban and rural phases of the tests performed on Routes 1 and 2 suggests a similar driving severity in each speed bin. This correlates well with similar CO₂ emissions of the Golf TDI in those phases. The shift of the VSP distribution to the left, which is to say to lower VSP, for the tests on Route 3 indicate a lower dynamicity, which explains the notably lower CO₂ emissions in the urban and rural parts on this route. In the motorway section, the VSP distribution of the tests on Routes 1 and 3 shows a good correlation, reflected also in similar CO₂ emissions. However, the motorway driving on Route 2 (red line) was performed with a higher dynamicity, which correlates with the higher measured CO₂ emissions.

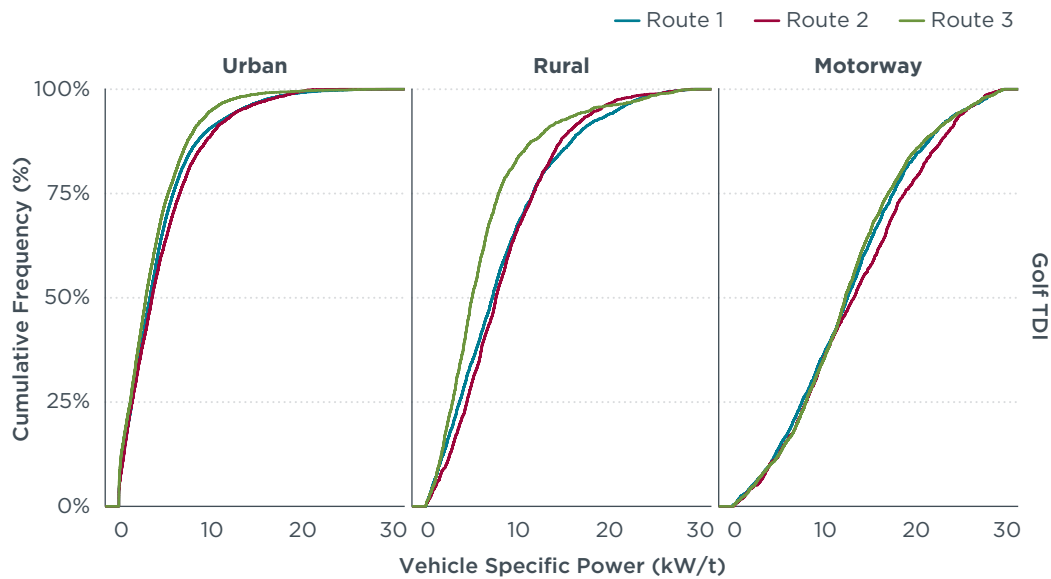

Figure 16. Comparison of the average VSP distribution of tests performed with the Golf TDI on all routes.

For the comparison of the driving dynamicity between the two vehicles on the same route, the Golf TDI and Golf TSI VSP distributions are plotted against each other for all routes in Figure 17. The data are shown separately for each speed bin. When multiple tests were performed on a route, the VSP distribution of each single test is shown as a thin line and the average distribution of all tests is displayed as bold curve.

The average VSP distributions of the Golf TDI and Golf TSI show good agreement in the urban phase for all routes. This is also reflected in the average CO₂ emissions, where the difference between the Golf TDI and Golf TSI is in a similar range for all three routes. The slightly larger difference for Routes 1 and 3 likely is attributable to different ambient temperatures, as discussed below.

In the rural sections of Routes 1 and 2, the Golf TDI was operated more dynamically than the Golf TSI, indicated by a VSP distribution shifted toward higher VSP. This corresponds to a larger CO₂ emission difference between the Golf TDI and Golf TSI. When driven with a dynamicity comparable to the Golf TDI, higher CO₂ emissions of the Golf TSI are therefore expected. On Route 3, the VSP distribution in the rural phase is similar overall but shows that the Golf TSI was operated more at low and high VSP, whereas the Golf TDI was operated more at medium VSP. Both vehicles have similar CO₂ emissions in this phase.

The average VSP distribution in the highway section is similar for both vehicles on Routes 2 and 3 but shifted toward higher VSP for the Golf TSI on Route 1. However, the difference in CO₂ emissions between the two vehicles is almost the same on Routes 1 and 2. Again, this is likely attributable to differing ambient temperatures. The larger CO₂ deviation observed on Route 3 in the motorway part, however, cannot be explained by the VSP distribution.

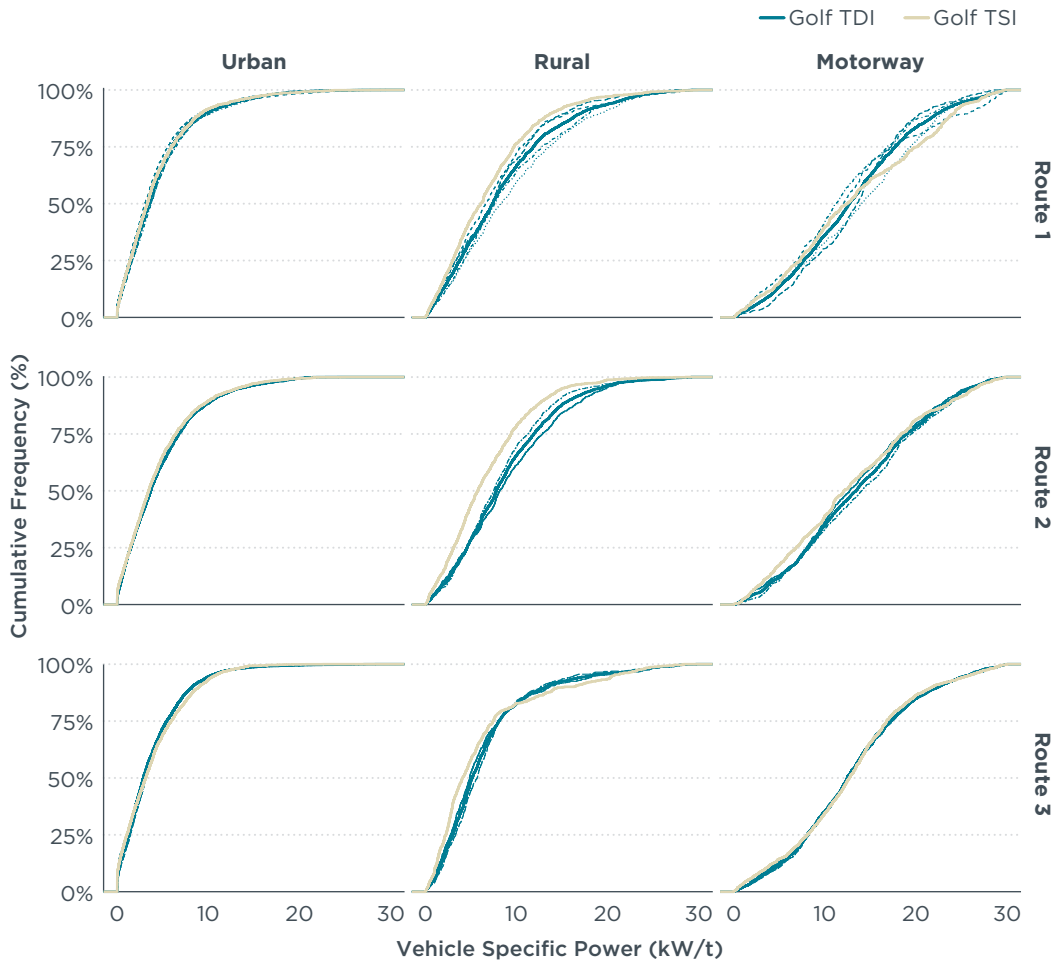

Figure 17. Cumulative distribution of VSP for the real-world driving tests performed on three different routes. In the case of multiple tests performed on one route with the same vehicle, the VSP distribution of the individual tests is shown as thin lines and the average distribution is shown in bold.

Analysis of ambient temperature. The RDE tests have been performed at ambient temperatures between 20°C and 35°C, as shown in Table 5. In all tests, the air conditioning was active in automatic mode. Because the air conditioning consumes more energy at higher ambient temperatures, an effect of the ambient temperature on the CO₂ emissions is expected.

On Route 1, the Golf TSI was tested at 25°C whereas Golf TDI test temperature was between 28°C and 32°C. On Route 2, the Golf TSI was tested at approximately 30°C, which is between the ambient temperatures of the two tests performed with the Golf TDI.

Exemplarily, an analysis of the urban phase results of Route 1 and Route 2, where the impact of air conditioning on the fuel consumption is presumably highest (“Auto-Klimaanlagen im Test”, 2019), is used to understand the effect of the ambient temperature on the CO₂ emissions. For that purpose, the average VSP distribution between the Golf TDI and Golf TSI in the urban phase on Route 1 and Route 2 is plotted against each other in Figure 18. The good agreement of the VSP distributions suggests that both vehicles were driven in a similar manner on both routes. It is therefore reasonable to assume that the Golf TSI CO₂ emissions in the urban part of Route 1 would be at a similar level as the ones measured on Route 2, if the test on Route 1 would be performed at 30°C as well, which means approximately 3% to 4% higher. For the rural and motorway section, a smaller effect is expected.

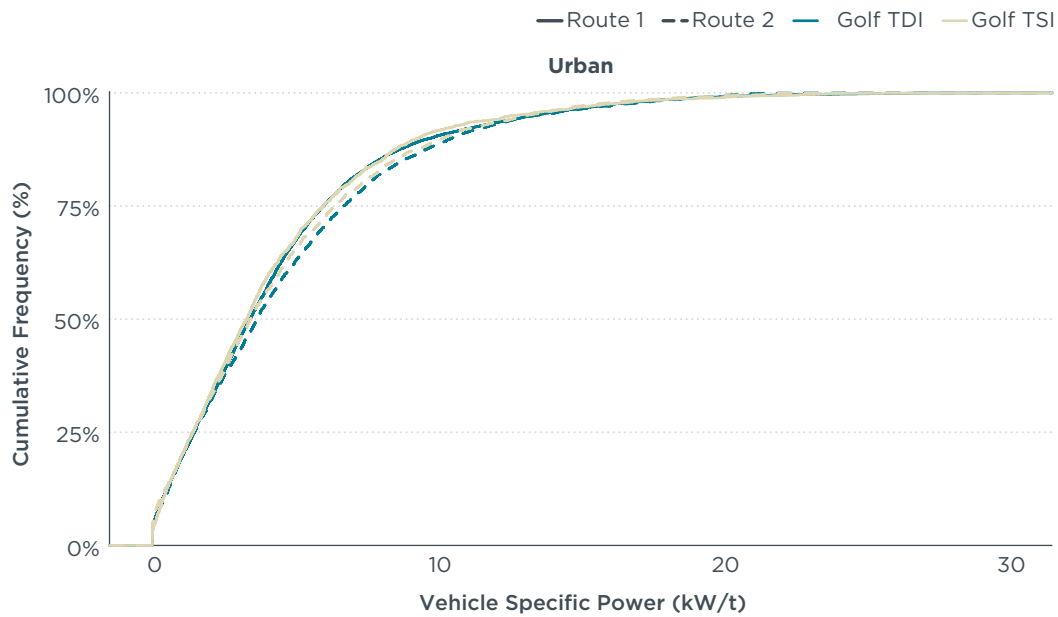

Figure 18. Comparison of the average cumulative VSP distribution for the urban speed bin. The tests performed with both vehicles on Routes 1 and 2 show a good agreement in the VSP distribution.

Overall, the analyses performed suggest that both vehicles have similar real-world CO₂ emissions, with a slight benefit for the Golf TSI. This is especially probable when considering that an additional PEMS for PN emission measurement was installed on the Golf TSI—both increasing the payload slightly and likely having a detrimental effect on the aerodynamic drag—and that the tires mounted on the Golf TSI were one rolling resistance class worse than those on the Golf TDI.

This tendency of lower CO₂ emissions for the Golf TSI also can be observed in the self-reported fuel consumption from consumers on the German website Spritmonitor.⁹ When accessing the website on March 14, 2019, fuel consumption data records were available for 25 Golf TSI and 113 Golf TDI vehicles. The reported fuel consumption of the Golf TSI converted to CO₂ emissions varied from 122 to 211 g/km with an average value of 150 g/km. For the Golf TDI, the CO₂ emissions ranged from 122 to 213 g/km with an average value of 162 g/km. The relatively low CO₂ emission deviation of -3% to 0% in the case of the Golf TDI and 1% to 5% for the Golf TSI between the average measured CO₂ emissions on Routes 1 and 2 and the data reported on Spritmonitor are an indicator that the composition and driving style of the real-world driving tests on those two routes are fairly representative for trips performed by consumers.

⁹ Spritmonitor (www.spritmonitor.de) is an independent German website where consumers can report and track the fuel consumption of their vehicles. A more detailed description can be found in Tietge et al. (2019).

4. CONCLUSIONS AND POLICY RECOMMENDATIONS

The objective of this vehicle testing project was to compare the CO₂ emissions of gasoline and diesel C-segment vehicles, in the laboratory and on public roads. The Volkswagen Golf test vehicles were selected with a focus on comparability from the consumer's point of view, which meant focusing on similar driving performance.

Two versions of the gasoline powered Golf TSI were available, both having the same base engine but one with 96 kW and the other with 110 kW. Whereas the engine power of the diesel powered Golf TDI was 110 kW, its acceleration performance and maximum speed fell between the two gasoline versions. The decision was made to test the gasoline Golf with the 96 kW version because it applies more advanced engine technologies and the declared NEDC CO₂ emissions were almost the same for both versions.

With the aim of analyzing the CO₂ emission performance under a wide range of ambient and driving conditions, NEDC and WLTC chassis dynamometer tests were performed at different ambient temperatures. The real-world driving tests on public roads were performed on three different routes differing in speed and altitude profile.

For all tests performed in the laboratory, the gasoline powered Golf TSI showed lower CO₂ emissions than the comparable diesel powered Golf TDI. As expected, decreasing ambient temperature resulted in higher CO₂ emissions for both vehicles. The CO₂ emission benefit of the Golf TSI also prevailed for warm-start tests. A comparison of cold-start tests with tests started with a warm engine showed that the gasoline engine warms up much faster than the diesel engine. The gasoline engine also performs a fuel intensive, rapid catalyst heat up at the beginning of a cold-start test, which partly counteracts the CO₂ benefit of an engine that warms up more quickly.

Lower CO₂ emissions were also measured for the Golf TSI during the real-world driving. However, because driving on public roads is always subject to some variability in driving dynamicity, and considering that the CO₂ emissions are directly linked to the power demand, an analysis of the driving dynamicity was performed. That analysis suggests that both vehicles, when driven in the same manner at the same ambient conditions, have similar real-world CO₂ emissions, with a slight benefit for the Golf TSI. These findings are also supported by the CO₂ emission values reported by consumers on the independent German website Spritmonitor for the Golf TSI, which are on average lower than those reported for the Golf TDI. As mentioned above, the Golf TSI also is available with a 110 kW engine. For this engine version, with fewer efficiency improving technologies installed, the consumer-reported average CO₂ emissions are at the same level as for the Golf TDI.

The analyses in this paper are based on laboratory and on-road tests of two individual vehicles, so general conclusions about the performance of gasoline versus diesel passenger cars should be derived only with caution. However, the Golf TDI is almost exactly the representative vehicle, in terms of mass and CO₂ emissions, for all new passenger cars registered in the EU in 2017 (Mock, 2018). And the analysis shows that, at least for the popular C-segment, a gasoline vehicle equipped with modern technology can achieve the same or an even lower CO₂ emission level than a comparable diesel vehicle.

The comparison of the current gasoline and diesel VW Golf models with similar C-segment vehicle models of other manufacturers, shown in Table 6, reveals that the CO₂ emissions of the Golf TDI are in the same range as the diesel models of other manufacturers. It also shows that the CO₂ emissions of the Golf TSI are notably lower than the emissions of all other compared vehicles. This leads to the conclusion that

a considerable CO₂ emission reduction can be achieved for other gasoline powered C-segment vehicles as well.

Table 6. NEDC type-approval CO₂ emissions of current C-segment diesel and gasoline vehicles with comparable performance parameters as the latest Golf TDI and TSI. The table shows data for two-wheel driven, hatchback vehicle models equipped with automatic transmission.

Brand	Model	Variant	Fuel type	Power (kW)	Max speed (km/h)	0-100km/h (s)	CO ₂ (g/km)
VW	Golf	2.0 TDI SCR	Diesel	110	216	8.7	116-118
BMW	1-series	118d	Diesel	110	212	8.2	115-118
Fiat	Tipo	1.6 MultiJet DCT	Diesel	88	199	10.1	118
Ford	Focus	2.0-I-EcoBlue	Diesel	110	207	9.3	114-121
Mercedes	A-Class	A 200 d	Diesel	110	220	8.1	107-113
Peugeot	308	1.5 I BlueHDi	Diesel	96	206	9.4	98
Renault	Megane	Blue dCi 150 EDC	Diesel	110	205	9.3	124
VW	Golf	1.5 BlueMotion TSI	Gasoline	96	210	9.1	111-113
VW	Golf	1.5 BlueMotion TSI	Gasoline	110	216	8.3	116-119
BMW	1-series	118i	Gasoline	100	210	8.7	134-140
Fiat	Tipo	1.4 T-Jet ^a	Gasoline	88	200	9.9	163
Ford	Focus	1.5-I-EcoBoost	Gasoline	110	208	8.9	133-138
Mercedes	A-Class	A 180 ^a	Gasoline	100	215	9.2	127-132
Peugeot	308	1.2 I PureTech	Gasoline	96	205	9.8	124
Renault	Megane	TCe 140 EDC PF	Gasoline	103	205	9.2	125

^aVehicle model available only with manual transmission.

Data Sources: BMW (2019), Fiat (2019), Ford (2019), Mercedes-Benz (2018), Peugeot (2018), Renault (2019), VW AG (2019a).

It is worthy of note that despite the extensive technology package deployed on the VW Golf gasoline engine to achieve low CO₂ emissions, the Golf TSI comes at a significantly lower price than the Golf TDI. The 2018 Golf TSI is 3,400 euros cheaper than the equivalent Golf TDI of the same model year (VW AG, 2017).

This price difference has even increased to more than 3,600 euros for the 2019 model year. This is likely related to the introduction of a selective catalytic reduction system for NO_x reduction in October 2018 for the Euro 6d-Temp type-approved version of the Golf TDI. This system replaces the NSC. However, at the same time, a gasoline particulate filter (GPF) was introduced in the Golf TSI (“Pkw-Modelle mit der Abgasnorm Euro 6d”, 2019; VW AG, 2019a). A comparison with the model year 2018 vehicles shows that neither the introduction of the GPF nor the replacement of the NSC has a notable effect on the type-approval CO₂ emissions (VW AG, 2019a).

Presumably, the efficiency of the diesel engine could also be further improved by deploying some of the CO₂ saving technologies of the gasoline engine. However, this would even further increase the cost of the Golf TDI. A cost-efficient approach would be to use the price advantage of the new gasoline engine to further improve the CO₂ emissions by investing in lightweighting, electrification, or other fuel-saving engine and vehicle technologies.

This might help to reach similar or even lower CO₂ emissions with the gasoline engine also in larger and heavier vehicles. For example, the Volkswagen Passat station wagon, a D-segment vehicle, is offered with both the new gasoline engine in the 110 kW version and the diesel engine with 110 kW. Here, the CO₂ emissions of the diesel

version with 113–117 g/km are still lower than the 124–126 g/km declared for the gasoline vehicle, but only by 9–11 g/km, which is equivalent to 8%–10% (VW AG, 2019b). Considering the current price premium of more than 2,500 euros for the Passat diesel, it is conceivable that a gasoline version applying more lightweighting and efficiency measures would turn out at a CO₂ emissions level comparable to the diesel version, at the same or even lower cost.

However, today diesel fuel is still incentivized by most EU member states through lower fuel taxes (Wappelhorst, Mock, & Yang, 2018). The tax abatement for diesel fuel incentivizes consumers to choose a diesel powered vehicle, even if the equivalent gasoline vehicle has a similar fuel consumption, especially when a high annual mileage is driven, as the lower fuel cost compensates for the higher vehicle price. Countries such as France, Switzerland, and the United Kingdom already have or are in the middle of phasing out tax subsidies for diesel fuel. The analysis in this paper shows that, at least for the popular C-size segment, it is possible to offer a gasoline vehicle with the same or even lower CO₂ emission levels than a comparable diesel vehicle—also under real-world driving conditions. As a result, other countries should reassess their fuel and vehicle tax policies, adapting them to the technological progress of recent years and phasing out subsidies for diesel vehicles.

REFERENCES

- Ahrens, G.-A. (2014). Forschungsprojekt "Mobilität in Städten – SrV 2013" [Research project „Mobility in Cities - SrV 2013“]. Retrieved from the Technical University Dresden website, <https://tu-dresden.de/bu/verkehr/ivs/srv/srv-2013>
- Auto-Klimaanlagen im Test [Passenger car air conditioning test]. (2019, February 22). Retrieved from the ADAC website, <https://www.adac.de/rund-ums-fahrzeug/ausstattung-technik-zubehoer/ausstattung/auto-klimaanlagen/>
- BMW. (2019). Der BMW 1er. 3- und 5-Türer [THE BMW 1 Series. 3- and 5-door]. Retrieved from https://www.bmw.de/content/dam/bmw/marketDE/bmw_de/new-vehicles/pdf/F20F21_Preisliste_Maerz_2019_online_01.pdf.asset.1548326562989.pdf
- Demmelbauer-Ebner, W., Persigehl, K., Görke, M., & Werstat, E. (2017). The new 1.5-l four-cylinder TSI engine from Volkswagen. *MTZ Worldwide*, 78(2), 16–23. doi: 10.1007/s38313-017-0009-x
- Dornoff, J., Miller, J., Mock, P., & Tietge, U. (2018). *The European Commission regulatory proposal for post-2020 CO₂ targets for cars and vans: A summary and evaluation* (Briefing) (p. 20). Retrieved from the International Council on Clean Transportation, <https://www.theicct.org/publications/ec-proposal-post-2020-co2-targets-briefing-20180109>
- Eiser, A., Doerr, J., Jung, M., & Adam, S. (2011). The new 1.8 l TFSI engine from Audi Part 1: Base engine and thermomanagement. *MTZ Worldwide*, 72(6), 32–39. doi:10.1365/s38313-011-0062-9
- European Commission. (2017). Commission Regulation (EU) 2017/1151 of 1 June 2017 supplementing Regulation (EC) No 715/2007 of the European Parliament and of the Council on type-approval of motor vehicles with respect to emissions from light passenger and commercial vehicles (Euro 5 and Euro 6) and on access to vehicle repair and maintenance information, amending Directive 2007/46/EC of the European Parliament and of the Council, Commission Regulation (EC) No 692/2008 and Commission Regulation (EU) No 1230/2012 and repealing Commission Regulation (EC) No 692/2008. Retrieved from <http://data.europa.eu/eli/reg/2017/1151/oj>
- European Commission. (2018). Commission Regulation (EU) 2018/1832 of 5 November 2018 amending Directive 2007/46/EC of the European Parliament and of the Council, Commission Regulation (EC) No 692/2008 and Commission Regulation (EU) 2017/1151 for the purpose of improving the emission type approval tests and procedures for light passenger and commercial vehicles, including those for in-service conformity and real-driving emissions and introducing devices for monitoring the consumption of fuel and electric energy. Retrieved from <http://data.europa.eu/eli/reg/2018/1832/oj>
- European Union. (2019). Regulation (EU) 2018/... of the European Parliament and of the Council of ... setting emission performance standards for new passenger cars and for new light commercial vehicles as part of the Union's integrated approach to reduce CO₂ emissions from light-duty vehicles [Draft proposal]. Retrieved from https://eur-lex.europa.eu/legal-content/EN/TXT/PDF/?uri=CONSIL:ST_5091_2019_EXT_1&from=EN
- Fiat. (2019). Fiat—Tipo 5-Türer/Kombi—Preise, Ausstattung und Technik [Fiat—Tipo 5-door/station wagon—Prices, equipment and technology]. Retrieved from <https://www.fiat.de/content/dam/fiat/de/preisliste/tipo-5-tuerer.pdf>
- Ford. (2019). Der neue Ford Focus Preisliste [The new Ford Focus price list]. Retrieved from https://www.ford.de/content/dam/guxeu/de/documents/price-list/cars/new-focus/PL-new_ford_focus.pdf

- German Association of the Automotive Industry (Verband der Automobilindustrie, VDA). (2018, December 17). Mattes: CO₂ regulation is too demanding and offers too little promotion. Retrieved from <https://www.vda.de/en/press/press-releases/20181220-mattes-co2-regulation-is-too-demanding-and-offers-too-little-promotion>
- Jiménez-Palacios, J. L. (1999). *Understanding and quantifying motor vehicle emissions with vehicle specific power and TILDAS remote sensing* (Doctoral dissertation, Massachusetts Institute of Technology). Retrieved from http://cires1.colorado.edu/jimenez/Papers/Jimenez_PhD_Thesis.pdf
- Mercedes-Benz. (2018). A-Klasse Kompaktlimousine und Limousine [A-class hatchback and sedan]. Retrieved from https://www.mercedes-benz.de/passengercars/mercedes-benz-cars/models/a-class/hatchback/buy-and-own/pricelists/_jcr_content/downloadbox/downloadcolumn1/download.attachment.Preisliste_A-Klasse_Kompaktlimousine_Limousine_WV177_190213.pdf
- Middendorf, H., Theobald, J., Lang, L., & Hartel, K. (2013). Der 1,4-L-TSI-Ottomotor mit Zylinderabschaltung [The 1.4-L-TSI petrol engine with cylinder deactivation]. In W. Siebenpfeiffer (Ed.), *Energieeffiziente Antriebstechnologien* (pp. 110–115). doi:10.1007/978-3-658-00790-4_17
- Mock, P. (Ed.). (2018). *European vehicle market statistics—Pocketbook 2018/19*. Retrieved from the International Council on Clean Transportation, <https://www.theicct.org/publications/european-vehicle-market-statistics-20182019>
- Mock, P., & Tietge, U. (2018). *Diesel car sales decline will have negligible impact on attainment of European CO₂ emission standards* (Briefing) (p. 5). Retrieved from the International Council on Clean Transportation, <https://www.theicct.org/publications/briefing-eu-diesel-sales-decline-impacts-20180318>
- Neusser, H.-J., Kahrstedt, J., Dorenkamp, R., & Jelden, H. (2013). The Euro 6 engines in the modular diesel engine system of Volkswagen. , 74(6), 4–10. doi:10.1007/s38313-013-0057-9
- Pavlovic, J., Ciuffo, B., Fontaras, G., Valverde, V., & Marotta, A. (2018). How much difference in type-approval CO₂ emissions from passenger cars in Europe can be expected from changing to the new test procedure (NEDC vs. WLTP)? *Transportation Research Part A Policy and Practice*, 111. doi:10.1016/j.tra.2018.02.002
- Pavlovic, J., Marotta, A., Ciuffo, B., Serra, S., Fontaras, G., Anagnostopoulos, K., ... Silberholz, G. (2016). Correction of test cycle tolerances: Evaluating the impact on CO₂ results. *Transportation Research Procedia*, 14, 3099–3108. doi:10.1016/j.trpro.2016.05.250
- Peugeot. (2018, December 3). Peugeot 308—Preise, Ausstattungen, Technische daten [Peugeot 308—Prices, equipment, technical data]. Retrieved from <https://media.peugeot.de/file/50/6/preisliste-peugeot-308-03.12.2018.487506.pdf>
- Pkw mit der Abgasnorm Euro 6d-TEMP/Euro 6d [Passenger cars with emission standard Euro 6d-TEMP/Euro 6d]. (2019, March). Retrieved from the ADAC website, https://www.adac.de/infotestrat/umwelt-und-innovation/abgas/modelle_mit_euro_6d_temp/default.aspx?componentid=304636&sourcepageid=0
- Renault. (2019, March 1). Renault MEGANE und MEGANE Grandtour - Preise und Ausstattungen [Renault MEGANE and MEGANE Grandtour - Prices and equipment] (2019, March). Retrieved from https://www.renault-koenig.de/fileadmin/downloads/pdf/preislisten/renault/Megane_www.pdf
- Scheidt, M., Brands, C., Kratzsch, M., & Günther, M. (2014). Combined Miller/Atkinson strategy for future downsizing concepts. *MTZ Worldwide*, 75(5), 4–11. doi:10.1007/s38313-014-0144-6

- Steinberg, P., & Goßlau, D. (2017). Kraftstoffverbrauch [Fuel consumption]. In R. van Basshuysen & F. Schäfer (Eds.), *Handbuch Verbrennungsmotor* (pp. 1149–1183). doi:10.1007/978-3-658-10902-8_26
- Tietge, U., Díaz, S., Mock, P., Bandivadekar, A., Dornoff, J., & Ligterink, N. (2019). *From laboratory to road: A 2018 update of official and “real-world” fuel consumption and CO₂ values for passenger cars in Europe*. Retrieved from the International Council on Clean Transportation, <https://www.theicct.org/publications/laboratory-road-2018-update>
- Tsiakmakis, S., Fontaras, G., Ciuffo, B., & Samaras, Z. (2017). A simulation-based methodology for quantifying European passenger car fleet CO₂ emissions. *Applied Energy*, 199, 447–465. doi:10.1016/j.apenergy.2017.04.045
- Tsiakmakis, S., Fontaras, G., Cubito, C., Pavlovic, J., Anagnostopoulos, K., & Ciuffo, B. (2017). *From NEDC to WLTP: Effect on the type-approval CO₂ emissions of light-duty vehicles* (Report No. EUR 28724 EN). Retrieved from the European Commission website, <https://ec.europa.eu/jrc/en/publication/eur-scientific-and-technical-research-reports/nedc-wltp-effect-type-approval-co2-emissions-light-duty-vehicles>
- UNECE. (2015). Addendum 82: Regulation No. 83, Revision 5, 07 series of amendments to the Regulation - Uniform provisions concerning the approval of vehicles with regard to the emission of pollutants according to engine fuel requirements (E/ECE/324/Rev.1/Add.82/Rev.5 E/ECE/TRANS/505/Rev.1/Add.82/Rev.5). Retrieved from <https://www.unece.org/?id=39145>
- VW AG. (2013). Die neue Ottomotoren-Baureihe EA211 Konstruktion und Funktion [The new petrol engine family EA211 - Design and functioning]. Volkswagen AG. Retrieved from <https://erwin.volkswagen.de/erwin/showHome.do>
- VW AG. (2014). Die Dieselmotoren-Baureihe EA288 mit Abgasnorm EU6 [The diesel engine family EA288 with emission standard EU6]. Retrieved from <https://erwin.volkswagen.de/erwin/showHome.do>
- VW AG. (2015, June 4). Der Golf Technik und Preise Gültig für das Modelljahr 2016 [The Golf - Technology and prices - Valid for model year 2016]. Retrieved from <https://www.volkswagen.de/de/dialog-center/downloadcenter.html>
- VW AG. (2017, December 14). Der Golf Technik und Preise Gültig für das Modelljahr 2018 [The Golf - Technology and prices - Valid for model year 2018]. Retrieved from <https://www.volkswagen.de/de/dialog-center/downloadcenter.html>
- VW AG. (2018). Die 1,5l-96/110 kW-TSI-Motoren EA211 EVO Konstruktion und Funktion [The 1.5l-96/110 kW TSI engine EA211 EVO - Design and functioning]. Retrieved from <https://erwin.volkswagen.de/erwin/showHome.do>
- VW AG. (2019a, January 10). Der Golf, Golf Variant & Golf Alltrack Technik und Preise Gültig für das Modelljahr 2019 [The Golf, Golf Variant & Golf Alltrack - Technology and prices - Valid for model year 2019]. Retrieved from <https://www.volkswagen.de/de/dialog-center/downloadcenter.html>
- VW AG. (2019b, February 28). Der Passat und Passat Variant Technik und Preise Gültig für das Modelljahr 2019 [The Passat and Passat Variant - Technology and prices - Valid for model year 2019]. Volkswagen AG. Retrieved from <https://www.volkswagen.de/de/dialog-center/downloadcenter.html>
- Wappelhorst, S., Mock, P., & Yang, Z. (2018). *Using vehicle taxation policy to lower transport emissions: An overview for passenger cars in Europe*. Retrieved from the International Council on Clean Transportation, <https://www.theicct.org/publications/using-vehicle-taxation-policy-lower-transport-emissions>
- Zeit Online. (2018, December 5). Umstrittener Antrieb: Deutsche Hersteller wollen mehr Diesel-Autos verkaufen. *Die Zeit*. Retrieved from <https://www.zeit.de/news/2018-12/05/deutsche-hersteller-wollenmehr-diesel-autos-verkaufen-181205-99-95583>

APPENDICES

APPENDIX A: EXTENDED LIST OF TEST VEHICLE CHARACTERISTICS

Parameter	Golf TDI	Golf TSI
Manufacturer	Volkswagen	Volkswagen
Trade name	Golf	Golf
Variant trade name	2.0 TDI BlueMotion Technology	1.5 TSI ACT BlueMotion
Manufacturer type	Golf VII (VW type code: AU)	Golf VII (VW type code: AU)
Date of first registration	May 2015	September 2017
Mileage at test start	~ 24,000 km	~ 11,000 km
Trim level	Comfortline	Comfortline
Transmission type	Dual clutch transmission	Dual clutch transmission
Number of speeds	6	7
Powered axle(s)	Front	Front
Chassis type	Hatchback	Hatchback
Vehicle segment	C (Medium)	C (Medium)
Date of type approval	October 2014	August 2017
Type-approval cycle	NEDC	NEDC
Emission standard	Euro 6b (W)	Euro 6c (ZD)
OBD standard	Euro 6-1	Euro 6-2
Eco-innovations	None	None
Mass in running order	1,394 kg	1,344 kg
Technically permissible max mass	1,880 kg	1,820 kg
Mass of test vehicle (fuel tank full, excl. driver, excl. PEMS)	Approx. 1,420 kg	Approx. 1,340 kg
Mass of test vehicle (fuel tank full, incl. driver, co-driver and PEMS)	1,660–1,680 kg	1,600–1,620 kg
Rated vehicle speed	214 km/h	210 km/h
Acceleration 0-80 km/h	6.2	6.2
Acceleration 0-100 km/h	8.6	9.1
Wheel dimensions	225/40 R18	225/45 R17
Tire rolling resistance class	B	C
Engine displacement	1,968 ccm ³	1,498 ccm ³
Rated power at speed	110 kW at 3,500–4,000 rpm	96 kW at 5,000–6,000 rpm
Rated torque at speed	340 Nm at 1,750–3,000 rpm	200 Nm at 1,400–4,000 rpm
Engine family	EA288	EA211 EVO
Engine code	CRLB	DACA
Ignition type	Compression ignition	Positive ignition
Fuel type	Diesel (mono-fuel)	Gasoline (mono-fuel)
Combustion process	Diesel-cycle	Otto- and Miller-cycle
Number of cylinders	4	4
Orientation of cylinders	In-line	In-line
Injection system type	Direct injection, common rail, 2000 bar	Direct injection, 350 bar
Charging system	VTG turbocharger, single-stage, pneumatic actuation	VTG turbocharger, single-stage, electric actuation
EGR system	Uncooled high-pressure EGR Cooled low-pressure EGR	None
Cylinder deactivation	No	Yes, on cylinders 2 and 3
Variable valve timing	Yes	Yes, on inlet and outlet side
Start-stop system	Yes	Yes
Coasting system	No	Yes
Catalysts and position	Close coupled NSC Close coupled coated DPF	Close coupled TWC Underfloor TWC

APPENDIX B: GOLF TSI TECHNOLOGY—WORKING PRINCIPLES AND THEIR EFFECTS ON CO₂ EMISSIONS

The working principles of the different technologies deployed in the Golf TSI and their effects on CO₂ emissions are as follows (Demmelbauer-Ebner et al., 2017; Middendorf, Theobald, Lang, & Hartel, 2013; Steinberg & Goßlau, 2017; VW AG, 2013, 2018).

Cylinder deactivation: On the Golf TSI engine, cylinder deactivation is performed on cylinders 2 and 3 at low to medium engine loads. In a deactivated cylinder, the piston is still performing the oscillating up-and-down movement, but no fuel is injected, the ignition is stopped, and the inlet and outlet valves are not activated. Thereby, less energy for the valve actuation is needed and significant heat losses occur only in the two active cylinders. The deactivation of two cylinders also results in a shift of operating point toward higher load for the two remaining cylinders, because the engine operating in two-cylinder mode still must provide the same power output as it would with four active cylinders. To achieve higher loads, more air is needed in the cylinder and therefore the throttle valve must be open wider, significantly reducing the energy losses caused by throttling. Literature reports a fuel-saving potential of this technology of 0.4 l/100km in the NEDC and up to 1l/100km for city driving (Middendorf et al., 2013; Steinberg & Goßlau, 2017).

Coasting: The term *coasting*, sometimes also called *sailing*, describes the decoupling of the engine from the powered wheels by opening the clutch during coasting phases, which means phases where the requested engine power output is zero or lower. Opening the clutch lets the vehicle run freely, not dissipating energy in the engine, which increases the distance that can be covered without powering the engine. The tested 96 kW version of the Golf TSI applies two levels of coasting. Level 1, when the engine is in idle, is activated between a vehicle speed of 15 and 40 km/h. In Level 2 the engine is shut off during the coasting. This mode is applied from 40 km/h up to a vehicle speed of 140 km/h. Whereas the positive effect on fuel economy by shutting off the engine during coasting phases is easily conceivable, the advantage of coasting with engine on is not evident. In this mode the potential coasting distance increases as well but the engine running in idle still consumes fuel. When coasting with engine in engine overrun mode, the fuel injection is usually shut off, making the potential coasting distance is shorter but the fuel consumption is zero. Volkswagen claims a fuel-saving potential for the coasting technology of up to 0.4 l/100km (VW AG, 2018).

Miller cycle combustion process: The Miller cycle is to a large extent similar to the Otto cycle. However, whereas the intake valves open at a similar time as for the Otto cycle—in the vicinity of the top dead center (TDC)—they are closed in the Miller cycle well before the piston reaches the bottom dead center (BDC). This lets the air trapped in the cylinder cool down during the expansion until BDC and, as a consequence, a lower temperature is achieved at the end of compression. The risk for uncontrolled self-ignition, known as knocking, is strongly temperature dependent. A lower compression end temperature therefore allows an increase in the geometric engine compression ratio, which improves thermal efficiency. The shorter inlet valve opening duration of the Miller cycle and the smaller effective cylinder volume at the time the inlet valve closes require a higher intake manifold pressure to achieve the desired cylinder fill. This allows opening the air throttle, thus reducing throttling losses. It also requires a charging device to generate the higher air pressure. Applying the same exhaust valve timing as the Otto cycle, the effective expansion stroke in the Miller cycle is longer resulting in lower exhaust temperatures, which is the prerequisite to deploying a turbocharger with a variable nozzle turbine on a gasoline engine.

The Miller cycle combustion process can reduce the fuel consumption in the NEDC by approximately 3% (Scheidt, Brands, Kratzsch, & Günther, 2014).

Variable turbine geometry (VTG) turbocharger: As the name indicates, the angle of the turbine guide blades of a VTG turbocharger can be adjusted. This changes both the flow cross section and the angle of attack on the turbine. Thereby the exhaust enthalpy can be used efficiently to achieve the desired boost pressure at the lowest possible backpressure over a wide range of engine operating conditions.

Active coolant temperature control: The engine coolant temperature has a significant impact on fuel consumption. A cold engine entails high friction losses on all moving parts and heat losses in the combustion chamber, leading to lower engine efficiency. In addition, measures to stabilize the combustion and to heat up the aftertreatment system need to be taken, which further reduces thermal efficiency. The goal is, therefore, to shorten the duration of the cold-start phase as much as possible. For this purpose, the engine of the Golf TSI contains an active coolant temperature control system consisting of a mechanically driven coolant pump and a rotary valve block. This system allows flexible control of the coolant flow rate through the different engine circuits and heat exchangers. Starting with a cold engine, the coolant is first not circulated, which lets the still coolant in the cylinder cooling jacket heat up rapidly. With increasing temperature, the coolant circulation is started, and the various engine and heat exchanger coolant circuits are switched on as needed to reach and maintain the desired temperature. An additional benefit of this technology is engine load dependent coolant temperature control. At low to medium loads, a higher coolant temperature is desired to improve the thermal efficiency by reducing heat losses, whereas a lower temperature is maintained at high loads resulting in a reduced knock tendency and lower exhaust temperatures. For a similar coolant temperature control system, Audi indicates a fuel saving potential of 2.5 g CO₂/km for the NEDC (Eiser, Doerr, Jung, & Adam, 2011).