

# STEAM/CONVECTION GAS OVENS

## INSTALLATION AND OPERATING INSTRUCTIONS (for the United Kingdom)

### Summary

Page

- Installation diagrams.....	4	7.2 REPLACING THE.....	45
<b>APPLIANCE IDENTIFICATION.....</b>	<b>37</b>	7.3 REPLACING THE GAS VALVE .....	45
<b>I. GENERAL CHARACTERISTICS.....</b>	<b>38</b>	7.4 GAS VALVE ADJUSTMENT .....	45
1. <b>TABLE 1: TECHNICAL DATA.....</b>	<b>38</b>	7.5 TABLE 2: NOZZLES AND ADJUSTMENTS / GAS TYPES..	46
2. <b>APPLIANCE DESCRIPTION .....</b>	<b>39</b>	7.6 GAS TYPE STICKER .....	47
3. <b>GENERAL INSTRUCTIONS .....</b>	<b>39</b>	<b>8. SAFETY DEVICE .....</b>	<b>47</b>
3.1 PERSONAL PROTECTION EQUIPMENT .....	39	<b>9. OPERATION CHECK.....</b>	<b>47</b>
3.2 RESIDUAL RISKS .....	40	<b>10. MAINTENANCE .....</b>	<b>47</b>
3.3 TECHNICAL DATA PLATE .....	40	<b>11. BRIEF TROUBLESHOOTING GUIDE .....</b>	<b>47</b>
4. <b>THE ENVIRONMENT .....</b>	<b>40</b>	<b>12 POSITIONING OF MAIN COMPONENTS.....</b>	<b>47</b>
4.1 PACKING.....	40	<b>III. OPERATING INSTRUCTIONS .....</b>	<b>48</b>
4.2 USE .....	40	<b>1. OVEN DOOR OPENING .....</b>	<b>48</b>
4.3 CLEANING .....	40	1.1 6 AND 10-RACK MODEL .....	48
4.4 DISPOSAL.....	40	1.2 20-RACK MODEL.....	48
<b>II. INSTALLATION INSTRUCTIONS.....</b>	<b>41</b>	<b>2. Oven door closing .....</b>	<b>48</b>
1. <b>PLACE OF INSTALLATION.....</b>	<b>41</b>	2.1 6 AND 10-RACK MODELS .....	48
1.1 REFERENCE STANDARDS .....	41	2.2 20-RACK MODELS .....	48
2. <b>POSITIONING .....</b>	<b>41</b>	<b>3. DESCRIPTION OF CONTROL PANEL .....</b>	<b>49</b>
3. <b>Burnt gas discharge.....</b>	<b>41</b>	3.2 MAIN FUNCTIONS AND SYMBOLS.....	49
3.1 FOREWORD .....	41	<b>4. CONTROL PANEL USE.....</b>	<b>52</b>
3.2 INSTRUCTIONS REGARDING THE EXHAUST SYSTEM.....	42	4.1 SWITCHING THE OVEN ON .....	52
3.3 INSTALLATION OF ACCESSORIES.....	42	4.2 SWITCHING THE OVEN OFF .....	52
4. <b>Electrical connection .....</b>	<b>42</b>	4.3 SELECTING CONTROLS (AREAS).....	52
4.1 POWER CABLE INSTALLATION .....	43	<b>OVEN USE.....</b>	<b>52</b>
5. <b>WATER CONNECTION.....</b>	<b>43</b>	4.4 MANUAL.....	53
5.1 SUPPLY WATER CHARACTERISTICS .....	43	4.5 AUTOMATIC.....	58
5.2 WATER DRAINING SYSTEM.....	44	4.6 PROGRAMS.....	60
6. <b>GAS CONNECTION.....</b>	<b>44</b>	4.7 CLEANING .....	60
6.1 INSTRUCTIONS .....	44	4.8 SETTINGS.....	61
6.2 NOMINAL HEAT OUTPUT .....	45	<b>5. SWITCHING OFF IN CASE OF A FAULT.....</b>	<b>63</b>
6.3 SUPPLY PRESSURE CHECK.....	45	<b>6. CLEANING AND MAINTENANCE.....</b>	<b>63</b>
7. <b>CONVERSION TO ANOTHER TYPE OF GAS.....</b>	<b>45</b>	6.1 STEAM GENERATOR PERIODICAL MAINTENANCE ..	64
7.1 ACCESSING COMPONENTS.....	45	6.2 REPLACING CONSUMABLE COMPONENTS.....	65
		6.3 PARTICULAR CLEANING.....	65

## APPLIANCE IDENTIFICATION

"Technical Data" plate

PNC 9PDX **260462 05**

<b>2. TABLE 1: TECHNICAL DATA</b>		
<b>6 GN 1/1</b>		
260462	260456	260457
260451-2000	260463	260457
o	o	o
**	**	**
	230	



**Information on sound emissions:** The functional components of the appliances in question have a noise level not exceeding 70 dB (A).

\* The oven model is specified at the **PNC** field on the "Technical Data" plate located at the bottom on the left side.

\*\* Gas consumption was calculated considering:

- Temperature 15°C;
- Atm. pressure 1013.25 mbar;
- Net heat value :
  - G30 (Hi=45.65 MJoule/kg)
  - G31 LPG (Hi=46.34 MJoule/kg)
  - G20 natural gas (Hi=34.02 MJoule/m3)
  - G25 natural gas (Hi=29.25 MJoule/m3)
  - LPG (Japan) (Hi=46.36 MJoule/kg)
  - Natural gas 13A (Japan) (Hi=46.05 MJoule/kg)

for AUSTRALIA  
 Propane Gas (Hi=95.8 MJ/m3)  
 Natural Gas (Hi=37.8 MJ/m3)

## 2. APPLIANCE DESCRIPTION

This handbook concerns various appliance models. For further information regarding your model, refer to Table 1 "Technical Data".

The appliance has the following features:

- Digital indication of temperature.
- Thermostatic probe for measuring the product's "core" temperature (core probe).
- Constant monitoring of cooking parameters during the entire cycle.
- Periodical emptying and subsequent automatic cleaning of the steam generator to prevent excess scaling (depending on the model).
- Signalling the need for periodical boiler maintenance; see relevant section (depending on the model).
- Compartment rapid fume extraction device for gratinating, with automatic activation.
- AIR-BREAK anti-backflow device for preventing backflow from the drainage system entering the oven (depending on the model).
- Compartment lamps.
- Door opening double-action **safety** mechanism to prevent burns (depending on the model).
- Door with double glass: better comfort in the kitchen and low surface temperatures.
- Cycle for daily cleaning of oven compartment (CLEANING SYSTEM) (depending on the model).
- Self-diagnosis for possible malfunctions by means of signalling with identification codes.

**For UK and COMMONWEALTH only:**  
 This appliance is designated as a forced draught burner, therefore the appliance is classed as COMCAT5 and only installers who held the relevant gas qualification are allowed to install/commission and service this product.  
**WARNING:**  
 Failure to use a qualified/authorised installer WILL INVALIDATE THE WARRANTY conditions and may render the appliance inoperative.  
 If any doubt please consult the manufacturer for further advice. Under no circumstances must this product be used unless installed and /or commissioned by a qualified engineer.

## 3. GENERAL INSTRUCTIONS

The following symbols are used in the manual to mark and identify the various types of hazards:



**ATTENTION!**  
 DANGER FOR THE HEALTH AND SAFETY OF OPERATORS.



**ATTENTION!**  
 DANGER OF ELECTRIC DISCHARGE (Electrocution) - DANGEROUS VOLTAGE.



**ATTENTION!**  
 RISK OF DAMAGE TO THE MACHINE.



- Before installing and using the appliance, carefully read this handbook as it provides important information and instructions on safe installation, use and maintenance.

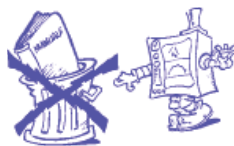

- Keep this handbook for further consultation by the various operators, or in case the appliance is resold.



**Attention:** Appliance installation, any maintenance work and conversion to another type of gas must only be carried out by professionally qualified personnel authorised by the Manufacturer.

- This appliance is intended for collective use and is expressly designed for cooking food. Any other use is deemed improper.

**The appliance must only be used by trained staff.**

- This appliance is not intended for use by people (including children) with limited physical, sensory or mental abilities or without experience and knowledge of it, unless they are supervised or instructed in its use by a person responsible for their safety.
- Switch the appliance off in case of fault or poor operation.
- **For any repairs, only consult an After-Sales Centre authorised by the manufacturer and demand original replacement parts. Failure to observe the above can compromise appliance safety and invalidates any form of warranty.**



- Do not clean the appliance with direct jets of water.

- Do not use products containing chlorine (chlorine bleach, hydrochloric acid, etc.), even if diluted, to clean the steel parts.
- Do not use corrosive substances (e.g. muriatic acid) to clean the floor under the appliance.
- For further details see the section "Cleaning and maintenance".

### 3.1 PERSONAL PROTECTION EQUIPMENT

Give below is a summary table of the Personal Protection Equipment (PPE) to be used during the various stages of the machine's service life.

Stage	Protective garments	Safety footwear	Gloves	Glasses	Ear protectors	Mask	Safety helmet
Transport		X					
Handling		X					
Unpacking		X					
Assembly		X					
Normal use	X	X	X (*)				
Adjustments		X					
Routine cleaning		X	X				
Extraordinary cleaning		X	X				
Maintenance		X					
Dismantling		X					
Scrapping		X					

Key: X PPE REQUIRED  
 PPE AVAILABLE OR TO BE USED IF NECESSARY  
 PPE NOT REQUIRED

(\*) During Normal use, gloves must be heatproof to protect hands when removing the hot pan from the appliance.

Failure to use the personal protection equipment by operators, specialised technicians or users can involve exposure to chemical risk and possible damage to health.

### 3.2 RESIDUAL RISKS

The machine has several risks that were not completely eliminated from a design standpoint or with the installation of adequate protection devices.

For the Customer's complete information, the residual risks remaining on the machine are indicated below: such actions are to be considered incorrect and therefore strictly forbidden.

RESIDUAL RISK	DESCRIPTION OF HAZARDOUS SITUATION
Slipping or falling	The operator can slip due to water or dirt on the floor.
Burns	The operator deliberately or unintentionally touches some components inside the machine or dishes at the out-feed without using gloves or without allowing them to cool.
Danger of electric discharge (Electrocution)	Contact with live parts during maintenance operations carried out with the electrical panel powered. The operator intervenes (with a power tool or without disconnecting the power to the machine) lying down on the wet floor.
Falling from above	The operator intervenes on the machine using unsuitable systems to access the upper part (e.g. rung ladders, or climbs on it).
Tipping of loads	During maintenance on the machine or the packing containing the machine with the use of unsuitable accessories or lifting systems or with load unbalanced. When handling pans containing food.
Chemical	Contact with chemical substances (e.g. detergent, rinse aid, scale remover, etc.) without taking adequate safety precautions. Therefore always refer to the safety cards and labels on the products used.

### 3.3 TECHNICAL DATA PLATE

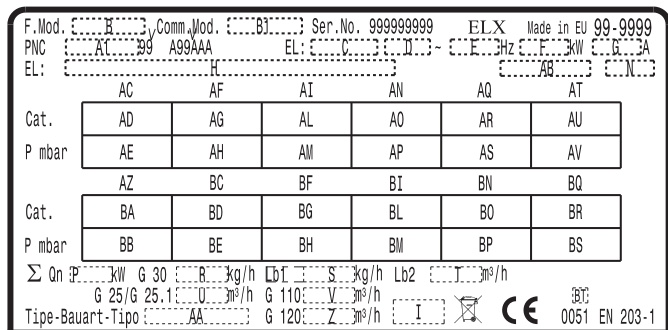

Meaning of fields given on the plate:

- F. Mod. .... factory description of product
- Comm. Model ..... commercial description
- Ser. Nr. .... serial number
- ELX ..... manufacturer: Electrolux Professional spa  
Viale Treviso, 15  
33170 Pordenone (Italy)

- Made in EU ..... place of manufacture
- 99-9999 ..... month/year of manufacture
- PNC: ..... production number code
- EL: ..... [C] power supply voltage, [D] phase

- Hz ..... power supply frequency
- kW ..... max. power input
- A ..... current absorption
- EL: ..... [H] electrical prearrangement
- Cat ..... gas category
- P mbar ..... gas pressure
- Σ Qn ..... gas power
- G30-Lb1-...G120... consumption of various gas types
- Type-Bauart-type .. construction type (fume exhaust system)
- [I] ..... protection rating
- CE ..... CE marking
- 0051 EN 203-1 ..... reference standards

## 4. THE ENVIRONMENT

### 4.1 PACKING

All the packing materials are environmentally friendly. They can be stored without risk or burned in a special waste incineration plant. Recyclable plastic components are marked as follows:



PE

**polyethylene:** outer wrapping, instructions bag, gas nozzle bag.



PP

**polypropylene:** roof packing panels, straps



PS

**polystyrene foam:** corner protectors

### 4.2 USE

Our appliances are designed and optimised with laboratory testing in order to offer high performance and efficiency. In any case, to reduce energy consumption (electricity, gas and water), avoid using the appliance empty for long periods or in conditions that compromise optimum efficiency (e.g. door open). Also, if possible, preheat the appliance immediately before use.

### 4.3 CLEANING

In order to reduce the emission of pollutants into the environment, clean the appliance (externally and when necessary internally) with products that are over 90% biodegradable.

### 4.4 DISPOSAL

At the end of the product's working life, make sure it is not dispersed in the environment. Our appliances are manufactured using more than 90% metals (stainless steel, iron, aluminium, galvanised sheet, copper, etc.) which can be recycled by means of the conventional recovery structures, in compliance with the current regulations in the country of use. Make the appliance unusable by removing the power cable and any compartment or cavity closing devices (when present) in order to avoid the risk of someone becoming trapped inside.

The symbol  on the product indicates that this product should not be treated as domestic waste, but must be correctly disposed of in order to prevent possible negative consequences for the environment and the human health. Regarding the recycling of this product, please contact the sales agent or dealer of your product, your after-sales service or the appropriate waste disposal service.

### for AUSTRALIA

- Warnings:**
  - Do not store or use gasoline or other flammable vapours, liquids or items in the vicinity of this or any other appliance.
  - Do not spray aerosols in the vicinity of this appliance while it is in operation.
  - Never check for leaks with an open flame
  - The appliance is not suitable for a marine environment.



## II. INSTALLATION INSTRUCTIONS



**Attention:** The external panels of the oven must be removed for the operations described in this section. As the unit must be operating in order to carry out some adjustments, pay maximum attention to the live parts.



**Attention:** Maintenance in the upper part of the appliance requires the use of ladders with protection (guard).

### 1. PLACE OF INSTALLATION

- Only install the appliance in a suitably ventilated place.

#### 1.1 REFERENCE STANDARDS

- Install the appliance in compliance with the current local and national regulations.

#### for AUSTRALIA

- This appliance shall be installed only by authorised persons and in accordance with the manufacturer's installation instructions, local gas fitting regulations, municipal building codes, electrical wiring regulations, local water supply regulations, AS5601-gas installation, health authorities and any other statutory regulations.

### 2. POSITIONING

- Unpack the appliance, carefully remove the protective film from outside panels, making sure no traces of glue remain. If necessary, remove them using a suitable solvent. Remove the packing using protective gloves. Lift the appliance with a lift truck, remove the base, and position it the place of use. Remove the protective film and make sure the packing material is not dispersed in the environment but disposed of according to the current regulations in the country where the product is used.

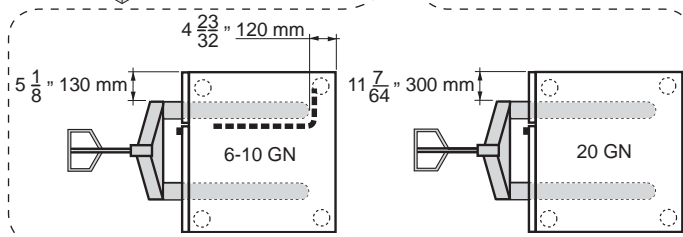
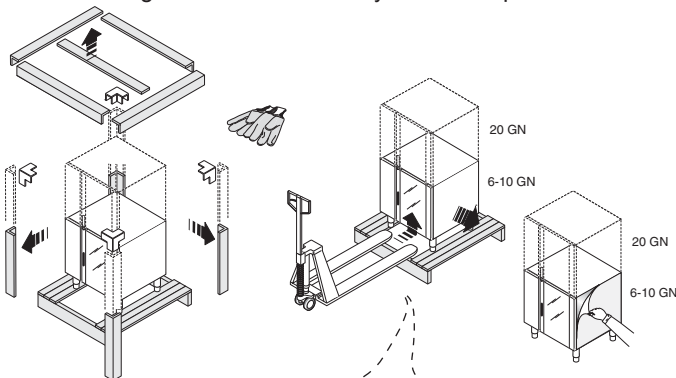

- For disposal of the packing, see the section "The Environment"
- For the overall space required and connection dimensions, refer to the installation diagrams given on the first pages of this instruction handbook.
- The left side of the appliance must remain at least **50 cm** from other surfaces to enable maintenance operations, whereas the

right side and back must remain **10 cm** from any surface.

- Position the appliance on a flat surface and, if necessary, adjust the height of the worktop by means of the adjustable feet.
- The appliance is not suitable for built-in installation.



#### Attention:

**Make sure the steam coming from the oven discharge or adjacent appliances does not reach the aeration vents (for cooling internal components), located at the bottom of the appliance.**

### 3. BURNT GAS DISCHARGE

#### 3.1 FOREWORD

In relation to the combustion technology used, Steam Convection gas ovens are classified according to their "**Construction Type**". The regulations provide for a specific burnt gas discharge system for each of these.

Consequently, before installing the discharge system:

- identify the "**Construction type**" of the model in **Table 1** (technical data) or on the dataplate;

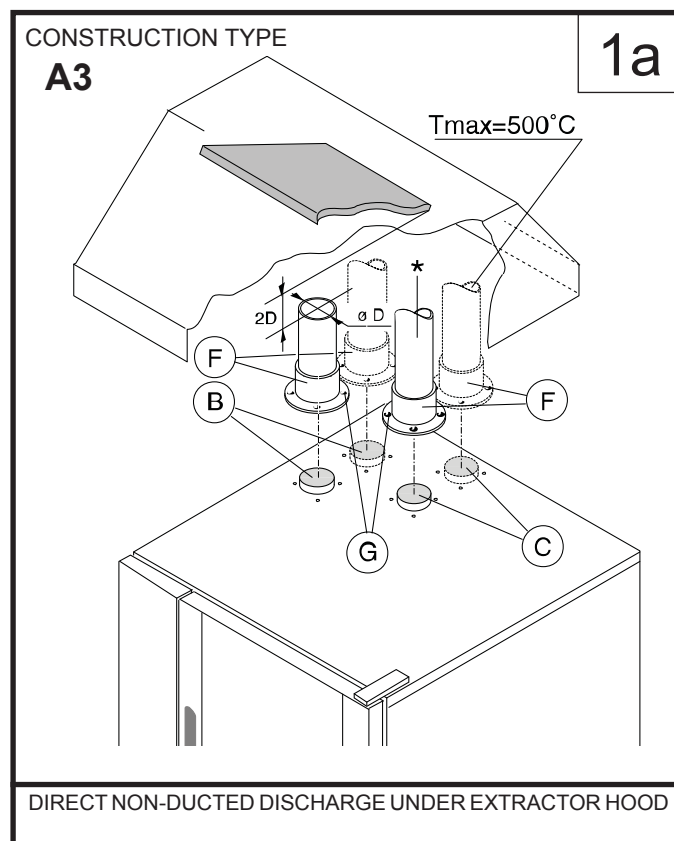

DIRECT NON-DUCTED DISCHARGE UNDER EXTRACTOR HOOD

#### KEY:

- A:** Manifold / draught damper accessory (to be ordered from the manufacturer)
- B:** Steam generator burnt gas outlet
- C:** Compartment convector burnt gas outlet
- E:** Adapter ring for commercial ducts (to be ordered from the manufacturer)
- F:** Conical sections for single outlet (supplied) **(always install)**
- G:** Fixing screws (supplied);
- \***: Commercial extension pipes (not supplied)

#### SILICONE :

Apply silicone sealant between the contact surfaces

## CONSTRUCTION TYPE

B13

1b

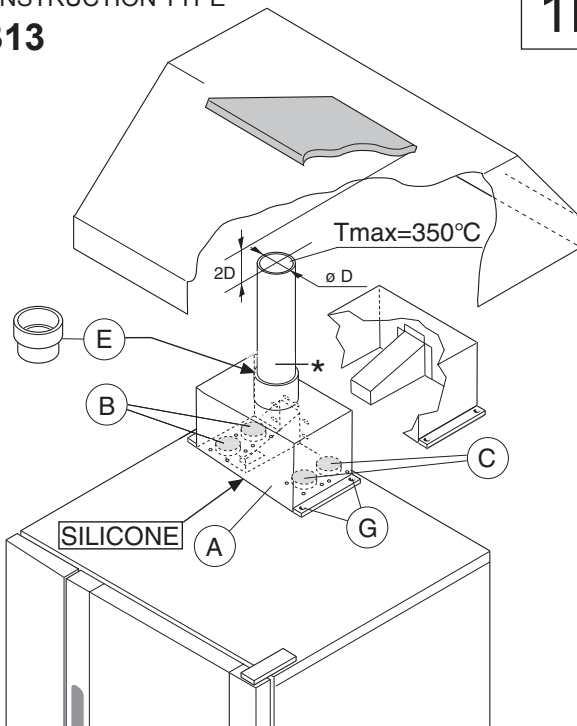

DISCHARGE WITH MANIFOLD UNDER EXTRACTOR HOOD

## CONSTRUCTION TYPE

B13

1c

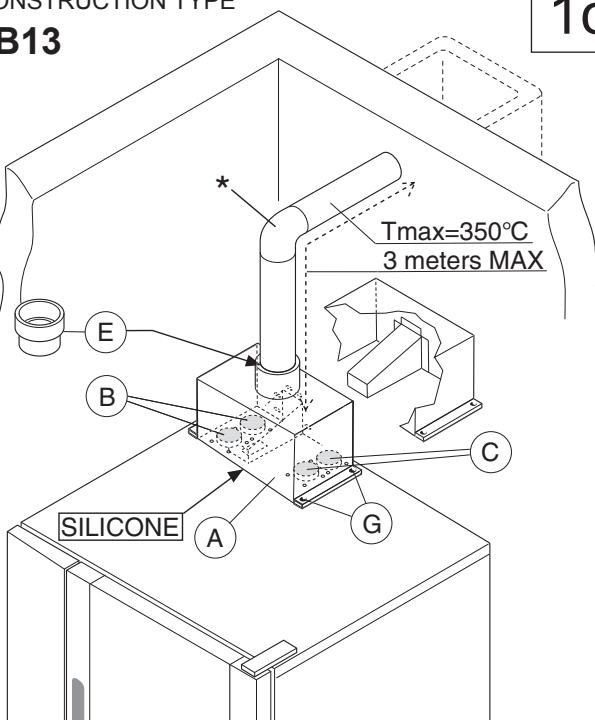

DISCHARGE TO THE OUTSIDE OR CENTRAL FLUE WITH MANIFOLD

b) choose the diagram with the type of construction from those given below, depending on how the burnt gases are to be exhausted from the place of installation (e.g. discharge under extraction hood, to the outside or to a central flue).

## 3.2 INSTRUCTIONS REGARDING THE EXHAUST SYSTEM

Before installation, check (according to the reference standard) that the volume sucked by the fume exhaust system is greater

## KEY:

- A:** Manifold / draught damper accessory (to be ordered from the manufacturer)  
**B:** Steam generator burnt gas outlet  
**C:** Compartment convector burnt gas outlet  
**E:** Adapter ring for commercial ducts (to be ordered from the manufacturer)  
**F:** Conical sections for single outlet (supplied) **(always install)**  
**G:** Fixing screws (supplied);  
 \* : Commercial extension pipes (not supplied)

## SILICONE :

Apply silicone sealant between the contact surfaces

than that of burnt gases produced by the appliance (see point 1.1).

In case of burnt gas exhausting under an extractor hood, respect the distance (shown in the figure) between the top of the exhaust pipe and the lowest point of the hood filters. This distance is defined on the basis of exhaust pipe diameter "D".

In the case of discharge to the outside or to a central flue (Fig. "1c"), the exhaust ducting must **NOT** be longer than 3 metres (total length) or have any reductions in diameter, and must be periodically inspected and cleaned when necessary.



**Attention:** Since burnt gases (see figure) can reach very high temperatures, check the materials extension ducts and extractor hood filters are made from. Also make sure to periodically check the filters which, if clogged with grease and grime, will reduce the efficiency of the extraction system.

## 3.3 INSTALLATION OF ACCESSORIES

Accessories can be easily installed by following the figures given below and the relevant key.

The screw holes for fixing accessories "A" and "F" are  $\phi 3.5$  mm and must be drilled in situ on the oven cover, at the punch marks.

## 4. ELECTRICAL CONNECTION

- **Connection to the electrical power supply must be done in compliance with the current national and local regulations.**
- Before connecting, make sure the voltage and frequency match that given on the dataplate.
- The appliance must be connected to the power supply in a permanent way. Connection must be made with an H05 RN-F type cable. The power cable must be installed in a metal or rigid plastic pipe without any sharp parts.
- An omnipolar switch of suitable capacity with contact opening distance of at least 3 mm must be installed ahead of the appliance. This switch must be installed in the building's permanent electrical system, in the immediate vicinity of the appliance.
- Appliance max. leakage current is 5 mA.
- A device (interlocked plug, lockable switch or similar devices) lockable in the open position during maintenance must be installed ahead of the appliance.
- The appliance must be connected to an efficient earthing system. For that purpose, the connection terminal block has a terminal with the symbol  $\perp$  for connecting the earth wire. The appliance must also be included in an equipotential system. This connection is made with the setscrew marked  $\nabla$ , located externally near the power cable entry. The equipotential wire must have a section of at least 10 mm<sup>2</sup>.

### 4.1 POWER CABLE INSTALLATION

To connect the power cable to the appliance, proceed as follows:

#### Model 6 - 10 - 20 GN

- Remove the left side panel.
- Connect the cable to the terminal block as shown in the wiring diagram attached to the appliance, and secure it with the special cable gland.

The manufacturer declines any liability if the current national and local regulations and possible safety regulations are not respected.

### 5. WATER CONNECTION

(See the installation diagrams at the beginning of this handbook)

When connecting the appliance to the water system with hoses they must be new and not used.

The oven has two separate water supply inlets ("B" and "N").

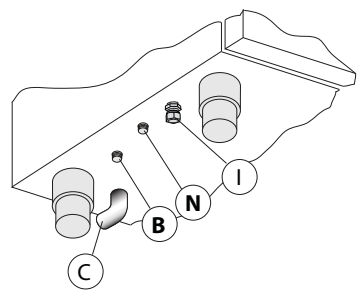

- C - Water drain manifold
- B - Steam generator or boiler water supply connection
- N - Condensate and Cleaning water connection
- I - Power cable entry

The feed pipes of both inlets must be provided with a mechanical filter and shutoff valve. Before installing the filters it is advisable to allow a certain amount of water to run in order to clear the pipe of any solid particles.

#### 5.1 SUPPLY WATER CHARACTERISTICS

The appliance must be supplied with **drinking water** having the specific characteristics given in this section.

To appraise the suitability of the supply water the following characteristics must be measured:

- Total Hardness
- Conductivity
- Chloride Cl<sup>-</sup>
- pH

### WATER CHARACTERISTICS INLET "B"

To guarantee correct appliance operation, several water treatment systems may have to be installed. For that purpose, see the instructions of the following Flow Chart :

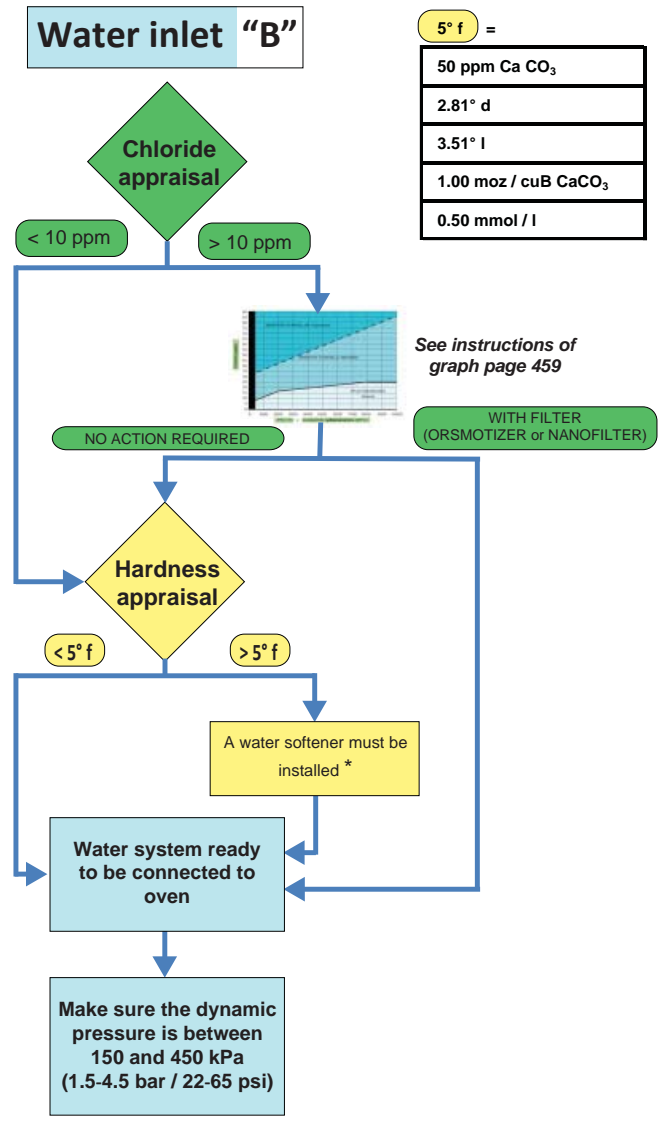

\* If deemed suitable by the installer, the water softener can be replaced with a NANOFILTER.

#### ATTENTION:

- conductivity above 50 µS/cm is necessary.
- The periodical check of filter functionality, according to that indicated by the manufacturer, is important to avoid compromising appliance operation and to prevent the risk of corrosion.
- For good operation of the water softeners and filters make sure to regularly service them.

Note: The softener (Automatic Water Softener) with automatic regeneration has a kit (Resin Sterilizer) for sterilization of the resins (additional request).

- To prevent damaging the appliance, at every periodical regeneration do a filter wash cycle without introducing water in the oven.
- The manufacturer declines any liability in case of incorrect maintenance.

**Attention:** Dispensers of substances for preventing scale in the pipes (e.g. polyphosphate dispensers) must not be used because they can compromise correct appliance operation.

**WATER CHARACTERISTICS INLET "N"**

To guarantee correct appliance operation, several water treatment systems may have to be installed. For that purpose, see the instructions of the following Flow Chart :

**Water inlet "N"**

5° f =
50 ppm Ca CO <sub>3</sub>
2.81° d
3.51° l
1.00 moz / cuB CaCO <sub>3</sub>
0.50 mmol / l

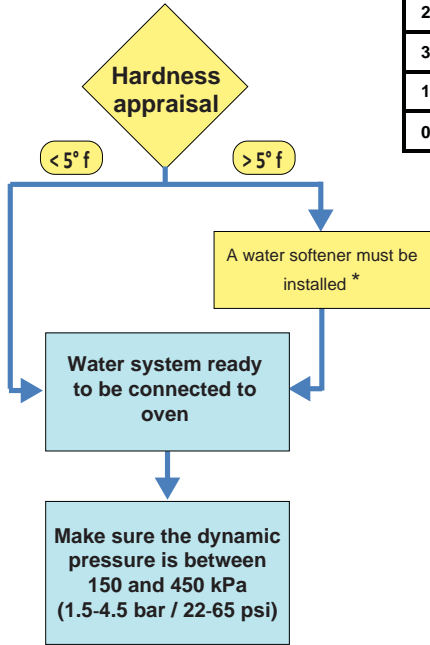

\* If deemed suitable by the installer, the water softener can be replaced with a NANOFILTER, provided the minimum water flow rate for the oven wash cycle is respected.

**Note:** The softener (Automatic Water Softener) with automatic regeneration has a kit (Resin Sterilizer) for sterilization of the resins (additional request).

**CHECK SUPPLY PRESSURE INPUT "B" AND "N"**

The pressure measured upstream of the oven (and downstream of any WATER FILTRATION SYSTEMS installed) must be between **150 and 450 kPa (1.5 - 4.5 bar / 22-65 psi)** measured in dynamic conditions, i.e. during the boiler filling and washing phase.

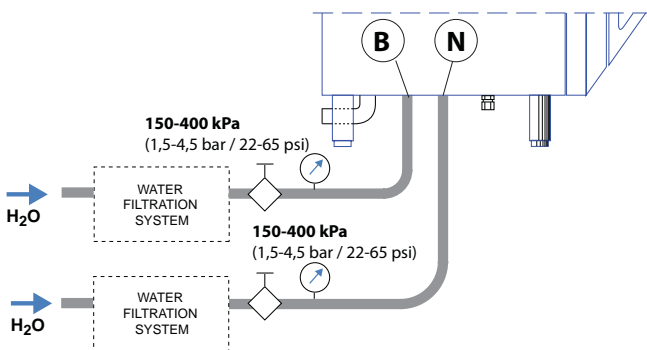

**Attention (water inlet N)**  
If the feed pipes supplied with the appliance are not long enough for installation, use longer ones with **internal diameter of at least ø 20 mm** and without union elbows.

**For UK and COMMONWEALTH only:**

This appliance is designated as a forced draught burner, thereIn accordance with "the water supply (Water Fittings) Regulations 1999", it is mandatory that this appliance when installed to the mains water supply has fitted an approved "double check valve" connected upstream of the appliance. Failure to comply with these regulations may lead to the appliance being disconnected.

**5.2 WATER DRAINING SYSTEM**

The oven has an AIR-BREAK anti-backflow device inside to prevent any backflow from the drainage system entering the internal pipes and the oven compartment. This allows the drain pipe to be connected directly to the mains system or discharging into a floor grate.

The drain pipe (rigid or flexible type) can be run to the side or back if the oven is not placed against a wall, excluding the front part with rack support structure. It must **not be more than 1 metre** long, with inside diameter not less than that of the oven discharge pipe (1" 1/4), and must withstand temperatures of at least 100°C. Make sure there are no constrictions in hoses or elbows in metal pipes, along the entire drain path. Avoid horizontal sections where water can collect and stagnate (min. slope 5%).

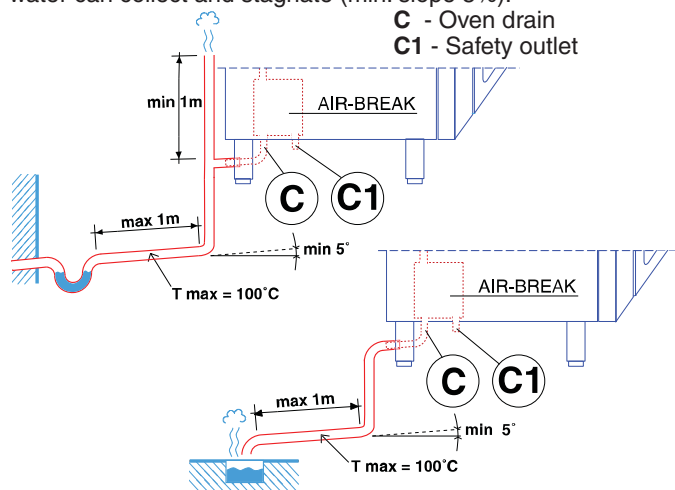

**Attention:**

- Do not obstruct the safety outlet **C1**.
- Do not connect the safety outlet **C1** to the drainage system.

**Note:**

If water comes out of the AIR-BREAK (safety outlet C1) it means the drain C is blocked. Elimination of the obstruction **should be carried out by specialised technical personnel**.

**6. GAS CONNECTION**

**6.1 INSTRUCTIONS**

- **Make sure the appliance is arranged for the type of gas to be used, otherwise follow the instructions in par. 7 "Conversion to another type of gas".**
- **The gas connection union is painted yellow.**
- Before installing, consult the gas company to check the compatibility between the supply capacity and foreseen consumption.
- Before connecting the appliance to the gas pipes, remove the plastic protection cap from the union.
- Fit a rapid gas shutoff cock in an easily accessible place ahead of the appliance.
- After installation, use soapy water to check gas connections for leaks.
- **The combustion aeration capacity cannot be modified.**
- Always check operation in case of possible connection to another type of gas (see par. 8 "Operation Check").



## 6.2 NOMINAL HEAT OUTPUT

For data regarding the **nominal heat output** refer to "**Technical Data**" **Table 1**.

This parameter is determined by the gas supply pressure and the diameter of the gas valve diaphragm (nozzle).

Appliance nominal heat output must always be checked (by the authorised installer or by the gas company) in case of new installations and conversion to a different gas type or following all maintenance work.

**Any change to the nominal heat output is strictly prohibited.**

## 6.3 SUPPLY PRESSURE CHECK

(Fig. 2a)

The supply pressure must be measured ahead of the gas control valve with the appliance operating (after conversion in case of a different type of gas), using a **pressure gauge with minimum resolution of 0.1 mbar** and proceeding as follows:

- 1) Remove the left side to access the gas valve;
- 2) Loosen screw "C" of the gas valve pressure point and connect the pressure gauge tube to it;
- 3) Open the gas shutoff cock;
- 4) Start a **combi cooking cycle** (see "**Operating instructions**") so that all the burners can be lit;
- 5) Check that the pressure reading is within the values given in the following table:

### GAS TYPE PRESSURE (MBAR)

	Nom.	Min.	Max.
Natural gas G20	20	17	25
LPG G30/G31	37	25	45

for Japan

Natural gas 13A	13	10	25
LPG	25	20	33

### PRESSURE (KPa)

for AUSTRALIA

Natural gas	1	-	-
L. P. G.	2.75	-	-

**The appliance will not function with different values.**

Inform the gas company;

- 6) After measuring the supply pressure, stop the cooking cycle and close the gas shutoff cock.
- 7) Disconnect the pressure gauge and carefully tighten screw "C";
- 8) Close the appliance.

## 7. CONVERSION TO ANOTHER TYPE OF GAS



**Attention:** The appliance is factory set for a **type of gas**, as specified on the stickers on the appliance and packing. To convert the appliance to another type of gas, carefully follow the instructions given below, using the diaphragms (nozzles) contained in the bag supplied with the appliance.

### 7.1 ACCESSING COMPONENTS

- Remove the appliance left side panel.

### 7.2 REPLACING THE

#### BURNER-BLOWER REDUCER (PLATE) (Fig. 2b)

The reducer (plate) must be replaced for **gas G30 and G31 (LPG)** only in some models as indicated in TABLE 2 (following pages).

The diameter of the reducer's middle hole is given in mm.

- Undo the 2 nuts "P" securing plate "L" to burner "H".
- Unscrew the 4 nuts "F" securing blower "G" to burner "H".
- Replace plate "L" (including the 2 seals "M") with the one for gas G30 and G31 (LPG)
- Insert the 2 pins "L1" of plate "L" in the 2 slots "H1" and retighten the 2 nuts "P" (with respective washer).
- Retighten the 4 nuts "F" (with respective washer).

## 7.3 REPLACING THE GAS VALVE

### DIAPHRAGM (NOZZLE)

(Fig. 2a)

- Unscrew the hex nut of union "A" with the respective **seal "A1"** and replace diaphragm "B" (nozzle) with one suitable for the type of gas used by relevant burner (convector or steam generator) and the oven model purchased (see **Table 2** - following pages). The diaphragm (nozzle) diameter, shown in hundredths of mm, is stamped on the body (e.g. ø3.5 mm, stamping: 350)
- Retighten hex nut "A" with the respective **seal "A1"**.
- Repeat the above operations for the other valves (if present) and proceed with the instructions in the next paragraph.

### 7.3.1 CHANGING PARAMETERS

- Change the electronic card parameters relevant to the burner blower control as indicated in the service manual (not supplied).

## 7.4 GAS VALVE ADJUSTMENT

(Fig. 2a)

**Note:** The adjustments given below must only be made by a technician authorised by the manufacturer.

To adjust the pressure (**negative**) of the gas valve, adapting it to a type of gas different from that for which it is arranged, proceed as follows:

- Loosen the screw "D" relevant to the gas valve pressure point and connect a **pressure gauge with minimum resolution of 1 Pa** to it;
- Remove adjustment screw cap "E1".
- Light the burner and select on the control panel a HOT AIR cooking cycle for the convector and STEAM for the steam generator (see "Operating instructions").
- 1 minute after lighting the burner, use a suitable tool to turn screw "E" of the valve, adjusting the pressure (**negative**) until the pressure gauge reading matches the value shown in TABLE 2 (following pages) for the burner in question. Wait a few minutes and (if the value has changed) adjust screw "E" again.
- After adjusting, refit cap "E1" and seal it with red paint, taking care not to clog the vent holes in the valve.
- Turn off the burner.
- Repeat the above procedure for the other valves (if present).



**Attention:**  
After conversion, refit the oven outer panels.

7.5 TABLE 2: NOZZLES AND ADJUSTMENTS / GAS TYPES

FIGURE		2a - 2b																				
n° of GRIDS		6 GN1/1				10 GN1/1				10 GN2/1				20 GN1/1				20 GN2/1				
CONVECTOR ° BOILER **		o		**		o		**		o		**		o		**		o		**		
REFERENCE		∅	#	∅	#	∅	#	∅	#	∅	#	∅	#	∅	#	∅	#	∅	#	∅	#	
Diaphragm (nozzle) gas valve Heading 7.3	G30	5,25	525	4,75	475	5,5	550	5,8	580	5,8	580	5,8	580	5,5	550	5,8	580	5,8	580	6	600	
	G31 L.P.G. Propane Gas (AU)	5,5	550	5	500	5,7	570	6,15	615	6,25	625	6,15	615	5,7	570	6,15	615	6,25	625	6,25	625	
	G20 - 13A Natural Gas (AU)	6	600	6	600	7	700	7,5	750	7,8	780	7,5	750	7	700	7,5	750	7,8	780	7,5	750	
	G25 natural gas	6,75	675	6,75	675	8	800	8,5	850	8,5	850	9	900	8	800	9	900	9,25	925	9	900	
REPLACING °° burner-blower reducer (plate) Heading 7.2	G30 Propane Gas	12		12		18		18 °°		18 °°		18 °°		18		18 °°		18 °°		18 °°		21
	G31 L.P.G. Propane Gas (AU)	12		12		18		18 °°		18 °°		18 °°		18		18 °°		18 °°		18 °°		21
	G20 - 13A Natural Gas (AU)	12		12		18		21		21		21		18		21		21		21		21
	G25 natural gas	12		12		18		21		21		21		18		21		21		21		21
Ventilator * (ring) burner	G30/G31 L.P.G. Propane Gas (AU)	F		F		R		G		G		G		R		G		G		G		G
	G20 - 13A Natural Gas (AU)	F		F		R		G		G		G		R		G		G		G		G
	G25 natural gas	F		F		R		G		G		G		R		G		G		G		G
Adjustment pressure (negative) gas valve (Pa) Heading 7.4	G30	0 / -10		0		0		0 / -10		0		0 / -10		0		0 / -10		0		0		0
	G31 L.P.G. Propane Gas (AU)	0 / -10		0		0		0 / -10		0		0 / -10		0		0 / -10		0		0		^ 0 v -10
	G20 - 13A Natural Gas (AU)	0		0		0		0		0 / -20		0		0		0		0		0		^ 0/-20 v 0/-10
	G25 natural gas	0 / -10		0 / -10		0		0		0		0 / -10		0		0 / -10		0		0		0

∅ = diameter (mm)  
# = stamping  
^ (up) = upper burner gas valve  
v (down) = lower burner gas valve

F (Fuchsia)  
R (Red)  
G (Green)

\* The aerator (coloured ring) "N" (fig. 2b) of the burner blower must **not** be replaced; the colours given in the table are only a guide.

(AU) = AUSTRALIA

**GAS VALVE  
(CONVECTOR / STEAM GENERATOR)**

- Replacing diaphragm "B"
- Screw "E" adjustment

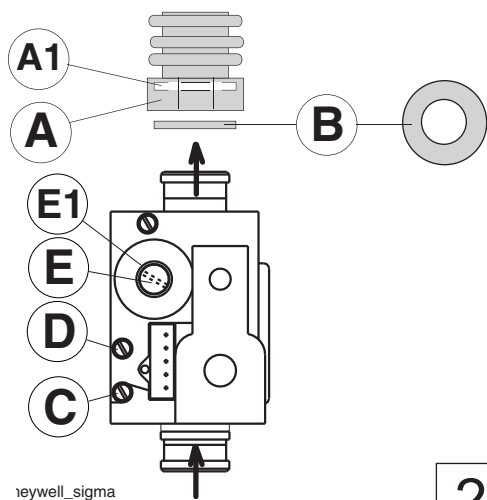

2a

**BURNER BLOWER  
(CONVECTOR)**

- Replacing plate "L" for gas G30 and G31 (LPG)

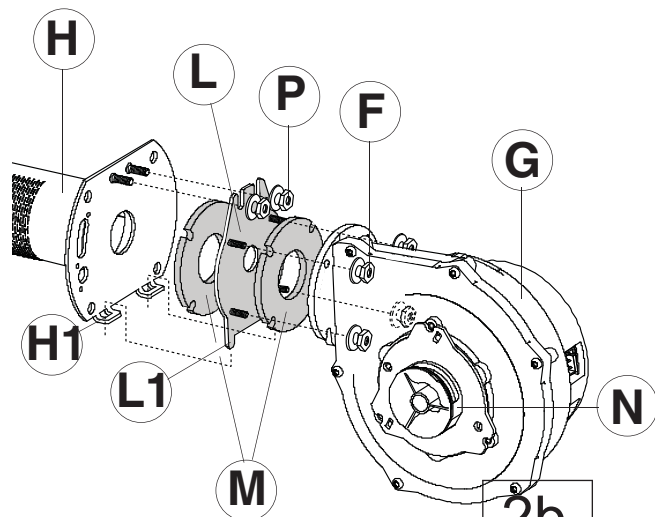

2b

## 7.6 GAS TYPE STICKER

After the conversion to a different type of gas, apply the sticker for the new gas on the oven in place of the existing one. The sticker is included in the bag supplied.

## 8. SAFETY DEVICE

The appliance is equipped with the following safety devices:

- **Fuses**, see the wiring diagram, located behind the control panel. For replacement, unscrew the cap and replace the damaged component with another one having the same rating; this value is given on the label located in the same place.

- **Compartment manual-reset safety thermostat** located behind the control panel; it shuts off the gas supply to the convector burner.

- **Steam generator manual-reset safety thermostat** located behind the control panel; it shuts off the gas supply to the generator burner.

Resetting operations must be carried out by specialised technical personnel after eliminating the causes of interruption.

- **Automatic-reset thermal device** inside the **fan**, which is activated if the fan overheats, protecting unit operation; it cuts off the electrical power to the appliance.

## 9. OPERATION CHECK

- Switch the appliance on, as described in the section "Operating instructions";
- Explain appliance operation, routine maintenance and cleaning operations to the user, with the help of the instruction handbook.



### Attention:

- During operation, pay attention to the hot areas of the exterior surface.
- Do not place objects on the outlets located at the top of the appliance.

- With oven hot, check the correct working of the door closing mechanism. If necessary, adjust closing by adjusting the position of the catch.

## 10. MAINTENANCE

The components requiring routine maintenance are accessible by opening the control panel, and left and rear panels.

## 11. BRIEF TROUBLESHOOTING GUIDE

Even with correct use of the appliance, malfunctions can occur.

**The burner fails to light** (the message "burn" appears on display TM, see "**Operating instructions**" chap. 5).

Possible causes:

- The ignition electrode is incorrectly positioned or the insulation is faulty.
- The ignition/flame control device is damaged.
- The ignition electrode high tension lead is broken or leaking.
- Insufficient gas pressure.
- Faulty gas valve.
- Burner fan unit damaged, insufficient air pressure in combustion chamber.
- The electronic control panel is damaged.
- Blown fuse, see wiring diagram.
- Compartment temperature probe damaged (configuration error Ept1 - see "**Operating instructions**" chap. 5).
- Temperature limiter activation.
- High room humidity (condensation): air the room.

**The burner goes out** (the message "burn" appears on the display TM, see "**Operating instructions**" chap. 5).

Possible causes:

- Power supply polarity (Phase/Neutral) inverted.
- The oven electrical system is "Phase/Phase" type. In this case install the special "Transformer Kit" available from the manufacturer.
- Faulty gas valve.
- Flame detection electrode incorrectly positioned or disconnected.
- Burner fan unit damaged (shutdown situation).
- Flame control device damaged.
- High room humidity (condensation): air the room.

**Incorrect oven compartment temperature thermostating.**

Possible causes:

- Electronic control panel faulty.
- Oven compartment temperature probe dirty, faulty or disconnected, see configuration error Ept1 (see "**Operating instructions**" chap. 5).

**The oven fails to switch on.** Possible causes:

- Electronic control panel damaged.
- Fuse F2 blown due to damaged auxiliary circuit components.

**Oven compartment lamps damaged**

**ATTENTION:** Switch the appliance off before replacing oven compartment lamps.

## 12 POSITIONING OF MAIN COMPONENTS

**(Any operation inside the appliance must only be carried out by an installer authorised by the Manufacturer).**

Open the control panel to access the following components:

- Electronic boards.
- Compartment temperature limiter thermostat.
- Fuses.
- Door safety microswitch.
- Compartment vent shutter control gear motor.

Remove the appliance left side panel to access to all the other components.

## III. OPERATING INSTRUCTIONS

Before starting the appliance, carefully read this handbook. The instructions and information given in it are important for correct and optimum oven use. If required, further details regarding its characteristics and cooking performance can be obtained from the dealer.

- To avoid obstructing the fume and steam discharge pipes, do not place pans or utensils of any kind on the oven.
- Do not place objects (e.g. pans) under the bottom of the oven, so as not to obstruct any cooling air inlet or outlet holes.
- Have the appliance fully checked periodically (at least once a year). For that purpose, it is advisable to stipulate a maintenance contract.
- The core probe is a precision component. Absolutely avoid impacts, forcing when inserting, and pulling of the flexible cable (in particular when using the trolley-mounted structures). **The warranty does not cover the replacement of core probes damaged by improper use.**
- In the **combi** cooking cycle it is advisable not to exceed temperatures of 200-210°C. Higher values can reduce the efficiency of the compartment seals.
- When arranging food inside the oven compartment, keep a space of at least 40mm between trays, to ensure better circulation of hot air.
- If the oven is installed near appliances that produce greasy fumes (e.g. fryer), make sure to use the **air filter** (not supplied), to be placed under the **control panel**, to protect the internal electronic components.
- During **preheating** of oven 20 GN 1/1 or 2/1, insert the trolley (without food) or the special accessory (not supplied) to close the bottom opening between the compartment and door. This prevents steam from coming out and into the control panel with consequent damage to the electronic board.
- **Do not salt food inside the oven, in particular with humid cycles.**
- **Do not place flammable liquids (e.g. spirits) inside the oven during operation.**



The maximum height at which the trays are placed in the oven must not exceed 1.6 m. This applies if installed according to the instructions and using original accessories (except for stacked ovens). In case of stacked ovens or in any other case when the above distance is exceeded, the following sticker (supplied) must be placed on the front of the oven in a visible position at a height of 1.6 m from the floor.



**ATTENTION: To avoid burns, do not use recipients containing liquids (or products that become liquid with cooking) on levels that are not easily visible. This is to prevent spilling during handling.**

### 1. OVEN DOOR OPENING

#### 1.1 6 AND 10-RACK MODEL



**Attention! Risk of burns. Always** open the door with caution when the oven is hot.

- a) Turn the door handle all the way in either direction (indifferently) to fully open the oven door.  
The cooking cycle is stopped, if in progress.

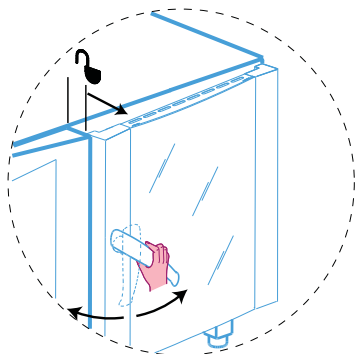

#### MODELS WITH DOUBLE OPENING SYSTEM (on request)

The oven has a **double opening system** to prevent being exposed to steam when opening the door completely; therefore carry out the following operations:

- a) Turn the door handle all the way clockwise. The door opens a little, hooking on the **stop**. The cooking cycle is stopped, if in progress.

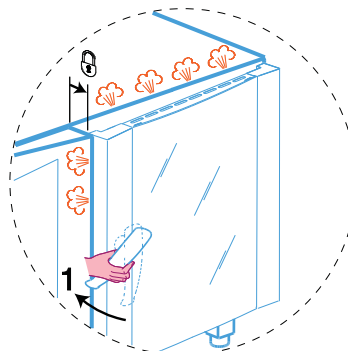

- b) Turn the handle all the way anticlockwise to open the oven door completely.

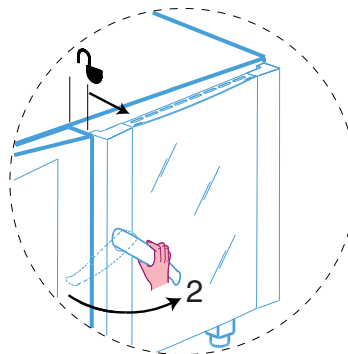

#### 1.2 20-RACK MODEL



**Attention! Risk of burns. Always** open the door with caution when the oven is hot.

- a) Turn the handle anticlockwise 90° to open the door completely. The cooking program is stopped, if in progress.

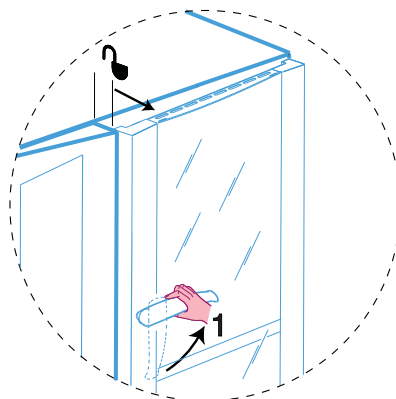

### 2. OVEN DOOR CLOSING

#### 2.1 6 AND 10-RACK MODELS

Closing is obtained by pressing the door against the oven enough to lock it.

#### 2.2 20-RACK MODELS

- a) Turn the door handle all the way anticlockwise and bring the door against the oven.  
b) Keeping the door pressed against the oven, bring the handle to the upright position and lock it.



### 3. DESCRIPTION OF CONTROL PANEL

The control panel has the following controls:

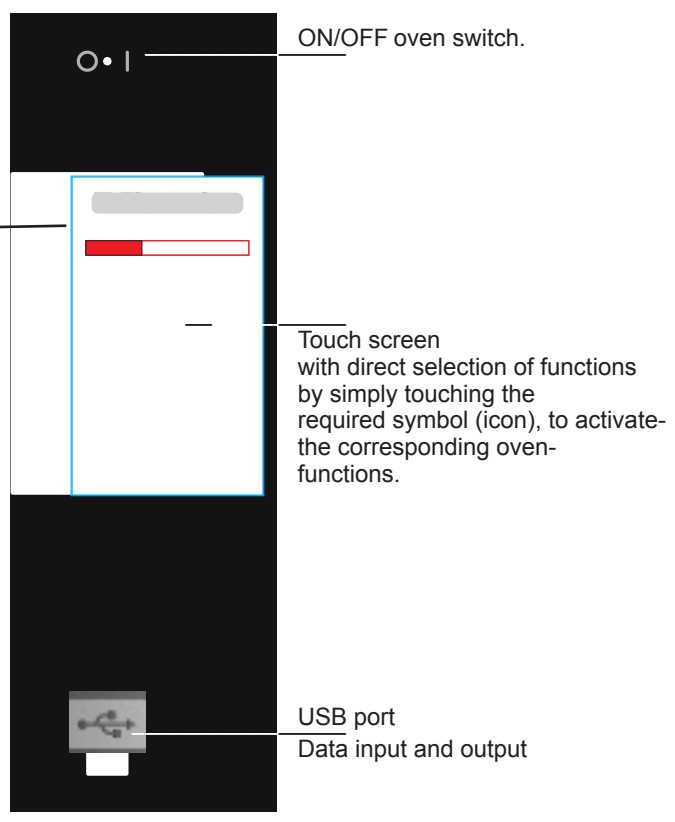

### 3.2 MAIN FUNCTIONS AND SYMBOLS

#### MANUAL

- Hot air cycle:** for roasting and gratinating with max. temperature 300°C.
- Combi cycle:** superheated steam. The steam generator and compartment heaters are used at the same time to keep foods tender (max. temperature 250°C).
- Steam cycle:** ideal for boiling (operating temperature automatically fixed at 100°C).
- Low temperature steam** can be set for gentle cooking, vacuum packed foods and for defrosting (temperature from 25°C to 99°); **superheated steam** (temperature from 101° to 130°C).

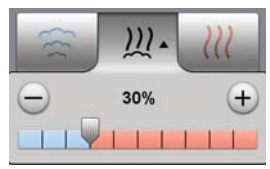

**Electronic humidity adjustment:** for adjusting the required humidity level in the **Combi Cycle**.

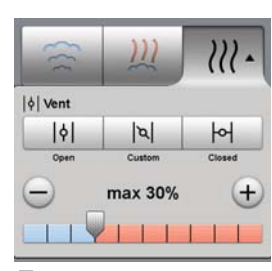

**Humidity setting and adjustment:** for activating or excluding the humidity or adjusting the required level in the **Hot Air Cycle**.



**Hot air cycle with compartment vent open:** for very dry cooking, allowing the removal of humidity when necessary (max. temperature 300°C).



**Hot air cycle with adjustable compartment vent:** for cooking with humidity adjustable from 1 to 99 %, allowing the removal of humidity when the set value is exceeded.



**Hot air cycle with compartment vent closed:** for cooking with high humidity. (Default setting)



**Digital thermostat** for control of compartment temperature.



**Timer** for control of cooking time. The letter S next to the number means short cooking cycle; see symbol MM:SS.

or



**Digital thermometer/thermostat** for control of product core temperature.

**Cooking with ECO-DELTA:** for cooking large pieces of food (at least 5kg, e.g. whole turkey, leg of pork, etc.). In this cooking mode a temperature setting of between 1°C and 120°C is selected.

In this case, cooking is moderate and long, since the COMPARTMENT temperature is automatically adjusted according to the temperature inside the food (CORE PROBE), maintaining a constant difference (ECO-DELTA) between them, from start to end of cooking.

The **ECO-DELTA** function is only possible with the core probe inserted.

Example:

COOKING:	START	.....	END
ECO-DELTA	= 80°... 80...80...	80...	80°C (set)
CORE PROBE	= 10°... 11...12...	40...	60°C (set)
COMPARTMENT	= 90°... 91...92...	120...	140°C (result)



**Fast compartment cooling:** useful for going from one type of cooking to another at lower temperature; it enables fan rotation and automatic injection of water (TS < 180°C) even with the door open.



**Attention!** Risk of burns. **Always** open the door with caution when the oven is hot.



**Continuous cooking:** the cooking time is endless, therefore it is necessary to press STOP when the food is cooked.

MM:SS

**MM:MINUTES** and **SS:SECONDS** for short cooking cycles. Converts minutes into seconds and the letter S appears next to the number in the bar as an indicator

**INFORMATION - NOTES - WARNINGS**



**Information area**  
Area displaying current Status, Error, Warning and Utility information.



**Warning light signalling oven door open.**



**Scale indicator:** when this light comes on, the steam generator must be descaled. Follow the instructions given in par. 6.1.

**Steam generator status light:**



- generator in **filling** phase or no water. **Make sure water reaches the oven!**



- generator in **preheating** phase.



- generator **ready** (indicator light off).



**burner off**



**Error**



**Attention**



**Information**



**Queries**

**UTILITIES**



**Low speed cycle (fan):** for gentle baking, such as light patisserie. Combinable with all cycles.



**Pulsed speed cycle (fan):** for low temperature cooking, ideal for maintaining cooked products, dehydrating or drying for vegetables or finishing food. Combinable with all cycles.



**Normal speed cycle (fan):** for normal cooking. Ideal for roasting, gratinating and classic cooking. Combinable with all cycles. (Default setting)



**Manual injection of water in compartment:** for instantly increasing the humidity level during a cooking cycle. Use the + and - buttons to adjust the injection duration in seconds (10 s intervals).



**Low power cycle (heating):** for gentle baking, such as light patisserie. Combinable with all cycles.



**FSC-STANDARD risk cooking:** for foods having a low contamination level.



**FSC-HIGH risk cooking:** for foods having a high contamination level.



**FSC-**The FOODSAFE CONTROL had positive results, cooking occurred in safe conditions



**Save Program**



**Programmed Start:** allows the cooking cycle to be started later by setting the required time.



**Multitimer:** for setting cooking of foods at the same temperature but at different times (max. 14).

**MULTIPHASE**



**Cooking with phases in sequence:** for setting cooking programs with several phases in automatic sequence (max. 15 phases).



**Active pause phase**



**Add pause phase:** by entering a time value in this mode it is possible to delay the start of cooking programs or include a pause between two cycles (e.g. proving).



**Active Maintaining Cycle phase.**



**Add Maintaining Cycle (70°C):** for slow and prolonged cooking, typically for meat (large cuts). Activated at the end of cooking. Combinable with all cycles.

**SPECIAL CYCLES**



**Regeneration cycle:** produces the optimum humidity for fast heating of products to be regenerated. Ideal cycle for heating and regenerating complete menus, single or multiple portions (e.g. banqueting) in pans or single dishes. Also ideal for regenerating stale bread.



**Low Temperature:** low temperature cooking cycle to obtain tender and evenly cooked food.



**Proving:** Ideal cycle for raising baking products, buns, pizzas and various doughs.

**VARIOUS AND COMMON FUNCTIONS**



**Manual draining of steam generator water:** press the button to drain water from the steam generator. (See 6.1 STEAM GENERATOR PERIODICAL MAINTENANCE)



**Attention! In order to prevent excessive scaling in the steam generator, make sure to:**

- respect the parameters regarding the water supply – see installation;
- always drain the generator at the end of each day.



**Compartment preheating:** indicates that the oven is preheating the compartment (please wait). This phase can be skipped in MANUAL mode but not in AUTOMATIC mode.



**SKIP PHASE:** the next foreseen phase can be skipped for particular types of cooking.  
- Compartment preheating (excluding AUTOMATIC)  
- Low temperature phases (PREHEAT, SEARING)



**Skip PHASES in Multiphase:** one or more phases can be skipped during cooking with Multiphase.



**Confirm**



**Go back to previous page**



**Cancel space (Backspace)**



**Find Program**



**Custom**



**Upload data in oven from USB port**



**Download data from oven on USB port**



**Restore oven configuration to default values (Reset)**



**Drawer**

The drawer is an expansion located inside several environments of the menu and contains options that are useful in some functions.



**Technical assistance**

# OVEN USE

## 4. CONTROL PANEL USE

### Foreword:

When selecting certain functions, the initial status is restored if no button is pressed within 15 seconds (approx.).

### 4.1 SWITCHING THE OVEN ON

Before using the oven, make sure:

- the external electric safety switch is on;
- the water shutoff cocks are open;
- the oven outlets are not blocked.

Switch the oven on by pressing the button I (O - I) of the following switch:



the start screen will appear, during which the electronic board performs several checks.

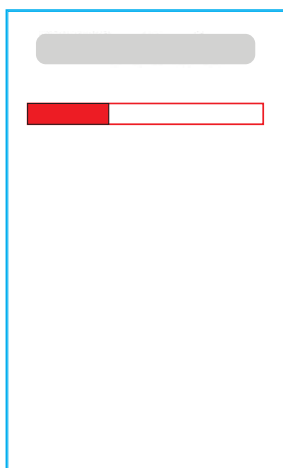

**Touch screen**

Touch the symbols on the "touch screen" to select the oven functions, setting and modifying the relevant values. It is also arranged with a basic functions menu to simplify use, and can be customised as required by adding or removing some functions. The "touch screen" has a similar use to that of a cell phone and computer, with drop-down menu and keypad for entering values. In some cases, by touching the required symbol a screen relevant to the symbol appears, and in others only the function is selected.

**TOUCH the required part of the Display to perform any operation, such as:**

- select
- confirm
- change screen (or Display page)

### 4.2 SWITCHING THE OVEN OFF

To switch the oven off, press the button O (O - I) of the following switch:

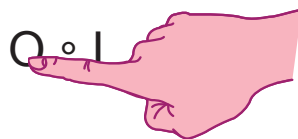

### 4.3 SELECTING CONTROLS (AREAS)

The controls are mainly divided into 5 different management areas for the various functions. These are selected from the CONTROLS MENU in the drop-down menu of the first line of MANUAL mode.

Manual	= manual cooking mode (conventional).
Programs	= use of existing programs (or recipes) and storing of new ones.
Automatic	= automatic cooking system.
Cleaning	= cleaning programs for oven compartment.
Settings	= variation and configuration of functions.



# 4.4 MANUAL

After SWITCHING THE OVEN ON the following MANUAL cooking mode screen appears:

Drop-down "CONTROLS MENU":

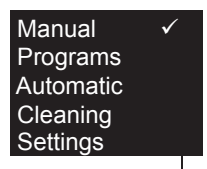

Manual

Phase 1 of 1

50% Humidity bar

48° Temperature



0:30 Current TIME

START





Information area icon

"DRAWER" drop-down menu with Utilities in several items of the CONTROLS MENU

To set a cooking cycle, select the required CYCLE:

-  HOT AIR (touch)
-  COMBI (touch)
-  STEAM (touch)

and set:

- HUMIDITY (excluding STEAM cycle) (touch CYCLE button)
- TEMPERATURE (touch the bar )
- TIME (touch the bar )
- or CORE PROBE (touch the bar  and then )

In this way a cooking cycle has been set; now, just close the door and touch START to start the Cycle. The PREHEATING stage starts, after which the message "LOAD" appears, indicating to place food in the oven; close the door to start cooking. In case of AUTOMATIC START, just close the door to automatically start the cycle.

After about 10 seconds the following Cooking in Progress screen will appear:

Phase 2/3

Combi

Humidity bar

160°

2:17

2:30

Information area icon

\* In PROGRAMMED mode, the word "Combi" will be replaced by the name of the Program or Recipe in progress (e.g. Chicken)

This figure (for information) shows nearly all the possible cases; but only those concerned are presented. Touch this screen to return to the MANUAL control Settings. Any setting already made can be modified and the Cooking Cycle can be stopped by touching STOP for a few seconds. The SKIP COMPARTMENT PREHEATING function also appears with the respective symbol  next to the STOP button, to skip preheating for particular types of cooking.



The previous description regarded setting a cooking Cycle. Now, this will enable setting others in a more complex way, by adding the other functions made available.

The functions in MANUAL Cooking mode are as follows:

cycle HOT AIR		HUMIDITY	TEMPERATURE	TIME	CORE PROBE
	adjustable	x (vent	x	x (max. 8 hours)	x (from 10° to 99°)
	compartment vent open	x	-	-	-
	compartment vent closed	x	-	-	-
	Eco Delta *	-	x (from 20° to 120°)	-	-
	endless	-	-	x	-
	MM:SS (short cooking cycles)	-	-	-	max. 59 min. and 59 sec. -
cycle COMBI		HUMIDITY	TEMPERATURE	TIME	CORE PROBE
	adjustable	x (%)	x	x (max. 8 hours)	x (from 10° to 99°)
	Eco Delta *	-	x (from 20° to 120°)	-	-
	endless	-	-	x	-
	MM:SS (short cooking cycles)	-	-	-	max. 59 min. and 59 sec. -
cycle STEAM		HUMIDITY	TEMPERATURE	TIME	CORE PROBE
	adjustable	-	x	x (max. 8 hours)	x (from 10° to 99°)
	Eco Delta *	-	x (from 20° to 120°)	-	-
	endless	-	-	x	-
	MM:SS (short cooking cycles)	-	-	-	max. 59 min. and 59 sec. -

\* Eco Delta: on setting the temperature range, a small triangle will appear as a reference next to the value; also, the time bar goes to that of the core probe for the relevant setting.

E.g. In the HOT AIR cycle, as indicated in the previous table, it is possible to set the Humidity, Temperature, Time or Core Probe, and Temperature with Eco Delta, compartment Cooling, endless Time for continuous Cooking (conventional cooking) and Short Cooking Cycles (MM:SS).

To set the data of the various functions, a keypad like the following is used:



To zero-set the value just entered, touch the 0 on the keypad.

If a function (e.g. Eco Delta ) has been set on the keypad, to cancel it just touch the same button again.

To return to the initial setting, select another cycle and return to the same.

Cooling: it is possible to set an oven compartment cooling temperature to be reached, which will be indicated with the corresponding symbol on the cooking in progress screen. Compartment cooling therefore occurs manually and is done outside the cooking cycle.

To add more functions, there are the UTILITIES situated in the DRAWER and selected as cooking cycle variables.



DRAWER open

UTILITIES

INFORMATION  
real data

### UTILITIES (see page 47)

cycle	HOT AIR	COMBI	STEAM
Fan speed *	x	x	x
Injection of water in compartment x (from 10sec. to 120sec.)	-	-	-
Reduced power	x	x	x
Programmed Start	x	x	x
FSC (Food Safe Control)	x	x	x
Store programs	x	x	x

\* The default speed is the maximum and never appears in the information field, whereas the others will appear if selected (half or pulsed).

### INFORMATION (real data)

- 23% humidity
- 175° compartment temperature (C°)
- 28° core probe temperature (C°)
- 01:58 clock (1 hour : 58 minutes)

**Important**  
When the oven is switched on after several hours of inactivity, wait 20 seconds (the time necessary for stabilisation of the LAMBDA probe) for a correct HUMIDITY reading.

#### 4.4.1 MULTIPHASE

Food can be cooked with different modes during its cycle and therefore in different phases.  
The oven enables programs consisting of several sequential phases (up to a max. of 15 phases). During cooking, going from one phase to the next occurs automatically, until automatic stopping of the program with completion of the last set phase.  
A cycle with several phases is set by carrying out the following operations:  
1) switch the oven on;  
2) Set for PHASE 1:  
- cooking mode (humidity if necessary);  
- compartment temperature;  
- cooking time (or alternatively the core probe temperature).  
3) Press the "Phase" button and then the "Add new phase" button.  
4) For PHASE 2 and following, set as per PHASE 1.  
When there are several phases, these will be listed, giving the relevant settings (an arrow will scroll the next ones which are not displayed).

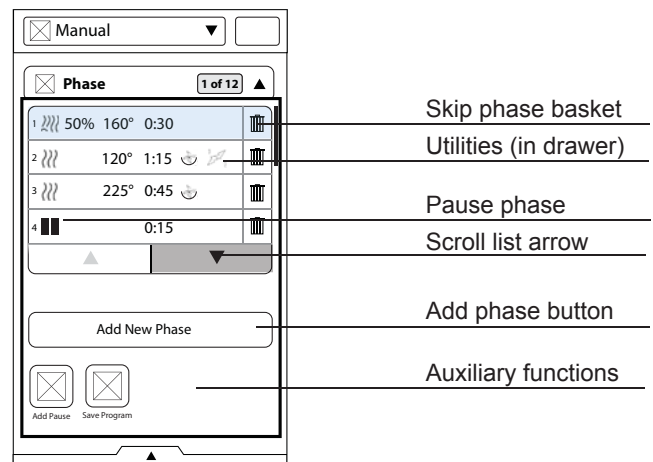

The figure shows phase 1 with the following settings:

- 1 phase number
- combi cycle
- 50% humidity
- 160° temperature (C°)
- 0:30 cooking phase time (0 hours : 30 minutes)

Also, one or more phases can be skipped during cooking; press the symbol next to phase 3 (ex. in figure) to go to this.



The Multiphase also has special phases, such as:  
- Pause for setting a pause between cooking cycles.  
- Maintaining cycle with the possibility of setting a food temperature that is kept constant for an infinite time  $\infty$ .

#### 4.4.2 MULTITIMER

With the MultiTimer system it is possible to set a different time for each recipe (chicken, potatoes, etc.) or for each pan placed on the various levels, e.g. starting from level 1 at the top and going down to 2, 3, etc.  
This function also allows the oven to be used with an "à la carte" menu, where the food can be placed in the oven at the required time.

To set the MultiTimer, proceed as follows:  
1) open the drawer in Manual mode and press the relevant button



Then press the following buttons:  
2) START cycle start for setting the Multitimer



3) MultiTimer to access the setting of times.

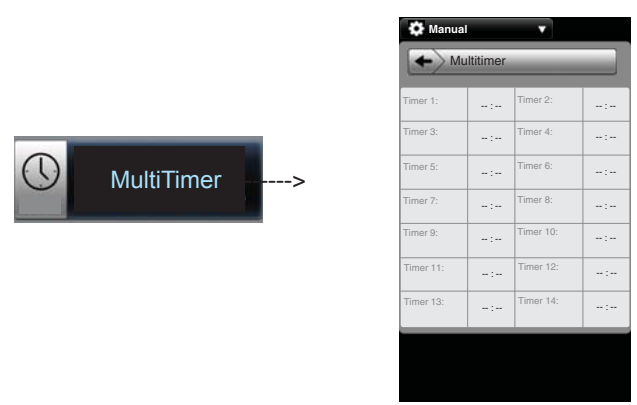

- 4) Timer1 and enter the recipe name (chicken, potatoes, etc).
- 5) --:-- and enter the time with the keypad.

For Timer2 and following, set as per Timer1.

To start the cooking cycle, open the oven door, load the food and close the door.  
The MultiTimer will start the countdown with the position having the shortest time setting.

At the end of each set cooking time the oven will sound a beep to indicate the type of food cooked. Open the door and remove the ready to serve product.

#### 4.4.3 ECODELTA

 The ECO DELTA function enables cooking without harming the food with high temperatures; this ensures more gentle and more even cooking, with less weight loss. This is an advanced cooking method, where the oven compartment temperature varies according to the core temperature of the food.

The operator can select a Delta value of between 20°C and 120°C; it is advisable to set a value between 20°C and 70°C, and a value between 10°C and 99°C for the Core Probe. The oven compartment temperature is automatically adjusted in order to always be higher than that in the core of the product.

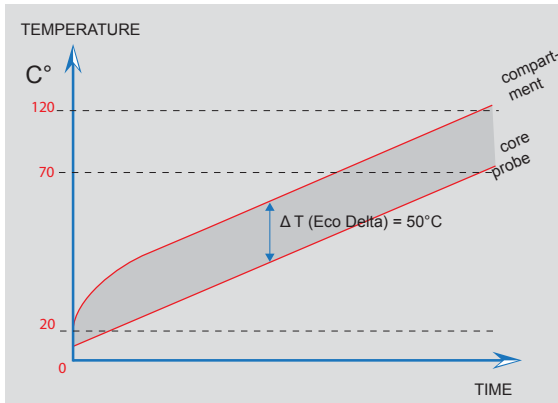

The graph shows an example with a set Delta of 50°C where the compartment temperature increases, keeping this difference of 50°C constant with respect to the core probe.

This type of cooking is slower than the conventional cooking method but has the advantage of obtaining better product results and quality.





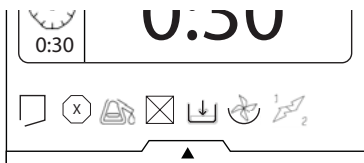

This type of cooking is ideal for large pieces of meat.

#### 4.4.4 INFORMATION AREA



The information area is the zone above the drawer that displays oven operation status with icons, subdivided into items.

The figure above gives (starting from the left) the following:

-  door open
-  error x
-  descaling,
-  boiler preheating
-  fan speed,
-  reduced power

#### 4.4.5 FSC (Food Safe Control)



The FOOD SAFE CONTROL (FSC) is a device enabling the microbiological SAFE condition of the food to be controlled during cooking.

Depending on the chosen food category (HIGH risk or STANDARD risk), during cooking the FSC recognises the moment when the food reaches an acceptable sanitisation level for its SAFE consumption.

The cooking results can be shown on the DISPLAY.

The process requires strict compliance with proper food processing practices according to the rules of hygiene, before and after cooking.

Cooking using the FSC does not sanitise bad or deteriorated food, which remains so even after cooking.

To use the FSC, set a cooking cycle as described above.

Always insert the CORE PROBE even with TIMED cooking cycles.

The FSC is composed of 2 categories:



**FSC-STANDARD risk cooking:** for foods having a low contamination level. (e.g. whole pieces of beef)



**FSC-HIGH risk cooking:** for foods having a high contamination level. (e.g. roulades of meat, mince-meat, poultry, pork, fish)

Set the HIGH or STANDARD risk category in the UTILITIES drawer and press "START" to start.

In this way, cooking with the FSC starts; if the safe condition is reached during cooking, a confirmation will appear next to the FSC symbol:



F: 0.0

The Pasteurization factor F with value reached will also appear (if set).

If, on the other hand, cooking does not end in a safe condition, the FSC warns with a dialogue window and requests ending of the cycle automatically or manually by the user.

At the end (in one way or the other), the following will appear:

- |       |                     |
|-------|---------------------|
| FSC ✓ | for positive result |
| FSC x | for negative result |



### 4.3.6 CORE PROBE USE



(PRODUCT CORE TEMPERATURE CONTROL)  
The core probe allows accurate control of the core temperature of the product being cooked. This enables setting of the required value (from 10°C to 99°C) and automatic stopping of cooking when that value is reached.



**Attention:** The core probe is a precision component. Absolutely avoid impacts, forcing when inserting, and pulling of the flexible cable (in particular when using the trolley-mounted structures). The warranty does not cover the replacement of core probes damaged by improper use.

After selecting the time icon select that of the core probe and press **START** to start the cycle.  
- Wait until the compartment temperature field indicates reaching of preheating (the message LOAD appears).  
- Open the door and introduce the product to be cooked.



**Attention!** Risk of burns. **Always** open the door with caution when the oven is hot.

1) Remove the core probe "A" from its seat "B" and insert it in the product without forcing excessively, making sure the tip (the sensitive part) is positioned near the centre of the product.

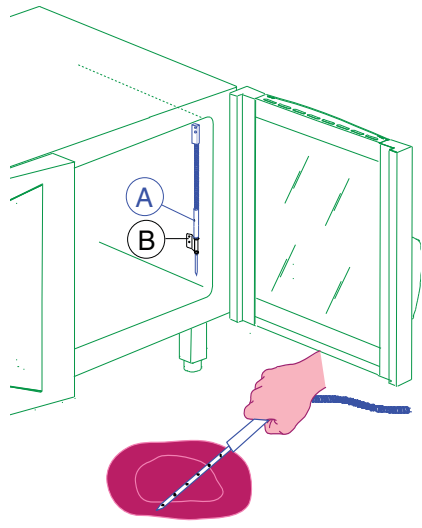

—————MULTIPOINT 6-sensor core probe

The oven is equipped with a MULTIPOINT core probe with 6 sensors along the entire stem, for correctly measuring the product core temperature even if the tip is not completely in the centre.

- Close the door and press the **START button**.
- 2) **Stopping the cycle.** When the required product core temperature is reached the oven stops automatically and the elapsed cooking cycle time is displayed.
- 3) **Core probe mode deactivation.** Set a cooking time on the Timer . This action automatically cuts out the core probe, whereas it is the opposite when the time is set. The core probe mode is also deactivated when the oven is switched off.

**Note:**  
With vacuum packed food products it is necessary to use the special external core probe (accessory available on request), to be connected to the USB socket. For its use, see the instructions included with the accessory.

### 4.3.7 END OF COOKING

At the end of the set time, the cooking cycle automatically stops and the oven buzzer sounds continuously. The display shows the message:



COOKING FINISHED !

Several parameters such as the following are also displayed:  
- total time  
- FSC a bar with relevant result will appear if set.

Open the door and remove the product.



**Attention!** Risk of burns. **Always** open the door with caution when the oven is hot.

**Notes:**  
- The buzzer can be stopped in advance by carrying out any operation on the control panel or by opening the door. The cooking cycled can be manually stopped by keeping the STOP button pressed for a few seconds. A cycle identical to that just completed can be repeated by pressing the START button again.

## 4.5 AUTOMATIC

The AUTOMATIC control mode is used for automatic cooking, by setting several simplified functions. This saves the operator from having to know the cooking parameter values (temperature, time, humidity) and makes the same type of cooking more equal.

Select AUTOMATIC from the Main Menu.  
The functions to be set are as follows:

- 1) food **TYPE**
- 2) cooking **MODE**
- 3) preset **COOKING**

There are also several parameters (which differ according to the cooking Mode used) to be confirmed or modified, such as :

- Form of food (whole or fillets)
- Cooking system (timed or with core probe)
- Food Browning level (low, medium, high)
- Food cooking level (rare, medium, well done)

### 1) TYPE of food

- Red meat
- Minced meat
- Poultry
- Fish
- Vegetables
- Side dishes
- Bakery
- Dessert



Also the Special Cycles can appear on the same screen.

### 2) Cooking **MODE**

- (example)
- Baked
  - **Steamed**
  - Grilled
  - Gratin

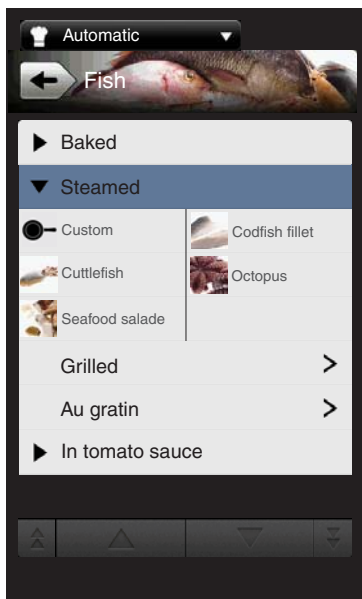

There are completely automatic cooking Modes where no parameter can be set (e.g. Red Meat \ Steam).

### 3) Preset **COOKING** (example in figure)

#### ▼ Steamed

- Custom
- Codfish fillet
- Cuttlefish
- Octopus
- Seafood salade

Select one of the preset COOKING cycles to access the following example screen (Roast meat) where the cooking MODE parameters are shown with the preset (default) choices which can be modified if required.

#### Form of food

- Whole
- Fillets

#### Browning Level

- Low
- Medium
- High

#### Cooking Level

- Rare
- Medium (70°)
- Well Done

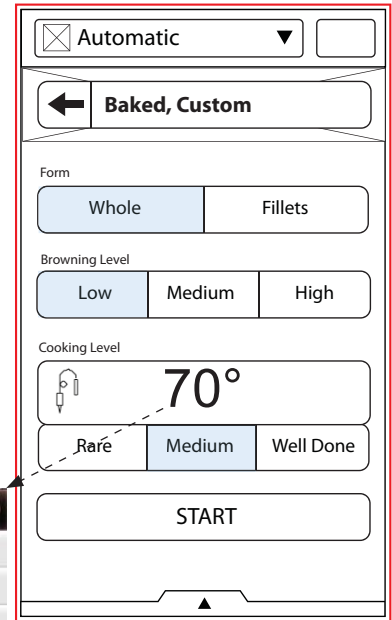

keypad for adjusting the core probe temperature

## 4.3.9 SPECIAL CYCLES

The special cycles appear on the AUTOMATIC mode main screen, and are as follows:

- Low Temperature Cooking
- Proofing
- Reheating

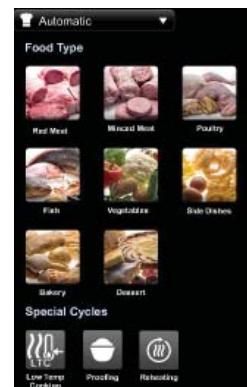

### LOW TEMPERATURE COOKING (EFS-LTC)



Low temperature cooking is a specific cooking procedure particularly recommended for beef, such as entrecote, rump and fillet, but also good for other types of meat, including veal, lamb, venison, turkey, duck, pork, etc.

The meat cuts can be: roast-beef, shoulder, leg, saddle, steak with bone, rump, fillet, cutlets, etc.

The EFS-LTC is a completely automatic preset program, for obtaining tender and evenly cooked **food**.

The program comprises 4 main phases:  
PREHEAT, SEARING, MATURE, HOLD.

Select AUTOMATIC



Press the button

Set the program by entering the SEARING temperature, then enter the core probe final temperature and press



**During the Preheating phase it is advisable to place the core probe outside the compartment.**

After the PREHEAT phase (if necessary modify the compartment temperature already set) LOAD the food in the oven and insert the 6-sensor MULTIPOINT core probe (if necessary modify the core probe temperature already set).

Close the door to start the cooking cycle. The SEARING (dry heat sealing of the food) phase starts, followed by quick oven cooling (CoolDown) for subsequent slow cooking with the MATURE phase (for tenderising the meat). This is followed by the food temperature HOLD phase.

The entire EFS-LTC cycle can take several hours. One or more phases can be skipped, going to the next phase; this is useful, for example, when cooking is started (SEARING phase) with another appliance (e.g. frytop) and is to be completed with the oven (MATURE and HOLD phase). The MATURE phase cannot be skipped.

Main advantages:

- Excellent quality of the food.
- The standard LTC procedure guarantees repeatable results from year to year.
- Typical roast flavour; succulence of the food from the centre to the edge.
- Uniform colour and perfectly even cooking.
- Quick maturing process, time-saving and possibility of using fresh cuts of meat.
- Lower weight loss, 5-8% (depending on the quality of the food and core probe temperature setting).
- Considerable saving of portions for sale.
- Considerable energy-saving due to the EFS-LTC smart program.

### PROVING



Proving is done like a normal cycle, setting the time and temperature.

Several utilities such as fan speed and programmed start can also be used.



possibility: delayed start.

### REGENERATION



When set, the regeneration program functions like a normal automatic cycle.

Select one of the following items:

- ▼ Pan
  - Custom
  - Core Probe
  - Timer
- ▼ Plate
  - Custom
  - Core Probe
  - Timer

Bread > (Timer)

Then, for example, by selecting Pan and Core Probe, the following figure appears:

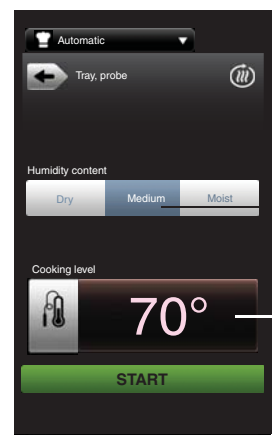

Medium selected

Core probe temperature (modifiable)

Lastly, press START to start the cycle.

## 4.6 PROGRAMS

The PROGRAMS control is used for already stored programs (or recipes), storing new ones and managing them inside a list.

program search

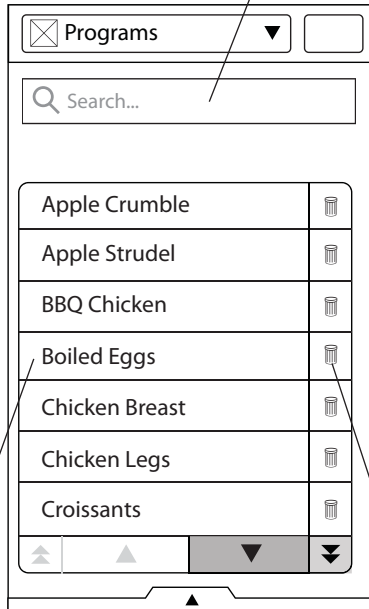

list of programs (example)

program cancel button (basket)

### 4.6.2 PROGRAM SEARCH

To find a program, enter the name using the keypad and press OK. The program with name closest to the one required will be highlighted on the list.

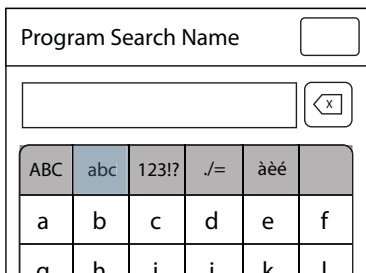

ABC = Upper case letters  
 abc = Lower case letters  
 123 = Numbers  
 ./= = Symbols  
 àèé = Other characters

### 4.6.3 START PROGRAM

Press the button of the Program Name on the Program List to access the Start screen and set the cooking parameters or start the program.

### 4.6.4 SAVE PROGRAM



Press this button to access the screen to save the program (or recipe); this is similar to the search by entering a name and confirming with OK.

## 4.6.5 LOAD / SAVE PROGRAMS

### LOAD recipes / programs in Oven from USB:

- 1) Insert the USB key.
- 2) Access the Programs menu
- 3) Open the drawer and select the symbol



(upload from USB)

- 4) Select the required file (e.g. UI40\_01.prg)

Wait for completion of the loading process.

**Attention:** Recipes / programs with the same name will be overwritten.

- 5) Press OK and remove the key.

### SAVE recipes / programs from Oven on USB:

- 1) Insert the USB key.
- 2) Access the Programs menu
- 3) Open the drawer and select the symbol



(save on USB)

Wait for completion of the save procedure.

- 4) Press OK and remove the key.

## 4.7 CLEANING

### CLEANING SYSTEM

This cleaning system carries out automatic compartment washing with suitable detergents according to the amount of grime detected; therefore the following 4 cycles have been provided for:



#### CLEAN Soft

For still fresh grime from not very greasy cooking (e.g. with STEAM cycle)



#### CLEAN Medium

For normal grime from greasy cooking.



#### CLEAN Strong

For heavy grime from very greasy cooking (e.g. roast chicken, sausages).



#### CLEAN Extra Strong

For heavy grime from very greasy cooking (e.g. roast chicken, sausages) even with dried residuals (encrustations).

To use these stored programs, proceed as follows:

#### Note 1:

Before cleaning the compartment with the CLEANING SYSTEM, remove the grease filter (if present).

The CLEANING SYSTEM cycle **starts** when the temperature has automatically reached **70°C in the compartment**.

Before carrying out a **CLEANING SYSTEM** cycle, make sure there is detergent in the containers (located under the control panel on models 6-10GN1/1 or independent in models 20GN1/1-2/1) and that it is of the required type, therefore see par. 6. CLEANING AND MAINTENANCE.





**Warning:**

In case of complete emptying of the detergent and/or rinse aid containers or emptying of their supply tubes, the CLEANING SYSTEM cycle must be started after firstly doing the CLEAN 1 cycle, then the same or other cycles. This operation allows the pipes to be refilled with the appropriate liquids and the cleaning cycles to be done correctly.

If the CLEANING SYSTEM is not used for long periods, it is necessary to do a cleaning cycle (CLEAN 1) with water instead of detergent and rinse aid before and afterwards, to flush the respective supply pumps.

- Select a cleaning cycle (Medium is preset).

		Green Spirit / Economizer	
<input checked="" type="checkbox"/> Cleaning			
 Green Spirit		or	and
<input checked="" type="checkbox"/> Soft	0:45	0:35	0:25
<input checked="" type="checkbox"/> Medium	1:00	0:45	0:35
<input checked="" type="checkbox"/> Strong	1:30	1:15	1:05
<input checked="" type="checkbox"/> Extra Strong	2:30	2:10	2:00



Cycle duration  
2 hours  
30 minutes

- If necessary, select one of the **Green Spirit / Economizer** functions.



 **Green Spirit**

/

 **Economizer**

 Skip Rinse Aid  
  Skip Drying Phase  
  Reduce Water Consumption

 /  The "Green Spirit / Economizer" function enables use of the cleaning programs in respect for the environment.

-  If "Skip Rinse Aid" is selected, remember that the traces of scaling could remain in the compartment after cleaning.
-  For "Skip Drying Phase" it is necessary to open the door after cleaning, to air the oven.
-  For "Reduce Water Consumption" make sure an efficient ventilation system is installed. Reduction occurs by deactivation of fume suppression.

- Press START to start the cycle. If necessary, to stop the cleaning cycle press STOP for a few seconds.

## 4.8 SETTINGS

Select one of the following items:

	Language
International	International
Date	Date
Clock	Clock
Food Safety	Food safety

### LANGUAGE

Settings
 

← Language
 

中文  
 日本語  
 한국어  
 Български  
 Dansk  
 Deutsch  
 Eesti  
 English

select the language  
scroll list of languages

### INTERNATIONAL

set the language

Settings
 

← International
 

Language  
 English

Date Format  
 - DD/MM/YYYY +  
 29/03/2010

Time Format  
 24 H    AM/PM

Temperature  
 °C    °F

select the unit of measure for temperature (°C Celsius or Fahrenheit °F)  
select the required time format  
select the required date format (+/-)

**DATE****TIME**

Enter the date and time with the +/- sign (or with the keypad).

The example settings in the 2 figures are:

Date  
30 July 2009

Time  
4:35 p.m. (PM: Post Meridiem)

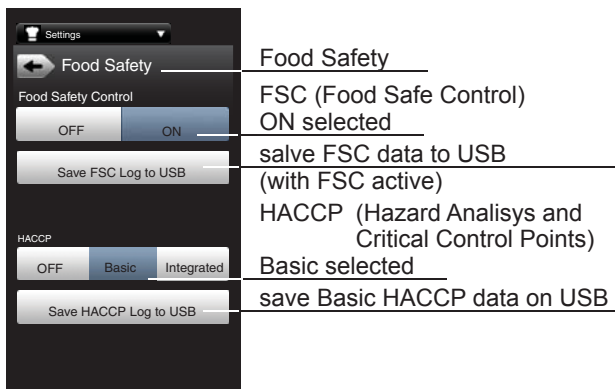
**FOOD SAFETY**

- FSC: see par. 4.4.4

- HACCP: according to the system required, cooking data can be recorded on USB key (Basic) or on Personal Computer (Integrated)

**GREEN SPIRIT****General**

- Oven standby after: 0:30
- No boiler preheat in stop

**Turn off lamps**

- After 0.15 when not cooking

**Cleaning**

- Skip rinse-aid
- Skip drying phase
- Reduce water consumption

**SOUNDS**

- Button pressure sounds
- Standard volume buzzer
- Loud volume buzzer

**MANUAL**

- Enable Manual

- General**
- Show real and set value
  - Multi-phase cooking
  - Delayed start

**Timer/Temperature dialogs**

- Short cooking
- MultiTimer cooking
- Eco-delta cooking

**Opzioni**

- FSC
- Show F value during cooking
- Ask for FSC risk set on start
- Cooking info in drawer

**Hold**

Default convection temp. 70°  
Default steam temp. 70°  
Probe temp. increase: Δ5°

Default cycle >

**PROGRAMS**

- Enable Programs
- Abilita salvataggio Programmi
- Enable Programs save

**AUTOMATIC**

- Enable Automatic
- Low Temperature Cooking
- Proving
- Regeneration

**CLEANING**

- Enable Cleaning
- Force after 0:00 of cooking

**Default cycle**

- Soft
- Medium
- Strong
- Extra strong

**PASSWORD**

Set password

**AUTOSTART**

- Enable Autostart

**LOAD / SAVE CONFIGURATION****SAVE Oven Configuration on USB:**

- 1) Insert the USB key.
- 2) Access the Settings menu
- 3) Open the drawer and select the symbol



(download on USB)

Wait for completion of the download process.

- 4) Press OK and remove the key.

**LOAD Oven Configuration from USB:**

- 1) Insert the USB key.
- 2) Access the Settings menu
- 3) Open the drawer and select the symbol



(upload from USB)

- 4) Select the required file (e.g. UI40\_01.zip)

Wait for completion of the loading process.

**Attention:** Recipes / programs with the same name will be overwritten.

- 5) Press OK and remove the key.

**4.8.1 MAINTENANCE**

**BOILER DRAIN**



**Manual draining of steam generator water:** press the button to drain water from the steam generator. (See 6.1 STEAM GENERATOR PERIODICAL MAINTENANCE)



**Attention! In order to prevent excessive scaling in the steam generator, make sure to:**

- respect the parameters regarding the water supply – see installation;
- always drain the generator at the end of each day.

**GUIDED DESCALING**



Guided descaling of the steam generator (boiler), with pure VINEGAR, facilitates the user in carrying out descaling operations.

For its use, refer to par. 6.1 STEAM GENERATOR PERIODICAL MAINTENANCE.

**TECHNICAL ASSISTANCE**



**Technical assistance**

By pressing this button a password is requested for accessing the area reserved for authorised technical personnel in order to edit the various oven operation parameters.

**5. SWITCHING OFF IN CASE OF A FAULT**

In case of a fault, deactivate the appliance:

- Turn off the automatic power switch located ahead of the appliance and close the water and gas cocks.
- Contact an After-Sales Service Centre with qualified personnel authorised by the manufacturer.

**IMPORTANT!**

**With cooking cycle in progress, the signalling of an error code occurs with continuous sounding of the buzzer and stopping of the cycle.**

**In this case the appliance can be used in ways not involving the conditions that generated the error. Therefore just program the oven for a cycle that does not use the damaged component.**

**The After-Sales Service must be informed of the alarm code appearing on the display.**

**6. CLEANING AND MAINTENANCE**

- Turn off the automatic power switch located ahead of the appliance and close the water and gas cocks.
- At the end of each day, clean the oven compartment using suitable products and following the supplier's recommendations.
- Do not clean the appliance with direct jets of water.
- Do not use products containing chlorine (chlorine bleach, hydrochloric acid, etc.), even if diluted, to clean the steel parts.
- Do not use corrosive substances (e.g. muriatic acid) to clean the floor under the appliance.

MAINTENANCE, INSPECTIONS, CHECKS AND CLEANING	FREQUENCY
<b>Routine cleaning</b>	<b>Daily</b>
General cleaning of machine and surrounding area	

<b>Mechanical protection devices</b>	<b>Monthly</b>
Check condition and for any deformation, loosening or removed parts.	
<b>Control and Machine structure</b>	<b>Yearly</b>
Check mechanical part for any breakage or deformation, tightening of screws. Check readability and condition of words, stickers and symbols and restore if necessary.	
Electrical connection cable and plug	<b>Yearly</b>
Check connection cable (replace it if necessary) and plug.	

The appliance (except for some models) has an automatic compartment cleaning programme called CLEANING SYSTEM; for its use see par. 4.7 CLEANING.

The CLEANING SYSTEM program requires detergents, therefore fill the DETERGENT CONTAINER - max. 5 litres (on RIGHT with RED cap) and the RINSE AID CONTAINER - max. 1.2 litres (on LEFT with BLUE cap) located under the control panel:

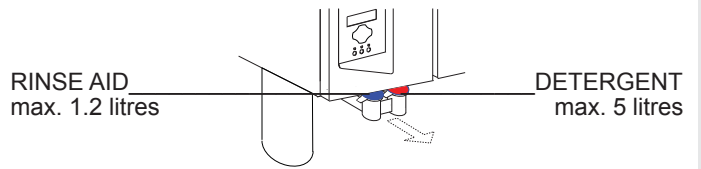

For models 20GN1/1-2/1 connect the tubes (supplied) on the left side of the oven (RH connection RED symbol for DETERGENT; LH connection BLUE symbol for RINSE AID) and insert the other ends in their respective containers (not supplied) filled with DETERGENT and RINSE AID.

To ensure best cleaning results, as well as to protect the oven with the integrated CLEANING SYSTEM, the following detergents must be used:

ELECTROLUX "ExtraStrong Clean for Oven" - Detergent (Code 0S1192)

ELECTROLUX "ExtraStrong Rinse for Oven" - Rinse Aid (Code 0S1193)

Do not use detergent or rinse aid powder dissolved in water or in gel form and containing chlorine.

**ATTENTION:**

The warranty does not cover damage caused by the use of detergents and rinse aids not complying with the above characteristics.

- Detergent and rinse aid containers, independent of the oven, **must not be placed** higher than the appliance support surface (for model 6 GN they must be placed lower than the oven support top).

**Attention:** Contact with chemical substances (e.g. detergent, rinse aid, scale remover, etc.) without taking adequate safety precautions. Therefore always refer to the safety cards and labels on the products used.

To facilitate oven compartment cleaning, remove the rack trolley guides from the bottom of the oven and open the suction wall.

- To open the oven compartment **suction wall A** (Fig. 2) proceed as follows:
  - switch the oven off and disconnect the power to the appliance;
  - undo (1a) screw B2 completely with a screwdriver,
  - insert the tip of a screwdriver in slot B and prise (1b) inwards to open the wall, unhooking it from the pegs B1 at the back.

If required, **completely remove** suction wall:

- unscrew (2) nut C1 with a hexagon wrench.
- lift (3) the suction wall and remove it (4) from the bottom pin C of the oven compartment;
- lower (5) the wall to release it from the top pin D and completely remove it (6).

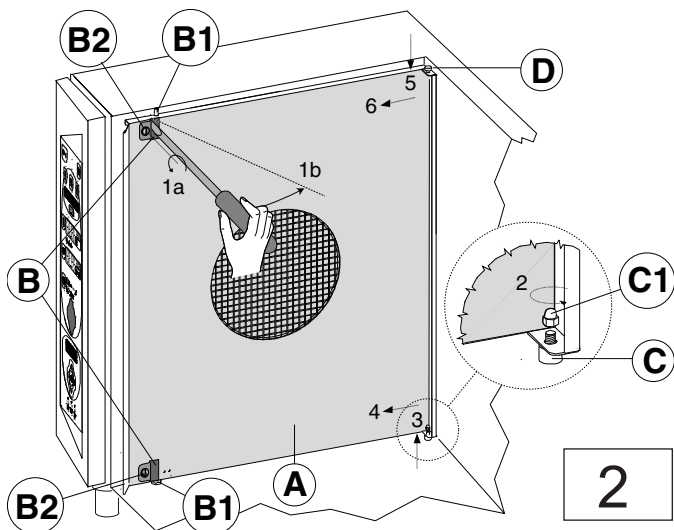

To refit the wall, repeat the steps in reverse order and retighten nut C1.

- If present, clean the oven compartment **grease filter** (not supplied) at least every three cooking cycles.

- If present, clean the **air filter** (not supplied) at least once a month, removing it from under the **control panel**.

Non-compliance with the above will result in filter inefficiency and produce anomalous effects in cooking.

- Clean the stainless steel parts every day using lukewarm soapy water, rinsing with plenty of water and drying thoroughly.

- Do not clean the stainless steel with steel wool, brushes or scrapers in common steel, as they could deposit ferrous particles which oxidise, causing rust spots.

- Whenever the appliance is not used for long periods:

- Disconnect the power supply and close the water and gas cocks;
- go over all steel surfaces vigorously with a cloth moistened with paraffin oil in order to create a protective film;
- Periodically air the premises.

## 6.1 STEAM GENERATOR PERIODICAL MAINTENANCE

- In case of excessive scale in the steam generator the following light comes on



signalling the need to carry out descaling.

**The manufacturer declines any liability if these prescriptions are not respected; also, the warranty does not cover the repair or replacement of components damaged by scale whenever the required supply water characteristics are not respected (see the relevant section).**

Descaling can be carried out using two methods:

- with vinegar, concentration 100%;
- with chemical descaler (carefully following the instructions given below).

**The appliance must be switched on for these operations.**

### 6.1.2 METHOD WITH 100% VINEGAR

The method with VINEGAR is carried out through GUIDED DESCALING.

Select "Settings" from the menu and press the button:



Guided descaling

Follow the steps indicated on the oven display, as listed below:

- 1/5) Make sure the oven compartment is empty
- 2/5) Boiler preparation (emptying): wait
- 3/5) Filling: fill the boiler with pure vinegar via the upper cap until a beep sounds, indicating quantity reached. Given below are the approximate quantities of vinegar (in litres) required for each oven model:

	6-1/1	10-1/1	20-1/1	6-2/1	10-2/1	20-2/1
gas	5	9	9	6	9	23
elec- tric	5	5	8	7	8	15

4/5) Descaling: wait (the remaining time, including rinse, is indicated).

5/5) Rinse: wait (boiler and compartment are rinsed with water and steam); this phase is NOT blockable.

In case of a power failure or oven switch-off during descaling phases 3 and 4, rinse phase 5 will ensue. If it occurs also in this last phase, the rinse will be carried out at the next oven switch-on.

### 6.1.3 METHOD WITH CHEMICAL DESCALER

Descaling with chemical products must be carried out according to the supplier's instructions (the detergent supplier firms).

For example, using the ECOLAB "STRIP-A-WAY" type descaler, proceed as follows:

- 1) Close the water supply cock.
- 2) Completely drain the steam generator by pressing the following button



3) After one minute close the steam generator drain (press the above-mentioned button).

4) Remove the plastic cap of the generator access tube and introduce the following quantity of liquid through the same:

- 2 litres of descaling liquid plus 6 litres of water (6-10gn)
- 4.5 litres of descaling liquid plus 11.5 litres of water (20gn)

5) Open the water cock.

6) Operate the oven STEAM cycle for 12 minutes.

7) Switch off and wait 40 minutes.

8) Switch the oven on again for another 2 minutes.

9) Switch off and wait 60 minutes.

10) With the water cock open, reopen the generator drain valve to empty it (press the above-mentioned button).

11) Switch the oven off.

12) Rinse the inside of the generator with a rubber hose inserted in the pipe, until clean water comes out the drain.

13) Refit the cap and close the steam generator drain (press the above-mentioned button).

**IMPORTANT - 1**

Carefully rinse the inside of the generator with a rubber hose inserted through the generator access pipe, to remove all traces of descaler.

- Refit the cap and close the steam generator drain (pushbutton or lever).

After these procedures it is advisable to operate the oven empty, in STEAM cycle, for 30 minutes.

**IMPORTANT - 2**

If the water cock is not easily accessible, to empty the boiler proceed as follows:

- 1) Open the boiler drain valve with the special pushbutton.
- 2) Wait 2 minutes and switch the oven off; the drain valve will automatically close.

**6.2 REPLACING CONSUMABLE COMPONENTS**

**Replacing the oven compartment lamp (Fig. 3)**

To replace the oven compartment lamp, if burnt out, proceed as follows:

- Disconnect the power to the appliance.
- Undo the 4 screws fixing the light fitting ring nut "A" and remove the glass "V" together with seal "G".
- Remove the halogen lamp "L" and replace it with another one having the same characteristics (12V - 10W - 300°C), using a clean cloth or paper to avoid direct contact with fingers.
- Refit the protection glass, correctly inserted inside the seal, in the lamp compartment and fix the ring nut by retightening the 4 screws, after smearing the seal with food-grade silicone grease.

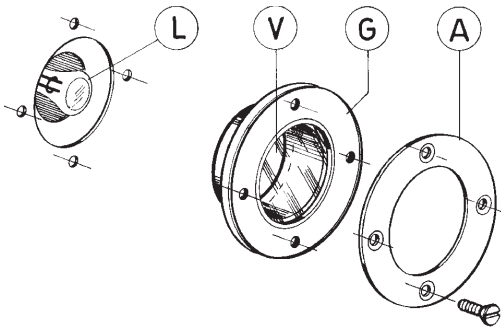

3

**Replacing door seals (Fig. 4)**

**NB:** The door seal is a component that can become worn over time. It is advisable to replace it whenever any hardening or breakage is noticed.

To replace it, proceed as follows:

- Remove the seal from its seat and clean the latter of any traces of silicone.
- Apply a bead of silicone sealant at point 1 along the inside profile of the seal seat.
- Insert the new seal along the entire seat.

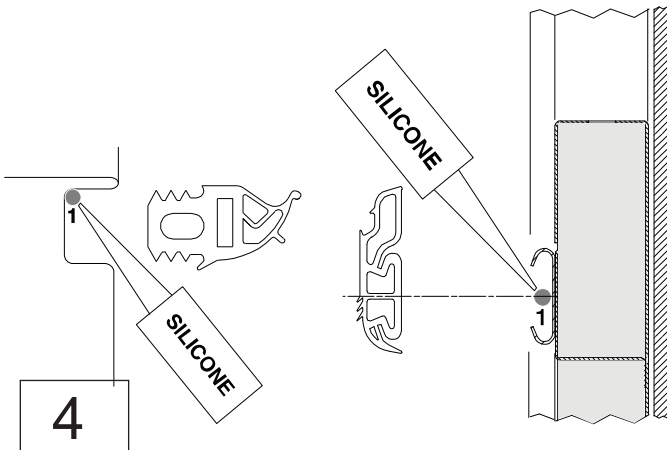

4

**6.3 PARTICULAR CLEANING**

**Discharge system cleaning and efficiency check**

Periodically clean the drain pipe, checking for any obstructions involving the draining of water.

**Cleaning the door internal glass (Fig. 5)**

These operations must be done with the door glass cold, without using abrasive detergents or rags.

The interspace surfaces are accessed by opening the internal glass hinged on the door.

- With the door open, press the two top and bottom retaining clips F and open the internal glass.

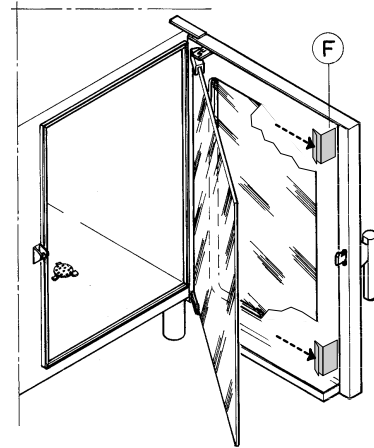

5

After cleaning, close the internal glass against the rubbers.

**Cleaning the CLEANING SYSTEM rotating jet (Fig. 6)**

It is advisable to clean the jet in case of:

- long periods of CLEANING SYSTEM disuse
- difficulty in wash arm rotation (probable nozzle obstruction)
- use of very hard water.

If the nozzles are completely obstructed, use the tip of a knife to remove any encrustations.

- Extract (without removing) the retaining clip A from the middle block of the jet. For this operation insert the tip of a screwdriver in the part indicated by the arrow and turn it from the vertical to the horizontal position as shown in the figure.
- Remove the jet from the rotation pin.

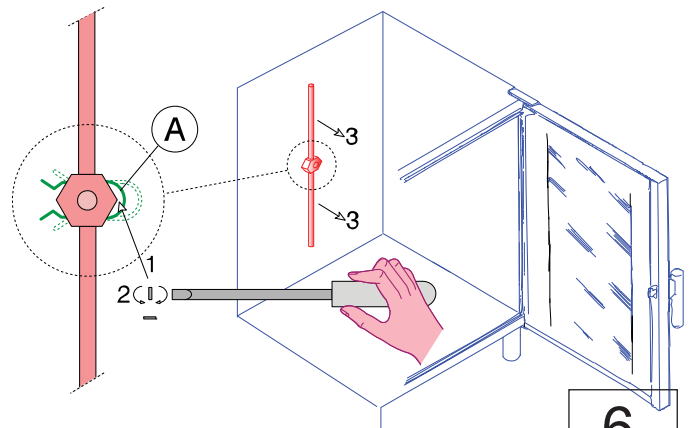

6

- Place the rotating jet in a bowl containing descaler, leave over night then rinse with plenty of water.
- Refit the jet, inserting it on the rotation pin and pressing the retaining clip into its original position.



