



# GE Experience in Fault-Ride-Through-Testing and Model Development

Naresh Acharya, Principal Engineer,  
GE Energy Consulting

Confidential. Not to be copied, distributed, or reproduced without prior approval.

2019 Future Energy Systems Technology Conference,  
April 10, 2019

# Progression of Fault-Ride-Through Requirement

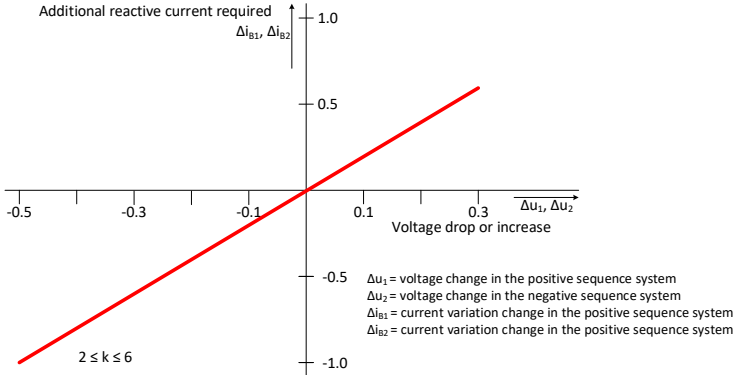
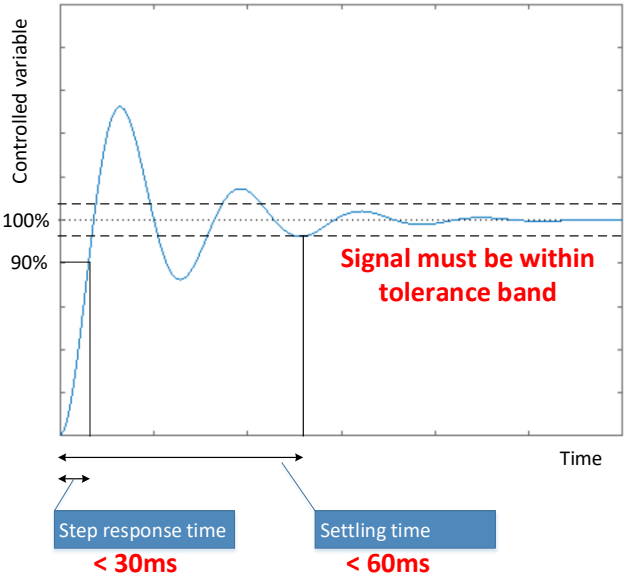
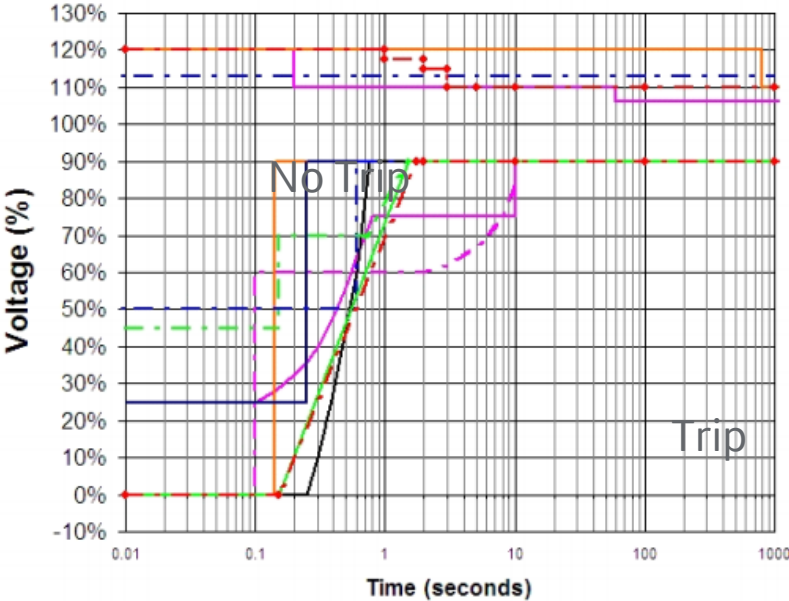

Wind farm required to remain connected during fault

Reactive current injection required during fault  
+  
Dynamics of reactive support (rise time, settling time)

Additional requirement for asymmetrical fault  
+  
Requirement for high voltage ride through

<https://www.wecc.org/Reliability/Voltage%20Ride%20Through%20White%20Paper.pdf>



# Why Fault-Ride-Through Test?

- Evaluation of equipment performance during fault
- Evaluation of grid code compliance (requirement for “certification” in many countries)
- Evaluation and validation of simulation model (requirement for “certification” in many countries)



# Fault-Ride-Through Setup

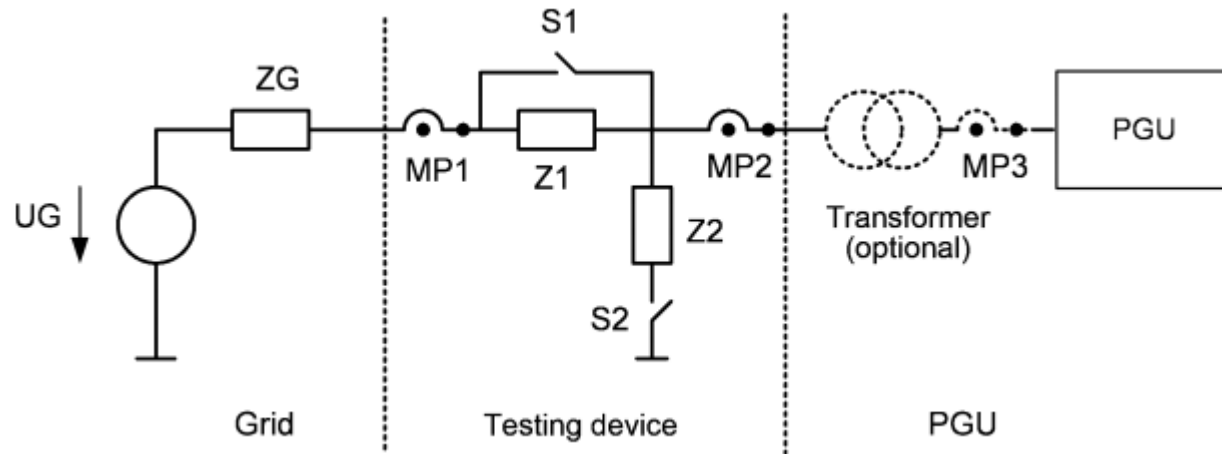

**Grid**

**Test Container**

**Wind Turbine**

MP1, MP2, MP3 – Measurement location  
 Z1 – Serial impedance  
 Z2 – Shunt impedance

MP1, MP2, MP3 – Measurement location  
 Z1 – Serial impedance  
 Z2 – Shunt impedance

Desired voltage for testing can be generated by appropriately selecting size of Z1 and Z2.

Source: Asmine, Mohamed, et al. "Model validation for wind turbine generator models." *IEEE Transactions on Power Systems* 26.3 (2011): 1769-1782.



# Type of FRT Tests

- Three phase and phase-phase faults
- Faults with different voltage dip and rise (LVRT, HVRT)
- Faults with varying duration (based on voltage dip)
- Full load and partial load tests
- Over-excited and under-excited condition
- E.g. certification of turbine according to VDE (Germany) requires more than 30 different variations of fault to be tested, evaluated and validated.



# Typical Steps in FRT testing & evaluation

- Install type of turbine to be tested at the testing site along with FRT container
- Prepare list of tests to be performed to meet the specific grid code & certification requirement
- Configure the converter control according to the specific grid code requirement
- Apply the fault (voltage dip)
- Collect high resolution instantaneous data, process the data to sequence components and evaluate the performance



# Performance evaluation (according to VDE AR-N 4120:20915)

- Additional reactive current during fault in proportion to change in voltage during fault
- Rise time < 30 ms
- Settling time < 60 ms
- **Evaluation:** equipment performed according to the requirement

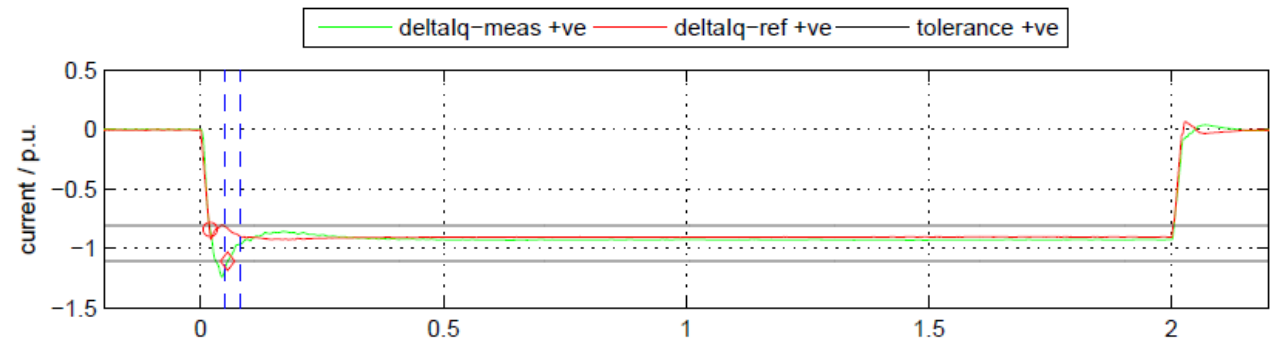
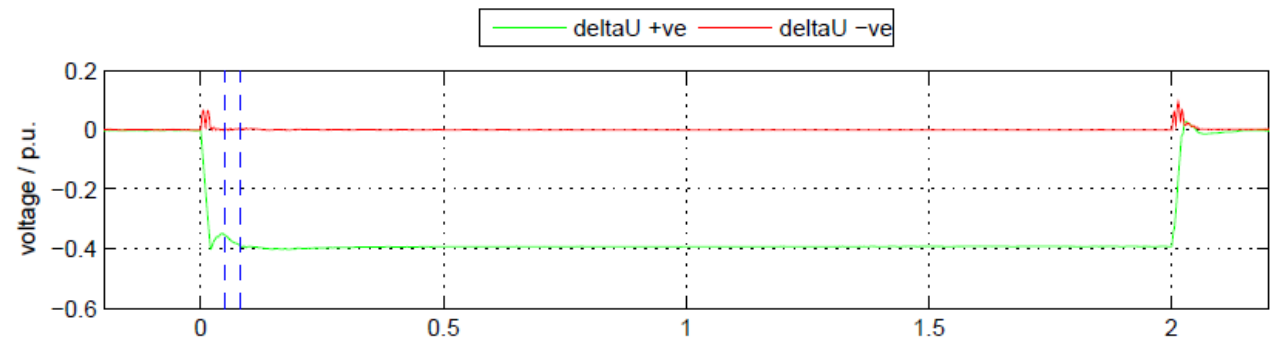

Three phase fault at partial load & configured voltage dip 0.47 pu.



# Performance evaluation (according to VDE AR-N 4120:20915)

- Additional reactive current during fault in proportion to change in voltage during fault (pos. and neg. sequence component for unbalanced fault)
- Rise time < 30 ms
- Settling time < 60 ms
- **Evaluation:** equipment performed according to the requirement

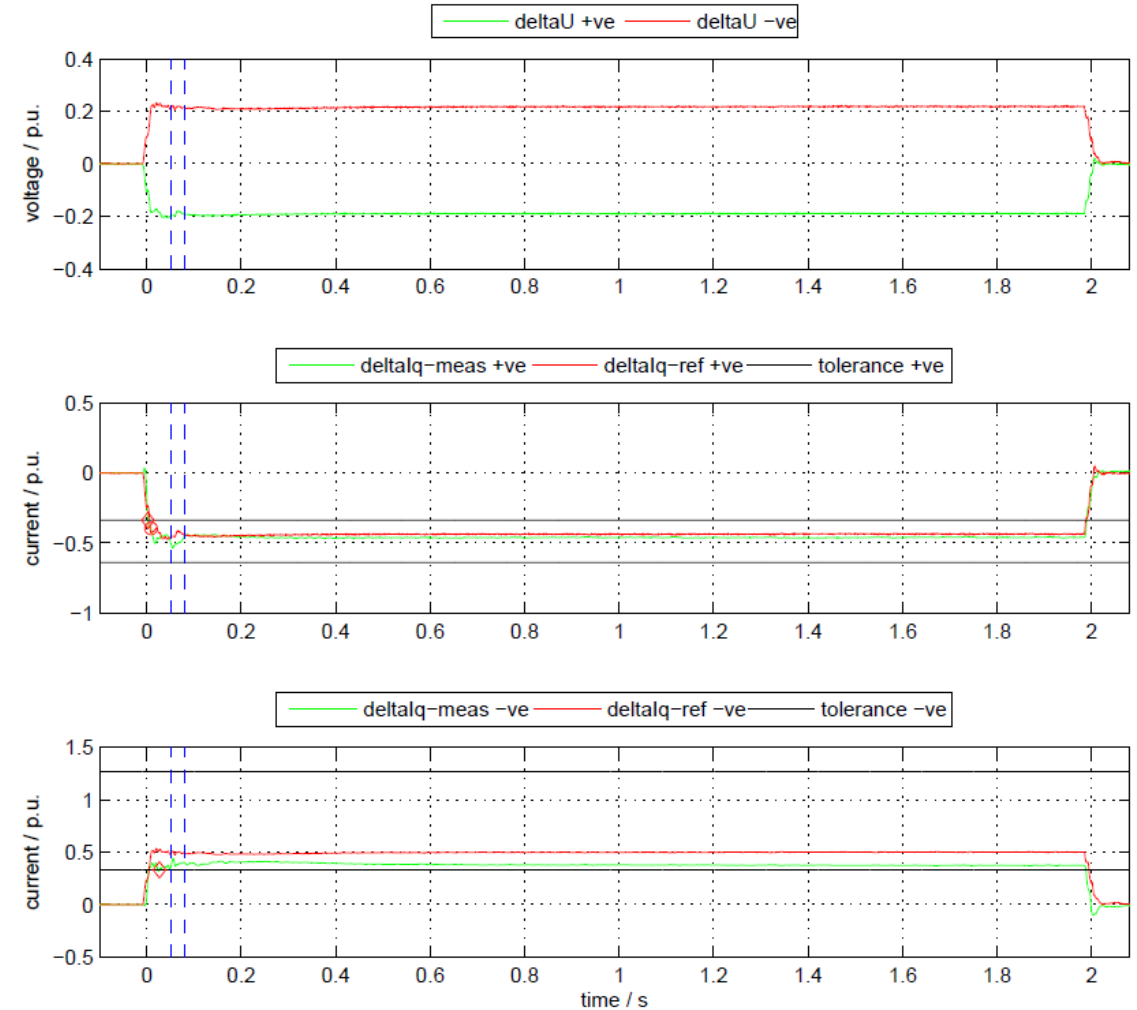

Phase-phase fault at partial load.





# Validation of Simulation Model

- IEC 61400-27-1 provides comprehensive validation plan.

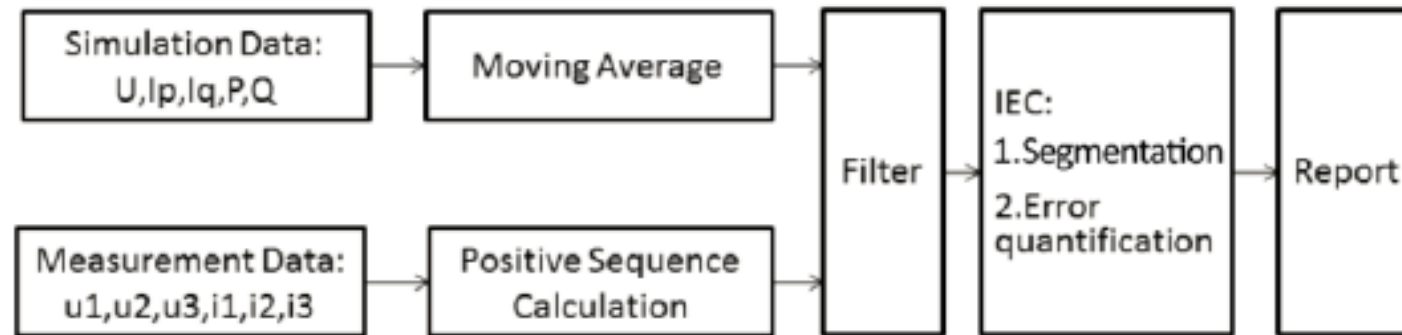

Model validation procedure according to IEC 61400-27-1



# Segmentation of waveform for validation

- For validation of simulation model, measured data are divided into three sections (pre-fault, during fault and post-fault)
- Time period immediately following fault application and fault clearing involves electromagnetic transient which cannot be captured in fundamental frequency model. These period are excluded from calculation of maximum error.

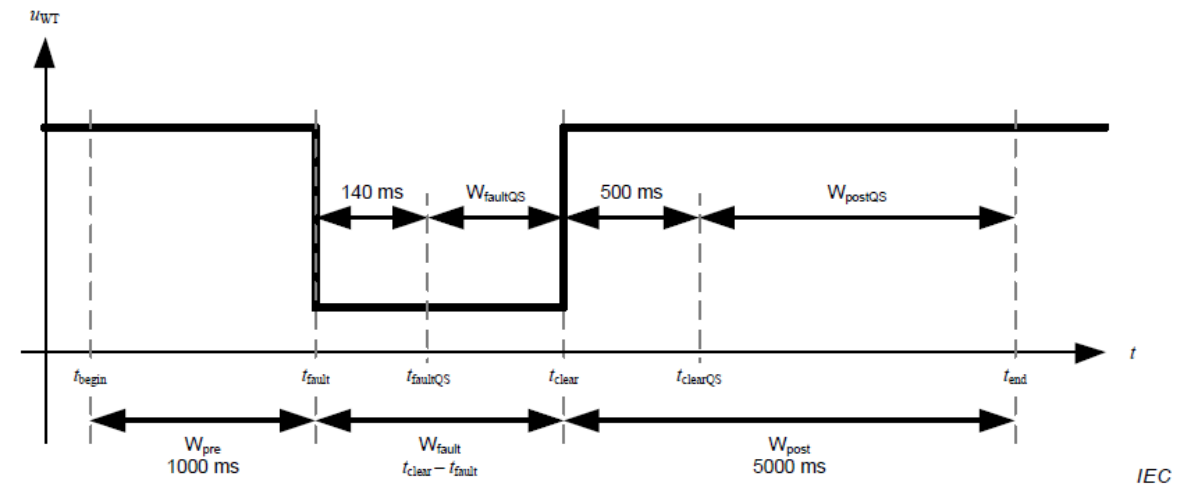

Segmentation of waveform according to IEC 61400-27-1



# Quantification of Error

- Quantification of error
  - maximum error (MXE)  
(evaluated for all segments except transient zone)
  - mean error (ME)  
(evaluated for all segments)
  - mean absolute error (MAE)  
(evaluated for all segments except transient zone after fault)
- Allowable threshold between simulation and measurement are specified by grid code (or specific guideline referenced by grid code).



# Allowable threshold based on requirement in Germany

Type 2 PGU		Positive phase sequence system											
		Real Power (P)			Reactive Power (Q)			Real Current (Iw)			Reactive Current (Ib)		
		MXE	ME	MAE	MXE	ME	MAE	MXE	ME	MAE	MXE	ME	MAE
Allowable threshold (3 ph fault)	Pre	0.150	±0.10	0.120	0.150	±0.1	0.120	0.150	±0.1	0.120	0.150	±0.1	0.120
	Fault	0.170	±0.15	0.170	0.170	±0.15	0.170	0.500	±0.3	0.400	0.170	±0.15	0.170
	Post	0.170	±0.15	0.170	0.170	±0.15	0.170	0.170	±0.15	0.170	0.170	±0.15	0.170
Allowable threshold (2 ph fault)	Pre	0.225	±0.15	0.180	0.225	±0.15	0.180	0.225	±0.15	0.180	0.225	±0.15	0.180
	Fault	0.255	±0.225	0.255	0.255	±0.225	0.255	0.750	±0.45	0.600	0.255	±0.225	0.255
	Post	0.255	±0.225	0.255	0.255	±0.225	0.255	0.255	±0.225	0.255	0.255	±0.225	0.255

Allowable threshold for positive phase sequence quantities



# Validation of simulation model

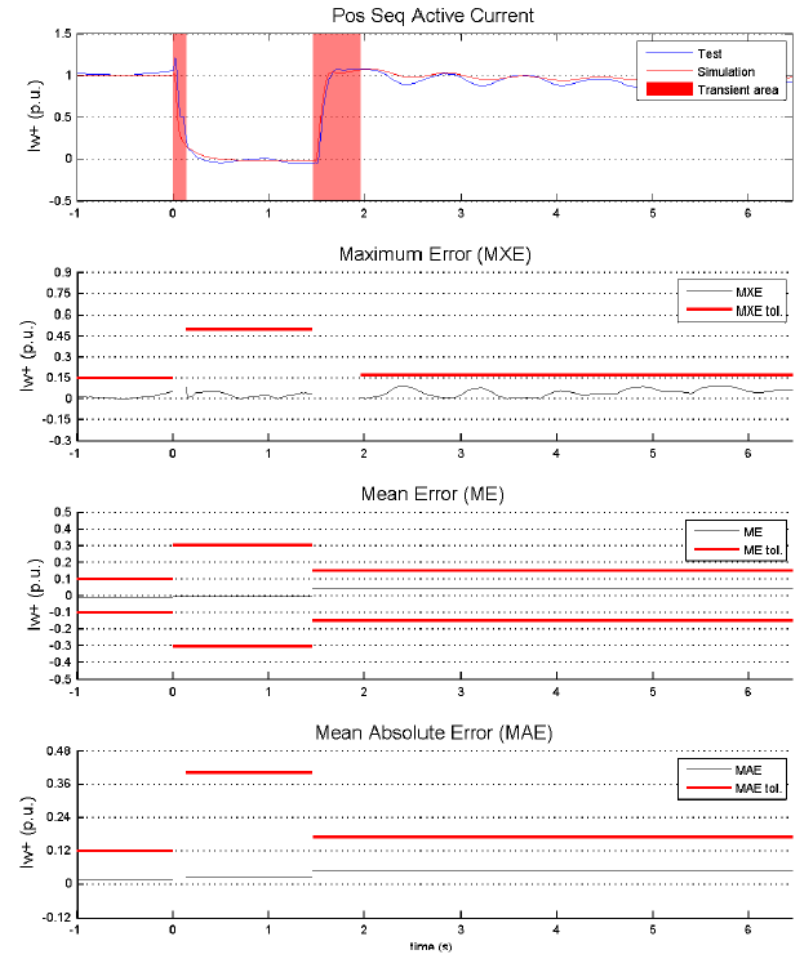
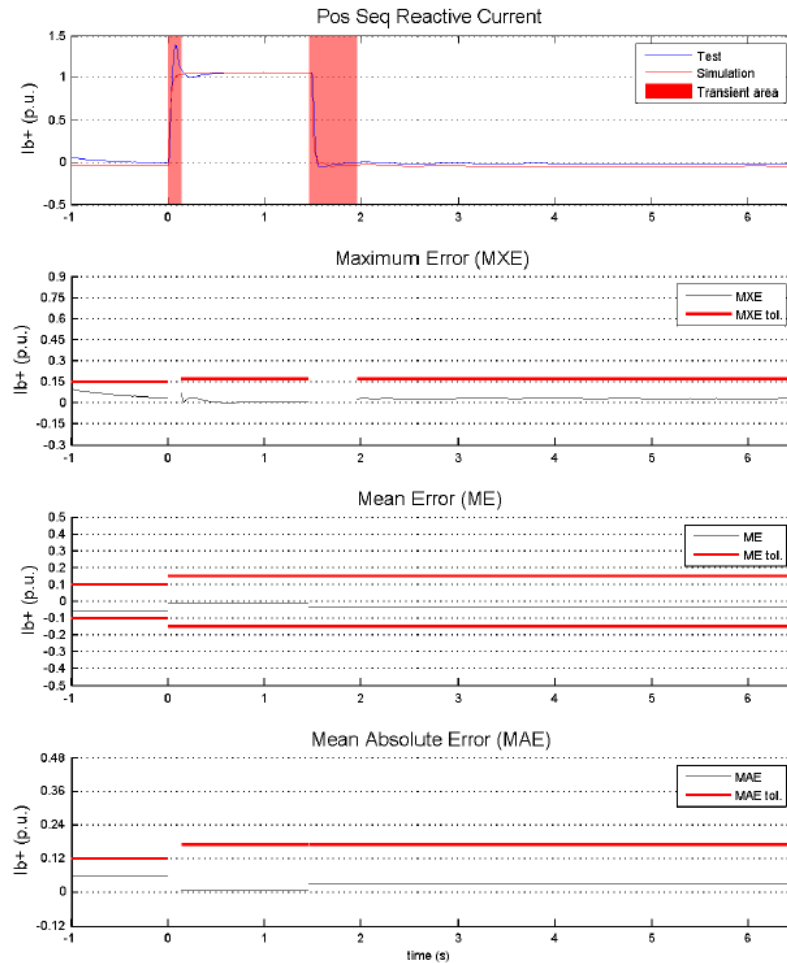

Performance of model with respect to measurement for a 30% voltage dip.



# Issues – CT Saturation

- Some initial test results in non-compliance
- Issue was not the equipment performance but source of data
- Measurement CT was saturated

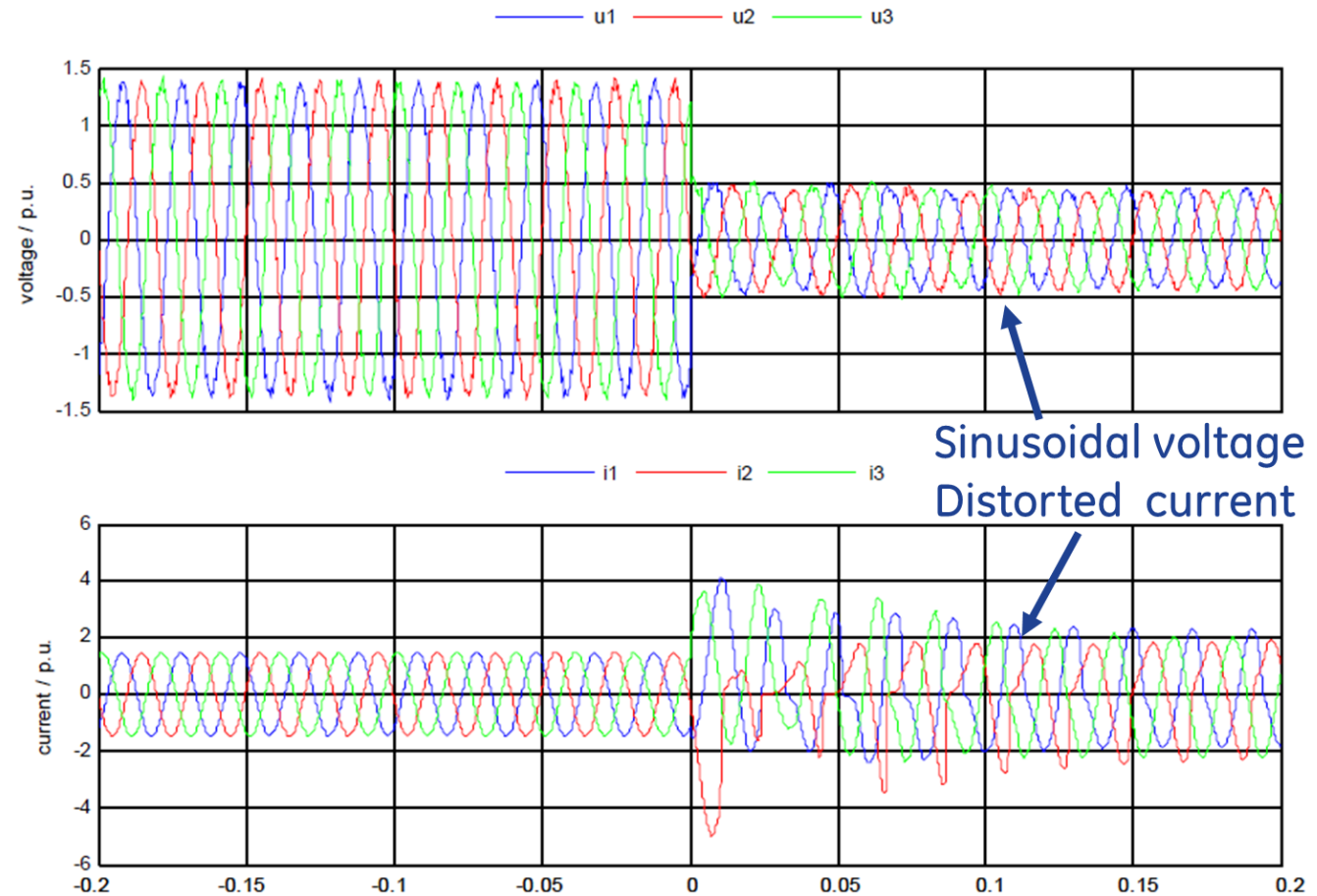

# Issues – CT Saturation

- Saturation in current measurement may lead to false assessment

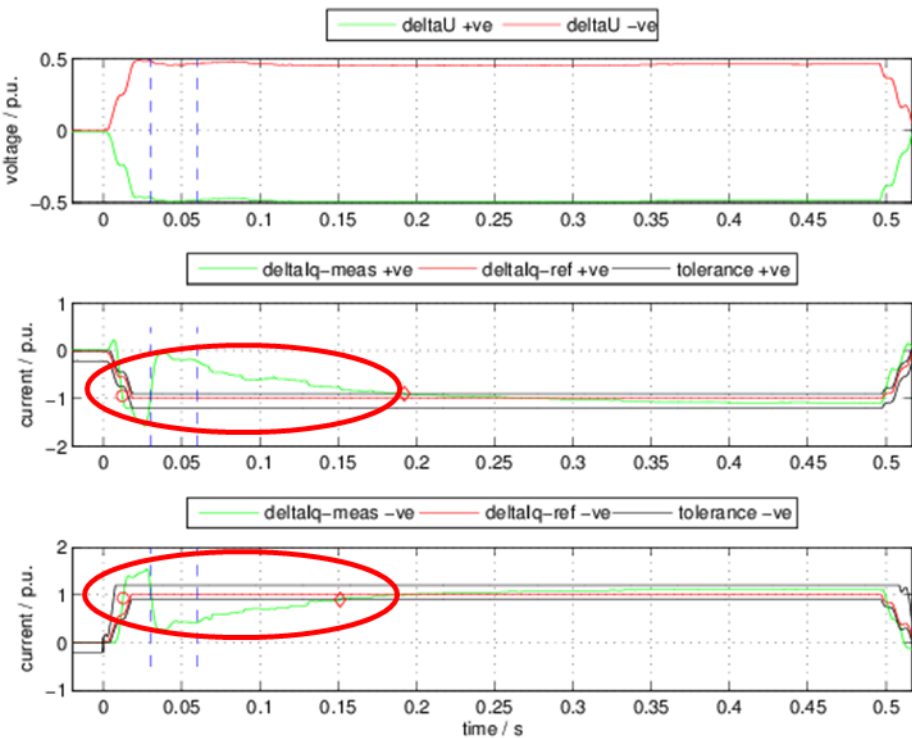

Evaluation of measured data from saturated CT

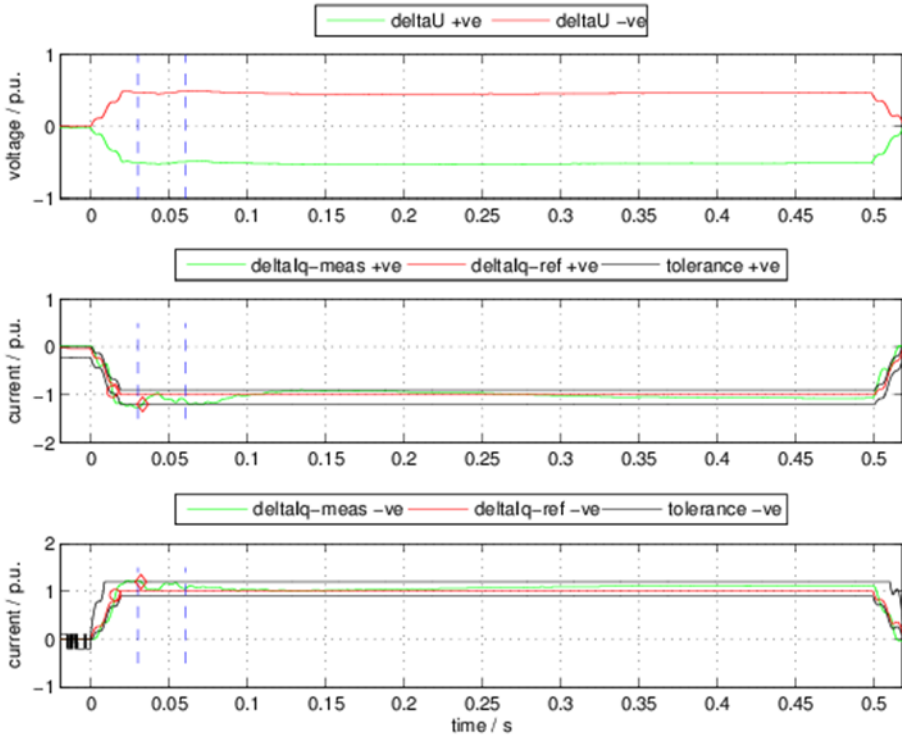

Evaluation of measured data from unsaturated CT



# Identifying CT Saturation

- Signature of saturation on measured fault current
- Integral of current will show flat-topped response if saturated.
- For delta connected system, non-zero sum of individual phase currents indicates saturation
- Figure shows comparison of saturated and unsaturated CT current

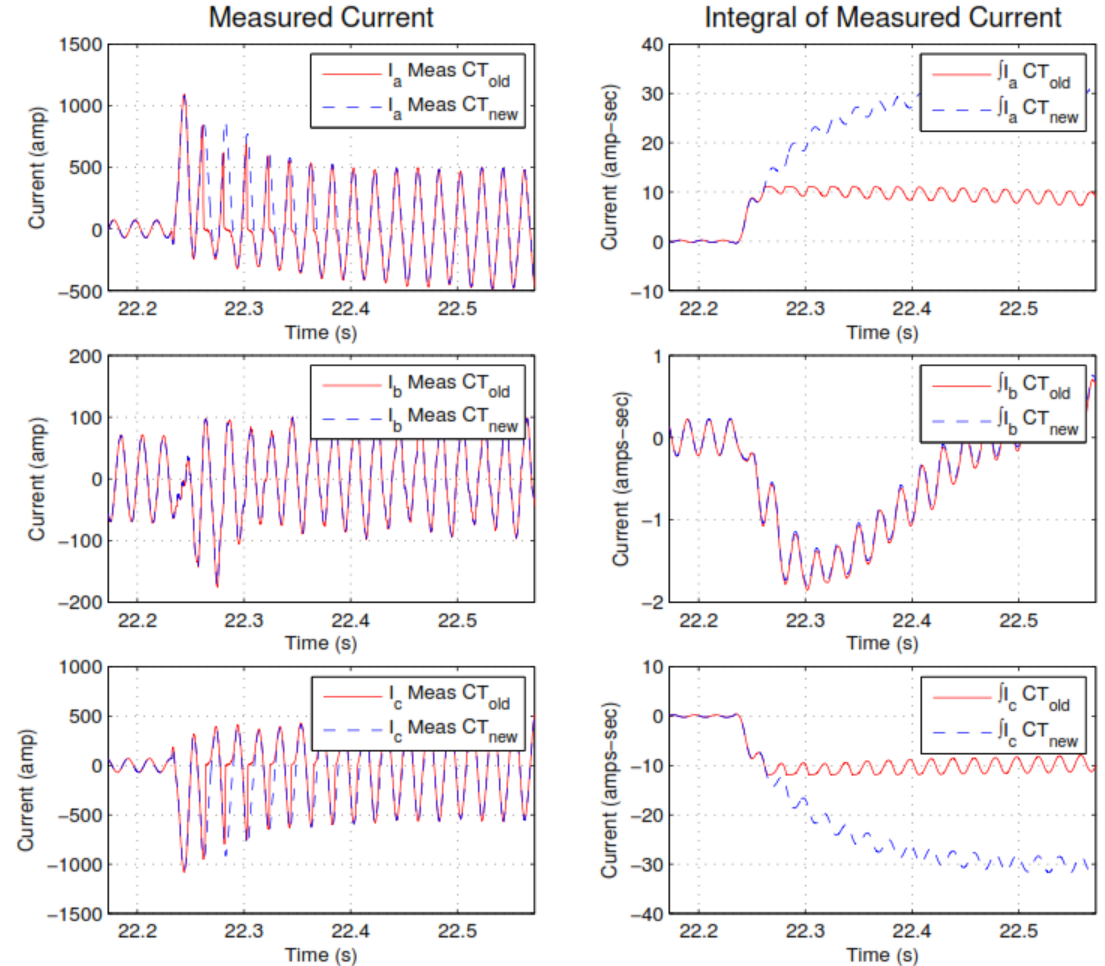



# Conclusion

- GE has been conducting extensive Fault-Ride-Through testing of wind turbines to meet and exceed the advanced grid code requirements.
- FRT testing has been done to satisfy the requirements in many countries including Germany, Spain, UK, Australia and China
- Data from the FRT test have been used to improve the performance of the stability models used for power system studies.
- Additionally complexity in the model have to included to closely represent the product in order to meet the validation requirement.



[acharyan@ge.com](mailto:acharyan@ge.com)

