

# GE MDS

# MDS iNET Series

*MDS iNET-II 900™*

*MDS iNET 900™*



## Wireless IP/Ethernet Transceiver

*iNET-II 900 Firmware Release 2.3*

*iNET 900 Firmware Release 6.3*

MDS 05-2806A01, Rev. H

NOVEMBER 2007



**GE MDS**  
industrial wireless networks

# QUICK-START INSTRUCTIONS

## INSTALLATION SUMMARY

### Step 1 – Mount the Transceiver

### Step 2 – Install the Antenna

### Step 3 – Measure & Connect Primary Power (10.5–30 Vdc)

### Step 4 – Review the Transceiver's Configuration

*Device Mode*—Access Point, or Remote (Default)

*Network Name*—Unique name for each radio network.

Required for Remotes to associate with Access Point.

*IP Address*—Must be a unique number to allow for IP access through the Ethernet Port.

NOTE: A unique IP address is essential to access the browser-based Management System.

*RF Output Power*—Adjust as necessary for regulatory compliance. (Default = 1 Watt /+30 dBm)

*Password*—Used for remote access and some Management System features. (Default = admin)

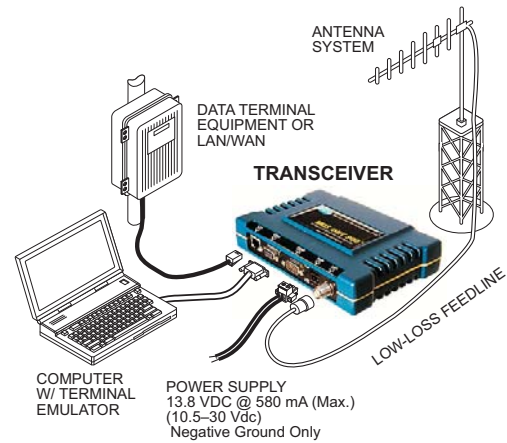
### Step 5 – Connect the Data Equipment

Connect the data equipment to data port(s):

- LAN—10BaseT Ethernet-compatible equipment:  
Ethernet Hub (Straight-Through Cable); Ethernet Node (Crossover)
- COM2—Serial, RS/EIA-232 compatible equipment
- COM1—Management System (Default); Serial (Alternate)

### Step 6 – Check for Normal Operation

- Observe the transceiver LED status panel for the proper indications. In a normally operating system, the following LED indications will be seen within 30 seconds of power-up:  
PWR—Lights continuously    LAN—On or blinks intermittently    LINK— On or blinks intermittently (Remotes: if associated)
- Use PING command to test basic data link integrity between Access Point and Remotes.
- If the PING command is successful, connect the RTU/data equipment to the data port and verify normal operation.
- If the LINK LED on Remotes is not on after 20 to 30 seconds, the unit has failed to associate with the Access Point. It may be necessary to reposition or redirect the radio's antenna for better reception/signal strength.
- Check connected data equipment for normal operation



## TYPICAL INSTALLATION

## BASIC CONFIGURATION DEFAULTS

The Management System can be accessed through the COM1 Port using a terminal emulator. The basic items listed below, and many other parameters and tools can be accessed through this tool. HTTP, Telnet access, and changing some parameters are controlled by password.

ITEM	MGT SYSTEM MENU	DEFAULT	VALUES/RANGE
Device Mode	Network Configuration	Remote	<ul style="list-style-type: none"> <li>• Remote</li> <li>• Access Point</li> </ul>
Unit Password	Device Information	admin (lower case)	<ul style="list-style-type: none"> <li>• 1–8 alphanumeric characters</li> <li>• Case-sensitive; can be mixed case</li> </ul>
Network Name	Network Configuration	"Not Programmed"	<ul style="list-style-type: none"> <li>• 1–16 alphanumeric characters</li> <li>• Case-sensitive; can be mixed case</li> </ul>
IP Address	Network Configuration	192.168.1.1	Contact your Network Administrator
RF Output Power	Radio Configuration	+30 dBm (1.0 Watt)	20–30 dBm @ 50Ω (0.1–1.0 Watt)

*Detailed instructions for setting transceiver parameters are contained in Section 3 of this manual.*

---

# TABLE OF CONTENTS

---

<b>1</b>	<b>PRODUCT OVERVIEW AND APPLICATIONS .....</b>	<b>1</b>
1.1	ABOUT THIS MANUAL.....	3
1.1.1	Related Publication .....	3
1.2	PRODUCT DESCRIPTION.....	3
1.2.1	Model Offerings .....	5
1.2.2	Differences Between iNET and iNET-II Models .....	6
1.2.3	GE MDS P21 Protected Network (Redundant) Configuration .....	6
1.3	APPLICATIONS .....	7
1.3.1	Wireless LAN .....	7
1.3.2	Point-to-Point LAN Extension .....	8
1.3.3	Backhaul for Serial Radio Networks .....	8
1.3.4	Multiple Protocols and/or Services .....	9
1.3.5	Wireless LAN with Mixed Services .....	10
1.3.6	Upgrading Older Wireless Network with Serial Interfaces .....	10
	Replacing Legacy Wireless Products .....	11
	Supplement legacy wireless network with IP services.....	11
1.3.7	High-Speed Mobile Data .....	11
1.4	NETWORK DESIGN CONSIDERATIONS.....	12
1.4.1	Extending Network Coverage with Repeaters .....	12
	What is a Repeater System? .....	12
	Option 1□Using two transceivers to form a repeater station (back-to-back repeater).....	12
	Option 2□Using the AP as a Store-and-Forward Packet Repeater .....	13
1.4.2	Protected Network Operation using Multiple Access Points .....	14
1.4.3	Collocating Multiple Radio Networks .....	14
	The Network Name and the association process .....	14
	Can radio frequency interference (RFI) disrupt my wireless network? .....	15
1.5	CYBER SECURITY .....	15
1.6	ACCESSORIES .....	17

## **2 EMBEDDED MANAGEMENT SYSTEM..... 19**

<b>2.1 INTRODUCTION .....</b>	<b>23</b>
2.1.1 Differences in the User Interfaces .....	23
<b>2.2 ACCESSING THE MENU SYSTEM .....</b>	<b>25</b>
2.2.1 Methods of Control .....	26
2.2.2 PC Connection & Log In Procedures .....	26
2.2.3 Navigating the Menus .....	31
Via Terminal Telnet or SSH Sessions	
Recommended for first-time log-in.....	31
Navigating via Web Browser.....	31
<b>2.3 BASIC DEVICE INFORMATION.....</b>	<b>32</b>
2.3.1 Starting Information Screen .....	32
2.3.2 Main Menu .....	34
2.3.3 Configuring Basic Device Parameters .....	35
Device Information.....	35
Device Names Menu.....	36
<b>2.4 CONFIGURING NETWORK PARAMETERS .....</b>	<b>37</b>
2.4.1 Network Configuration Menu .....	37
2.4.2 Network Interface Configuration Menu .....	39
Virtual LAN in iNET-II and iNET .....	40
Configuring for Operation with VLAN.....	41
Configuring the IP Address when VLAN Status is Enabled .....	42
Configuring the IP Address When VLAN Status is Disabled.....	43
2.4.3 Ethernet Port Configuration Menu .....	45
2.4.4 DHCP Server Configuration .....	46
2.4.5 SNMP Agent Configuration .....	47
2.4.6 Prioritized AP Configuration Submenu .....	49
<b>2.5 RADIO CONFIGURATION.....</b>	<b>51</b>
2.5.1 Radio Configuration Menu .....	51
2.5.2 Channel Config Menu .....	54
2.5.3 Skip Zones Menu .....	55
2.5.4 Auto Data Rate Configuration Menu .....	56
2.5.5 Mobility Configuration Menu .....	58
Additional Considerations for Mobile Operation.....	59
At Every Mobile (Remote) Radio .....	59
At Every AP Radio .....	60
<b>2.6 CONFIGURING THE SERIAL PORTS .....</b>	<b>60</b>
2.6.1 Overview .....	60
Com1 Port—Dual Purpose Capability .....	61

TCP vs. UDP .....	61
Serial Encapsulation .....	61
TCP Client vs. TCP Server .....	62
UDP Multicast .....	62
PPP .....	63
Data Buffering .....	63
Implementing Configuration Changes.....	63
Serial Configuration Wizard .....	63
2.6.2 Serial Data Port Configuration Menu .....	63
2.6.3 Configuring for UDP Mode .....	64
2.6.4 Configuring for TCP Mode .....	68
2.6.5 Configuring for PPP Mode .....	70
2.6.6 IP-to-Serial Application Example .....	71
2.6.7 Point-to-Multipoint IP-to-Serial Application Example .....	72
2.6.8 Point-to-Point Serial-to-Serial Application Example .....	74
2.6.9 Combined Serial and IP Application Example .....	75
Operation and Data Flow .....	75
2.6.10 Virtual LAN in iNET-II and iNET .....	77
Configuring for Operation with VLAN.....	78
<b>2.7 CYBER SECURITY CONFIGURATION .....</b>	<b>78</b>
2.7.1 Device Security .....	79
2.7.2 Wireless Security .....	80
Local Authentication <input type="checkbox"/> Approved Remotes/Access Points List Submenu.....	81
2.7.3 RADIUS Configuration .....	82
Operation of Device Authentication.....	83
Operation of User Authentication .....	83
2.7.4 RADIUS Configuration .....	84
2.7.5 Certificate Management (Remote transceivers only) .....	84
<b>2.8 PERFORMANCE VERIFICATION .....</b>	<b>85</b>
2.8.1 RSSI by Zone Menu (Remotes Only) .....	87
2.8.2 Event Log Menu .....	88
Time and Date.....	88
View Current Alarms .....	90
View Event Log .....	91
2.8.3 Packet Menu .....	91
Wireless Packet Statistics.....	91
Ethernet Packet Statistics .....	92
Packets Received by Zone .....	93
2.8.4 Wireless Network Status (Remotes Only) .....	94
The Transceiver <input type="checkbox"/> s Association Process .....	94
The Wireless Network Status Screen (Remotes Only).....	95
2.8.5 Remote Listing Menu (Access Points Only) .....	96
2.8.6 Endpoint Listing Menu (Access Points Only) .....	97
2.8.7 Remote Performance Listing Menu (Access Points Only) .....	98

2.8.8 Serial Data Statistics Menu .....	99
<b>2.9 MAINTENANCE.....</b>	<b>99</b>
2.9.1 Reprogramming Menu .....	100
Upgrading the Firmware .....	102
Error Messages During File Transfers .....	104
2.9.2 Configuration Scripts Menu .....	105
How Configuration Files Work .....	105
Sample of Configuration Script File .....	106
Editing Configuration Files .....	107
2.9.3 Authorization Keys Menu .....	108
2.9.4 Change the Type of Remote .....	108
2.9.5 Auto-Upgrade/Remote-Reboot Menu .....	108
Firmware Upgrade (with AP Acting as a TFTP Server).....	109
2.9.6 Radio Test Menu .....	110
2.9.7 Ping Utility Menu .....	111
2.9.8 Reset to Factory Defaults .....	111
Password Reset.....	111

### **3 TROUBLESHOOTING..... 113**

3.1 Interpreting the Front Panel LEDs .....	115
3.2 Troubleshooting Using the Embedded Management System.....	116
3.2.1 Starting Information Screen .....	117
3.2.2 Packet Statistics Menu .....	118
3.2.3 Serial Port Statistics Menu .....	119
3.2.4 Diagnostic Tools .....	119
3.3 Using Logged Operation Events.....	119
3.4 Alarm Conditions.....	120
3.5 Correcting Alarm Conditions .....	121
3.6 Logged Events .....	123

## **4 PLANNING A RADIO NETWORK..... 127**

### **4.1 INSTALLATION PLANNING ..... 129**

4.1.1 General Requirements .....	129
DIN Rail Mounting Option .....	131
4.1.2 Site Selection .....	131
4.1.3 Terrain and Signal Strength .....	132
4.1.4 Antenna & Feedline Selection .....	132
4.1.5 How Much Output Power Can be Used? .....	135
4.1.6 Conducting a Site Survey .....	136
4.1.7 A Word About Radio Interference .....	136
4.1.8 Notes on Using 28 VDC Power Supplies .....	138

### **4.2 RADIO (RF) MEASUREMENTS ..... 139**

4.2.1 Antenna System SWR and Transmitter Power Output .....	140
Introduction .....	140
Procedure .....	140
4.2.2 Antenna Aiming .....	141
Introduction .....	141
Procedure .....	141

### **4.3 dBm-WATTS-VOLTS CONVERSION CHART ..... 143**

### **4.4 PERFORMANCE NOTES..... 144**

4.4.1 Wireless Bridge .....	144
4.4.2 Distance-Throughput Relationship .....	144
4.4.3 Data Latency □ TCP versus UDP Mode .....	145
4.4.4 Data Compression .....	145
4.4.5 Packets-per-Second (PPS) .....	145
4.4.6 Station-to-Station Traffic .....	145
4.4.7 Interference has a Direct Correlation to Throughput .....	145
4.4.8 Maximizing Throughput .....	146
4.4.9 Placing an iNET Radio Behind a Firewall .....	147

### **4.5 SNMPv3 NOTES ..... 147**

4.5.1 Overview .....	147
SNMPv3 Accounts .....	148
Context Names .....	148
Password-Mode Management Changes.....	149

## **5 TECHNICAL REFERENCE..... 153**

### **5.1 DATA INTERFACE CONNECTORS ..... 155**

5.1.1 LAN Port .....	155
5.1.2 COM1 Port .....	156

5.1.3 COM2 Port .....	156
5.2 FUSE REPLACEMENT PROCEDURE .....	157
5.3 TECHNICAL SPECIFICATIONS .....	158
5.4 CHANNEL HOP TABLE .....	161

## **6 GLOSSARY OF TERMS AND ABBREVIATIONS... 165**

### **Copyright Notice**

This publication is protected by U.S.A. copyright law. Copyright 2007, GE MDS. All rights reserved.

### **ISO 9001 Registration**

GE MDS adheres to this internationally-accepted ISO 9001 quality system standard.

### **To our Customers**

We appreciate your patronage. You are our business. We promise to serve and anticipate your needs. We will strive to give you solutions that are cost effective, innovative, reliable and of the highest quality possible. We promise to build a relationship that is forthright and ethical, one that builds confidence and trust.

### **Products Covered in this Manual**

This manual covers two members of the GE MDS iNET Transceiver Series, both of which are designed to be operated under the FCC's Part 15 license-free rules. The iNET radio is a Frequency Hopping Spread Spectrum (FHSS) transceiver that operates at data speeds of 256 and 512 kbps.

The iNET-II is a similar design, but it is certified under the Digital Transmission System (DTS) provisions of FCC Part 15 and can operate at data speeds of 512 or 1024 kbps. Operational differences between these two models are identified, as necessary, in this manual.

---

**NOTE:** GE MDS iNET and GE MDS iNET-II transceivers are *not* over-the-air compatible.

---

### **Other GE MDS iNET 900 Series Documentation**

**Startup Guide** □ The associated GE MDS iNET 900 Series Startup Guide, P/N 05-2873A01, is provided with the transceiver and is limited to essential information needed for installers. The installation guide assumes some guidance to installers will be provided by the readers of this manual. This includes such things as antenna selection, radio communication site survey tools and techniques, and network design.

**Related Materials on the Internet** □ Data sheets, frequently asked questions, case studies, application notes, firmware upgrades and other updated information is available on the GE MDS Web site at [www.GEmds.com](http://www.GEmds.com).



## About GE MDS

Almost two decades ago, GE MDS began building radios for business-critical applications. Since then, we've installed nearly 100,000,000 radios in over 110 countries. To succeed, we overcame impassable terrain, brutal operating conditions and disparate, complex network configurations. We also became experts in wireless communication standards and system applications worldwide. The result of our efforts is that today, thousands of utilities around the world rely on GE MDS-based wireless networks to manage their most critical assets.

The majority of GE MDS radios deployed since 1985 are still installed and performing within our customers' wireless networks. That's because we design and manufacture our products in-house, according to ISO 9001 which allows us to control and meet stringent global quality standards.

Thanks to our durable products and comprehensive solutions, GE MDS is the wireless leader in industrial automation—including oil and gas production and transportation, water/wastewater treatment, supply and transportation, electric transmission and distribution and many other utility applications. GE MDS is also at the forefront of wireless communications for private and public infrastructure and online transaction processing. Now is an exciting time for GE MDS and our customers as we look forward to further demonstrating our abilities in new and emerging markets.

As your wireless needs change you can continue to expect more from GE MDS. We'll always put the performance of your network above all. Visit us at [www.GEmds.com](http://www.GEmds.com) for more information.

## OPERATIONAL & SAFETY NOTICES

### RF Exposure



Professional installation required. The radio equipment described in this guide emits radio frequency energy. Although the power level is low, the concentrated energy from a directional antenna may pose a health hazard. Do not allow people to come closer than 23 cm (9 inches) to the antenna when the transmitter is operating in indoor or outdoor environments. More information on RF exposure is on the Internet at [www.fcc.gov/oet/info/documents/bulletins](http://www.fcc.gov/oet/info/documents/bulletins).

### UL/CSA Notice

This product is available for use in Class 1, Division 2, Groups A, B, C & D Hazardous Locations. Such locations are defined in Article 500 of the National Fire Protection Association (NFPA) publication *NFPA 70*, otherwise known as the National Electrical Code.

The transceiver has been recognized for use in these hazardous locations by two independent agencies—Underwriters Laboratories (UL) and the Canadian Standards Association (CSA). The UL certification for the transceiver is as a Recognized Component for use in these hazardous locations, in accordance with UL Standard 1604. The CSA Certification is in accordance with CSA STD C22.2 No. 213-M1987.

**UL/CSA Conditions of Approval:** The transceiver is not acceptable as a stand-alone unit for use in the hazardous locations described above. It must either be mounted within another piece of equipment which is certified for hazardous locations, or installed within guidelines, or conditions of approval, as set forth by the approving agencies. These conditions of approval are as follows:

The transceiver must be mounted within a separate enclosure which is suitable for the intended application.

The antenna feedline, DC power cable and interface cable must be routed through conduit in accordance with the National Electrical Code.

Installation, operation and maintenance of the transceiver should be in accordance with the transceiver's installation manual, and the National Electrical Code. (*UL/CSA Notice continued on next page...*)

Tampering or replacement with non-factory components may adversely affect the safe use of the transceiver in hazardous locations, and may void the approval.

A power connector with screw-type retaining screws as supplied by GE MDS must be used.



Do not disconnect equipment unless power has been switched off or the area is known to be non-hazardous.

Refer to Articles 500 through 502 of the National Electrical Code (NFPA 70) for further information on hazardous locations and approved Division 2 wiring methods.

## FCC Part 15 Notices

The transceiver series complies with Part 15 of the FCC Rules. Operation is subject to the following two conditions: (1) this device may not cause harmful interference, and (2) this device must accept any interference received, including interference that may cause undesired operation. This device is specifically designed to be used under Section 15.247 of the FCC Rules and Regulations. Any unauthorized modification or changes to this device without the express approval of Microwave Data Systems may void the user's authority to operate this device. Furthermore, the iNET Series is intended to be used only when installed in accordance with the instructions outlined in this manual. Failure to comply with these instructions may also void the user's authority to operate this device.

Part 15 rules also require that the Effective Isotropic Radiated Power (EIRP) from an GE MDS iNET Series installation not exceed 36 dBm. Refer to *Antenna & Feedline Selection on Page 132* for more information.

## Industry Canada RSS Notices

Operation is subject to the following two conditions: (1) this device may not cause interference, and (2) this device must accept any interference, including interference that may cause undesired operation of the device.

To reduce potential radio interference to other users, the antenna type and its gain should be chosen so that the Equivalent Isotropic Radiated Power (EIRP) is not more than that permitted for successful communication.

This device has been designed to operate with the antennas listed below, and having a maximum gain of 12 dB. Antennas not included in this list or having a gain greater than 12 dB are strictly prohibited for use with this device. The required antenna impedance is 50 ohms. Refer to *Table 4-3 on Page 138* for a list of antennas acceptable for use with this transceiver.

## Manual Revision and Accuracy

This manual was prepared to cover a specific version of firmware code. Accordingly, some screens and features may differ from the actual unit you are working with. While every reasonable effort has been made to ensure the accuracy of this publication, product improvements may also result in minor differences between the manual and the product shipped to you. If you have additional questions or need an exact specification for a product, please contact our Customer Service Team using the information at the back of this guide. In addition, manual updates can often be found on the GE MDS Web site at [www.GEmds.com](http://www.GEmds.com).

## Environmental Information



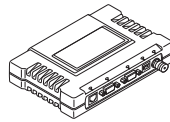
The manufacture of this equipment has required the extraction and use of natural resources. Improper disposal may contaminate the environment and present a health risk due to hazardous substances contained within. To avoid dissemination of these substances into our environment, and to limit the demand on natural resources, we encourage you to use the appropriate recycling systems for disposal. These systems will reuse or recycle most of the materials found in this equipment in a sound way. Please contact GE MDS or your supplier for more information on the proper disposal of this equipment.



# 1 **PRODUCT OVERVIEW AND APPLICATIONS**

## **Contents**

<b>1.1</b>	<b>ABOUT THIS MANUAL</b> .....	<b>3</b>
1.1.1	Related Publication .....	3
<b>1.2</b>	<b>PRODUCT DESCRIPTION</b> .....	<b>3</b>
1.2.1	Model Offerings .....	5
1.2.2	Differences Between iNET and iNET-II Models .....	6
1.2.3	GE MDS P21 Protected Network (Redundant) Configuration .....	6
<b>1.3</b>	<b>APPLICATIONS</b> .....	<b>7</b>
1.3.1	Wireless LAN .....	7
1.3.2	Point-to-Point LAN Extension .....	8
1.3.3	Backhaul for Serial Radio Networks .....	8
1.3.4	Multiple Protocols and/or Services .....	9
1.3.5	Wireless LAN with Mixed Services .....	10
1.3.6	Upgrading Older Wireless Network with Serial Interfaces .....	10
	Replacing Legacy Wireless Products .....	11
	Supplement legacy wireless network with IP services .....	11
1.3.7	High-Speed Mobile Data .....	11
<b>1.4</b>	<b>NETWORK DESIGN CONSIDERATIONS</b> .....	<b>12</b>
1.4.1	Extending Network Coverage with Repeaters .....	12
	What is a Repeater System? .....	12
	Option 1 □ Using two transceivers to form a repeater station (back-to-back repeater) .....	12
	Option 2 □ Using the AP as a Store-and-Forward Packet Repeater .....	13
1.4.2	Protected Network Operation using Multiple Access Points .....	14
1.4.3	Collocating Multiple Radio Networks .....	14
	The Network Name and the association process .....	14
	Can radio frequency interference (RFI) disrupt my wireless network? .....	15
<b>1.5</b>	<b>CYBER SECURITY</b> .....	<b>15</b>
<b>1.6</b>	<b>ACCESSORIES</b> .....	<b>17</b>



## 1.1 ABOUT THIS MANUAL

This Reference Manual is designed for use by professional installers and technicians. It contains an in-depth description of the product, including installation, configuration, and troubleshooting details.

### 1.1.1 Related Publication

A companion publication, the *GE MDS iNET Series Start-Up Guide* is also available (Part No. 05-2873A01). This smaller guide contains the essential information for installing the radio and placing it into operation. This guide is recommended for those primarily involved in the installation and setup of the product.

## 1.2 PRODUCT DESCRIPTION

The GE MDS iNET 900 transceiver (Figure 1-1) provides an easy-to-install wireless local area network (WLAN) service with long range and secure operation. It supports both Ethernet *and* serial data interface options at over-the-air data speeds of up to 1 Mbps (iNET-II) and 512 kbps (iNET).

---

**NOTE:** For information on the GE MDS iNET 900 ENI, which provides expanded gateway and protocol conversion capabilities not found in the GE MDS iNET 900 (DF1 to EIP, and MODBUS to MODBUS TCP conversions), refer to the *GE MDS iNET/ENI Supplement* (05-4131A01).

---



Figure 1-1. The GE MDS iNET 900 Transceiver

### ***Rugged Packaging***

The transceiver is housed in a compact and rugged cast-metal case that need only be protected from direct exposure to the weather. It contains a single printed circuit board with all necessary components for radio operation and data communications. The only user-serviceable component in the case is a fuse on the DC power input line.

### ***Simple Installation***

Most installations employ an omni-directional antenna at the Access Point (AP) location and a directional antenna at each Remote unit. The antenna is a vital link in the system and must be chosen and installed

correctly. See “INSTALLATION PLANNING” on Page 129 for guidance on choosing suitable installation sites and antennas.

For basic services, simply connect an antenna, connect your Ethernet LAN to the transceiver’s LAN port, apply primary power, set a few operating parameters, and you are done. No license is required for operation in the U.S.A., Canada, and many other countries. Check requirements for your region before placing the transceiver in service.

### ***Secure Operation***

Data network security is a vital issue in today's wireless world. GE MDS iNET Series radios provide multiple tools to help you build a network that minimizes the risk of eavesdropping and unauthorized access. Some are inherent in the radio's operation, such as the use of 900 MHz spread-spectrum transmissions; others include data encryption, enabling/disabling remote access channels, and password protection.

Remember, security is not a one-step process that can simply be turned on and forgotten. It must be practiced and enforced at multiple levels, 24 hours-a-day and 7 days-a-week. See “CYBER SECURITY” on Page 15 for more information about the transceiver’s security tools.

### ***Robust Radio Operation***

The transceiver is designed for frequency-hopping spread-spectrum operation in the license-free 900 MHz Industrial, Scientific, and Medical (ISM) band. It can provide reliable communications at distances up to 25 miles (40 km) over favorable terrain, even in the presence of weak signals or interference. Frequency hopping allows the transceiver to avoid interference from other transmitters in the same band, and provides frequency diversity for more reliable transmission. The over-the-air MAC increases reliability by adding retries to failed messages.

The iNET-II transceiver, which is certified to operate under DTS rules (hopping not required), also hops in order to achieve the same benefits that are realized with the iNET transceiver which is certified under FHSS rules.

### ***Flexible Services***

Users with a mixture of equipment having Ethernet and serial data interfaces can choose to use one or two of the user-configurable serial ports through the use of a Remote Dual Gateway. This flexibility allows the transceiver to provide services in data networks that are being migrated from legacy serial/EIA-232-based hardware to the faster and more easily interfaced Ethernet world.

### ***Flexible Management***

Configuration, commissioning, troubleshooting and other maintenance activities can be done locally or remotely. Four different modes of access are available: local RS-232 console, local or remote Internet Protocol (IP) access via Telnet or SSH, web browser (HTTP, HTTPS), and SNMP (v1/v2/v3). The text-based interface (RS-232 console Telnet and SSH) is implemented in the form of easy-to-follow menus, and the terminal server configuration includes a wizard to help you set up the units correctly.

## **Transceiver Features**

The transceiver's design makes the installation and configuration easy, while allowing for changes in the future.

- Long Range—Up to 30 miles (48 km) nominal range in line-of-sight conditions. Repeater stations may be used to extend the operational range. (Refer to TECHNICAL SPECIFICATIONS on Page 156 for more detailed information on range.)
- Industrial-Grade Product—Extended temperature range for trouble-free operation in extreme environments
- Robust Radio Communications—Designed to operate in dense, high-interference environments
- Robust Network Security—Prevents common attack schemes and hardware from gaining access or control of network. Common attack events logged and reported by alarms.
- High Speed—1 Mbps (iNET-II) is 100-times faster than 9.6 kbps radios. GE MDS iNET transceiver speed is 512 kbps.
- Plug-and-Play Connectivity—Ethernet bridge configuration option requires minimal setup
- Serial Ports—Gateway for serial-based equipment to IP/Ethernet networks with embedded terminal server. Site-to-site configurations are also possible.
- Single hardware package provides configuration as Access Point or Remote

### **1.2.1 Model Offerings**

The transceiver comes in two primary models—Access Point and Remote. Three types of Remote Gateways are available—the Ethernet Bridge, the Serial Gateway, and the Dual Gateway supporting both IP/Ethernet and serial services. Table 1-1 summarizes the different interface abilities for each type.

A unit can be configured by the owner to operate as an Access Point or as a Remote with some restrictions. Only the Dual Gateway Remote units can be reconfigured as an Access Point. Ethernet Bridge and a Serial Gateway Remotes cannot be reconfigured as an Access Point unless they are first upgraded to Dual Gateway type. This is accomplished with an “Authorization Key” purchased from the factory. Each one of these individual software keys is associated with the serial number of the corresponding unit.

**Table 1-1. Transceiver Models and Data Interface Services**

Model	Type	LAN <sup>1</sup>	COM1 <sup>1</sup>	COM2
Access Point <sup>3</sup>	N/A	Yes	Yes	Yes
Remote...	Ethernet Bridge <sup>2</sup>	Yes	No	No
	Serial Gateway <sup>2</sup>	No	Yes	Yes
	Dual Gateway <sup>3</sup>	Yes	Yes	Yes

**NOTES**

1. Provides access to the embedded Management System on all units.
2. Can be upgraded to Dual Gateway with an Authorization Key.
3. Can be configured as an Access Point or Dual Gateway through the embedded Management System.

### 1.2.2 Differences Between iNET and iNET-II Models

The iNET and iNET-II Transceivers, while similar in many respects, do have some important differences. The main differences are summarized in Table 1-2:

**Table 1-2. Transceiver Differences (iNET vs. iNET-II)**

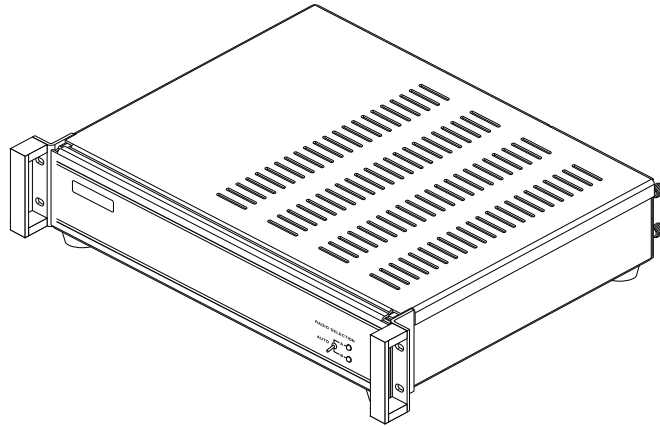
Characteristic	iNET	iNET-II
Data Rate	256/512 kbps	512 kbps/1 Mbps
FCC Certification Type	FHSS	DTS
Encryption	RC4-128	AES-128
Channel size	316.5 kHz	600 kHz
Channel operation	Zones	Channels
Firmware	Specific for iNET	Specific for iNET-II

**NOTE:** The GE MDS iNET and GE MDS iNET-II transceivers are *not* over-the-air compatible.

### 1.2.3 GE MDS P21 Protected Network (Redundant) Configuration

For mission-critical applications, GE MDS also offers the Protected Network Station. This radio incorporates two iNET Series transceivers, two power supplies, and a switchover logic board that automatically selects between Transceiver A and Transceiver B as the active radio. Figure 1-2 shows a view of the protected chassis. For system-level information on this product, see GE MDS publication 05-4161A01.





**Figure 1-2. GE MDS P21 Protected Network Station**  
*(incorporates two Transceivers, with Automatic Switchover)*

## 1.3 APPLICATIONS

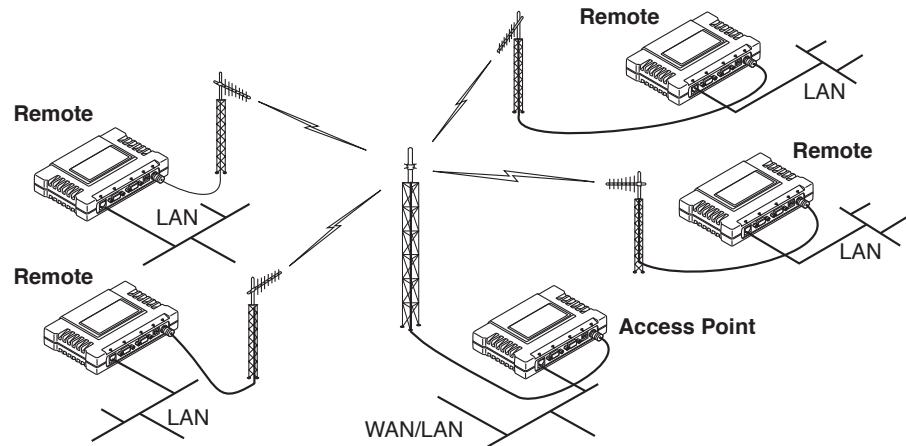
The following sections provide illustrations of typical transceiver installations. This is meant as an overview only. It is recommended that a network manager be involved in all installation planning activities.

### 1.3.1 Wireless LAN

The wireless LAN is the most common application of the transceiver. It consists of a central control station (Access Point) and one or more associated Remote units, as shown in Figure 1-3 on Page 8. A LAN provides communications between a central WAN/LAN and remote Ethernet segments. The operation of the radio system is transparent to the computer equipment connected to the transceiver.

The Access Point is positioned at a location from which it can communicate with all of the Remote units in the system. Commonly, this is a high location on top of a building or communications tower. Messages are exchanged at the Ethernet level. This includes all types of IP traffic.

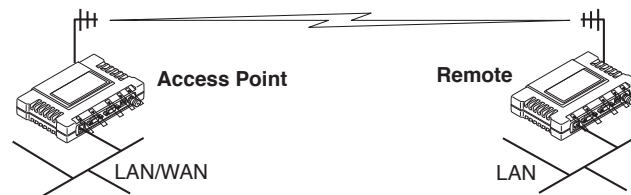
A Remote transceiver can only talk over-the-air to an Access Point unit (AP). Peer-to-peer communications between Remotes can only take place indirectly via the AP. In the same fashion, an AP can only talk over-the-air to associated Remote units. Exception: Two APs can communicate with each other “off-the-air” through their Ethernet connectors using a common LAN/WAN.



**Figure 1-3. Typical Wireless LAN**

### 1.3.2 Point-to-Point LAN Extension

A point-to-point configuration (Figure 1-4) is a simple arrangement consisting of an Access Point and a Remote unit. This provides a communications link for the transfer of data between two locations.

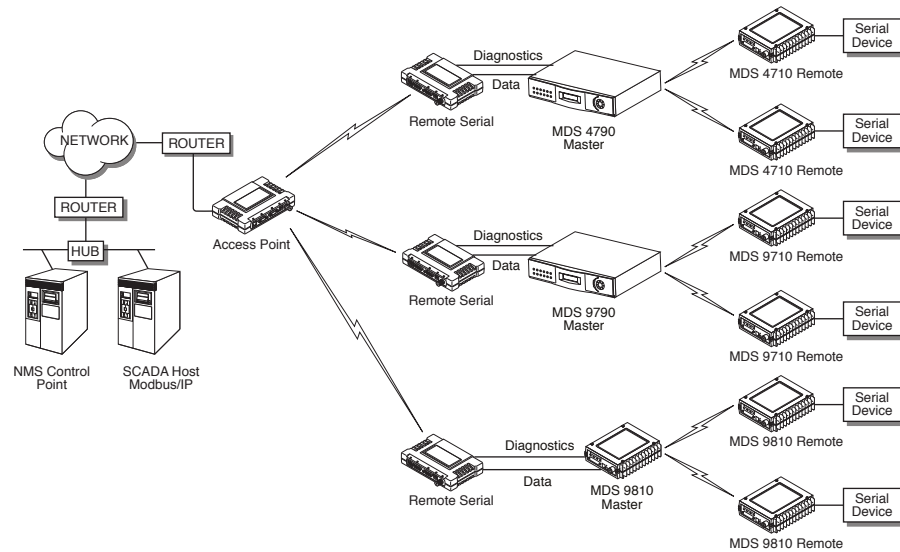


**Figure 1-4. Typical Point-to-Point Link**

### 1.3.3 Backhaul for Serial Radio Networks

One of the primary design features of the transceiver is to provide a path for serial devices to migrate to IP/Ethernet. Many radio networks in operation today still rely on serial networks at data rates of 9600 bps or less. These networks can use the transceiver as a means to continue using the serial service, while allowing the rest of the infrastructure to migrate to an IP format.

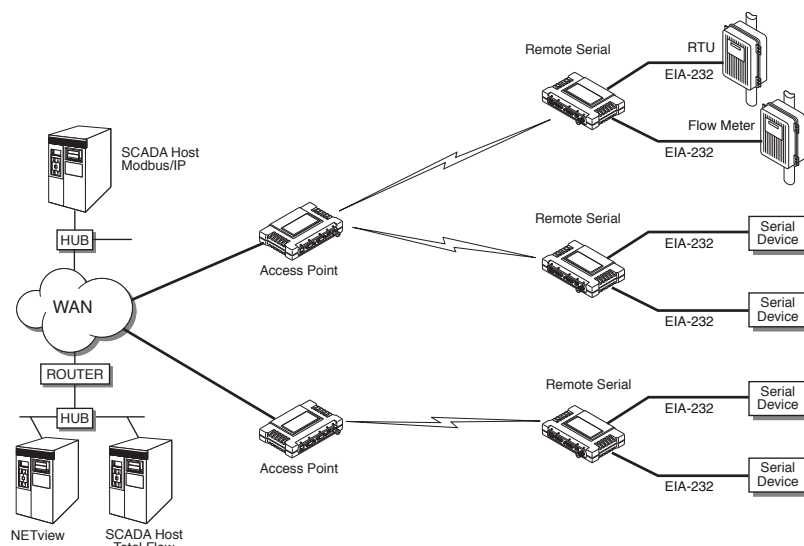
A Remote transceiver using one serial port for the data stream, and the other for network-wide diagnostics can support operational radio networks built with GE MDS serial-based radios, such as GE MDS x790/x710, GE MDS TransNET and others. In the case of radios using a single port for data and diagnostics, the capabilities are doubled. The data streams are delivered to an IP socket in an application, or in serial format using the Access Point.



**Figure 1-5. Backhaul Network**

### 1.3.4 Multiple Protocols and/or Services

Prior to the iNET Series, two radios were often used to service two different types of devices (typically connected to different SCADA hosts). An iNET or iNET-II radio provides this functionality with a single remote radio. Each of the two serial ports can be connected via IP to different SCADA hosts, transporting different (or the same) protocols. Both data streams are completely independent and the transceiver provides seamless simultaneous operation as shown in.



**Figure 1-6. Multiple Protocol Network**

By using a single radio, the cost of deployment is cut in half. Beyond requiring only one radio instead of two, the biggest cost reduction comes from using half of the required infrastructure at the remote site: one

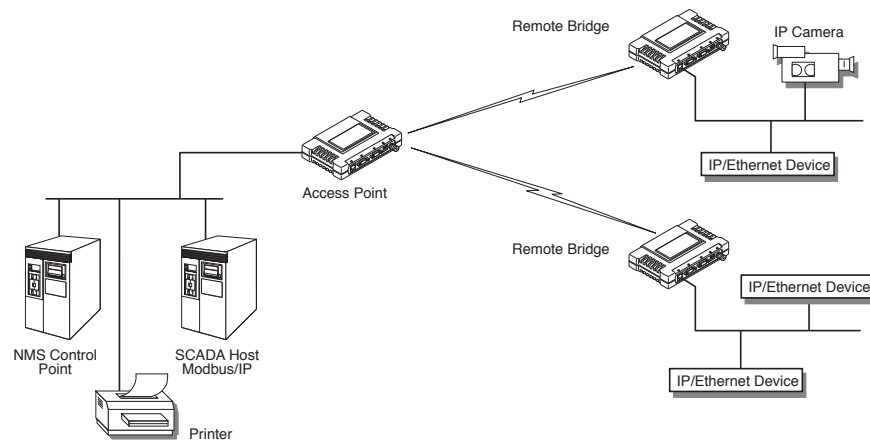
antenna, one feedline, one lightning protector and ancillary hardware. Other cost reductions come from the system as a whole, such as reduced management requirements. And above all, the radio offers potential for future applications that run over Ethernet and IP, such as video for remote surveillance.

### 1.3.5 Wireless LAN with Mixed Services

The iNET transceiver is an excellent solution for a long-range industrial wireless LAN. It offers several advantages over commercial solutions—primarily improved performance over extended distances. The rugged construction of the radio and its extended temperature range make it an ideal solution even in harsh locations. In extreme environments, a simple NEMA enclosure is sufficient to house the unit.

The transceiver trades higher speed for longer range. Commercial 802.11 a/b/g solutions are designed to provide service to relatively small areas such as offices, warehouses and homes. They provide high data rates but have limited range. The iNET transmits at a higher power level, uses a different frequency band, has higher sensitivity, and a narrower channel to concentrate the radio energy and reach farther distances. It is designed for industrial operation from the ground up.

IP-based devices that may be used with the transceiver include a new breed of more powerful Remote Terminal Units (RTUs) and Programmable Logic Controllers (PLCs). These, as well as other devices, may be used in applications ranging from SCADA/telemetry monitoring, web-based video, security monitoring, and voice over IP. Figure 1-7 shows a typical wireless IP network.



**Figure 1-7. Extended-Range LAN with Mixed Applications**

### 1.3.6 Upgrading Older Wireless Network with Serial Interfaces

Millions of wireless data products have been sold in the last two decades for licensed and license-free operation, many of them manufactured by

Microwave Data Systems. There are several ways that these systems can benefit from incorporating iNET equipment. The chief advantages are interface flexibility (serial and Ethernet in one unit), and higher data throughput. By taking advantage of its built-in serial and Ethernet interfaces, the transceiver is well suited to replace leased lines, dial-up lines, or existing MAS 900 MHz data transceivers.

### Replacing Legacy Wireless Products

In most cases, legacy radio transceivers supporting serial-interface equipment can be replaced with iNET transceivers. Legacy equipment can be connected to the transceiver through the COM1 or COM2 port with a DB-25 to DB-9 cable wired for EIA-232 signaling. The COM2 port supports all standard EIA-232 signaling and acts as a data-terminal equipment device (DTE).

---

**NOTE:** Several previous GE MDS-brand products had non-standard signal lines on their interface connectors (to control sleep functions and alarm lines, for example). These special functions are not provided nor supported by the iNET Series. Consult equipment manuals for complete pinout information.

---

### Supplement legacy wireless network with IP services

The iNET Dual Gateway model can support up to two serial devices and one Ethernet connection at the same time. The serial interfaces (COM1 and COM2) operate in two different modes: Connectionless UDP and connection-oriented TCP.

In the UDP mode, the transceiver supports point-to-multipoint serial-port to serial-port connectivity. In the TCP mode, it supports point-to-point Ethernet/IP to serial port connectivity.

For further details on the transceiver's Serial Gateway interface modes, see "*CONFIGURING THE SERIAL PORTS*" on Page 61.

### 1.3.7 High-Speed Mobile Data

The iNET radios support high-speed data communications in a mobile environment. Remote radios roam between different access points, providing seamless transitions and continuous coverage. For additional information on configuring a mobile network, refer to Mobility Configuration Menu on Page 58.

## 1.4 NETWORK DESIGN CONSIDERATIONS

### 1.4.1 Extending Network Coverage with Repeaters

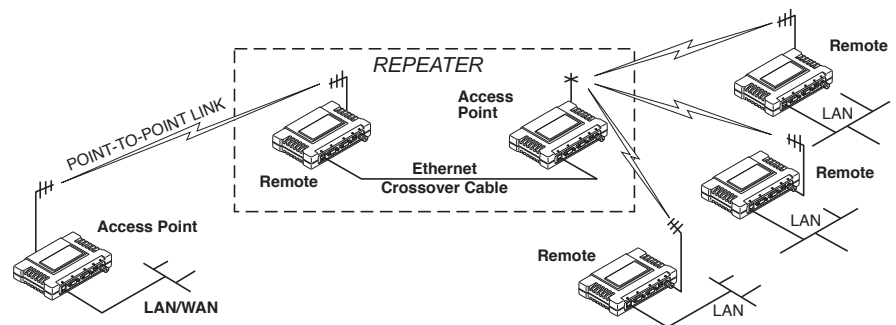
#### What is a Repeater System?

A repeater works by re-transmitting data from outlying remote sites to the Access Point and vice-versa. It introduces some additional end-to-end transmission delay but provides longer-range connectivity.

In some geographical areas, obstacles can make communications difficult. These obstacles are commonly large buildings, hills, or dense foliage. These obstacles can often be overcome with a repeater station.

#### Option 1—Using two transceivers to form a repeater station (back-to-back repeater)

Although the range between transceivers can be a nominal 40 km (25 miles) over favorable terrain, it is possible to extend the range considerably by connecting two units together at one site in a “back-to-back” fashion to form a repeater, as shown in Figure 1-8. This arrangement should be used whenever the objective is to utilize the maximum range between stations. In this case, using high-gain Yagi antennas at each location will provide more reliable communications than their counterparts—omnidirectional antennas.



**Figure 1-8. Typical LAN with a Repeater Link**

#### Overview

Two transceivers may be connected “back-to-back” through the LAN Ports to form a repeater station. (The cable must be a “cross-over” Ethernet cable for this to work). This configuration is sometimes required in a network that includes a distant Remote that would otherwise be unable to communicate directly with the Access Point station due to distance or terrain.

The geographic location of a repeater station is especially important. A site must be chosen that allows good communication with *both* the Access Point and the outlying Remote site. This is often on top of a hill, building, or other elevated terrain from which both sites can be “seen”

by the repeater station antennas. A detailed discussion on the effects of terrain is given in Section 4.1.2, *Site Selection* (beginning on Page 131).

The following paragraphs contain specific requirements for repeater systems.

### Antennas

Two antennas are required at this type of repeater station—one for each radio. Measures must be taken to minimize the chance of interference between these antennas. One effective technique for limiting interference is to employ *vertical separation*. In this arrangement, assuming both are vertically polarized, one antenna is mounted *directly* over the other, separated by at least 10 feet (3 Meters). This takes advantage of the minimal radiation exhibited by most antennas directly above and below their driven elements.

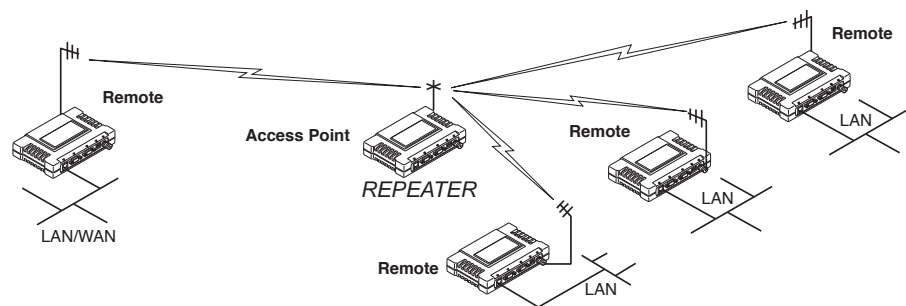
Another interference reduction technique is to cross-polarize the repeater antennas. If one antenna is mounted for polarization in the vertical plane, and the other in the horizontal plane, an additional 20 dB of attenuation can be achieved. (Remember that the corresponding stations should use the same antenna orientation when cross-polarization is used.)

### Network Name

The two radios that are wired together at the repeater site *must* have different network names.

### Option 2—Using the AP as a Store-and-Forward Packet Repeater

A wireless network can be extended through the use of an alternate arrangement using the Access Point as a repeater to re-transmit the signals of all stations in the network. The repeater is a standard transceiver configured as an Access Point, and operating in Store and Forward mode. (See Figure 1-9.)



**Figure 1-9. Typical network with store-and-forward repeater**

As with the conventional repeater described in Option 1 above, the location of a store and forward repeater is also important. A site must be chosen that allows good communication with *both* the Access Point and the outlying Remote site. This can be on the top of a hill, building, or other elevated terrain from which all sites can be “seen” by the repeater

station antenna. A detailed discussion on the effects of terrain is given in Section 4.1.2, *Site Selection* (beginning on Page 131)

### 1.4.2 Protected Network Operation using Multiple Access Points

Although GE MDS transceivers have a very robust design and have undergone intensive testing before being shipped, it is possible for isolated failures to occur. In mission-critical applications, down time can be virtually eliminated by using some, or all, of the following configurations:

In a point-to-multipoint scenario, the Access Point services multiple remotes. A problem in the Access Point will have an effect on all remotes, since none will have access to the network. When operation of the network does not tolerate any down time, it is possible to set up a protected configuration for the Access Point to greatly reduce the possibility of this occurrence.

Two or more Access Points can be configured with the same Network Name and kept active simultaneously, each with its own independent antenna. In this scenario, Remotes will associate with either one of the available Access Points. In case of a failure of one of the AP's the Remotes will quickly associate with another of the remaining Access Points re-establishing connectivity to the end devices.

The Access Points are unaware of the existence of the other AP's. Because the hopping algorithm uses *both* the Network Name *and* the Wireless MAC address of the AP to generate the hopping pattern, multiple AP's can coexist—even if they use the same network name. The collocated AP's will be using different hopping patterns and frequencies the great majority of the time. Although some data collisions will occur, the wireless-MAC is built to tolerate and recover from such occurrences with minimal degradation.

### 1.4.3 Collocating Multiple Radio Networks

Many networks can operate in relatively close physical proximity to one another provided reasonable measures are taken to assure the radio signal of one Access Point is not directed at the antenna of the second Access Point.

#### The Network Name and the association process

The Network Name is the foundation for building individual radio networks. It is part of a beacon signal broadcast by the Access Point (AP) to any Remote units with the same Network Name. Remotes that join the network are referred to as being “associated” with the Access Point unit.

Multiple APs with the same Network Name should be used with care. Using the same Network Name in multiple APs may result in Remotes



associating with undesired APs and preventing data exchange from occurring as planned.

The use of a different Network Name does not guarantee an interference-free system. It does however, assure that only data destined for a unique network is passed through to that network.

### **Co-Location for Multiple Networks**

It may be desirable to co-locate Access Points at one location to take advantage of an excellent or premium location that can serve two independent networks. Each network should have unique Network Name and each AP unit's antenna should be provided as much vertical separation as is practical to minimize RFI.

---

**NOTE:** All transceivers are shipped with the Network Name set to "Not Programmed." The Network Name must be programmed in order to pass data and begin normal operations.

---

### **Can radio frequency interference (RFI) disrupt my wireless network?**

When multiple radio networks operate in close physical proximity to other wireless networks, individual units may not operate reliably under weak signal conditions and may be influenced by strong radio signals in adjacent bands. This radio frequency interference cannot be predicted with certainty, and can only be determined by experimentation. If you need to co-locate two units, start by using the largest possible vertical antenna separation between the two AP antennas on the same support structure. If that does not work, consult with your factory representative about other techniques for controlling radio frequency interference between the radios. (See "A Word About Radio Interference" on Page 136 for more details.)

## **1.5 CYBER SECURITY**

Today the operation and management of an enterprise is becoming increasingly dependent on electronic information flow. An accompanying concern becomes the cyber security of the communication infrastructure and the security of the data itself.

The transceiver is capable of dealing with many common security issues. Table 1-3 profiles security risks and how the transceiver provides a solution for minimizing vulnerability.

**Table 1-3. Security Risk Management**

<b>Security Vulnerability</b>	<b>GE MDS Cyber Security Solution</b>
Unauthorized access to the backbone network through a foreign remote radio	<ul style="list-style-type: none"> <li>• 802.1x authentication</li> <li>• Approved Remotes List (local) Only those remotes included in the AP list will associate</li> </ul>
“Rogue” AP, where a foreign AP takes control of some or all remote radios and thus remote devices	<ul style="list-style-type: none"> <li>• 802.1x authentication</li> <li>• Approved AP List A remote will only associate to those AP included in its local authorized list of AP</li> </ul>
Dictionary attacks, where a hacker runs a program that sequentially tries to break a password.	<ul style="list-style-type: none"> <li>• Failed-login lockdown After 3 tries, the transceiver ignores login requests for 5 minutes. Critical event reports (traps) are generated as well.</li> </ul>
Denial of service, where Remote radios could be reconfigured with bad parameters bringing the network down.	<ul style="list-style-type: none"> <li>• Remote login with SSH or HTTPS</li> <li>• Local console login</li> <li>• Disabled HTTP &amp; Telnet to allow only local management services</li> </ul>
Airsnort and other war-driving hackers in parking lots, etc.	<ul style="list-style-type: none"> <li>• 900 MHz operation is not interoperable with standard 802.11b wireless cards</li> <li>• The transceiver cannot be put in a promiscuous mode</li> <li>• Proprietary data framing</li> </ul>
Eavesdropping, intercepting messages	<ul style="list-style-type: none"> <li>• AES-128 encryption (iNET-II)</li> <li>• RC4-128 encryption (iNET)</li> </ul>
Key cracking software	<ul style="list-style-type: none"> <li>• Automatic Rotating Key algorithm</li> </ul>
Replaying messages	<ul style="list-style-type: none"> <li>• Automatic Rotating Key algorithm</li> </ul>

**Table 1-3. Security Risk Management**

<b>Security Vulnerability</b>	<b>GE MDS Cyber Security Solution</b>
Unprotected access to configuration via SNMPv1	<ul style="list-style-type: none"> <li>• Implement SNMPv3 secure operation</li> </ul>
Intrusion detection	<ul style="list-style-type: none"> <li>• Provides early warning via SNMP through critical event reports (unauthorized, logging attempts, etc.)</li> <li>• Unauthorized AP MAC address detected at Remote</li> <li>• Unauthorized Remote MAC address detected at AP</li> <li>• Login attempt limit exceeded (Accessed via: Telnet, HTTP, or local)</li> <li>• Successful login/logout (Accessed via: Telnet, HTTP, or local)</li> </ul>

## 1.6 ACCESSORIES

The transceiver can be used with one or more of the accessories listed in Table 1-4. Contact the factory for ordering details.

**Table 1-4. Accessories**

<b>Accessory</b>	<b>Description</b>	<b>GE MDS Part No.</b>
AC Power Adapter Kit	A small power supply module designed for continuous service. UL approved. Input: 120/220; Output: 13.8 Vdc @ 2.5 A	01-3682A02
Omni-Directional Antennas	Rugged antennas well suited for use at Access Point installations. Consult with your factory Sales Representative for details	Call factory
Yagi Antenna (Directional)	Rugged antennas well suited for use at Remote installations. Consult with your factory Sales Representative for details.	Call factory
TNC Male-to-N Female Adapter	One-piece RF adaptor plug.	97-1677A161
TNC Male-to-N Female Adapter Cable	Short length of coaxial cable used to connect the radio's TNC antenna connector to a Type N commonly used on large diameter coaxial cables.	97-1677A159 (3 ft./1m)  97-1677A160 (6 ft./1.8m)
Ethernet RJ-45 Crossover Cable (CAT5)	Cable assembly used to cross-connect the Ethernet ports of two transceivers used in a repeater configuration. (Cable length ≈ 3 ft./1M)	97-1870A21
2-Pin Power Plug	Mates with power connector on transceiver. Screw terminals provided for wires, threaded locking screws to prevent accidental disconnect.	73-1194A39

**Table 1-4. Accessories (Continued)**

<b>Accessory</b>	<b>Description</b>	<b>GE MDS Part No.</b>
Ethernet RJ-45 Straight-thru Cable (CAT5)	Cable assembly used to connect an Ethernet device to the transceiver. Both ends of the cable are wired identically. (Cable length ≈ 3 ft./1M)	97-1870A20
EIA-232 Shielded Data Cable	Shielded cable terminated with a DB-25 male connector on one end, and a DB-9 female on the other end. Two lengths available (see part numbers at right).	97-3035L06 (6 ft./1.8m) 97-3035L15 (15 ft./4.6m)
EIA-232 Shielded Data Cable	Shielded cable terminated with a DB-9 male connector on one end, and a DB-9 female on the other end, 6 ft./1.8m long.	97-1971A03
Fuse	Small, board-mounted fuse used to protect against over-current conditions.	29-1784A03
Flat-Surface Mounting Brackets & Screws	Brackets: 2" x 3" plates designed to be screwed onto the bottom of the unit for surface-mounting the radio.	82-1753-A01
	Screws: 6-32/1/4" with locking adhesive. (Industry Standard MS 51957-26)	70-2620-A01
DIN Rail Mounting Bracket	Bracket used to mount the transceiver to standard 35 mm DIN rails commonly found in equipment cabinets and panels.	03-4022A02
COM2 Interface Adapter	DB-25(F) to DB-9(M) shielded cable assembly (6 ft./1.8 m) for connection of equipment or other EIA-232 serial devices previously connected to "legacy" units. (Consult factory for other lengths and variations.)	97-3035A06
GE MDS NETview MS Software	PC-based network management system for new-generation GE MDS transceivers. Allows radio control and diagnostics in a hierarchal map perspective.	03-3938A01
Bandpass Filter	Antenna system filter that helps eliminate interference from nearby paging transmitters.	20-2822A02
Ethernet Surge Suppressor	Surge suppressor for protection of Ethernet port against lightning.	29-4018A01



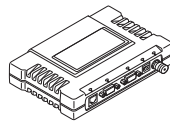
# 2 EMBEDDED MANAGEMENT SYSTEM

## Contents

2.1	INTRODUCTION .....	23
2.1.1	Differences in the User Interfaces .....	23
2.2	ACCESSING THE MENU SYSTEM .....	25
2.2.1	Methods of Control .....	26
2.2.2	PC Connection & Log In Procedures .....	26
2.2.3	Navigating the Menus .....	31
	Via Terminal Telnet or SSH Sessions	
	Recommended for first-time log-in .....	31
	Navigating via Web Browser .....	31
2.3	BASIC DEVICE INFORMATION.....	32
2.3.1	Starting Information Screen .....	32
2.3.2	Main Menu .....	34
2.3.3	Configuring Basic Device Parameters .....	35
	Device Information.....	35
	Device Names Menu .....	36
2.4	CONFIGURING NETWORK PARAMETERS .....	37
2.4.1	Network Configuration Menu .....	37
2.4.2	Network Interface Configuration Menu .....	39
	Virtual LAN in iNET-II and iNET.....	40
	Configuring for Operation with VLAN .....	41
	Configuring the IP Address when VLAN Status is Enabled.....	42
	Configuring the IP Address When VLAN Status is Disabled .....	43
2.4.3	Ethernet Port Configuration Menu .....	45
2.4.4	DHCP Server Configuration .....	46
2.4.5	SNMP Agent Configuration .....	47
2.4.6	Prioritized AP Configuration Submenu .....	49
2.5	RADIO CONFIGURATION .....	51
2.5.1	Radio Configuration Menu .....	51
2.5.2	Channel Config Menu .....	54
2.5.3	Skip Zones Menu .....	55
2.5.4	Auto Data Rate Configuration Menu .....	56
2.5.5	Mobility Configuration Menu .....	58
	Additional Considerations for Mobile Operation .....	59
	At Every Mobile (Remote) Radio .....	59

At Every AP Radio .....	60
<b>2.6 CONFIGURING THE SERIAL PORTS .....</b>	<b>60</b>
2.6.1 Overview .....	60
Com1 Port—Dual Purpose Capability .....	61
TCP vs. UDP .....	61
Serial Encapsulation .....	61
TCP Client vs. TCP Server .....	62
UDP Multicast .....	62
PPP .....	63
Data Buffering .....	63
Implementing Configuration Changes .....	63
Serial Configuration Wizard .....	63
2.6.2 Serial Data Port Configuration Menu .....	63
2.6.3 Configuring for UDP Mode .....	64
2.6.4 Configuring for TCP Mode .....	68
2.6.5 Configuring for PPP Mode .....	70
2.6.6 IP-to-Serial Application Example .....	71
2.6.7 Point-to-Multipoint IP-to-Serial Application Example .....	72
2.6.8 Point-to-Point Serial-to-Serial Application Example .....	74
2.6.9 Combined Serial and IP Application Example .....	75
Operation and Data Flow .....	75
2.6.10 Virtual LAN in iNET-II and iNET .....	77
Configuring for Operation with VLAN .....	78
<b>2.7 CYBER SECURITY CONFIGURATION .....</b>	<b>78</b>
2.7.1 Device Security .....	79
2.7.2 Wireless Security .....	80
Local Authentication <input type="checkbox"/> Approved Remotes/Access Points List Submenu .....	81
2.7.3 RADIUS Configuration .....	82
Operation of Device Authentication .....	83
Operation of User Authentication .....	83
2.7.4 RADIUS Configuration .....	84
2.7.5 Certificate Management (Remote transceivers only) .....	84
<b>2.8 PERFORMANCE VERIFICATION .....</b>	<b>85</b>
2.8.1 RSSI by Zone Menu (Remotes Only) .....	87
2.8.2 Event Log Menu .....	88
Time and Date .....	88
View Current Alarms .....	90
View Event Log .....	91
2.8.3 Packet Statistics Menu .....	91
Wireless Packet Statistics .....	91
Ethernet Packet Statistics .....	92
Packets Received by Zone .....	93
2.8.4 Wireless Network Status (Remotes Only) .....	94
The Transceiver <input type="checkbox"/> s Association Process .....	94

The Wireless Network Status Screen (Remotes Only).....	95
2.8.5 Remote Listing Menu (Access Points Only) .....	96
2.8.6 Endpoint Listing Menu (Access Points Only) .....	97
2.8.7 Remote Performance Listing Menu (Access Points Only) .....	98
2.8.8 Serial Data Statistics Menu .....	99
<b>2.9 MAINTENANCE.....</b>	<b>99</b>
2.9.1 Reprogramming Menu .....	100
Upgrading the Firmware .....	102
Error Messages During File Transfers.....	104
2.9.2 Configuration Scripts Menu .....	105
How Configuration Files Work .....	105
Sample of Configuration Script File .....	106
Editing Configuration Files.....	107
2.9.3 Authorization Keys Menu .....	108
2.9.4 Change the Type of Remote .....	108
2.9.5 Auto-Upgrade/Remote-Reboot Menu .....	108
Firmware Upgrade (with AP Acting as a TFTP Server) .....	109
2.9.6 Radio Test Menu .....	110
2.9.7 Ping Utility Menu .....	111
2.9.8 Reset to Factory Defaults .....	111
Password Reset .....	111





## 2.1 INTRODUCTION

The transceiver's embedded management system is accessible through various data interfaces. These include the COM1 (serial) port, LAN (Ethernet) port, and via SNMP. Essentially the same capabilities are available through any of these paths.

For SNMP management, the transceiver is compatible with GE MDS *NETview MS*<sup>™</sup> software. Refer to GE MDS publication 05-2973A01 for more information on this tool. For support of other SNMP software, a set of MIB files is available for download from the GE MDS Web site at **www.GEmds.com**. A brief summary of SNMP commands can be found at *SNMP Agent Configuration* section on Page 47 of this manual.

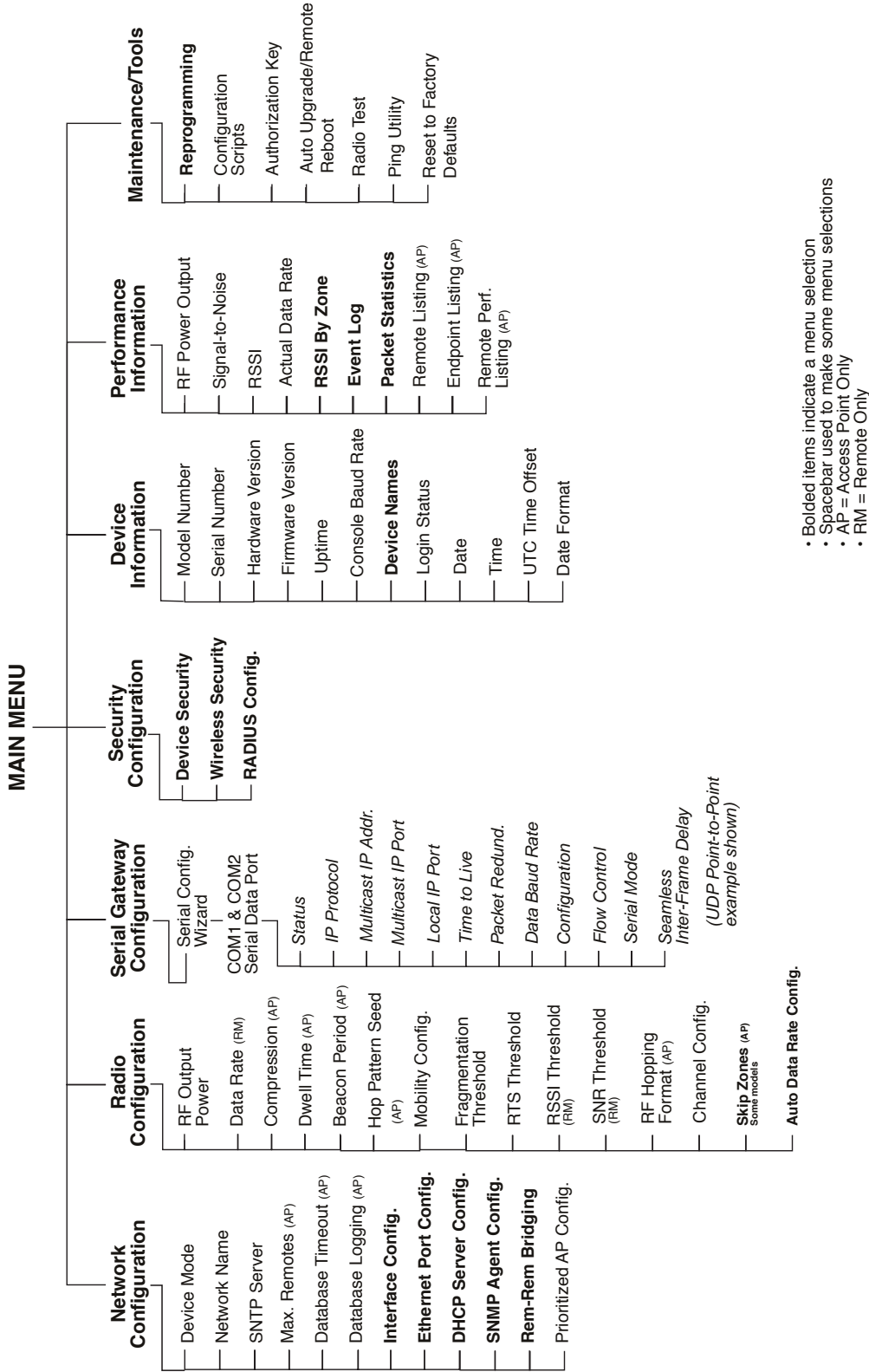
The transceiver's Management System and its functions are divided into the following menu groups:

- Section 2.3, *BASIC DEVICE INFORMATION* (beginning on Page 32)
- Section 2.4, *CONFIGURING NETWORK PARAMETERS* (beginning on Page 37)
- Section 2.5, *RADIO CONFIGURATION* (beginning on Page 51)
- Section 2.6, *CONFIGURING THE SERIAL PORTS* (beginning on Page 61)
- Section 2.7, *CYBER SECURITY CONFIGURATION* (beginning on Page 79)
- Section 2.8, *PERFORMANCE VERIFICATION* (beginning on Page 85)
- Section 2.9, *MAINTENANCE* (beginning on Page 99)

Each of these sections has a focus that is reflected in its heading. The section you are now reading provides information on connecting to the Management System, how to navigate through it, how it is structured, and how to perform top-level configuration tasks. Figure 2-1 on the following page shows a top-level view of the Management System (MS).

### 2.1.1 Differences in the User Interfaces

There are slight differences in navigation, but for the most part, the content is the same among different user interfaces. You will find a few differences in capabilities as the communications tool is driven by limitations of the access channel. Below are examples of the Starting Information Screen seen through a terminal and a Web-browser, respectively.

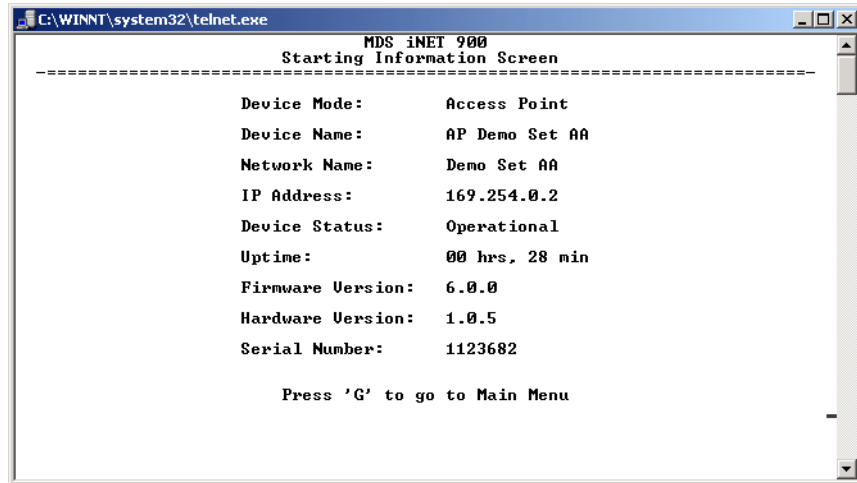


- Boided items indicate a menu selection
- Spacebar used to make some menu selections
- AP = Access Point Only
- RM = Remote Only

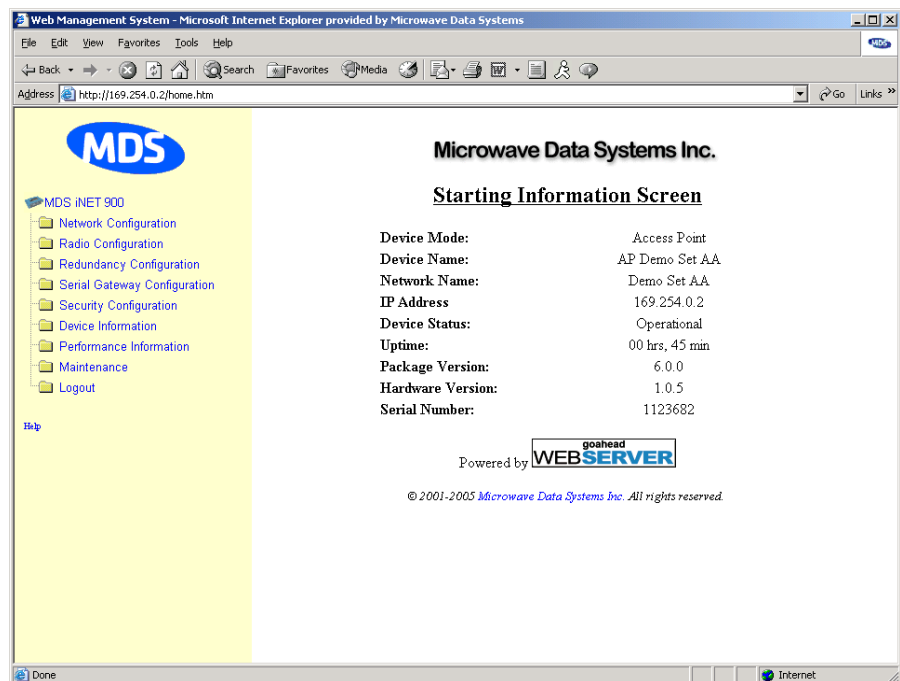
**NOTES**

- Chart shows top-level view only. Details are given on the following pages.
- Not all items are user-configurable
- Some menu items depend on the Device Mode selected

**Figure 2-1. Embedded Management System—Top-level Flowchart**



**Figure 2-2. View of MS with a text-based program—**  
*(Terminal Emulator shown—Telnet has similar menu structure)*



**Figure 2-3. View of the MS with a Browser**  
*(Selections at left provide links to the various menus)*

## 2.2 ACCESSING THE MENU SYSTEM

The radio has no external controls. All configuration, diagnostics and control is performed electronically using a connected PC. This section explains how to connect a PC, log into the unit, and gain access to the built-in menu screens.

## 2.2.1 Methods of Control

The unit's configuration menus may be accessed in one of several ways:

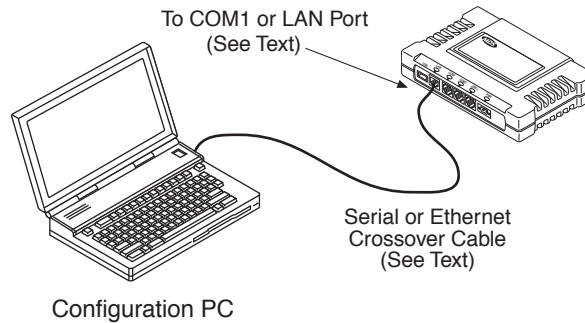
- **Local Console**—*This is the primary method used for the examples in this manual.* Connect a PC directly to the COM 1 port using a serial communications cable and launch a terminal communications program such as HyperTerminal. This method provides text-based access to the unit's menu screens. Console control is a hardware-based technique, and is intended for local use only.
- **Telnet or SSH\***—Connect a PC to the unit's LAN port, either directly or via a network, and launch a Telnet session. This method provides text-based access to the unit's menu screens in a manner similar to a Local Console session. Telnet sessions may be run locally or remotely through an IP connection.
- **Web Browser\***—Connect a PC to the unit's LAN port, either directly or via a network, and launch a web browser session (*i.e.*, Internet Explorer, Netscape, etc.) This method provides a graphical representation of each screen, just as you would see when viewing an Internet website. The appearance of menu screens differs slightly from other methods of control, but the content and organization of screen items is similar. Web browser sessions may be run locally or remotely via the Internet.

\* Telnet, SSH and Web Browser sessions require the use of a *straight-through* or *crossover* Ethernet cable, depending on whether the PC-to-radio connection is made directly, or through an Ethernet switch. For direct connection, a **crossover** cable is required; For connection using an Ethernet switch, a **straight-through** type is needed.

Cable type can be identified as follows: Hold the two cable ends side-by-side and in the same plug orientation (*i.e.*, both locking tabs up or down). Now look at the individual wire colors on each plug. If the wires on both plugs are ordered in the same sequence from left to right, the cable is a straight-through type. If they are not in the same order, it *may* be a crossover cable, or it may be wired for some other application. Refer to DATA INTERFACE CONNECTORS on Page 153 for detailed pinout information.

## 2.2.2 PC Connection & Log In Procedures

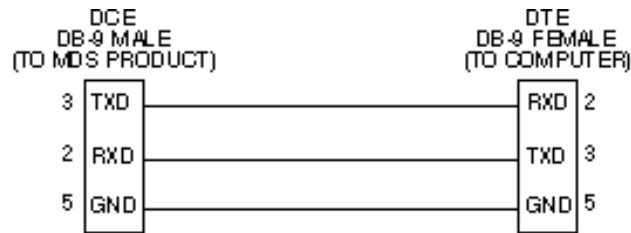
The following steps describe how to access the radio's menu system. These steps require a PC to be connected to the unit's COM 1 or LAN port as shown in Figure 2-4.



**Figure 2-4. PC Configuration Setup**

**Starting a Local Console Session (Recommended for first-time log-in)**

1. Connect a serial communications cable between the PC and the unit's COM 1 port. If necessary, a cable may be constructed for this purpose as shown in Figure 2-5.



**Figure 2-5. Serial Communications Cable (RJ-11 to DB-9)**  
(Maximum Recommended Cable Length 50 Feet/15 meters)

2. Launch a terminal emulation program such as HyperTerminal and configure the program with the following settings:
  - 19,200 bps data rate
  - 8 data bits, no parity
  - One stop bit, and no flow-control
  - Use ANSI or VT100 emulation.

**TIP:** The HyperTerminal communications program can be accessed on most PCs by selecting this menu sequence: **Start>>Programs>>Accessories>>Communications>>HyperTerminal.**

**NOTE:** Early versions of PuTTY might not operate when using SSH to connect to the transceiver. However, beta versions 0.59 and later do work properly. Both the latest released and the latest development snapshot can be downloaded from:  
[www.chiark.greenend.org.uk/~sgtatham/putty/](http://www.chiark.greenend.org.uk/~sgtatham/putty/).

**NOTE:** If the unit is powered-up or rebooted while connected to a terminal, you will see a series of pages of text information relating to the booting of the unit's microcomputer. Wait for the log-in screen before proceeding.

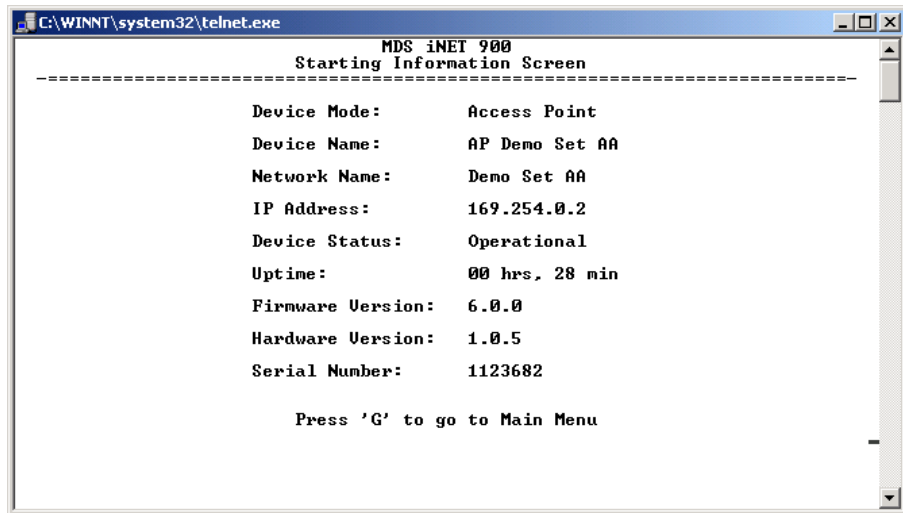
3. Press the **[ENTER]** key to receive the **login:** prompt.
4. Enter the username (default username is **iNET** or **iNET-II**, in accordance with radio model). Press **[ENTER]**.
5. Enter your password (default password is **admin**). (For security, your password keystrokes do not appear on the screen.) Press **[ENTER]**.

---

**NOTE:** Passwords are case sensitive. Do not use punctuation mark characters. You may use up to eight alpha-numeric characters.

---

The unit responds with the Starting Information Screen (Figure 2-6). From here, you can review basic information about the unit or press **G** to proceed to the Main Menu.



```

C:\WINNT\system32\telnet.exe
MDS iNET 900
Starting Information Screen
-----
Device Mode:      Access Point
Device Name:     AP Demo Set AA
Network Name:    Demo Set AA
IP Address:      169.254.0.2
Device Status:   Operational
Uptime:         00 hrs, 28 min
Firmware Version: 6.0.0
Hardware Version: 1.0.5
Serial Number:   1123682

Press 'G' to go to Main Menu
  
```

**Figure 2-6. Starting Information Screen—Local Console Session**  
(Telnet has similar menu structure)

### Starting a Telnet Session

---

**NOTE:** This method requires that you know the IP address of the unit beforehand. If you do not know the address, use the Local Console method (above) and access the *Starting Information Screen*. The address is displayed on this screen.

---

1. Connect a PC to the unit's LAN port, either directly or via a network. If connecting directly, use an Ethernet *crossover* cable; if connecting via a network, use a *straight-through* cable. The LAN LED lights to indicate an active connection.

---

**NOTE:** When using Ethernet to access the unit, it may be necessary to change your computer's IP address to be compatible with the radio IP address. You can identify or verify the unit's IP address by using a Local Console session to communicate with the radio through its COM 1 Port and viewing the *Starting Information Screen*.

---

2. Start the Telnet program on your computer targeting the IP address of the unit to which you are connected. and press **[ENTER]**.

**TIP:** A Telnet session can be started on most PCs by selecting: **Start>>Programs>>Accessories>>Command Prompt**. At the command prompt window, type the word **telnet**, followed by the unit's IP address (*e.g.*, **telnet 10.1.1.168**). Press **[ENTER]** to receive the Telnet log in screen.

---

**NOTE:** Never connect multiple units to a network with the same IP address. Address conflicts will result in improper operation.

---

3. Enter your username (default username is **iNET** or **iNET-II**, in accordance with radio model). Press **[ENTER]**.

Next, the **Password:** prompt appears. Enter your password (default password is **admin**). (For security, your password keystrokes will not appear on the screen.) Press **[ENTER]**.

The unit responds with a Starting Information Screen (see Figure 2-6). From here, you can review basic information about the unit or press **G** to proceed to the Main Menu.

---

**NOTE:** Passwords are case sensitive. Do not use punctuation mark characters. You may use up to eight alpha-numeric characters.

---

### **Starting a Web Browser Session**

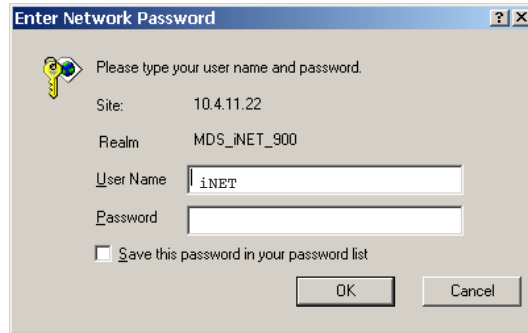
---

**NOTE:** Web access requires that you know the IP address of the unit you are connecting to. If you do not know the address, start a Local Console session (see Starting a Local Console Session (Recommended for first-time log-in) on Page 27) and access the *Starting Information Screen*. The IP address is displayed on this screen.

---

1. Connect a PC to the unit's LAN port, either directly or via a network. If connecting directly, use an Ethernet *crossover* cable; if connecting via a network, use a *straight-through* cable. The LAN LED lights to indicate an active connection.
2. Launch a Web-browser session on your computer (*i.e.*, Internet Explorer, Netscape Navigator, etc.).

3. Type in the unit's IP address and press **[ENTER]**.
4. A log-in screen is displayed (Figure 2-7) where you enter a user name and password to access the unit's menu system. Note that the default entries are made in *lower case*. (Default username is **iNET** or **iNET-II**, in accordance with radio model; Default Password is **admin**).



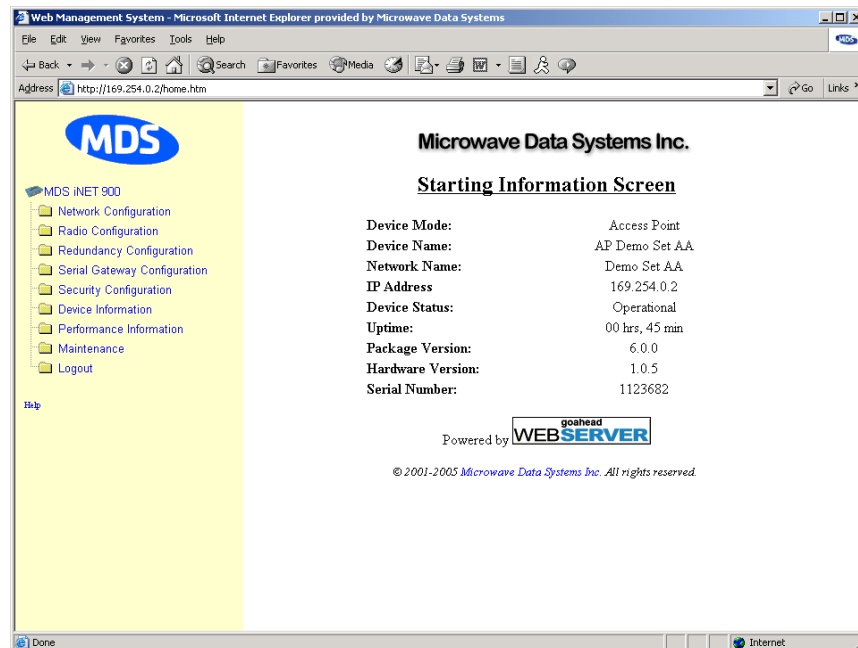
**Figure 2-7. Log-in Screen when using a Web Browser**

---

**NOTE:** Passwords are case sensitive. Do not use punctuation mark characters. You may use up to eight alpha-numeric characters.

---

5. Click **OK**. The unit responds with a startup menu screen similar to that shown in Figure 2-8. From here, you can review basic information about the unit or click on one of the menu items at the left side of the screen.



**Figure 2-8. Starting Information Screen—Web Browser Example**



## 2.2.3 Navigating the Menus

### Via Terminal Telnet or SSH Sessions

*Recommended for first-time log-in*

Local Console Telnet and SSH sessions use multi-layered text menu systems that are nearly identical. To move further down a menu tree, you type the letter assigned to an item of interest. This takes you to an associated screen where settings may be viewed, or changed. In most cases, pressing the **[ESCAPE]** key moves the screen back one level in the menu tree.

In general, the top portion of menu screens show *read-only* information (with no user selection letter). The bottom portion of the screen contains parameters that can be selected for further information, alteration of values, or to navigate to other submenus.

When you arrive at a screen with user-controllable parameter fields, you select the menu item by pressing an associated letter on the keyboard. If there is a user definable value, the field will clear to the right of the menu item and you can type in the value you wish to use. Follow this action by pressing the **[ENTER]** key to save the changes. If you make a mistake or change your mind before pressing the **[ENTER]** key, simply press **[ESCAPE]** to restore the previous value.

In some cases, when you type a letter to select a parameter, you will see a prompt at the bottom of the screen that says **Choose an Option**. In these screens, press the keyboard's **[SPACEBAR]** to step through the available selections. When the desired option appears, press the **[ENTER]** key to choose that selection. In some cases, several parameters may be changed and then saved by a single keystroke. The **[ESCAPE]** key can be used to cancel the action and restore the previous values.

#### **Logging Out Via Terminal Emulator or Telnet**

From the Main Menu screen, press **Q** to quit and terminate the session.

### Navigating via Web Browser

Navigating with a Web browser is straightforward with a framed "homepage." The primary navigation menu is permanently located on the left-hand side of this page. Simply click on a desired menu item to bring it to the forefront.

---

**NOTE:** To maintain security, it is best to log-out of the menu system entirely when you are done working with it. If you do not log out, the session automatically ends after 10 minutes of inactivity.

---

#### **Logging Out Via Web Browser**

Click on **Logout** in the left-hand frame of the browser window. The right-hand frame will change to a logout page. Follow the remaining instructions on this screen.

---

**NOTE:** In the menu descriptions that follow, parameter options/range, and any default values are displayed at the end of the text between square brackets. Note that the default setting is always shown after a semicolon: [available settings or range; default setting]

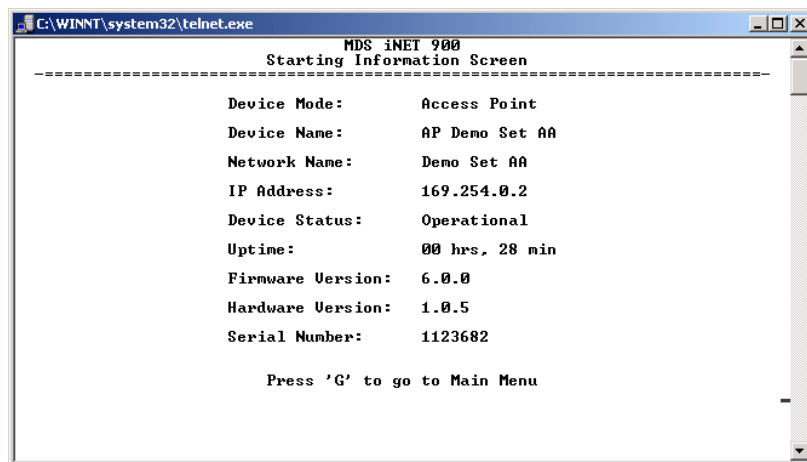
---

## 2.3 BASIC DEVICE INFORMATION

This section contains detailed menu screens and settings that you can use to specify the behavior of the unit.

### 2.3.1 Starting Information Screen

Once you have logged into the Management System, you will be presented with a screen that provides an overview of the transceiver and its current operating condition. It provides an array of vital information and operating conditions.



**Figure 2-9. Starting Information Screen**

- **Device Mode**—Current operating mode of the unit as it relates to the radio network.
- **Device Name**—This is a user-defined parameter that will appear in the heading of all pages.  
(To change it, see Network Configuration Menu on Page 37.)

---

**NOTE:** Do not use a colon (: ) or percent (%) symbol in the device name.

- **Network Name**—The name of the radio network in which the unit is associated [9 to 15 characters; Not Programmed].
- **IP Address**—Unit's IP address [192.168.1.1]
- **Device Status**—Condition of the unit's association with an Access Point.

At the Access Point:

- *Alarmed*—A alarm event has been logged and not cleared.
- *Operational*—Unit operating normally.

At a Remote:

- *Scanning*—The unit is looking for an Access Point beacon signal.
- *Expecting Sync(hronization)*—The unit has found a valid beacon signal for its network.
- *Hop Sync*—The unit has changed its frequency hopping pattern to match that of the Access Point.
- *Connected*—The unit has established a radio (RF) connection with the Access Point, but has not obtained cyber-security clearance to pass data.
- *Associated* —This unit has successfully synchronized and associated with an Access Point.
- *Alarmed*—The unit is has detected one or more alarms that have not been cleared.

---

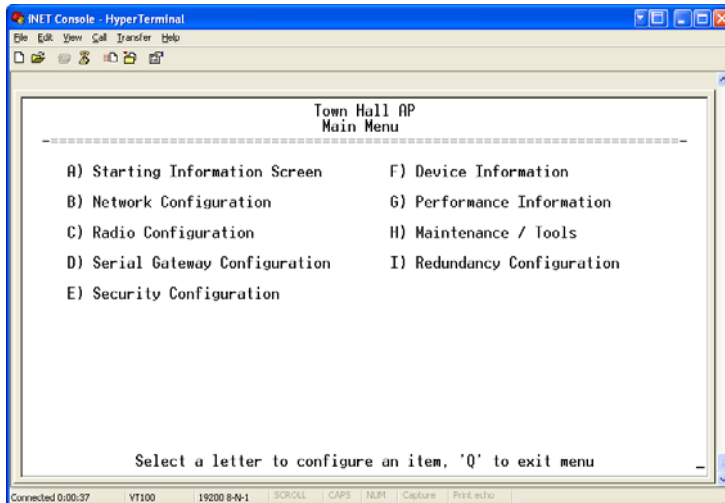
**NOTE:** If an alarm is present when this screen is displayed, an “A)” appears to the left of the **Device Status** field. Pressing the “A” key on your keyboard takes you directly to the “Current Alarms” screen.

---

- **Uptime**—Elapsed time since the transceiver was powered-up.
- **Firmware Version**— Version of firmware that is currently active in the unit.
- **Hardware Version**— Hardware version of the transceiver’s printed circuit board.
- **Serial Number**—Make a record of this number. It must be provided to purchase Authorization Keys to upgrade unit capabilities. (See “Authorization Keys Menu” on Page 108.)

## 2.3.2 Main Menu

The next screen, the Main Menu, is the entryway to all user-controllable features. The transceiver's **Device Name** appears at the top of this and all other screens as a reminder of the unit that is currently being controlled



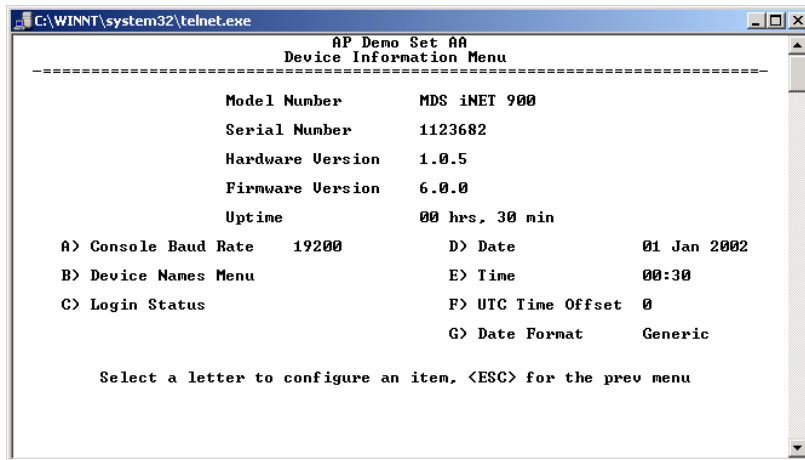
**Figure 2-10. Main Menu**

- **Starting Information Screen**— Select this item to return to the start-up screen. (See “Starting Information Screen” on Page 32)
- **Network Configuration**— Tools to configure the data network layer of the transceiver. (See “Network Configuration Menu” on Page 37)
- **Radio Configuration**— Tools to configure the wireless (radio) layer of the transceiver. (See “Radio Configuration Menu” on Page 52)
- **Serial Gateway Configuration**— Tools to configure the two serial ports. (See “Serial Data Port Configuration Menu” on Page 64)
- **Security Configuration**— Tools to configure the security services available with the transceiver’s environment. (See “CYBER SECURITY” on Page 15)
- **Device Information**— Top level user-specific and definable parameters, such as unit password. (See “Device Information” on Page 35)
- **Performance Information**— Tools to measure the radio and data layer’s performance of the radio network. (See “PERFORMANCE VERIFICATION” on Page 85)
- **Maintenance/Tools**— Tools to use configuration files, change firmware and use Authorization Keys to change major unit capabilities. (See “Authorization Keys Menu” on Page 108)
- **Redundancy Configuration**— For operation in protected (redundant) mode. The radio must be in a P21 enclosure for this operation. See GE MDS publication 05-4161A01 for details, available under the Downloads tab at [www.GEmds.com](http://www.GEmds.com).

## 2.3.3 Configuring Basic Device Parameters

### Device Information

Below is the menu/screen that displays basic administrative data on the unit to which you are connected. It also provides access to some user-specific parameters such as device names.



**Figure 2-11. Device Information Menu**

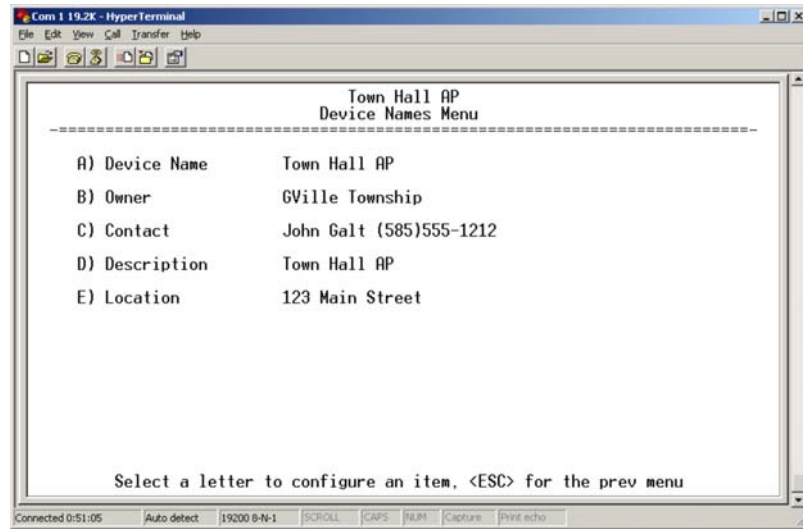
- **Model Number** (*Display only*)
- **Serial Number** (*Display only*)
- **Hardware Version** (*Display only*)
- **Firmware Version** (*Display only*)—Current firmware installed and being used by the transceiver.
- **Uptime** (*Display only*)—Elapsed time since powering up.
- **Console Baud Rate**—Used to set/display data communications rate (in bits-per-second) between a connected console terminal and the radio. [19200]
- **Device Names Menu**—Fields used at user’s discretion for general administrative purposes. The Device Name field is used by the transceiver as the “Realm” name for network security and in the MS screen headings. (See Figure 2-12 on Page 36)

**NOTE:** Do not use a colon (: ) or percent (%) symbol in the device name.

- **Date**—Current date being used for the transceiver logs. User-settable. (Value lost with power failure if SNTP (Simple Network Time Protocol) server not accessible.)
- **Time**—Current time of day. User-settable.  
Setting: HH:MM:SS  
(Value lost with power failure if SNTP server not accessible.)
- **Date Format**—Select presentation format:
  - Generic = dd Mmm yyyy
  - European = dd-mm-yyyy

- US = mm-dd-yyyy

## Device Names Menu



**Figure 2-12. Device Names Menu**

- **Device Name**—Device Name, used by the transceiver as the “Realm” name for network login (web browser only) and menu headings.

---

**NOTE:** Do not use a colon (: ) or percent (%) symbol in the device name.

---

- **Owner**—User defined; appears on this screen only.
- **Contact**—User defined; appears on this screen only.
- **Description**—User defined; appears on this screen only.
- **Location**—User defined; appears on this screen only.

## 2.4 CONFIGURING NETWORK PARAMETERS

### 2.4.1 Network Configuration Menu

The Network Configuration Menu contains parameters related to the operation of TCP/IP and Ethernet protocols. There are some differences between AP and Remote type radios regarding these parameters and they are noted where appropriate.

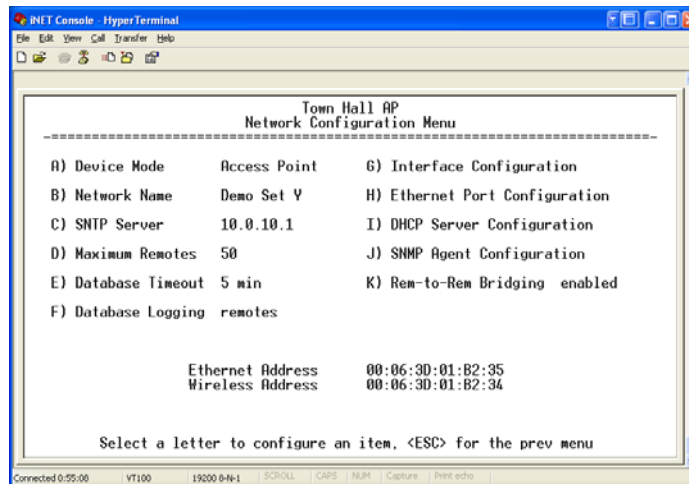


Figure 2-13. Network Configuration Menu  
From Access Point

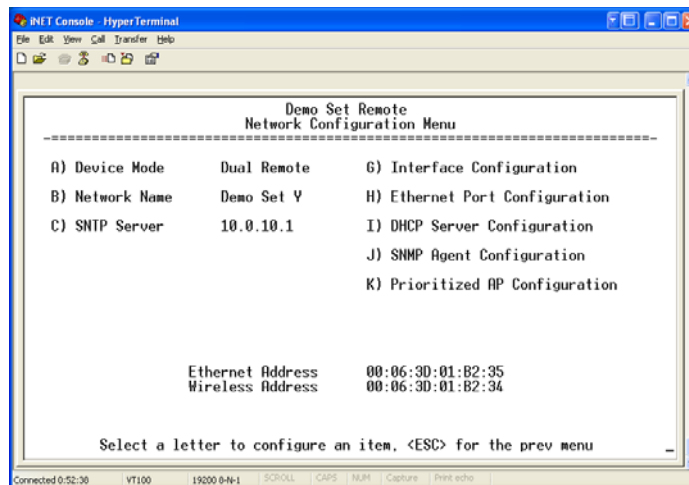


Figure 2-14. Network Configuration Menu  
From Remote Unit

- **Device Mode**—Either Access Point or a variation of a Remote. [Access Point, Remote; Remote]

---

**NOTE:** A serial Remote can be turned into an Ethernet Bridge and vice-versa. See Change the Type of Remote on Page 108 for details.

---

- **Network Name**—Name of the radio network that this unit belongs to. Essential for association of Remotes to the Access Point in a network. The Network Name should be at least nine characters long. [**9 to 15 characters; Not Programmed**]

**TIP:** For enhanced security, consider using misspelled words, a combination of letters and numbers, and a combination of upper and lower case letters. This helps protect against sophisticated hackers who may use a database of common words (for example, dictionary attacks) to determine the Network Name.

- **SNTP Server**—Address of SNTP server (RFC 2030) from which the transceiver will automatically get the time-of-day startup time. Without an SNTP server, the date and time must be manually set. An AP will try to get the time and date from the SNTP server only if an IP address is configured. It will continue to retry every minute until it succeeds.

A remote will get the time and date from the SNTP server, if an IP address is configured. Otherwise it gets it from the AP at authentication time. The transceivers use UTC (Universal Coordinated Time) with a configurable time offset. [**0.0.0.0**]

- **Maximum Remotes**—(AP only)—Number of Remotes permitted to be associated with this Access Point. [**50**]
- **Database Timeout** (AP Only)—This sets the database “age time.” See Remote Listing Menu (Access Points Only) on Page 96 to determine when a remote is declared unavailable. The timer may be set from 0 to 255 minutes and resets each time a message is received from a remote. [**0–255 minutes; 5 minutes**]
- **Database Logging** (AP Only)—Determines which types of devices will be reported as “added” or “deleted” from the AP’s database (see “*PERFORMANCE VERIFICATION*” on Page 85). In the case of deletions, this information is triggered by the expiration of Database Timeout above. [**Remote, All, Disabled; All**]. (**Remote** only reports the remote radios. Selecting **All** reports endpoints *and* remotes).
- **Interface Configuration**—Presents a menu for configuring the Virtual LAN (VLAN) and IP address of the transceiver. Detailed explanations are provided in the section titled Network Interface Configuration Menu on Page 39.

---

**NOTE:** In GE MDS iNET radios (where VLAN is not available) this option is shown as **IP ADDRESS CONFIGURATION**. Selecting this option follows the description in Configuring the IP Address When VLAN Status is Disabled on Page 43.

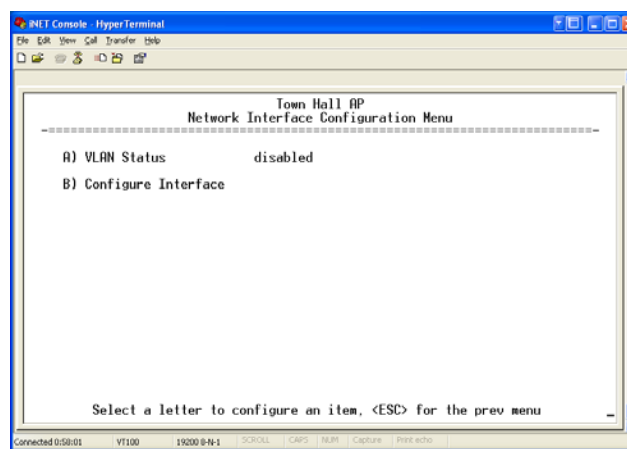
---



- **Ethernet Port Configuration**—Presents a menu for defining the status of the Ethernet port (enabled or disabled), the Ethernet rate limit, link hardware watch (enabled/disabled), and the Ethernet link poll address. Detailed explanations of this menu are contained in Ethernet Port Configuration Menu on Page 45.
- **DHCP Server Configuration**—Menu for configuration of DHCP services by the Access Point unit. DHCP provides “on-the-fly” IP address assignments to other LAN devices, including GE MDS iNET 900 units. See “DHCP Server Configuration” on Page 46 for more information. [**Disabled**]
- **SNMP Agent Configuration**—Contains SNMP configuration parameters. See “SNMP Agent Configuration” on Page 47 for more information.
- **Rem-to-Rem bridging**—This option is only available on Access Point radios. When this option is disabled communication can only happen from Remote to Access Point. This setting prevents a PC connected to one Remote radio to access a network connected to a different Remote within the same AP realm. [**enabled, disabled; enabled**]
- **Prioritized AP Configuration**—This option is only available on Remotes. It allows the definition of a Primary AP to which a Remote radio should be connected. See “Prioritized AP Configuration Submenu” on Page 49 for more information.
- **Ethernet Address (Display Only)**—Hardware address of the unit’s Ethernet interface.
- **Wireless Address (Display Only)**—Hardware address of the unit’s wireless Ethernet interface.

## 2.4.2 Network Interface Configuration Menu

Because iNET-II and iNET radios support 802.1Q VLAN, the method for configuring the IP address of a radio may vary depending on whether the VLAN Status option is enabled or not.



**Figure 2-15. Network Interface Configuration Menu**

- **VLAN Status**—Defines if the radio handles Ethernet frames in “extended” 802.1Q mode or in “normal” mode in the Ethernet port. [enabled, disabled; disabled]
- **Configure Interface**—Allows configuration of IP Addressing parameters. See Configuring the IP Address when VLAN Status is Enabled on Page 42, or Configuring the IP Address When VLAN Status is Disabled on Page 43.

---

**CAUTION:**The VLAN Status parameter must be consistent at both the Access Point and Remote radios in order for data to flow correctly. Failure to do so may result in data not being transported correctly even when the radios are in an associated state and able to communicate over-the-air.

---

### Virtual LAN in iNET-II and iNET

A VLAN is essentially a limited broadcast domain, meaning that all members of a VLAN receive broadcast frames sent by members of the same VLAN but not frames sent by members of a different VLAN. Additional details can be found in the IEEE 802.1Q standard.

The iNET-II and iNET support port-based VLAN at the Ethernet interface and over the air, according to the IEEE 802.1Q standard. When VLAN Status is enabled, the wireless port of both AP and remote radios act as a trunk port.

The Ethernet port of an Access Point radio is normally configured as a trunk port. This type of port expects incoming frames to have a **VLAN ID** and sends outgoing frames with a VLAN structure as well.

The Ethernet port of a remote radio can be configured as an access port or as a trunk port.

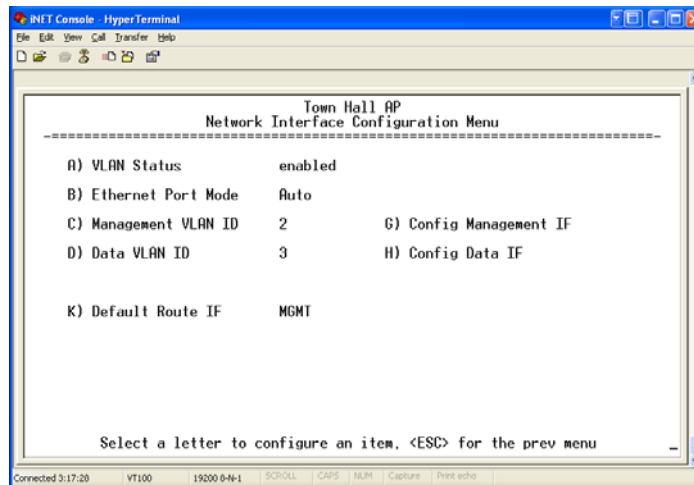
When the Ethernet port of a Remote radio is configured as VLAN Access Port, the radio will tag incoming traffic with a VLAN ID, and will strip the tag before sending out traffic. This VLAN is known as the DATA VLAN. Additionally, a second VLAN is assigned for other traffic that is terminated at the radio, such as SNMP, TFTP, ICMP, Telnet, etc. This is known as the MANAGEMENT VLAN. Traffic directed to the integrated terminal server that handles the serial ports is assigned to the DATA VLAN.

When the Ethernet port of a remote radio is configured as a VLAN trunk the radio expects all incoming Ethernet frames to be tagged, and passes through all outgoing frames as received from the wireless link, with the unchanged VLAN tag.

**NOTE:** The Ethernet port in an iNET-II and iNET is 10BaseT. Some Ethernet switches allow a VLAN trunk port only on a 100BaseT interface and may not be able to communicate with the radio.

## Configuring for Operation with VLAN

When VLAN Status is enabled the radio uses an 802.1Q frame structure.



**Figure 2-16. Network Interface Configuration Menu**

- **VLAN Status**—Defines whether the radio handles Ethernet frames in “extended” 802.1Q mode or in “normal” mode in the Ethernet port. Ethernet frames intended for the radio, but with a VLAN ID not configured in the radio are discarded. [enabled, disabled; disabled]

**NOTE:** This parameter must be consistent at both Access Point and Remote radios in order for data to flow correctly. Inconsistent configuration may result in data not being transported correctly and the loss of over-the-air communications.

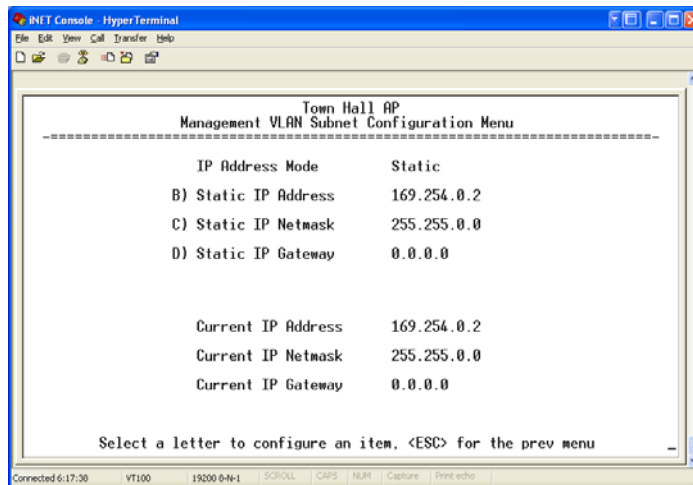
**NOTE:** A change made to the above parameter will result in the Commit Changes option appearing on screen. This will modify the appearance of the screen depending on the option selected.

- **Ethernet Port Mode**—Defines if the Ethernet port acts as a trunk port or as an access port. Auto mode defines the port as an access port in an AP, or a trunk port in a Remote radio. [Auto, Trunk, Access; Auto]
- **Management VLAN ID**—Defines the VLAN ID for traffic directed to the radio itself, other than the terminal server process. This VLAN ID is used for filtering and for tagging purposes. [1-4094; 2]

- **Data VLAN ID**—Defines the VLAN ID assigned to traffic directed to and from the Ethernet port and the terminal server process in the radio. This VLAN ID is used for filtering and for tagging purposes. [1-4094; 3]
- **Config Management IF**—Calls up a menu to configure the IP address associated with the Management VLAN ID.
- **Config Data IF**—Calls up a menu to configure the IP address associated with the Data VLAN ID.
- **Default Route IF**—Defines the VLAN that contains the default gateway in the radio. [MGMT, DATA; MGMT]

### Configuring the IP Address when VLAN Status is Enabled

The radios require a local IP address to support remote management and serial device (terminal server) services. When the radio is configured for VLAN operation the IP address can only be set as a static IP address.



**Figure 2-17. Management VLAN Subnet Configuration Menu**

- **IP Address Mode**—Defines the source of the IP address of this device. Only static IP addressing mode is available when VLAN Status is enabled [Static; Static]

**NOTE:** Changes to any of the following parameters while communicating over the network (LAN or over-the-air) may cause a loss of communication with the unit being configured. Communication will need to be re-established using the new IP address.

- **Static IP Address**—The IPv4 local IP address. [192.168.1.1]
- **Static IP Netmask**—The IPv4 local subnet mask. This value is used when the radio attempts to send a locally initiated message, either from the terminal server, or management process. [255.255.0.0]
- **Static IP Gateway**—The IPv4 address of the default gateway device, typically a router. [0.0.0.0]

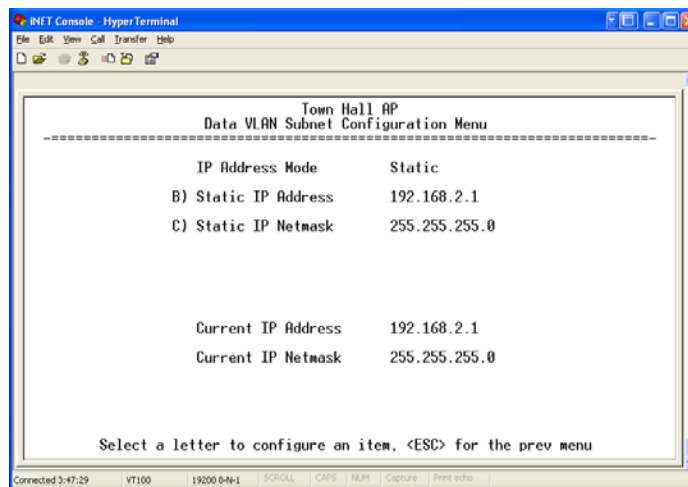
The lower three lines of the screen show the current addressing configured at the transceiver.

---

**NOTE:** Any change made to the above parameters results in the **Commit Changes** option appearing on screen. This allows all IP settings to be changed at the same time.

---

Selecting option H from Figure 2-16 shows the screen below. Note that the IP address is different although it is the same physical unit. This is because this IP address is defined for a different VLAN.



**Figure 2-18. Data VLAN Subnet Configuration Menu**

- **IP Address Mode**—Defines the source of the IP address of this device. Only static IP addressing mode is available when VLAN Status is enabled [**Static; Static**]

---

**NOTE:** Changes to any of the following parameters while communicating over the network (LAN or over-the-air) may cause a loss of communication with the unit being configured. Communication will need to be re-established using the new IP address.

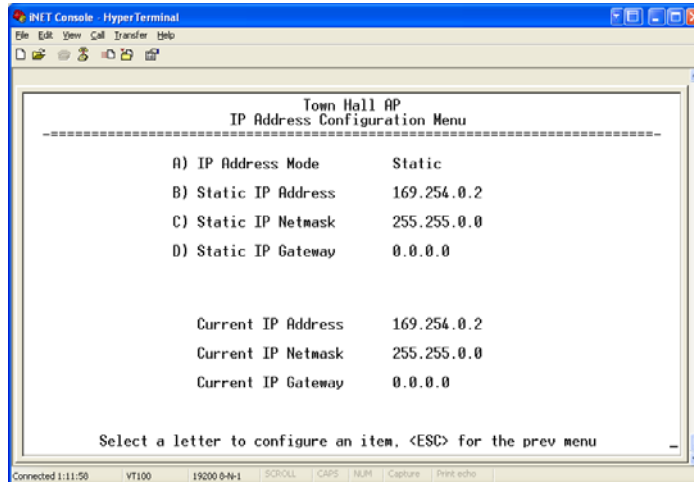
---

- **Static IP Address**—The IPv4 local IP address. [**192.168.1.1**]
- **Static IP Netmask**—The IPv4 local subnet mask. This value is used when the radio attempts to send a locally initiated message, either from the terminal server, or management process. [**255.255.0.0**]

### Configuring the IP Address When VLAN Status is Disabled

When the radio is not configured for operation with VLAN, it uses one IP address to support remote management and serial device services. The IP address of a radio can be set as a static IP address or as a dynamic IP address. When static IP addressing is used, the user must manually

configure the IP address and other parameters. When dynamic addressing is used, the radio uses a DHCP Client process to obtain an IP address from a DHCP Server, along with other parameters such as a subnet mask and a *default gateway*.



**Figure 2-19. IP Address Configuration Menu**

**CAUTION:** Changes to any of the following parameters while communicating over the network (LAN or over-the-air) may cause a loss of communication with the unit being configured. Communication will need to be re-established using the new IP address.

- **IP Address Mode**—Defines the source of the IP address of this device. The IP address must be configured manually when set to Static. A DHCP server must be available for the radio to obtain a valid IP address when set to Dynamic. Only static IP addressing mode is available when VLAN Status is enabled [**Static; Static, Dynamic**]
- **Dynamic Mode**—Enabling this option forces the transceiver (AP or Remote) to obtain an IP address from any DHCP server available on the LAN. Dynamic Mode is also known as DHCP Client mode. [**Disabled**]
- **Static IP Address**—The IPv4 local IP address. It need not be defined if DHCP Client mode is enabled. [**192.168.1.1**]
- **Static IP Netmask**—The IPv4 local subnet mask. This value is used when the radio attempts to send a locally initiated message, either from the terminal server, or management process. You don't have to define it if DHCP Client mode is enabled. [**255.255.0.0**]
- **Static IP Gateway**—The IPv4 address of the default gateway device, typically a router. [**0.0.0.0**]

The lower three lines of the screen show the actual addressing at the transceiver, whether it was obtained from static configuration or from a DHCP server.

---

**NOTE:** Any change made to the above parameters results in the **Commit Changes** option appearing on screen. This allows all IP settings to be changed at the same time.

---

## 2.4.3 Ethernet Port Configuration Menu

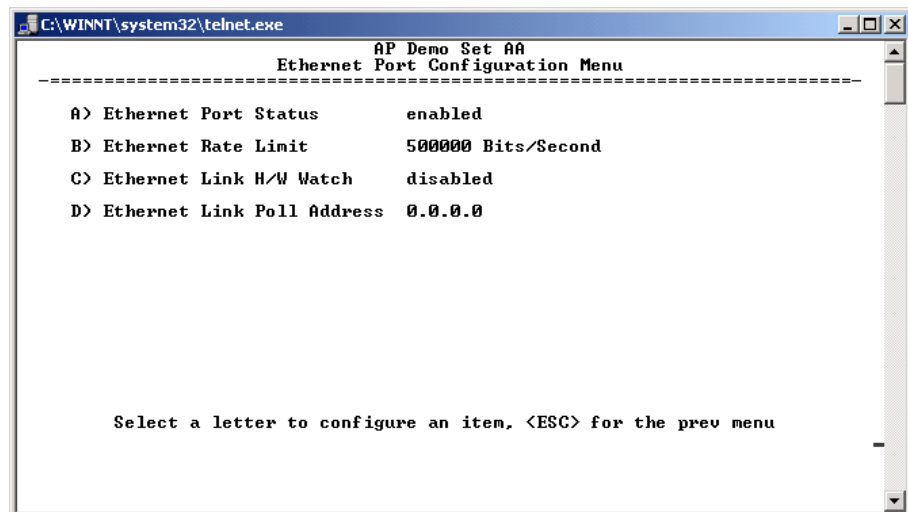
The transceiver allows for special control of the Ethernet interface, to allow traffic awareness and availability of the backhaul network for redundancy.

---

**NOTE:** The Ethernet port in iNET and iNET-II radios support 10BaseT connections only. This should not present a problem because most hubs/switches auto-switch between 10BaseT and 100BaseT connections. Confirm that your hub/switch is capable of auto-switching data rates.

To prevent Ethernet traffic from degrading performance, place the transceiver in a segment, or behind routers.

---



**Figure 2-20. Ethernet Port Configuration Menu**

- **Ethernet Port Status**— Allows enabling/disabling Ethernet traffic for security purposes. Setting it to **Follows Link Status** enables the port if there is a connection established with the AP, but disables it otherwise. [AP: **Enabled, Disabled; Enabled**] [Remote: **Always On, Follow Radio Link, Disabled; Always On**]
- **Ethernet Rate Limit**— The transceiver will send alarms (SNMP traps) when the rate reaches 50%, 75%, and 100% to help identify potential problems with traffic.

- **Ethernet Link (H/W) Watch** (*AP Only*)—Detects the lack of an Ethernet connection to the LAN port at the electrical level (link integrity). The current AP will broadcast a beacon signal indicating its “NOT AVAILABLE” status so Remotes that hear it do not try to associate to it. Once the Ethernet connection is restored, this beacon signal changes to “AVAILABLE” and Remotes are allowed to join in. [Disabled]
- **Ethernet Link Poll Address** (*AP Only*)—When an IP address is provided, the Access Point pings the remote IP device every 60 seconds to test the integrity of the backhaul link. If this link is not available, the AP will advertise its “NOT AVAILABLE” status in the beacon signal so Remotes do not try to associate to it. Once the IP address is reachable, this beacon signal changes to “AVAILABLE” and Remotes are allowed to join in. 0.0.0.0 disables this function. Any other valid IP address enables it. [0.0.0.0]

## 2.4.4 DHCP Server Configuration

A transceiver can provide automatic IP address assignments to other IP devices in the network by providing DHCP (Dynamic Host Configuration Protocol) services. This service eliminates setting individual device IP address on Remotes in the network, but it still requires thoughtful planning of the IP address range. One drawback to network-wide automatic IP address assignments is that SNMP services may become inaccessible as they are dependent on fixed IP addresses.

The network can be comprised of radios with the DHCP-provided IP address enabled or with DHCP services disabled. In this way, you can accommodate locations for which a fixed IP address is desired.

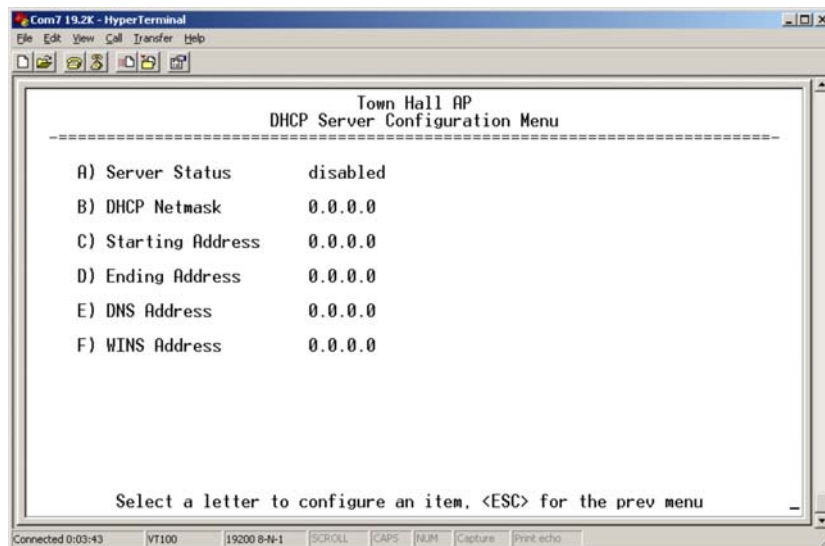


Figure 2-21. DHCP Server Configuration Menu



---

**NOTE:** There should be only one DHCP server active in a network (GE MDS iNET 900 or other DHCP server). If more than one DHCP server exists, network devices may randomly get their IP address from different servers every time they request one.

---

**NOTE:** Combining DHCP and RADIUS device authentication may result in a non-working radio module if the DHCP server is located at a remote radio. The DHCP server should be placed at the AP location, if possible.

---

- **Server Status**—Enable/Disable responding to DHCP requests to assign an IP address. [**Disabled/Enabled; Disabled**]
- **DHCP Netmask**—IP netmask to be assigned along with the IP address in response to a DHCP request. [**0.0.0.0**]
- **Starting Address**—Lowest IP address of the range of addresses to be provided by this device. [**0.0.0.0**]
- **Ending Address**—Highest IP address in the range of addresses to be provided by this device. A maximum of 256 addresses is allowed in this range. [**0.0.0.0**]
- **DNS Address**—Domain Name Server address to be provided by this service.
- **WINS Address**—Windows Internet Naming Service server address to be provided by this service.
- **Restart DHCP Server**—Selecting this option forces the transceiver to start servicing DHCP requests using the Starting Address. Payload data will not be interrupted but may experience some delays as new addresses are distributed.

## 2.4.5 SNMP Agent Configuration

The transceiver contains over 100 custom SNMP-manageable objects as well as the IETF standard RFC1213 for protocol statistics, also known as MIB II. Off-the-shelf SNMP managers such as Castle Rock Computing *SNMPC*<sup>™</sup> and Hewlett Packard HP *OpenView*<sup>™</sup> may also be used to access the transceiver's SNMP Agent's MIB. The transceiver's SNMP agent supports SNMPv3.

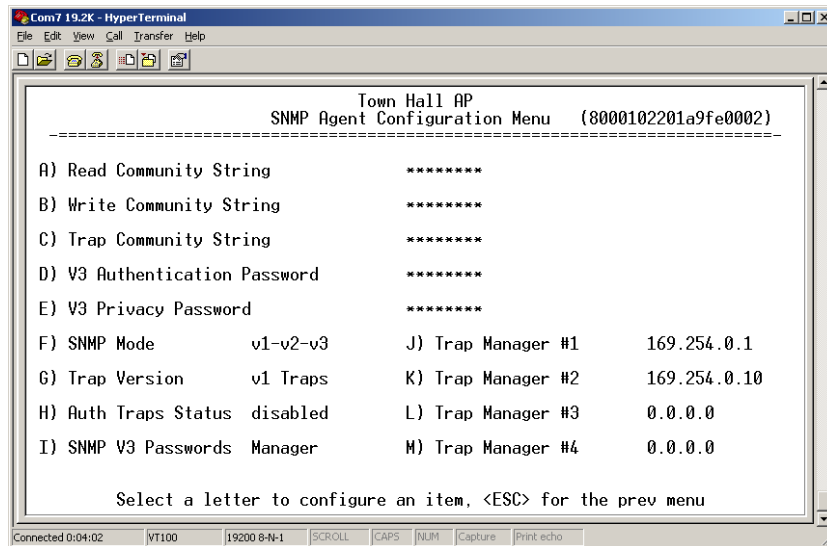
The objects are broken up into several MIB files. There are textual conventions, common files and specific files. This allows the flexibility to change areas of the MIB and not affect other existing installations or customers.

- **msdreg.mib**—GE MDS sub-tree registrations
- **MDS\_comm.mib**—GE MDS Common MIB definitions for objects and events which are common to the entire product family
- **inet\_reg.mib**—GE MDS sub-tree registrations
- **inettrv1.mib**—SNMPv1 enterprise-specific traps
- **inettrv2.mib**—SNMPv2 enterprise-specific traps

- **inet\_comm.mib**— MIB definitions for objects and events which are common to the entire iNET Series
- **inet\_ap.mib**—MIB definitions for objects and events for an Access Point transceiver
- **inet\_sta.mib**—Definitions for objects and events for a Remote radio
- **inet\_sec.mib**—For security management of the radio system. SNMPv3 allows read/write operation. SNMPv1/2 allows only for read-only access.
- **inet2.mib**—Additional objects specific to iNET-II.

**NOTE:** SNMP management requires that the proper IP address, network and gateway addresses are configured in each transceiver of the associated network.

In addition, some management systems may require the MIB files to be compiled in the order shown above.



**Figure 2-22. SNMP Server Configuration Menu**  
*From Access Point*

This menu provides configuration and control of vital SNMP functions.

- **Read Community String**—SNMP community name with SNMPv1/SNMPv2c read access. This string can be up to 30 alpha-numeric characters.
- **Write Community String**—SNMP community name with SNMPv1/SNMPv2c write access. This string can be up to 30 alpha-numeric characters.
- **Trap Community String**—SNMP community name with SNMPv1/SNMPv2c trap access. This string can be up to 30 alpha-numeric characters.

- **V3 Authentication Password**— Authentication password stored in flash memory. This is used when the Agent is managing passwords locally (or initially for all cases on reboot). This is the SNMPv3 password used for Authentication (currently, only MD5 is supported). This string can be up to 30 alpha-numeric characters.
- **V3 Privacy Password**— Privacy password stored in flash memory. Used when the SNMP Agent is managing passwords locally (or initially for all cases on reboot). This is the SNMPv3 password used for privacy (DES encryption). This string can be between 8 and 30 alpha-numeric characters.
- **SNMP Mode**— This specifies the mode of operation of the radio's SNMP Agent. The choices are: disabled, v1\_only, v2\_only, v3\_only, v1-v2, and v1-v2-v3. If the mode is disabled, the Agent does not respond to any SNMP traffic. If the mode is v1\_only, v2\_only, or v3\_only, the Agent responds only to that version of SNMP traffic. If the mode is v1-v2, or v1-v2-v3, the Agent responds to the specified version of SNMP traffic. [v1-v2-v3]
- **Trap Version**— This specifies what version of SNMP will be used to encode the outgoing traps. The choices are v1\_traps, v2\_traps, and v3\_traps. When v3\_traps are selected, v2-style traps are sent, but with a v3 header. [v1 Traps, v2 Traps, v3 Traps]
- **Auth Traps Status**— Indicates whether or not traps will be generated for login events to the transceiver. [Disabled/Enabled; Disabled]
- **SNMP V3 Passwords**— Determines whether v3 passwords are managed locally or via an SNMP Manager. The different behaviors of the Agent depending on the mode selected, are described in **SNMP Mode** above.
- **Trap Manager #1–#4**— Table of up to 4 locations on the network that traps are sent to. [Any standard IP address]

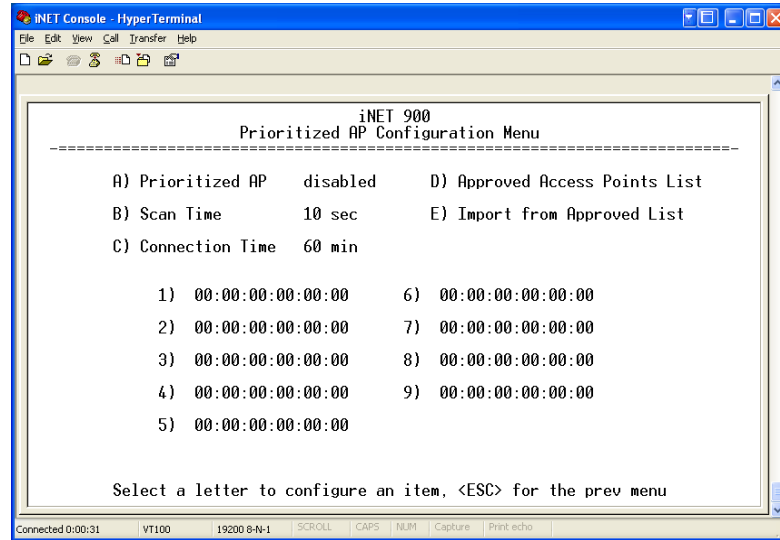
---

**NOTE:** The number in the upper right-hand corner of the screen is the SNMP Agent's SNMPv3 Engine ID. Some SNMP Managers may need to know this ID in order interface with the transceiver's SNMP Agent. The ID only appears on the screen when SNMP Mode is either v1-v2-v3 or v3\_only.

---

## 2.4.6 Prioritized AP Configuration Submenu

The Prioritized AP feature (Figure 2-23) allows the definition of a Primary AP to which a Remote radio should be connected.



**Figure 2-23. Prioritized AP Configuration Submenu**

- **Prioritized AP**— Shows status of the prioritization option. [enabled, disabled; disabled]
- **Scan Time**— Number of seconds that a Remote waits to receive beacons from an AP included in the Approved AP List. After this time, the list will be expanded to include the next entry and the cycle will be repeated until association is achieved.
- **Connection Time**— Amount of time that a Remote waits before breaking the connection and looking for an AP. This event happens only when the current AP is not the first entry in the Approved AP List, which means that the remote is not connected to the primary AP.
- **Approved Access Points List**— Displays the list of Approved AP used for local authentication purposes. This table is not the same as the Priority Table discussed here, and is only included as an aid to facilitate configuration.
- **Import from Approved List**— Copies the entries configured in the Approved AP List to this priority table.
- **1-10**— Priority Table of Access Points. This table should include the Wireless MAC Address of the desired Access Point units.

When association to an AP is terminated for any reason, the Remote enters Scanning mode. During this time it listens for beacons from an AP that matches the network name. If the Prioritized AP option is enabled, then the Wireless MAC Address of the AP must be part of the list at the remote. The initial list includes only the first entry of the table. If no beacon is received that matches the requirement and the Scan Time is exceeded, then the list is expanded to include the first two entries.

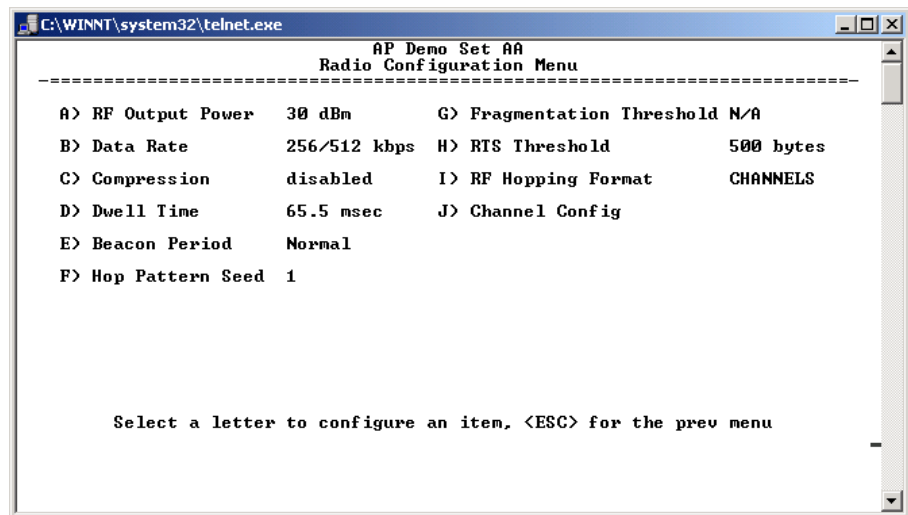
When a beacon matches the requirements, then the association process continues. It may be that the Remote associates to an AP that is not the first entry in the table. In this case the Remote will wait for Connection Time before breaking the connection and starting the process all over

again. This process will be repeated until the Remote associates to the first entry in the list (the Primary Access Point).

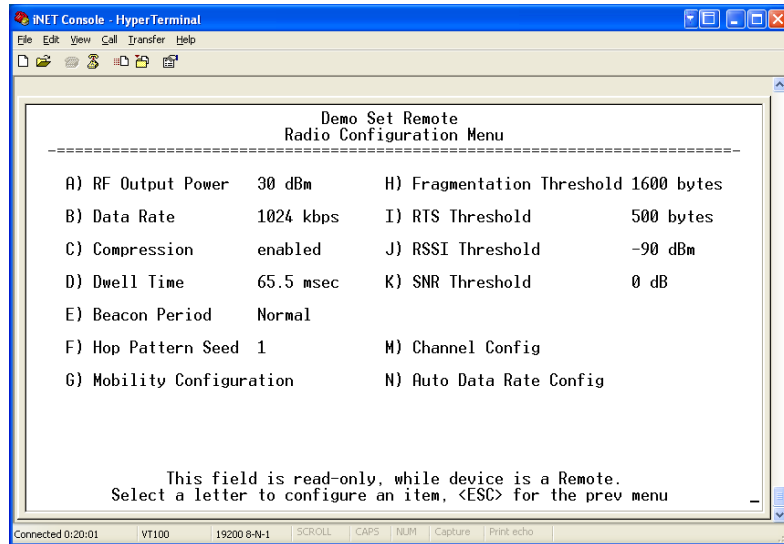
## 2.5 RADIO CONFIGURATION

There are two primary data layers in the transceiver network—radio and data. Since the data layer is dependent on the radio layer working properly, configuration of the radio items should be reviewed and set before proceeding. This section explains the *Radio Configuration Menu*, (Figure 2-24 for AP, Figure 2-25 for Remote).

### 2.5.1 Radio Configuration Menu



**Figure 2-24. Radio Configuration Menu**  
(From Access Point Unit)



**Figure 2-25. Radio Configuration Menu**  
(From Remote Unit)

- **RF Output Power**—Sets/displays RF power output level. Displayed in dBm. Setting should reflect local regulatory limitations and losses in antenna transmission line. (See “How Much Output Power Can be Used?” on Page 135 for information on how to calculate this value.)

[20–30; 20]

- **Data Rate**—Shows the over-the-air data rate setting for the Remote radio. Remotes can operate at one of two data rates when communicating with an AP: 1024 kbps (1 Mbps) or 512 kbps for iNET-II and 256 kbps or 512 kbps for iNET. The fastest data rate is possible with strong RF signal levels, typically stronger than –77 dBm RSSI including a 15 dB fade margin.

When the data rate is set to **AUTO**, the remote radio is able to change speeds based on the signal quality criteria set in the Auto Data Rate submenu described later in this section (see Page 55).

[iNET: 256, 512, **AUTO**; **AUTO**] [iNET-II: 512, 1024, **AUTO**; **AUTO**]

- **Compression** (*AP Only*)—Enabling this option uses LZO compression algorithm for over-the-air data. Varying levels of data reduction are achieved depending on the nature of the information. Text files are typically the most compressible, whereas binary files are the least compressible. On average, a 30% increase in throughput can be achieved with compression enabled.
- **Dwell Time**—Duration (in milliseconds) of one hop on a particular frequency in the hopping pattern. (This field is only changeable on an Access Point. Remotes get their value from AP upon association.)

[iNET: 16.4, 32.8, 65.5, 131.1, 262.1; 32.8]

[iNET-II: 8.2, 16.4, 32.8, 65.5, 131.1; 32.8]

**TIP:** If a packet is being transmitted and the dwell time expires, the packet will be completed before hopping to the next frequency.

- **Beacon Period**— Amount of time between Beacon transmissions (in msec).

Available Intervals: **Normal** (104 ms), **Fast** (52 ms), **Faster** (26 ms), **Slow** (508 ms), **Moderate** (208 ms). These values provide relatively quick association times where Fast is very fast ( $\approx 5$  sec) and the other end, the largest recommended value, the 508 ms period is slow ( $\approx 60$  sec). [**Normal, Fast, Faster, Slow, Moderate; Normal**]

**TIP:** Increasing the Beacon Period will provide a *small improvement* in network data throughput. Shortening it decreases the time needed for Remotes to associate with the AP. A short beacon period is usually only a benefit when there are mobile Remotes in the network.

- **Hop Pattern Seed**— A user-selectable value to be added to the hop pattern formula. This is done in the unlikely event that identical hop patterns are used with two collocated or nearby networks. Changing the seed value will minimize the potential for RF-signal collisions in these situations. (This field is only changeable on an Access Point. Remotes read the AP's value upon association.) [**0 to 255; 1**]
- **Mobility Configuration**— This selection brings up a submenu where parameters related to mobile operation may be set. For details, See “Mobility Configuration Menu” on Page 58.
- **Fragment Threshold**— Before transmitting over the air, if a packet exceeds this number of bytes, the transceiver sends the packet in multiple fragments that are reassembled before being delivered over the Ethernet interface at the receiving end. Only even numbers are acceptable entries for this parameter. Over-the-air data fragmentation is not supported on AP units. (See “PERFORMANCE NOTES” on Page 144 for additional information.) [**256–1600 bytes; 1600**]

**TIP:** In an interference-free environment this value should be large to maximize throughput. If interference exists then the value should be set to smaller values. The smaller the packet the less chance of it being interfered with at the cost of slightly reduced throughput.

- **RTS Threshold**— Number of bytes for the over-the-air RTS/CTS handshake boundary. (See “PERFORMANCE NOTES” on Page 144.) [**0 to 1600 bytes; 500**]

---

**NOTE:** While the transceiver accepts RTS Threshold settings below 100, the lowest functioning value is 100.

---

**TIP:** Lower the **RTS Threshold** as the number of Remotes or overall over-the-air traffic increases. Using RTS/CTS is a trade-off, giving up some throughput in order to prevent collisions in a busy over-the-air network.

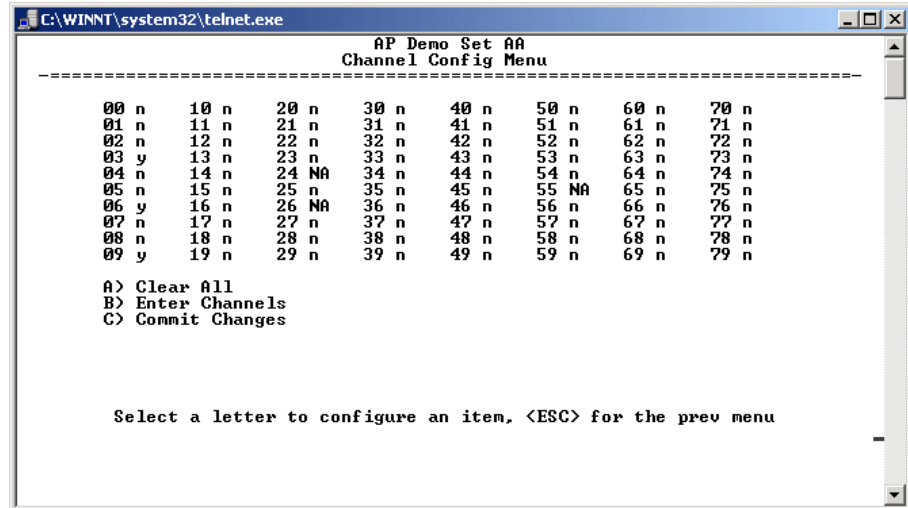
The **RTS Threshold** should be enabled and set with a value smaller than the **Fragmentation Threshold** described above. RTS forces the Remotes to request permission from the AP before sending a packet. The AP sends a CTS control packet to grant permission to one Remote. All other Remotes wait for the specified amount of time before transmitting.

- **RSSI Threshold (for alarm)**—Level (dBm) below which the received signal strength is deemed to have degraded, and a critical event (alarm) is generated and logged. Under these conditions, the PWR lamp flashes, and an SNMP trap is sent to the configured SNMP manager. [0 to -120; -90]
- **SNR Threshold (for alarm)**—Value (dB) below which the signal-to-noise ratio is deemed to have degraded and a critical event is generated and logged. Under these conditions, the PWR lamp flashes, and an SNMP trap is sent to the configured SNMP manager. [0 to 40; Not Programmed]
- **Channel Config** (*Only applies to iNET-II*)—Brings up the submenu discussed in Channel Config Menu on Page 55.
- **RF Hopping Format** (*Only applies to iNET*)—This option must be specified when the order is placed and cannot be modified in the field by the user. Operation must be compliant with country-specific restrictions. The available formats are:
  - **ISM:** 902–928 MHz band
  - **GSM:** 915–928 MHz band
  - **SPLIT:** 902-907.5 and 915-928 MHz bands
  - **CHANNELS:** 902–928 MHz, individual channels selectable within this range
- **Skip Zones** (*Only applies to iNET. Editable at AP Only.*)—This selection brings up a submenu discussed in Skip Zones Menu on Page 56.
- **Auto Data Rate Configuration**—This selection brings up a submenu as shown in Figure 2-28. For the settings in this submenu to have any effect, the Data Rate menu item (Page 52) must be set to **AUTO**.

## 2.5.2 Channel Config Menu

The Channel Configuration menu displays the utilization of channels in the 902–928 MHz range. This selection is available only on iNET-II or specially provisioned iNET units. The radio hops only on the channels selected in this menu.





**Figure 2-26. Channel Config Submenu**

Key to channel indicators:

n (no) = Radio channel is not used

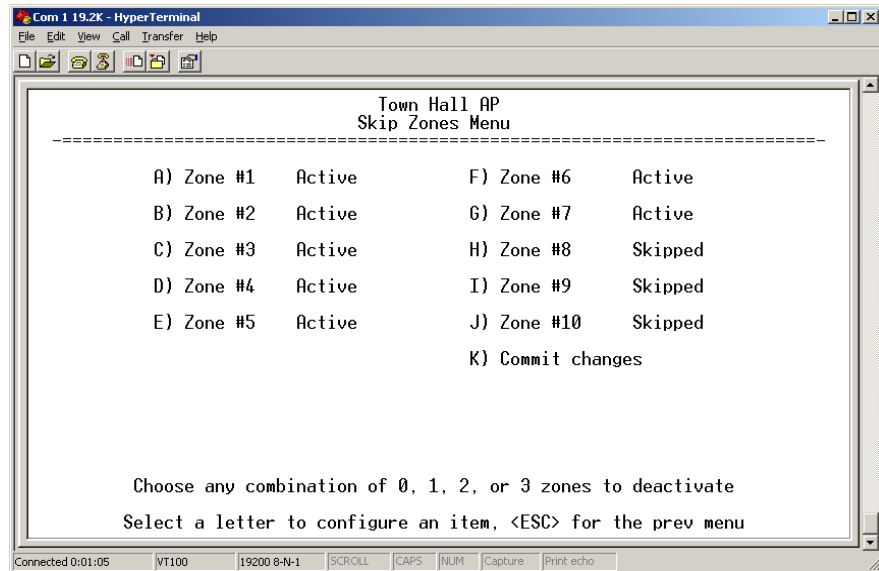
y (yes) = Radio channel is used

NA (not available) = Radio channel is not available

- **Clear All**—This command clears all entries in the Channel Config Menu, resetting the available channels to “no usage.” Channels that are not available for use will appear with a notation of or **NA**. These channels are not available because of pre-existing conditions, and are not user-configurable.
- **Enter Channels**—This allows selection of the channels used for frequency hopping operation. *The selection of particular channels will result in an indication of y. Be aware that these channels do not become active until the **Commit Changes** selection is invoked.*
- **Commit Changes**—This re-boots the radio and loads the active channels into the frequency list for frequency hopping operation.

### 2.5.3 Skip Zones Menu

- **Skip Zones** (*Does not apply to iNET-II. Editable at AP Only.*)—This selection brings up a submenu (Figure 2-27) that displays the current utilization of zones. Each zone consists of eight RF channels. In some instances there may be a part of the spectrum used by another system, that results in “continuous” or “persistent” interference to your system. To alleviate this form of interference, the transceiver may be programmed to “block out” affected portions of the spectrum using the Skip Zones Menu.



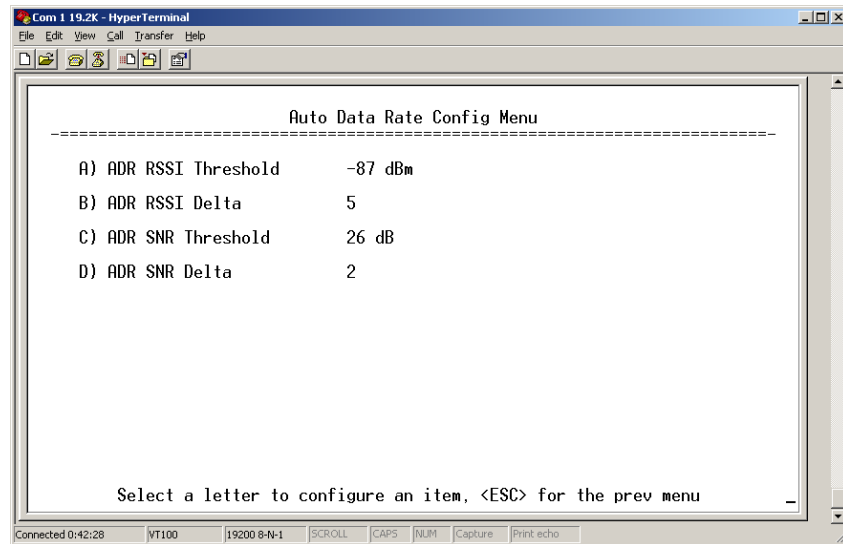
**Figure 2-27. Skip Zone Options Submenu—GE MDS iNET Only**  
*(“Commit changes” displayed only on Access Point radios)*

Figure 2-27 displays the utilization of 10 zones, each having eight RF operating frequencies. Zones can be toggled between **Active** and **Skipped** at Access Point units by first keying in the letter of the zone to be changed, and then pressing the spacebar to toggle between the two options for each zone. Select the **Commit Changes** menu item to implement changes. These changes will be forwarded to all units in the network through the Access Point’s beacon signal.

With an iNET radio (non-iNET-II), a maximum of three zones can be skipped and still be compliant with FCC regulations.

## 2.5.4 Auto Data Rate Configuration Menu

The Auto Data Rate Configuration submenu is typically for use in environments where signal quality is variable, and you wish to maintain the highest possible over-the-air data rate as conditions change.



**Figure 2-28. Auto Data Rate Submenu**

- **ADR RSSI Threshold**—A specified received signal strength value, which, if exceeded by the range of the **RSSI Delta** setting, causes a data rate change in the transceiver. [-50 to -100; -87 dBm]
- **ADR RSSI Delta**—A user-specified *difference* from the **RSSI Threshold** figure which, if exceeded, causes a data rate change in the transceiver. [0-10; 5]
- **ADR SNR Threshold**—A user-specified signal-to-noise ratio, which, if exceeded by the range of the **SNR Delta** setting, causes a data rate change in the transceiver. [10-30; 26]
- **ADR SNR Delta**—A user-specified *difference* from the **SNR Threshold** figure which, if exceeded, causes a data rate change in the transceiver. [0-10; 2]

**NOTE:** In the description below, “high speed” refers to 512 kbps for the iNET radio and 1 Mbps for the iNET-II radio.

“Standard speed” refers to 256 kbps for the iNET radio and 512 kbps for the iNET-II.

Using the example of Figure 2-28, assume the current RSSI is -87 dBm. An RSSI reduction of more than 5 dBm (more negative RSSI number) would cause a data rate change from high speed to standard speed. Once the data speed has changed to standard speed, an RSSI *increase* to the level of -82 dBm would be required for the radio to switch back to high speed. This provides an operational “window” or hysteresis range over which the data speed stays constant despite minor changes in signal strength.

The SNR (signal-to-noise ratio) threshold and delta operate in the same manner described above, with the exception that the units are expressed in relative dB instead of dBm. In the example of Figure 2-28, a drop of 2 dB from a level of 26 dB would result in a data rate change from high speed to standard speed. For the radio to return to high speed, the SNR would need to increase to 28 dB. (*See Glossary for definition of SNR.*)

RSSI or SNR figures alone mean little when determining signal quality. Both parameters must be considered to get a true understanding of signal quality. For example, a strong, but noisy signal would likely be less useful than a weak signal with low noise levels. Proper use of the threshold and delta settings will result in smoother, more reliable performance from your wireless link.

Figure 2-28 shows the default values for RSSI and SNR parameters but these may be changed to optimize performance in your environment. In properly designed systems, experience has shown that RSSI levels between -50 dBm and -90 dBm provide reliable operation, provided the signal-to-noise ratio is 17 dB or above. Tailoring the thresholds with these baseline values in mind, can provide improved performance in your system.

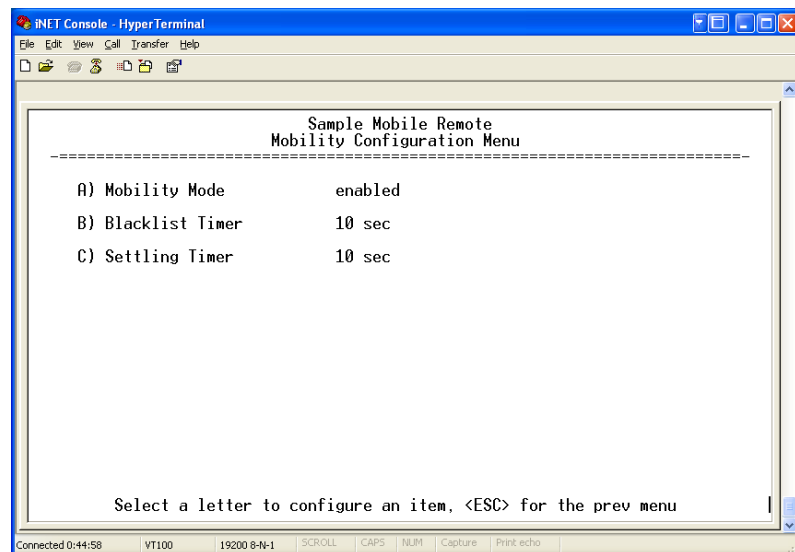
---

**NOTE:** The RSSI is an average of the last 20 RSSI samples. The RSSI value is reset every time the radio returns to scanning mode.

---

## 2.5.5 Mobility Configuration Menu

A mobile environment requires special considerations that are not a factor in fixed installations. Use the following menu to set Remote radios for mobile operation.



**Figure 2-29. Mobility Screen Showing Blacklist Timer Value**

- **Mobility Mode**—Selects whether or not mobility-specific parameters are active. [**enabled, disabled; disabled**]
- **Blacklist Timer**—Sets/displays the number of seconds an AP stays on the blacklist after association is lost. [**10-120; 10**]
- **Settling Timer**—Sets/displays the number of seconds the radio waits before evaluating the signal quality of a newly acquired AP. [**5-120; 10**]

After association is lost with an AP, and scanning for an alternate AP is started, the former AP is placed on a “blacklist” to avoid linking immediately back to the same AP. If no alternate AP is found, a link will be attempted with the same AP as before.

An Access Point is added to the blacklist when the Remote detects that the RSSI has dropped below the **RSSI Threshold** set in the Radio Configuration menu and should try to find an alternate AP to connect to.

An Access Point is removed from the blacklist table when it has been in the table longer than the time set by the **Blacklist Timer**.

### **Additional Considerations for Mobile Operation**

The following key points should be considered for all mobile installations:

- **Use middleware**—The use of middleware in the mobile laptops is highly recommended for better operation of a mobile data system. GE MDS provides middleware from one of the vendors in this market. Contact your GE MDS representative for details.
- **Plan your network coverage**—Deploy Access Points so that they provide overlapping coverage to each other. Access Points must use the same network name to enable roaming
- **Set the Remote radios to the lower speed** (512 kbps for iNET-II, 256 kbps for iNET) to optimize coverage
- **Set the RSSI Threshold to -85 dBm**—This level is typically used for mobile systems with good performance. Make sure there is overlapping coverage of more than one AP to provide a good user experience and continuous coverage.

### **At Every Mobile (Remote) Radio**

- **Fragmentation Threshold [256]**—Set to a small value. This parameter defines the size of the message packets transmitted over the wireless media. These fragments are reconstructed into the original packet before delivery to the external device at the remote end of the link. In a mobile environment with rapidly changing conditions, setting this value to a minimum value improves the probability of packets being sent complete on the first try.

## At Every AP Radio

Parameter settings that should be reviewed for AP radios providing service to mobile remotes:

- **Compression [disabled]**—Disable radio compression. Data compression is best performed by the middleware running on the mobile laptop PC. Gains in efficiency are made because middleware compresses data at a higher stack level, and it aggregates multiple data frames and streams into a single packet. Compression at the radio level, although highly efficient, works at the individual packet level.
- **Dwell Time [Set to the minimum value]**—This setting controls the amount of time that the unit spends on each frequency between hops. Although overall throughput appears to decrease by this setting the effects of multipath fading are minimized through frequency diversity.
- **Beacon Period [Set to the fastest value]**—This parameter defines the interval at which the Access Point transmits a synchronization beacon to all remotes. A faster setting minimizes resynchronization times when remote radios roam between access points or in highly interrupted coverage areas (dense buildings, for example).
- **RTS Threshold [0 -1600 bytes]**—Enable RTS flow at a small value. This setting is a wireless equivalent to RTS/CTS flow control in a wired communications circuit. This mechanism prevents packet collisions caused by the “Hidden Node” scenario, in which remotes can’t hear each other before transmitting. When this value is set below 100 or above 1500, it is effectively disabled.

## 2.6 CONFIGURING THE SERIAL PORTS

### 2.6.1 Overview

The transceiver includes an embedded serial device server that provides transparent encapsulation over IP. In this capacity, it acts as a gateway between serial and IP remote devices. Two common scenarios are PC applications using IP to talk to remote devices, and serial PC applications talking to remote serial devices over an IP network.

Essentially the same data services are available for both serial ports: COM1 and COM2. Note that the transceiver’s COM1 port is DCE and COM2 is DTE. Therefore, if the RTU to be connected is also DTE, then a null-modem cable will need to be used when connecting to COM2.

---

**NOTE:** In the discussion that follows, COM1 and COM2 will be treated alike unless noted.

---

### **Com1 Port—Dual Purpose Capability**

The COM1 port is used as a local console connection point and to pass serial data with an external device. Setting the COM1 port status to **Enable** prevents access to the Management System (MS) through this port. However, the MS can still be accessed via the LAN port using Telnet or a web browser.

To restore the COM1 port to support Management System services, connect a terminal to the port, select the proper baud rate (19,200 is default), and enter an escape sequence (+++) to reset it to the console mode.

### **TCP vs. UDP**

Both types of IP services are used by the transceiver embedded serial device server—TCP and UDP. TCP provides a connection-oriented link with end-to-end acknowledgment of data, but with some added overhead. UDP provides a connectionless best-effort delivery service with no acknowledgment.

Most polled protocols will be best served by UDP service as the protocol itself has built-in error recovery mechanisms. UDP provides the needed multidrop operation by means of multicast addressing.

On the other hand, TCP services are best suited for applications that do not have a recovery mechanism (error-correction) and must have the guaranteed delivery that TCP provides despite the extra overhead. The IP-to-Serial example shows how to do this. (See “IP-to-Serial Application Example” on Page 72.)

### **Serial Encapsulation**

Transparent encapsulation, or IP tunneling, provides a mechanism to encapsulate serial data into an IP envelope. Basically, all the bytes received through the serial port are put into the data portion of a TCP or UDP packet (TCP or UDP are user configurable options). In the same manner, all data bytes received in a TCP or UDP packet are output through the serial port.

When data is received by the radio through the serial port it is buffered until the packet is received completely. There are two events that signal an end-of-packet to the radio: a period of time since the last byte was received, or a number of bytes that exceed the buffer size. Both of these triggers are user configurable.

One radio can perform serial data encapsulation (IP-to-Serial) and talk to a PC. Two radios (or one radio and a terminal server) can be used together to provide a serial-to-serial channel.

### **TCP Client vs. TCP Server**

A TCP session has a server side and a client side. You can configure the transceiver to act as a server, a client, or both.

TCP servers listen and wait for requests from remote TCP clients to establish a session. A TCP client is a program running on a device other than the TCP server. Alternately, TCP clients actively attempt to establish a connection with a TCP server. In the case of the transceiver, this happens whenever data is received on the serial port.

The transceiver operates in either client or server mode, depending on which event occurs first, either receiving data on the serial port, or receiving a request to open a TCP connection from a remote client.

The transceiver keeps a TCP session open until internal timers that monitor traffic expire. Once a TCP session is closed, it must be opened again before traffic can flow.

### **UDP Multicast**

IP provides a mechanism to do a limited broadcast to a specific group of devices. This is known as “multicast addressing.” Many IP routers, hubs and switches support this functionality.

Multicast addressing requires the use of a specific branch of IP addresses set apart by the Internet Assigned Numbers Authority (IANA) for this purpose.

UDP multicast is generally used to transport polling protocols typically used in SCADA applications where multiple remote devices will receive and process the same poll message.

As part of the Multicast implementation, the radio sends IGMP membership reports and IGMP queries, and responds to membership queries. It defaults to V2 membership reports, but responds to both V1 and V2 queries.

You must configure the multicasted serial port as the target for the multicast data (for example, multipoint-to-multipoint mode, or point-to-multipoint mode where the inbound data is multicast). This restriction is because a host that only sends data to a multicast address (for example, point-to-multipoint mode where the iNET acts as a point) will not join the group to receive multicast data because the host’s inbound data is directed unicast data.



The serial-to-serial example which follows shows how to provide multicast services. (See “Point-to-Multipoint IP-to-Serial Application Example” on Page 73.)

## PPP

External devices can connect to the transceiver using PPP (Point-to-Point Protocol). The transceiver works as a server and assigns an IP address to the device that connects through this interface.

To gain access to the transceiver from a PC even if the network is down, a modem may be connected to one of the transceiver’s COM ports that has been configured with PPP.

## Data Buffering

Data buffering is always active regardless of the selected mode. When Seamless mode is selected, a buffer size of 256 bytes is used. When custom mode is selected, the size options are: 16, 32, 64, 128, and 256 bytes. The Inter-Frame Delay is settable in either Seamless or Custom modes.

## Implementing Configuration Changes

There are several configuration parameters for the Serial Gateway found under the *Serial Configuration Menu* of the Management System. After making changes to the configuration, you must use the menu’s “Commit Changes” to assert the changes.

If you are connecting EIA-232 serial devices to the transceiver, review these parameters carefully.

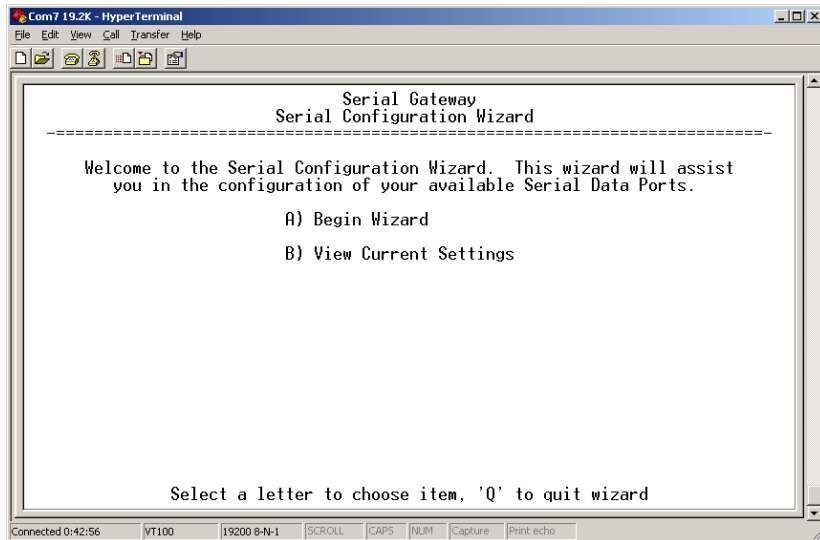
## Serial Configuration Wizard

The Serial Configuration Wizard available through the **Serial Gateway Configuration Menu** is recommended for configuration of serial ports. The wizard uses a step-by-step process, will eliminate possible conflicting settings, and streamline complex configurations.

The wizard can be bypassed by selecting option **B) View Current Settings** and adjusting the individual settings of the appropriate parameter

## 2.6.2 Serial Data Port Configuration Menu

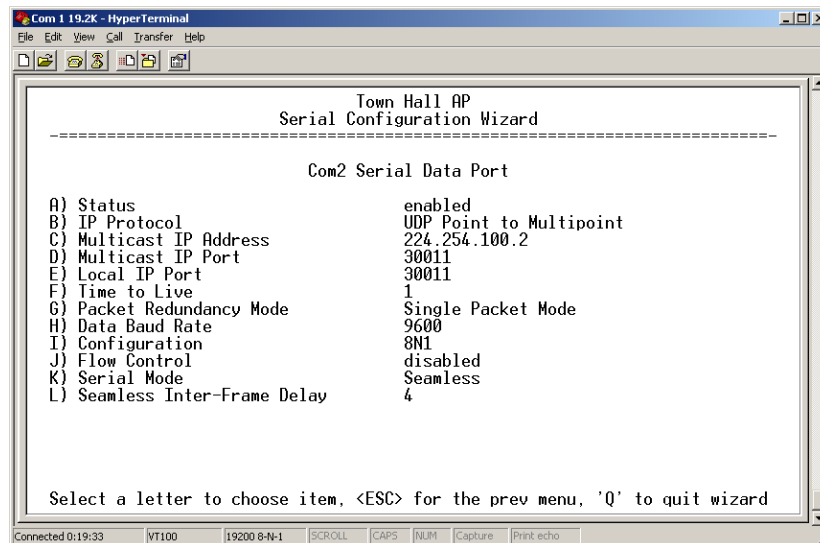
The first two menu items present the identical parameter fields for each port with one exception—Flow Control. This is available only on COM2.



**Figure 2-30. Serial Configuration Wizard**

- **Begin Wizard**—Tool for configuration of serial ports using a step-by-step process.
- **View Current Settings**—Displays all settable options. Depending on the selected IP protocol.

### 2.6.3 Configuring for UDP Mode



**Figure 2-31. UDP Point-to-Multipoint Menu**

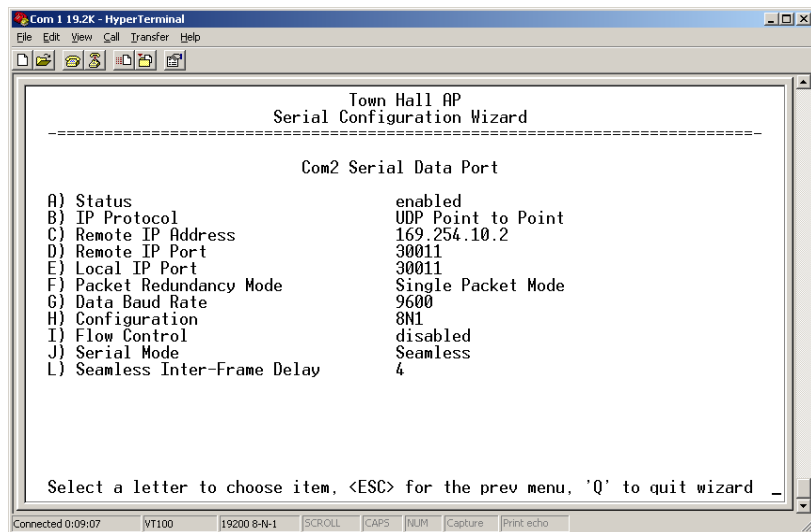
Use UDP point-to-multipoint to send a copy of the same packet to multiple destinations, such as in a polling protocol.

- **Status**—Enable/Disable the serial data port.

- **IP Protocol**—Point to Multipoint [TCP, UDP PPP; TCP]. This is the type of IP port that will be offered by the transceiver's serial device server.
- **Multicast IP Address** (used instead of **Local IP Address** when using UDP Point-to-Multipoint.)— Must be configured with a valid Class D IP address (224.0.0.0–239.255.255.255). IP packets received with a matching destination address will be processed by this unit [Any legal IP address; 0.0.0.0].
- **Multicast IP Port** (used instead of **Local IP Port** when using UDP Point-to-Multipoint.)— This port number must match the number used by the application connecting to local TCP or UDP socket. [1-64,000; COM1: 30010, COM2: 30011]
- **Local IP Port**—Receive IP data from this source and pass it through to the connected serial device. The port number must be used by the application connecting to local TCP or UDP socket. [Any valid IP port; COM1: 30010, COM2: 30011]
- **Time to Live (TTL)**—An IP parameter defining the number of hops that the packet is allowed to traverse. Every router in the path will decrement this counter by one.
- **Packet Redundancy Mode**— For proper operation, all radios' Serial Packet Redundancy mode must match (Single Packet mode vs. Packet Repeat mode). This is because a transceiver, when in Packet Repeat mode, sends 12 extra characters (sequence numbers, etc.) to control the delivery of the repeated data. Misconfigurations can result in undesired operation.
- **Data Baud Rate**—Data rate (payload) for the COM port in bits-per-second. [1,200–115,200; 19200]
- **Configuration**—Formatting of data bytes, representing data bits, parity and stop bits. [7N1, 7E1, 7O1, 8N1, 8E1, 8O1, 8N1, 7N2, 7E2, 7O2, 8N2, 8E2, 8O2; 8N1]
- **Flow Control [Com2 Only]**—RTS/CTS handshaking between the transceiver and the connected device. [Enable, Disable; Disabled]
- **Serial Mode**—When seamless mode is selected data bytes entering the serial data port are sent over the radio link without delay, but the receiving end will buffer the data until enough bytes have arrived to cover worst-case gaps in transmission. The delay introduced by data buffering may range from 22 to 44 ms, but the radio will not create any gaps in the *output* data stream. This permits operation with protocols such as MODBUS™ that do not allow gaps in their data transmission. [Seamless, Custom; Seamless]
- **Seamless Inter-Frame Delay**— Amount of time (in number of characters) that signal the end of a message (inter-character time-out). UDP packet sizes are delimited and sent out based on the Seamless Inter-Frame Delay only when receiving data through the serial port. MODBUS defines a “3.5-character” setting. [1–65,535; 4]

TIP: To convert this delay into milliseconds, multiply the number of characters configured here by 10 (there are usually 10 bits in each byte) and divide the result by the data rate of the serial port (in kbps).

- **Custom Data Buffer Size** (Custom Packet Mode only)—Maximum amount of characters, that the Remote end will buffer locally before starting to transmit data through the serial port. [16, 32, 64, 128, 256; 32]
- **Commit Changes and Exit Wizard**—Save and execute changes made on this screen (Shown only after changes have been entered.)



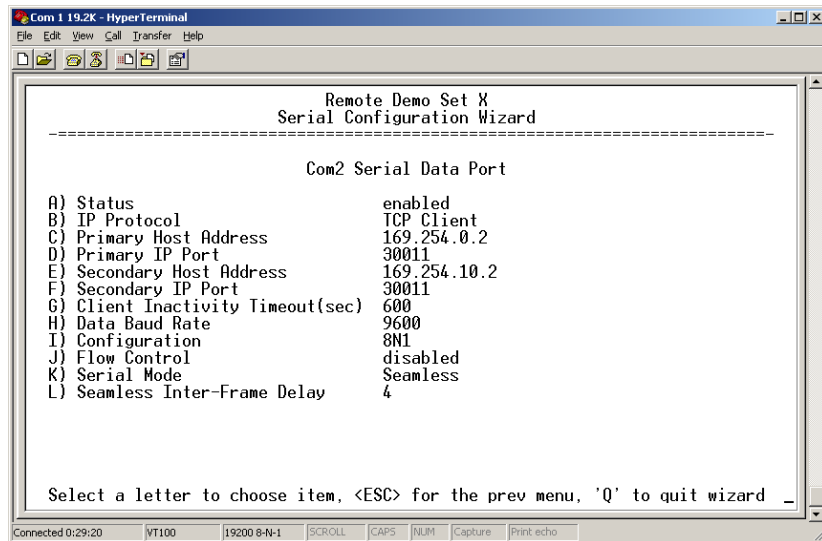
**Figure 2-32. UDP Point-to-Point Menu**

Use UDP point-to-point configuration to send information to a single device.

- **Status**—Enable/Disable the serial data port.
- **IP Protocol**—UDP Point-to-Point. This is the type of IP port that will be offered by the transceiver's serial device server. [TCP, UDP, PPP; TCP]
- **Remote IP Address**—Data received through the serial port is sent to this IP address. To reach multiple Remotes in the network, use UDP Point-to-Multipoint. [Any legal IP address; 0.0.0.0]
- **Remote IP Port**—The destination IP port for data packets received through the serial port on the transceiver. [1–64,000; COM1: 30010, COM2: 30011]
- **Local IP Port**—Port number where data is received and passed through to the serial port. This port number must be used by the application connecting to this transceiver. [1–64,000; COM1: 30010, COM2: 30011]

- **Packet Redundancy Mode**— For proper operation, all radios' Serial Packet Redundancy mode must match (Single Packet mode vs. Packet Repeat mode). This is because a transceiver, when in Packet Repeat mode, sends 12 extra characters (sequence numbers, etc.) to control the delivery of the repeated data. Misconfigurations can result in undesired operation.
- **Data Baud Rate**— Data rate (payload) for the COM port in bits-per-second. [1,200–115,200; 19200]
- **Configuration**— Formatting of data bytes. Data bits, parity and stop bits [7N1, 7E1, 7O1, 8N1, 8E1, 8O1, 8N1, 7N2, 7E2, 7O2, 8N2, 8E2, 8O2; 8N1].
- **Flow Control (COM2 only)**— RTS/CTS handshaking between the transceiver and the connected device. [Enable, Disable; Disabled]
- **Serial Mode**— When seamless mode is selected, data bytes will be sent over the air as quickly as possible, but the receiver will buffer the data until enough bytes have arrived to cover worst case gaps in transmission. The delay introduced by data buffering may range from 22 to 44 ms, but the radio will not create any gaps in the output data stream. This mode of operation is required for protocols such as MOD-BUS™ that do not allow gaps in their data transmission. [Seamless, Custom; Seamless]
- **Seamless Inter-Frame Delay**— Number of characters that represent the end of a message (inter-character time-out). MOD-BUS defines a “3.5-character” parameter. [1–65,535; 4]
- **Custom Data Buffer Size (Custom Packet Mode only)**— Maximum amount of characters, that the Remote end will buffer locally before starting to transmit data through the serial port. [16, 32, 64, 128, 256; 32]
- **Commit Changes and Exit Wizard**— Save and execute changes made on this screen (Shown only after changes have been entered.)

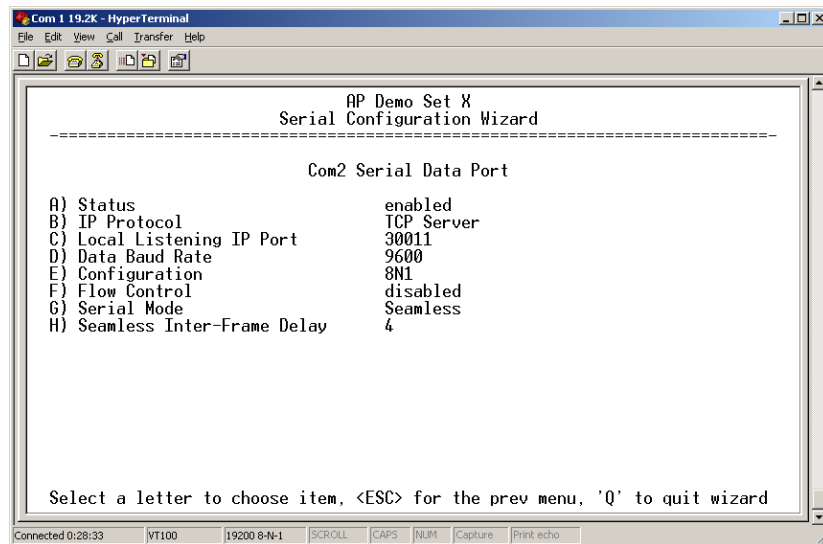
## 2.6.4 Configuring for TCP Mode



**Figure 2-33. TCP Client Menu (Remote)**

- **Status**— Enable/Disable the serial data port.
- **IP Protocol**— TCP Client. This is the type of IP port that will be offered by the transceiver's serial device server. [TCP, UDP, PPP, TCP]
- **Primary Host Address**— The IP address to be used as a destination for data received through the serial port. [Any legal IP address; 0.0.0.0]
- **Primary IP Port**— The destination IP port for data packets received through the serial port on the transceiver. [Any valid IP port; COM1: 30010, COM2: 30011]
- **Secondary Host Address**— The IP address to be used as a destination for data received through the serial port in case the primary host address is not available. [Any legal IP address; 0.0.0.0]
- **Secondary IP Port**— The destination IP port for data packets received through the serial port on the transceiver used along with the secondary host address above. [Any valid IP port; COM1: 30010, COM2: 30011]
- **Client Inactivity Timeout (sec)**— Amount of time (in seconds) that the transceiver will wait for data before terminating the TCP session. [0–600; 600]
- **Data Baud Rate**— Data rate (payload) for the COM port in bits-per-second. [1,200–115,200; 19200]
- **Configuration**— Interface signaling parameters. Data bits, parity and stop bits [7N1, 7E1, 7O1, 8N1, 8E1, 8O1, 8N1, 7N2, 7E2, 7O2, 8N2, 8E2, 8O2; 8N1].
- **Flow Control [Com2 Only]**— RTS/CTS handshaking between the transceiver and the connected device. [Enable, Disable; Disabled]

- **Serial Mode**— If data buffering is Enabled, the radio will operate in seamless mode. Data bytes will be sent over the air as quickly as possible, but the receiver will buffer the data until enough bytes have arrived to cover worst case gaps in transmission. The delay introduced by data buffering may range from 22 to 44 ms, but the radio will not create any gaps in the output data stream. This mode of operation is required for protocols such as MODBUS™ and some variants which do not allow gaps in their data transmission.  
[Seamless, Custom; Seamless]
- **Seamless Inter-Frame Delay**— Number of characters that represent the end of a message (inter-character time-out). MODBUS defines a “3.5-character” parameter.  
[1–65,535; 4]
- **Custom Data Buffer Size** (Custom Packet Mode only)—Maximum amount of characters, that the Remote end will buffer locally before starting to transmit data through the serial port.  
[16, 32, 64, 128, 256; 32]
- **Commit Changes and Exit Wizard**— Save and execute changes made on this screen (Shown only after changes have been entered.)



**Figure 2-34. TCP Server Menu (AP)**

- **Status**— Enable/Disable the serial data port.
- **IP Protocol**— TCP Server. This is the type of IP port that will be offered by the transceiver’s serial device server.  
[TCP, UDP, PPP; TCP]
- **Local Listening IP Port**— Receive IP data from this source and pass it through to the connected serial device. The port number must be used by the application connecting to local TCP or UDP socket.  
[Any valid IP port; COM1: 30010, COM2: 30011]

- **Data Baud Rate**—Data rate (payload) for the COM port in bits-per-second. [1,200–115,200; 19200]
- **Configuration**—Interface signaling parameters. Data bits, parity and stop bits [7N1, 7E1, 7O1, 8N1, 8E1, 8O1, 8N1, 7N2, 7E2, 7O2, 8N2, 8E2, 8O2; 8N1].
- **Flow Control (COM2 only)**—RTS/CTS handshaking between the transceiver and the connected device. [Enable, Disable; Disabled]
- **Serial Mode**— If data buffering is Enabled, the radio will operate in seamless mode. Data bytes will be sent over the air as quickly as possible, but the receiver will buffer the data until enough bytes have arrived to cover worst case gaps in transmission. The delay introduced by data buffering may range from 22 to 44 ms, but the radio will not create any gaps in the output data stream. This mode of operation is required for protocols such as MODBUS™ and some variants which do not allow gaps in their data transmission. [Seamless, Custom; Seamless]
- **Seamless Inter-Frame Delay**— Number of characters that represent the end of a message (inter-character time-out). MODBUS defines a “3.5-character” parameter. [1–65,535; 4]
- **Custom Data Buffer Size (Custom Packet Mode only)**— Maximum amount of characters, that the Remote end will buffer locally before starting to transmit data through the serial port. [16, 32, 64, 128, 256; 32]
- **Commit Changes and Exit Wizard**— Save and execute changes made on this screen (Shown only after changes have been entered.)

## 2.6.5 Configuring for PPP Mode

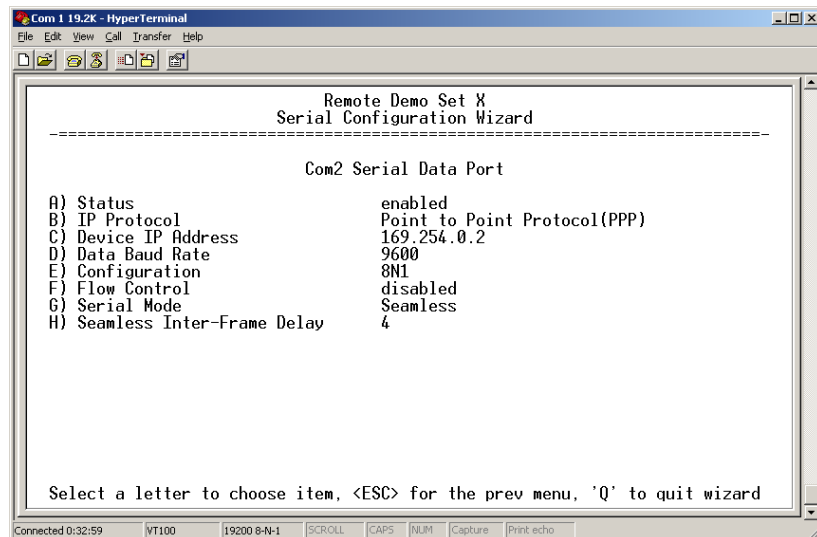


Figure 2-35. PPP Menu



- **Status**—Enable/Disable the serial data port.
- **IP Protocol**—PPP. This is the type of IP port that will be offered by the transceiver's serial device server. [**TCP, UDP, PPP; TCP**]
- **Device IP Address**—IP address that will be assigned to the dialing device once the connection is established. [**0.0.0.0**]
- **Data Baud**—The baud rate of the serial port of the transceiver to which the external device is connected.  
[**1200, 2400, 4800, 9600, 19200, 38400, 57600, 115200; 19200**]
- **Configuration**—Byte format of the serial port  
[**7N1, 7E1, 7O1, 7N2, 7E2, 7O2, 8N1, 8O1, 8N2, 8E2, 8O2; 8N1**]
- **Flow Control (COM2 only)**—RTS/CTS handshaking between the transceiver and the connected device.  
[**Enable, Disable; Disabled**]
- **Serial Mode**—When seamless mode is selected, data bytes will be sent over the air as quickly as possible, but the receiver will buffer the data until enough bytes have arrived to cover worst case gaps in transmission. The delay introduced by data buffering may range from 22 to 44 ms, but the radio will not create any gaps in the output data stream. This mode of operation is required for protocols such as MODBUS™ that do not allow gaps in their data transmission. [**Seamless, Custom; Seamless**]
- **Seamless Inter-Frame Delay**—Number of characters that represent the end of a message (inter-character time-out). MODBUS defines a “3.5-character” parameter. [**1–65,535; 4**]
- **Custom Data Buffer Size (Custom Packet Mode only)**—Maximum amount of characters, that the Remote end will buffer locally before starting to transmit data through the serial port.  
[**16, 32, 64, 128, 256; 32**]
- **Commit Changes and Exit Wizard**—Save and execute changes made on this screen (Shown only after changes have been entered.)

A PPP session shows the following possible states:

- **Sending LCP Requests**—The PPP server is querying for any clients that need to connect.
- **Link Established**—A successful PPP connection has been negotiated and an IP address is assigned.
- **Port not Enabled**—The serial port is disabled.

## 2.6.6 IP-to-Serial Application Example

You have a choice to use UDP or TCP to establish communications. This will depend on the type of device you are communicating with at the other end of the IP network. In this example we will use TCP to illustrate its use.

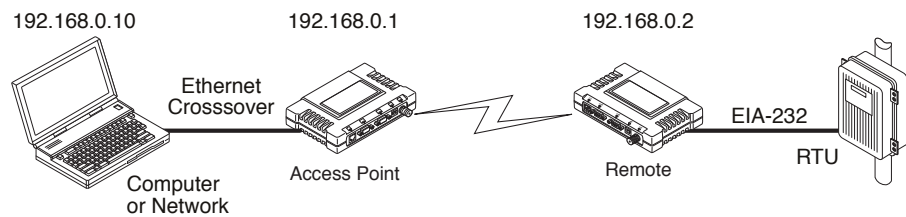
In TCP mode, the transceiver remains in a passive mode offering a socket for connection. Once a request is received, data received at the serial port will be sent out through the IP socket and vice versa, until the

connection is closed, or the link is interrupted. In this mode, the transceiver behaves the same, whether it is an Access Point or a Remote. (See Figure 2-36 and Table 2-1)

**NOTE:** The TCP session has a timeout of 10 minutes (600 seconds). If inactive for that time, it will be closed. The transceiver will offer the port again for connection after this time expires.

**Establishing a Connection**

From the PC, establish a TCP connection to the IP address of the Remote transceiver and to the IP port as configured above (30010—COM1, 30011—COM2). A Telnet client application can be used to establish this connection. Data can now be sent between the PC and the RTU or other connected device.



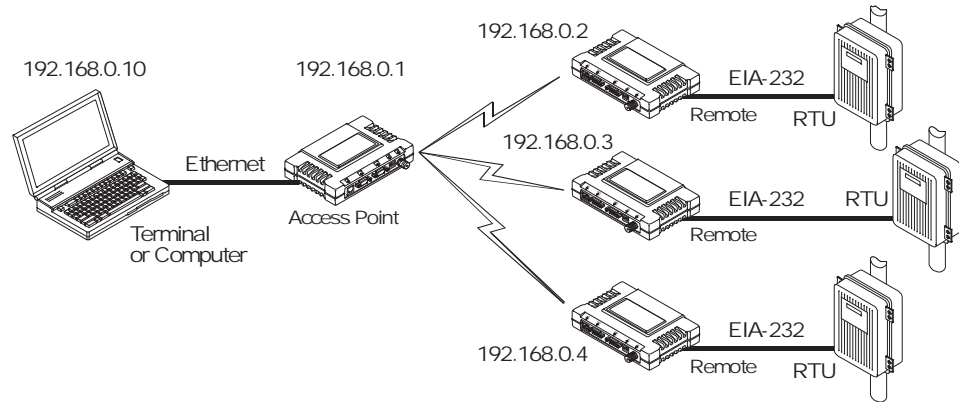
**Figure 2-36. IP-to-Serial Application Diagram**

**Table 2-1. Serial Port Application Configuration**  
*IP-to-Serial Connection*

Transceiver Location	Menu Item	Setting
Access Point	None is required	None is required
Remote Unit	IP Address	192.168.0.2
	Status	Enabled
	IP Protocol	TCP
	Baud Rate	9,600 (Example)
	Flow Control	None
	Local IP Port	30011

**2.6.7 Point-to-Multipoint IP-to-Serial Application Example**

The operation and data flow for this mode is very similar to Point-to-Point serial-to-serial application, except that it uses multicast addressing. The primary difference is that the PC uses UDP to communicate with all of the Remotes. Upon receiving the packet, each Remote strips the data out of the UDP packet and sends it from its COM port. Likewise, data presented at any of the Remotes' COM ports is packetized, sent to the PC using the Access Point (see Figure 2-37 and Table 2-2 on Page 73).



**Figure 2-37. Point-to-Multipoint Serial-to-Serial Application Diagram**

**Table 2-2. Serial Port Application Configuration**

Transceiver Location	Menu Item	Setting
PC	IP Protocol	UDP
	Remote IP Address	224.254.1.1 — Multicast Address <sup>1</sup>
	Local IP Port	30011
Access Point (COM2) <sup>2</sup>	N/A	None required
Remote Units (COM2) <sup>1</sup>	Enable	Enabled
	Baud Rate	2,400 (Example)
	Serial Mode	Custom
	Flow Control	Hardware (Example)
	IP Protocol	UDP
	Remote IP Address	192.168.0.1
	Remote IP Port	30011
Local IP Port	30011	
	Local Multicast Address	224.254.1.1 — Multicast Address <sup>2</sup>

1. This address is an example only. Any Class D IP address (224.0.0.0–239.255.255.255) will work.
2. Either COM port can be used, but they must be the same ones at both ends of the link. Both COM ports can be used simultaneously for two independent data channels.

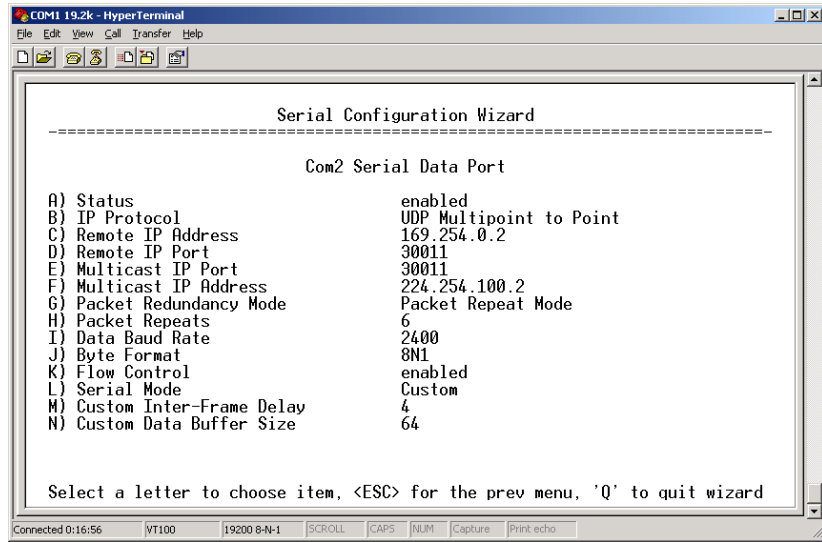


Figure 2-38. Remote Radio Serial Port Configuration

## 2.6.8 Point-to-Point Serial-to-Serial Application Example

Once the transceivers are configured and the changes have been executed, they begin processing any data presented at the COM ports. Data presented at the Access Point’s COM port will be packetized and sent via UDP to the Remote. Upon receiving the packet, the Remote strips the data out of the UDP packet and sends it out its COM port. Likewise, data presented at the Remote’s COM port is packetized, sent to the Access Point, stripped, and sent out the Access Point’s COM port. Note, this configuration does not use multicast addressing.

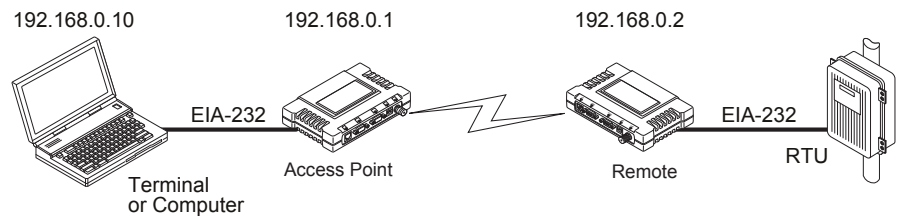


Figure 2-39. Point-to-Point Serial-to-Serial Application Diagram

Table 2-3. Serial Port Application Configuration

Transceiver Location	Menu Item	Setting
Access Point (COM2) <sup>1</sup>	Status	Enabled
	Data Baud Rate	9,600 (Example)
	Flow Control	Hardware (Example)
	Serial Mode	Seamless
	SIFD	4
	IP Protocol	UDP

**Table 2-3. Serial Port Application Configuration (Continued)**

Transceiver Location	Menu Item	Setting
	Remote IP Address	192.168.0.2 (IP address of the Remote radio)
	Remote IP Port	30011
	Local IP Port	30011
Remote Unit (COM2) <sup>1</sup>	Status	Enabled
	Data Baud Rate	9,600 (Example)
	Flow Control	X-ON/X-OFF (Example)
	Serial Mode	Seamless
	SIFD	4 (Characters)
	IP Protocol	UDP
	Remote IP Address	192.168.0.1 (IP address of the AP)
	Remote IP Port	30011
	Local IP Port	30011

1. Either COM port can be used, but they must be the same ones at both ends of the link. Both COM ports can be used simultaneously for two independent data channels.

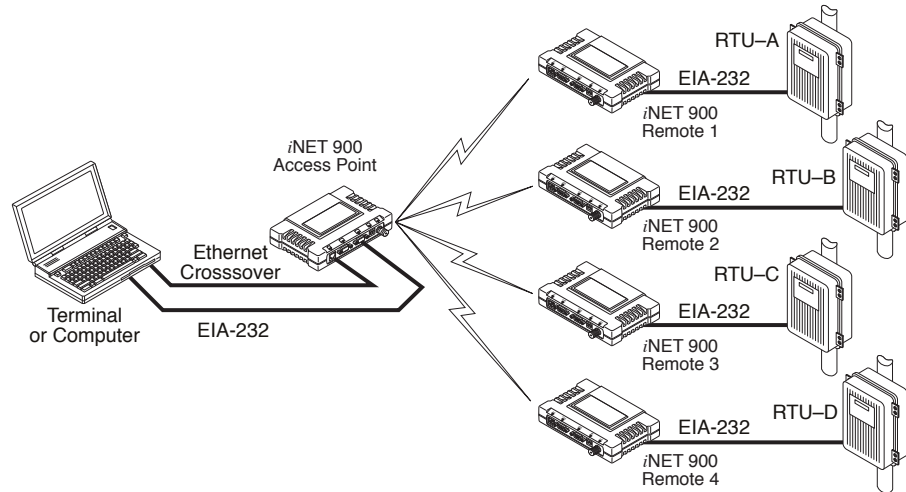
## 2.6.9 Combined Serial and IP Application Example

Note that in this example, the TCP mode does not involve the Access Point. Thus, the transceiver in a single network can run in *both* modes at the same time. In other words, some Remotes can be configured for TCP mode while others can be configured (along with the Access Point) for UDP mode.

In this configuration, the Host PC can use both data paths to reach the RTUs. This may be helpful when a mixed collection of RTUs is present where some RTUs can operate in a broadcast form while others cannot (see Figure 2-40 on Page 76 and Table 2-4 on Page 76).

### Operation and Data Flow

- Communicate with RTU A by Telnetting to Remote 1, port 30011.
- Communicate with RTU B by Telnetting to Remote 2, port 30011.
- Communicate with RTUs C and D by sending and receiving data from the Access Point's COM port.
- All communication paths can be used simultaneously.



**Figure 2-40. Mixed-Modes Application Diagram**

**Table 2-4. Serial Port Application Configuration**

Transceiver Location	Menu Item	Setting
Access Point	Status	Enabled
	Baud Rate	9,600
	Flow Control	Disabled
	IP Protocol	UDP
	Send to Address	A multicast IP address such as 224.254.1.1
	Send to Port	30011
	Receive on Port	30011
	Receive on Address	0.0.0.0 (Not Used)
Remote Units 1 & 2 (COM2)	Status	Enabled
	Baud Rate	2,400
	Flow Control	Disabled
	IP Protocol	TCP
	Receive on Port	30011
Remote Units 3 & 4 (COM2)	Status	Enabled
	Baud Rate	9,600
	Flow Control	Disabled
	IP Protocol	UDP
	Send to Address	IP address of the AP
	Send to Port	30011
	Receive on Port	30011
Receive on Address	224.254.1.1 (The multicast IP address used for the AP's Send To Address above)	

## 2.6.10 Virtual LAN in iNET-II and iNET

The iNET-II and iNET radios support port-based VLAN at the Ethernet interface and over the air, as specified by the IEEE 802.1Q standard.

A VLAN creates independent logical networks within a physical network. It allows communications as if all stations and switches are connected to the same physical LAN segment. Members of a VLAN receive frames only from other members of the same VLAN.

The iNET-II and iNET radios act as an Ethernet switch with two interfaces: the wireless interface is always a trunk port, while the Ethernet interface is configured as either a trunk port or an access port. A trunk port expects incoming frames to have a VLAN ID, and sends outgoing frames with a VLAN tag as well. The radio's trunk port also supports Native VLAN, which allows the transmission and reception of untagged frames. The radio does not support Generic Attribute Registration Protocol (GVRP).

The Ethernet port of an Access Point radio is normally configured as a trunk port, and is connected to a VLAN-aware switch or router.

You can configure the Ethernet port of a remote radio as an access port or as a trunk port:

- When the Ethernet interface is configured as an access port, incoming traffic is tagged with a VLAN ID, and outgoing traffic is sent without a tag. This traffic is assigned to the DATA VLAN. A second VLAN, known as the MANAGEMENT VLAN, is used for traffic targeted at the radio, such as SNMP, TFTP, ICMP, Telnet, and so on. Traffic directed to the transceiver's integrated terminal server, which controls the serial ports, is assigned to the DATA VLAN.
- When the Ethernet interface is configured as trunk port, the transceiver bridges all frames to and from the wireless link with the unchanged VLAN tag. Untagged frames are also bridged transparently.

---

**NOTE:** The Ethernet port in an iNET-II or iNET radio is 10BaseT. Some Ethernet switches allow a VLAN trunk port only on a 100BaseT interface, and might not be compatible with the transceiver.

---

## Configuring for Operation with VLAN

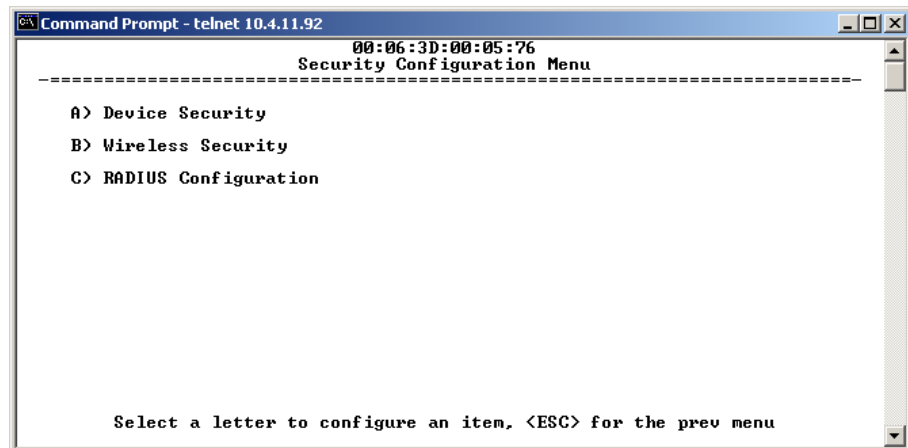
**Figure 2-41. Network Interface Configuration Menu**

- **VLAN Status**—When **enabled**, the transceiver uses an 802.1Q frame structure.
- **Data VLAN ID**—Defines the VLAN ID assigned to the traffic that is directed to and from the transceiver's Ethernet port and the terminal server process. The transceiver uses this VLAN ID for filtering and tagging purposes. [1-4094; 3]
- **Management VLAN Mode**—Defines whether frames belonging to the management VLAN are tagged or untagged [Native].
- **Config Management IP**—Opens the Configuration Management IP menu.
- **Config Data IP**—Opens the Configuration Management IP menu.

## 2.7 CYBER SECURITY CONFIGURATION

The cyber security features of the transceiver are grouped into three general areas: controlling access to the radio itself for configuration and management purpose (Device Security), controlling how and when radios communicate with each other, as well as how data traffic is handled (Wireless Security) and a special section dealing with authentication and authorization using a central server (RADIUS Configuration). Figure 2-42 shows the Security Configuration Menu, which is the entry point for these categories.

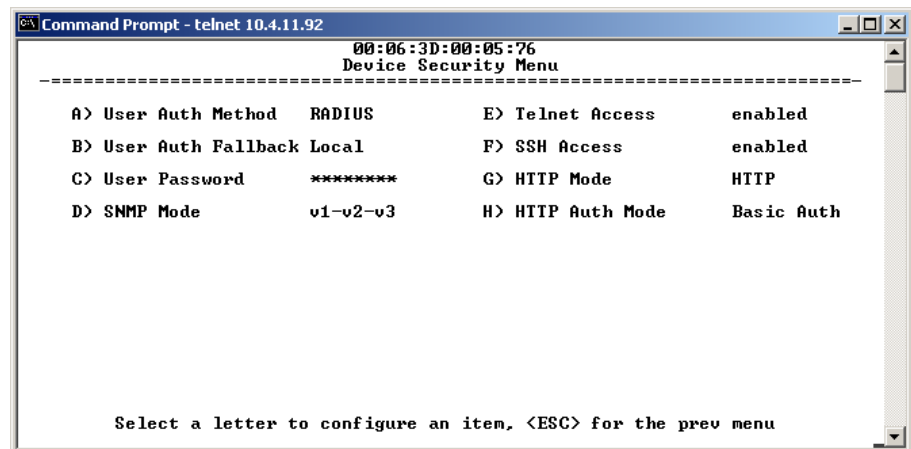




**Figure 2-42. Security Configuration Menu**  
(Access Point Version Shown)

## 2.7.1 Device Security

This group of features controls how the radios can be accessed either locally or remotely for configuration and management.



**Figure 2-43. Device Security Menu**

- **User Auth Method**— Defines whether username and password is verified locally or via a central server. [**Local**, **RADIUS**; **Local**]
- **User Auth Fallback**— Defines the alternate authentication mode in case the authentication server is not available. [**Local**, **None**; **Local**]
- **User Password**— Local password for this unit. Used at log-in via COM1 Port, Telnet, SSH and Web browser. [**Up to 8 alphanumeric characters without spaces (case-sensitive); admin**]

**TIP:** For enhanced security, consider using misspelled words, a combination of letters and numbers, and a combination of upper and lower case letters. Also, the more characters used (up to eight), the more secure the password will be. These strategies help protect against sophisticated hackers who may use a database of common words (for example, dictionary attacks) to determine a password.

- **SNMP Mode**— This specifies the mode of operation of the radio's SNMP Agent. If the mode is disabled, the Agent does not respond to any SNMP traffic. If the mode is v1\_only, v2\_only, or v3\_only, the Agent responds only to that version of SNMP traffic. If the mode is v1-v2, or v1-v2-v3, the Agent responds to the specified version of SNMP traffic.  
[disabled, v1\_only, v2\_only, v3\_only, v1-v2, v1-v2-v3; v1-v2-v3]
- **Telnet Access**— Controls remote access through Telnet sessions on Port 23 [Enabled, Disabled; Enabled]
- **SSH Access**— Controls remote access through SSH (Secure Shell) sessions on Port 22 [Enabled, Disabled; Enabled]
- **HTTP Mode**— Controls remote access through HTTP sessions on Ports 80 and 443. Selecting **HTTPS** forces secure connections to Port 443. When **HTTP Mode** is disabled, access through HTTP or HTTPS is not allowed. [Disabled, HTTP, HTTPS; HTTP]
- **HTTP Auth Mode**— Selects the method of HTTP log-in authentication. This parameter functions only when **HTTP** is selected in the previous menu item. Although the **Basic Auth** mode requests a password, the actual password text is transmitted in the clear (unencrypted). [Basic Auth, MD5 Digest; Basic Auth]

## 2.7.2 Wireless Security

The features in the Wireless Security menu control the communication of data across the wireless link. The radios can be authenticated locally via a list of authorized radios, or remotely via a centralized RADIUS server. RADIUS is a centralized authentication mechanism based on standards.

```

Command Prompt - telnet 10.4.11.92
00:06:3D:00:05:76
Wireless Security Menu
-----
A> Device Auth Method  None          D> Approved Remotes List
B> Encryption          disabled       E> Encryption Phrase  *****
C> Auto Key Rotation   enabled        F> Force Key Rotation

Select a letter to configure an item, <ESC> for the prev menu

```

**Figure 2-44. Wireless Security Menu**

- **Device Auth Method**—Controls whether device authentication is executed locally, via a central server, or not at all. Selecting **Local** uses the Approved Remotes List described later in this manual. [**None, Local, RADIUS; None**]
- **Encryption**— When enabled, it forces the transceiver to use AES-128 encryption (RC4-128 on iNET) on all over-the-air messages. This option requires the Encryption Phrase to be previously configured. Both the AP and the Remote radios must use the same encryption phrase. (Some units may not be authorized to use encryption. “See “Authorization Keys Menu” on Page 108” for additional details.) [**Enabled, Disabled; Disabled**]
- **Auto Key Rotation**— When enabled, it forces the transceiver to use the key rotation algorithm to generate a new encryption key after 500 kilobytes of information has been transmitted, or one hour has elapsed. [**Enabled, Disabled; Disabled**]
- **Approved Access Points/Remotes List** —Displays a menu to manage the list of other radios with which this unit will be permitted to communicate.
- **Encryption Phrase**—Phrase (text & numbers) that will be used by the encryption algorithm.  
[**8 to 29 alphanumeric characters; Blank**]
- **Force Key Rotation**— It triggers an immediate key rotation of the encryption keys before the internal counters do it automatically.

### **Local Authentication—Approved Remotes/Access Points List Submenu**

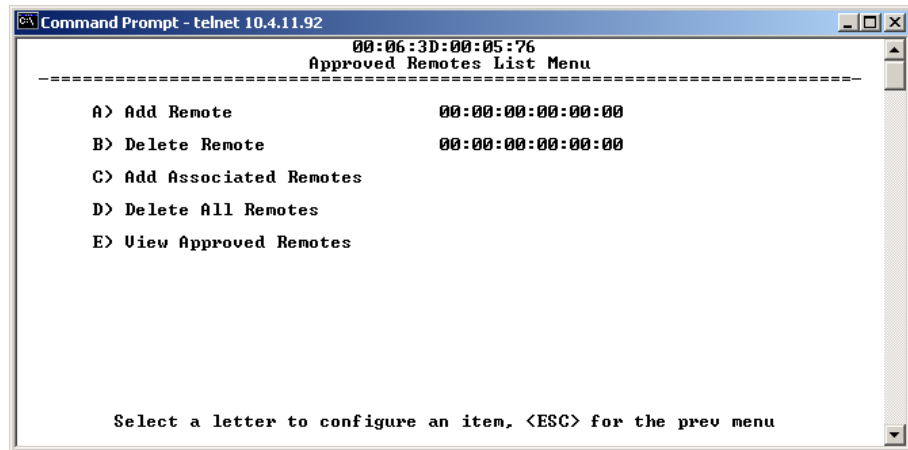
Setting the **Device Auth Method** to **Local** forces the transceiver to check the *Approved AP List* before a radio link can be established. In the case of a Remote, the AP must be in the *Approved Access Points List* before it accepts the beacon as being valid. In the case of an AP, a Remote must be in the *Approved Remotes List* to be granted authorization. Before enabling this option, at least one entry must already exist in the *Approved AP/Remotes List*.

This menu is the same for both Access Points and Remotes and the names change to reflect their mode. Replace “Remotes” with Access Points” in the following description.

---

**NOTE:** The limit for Remotes (in an Access Point radio) is 255. The limit for Access Points (in a Remote radio) is 104.

---



**Figure 2-45. Approved Remotes List Menu**

- **Add Remote**—Enter MAC address of Remote.  
[Any valid 6-digit hexadecimal MAC address; 00:00:00:00:00:00]
- **Delete Remote**—Enter MAC address of Remote. For security purposes, you may want to delete a stolen or deprovisioned radio from this list.
- **Add Associated Remotes**— Add all currently associated remotes to the approved remote list. Alternatively, you can enter each Remote MAC manually.
- **Delete All Remotes**— Remove (complete purge) of all Remotes from current list.
- **View Approved Remotes**— Simple listing of approved Remotes by MAC address, of radios authorized to join this AP. If a Remote is not in this list, it will not be able to associate with this AP.
- **Save Changes**— Saves all changes made during the session with this menu. Changes are implemented only if they are “saved” before exiting this menu.

### 2.7.3 RADIUS Configuration

This section covers the authentication settings needed for the iNET radios to access the RADIUS server, which is used for Device Level Security and for Wireless Access Security. GE MDS does not provide the RADIUS server software.

## Operation of Device Authentication

Device authentication forces the radio to authenticate before allowing user traffic to traverse the wireless network. When Device Security is configured to use RADIUS as the Authentication Method, Remote radios need three types of certificates: public (client), private, and root (Certificate Authority). These files are unique to each Remote radio and need to first be created at the server and then installed into each unit via TFTP. The certificate files must be in DER format.

Device authentication uses the serial number of each radio as the Common Name (CN) in its certificate and in its RADIUS identity field. Each Access Point *and* Remote radio must be identified/recognized by the RADIUS Server through the Common Name (Serial number) and IP address entries.

---

**NOTE:** Consult your RADIUS network administrator for assistance in configuration, or for help with other issues that may arise.

---

To activate device authentication, select **Device Auth Method** and set **RADIUS** as the active mode. The behavior of this setting differs depending on whether it is implemented on an Access Point or a Remote transceiver. An explanation of these behaviors is given below:

*Access Point:* When **Device Auth Method** is set to **RADIUS**, the AP disassociates all associated Remotes and waits for the RADIUS Server to Authenticate the Remotes before allowing data to be passed from them. When approval is received from the RADIUS Server, data from the Remote is allowed to pass.

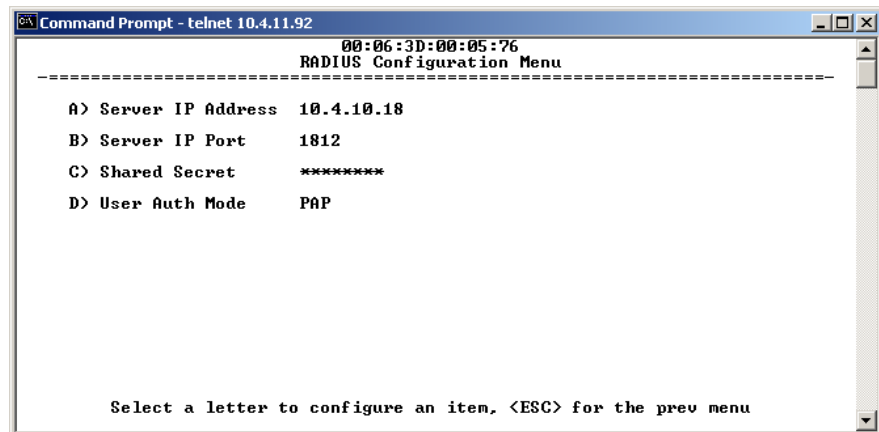
*Remote:* When **Device Auth Method** is set to **RADIUS**, the Remote halts any data it is passing, and requests Authentication from the RADIUS Server. If accepted, data is allowed to be transmitted.

## Operation of User Authentication

When user authentication is set to **Local** or **RADIUS**, you must enter a valid user name and password before being allowed to manage the radio. In **RADIUS** mode both of these fields may be up to 40 characters long. In **Local** mode the user name is **iNET** and the password may be up to 8 characters long.

When set to **RADIUS**, *all* logins to the local configuration services are required to be authenticated via the RADIUS Server, including telnet and SSH (Secure Shell) sessions. Authentication must be accepted before access to the radio menu is granted.

## 2.7.4 RADIUS Configuration



**Figure 2-46. RADIUS Configuration Menu**

- **Server IP Address**—Used to set/display address of the Server where the RADIUS application resides.
- **Server IP port**—1812 is the standard port for authentication (RFC 2865, June 2000), but this setting may be changed if necessary to any number between 1 and 65535. [**1-65535; 1812**]
- **Shared Secret**—User authentication and Device authentication require a common shared secret to complete a RADIUS transaction. This entry must match the string used to configure the appropriate files on the RADIUS Server.
- **User Auth Mode**—Should be set to PAP or CHAP depending on the configuration of the server.

---

**NOTE:** CHAP is more secure than PAP. PAP may display the login password in log files at the RADIUS Server while CHAP will encrypt the login password.

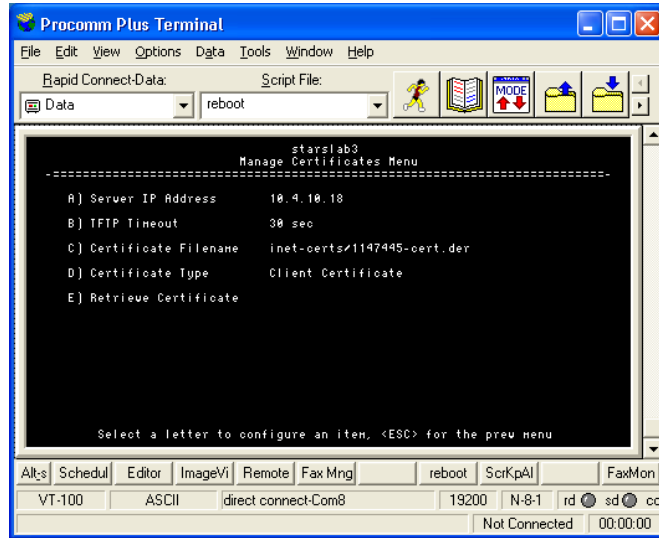
---

**NOTE:** The security password may not exceed 40 characters in length.

---

## 2.7.5 Certificate Management *(Remote transceivers only)*

Use Certificate generation software to generate certificate files and then install these files into each Remote unit via TFTP. The certificate files must be in DER format. The Common Name (CN) field in the public certificate file must match the serial number of the unit it will be installed in.



**Figure 2-47. Manage Certificates Menu**

(NOTE: The appearance of this screen differs from the others because a different terminal program was used; Menu content is the same regardless of program.)

- **Server IP Address**—the IP address of the Server where the RADIUS application resides.
- **TFTP Timeout** should be set appropriately according to the layout of the network.

Three certificate files (Root, Client, and Private Key) must be present in *each* of the Remote radios. Use the commands described below to install these files into each Remote radio.

- **Certificate Filename**—Used to specify the filename of the certificate file residing on the TFTP server.
- **Certificate Type**—Selects one of the three file types mentioned above. [**Root Certificate, Client Certificate, Private Key Certificate; Root Certificate**]
- **Retrieve Certificate**—Initiates the retrieval of the certificate file from the storage location. A successful installation issues a **Complete** status message.

---

**NOTE:** It is *imperative* that the three certificate files are installed correctly into the Remote radio, in their respective file types. If they are not, it will render the Remote un-authenticated for data traffic. Consult your RADIUS network administrator if issues arise.

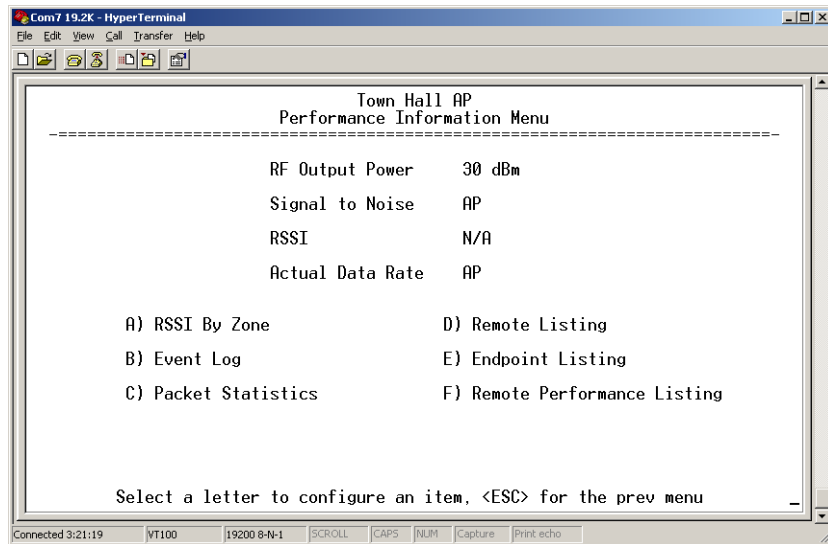
---

## 2.8 PERFORMANCE VERIFICATION

After the basic operation of the radio has been checked, you may wish to optimize the network's performance using some of the following suggestions. The effectiveness of these techniques will vary with the design of your system and the format of the data being sent.

There are two major areas for possible improvement—the radio and the data network. The following sections will provide you with a variety of items to check and on many occasions, ways to correct or improve their performance.

The menu/screen shown in Figure 2-48 is one of two primary sources of information on the radio layer and radio network performance.



**Figure 2-48. Performance Information Menu**  
(AP Version Shown)

- **RF Output Power** (*Display only*)—Measured power output. (See “How Much Output Power Can be Used?” on Page 135)
- **Signal-to-Noise** (*Display only*)—Current running-average SNR value all active operating frequencies. (No value displayed on APs)

---

**NOTE:** The RSSI is an average of the last 20 RSSI samples. The RSSI value is reset every time the radio returns to scanning mode.

---

- (*Display only*)—Current running-average Received Signal Strength Indication for all active operating frequencies. (No value displayed on APs.)
- **Actual Data Rate** (*Display only*)—Over-the-air transmission rate (as opposed to selected data rate) for the remote being monitored. The fastest data rates can generally be achieved with stronger signal levels.
- **RSSI by Zone**—Received Signal Strength Indicator by Zone. (See “RSSI by Zone Menu (Remotes Only)” on Page 87)
- **Event Log**—Access the menu for managing the unit’s log of operational activities. (See “Authorization Key—Alter the unit’s overall capabilities by enabling the built-in resources. (See “Authorization Keys Menu” on Page 108)” on Page 100)



- **Packet Statistics**—Multiple radio and network operating statistics. (See “Packet Statistics Menu” on Page 91)
- **Wireless Network Status** (*Displayed only at Remotes*)—Current association state and MAC address of the Access Point. (See “Wireless Network Status (Remotes Only)” on Page 94)
- **Remote Listing** (*AP Display only*) —List of basic information for all Remote units currently associated with this Access Point. (See “Remote Listing Menu (Access Points Only)” on Page 96)
- **Endpoint Listing** (*AP Display only*)—List of units accessible by this AP through associated Remote ports. (See “Endpoint Listing Menu (Access Points Only)” on Page 97)
- **Remote Performance Listing** (*AP Display only*)—(See “Remote Performance Listing Menu (Access Points Only)” on Page 98)

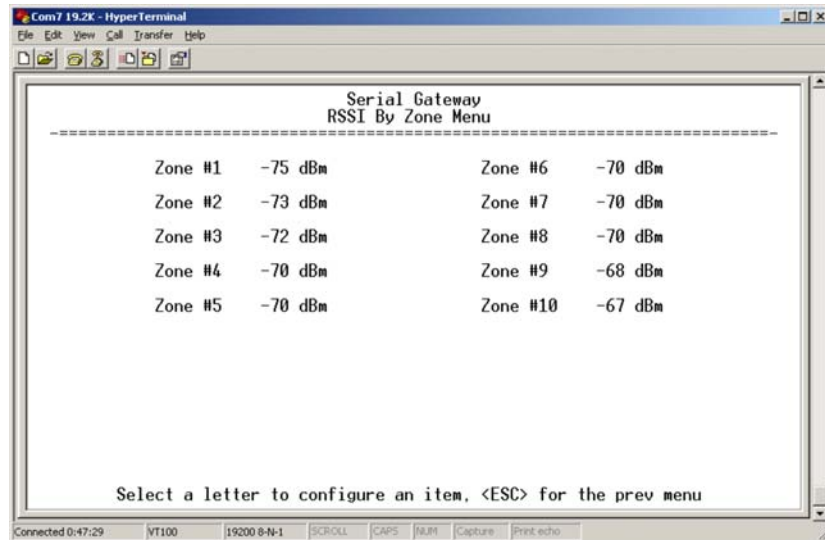
### 2.8.1 RSSI by Zone Menu (*Remotes Only*)

This screen displays the strength of RF signals received from the currently associated Access Point.

Network integrity depends in large part on stable radio signal levels being received at each end of a data link. In general, signal levels stronger than  $-80$  dBm will provide reliable communication that includes a 15 dB fade margin.

If you find there is a poor signal level on one zone, check the *Packet Statistics Menu* section on Page 91 and record the values. Then, set the questionable zone to “Skipped” in the Radio Configuration Menu (Page 52) and look for an improvement in the Packet Statistics error rates. If there is none, return the Zone to “Active.”

RSSI measurements and Wireless Packet Statistics are based on multiple samples over a period of several seconds. The average of these measurements will be displayed by the Management System.



**Figure 2-49. RSSI by Zone Menu**

**TIP:** Under normal circumstances, the signal levels in each zone should be within a few decibels of each other. If you see one that is significantly lower or higher, it may be a sign of radio frequency interference from another signal source on the 900 MHz band. See “PERFORMANCE NOTES” on Page 144 for further information.

## 2.8.2 Event Log Menu

The transceiver’s microprocessor monitors many operational parameters and logs them. Events are classified into four levels of importance, which are described in Table 2-5. Some of these events will result from a condition that prevents the normal of the unit—these are “critical” events. These will cause the unit to enter an “alarmed” state and the PWR LED to blink until the condition is corrected. All events are stored in the Event Log that can hold up to 8,000 entries.

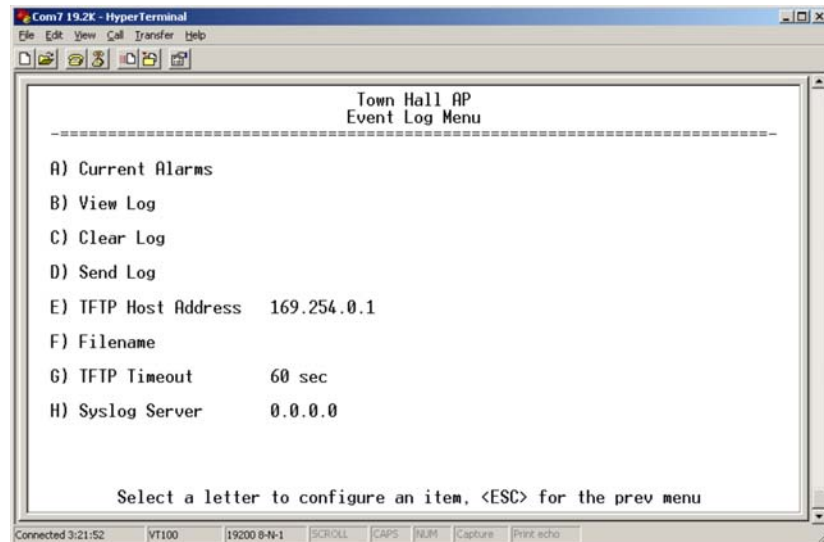
**Table 2-5. Event Classifications**

Level	Description/Impact
Informational	Normal operating activities
Minor	Does not affect unit operation
Major	Degraded unit performance but still capable of operation
Critical	Prevents the unit from operating

### Time and Date

The events stored in the Event Log are time-stamped using the time and date of the locally connected device. Remote units obtain this information from the Access Point when they associate with it. The Access Point

obtains the time and date from a Time Server. This server can generally be provided by a standard Windows PC server SNTP application. In the absence of the SNTP services, the user must manually enter it at the Access Point. (See “Device Information” on Page 35 for SNTP server identification.) The manually set time and date clock is dependent on the unit’s primary power. A loss of power will reset the clock to January 1, 2002 but will not affect previously stored error events.



**Figure 2-50. Event Log Menu**

- **Current Alarms** (*Telnet/Terminal only*)— View list of root causes that have placed the Device Status in the alarmed state. (See “Alarm Conditions” on Page 120)
- **View Log**— View a list of events stored in the current log. Some of these events are stored in volatile memory and will be erased with a loss of power. The events are numbered for easier identification and navigation.
- **Clear Log**— Purges the log of all events

**TIP:** Save your Event Log before choosing to clear it in order to retain potentially valuable troubleshooting information. (See “Upgrading the Firmware” on Page 102 for an overview on how to transfer files from the transceiver to a computer on the network using TFTP.)

- **Send Log** (*Telnet/Terminal only*)— Initiate TFTP transfer of the unit’s event Event Log in a plain text (ASCII) file to a TFTP server at the remote location.
- **TFTP Host Address** (*Telnet/Terminal only*)— IP address of the computer on which the TFTP server resides. This same IP address is used in other screens/functions (reprogramming, logging, etc.). Changing it here also changes it for other screens/functions.  
**[Any valid IP address; 127.0.0.1]**

- **Filename** (*Telnet/Terminal only*)—Name to be given to the Event Log file sent to the TFTP server for archiving.  
[Any 40-char alphanumeric string; Blank]

**NOTE:** You may want to change the filename to reflect the type of log you intend to archive and/or its date.

- **TFTP Time-out** (*Telnet/Terminal only*)—Time in seconds the TFTP server will wait for a packet ACK (acknowledgment) from the transceiver before canceling the file transfer.  
[10 to 120 seconds; 10]
- **Syslog Server**—IP address to which alarms are sent using the syslog message format. [Any valid IP address; 0.0.0.0]

## View Current Alarms

Most events, classified as “critical” will make the PWR LED blink, and will inhibit normal operation of the transceiver. The LED will remain blinking until the corrective action has been completed.

An alarm condition is different from a log event in the sense that an alarm is persistent in nature. That is, an alarm condition remains as an alarm until it has been cleared by correcting the cause (see Table 3-6 on Page 122 for corrective action).

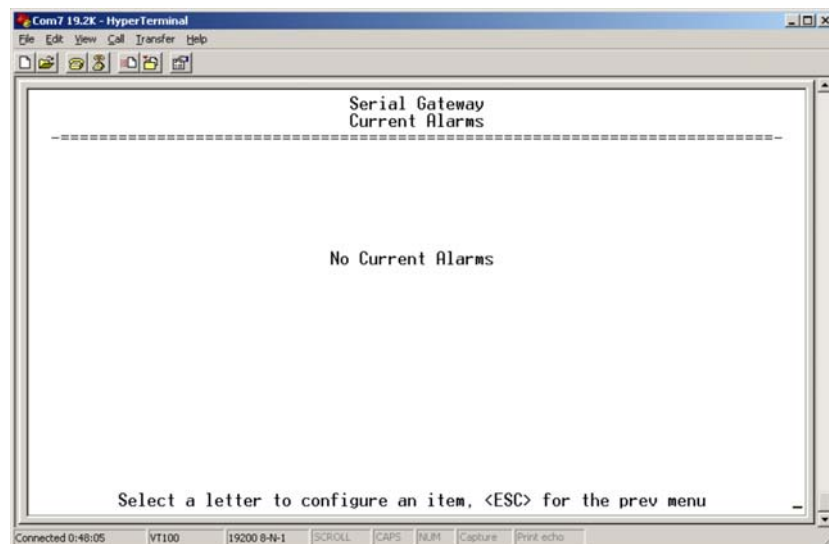
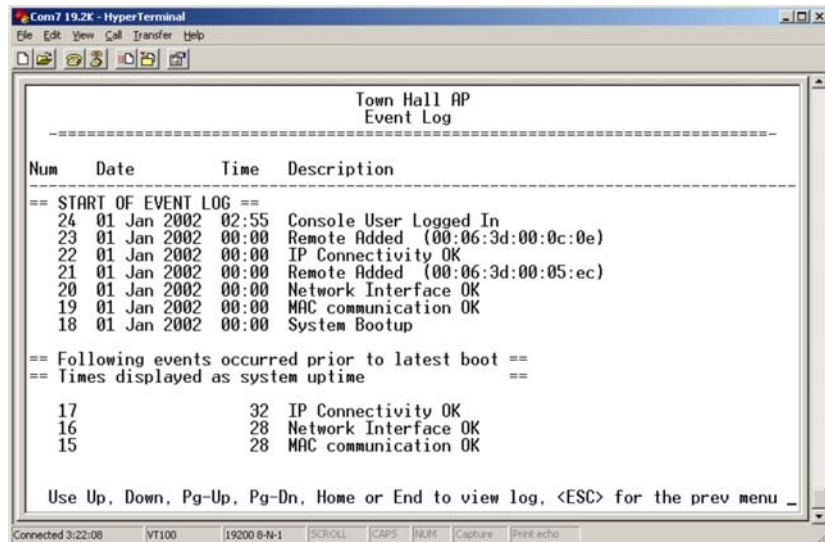


Figure 2-51. Current Alarms Screen

## View Event Log

See Table 3-4 on Page 119 for event classifications.



```

Town Hall AP
Event Log
-----
Num   Date       Time   Description
-----
== START OF EVENT LOG ==
24 01 Jan 2002 02:55 Console User Logged In
23 01 Jan 2002 00:00 Remote Added (00:06:3d:00:0c:0e)
22 01 Jan 2002 00:00 IP Connectivity OK
21 01 Jan 2002 00:00 Remote Added (00:06:3d:00:05:ec)
20 01 Jan 2002 00:00 Network Interface OK
19 01 Jan 2002 00:00 MAC communication OK
18 01 Jan 2002 00:00 System Bootup

== Following events occurred prior to latest boot ==
== Times displayed as system uptime ==

17           32 IP Connectivity OK
16           28 Network Interface OK
15           28 MAC communication OK

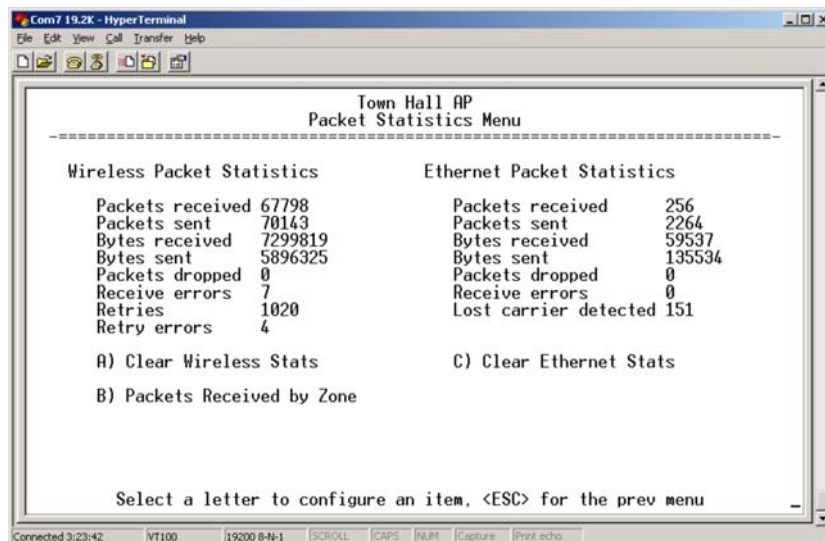
Use Up, Down, Pg-Up, Pg-Dn, Home or End to view log, <ESC> for the prev menu _

```

**Figure 2-52. Sample Event Log Screen**

## 2.8.3 Packet Statistics Menu

An iNET radio maintains running counters of different categories of events in the Ethernet protocol. The Packet Statistics refer to each Ethernet interface from the perspective of the *radio*.



```

Town Hall AP
Packet Statistics Menu
-----

Wireless Packet Statistics          Ethernet Packet Statistics

Packets received 67798              Packets received 256
Packets sent 70143                 Packets sent 2264
Bytes received 7299819             Bytes received 59537
Bytes sent 5896325                 Bytes sent 135534
Packets dropped 0                  Packets dropped 0
Receive errors 7                   Receive errors 0
Retries 1020                       Lost carrier detected 151
Retry errors 4

A) Clear Wireless Stats            C) Clear Ethernet Stats
B) Packets Received by Zone

Select a letter to configure an item, <ESC> for the prev menu

```

**Figure 2-53. Sample Packet Statistics Menu**

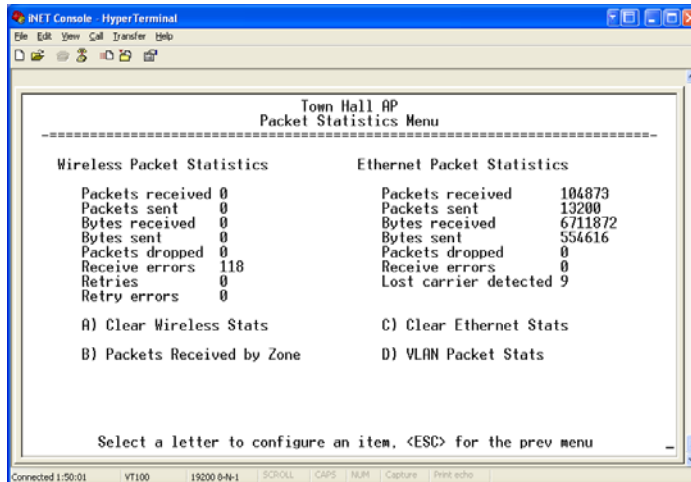
### Wireless Packet Statistics

- **Packets received**—Over-the-air data packets received by this unit

- **Packets sent**—Over-the-air data packets sent by this Remote.
- **Bytes received**—Over-the-air data bytes received by this Remote.
- **Bytes sent**—Over-the-air data bytes sent by this Remote.
- **Packets dropped**—To-be-transmitted packets dropped as a result of a lack of buffers in the RF outbound queue.
- **Receive errors**—Packets that do not pass CRC. This may be due to transmissions corrupted by RF interference.
- **Retries**—Number of requests to re-send a data packet before it is acknowledged. If the packet was not acknowledged, this counter is not incremented.
- **Retry errors**—Packets discarded after exceeding seven retries over-the-air.
- **Clear Wireless stats**—Resets the statistics counter.

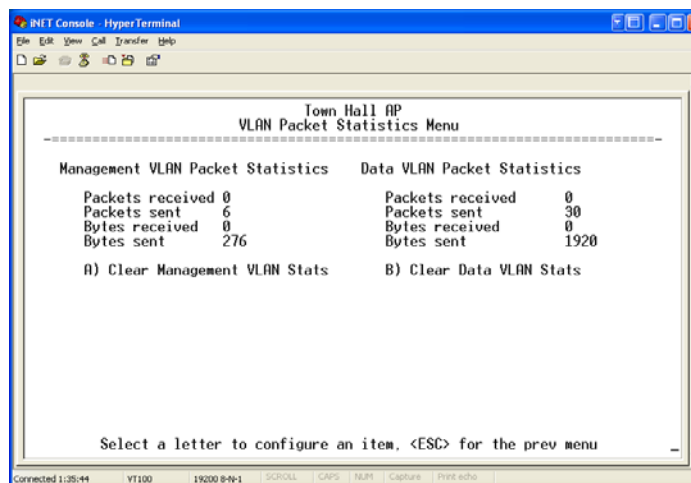
### Ethernet Packet Statistics

- **Packets received**—Packets received by the transceiver through the Ethernet port.
- **Packets sent**—Packets transmitted by the transceiver through the Ethernet port.
- **Bytes received**—Data bytes received by this Remote through its LAN port.
- **Bytes sent**—Data bytes sent by this Remote.
- **Packets dropped**—Received packets dropped as a result of a lack of buffers.
- **Receive errors**—Packets that do not pass CRC. This may be due to collisions in the Ethernet LAN.
- **Lost carrier detected**—A count of the number of packets that the unit attempted to send out the Ethernet port when the carrier signal of the Ethernet was not present. (No carrier present could be due to a loose connection, bad or wrong cable, or equipment failure at the other end of the Ethernet cable.)
- **Clear Ethernet stats**—Resets the statistics counter.
- **Wireless Packet Statistics** (when VLAN is shown)—A screen almost identical to Figure 2-53 is shown, except that option D (VLAN Packet Stats) appears as in Figure 2-54 below.



**Figure 2-54. Sample Packet Statistics Menu**

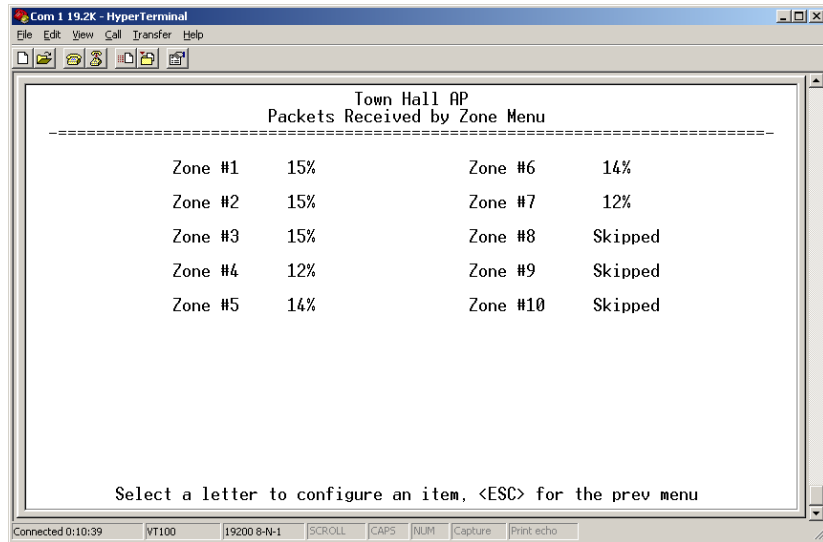
The VLAN Packet Statistics Menu (Figure 2-55) groups the statistics of both wired and wireless interfaces. The numbers have different meaning depending on whether the Ethernet port is defined as an Access Port or as a Trunk Port.



**Figure 2-55. VLAN Packet Statistics**

### Packets Received by Zone

This screen, shown in Figure 2-56, presents a breakdown of wireless packet statistics by-zone. All zones should report similar numbers. If one or more zones report lower numbers than the others (2% reduction), the specific zone is probably experiencing interference. An improvement can be realized by blocking this zone (see **Main Menu>>Radio Configuration>>Skip Zone Option**).



**Figure 2-56. Packets Received By Zone Menu**

### 2.8.4 Wireless Network Status *(Remotes Only)*

The Wireless Network Status screen provides information on a key operating process of the transceiver—the association of the Remote with the Access Point. The following is a description of how this process takes place and as monitored on the *Figure 2-57. Wireless Network Status Screen*" on page 95.

#### The Transceiver's Association Process

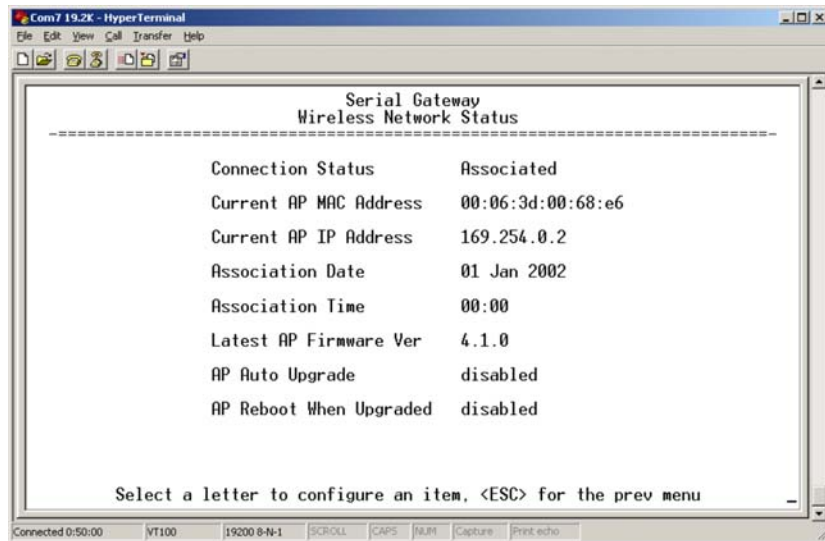
After the Remote is powered up and finishes its boot cycle, it begins scanning the 900 MHz band for beacon signals being sent out from AP units. If the Remote sees a beacon with a *Network Name* that is the same as its own, the Remote will stop its scanning and temporarily synchronize its frequency-hopping pattern to match the one encoded on the AP's beacon signal. The Remote waits for three identical beacon signals from the AP and then it toggles into a fully synchronized "associated" state. If the Remote does not receive three identical beacons from the Access Point unit within a predetermined time period, it returns to a scanning mode and continues to search for an AP with a matching network name in its beacon.

Under normal circumstances, the association process should be completed within 20 seconds after boot-up. This time can vary depending on the beacon period setting at the AP. See **Beacon Period** description in Section 2.5.1, *Radio Configuration Menu* (beginning on Page 52).

Remote units are always monitoring the beacon signal. If an associated Remote loses the AP's beacon for more than 20 seconds, the association process starts again.



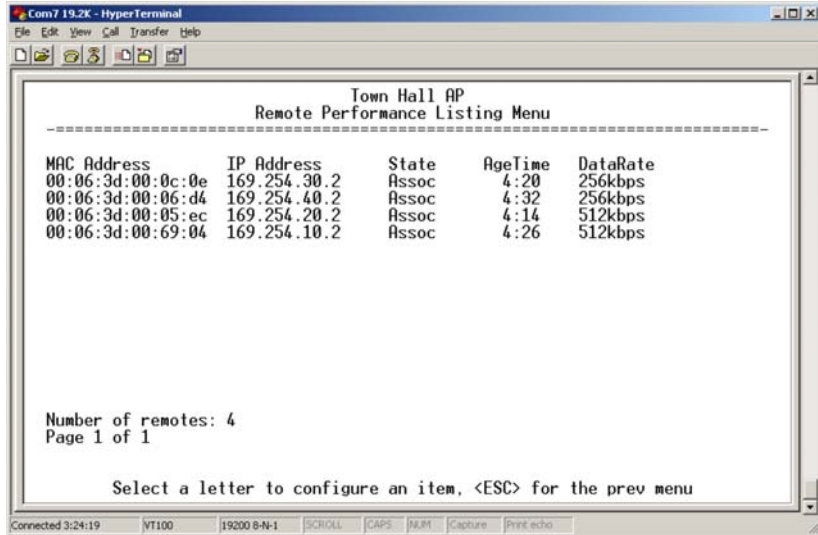
## The Wireless Network Status Screen *(Remotes Only)*



**Figure 2-57. Wireless Network Status Screen**

- **Connection Status**—Current state of the wireless network communication.
  - *Scanning*—The unit is looking for an Access Point beacon signal.
  - *Expecting Sync(hronization)*—The unit has found a valid beacon signal for its network.
  - *Hop Sync*—The unit has changed its frequency hopping pattern to match that of the Access Point.
  - *Connected* —The unit has established a radio (RF) connection with the Access Point, but has not obtained cyber-security clearance to pass data.
  - *Associated* —This unit has successfully synchronized and associated with an Access Point. This is the normal status.
  - *Alarmed*—The unit is has detected one or more alarms that have not been cleared.
- **Current AP Mac Address**—Wireless address of Access Point with which the Remote is associated.
- **Current AP IP Address**—IP address of Access Point with which the Remote is associated.
- **Association Date**—Date of last successful association with an Access Point.
- **Association Time**—Time of day association was established on the association date.
- **Latest AP Firmware Version**
- **AP Auto Upgrade**
- **AP Reboot when Upgraded**

## 2.8.5 Remote Listing Menu *(Access Points Only)*



MAC Address	IP Address	State	AgeTime	DataRate
00:06:3d:00:0c:0e	169.254.30.2	Assoc	4:20	256kbps
00:06:3d:00:06:d4	169.254.40.2	Assoc	4:32	256kbps
00:06:3d:00:05:ec	169.254.20.2	Assoc	4:14	512kbps
00:06:3d:00:69:04	169.254.10.2	Assoc	4:26	512kbps

Number of remotes: 4  
Page 1 of 1

Select a letter to configure an item, <ESC> for the prev menu

**Figure 2-58. Remote Listing Menu**  
*(List of transceivers associated with this AP)*

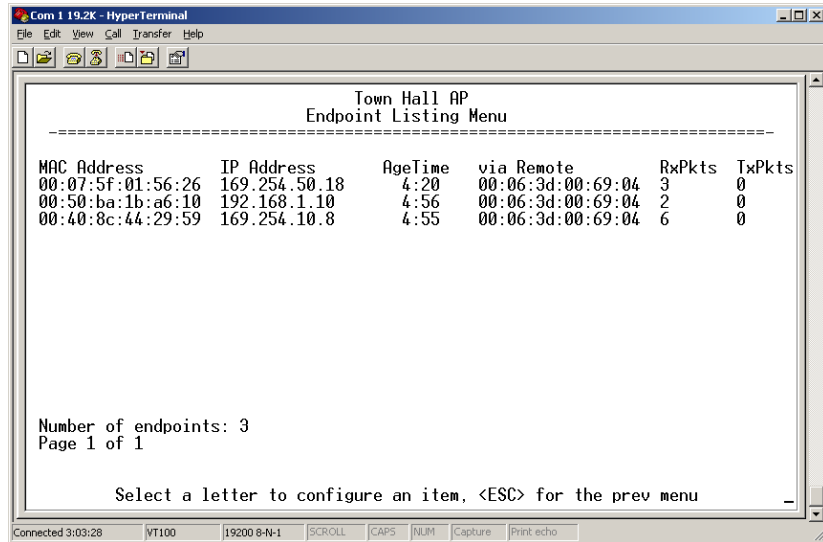
- **MAC Address**—Hardware address of the Remote transceiver.
- **IP Address**—IP Address of the Remote transceiver.
- **State**—Current association state of the Remote transceiver.
- **AgeTime**—Time, in minutes, remaining before the device (address) will be deleted from the table.

Each transceiver maintains a table with the addresses of the devices it communicates with. The age-time countdown is restarted to 5 minutes every time a message to/from that device is detected. If no traffic is exchanged with that device, it then “ages out” of the table. When traffic is detected it is included again in the table. This optimizes memory space utilization.

- **DataRate**—Supported data rate by this unit.

## 2.8.6 Endpoint Listing Menu *(Access Points Only)*

This list shows all of the non-iNET 900 Ethernet devices that are known to the transceiver and is equivalent to the ARP table of IP devices.



MAC Address	IP Address	AgeTime	via Remote	RxPkts	TxPkts
00:07:5f:01:56:26	169.254.50.18	4:20	00:06:3d:00:69:04	3	0
00:50:ba:1b:a6:10	192.168.1.10	4:56	00:06:3d:00:69:04	2	0
00:40:8c:44:29:59	169.254.10.8	4:55	00:06:3d:00:69:04	6	0

Number of endpoints: 3  
Page 1 of 1

Select a letter to configure an item, <ESC> for the prev menu

**Figure 2-59. Endpoint Listing Menu**

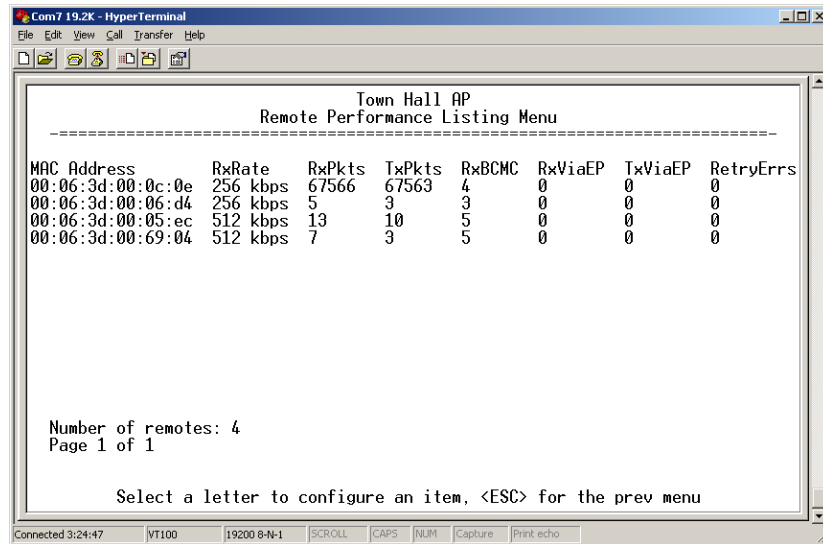
*(Lists all equipment attached to REMOTE transceivers in the network)*

- **MAC Address**—Hardware address of endpoint device.
- **IP Address**—IP Address of endpoint device.
- **AgeTime**—Time, in minutes, remaining before the device (address) will be deleted from the table.

Each AP maintains a table with the addresses of the remote radios it communicates with. The age-time countdown is restarted to 5 minutes every time a message to/from that remote is detected. If no traffic is exchanged with that remote, it then “ages out” of the table. When traffic is detected it is included again in the table. This optimizes memory space utilization.

- **via Remote**—Hardware address of the radio connected to this device.
- **RxPkts**—Over-the-air data packets received by the transceiver, and passed on to the endpoint device.
- **TxPkt**—Number of packets received from the endpoint device and passed over-the-air.

## 2.8.7 Remote Performance Listing Menu (Access Points Only)



```

Town Hall AP
Remote Performance Listing Menu
-----
MAC Address      RxRate  RxPkts  TxPkts  RxBCMC  RxViaEP  TxViaEP  RetryErrs
00:06:3d:00:0c:0e 256 kbps 67566   67563   4        0         0         0
00:06:3d:00:06:d4 256 kbps  5        3        3        0         0         0
00:06:3d:00:05:ec 512 kbps 13       10       5        0         0         0
00:06:3d:00:69:04 512 kbps  7        3        5        0         0         0

Number of remotes: 4
Page 1 of 1

Select a letter to configure an item, <ESC> for the prev menu
  
```

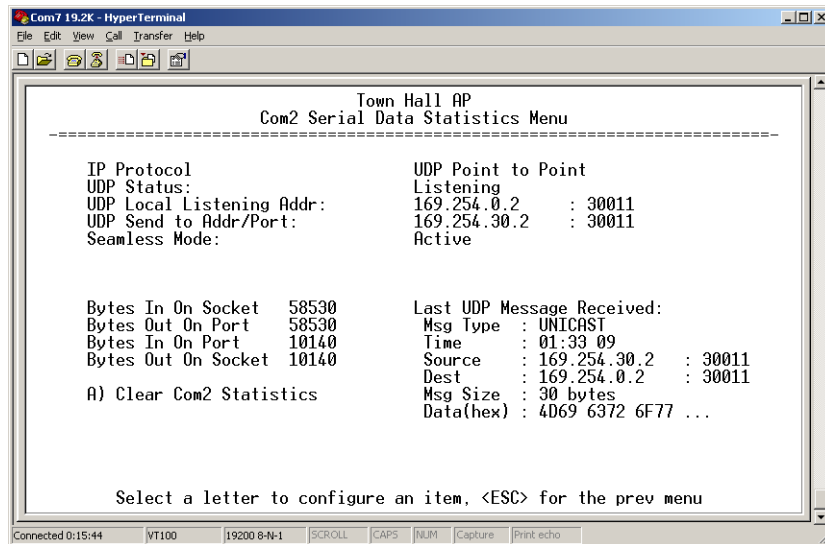
**Figure 2-60. Remote Performance Listing Menu for iNET AP**  
(iNET-II will show RxRate as 512 kbps or 1024 kbps)

This screen provides a unit-by-unit summary of all Remote units currently associated with this Access Point. The parameters are displayed in a column format with each line corresponding to one Remote.

- **RxRate**—Over-the-air data rate the radio is currently using. All transceivers do not need to use the same rate.
- **RxPkts**—Over-the-air data packets received from this unit.
- **TxPkts**—Over-the-air data packets sent to this unit.
- **RxBCMC**—Total number of Broadcast and/or Multicast packets received over-the-air.
- **RxViaEP**—Packets received by the transceiver through the Ethernet port.
- **TxViaEP**—Packets sent by the transceiver through the Ethernet port.
- **RetryEr**—Packets discarded after exceeding five retries over-the-air.

## 2.8.8 Serial Data Statistics Menu

This screen provides a summary of port activity for both serial data ports. These values will be reset to zero after a reboot cycle.



```

Com7 19.2K - HyperTerminal
File Edit View Call Transfer Help
-----
Town Hall AP
Com2 Serial Data Statistics Menu
-----
IP Protocol                               UDP Point to Point
UDP Status:                               Listening
UDP Local Listening Addr:                  169.254.0.2   : 30011
UDP Send to Addr/Port:                    169.254.30.2 : 30011
Seamless Mode:                           Active

Bytes In On Socket  58530                 Last UDP Message Received:
Bytes Out On Port   58530                 Msg Type   : UNICAST
Bytes In On Port    10140                 Time      : 01:33 09
Bytes Out On Socket 10140                 Source    : 169.254.30.2   : 30011
                                                Dest     : 169.254.0.2   : 30011
A) Clear Com2 Statistics                 Msg Size  : 30 bytes
                                                Data(hex) : 4D69 6372 6F77 ...

Select a letter to configure an item, <ESC> for the prev menu
-----
Connected 0:15:44  VT100  19200 8-N-1  SCROLL  CAPS  NUM  Capture  Print echo

```

**Figure 2-61. Serial Data Statistics Screen**  
(Both COM1 and COM2 will be shown)

- **Bytes in on port**—Number of bytes received by the transceiver through the serial interface
- **Bytes out on port**—Number of bytes transmitted by the transceiver through the serial interface
- **Bytes in on socket**—Number of bytes received by the transceiver through the IP socket
- **Bytes out on socket**—Number of bytes transmitted by the transceiver through the IP socket

In general, the number of bytes **Out on Socket** should follow the number of bytes **In On Port** as all bytes received on the serial port should be transmitted out to the IP interface. The same should be true in the opposite direction, bytes **Out On Port** should follow bytes **In On Socket**.

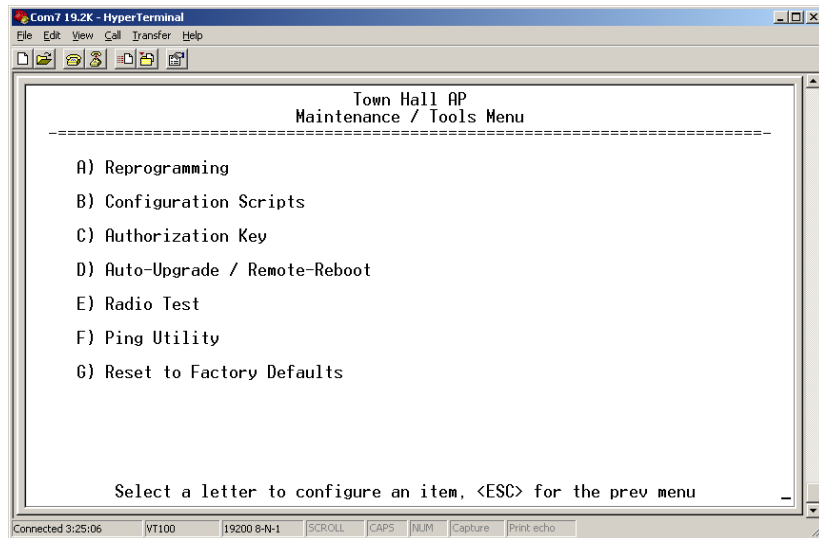
- **Clear Com1 Statistics**—Resets counter to zero.
- **Clear Com2 Statistics**—Resets counter to zero.

## 2.9 MAINTENANCE

In the normal course of operating a wireless network, you will want to take advantage of product improvements, and to read and archive the configuration of your individual transceivers using the *Maintenance Menu*. This section provides detailed information on how to take advantage of these services.

The maintenance tasks are:

- **Reprogramming**— Managing and selecting the unit’s operating system firmware resources. (See “Reprogramming Menu” on Page 100)
- **Configuration Scripts**— Saving and importing data files containing unit operating parameters/settings. (See “Configuration Scripts Menu” on Page 105)
- **Authorization Key**— Alter the unit’s overall capabilities by enabling the built-in resources. (See “Authorization Keys Menu” on Page 108)
- **Auto-Upgrade/Remote-Reboot**— Configure when remotes retrieve new firmware versions from the associated AP, and whether or not they reboot to the new firmware after receiving the new firmware. (See “Auto-Upgrade/Remote-Reboot Menu” on Page 108)
- **Radio Test**— A diagnostic tool for testing RF operation. (See “Radio Test Menu” on Page 110)
- **Ping Utility**— Diagnostic tool to test network connectivity. (See “Ping Utility Menu” on Page 111)



**Figure 2-62. Maintenance/Tools Menu**

### 2.9.1 Reprogramming Menu

The transceiver has two copies of the firmware (microprocessor code) used for the operating system and applications. One copy is “active” and the second one is standing by, ready to be used once activated. You can load new firmware into the inactive position and place it in service whenever you desire.

From time-to-time GE MDS offers upgrades to the transceiver firmware. Loading new firmware into the unit will not alter any privileges provided by Authorization Keys and does *not* require the transceiver be

taken off-line until you want to operate the unit from the newly installed firmware image.

Firmware images are available free-of-charge at:  
[www.GEMds.com/service/technical/support](http://www.GEMds.com/service/technical/support)

---

**NOTE:** GE MDS iNET firmware may *not* be installed in GE MDS iNET-II radios, or vice-versa.

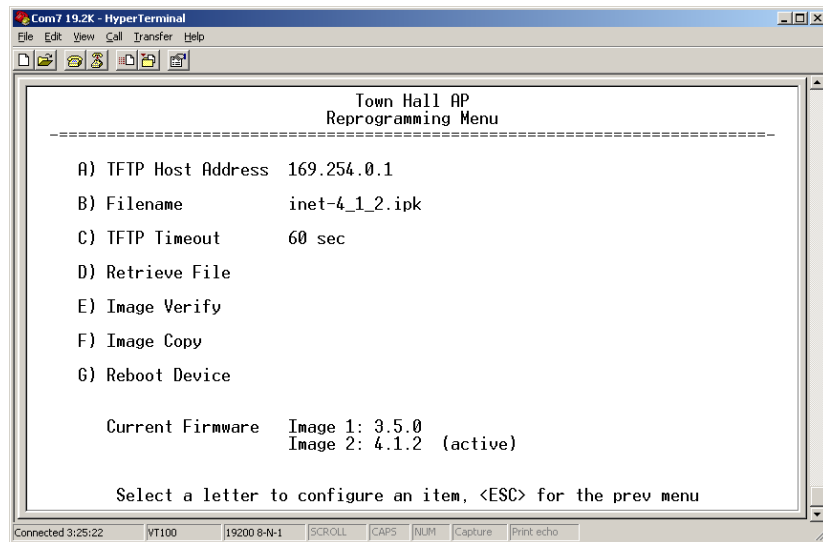
---

**NOTE:** When upgrading to firmware 6.0.0 or later, the unit creates internal files following the first reboot. This one-time process delays the response of the HTTP interface for 5-10 minutes. If DC power is cycled (turned off and back on) during this process, the files will have to be created again. It is recommended that you wait until this 5-10 minute process is complete before verifying operation of HTTP, HTTPS, or SSH.

---

**NOTE:** Always read the release notes for downloaded firmware. Some versions may not be compatible over the air, or with the particular unit you have.

---



**Figure 2-63. Reprogramming Menu**  
*(Shown with "Image Copy" Selected)*

- **TFTP Host Address**— IP address of the host computer from which to get the file. **[Any valid IP address]** This same IP address is used in other screens/functions (reprogramming, logging, etc.). Changing it here also changes it for other screens/functions.
- **Filename**— Name of file to be received by the TFTP server. **[Any 40-character alphanumeric string]** Verify that this corresponds to the TFTP directory location. May require sub-directory, for example: `\firmware\inet\inet-4_4_0.ipk`.

- **TFTP Timeout**—Time in seconds the TFTP server will wait for a packet ACK (acknowledgment) from the *transceiver* before canceling the file transfer. [2 to 60 seconds; 10]
- **Retrieve File**—Initiates the file transfer from the TFTP server. The new file is placed into inactive firmware image. [Y, N]
- **Image Verify**—Initiate the verification of the integrity of firmware file held in unit.
- **Image Copy**—Initiate the copying of the active firmware into the inactive image.
- **Reboot Device**—Initiate rebooting the *transceiver*. This will interrupt data traffic through this unit, and the network if performed on an Access Point. Intended to be used to toggle between firmware images.

**NOTE:** See “Upgrading the Firmware” on Page 102 for details on setting up the TFTP server.

## Upgrading the Firmware

Firmware images are available free-of-charge at:  
[www.GEmds.com/service/technical/support](http://www.GEmds.com/service/technical/support)

---

**NOTE:** GE MDS iNET firmware may *not* be installed in GE MDS iNET-II radios, or vice-versa.

---

To install firmware by TFTP, you will need:

- A PC with a TFTP server running.
- The IP address of the PC running the TFTP server.
- A valid firmware file

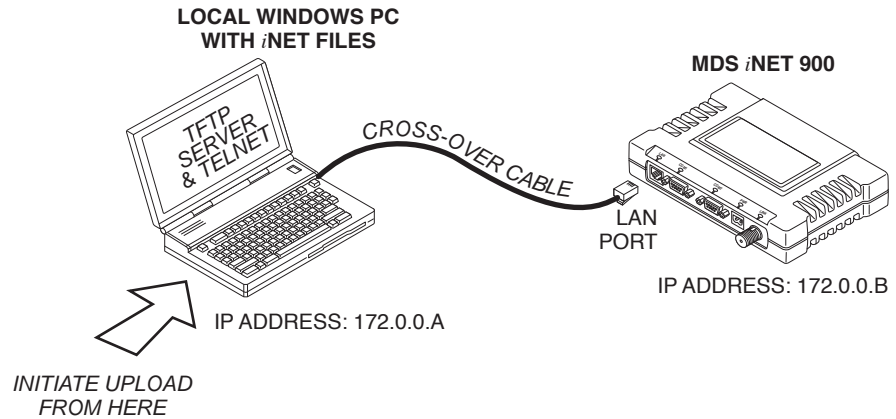
The IP address of the radio can be found under the Management Systems’ **Configuration** menu. (See “Network Configuration Menu” on Page 37.)

A TFTP server is available on the GE MDS Web site at:  
[www.GEmds.com/service/technical/support/downloads.asp](http://www.GEmds.com/service/technical/support/downloads.asp)

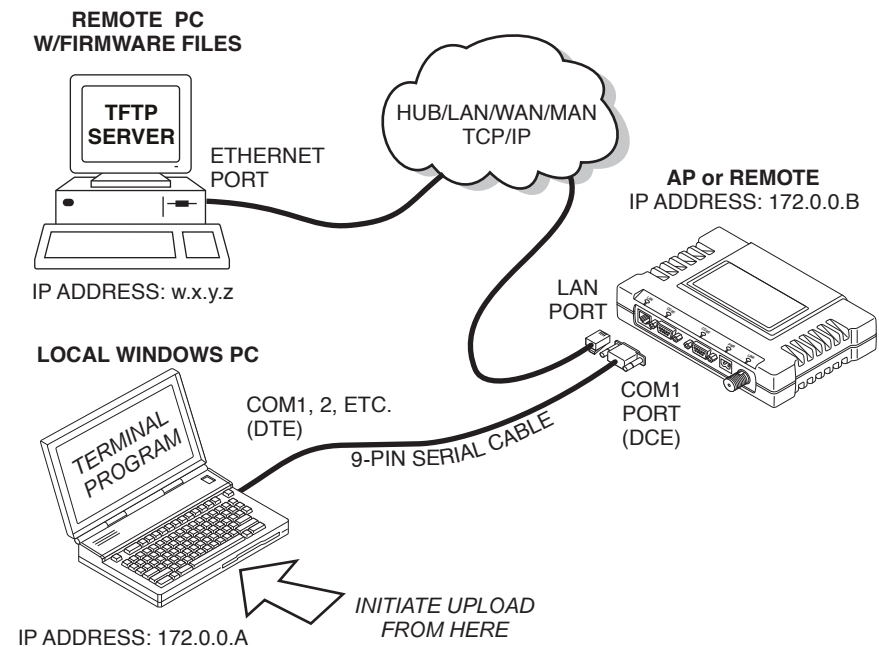
**TIP:** If you do not know your computer’s address on a Windows PC, you can use the **RUN** function from the **Start** menu and enter **winiipcfg** or **ipconfig** to determine your local PC’s IP address.

There are several alternatives to connecting the transceiver for firmware upgrade. Figure 2-64 and Figure 2-65 show two variations. It is essential all of the equipment be on the same subnet.





**Figure 2-64. Firmware Upgrade Setup—Option 1**  
(TFTP Server and Firmware File on Same CPU)



**Figure 2-65. Firmware Upgrade Setup—Option 2**  
(TFTP Server and Firmware File on Remote Server)

**NOTE:** The LAN and COM1 ports share a common data channel when loading firmware over-the-air. Transferring the radio firmware image file ( $\approx 3$  Mb), may take several minutes depending on traffic between the TFTP server and the transceiver.

Regardless of your connection to the transceiver, loading firmware/configuration files into the unit's flash-RAM is much slower than loading software onto a PC hard drive or RAM.

**Upgrade Procedure**

To load a new firmware file (`filename.ipk`) into the transceiver, use the following procedure:

1. Launch a TFTP server on a PC connected either directly or via a LAN to the Ethernet port (LAN) of the radio. Point the server towards the directory containing the firmware image file.
2. Connect to the Management System by whichever means is convenient: Browser or Telnet via the LAN, or Terminal emulator via the COM1 port.
3. Go to the MS Reprogramming Menu.  
(Main Menu>>Maintenance Menu>>Reprogramming Menu)
4. Fill in the information for the:
  - **TFTP Host Address**—IP Address of server (host computer) running TFTP server.
  - **Retrieve File**—Name of file (**filename.ipk**) to be pulled from the TFTP server holding the firmware file.
5. Pull the firmware file through the TFTP server into the transceiver.  
(Main Menu>>Maintenance Menu>>Reprogramming Menu>>Retrieve File)  
  
Status messages on the transfer are posted on the Management System screen.

---

**NOTE:** The new firmware image file that replaces the “Inactive Image” file will be automatically verified.

---

6. Reboot the transceiver.  
**Main Menu>>Maintenance Menu>>Reprogramming Menu>>Reboot Device**
7. Test the transceiver for normal operation.

*End of Procedure*

## **Error Messages During File Transfers**

It is possible to encounter errors during a file transfer. In most cases errors can be quickly corrected by referring to Table 2-6.

**Table 2-6. Common Errors During TFTP Transfer**

<b>Error Message</b>	<b>Likely Cause/Corrective Action</b>
Invalid File Type	Indicates that the file is not a valid firmware file. Locate proper file and re-load.
File not found	Invalid or non-existent filename on TFTP server
Invalid file path	Invalid or non-existent file path to TFTP server
Timeout	TFTP transfer time expired. Increase the timeout value.
Flash Error	Flash memory error. Contact factory for assistance.

**Table 2-6. Common Errors During TFTP Transfer (Continued)**

Error Message	Likely Cause/Corrective Action
Bad CRC	Cyclic Redundancy Check reporting a corrupted file. Attempt to re-load, or use a different file.
Version String Mismatch	Invalid file detected. Attempt to re-load, or use a different file.
Sending LCP Requests	The PPP server is querying for any clients that may need to connect.
Port not Enabled	The serial port is disabled.

## 2.9.2 Configuration Scripts Menu

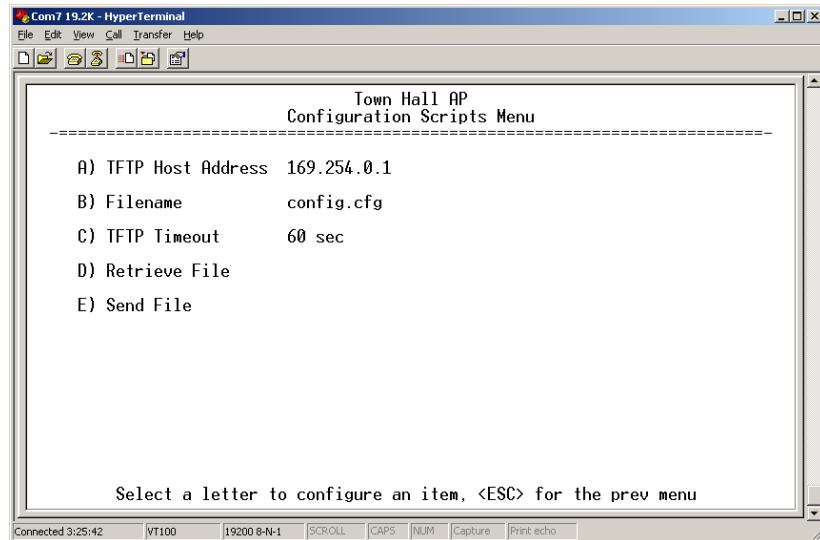
A configuration script file contains all of the settable parameters of a radio that are accessible through the menu interface, with a few exceptions. A configuration script file is in plain text format and can be easily edited in a text program.

Configuration scripts can be helpful in several ways. Three common uses for them are:

- To save and restore known-good configuration files from your radios.
- To facilitate the configuration of a large number of radios.
- To provide troubleshooting information when you contact the factory for technical support.

### How Configuration Files Work

When a configuration script file is downloaded to a radio (**Retrieve**), the radio executes the parameters as commands and takes the values contained in it. When a configuration script file is uploaded from the radio (**Send**) it contains the current values of the parameters that the radio is configured with. Figure 2-66 below shows the Configuration Scripts Menu.



**Figure 2-66. Configuration Scripts Menu**

- **TFTP Host Address**— IP address of the computer on which the TFTP server resides. [**Any valid IP address**]
- **Filename**— Name of file containing this unit’s configuration profile that will be transferred to the TFTP server. The configuration information will be in a plain-text ASCII format. [**Any 40-character alphanumeric string**] May require a sub-directory, for example: **config\inet-config.txt**. (See “Configuration Scripts Menu” on Page 105 for more information.)

---

**NOTE:** The filename field is used to identify the desired incoming file and as the name of the file being exported to the TFTP server. Before exporting a unit’s configuration, you may want to name it in a way that reflects the radio’s services or other identification.

- **TFTP Timeout**— Time in seconds the TFTP server will wait for a packet ACK (acknowledgment) from the *transceiver* before suspending the file transfer. [**10 to 120 seconds; 10**]
- **Retrieve File**— Initiate the file transfer of the configuration file from TFTP server into the transceiver.
- **Send File**— Initiate the file transfer from the transceiver’s current configuration file to TFTP server.

---

**NOTE:** See “Upgrading the Firmware” on Page 102 for details on setting up the TFTP server.

### Sample of Configuration Script File

A sample configuration script file is provided as part of every firmware release. The name of the file is followed by the revision number. For example, the sample file for firmware revision 2.1.0 is:  
**inet2-config-2\_1\_0.txt.**

## Editing Configuration Files

Once a Remote unit's operation is fine-tuned, use the Configuration Scripts Menu on Page 105 to save a copy of the configuration on a PC. Once the file is saved on the PC it can be used as a source to generate modified copies adjusted to match other devices. The configuration files can be modified using a text editor or an automated process. (These applications not provided by GE MDS).

We recommend that you review and update the following parameters for each individual unit. Other parameters may also be changed as necessary. Each resulting file should be saved with a different name. We recommend using directories and file names that reflect the location of the unit to facilitate later identification.

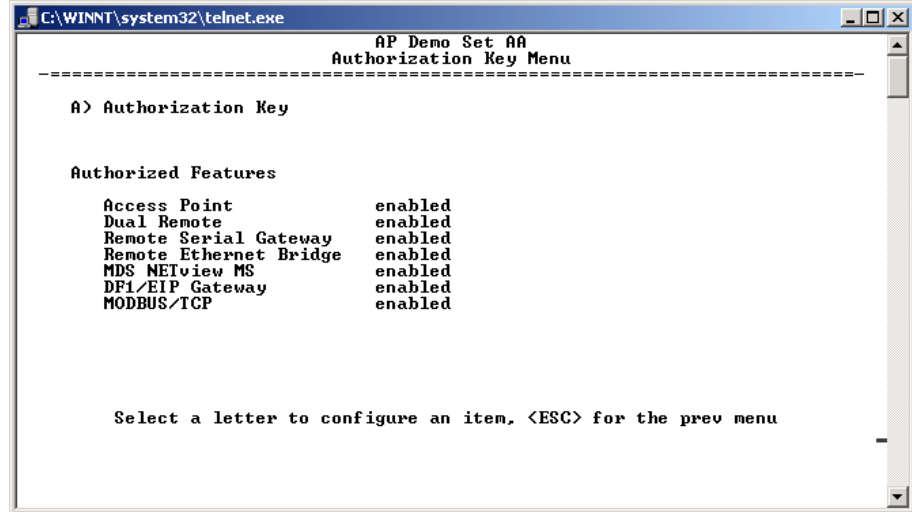
**Table 2-7. Common User-Alterable Parameters**

Field	Comment	Range
IP Address	Unique for each individual radio	Any legal IP address
IP Gateway	May change for different groups or locations	Any legal IP address
Unit Name	Should reflect a specific device. This information will appear in Management System headings	Any 20-character alphanumeric string
Location	Used only as reference for network administration	Any 40-character alphanumeric string

### Editing Rules

- You may include only parameters you want to change from the default value.
- Change only the parameter values.
- Capitalization counts in some field parameters. (Example: System Mode)
- Comment Fields
  - a. Edit, or delete anything on each line to the right of the comment delineator, the semicolon (;).
  - b. Comments can be of any length, but must be on the same line as the parameter, or on a new line that begins with a semicolon character.
  - c. Comments after parameters in files exported from a transceiver do not need to be present in your customized files.
- Some fields are read-only. These are designated by “(RO)” in the configuration sample file.

## 2.9.3 Authorization Keys Menu



**Figure 2-67. Authorization Key Menu**

- **Authorization Key**—Initiate the entering of an Authorization Key into the transceiver’s non-volatile memory.
- **Authorized Features**—List of authorized features available for use [enabled, disabled].

GE MDS iNET-II radios will show an additional selection called **Encryption** under Authorized Features.

## 2.9.4 Change the Type of Remote

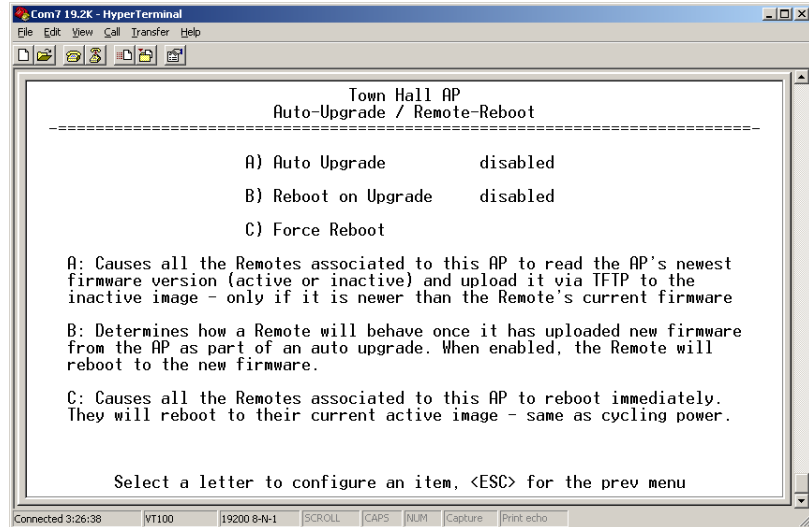
Enter the serial number of the unit to be changed in the **Auth Key** field to turn a Serial Gateway Remote into an Ethernet Bridge Remote, or vice-versa.

## 2.9.5 Auto-Upgrade/Remote-Reboot Menu

---

**NOTE:** This menu is only available when GE MDS NETview MS key is enabled.

---



**Figure 2-68. Auto-Upgrade / Remote Reboot Menu**

- **Auto Upgrade**— Causes all of the Remotes associated to this AP to read the AP’s newest firmware version (active or inactive) and upload it via TFTP to the inactive image, but only if it is newer than the Remote’s current firmware.
- **Reboot on Upgrade**— Determines how a Remote will behave once it has uploaded new firmware from the AP as part of an auto-upgrade. When enabled, the Remote will reboot to the new firmware.
- **Force Reboot**— Causes all of the Remotes associated to this AP to reboot immediately. They will reboot to their current active image—the same as if the power were re-cycled.

---

**NOTE:** To use the Auto Upgrade/Reboot feature, both the AP and Remotes must already be running version 4.4.0 or newer firmware.

Exception: If the AP has already been upgraded to version 4.4.0 and the Remote is still at 3.5.0 or older, you can upgrade the Remote by using the AP as a file server. This method allows for only one remote to be upgraded at a time. Instructions for this method are given below.

---

### **Firmware Upgrade (with AP Acting as a TFTP Server)**

An AP running firmware version 4.4.0 (or newer) may be used as a file server to upgrade Remotes running older firmware (3.5.0 or earlier). Follow the steps below to perform the upgrade:

1. At the Reprogramming Menu (Page 101), Enter the AP’s IP Address in the TFTP Server field.
2. Enter **upgrade\_from\_ap.ipk** in the Filename field.

---

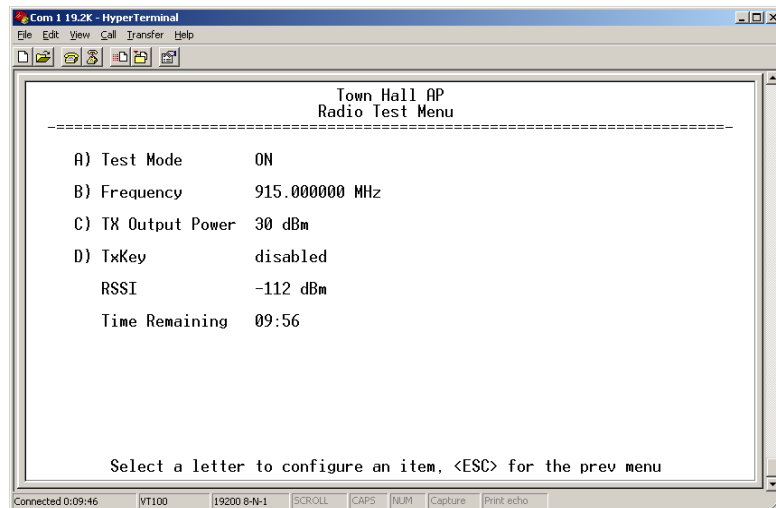
**NOTE:** The filename is case sensitive.

---

3. Perform the firmware download.

## 2.9.6 Radio Test Menu

Using this menu, you can manually key the radio transmitter to make measurements of antenna performance. (See “Antenna Aiming” on Page 141 for details.)



**Figure 2-69. Radio Test Menu**  
*Shown with Test Mode set to ON*

---

**NOTE :** Use of the Test Mode will disrupt traffic through the radio. If the unit is an Access Point, it will disrupt traffic through the *entire* network.

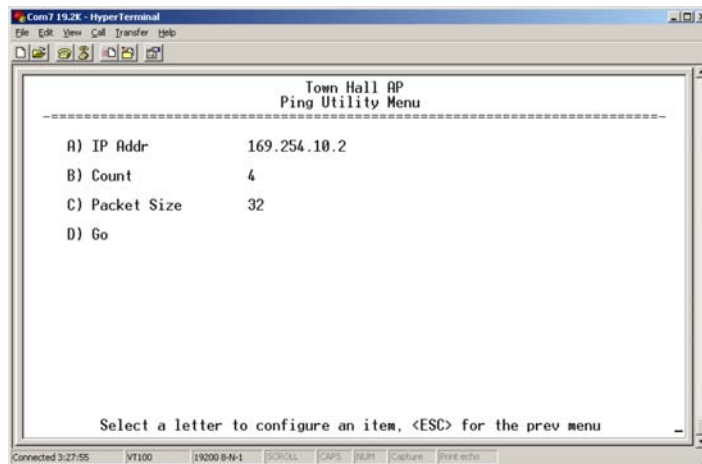
Test Mode function is automatically limited to 10 minutes and *should only be used for brief measurement of transmit power*. It may also be manually reset to continue with the testing or turned off.

- 
- **Test Mode**— Controls access to the transceiver’s suite of tools. [ON, OFF; OFF]
  - **Frequency**— Set radio operating frequency during the testing period to a single frequency. [915.0000 MHz]
  - **TX Output Power**— Temporarily overrides the power level setting in the Radio Configuration Menu. [20]
  - **TxKey**— Manually key the radio transmitter for power measurements. [Enable, Disable; Disable]



- **RSSI**—Incoming received signal strength on frequency entered in the frequency parameter on this screen (–dBm). This RSSI measurement is updated more frequently than the RSSI by Zone display of the Performance Information menu. Note that for the GE MDS iNET, the RSSI is an average of the RSSI samples. The RSSI value is reset every time the radio returns to scanning mode.

## 2.9.7 Ping Utility Menu



**Figure 2-70. Ping Utility Menu**

- **IP Addr**—Address to send a PING. [**Any valid IP address**]
- **Count**—Number of PING packets to be sent.
- **Packet Size**—Size of each PING data packet (bytes).
- **Go**—Send PING packets to address shown on screen.

Screen will be replaced with detailed report of PING activity. Press any key after viewing the results to return to this menu.

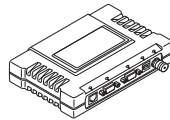
## 2.9.8 Reset to Factory Defaults

To reset all transceiver parameters back to the factory defaults, including the password, you must enter a special code (authorization key) provided by the factory in place of the user name at the time of login.

This procedure is useful when several parameters have been modified, and there is no track of changes. It causes the transceiver to return to a known state.

### Password Reset

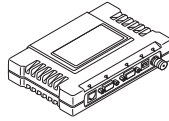
As part of the reset action the transceiver’s password is reverted to the default value of **admin**. As a security measure, this event causes all radio parameters to return to the factory default settings, including zone skipping (as applicable), baud rate settings, network name, security phrase, etc.



# 3 TROUBLESHOOTING

## Contents

3.1	Interpreting the Front Panel LEDs .....	115
3.2	Troubleshooting Using the Embedded Management System .	116
3.2.1	Starting Information Screen .....	117
3.2.2	Packet Statistics Menu .....	118
3.2.3	Serial Port Statistics Menu .....	119
3.2.4	Diagnostic Tools .....	119
3.3	Using Logged Operation Events.....	119
3.4	Alarm Conditions.....	120
3.5	Correcting Alarm Conditions.....	121
3.6	Logged Events.....	123



Successful troubleshooting of a wireless system is not difficult, but requires a logical approach. It is best to begin troubleshooting at the Access Point unit, as the rest of the system depends on the Access Point for synchronization data. If the Access Point has problems, the operation of the entire wireless network will be affected.

When communication problems are found, it is good practice to begin by checking the simple things. Applying basic troubleshooting techniques in a logical progression can identify many problems.

### ***Multiple Communication Layers***

It is important to remember the operation of the network is built upon a radio communications link. On top of that are two data levels— wireless MAC, and the data layer. It is essential that the wireless aspect of the Access Point and the Remotes units to be associated are operating properly before data-layer traffic will function.

### ***Unit Configuration***

There are over 50 user-configurable parameters in the Management System. Do not overlook the possibility that human error may be the cause of the problem. With so many possible parameters to look at and change, a parameter may be incorrectly set, and then what was changed is forgotten.

To help avoid these problems, we recommend creating an archive of the transceiver's profile when your installation is complete in a Configuration File. This file can be reloaded into the transceiver to restore the unit to the factory defaults or your unique profile. For details on creating and archiving Configuration Files, Configuration Scripts Menu on Page 105.

### ***Factory Assistance***

If problems cannot be resolved using the guidance provided here, review the GE MDS web site's technical support area for recent software/firmware updates, general troubleshooting help, and service information. Additional help is available through our Technical Services Department. (See "TECHNICAL ASSISTANCE" on the inside of the rear cover.)

## **3.1 Interpreting the Front Panel LEDs**

An important set of troubleshooting tools are the LED status indicators on the front panel of case. You should check them first whenever a problem is suspected. Table 3-1 below provides suggestions for

resolving common system difficulties using the LEDs, and Table 3-2 provides other simple techniques.

**Table 3-1. Troubleshooting Using LEDs—Symptom-Based**

Symptom	Problem/Recommended System Checks
PWR LED does not turn on	<ul style="list-style-type: none"> <li>a. Voltage too low—Check for the proper supply voltage at the power connector. (10–30 Vdc)</li> <li>b. Indefinite Problem—Cycle the power and wait (<math>\approx</math> 30 seconds) for the unit to reboot. Then, recheck for normal operation.</li> </ul>
LINK LED does not turn on	<ul style="list-style-type: none"> <li>a. Network Name of Remote not identical to desired Access Point—Verify that the system has a unique Network Name.</li> <li>b. Not yet associated with an Access Point with the same Network Name.  Check the “Status” of the unit’s process of associating with the Access Point. Use the Management System.</li> <li>c. Poor Antenna System—Check the antenna, feedline and connectors. Reflected power should be less than 10% of the forward power reading (SWR 2:1 or lower).</li> </ul>
PWR LED is blinking	<ul style="list-style-type: none"> <li>a. Blinking indicates an alarm condition exists.</li> <li>b. View Current Alarms and Event Log and correct the problem if possible. (See “Using Logged Operation Events” on Page 119)</li> <li>c. Blinking will continue until the source of the alarm is corrected, for example, a valid IP address is entered, etc.</li> </ul>
LAN LED does not turn on	<ul style="list-style-type: none"> <li>a. Verify the Ethernet cable is connect at both ends.</li> <li>b. Verify that the appropriate type of Ethernet cable is used: straight-through, or crossover.</li> </ul>
LAN LED lights, but turns off after some time	Verify traffic in LAN. Typically, the radio should not be placed in high traffic enterprise LANs, as the it will not be able to pass this level of traffic. If needed, use routers to filter traffic.

## 3.2 Troubleshooting Using the Embedded Management System

If you have reviewed and tried the things mentioned in Table 3-1 and still have not resolved the problem, there are some additional tools and techniques that can be used. The embedded Management System is a good source of information that may be used remotely to provide preliminary diagnostic information, or may even provide a path to correcting the problem.

**Table 3-2. Basic Troubleshooting Using the Management System**

Symptom	Problem/Recommended System Checks
Remote does not associate; stays in HOPSYNC	<ol style="list-style-type: none"> <li>Verify the AP has sufficiently large number in the “Max Remotes” parameter of the Network Configuration Menu.</li> <li>Verify the correct MAC address is listed in the “Approved Remotes List” or “Approved Access Points List” of the Security Configuration menu.</li> </ol>
Serial data is slow with UDP multicast traffic	Change Beacon Period to FAST. (Radio Configuration Menu)
Cannot access the MS through COM1	<ol style="list-style-type: none"> <li>Connect to unit via Telnet or Web browser</li> <li>Disable the serial mode for COM1 (Serial Gateway Configuration&gt;&gt;Com1 Serial Data Port&gt;&gt;Status&gt;&gt;Disabled)  or, if you know the unit’s data configuration:               <ol style="list-style-type: none"> <li>Connect to COM 1 via a terminal set to VT100 and the port’s data baud rate.</li> <li>Type <b>+++</b></li> <li>Change the terminal’s baud rate to match the transceiver’s Console Baud Rate.</li> <li>Type <b>+++</b></li> </ol> </li> </ol>
Display on terminal/Telnet screen garbled	Verify the terminal/terminal emulator or Telnet application is set to VT100
Cannot pass IP data to WAN.	<ol style="list-style-type: none"> <li>Verify your IP settings.</li> <li>Use the PING command to test communication with the transceivers in the local radio system.</li> <li>If successful with local PING, attempt to PING an IP unit attached to a transceiver.</li> <li>If successful with the LAN PINGs, try connecting to a known unit in the WAN.</li> </ol>
Wireless Retries too high.	Possible Radio Frequency Interference— <ol style="list-style-type: none"> <li>If omnidirectional antennas are used, consider changing to directional antennas. This will often limit interference to and from other stations.</li> <li>Try skipping some zones where persistent interference is known or suspected.</li> <li>The installation of a filter in the antenna feedline may be necessary. Consult the factory for further assistance.</li> </ol>
Password forgotten.	<ol style="list-style-type: none"> <li>Connect to the transceiver using a terminal through the COM1 Port.</li> <li>Obtain a password-resetting Authorization Key from your factory representative.</li> <li>Enter the Authorization Key at the login prompt as a password.</li> </ol>
Packet Repeat Mode troubles (extra characters in data, data not delivered)	Verify that all radios in the network have their Packet Redundancy Mode set to the same selection (Single Packet vs. Packet Repeat Mode).

The following is a summary of how several screens in the Management System can be used as diagnostic tools.

### 3.2.1 Starting Information Screen

(See Starting Information Screen on Page 32)

The Management System’s “homepage” provides some valuable bits of data. One of the most important is the “Device Status” field. This item will tell you if the unit is showing signs of life.

If the *Device Status* field says “associated,” then look in the network areas beginning with network data statistics. If it displays some other message, such as *Scanning*, *Hop Sync* or *Alarmed*, you will need to determine why it is in this state.

The Scanning state indicates a Remote unit is looking for an Access Point beacon signal to lock onto. It should move to the Hop Sync and finally to the Associated state within less than a minute. If this Remote unit is not providing reliable service, look at the *Event Logs* for signs of lost association with the Access Point or low signal alarms. Table 3-3 provides a description of the Device Status messages.

**Table 3-3. Device Status<sup>1</sup>**

<b>Scanning</b>	The unit is looking for an Access Point beacon signal. If this is a Remote radio, <i>Associated</i> means that this unit is associated with an Access Point
<b>Hop Sync</b>	The unit has found a valid beacon signal for its network and has changed its frequency hopping pattern to match that of the AP.
<b>Connected</b>	The unit has established a radio (RF) connection with the Access Point, but has not obtained cyber-security clearance to pass data.
<b>Associated</b>	This unit has successfully synchronized and is “associated” with an Access Point. This is the normal operating state.
<b>Alarmed</b>	The unit is has detected one or more alarms that have not been cleared.

1. Available in the *Startup Information Screen* or the *Wireless Status Screen* at the Remotes.

If the Remote is in an “Alarmed” state, the unit may still be operational and associated. Look for the association state in the *Wireless Network Status* screen to determine if the unit is associated. If it is, then look at the *Error Log* for possible clues.

If the unit is in an “Alarmed” state and not able to associate with an Access Point unit, then there may be problem with the wireless network layer. Call in a radio technician to deal with wireless issues. Refer the technician to the RADIO (RF) MEASUREMENTS on Page 139 for information on antenna system checks.



### 3.2.2 Packet Statistics Menu

(See Packet Statistics Menu on Page 91)

This screen provides detailed information on data exchanges between the unit being viewed and the network through the wireless and the Ethernet (data) layers. These include:

#### Wireless Packet Statistics

- Packets received
- Packets sent
- Bytes received
- Bytes sent
- Packets dropped
- Receive errors
- Retries
- Retry errors

#### Ethernet Packet Statistics

- Packets received
- Packets sent
- Bytes received
- Bytes sent
- Packets dropped
- Receive errors
- Retries
- Retry errors
- Lost carrier detected

The most significant fields are the *Packets Dropped*, *Retries*, *Retry Errors*, *Receive Errors* and *Lost Carrier Detected*. If the data values are more than 10% of their sent and received counterparts, or the *Lost Carrier Detected* value is greater than a few dozen, there may be trouble with radio-frequency interference or a radio link of marginal strength. Review the *RSSI by Zone Screen's* values (Page 87) for zones that are more than 2 dB (decibels) below the average level, and for signal level values that are likely to provide marginal service. For example, an average level is less than -85 dBm during normal conditions with a data rate of 256 kbps.

If the RSSI levels in each zone are within a few dB of each other, but less than -85 dBm, then a check should be made of the aiming of the antenna system and for a satisfactory SWR. Refer to RADIO (RF) MEASUREMENTS on Page 139 for information on antenna system checks.

---

**NOTE:** For a data rate of 512 kbps (1 Mbps for iNET-II), the average signal level should be -77 dBm or stronger with no interference.

---

### 3.2.3 Serial Port Statistics Menu

(See Serial Data Statistics Menu on Page 99)

This screen provides top-level information on data exchanges between the unit's serial ports and the network through the wireless and the Ethernet (data) layers. These include:

You can use this screen as a indicator of port activity at the data and IP levels.

- Bytes In On Port xxx
- Bytes In On Socket xxx
- Bytes Out On Port xxx
- Bytes Out On Socket xxx

### 3.2.4 Diagnostic Tools

(See MAINTENANCE on Page 99)

The radio’s Maintenance menu contains two tools that are especially useful to network technicians—the Radio Test Menu and the Ping Utility. The Radio Test selection allows for testing RF operation, while the Ping Utility can be used to verify reachability to pieces of equipment connected to the radio network. This includes transceivers and user-supplied Ethernet devices.

## 3.3 Using Logged Operation Events

(See Event Log Menu on Page 88)

The transceiver’s microprocessor monitors many operational parameters and logs them as various classes of “events”. If the event is one that affects performance, it is an “alarmed”. There are also normal or routine events such as those marking the rebooting of the system, implementation of parameter changes and external access to the Management System. Informational events are stored in temporary (RAM) memory that will be lost in the absence of primary power, and Alarms will be stored in permanent memory (Flash memory) until cleared by user request. Table 2-5 summarizes these classifications.

**Table 3-4. Event Classifications**

Level	Description/Impact	Storage
Informational	Normal operating activities	Flash Memory
Minor	Does not affect unit operation	RAM
Major	Degraded unit performance but still capable of operation	RAM
Critical	Prevents the unit from operating	RAM

These various events are stored in the transceiver’s “Event Log” and can be a valuable aid in troubleshooting unit problems or detecting attempts at breaching network security.

## 3.4 Alarm Conditions

(See View Current Alarms on Page 90)

Most events, classified as “critical” will make the PWR LED blink, and will inhibit normal operation of the transceiver. The LED blinks until the corrective action is completed.

**Table 3-5. Alarm Conditions (Alphabetical Order)**

<b>Alarm Condition Reported</b>	<b>Event Log Entry</b>	<b>SNMP Trap</b>
EVENT_50_LIMIT	Crossed 50% of Eth Port Rate Limit	rateLimit50(20)
EVENT_75_LIMIT	Crossed 75% of Eth Port Rate Limit	rateLimit75(21)
EVENT_100_LIMIT	Crossed 100% of Eth Port Rate Limit	rateLimit100(22)
EVENT_ADC	ADC output Railed	adcInput(3)
EVENT_AP_NN_CHANGED	Network Name changed at the AP	apNetNameChanged(74)
EVENT_BRIDGE	Network Interface /Error	networkInterface(17)
EVENT_NO_CHAN_CNT	Mismatch in Channel count at AP/REM	ChanCnt(71)
EVENT_NO_CHAN	Using Channel hopping but no channels selected	NoChan(23)
EVENT_COMPRESS	Compression setting changed	compressionChanged(76)
EVENT_ENDPOINT	Endpoint Added/Removed (AP only)	eventEndpoint(67)
EVENT_ETH_LINK_AP*	AP Ethernet Link Disconnected	apEthLinkLost(19)
EVENT_FLASH_TEST	Flash Test Failed	-
EVENT_FPGA	FPGA communication Failed	fpgaCommunication(2)
EVENT_FREQ_CAL	Frequency Not Calibrated	frequencyCal(7)
EVENT_INIT_ERR	Initialization Error	initializationError(18)
EVENT_IPADDR*	IP Address Invalid	ipAddressNotSet(4)
EVENT_IP_CONN(OK)		ipConnectivityOK(75)
EVENT_IPMASK*	IP Mask Invalid	ipNetmaskNotSet(5)
EVENT_LAN_PORT		lanPortStatus(78)
EVENT_MAC	MAC communication Failed	macCommunication(1)
EVENT_MACADDR	MAC Address Invalid	noMacAddress(6)
EVENT_NETNAME*	Netname Invalid	invalidNetname(12)
EVENT_PLL_LOCK	PLL Not locked	pllLock(10)
EVENT_POWER_CAL	Power Calibrated/Not Calibrated	powerCal(8)
EVENT_POWER_HIGH	RF Power Control Saturated High	rfPowerHigh(13)
EVENT_POWER_LOW	RF Power Control Saturated Low	rfPowerLow(14)

**Table 3-5. Alarm Conditions (Alphabetical Order) (Continued)**

Alarm Condition Reported	Event Log Entry	SNMP Trap
EVENT_REMOTE	Remote Added/ Removed (AP only)	eventRemote(66)
EVENT_REPETITIVE	The previous event is occurring repetitively	
EVENT_ROUTE_ADD	Manual entry added to Routing table	routeAdded(68)
EVENT_ROUTE_DEL	Manual entry deleted from Routing table	routeDeleted(69)
EVENT_RSSI*	RSSI Exceeds threshold	rss(11)
EVENT_RSSI_CAL	RSSI Not Calibrated	rssCal(9)
EVENT_SDB_ERR	Internal Remote/Endpoint database error (AP only)	sdbError(80)
EVENT_SINREM_SWITCH	Eth/Serial mode switch in a Single Remote	sinRemSwitch(70)
EVENT_SYSTEM_ERROR*	System Error Cleared; Please Reboot	systemError(16)
EVENT_TFTP_CONN	TFTP connectivity achieved	tftpConnection(73)
EVENT_TFTP_ERR	Attempted TFTP connection failed	tftpConnFailed(79)

\* Condition may be corrected by user and alarm cleared.

## 3.5 Correcting Alarm Conditions

(See View Event Log on Page 91)

Table 3-6 provides insight on the causes of events that inhibit the unit from operating, and possible corrective actions. The Event Description column appears on the **Event Log** screen.

**Table 3-6. Correcting Alarm Conditions—Alphabetical Order**

Event Log Entry	Generating Condition	Clearing Condition or Action
ADC Failure	The ADC always reads the same value (either high or low limit)	Contact factory Technical Services for assistance
AP Ethernet Link	Monitor will check state of Ethernet link and set alarm if it finds the link down	Ethernet link is re-established
Bridge Down	When the Bridge fails to be initialized	Contact factory Technical Services for assistance
Flash Test Failed	Internal check indicates corruption of Flash memory	Contact factory Technical Services for assistance
FPGA Failure	Communication lost to the FPGA	Contact factory Technical Services for assistance

**Table 3-6. Correcting Alarm Conditions—Alphabetical Order**

<b>Event Log Entry</b>	<b>Generating Condition</b>	<b>Clearing Condition or Action</b>
General System Error	Internal checks suggest unit is not functioning properly	Reboot the transceiver
Initialization Error	Unit fails to complete boot cycle	Contact factory Technical Services for assistance
Invalid IP Address	The IP address is either 0.0.0.0 or 127.0.0.1	Program IP address to something other than 0.0.0.0 or 127.0.0.1
MAC Failure	The monitor task reads the LinkStatus from the MAC every second. If the MAC does not reply 10 consecutive times (regardless of what the result is) the CPU assumes the transceiver has lost communication to the MAC.	Contact factory Technical Services for assistance
Network Interface Error	Unit does not recognize the LAN interface	Contact factory Technical Services for assistance
Network Name Not Programmed	Network name is “Not Programmed”	Change Network Name to something other than “Not Programmed”
PLL Out-of-Lock	The FPGA reports a synthesizer out-of-lock condition when monitored by the CPU.	Contact factory Technical Services for assistance.
Power Control Railed High	Power control can no longer compensate and reaches the high rail	Contact factory Technical Services for assistance
Power Control Railed Low	Power control can no longer compensate and reaches the low rail	Contact factory Technical Services for assistance
RSSI Exceeds Threshold	The running-average RSSI level is weaker (more negative) than the user-defined value.	Check aiming of the directional antenna used at the Remote; or raise the threshold level to a stronger (less-negative) value.

## 3.6 Logged Events

(See View Event Log on Page 91)

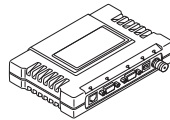
The following events allow the transceiver to continue operation and do not make the PWR LED blink. Each is reported through an SNMP trap. The left hand column, “Event Log Entry” is what will be shown in the Event Log.

**Table 3-7. Non-Critical Events—Alphabetical Order**

<b>Event Log Entry</b>	<b>Severity</b>	<b>Description</b>
Association Attempt Success/Failed	MAJOR	Self explanatory
Association Lost - AP Hop Parameter Changed	MINOR	Self explanatory
Association Lost - AP's Ethernet Link Down	MAJOR	Self explanatory
Association Lost - Local IP Address Changed	MAJOR	Self explanatory
Association Lost - Local Network Name Changed	MAJOR	Self explanatory
Association Lost/Established	MAJOR	Self explanatory
Auth Demo Mode Expired -- Rebooted Radio/Enabled	MAJOR	Self explanatory
Auth Key Entered - Key Valid/Key Invalid	MAJOR	Self explanatory
Bit Error Rate Below threshold/Above threshold	INFORMATIONAL	Self explanatory
Console Access Locked for 5 Min	MAJOR	Self explanatory
Console User Logged Out/Logged In	MAJOR	Self explanatory
Country/SkipZone Mismatch	INFORMATIONAL	Self explanatory
Current AP No Longer Approved	MAJOR	May occur during the Scanning process at a remote. Indicates that the received beacon came from an AP which is not in the "Approved AP" list. This may be caused by some remotes hearing multiple AP's. This event is expected behavior.
MAC Decryption Failed/MAC Decryption OK		A decryption error is logged when an encryption phrase mismatch has occurred. A mismatch is declared after five consecutive errors over a 40-second window. When the error has cleared, <b>MAC DECRYPT OK</b> will appear.
Desired AP IP Addr Mismatch	INFORMATIONAL	Self explanatory
ETH Rate		Indicates heavy bursts of traffic on the unit's Ethernet port (LAN). This is expected behavior, resulting from the network configuration.
Ethernet Port Enabled/Disabled	INFORMATIONAL	Self explanatory
Expected Sync Lost/Established	INFORMATIONAL	Self explanatory
Hop Sync Lost/Established	INFORMATIONAL	Self explanatory
Hop Table Generated/Generation Failed	INFORMATIONAL	Self explanatory
HTTP Access Locked for 5 Min	MAJOR	Self explanatory

**Table 3-7. Non-Critical Events—Alphabetical Order (Continued)**

<b>Event Log Entry</b>	<b>Severity</b>	<b>Description</b>
HTTP User Logged Out/Logged In	MAJOR	httpLogin(49)
Log Cleared	INFORMATIONAL	Self explanatory
MAC Param Changed		Caused by remotes running in auto data rate mode. Every time the link conditions cause a data rate change, the remote's MAC changes to the new rate and forwards a signal to the AP. This indicates link quality is changing and causing the data rate to adjust accordingly.
Max Beacon Wait Time Exceeded	MAJOR	Self explanatory
Received Beacon - AP is Blacklisted	INFORMATIONAL	Self explanatory
Received Beacon - Netname Does Not Match	INFORMATIONAL	Self explanatory
Received Beacon - Valid/Errored	INFORMATIONAL	Self explanatory
Rem Ethernet Link Connected/Disconnected	MAJOR	Self explanatory
Reprogramming Complete	INFORMATIONAL	Self explanatory
Reprogramming Failed	MAJOR	Self explanatory
Reprogramming Started	INFORMATIONAL	Self explanatory
Scanning Started	INFORMATIONAL	Self explanatory
SNR Within threshold/Below threshold	INFORMATIONAL	Self explanatory
System Bootup (power on)	INFORMATIONAL	Self explanatory
Telnet Access Locked for 5 Min	MAJOR	Self explanatory
Telnet User Logged Out/Logged In	MAJOR	Self explanatory
User Selected Reboot	MAJOR	Self explanatory



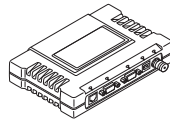




# 4 PLANNING A RADIO NETWORK

## Contents

4.1	INSTALLATION PLANNING .....	129
4.1.1	General Requirements .....	129
	DIN Rail Mounting Option .....	131
4.1.2	Site Selection .....	131
4.1.3	Terrain and Signal Strength .....	132
4.1.4	Antenna & Feedline Selection .....	132
4.1.5	How Much Output Power Can be Used? .....	135
4.1.6	Conducting a Site Survey .....	136
4.1.7	A Word About Radio Interference .....	136
4.1.8	Notes on Using 28 VDC Power Supplies .....	138
4.2	RADIO (RF) MEASUREMENTS.....	139
4.2.1	Antenna System SWR and Transmitter Power Output .....	140
	Introduction.....	140
	Procedure .....	140
4.2.2	Antenna Aiming .....	141
	Introduction.....	141
	Procedure .....	141
4.3	dBm-WATTS-VOLTS CONVERSION CHART.....	143
4.4	PERFORMANCE NOTES .....	144
4.4.1	Wireless Bridge .....	144
4.4.2	Distance-Throughput Relationship .....	144
4.4.3	Data Latency □ TCP versus UDP Mode .....	145
4.4.4	Data Compression .....	145
4.4.5	Packets-per-Second (PPS) .....	145
4.4.6	Station-to-Station Traffic .....	145
4.4.7	Interference has a Direct Correlation to Throughput .....	145
4.4.8	Maximizing Throughput .....	146
4.4.9	Placing an iNET Radio Behind a Firewall .....	147
4.5	SNMPv3 NOTES .....	147
4.5.1	Overview .....	147
	SNMPv3 Accounts.....	148
	Context Names.....	148
	Password-Mode Management Changes .....	149



## 4.1 INSTALLATION PLANNING

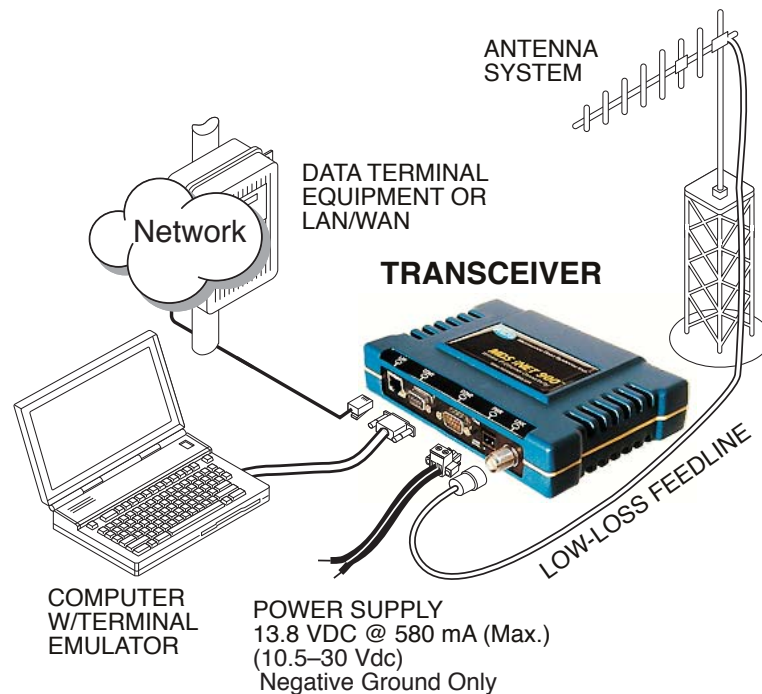
This section provides tips for selecting an appropriate site, choosing an antenna system, and reducing the chance of harmful interference.

### 4.1.1 General Requirements

There are three main requirements for installing a transceiver—adequate and stable primary power, a good antenna system, and the correct interface between the transceiver and the data device. Figure 4-1 shows a typical Remote Gateway installation.

**NOTE:** The iNET network port supports 10BaseT connections, but does not support 100BaseT connections. This should not present a problem because most hubs/switches auto-switch between 10BaseT and 100BaseT connections. Confirm that your hub/switch is capable of auto-switching data rates.

To prevent Ethernet traffic from degrading iNET performance, place the iNET in a segment, or behind routers.



**Figure 4-1. Typical Installation with a Tower-Mounted Antenna**  
*(Connect user data equipment to any compatible LAN or COM Port)*

### Unit Dimensions

Figure 4-2 shows the dimensions of the transceiver case and its mounting holes, and Figure 4-3 on Page 131, the dimensions for mounting with factory-supplied brackets. If possible, choose a mounting

location that provides easy access to the connectors on the end of the radio and an unobstructed view of the LED status indicators.

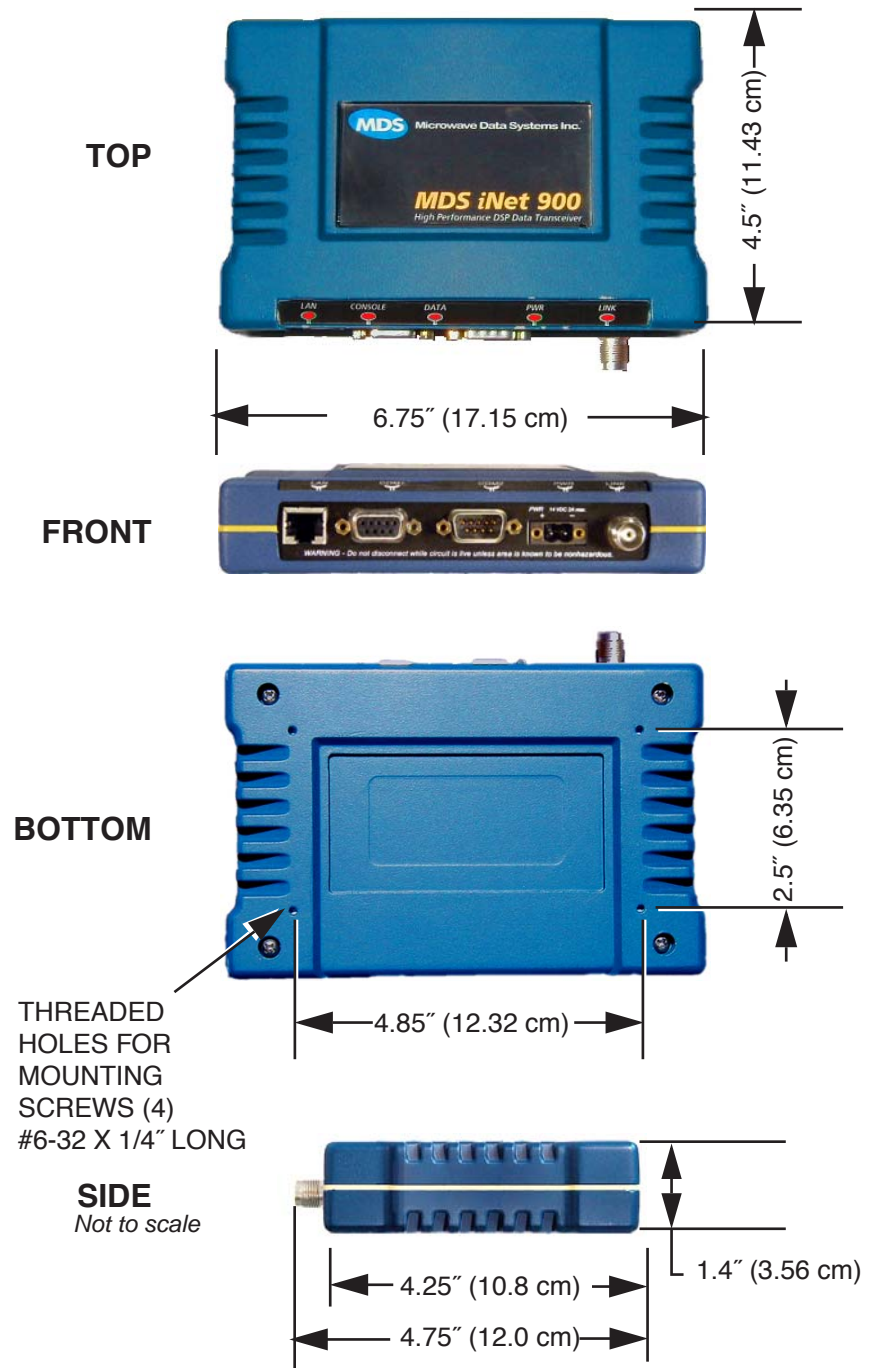
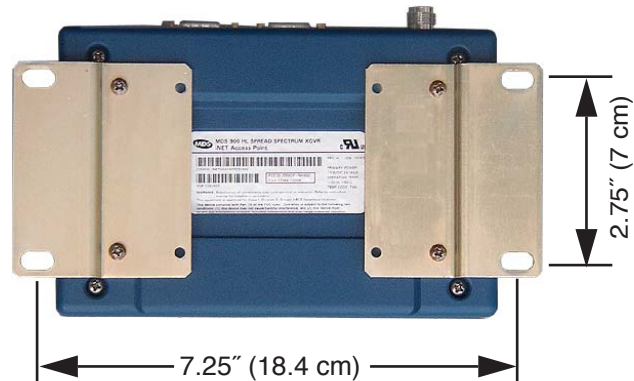


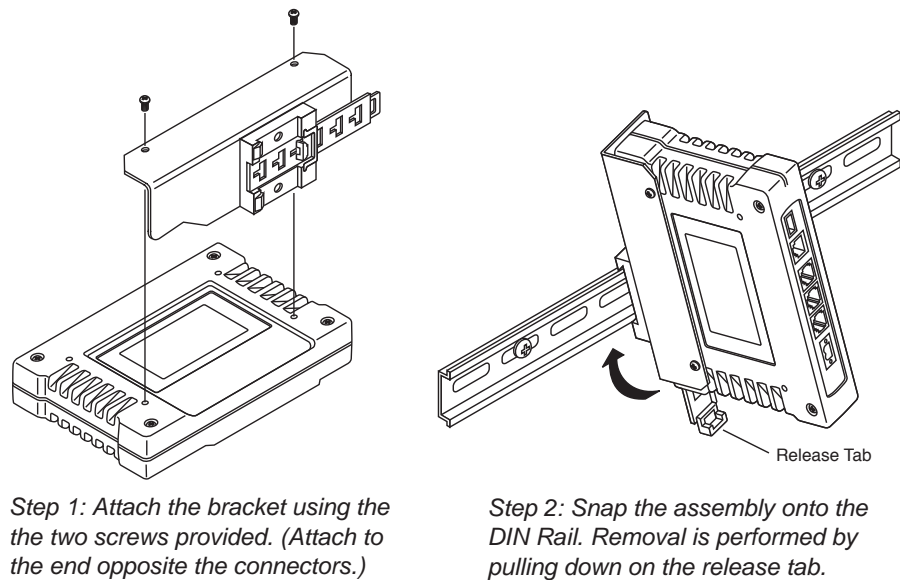
Figure 4-2. Transceiver Dimensions



**Figure 4-3. Mounting Bracket Dimensions**

### DIN Rail Mounting Option

The unit may also be mounted with an optional 35mm DIN Rail Mounting Bracket (Part No. 03-4022A02). Equipment cabinets and racks of recent design often employ this type of mounting. Once the DIN bracket is mounted to the iNET case, it allows for quick installation and removal of the radio without the need for tools of any kind. Figure 4-4 shows how the DIN Rail bracket attaches to the back of the unit's case, and how the entire unit attaches to the mounting rail.



**Figure 4-4. DIN Rail Mounting of GE MDS Equipment**

### 4.1.2 Site Selection

Suitable sites should provide:

- Protection from direct weather exposure
- A source of adequate and stable primary power

- Suitable entrances for antenna, interface or other required cabling
- Antenna location that provides as unobstructed a transmission path as possible in the direction of the associated station(s)

These requirements can be quickly determined in most cases. A possible exception is the last item—verifying that an unobstructed transmission path exists. Radio signals travel primarily by line-of-sight, and obstructions between the sending and receiving stations will affect system performance. If you are not familiar with the effects of terrain and other obstructions on radio transmission, the discussion below will provide helpful background.

### 4.1.3 Terrain and Signal Strength

While the license-free 900 MHz band offers many advantages for data transmission services, signal propagation is affected by attenuation from obstructions such as terrain, foliage or buildings in the transmission path.

A line-of-sight transmission path between the central transceiver and its associated remote site(s) is highly desirable and provides the most reliable communications link.

Much depends on the minimum signal strength that can be tolerated in a given system. Although the exact figure will differ from one system to another, a Received Signal Strength Indication (RSSI) of  $-77$  dBm ( $-80$  dBm for iNET-II) or stronger will provide acceptable performance in many systems. While the equipment will work at lower-strength signals, signals stronger than  $-77$  dBm provide a “fade margin” of 15 dB to account for variations in signal strength that may occur from time-to-time. RSSI can be measured with a terminal connected to the COM1 Port or with a HTTP browser to the LAN (Ethernet) connector. (See “Antenna Aiming” on Page 141 for details.)

### 4.1.4 Antenna & Feedline Selection

---

**NOTE:** The transceiver is a Professional Installation radio system and must be installed by trained professional installers, or factory trained technicians.

This text that follows is designed to aid the professional installer in the proper methods of maintaining compliance with FCC Part 15 limits and the +36 dBm or 4 watts peak E.I.R.P limit.

---

#### Antennas

The equipment can be used with a number of antennas. The exact style used depends on the physical size and layout of a system. Contact your

factory representative for specific recommendations on antenna types and hardware sources.

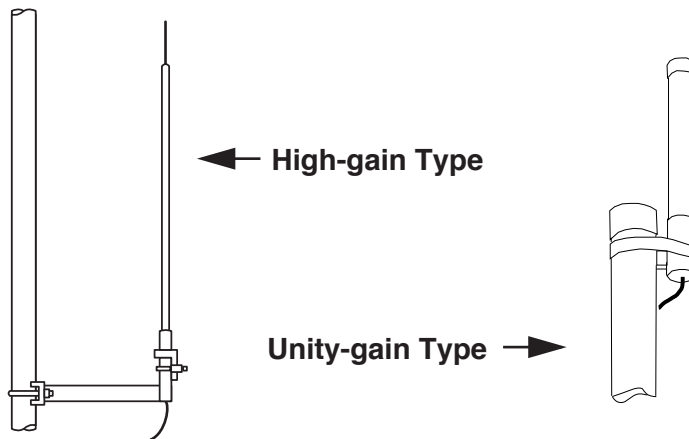
In general, an omnidirectional antenna (Figure 4-5) is used at the Access Point station site. This provides equal coverage to all of the Remote Gateway sites.

---

**NOTE:** Antenna polarization is important. If the wrong polarization is used, a signal reduction of 20 dB or more will result. Most systems using a gain-type omnidirectional antenna at the Access Point station employ vertical polarization of the signal; therefore, the remote antenna(s) must also be vertically polarized (elements oriented perpendicular to the horizon).

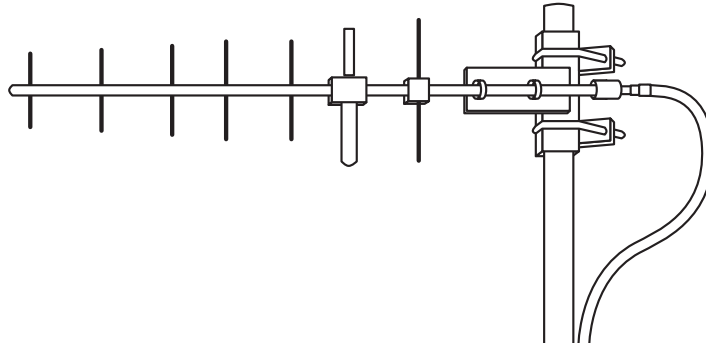
When required, horizontally polarized omnidirectional antennas are also available. Contact your factory representative for details.

---



**Figure 4-5. Typical Omnidirectional Antennas**

At Remote Gateway sites and units in point-to-point LANs, a directional Yagi (Figure 4-6) antenna is generally recommended to minimize interference to and from other users. Antennas are available from a number of manufacturers.



**Figure 4-6. Typical Yagi Antenna (mounted to mast)**

### Feedlines

The choice of feedline used with the antenna should be carefully considered. Poor-quality coaxial cables should be avoided, as they will degrade system performance for both transmission and reception. The cable should be kept as short as possible to minimize signal loss.

For cable runs of less than 20 feet (6 meters), or for short range transmission, an inexpensive type such as Type RG-8A/U may be acceptable. Otherwise, we recommend using a low-loss cable type suited for 900 MHz, such as Heliax®.

Table 4-1 lists several types of popular feedlines and indicates the signal losses (in dB) that result when using various lengths of cable at 900 MHz. The choice of cable will depend on the required length, cost considerations, and the amount of signal loss that can be tolerated.

**Table 4-1. Length vs. Loss in Coaxial Cables at 900 MHz**

Cable Type	10 Feet (3.05 m)	50 Feet (15.24 m)	100 Feet (30.48 m)	500 Feet (152.4 m)
RG-214	.76 dB	3.8 dB	7.6 dB	Unacceptable Loss
LMR-400	0.39 dB	1.95 dB	3.90 dB	Unacceptable Loss
1/2 inch HELIAX	0.23 dB	1.15 dB	2.29 dB	11.45 dB
7/8 inch HELIAX	0.13 dB	0.64 dB	1.28 dB	6.40 dB
1-1/4 inch HELIAX	0.10 dB	0.48 dB	0.95 dB	4.75 dB
1-5/8 inch HELIAX	0.08 dB	0.40 dB	0.80 dB	4.00 dB

The tables below outline the minimum lengths of RG-214 coaxial cable that must be used with common GE MDS omnidirectional antennas in order to maintain compliance with FCC maximum limit of +36 dBi. If other coaxial cable is used, the appropriate changes in loss figures must be made.



**NOTE:** The authority to operate the transceiver in the USA may be void if antennas other than those approved by the FCC are used. Contact your GE MDS representative for additional antenna information.

**Table 4-2. Feedline Length vs. Antenna Gain\***  
(Required for Regulatory compliance)

Antenna Gain (dBd)	Antenna Gain (dBi)	Minimum Feedline Length (Loss in dB)	EIRP Level @ Min. Length	Maxrad Antenna Part No.
Unity (0 dB)	2.15 dBi	No minimum length	+32.15 dBm	Omni #MFB900
3 dBd	5.15 dBi	No minimum length	+35.15 dBm	Omni # MFB900
5 dBd	7.15 dBi	3.1 meters (1.2 dB)	+35.95 dBm	Omni # MFB900
6 dBd	8.15 dBi	9.1 meters (2.2 dB)	+35.95 dBm	Yagi # BMOY8903
10 dBd	12.15 dBi	24.7 meters (6.15 dB)	+35.25 dBm	Yagi # Z941

\*Refer to Table 4-3 for allowable power settings of the transceiver for each antenna type.

**NOTE:** There is no minimum feedline length required when a 6 dBi gain or less antenna is used, as the EIRP will never exceed 36 dBm which is the maximum allowed, per FCC rules. The transceiver's RF output power may only be adjusted by the manufacturer or its sub-contracted Professional Installer.

The GE MDS iNET-II Transceiver is factory set to +29 dBm power output to maintain compliance with the FCC's Digital Transmission System (DTS) Part 15 rules. These rules limit power to a maximum of 8 dBm/3 kHz, thus the iNET-II Transceiver is factory set to +29 dBm. When calculating maximum transceiver power output for iNET-II installations, use +29 dBm if antenna gain is 6 dBi or less. See How Much Output Power Can be Used? on Page 135 for power control of higher gain antennas.

### 4.1.5 How Much Output Power Can be Used?

The transceiver is normally supplied from the factory set for a nominal +30 dBm (+29 dBm for iNET-II) RF power output setting; this is the maximum transmitter output power allowed under FCC rules. The power must be *decreased* from this level if the antenna system gain exceeds 6 dBi. The allowable level is dependent on the antenna gain, feedline loss, and the transmitter output power setting.

**NOTE:** In some countries, the maximum allowable RF output may be limited to less than the figures referenced here. Be sure to check for and comply with the requirements for your area.

### 4.1.6 Conducting a Site Survey

If you are in doubt about the suitability of the radio sites in your system, it is best to evaluate them before a permanent installation is underway. This can be done with an on-the-air test (preferred method); or indirectly, using path-study software.

An on-the-air test is preferred because it allows you to see firsthand the factors involved at an installation site and to directly observe the quality of system operation. Even if a computer path study was conducted earlier, this test should be done to verify the predicted results.

The test can be performed by first installing a radio and antenna at the proposed Access Point (AP) station site (one-per-system). Then visit the Remote site(s) with another transceiver (programmed as a remote) and a hand-held antenna. (A PC with a network adapter can be connected to each radio in the network to simulate data during this test using the PING command.)

With the hand-held antenna positioned near the proposed mounting spot, a technician can check for synchronization with the Access Point station (shown by a lit LINK LED on the front panel) and measure the reported RSSI value. (See “Antenna Aiming” on Page 141 for details.) If adequate signal strength cannot be obtained, it may be necessary to mount the station antennas higher, use higher gain antennas, select a different site or consider installing a repeater station. To prepare the equipment for an on-the-air test, follow the general installation procedures given in this guide and become familiar with the operating instructions found in the *CHAPTER-2 EMBEDDED MANAGEMENT SYSTEM* section Page 19.

### 4.1.7 A Word About Radio Interference

The transceiver shares the radio-frequency spectrum with other 900 MHz services and other Part 15 (unlicensed) devices in the USA. As such, near 100% error-free communications may not be achieved in a given location, and some level of interference should be expected. However, the radio’s flexible design and hopping techniques should allow adequate performance as long as care is taken in choosing station location, configuration of radio parameters and software/protocol techniques.

In general, keep the following points in mind when setting up your communications network.

- Systems installed in rural areas are least likely to encounter interference; those in suburban and urban environments are more likely to be affected by other devices operating in the license-free frequency band and by adjacent licensed services.
- Use a directional antenna at remote sites whenever possible.

Although these antennas may be more costly than omnidirectional types, they confine the transmission and reception pattern to a comparatively narrow lobe, that minimizes interference to (and from) stations located outside the pattern.

- If interference is suspected from a nearby licensed system (such as a paging transmitter), it may be helpful to use horizontal polarization of all antennas in the network. Because most other services use vertical polarization in this band, an additional 20 dB of attenuation to interference can be achieved by using horizontal polarization. Another approach is to use a bandpass filter to attenuate all signals outside the 900 MHz band.
- Multiple Access Point units can co-exist in proximity to each other with only very minor interference. Each network name has a different hop pattern. (See “Protected Network Operation using Multiple Access Points” on Page 14.) Additional isolation can be achieved by using separate directional antennas with as much vertical or horizontal separation as is practical.
- If constant interference is present in a particular frequency zone (collection of 8 RF channels), it may be necessary to “skip” that zone from the radio’s hopping pattern. The radio includes built-in software to help users identify and remove blocked frequency zones from its hopping pattern. See Page 56 for more information on Skip Zones.
- If interference problems persist even after skipping some zones, try reducing the length of data streams. Groups of short data streams have a better chance of getting through in the presence of interference than do long streams.
- The power output of all radios in a system should be set for the lowest level necessary for reliable communications. This lessens the chance of causing unnecessary interference to nearby systems.

If you are not familiar with these interference-control techniques, contact your factory representative for more information.

### **Calculating System Gain**

To determine the maximum allowable power setting of the radio, perform the following steps:

1. Determine the antenna system gain by subtracting the feedline loss (in dB) from the antenna gain (in dBi). For example, if the antenna gain is 9.5 dBi, and the feedline loss is 1.5 dB, the antenna system gain would be 8 dB. (If the antenna system gain is 6 dB or less, no power adjustment is required.)

2. Subtract the antenna system gain from 36 dBm (the maximum allowable EIRP). The result indicates the maximum transmitter power (in dBm) allowed under the rules. In the example above, this is 28 dBm.
3. If the maximum transmitter power allowed is less than 30 dBm, set the power to the desired level using the Management System.  
(Main Menu>>Radio Configuration>>RF Output Power Setpoint)

For convenience, Table 4-3 lists several antenna system gains and shows the maximum allowable power setting of the radio. Note that a gain of 6 dB or less entitles you to operate the radio at full power output –30 dBm (28.7 dBm for iNET-II).

**Table 4-3. Antenna System Gain vs. Power Output Setting**

Antenna System Gain (Antenna Gain in dBi* minus Feedline Loss in dB†)	Maximum Power Setting (PWR command) iNET Radio	Maximum Power Setting (PWR command) iNET-II Radio	EIRP (in dBm)
Omni 6 (or less)	30	28	36
Omni 9	27	26	36
Yagi 12	24	23	36
Yagi 14	22	Not allowable	36
Yagi 16	20	Not allowable	36

\* Most antenna manufacturers rate antenna gain in dBd in their literature. To convert to dBi, add 2.15 dB.

† Feedline loss varies by cable type and length. To determine the loss for common lengths of feedline, see Table 4-1 on Page 134.

For assistance in the conversion of dBm to Watts, see dBm-WATTS-VOLTS CONVERSION CHART on Page 143.

### 4.1.8 Notes on Using 28 Vdc Power Supplies

Common 28 Vdc supplies are often high-current power supplies designed primarily to charge battery banks. The radio can be operated from these supplies, providing there are no transients on the leads as power is applied to the radio. Transients can be created that rise above 30 Vdc to a voltage that exceeds the primary voltage rating of the radio and can destroy its voltage regulators and other components. It is important to keep this potential hazard in mind when designing 28 Vdc power supply connections for the radio.

- Use a two-conductor cable to power to the radio. Then the currents in the positive and negative wires are equal and opposite, causing their magnetic fields to cancel. The result is no net inductance in the connection to cause voltage overshoot.

- Do not connect a radio to a power supply that is already powered up, unless necessary (that is, when connecting a radio to a battery bank and charger). When power is applied by switching on a power supply, the rise time of the supply is too slow to cause overshoot.
- Typically, there are multiple return paths for the negative side of the power supply, through the coaxial cable shield and the chassis, for example. Any imbalance in the currents in the power cable results in voltage overshoot, so this should be minimized during initial power-up if the supply cannot be turned off.
- Add a 1 to 2  $\Omega$ , 2 Watt resistor in series with the positive lead. This greatly limits voltage overshoot. Since these radios draw very little current in receive mode, and transmit only briefly, there is little loss in power efficiency. In transmit, the voltage drop is minimal and has no effect.
- Minimize the length of the power cabling, within reason.
- When power is applied from a power source having a relatively high (1 or 2  $\Omega$ ) source impedance, or from a power source without a large amount of output capacitance, no overshoot occurs. Therefore, use a power supply that is rated appropriately for the radio if possible—avoid using power supplies that far exceed the radio's current requirements.

Please direct any questions you may have about interfacing to GE MDS radios to the Technical Services Department via e-mail or telephone:

E-mail: [TechSupport@GEmds.com](mailto:TechSupport@GEmds.com)  
Tel. +1-585-241-5510.

## 4.2 RADIO (RF) MEASUREMENTS

There are several measurements that are a good practice to perform during the initial installation. They will confirm proper operation of the unit and if they are recorded, serve as a benchmark in troubleshooting should difficulties appear in the future. These measurements are:

- Transmitter Power Output
- Antenna System SWR (Standing-Wave Ratio)
- Antenna Direction Optimization

These procedures may interrupt traffic through an established network and should only be performed by a skilled radio-technician in cooperation with the network manager.

## 4.2.1 Antenna System SWR and Transmitter Power Output

### Introduction

A proper impedance match between the transceiver and the antenna system is important. It ensures the maximum signal transfer between the radio and antenna. The impedance match can be checked indirectly by measuring the SWR (standing-wave ratio) of the antenna system. If the results are normal, record them for comparison for use during future routine preventative maintenance. Abnormal readings indicate a possible trouble with the antenna or the transmission line that will need to be corrected.

The SWR of the antenna system should be checked before the radio is put into regular service. For accurate readings, a wattmeter suited to 1000 MHz measurements is required. One unit meeting this criteria is the Bird Model 43™ directional wattmeter with a 5J element installed.

The reflected power should be less than 10% of the forward power ( $\approx 2:1$  SWR). Higher readings usually indicate problems with the antenna, feedline or coaxial connectors.

If the reflected power is more than 10%, check the feedline, antenna and its connectors for damage.

Record the current transmitter power output level, and then set it to 30 dBm for the duration of the test to provide an adequate signal level for the directional wattmeter.

### Procedure

1. Place a directional wattmeter between the ANTENNA connector and the antenna system.
2. Place the transceiver into the Radio Test Mode using the menu sequence below:  
(Main Menu>>Maintenance Menu>>Radio Test>>Test Mode>>Y>>ON)

---

**NOTE:** The Test Mode has a 10-minute timer, after which it will return the radio to normal operation. The Radio Test Mode can be terminated manually by selecting **OFF** on the menu or temporarily disconnecting the radio's DC power.

---

3. Set the transmit power to 30 dBm. (This setting does not affect the output level during normal operation—only during Test Mode.)  
(Main Menu>>Maintenance Menu>>Radio Test>>Test Mode>>Tx Power Output)
4. Key the transmitter.  
(Main Menu>>Maintenance Menu>>Radio Test>>Test Mode>>TxKey>>Enable)

Use the PC's spacebar to key and unkey the transmitter ON and OFF. (Enable/Disable)

5. Measure the forward and reflected power into the antenna system and calculate the SWR and power output level. The output should agree with the programmed value.

**(Main Menu>>Radio Configuration>>RF Power Output)**

6. Turn off Radio Test Mode at the Access Point and Remote.

**(Main Menu>>Maintenance Menu>>Radio Test>>Test Mode>>Disable)**

*End of procedure*

## 4.2.2 Antenna Aiming

### Introduction

The radio network integrity depends, in a large part, on stable radio signal levels being received at each end of a data link. In general, signal levels stronger than  $-77$  dBm ( $-80$  dBm for iNET-II) provides the basis for reliable communication that includes a 15 dB fade margin. As the distance between the Access Point and Remotes increases, the influence of terrain, foliage and man-made obstructions become more influential and the use of directional antennas at Remote locations becomes necessary. Directional antennas usually require some fine-tuning of their bearing to optimize the received signal strength. The transceiver has a built-in received signal strength indicator (RSSI) that can be used to tell you when the antenna is in a position that provides the optimum received signal.

RSSI measurements and Wireless Packet Statistics are based on multiple samples over a period of several seconds. The average of these measurements will be displayed by the Management System.

The measurement and antenna alignment process will usually take 10 or more minutes at each radio unit.

The path to the Management System menu item is shown in bold text below each step of the procedure.

### Procedure

1. Verify the Remote transceiver is associated with an Access Point unit by observing the condition of the LINK LED (**LINK LED = On or Blinking**). This indicates that you have an adequate signal level for the measurements and it is safe to proceed.
2. View and record the *Wireless Packets Dropped* and *Received Error* rates.  
**(Main Menu>>Performance Information>>Packet Statistics>>Wireless Packet**

**Statistics)**

This information will be used later.

3. Clear the *Wireless Packets Statistics* history.

**(Main Menu>>Performance Information>>Packet Statistics>>Wireless Packet Statistics>>Clear Wireless Stats)\**

4. Read the RSSI level at the Remote.  
**(Main Menu>>Performance Information>>RSSI by Zone)**

5. Optimize RSSI (less negative is better) by slowly adjusting the direction of the antenna.

Watch the RSSI indication for several seconds after making each adjustment so that the RSSI accurately reflects any change in the link signal strength.

6. View the *Wireless Packets Dropped* and *Received Error* rates at the point of maximum RSSI level. They should be the same or lower than the previous reading.

**(Main Menu>>Performance Information>>Packet Statistics>>Wireless Packet Statistics)**

If the RSSI peak results in an increase in the *Wireless Packets Dropped* and *Received Error*, the antenna may be aimed at an undesired signal source. Try a different antenna orientation.

*End of procedure*



## 4.3 dBm-WATTS-VOLTS CONVERSION CHART

Table 4-4 is provided as a convenience for determining the equivalent voltage or wattage of an RF power expressed in dBm.

**Table 4-4. dBm-Watts-Volts conversion—for 50 ohm systems**

dBm	V	Po	dBm	V	Po	dBm	mV	Po	dBm	$\mu$ V	Po
+53	100.0	200W	0	.225	1.0mW	-49	0.80		-98	2.9	
+50	70.7	100W	-1	.200	.80mW	-50	0.71	.01 $\mu$ W	-99	2.51	
+49	64.0	80W	-2	.180	.64mW	-51	0.64		-100	2.25	.1pW
+48	58.0	64W	-3	.160	.50mW	-52	0.57		-101	2.0	
+47	50.0	50W	-4	.141	.40mW	-53	0.50		-102	1.8	
+46	44.5	40W	-5	.125	.32mW	-54	0.45		-103	1.6	
+45	40.0	32W	-6	.115	.25mW	-55	0.40		-104	1.41	
+44	32.5	25W	-7	.100	.20mW	-56	0.351		-105	1.27	
+43	32.0	20W	-8	.090	.16mW	-57	0.32		-106	1.18	
+42	28.0	16W	-9	.080	.125mW	-58	0.286				
+41	26.2	12.5W	-10	.071	.10mW	-59	0.251		<b>dBm</b>	<b>nV</b>	<b>Po</b>
+40	22.5	10W	-11	.064		-60	0.225	.001 $\mu$ W	-107	1000	
+39	20.0	8W	-12	.058		-61	0.200		-108	900	
+38	18.0	6.4W	-13	.050		-62	0.180		-109	800	
+37	16.0	5W	-14	.045		-63	0.160		-110	710	.01pW
+36	14.1	4W	-15	.040		-64	0.141		-111	640	
+35	12.5	3.2W	-16	.0355					-112	580	
+34	11.5	2.5W				<b>dBm</b>	<b><math>\mu</math>V</b>	<b>Po</b>	-113	500	
+33	10.0	2W	<b>dBm</b>	<b>mV</b>	<b>Po</b>	-65	128		-114	450	
+32	9.0	1.6W	-17	31.5		-66	115		-115	400	
+31	8.0	1.25W	-18	28.5		-67	100		-116	355	
+30	7.10	1.0W	-19	25.1		-68	90		-117	325	
+29	6.40	800mW	-20	22.5	.01mW	-69	80		-118	285	
+28	5.80	640mW	-21	20.0		-70	71	.1nW	-119	251	
+27	5.00	500mW	-22	17.9		-71	65		-120	225	.001pW
+26	4.45	400mW	-23	15.9		-72	58		-121	200	
+25	4.00	320mW	-24	14.1		-73	50		-122	180	
+24	3.55	250mW	-25	12.8		-74	45		-123	160	
+23	3.20	200mW	-26	11.5		-75	40		-124	141	
+22	2.80	160mW	-27	10.0		-76	35		-125	128	
+21	2.52	125mW	-28	8.9		-77	32		-126	117	
+20	2.25	100mW	-29	8.0		-78	29		-127	100	
+19	2.00	80mW	-30	7.1	.001mW	-79	25		-128	90	
+18	1.80	64mW	-31	6.25		-80	22.5	.01nW	-129	80	.1fW
+17	1.60	50mW	-32	5.8		-81	20.0		-130	71	
+16	1.41	40mW	-33	5.0		-82	18.0		-131	61	
+15	1.25	32mW	-34	4.5		-83	16.0		-132	58	
+14	1.15	25mW	-35	4.0		-84	11.1		-133	50	
+13	1.00	20mW	-36	3.5		-85	12.9		-134	45	
+12	.90	16mW	-37	3.2		-86	11.5		-135	40	
+11	.80	12.5mW	-38	2.85		-87	10.0		-136	35	
+10	.71	10mW	-39	2.5		-88	9.0		-137	33	
+9	.64	8mW	-40	2.25	.1 $\mu$ W	-89	8.0		-138	29	
+8	.58	6.4mW	-41	2.0		-90	7.1	.001nW	-139	25	
+7	.500	5mW	-42	1.8		-91	6.1		-140	23	.01fW
+6	.445	4mW	-43	1.6		-92	5.75				
+5	.400	3.2mW	-44	1.4		-93	5.0				
+4	.355	2.5mW	-45	1.25		-94	4.5				
+3	.320	2.0mW	-46	1.18		-95	4.0				
+2	.280	1.6mW	-47	1.00		-96	3.51				
+1	.252	1.25mW	-48	0.90		-97	3.2				

## 4.4 PERFORMANCE NOTES

The following is a list of points that are useful for understanding the performance of the radio in your installation.

### 4.4.1 Wireless Bridge

The transceiver acts as a bridge. If any radio in your network is connected to a large LAN, such as may be found in a large office complex, there may be undesired multicast/broadcast traffic over the air. As a bridge, the radios transmit this type of frame.

The radio goes through a listening and learning period at start-up before it will send any packets over either of its ports. This is about 10 seconds after the CPU's operating system has finished its boot cycle.

The bridge code in the transceiver operates and makes decisions about packet forwarding just like any other bridge. The bridge code builds a list of source MAC addresses that it has seen on each of its ports. There are a few general rules that are followed when a packet is received on any port:

- If the destination address is a multicast or broadcast address, forward the packet to all remotes.
- If the destination address is not known, forward the packet to all remotes.
- If the destination address is known, forward the packet to the port that the destination is known to be on (usually the RF port).
- The bridge code uses Spanning Tree Protocol (STP) to prevent loops from being created when connecting bridges in parallel. For example, connecting two remotes to the same wired LAN could create a loop if STP was not used. Every bridge running STP sends out Bridge Protocol Data Units (BPDUs) at regular intervals so that the spanning tree can be built and maintained. BPDUs are 60-byte multicast Ethernet frames.

### 4.4.2 Distance-Throughput Relationship

Distance affects throughput. Because of timers and other components of the protocol, there is a practical distance limit of 30 miles (48 km) for reliable operation. After this, although data still flows, the throughput will begin to drop and latency will increase, due to additional retries between the radios. Packets may start to be dropped. Some applications may tolerate this; others may not. Repeater stations may be used to extend the range.

### 4.4.3 Data Latency—TCP versus UDP Mode

The latency of data passing through a network will depend on user data message length, the overall level of traffic on the network, and the quality of the radio path.

Under ideal conditions—low traffic and good RF signal path—the latency for units operating in the TCP mode, will typically be around 5 ms in each direction. However, when UDP multicast traffic is transported, the outbound packet latency (from AP to remote) is dependent on the beacon period.

UDP multicast packet latency can be minimized by setting the **Beacon Period** to **Fast** (52 ms). Changing beacon rate to **Fast** will result in an average latency of 31 ms, assuming outbound packets wait for a beacon transmission 50% of the time (26ms) plus the normal packet latency (5 ms).

### 4.4.4 Data Compression

Enabling this option uses an LZO compression algorithm for over-the-air data. Varying levels of data reduction are achieved depending on the nature of the data. Text files are typically the most compressible, whereas binary files are the least compressible. On average, a 30% increase in throughput can be achieved with compression enabled.

Compression is used on data packets of 100 bytes or more, including Ethernet, IP, and TCP/UDP headers.

### 4.4.5 Packets-per-Second (PPS)

The iNET-II radio has a limit of approximately 140 PPS (70 PPS in iNET). Consider this restriction when planning your network, especially when smaller packets are expected to make up the majority of the traffic as is the case with VoIP (Voice over IP).

### 4.4.6 Station-to-Station Traffic

When sending frames from an endpoint connected to one transceiver to *another* endpoint with a different transceiver, the throughput will be halved at best. This is because all frames must go through the AP and thus are transmitted twice over the same radio system. Therefore, in the previous 100-byte UDP example, the number of over-the-air bytes will be 380 bytes (190 bytes x 2) if the frame has to go station-to-station.

### 4.4.7 Interference has a Direct Correlation to Throughput

Interference could be caused by other radios at the same site, in nearby locations, or by high power transmitters such as paging systems.

## 4.4.8 Maximizing Throughput

Here are some suggestion on things to try that may maximize throughput:

1. *AP Only*: Increment the **Dwell Time** to the maximum of 262.1 ms. This lowers the overhead since it will stay longer on a channel. The down side is that if a particular channel is interfered with it will take longer to hop to another channel.  
(Main Menu>>Radio Configuration>>Dwell Time)
2. *AP Only*: Change the **Beacon Period** to **Normal** (508 ms). This will also reduce the overhead of beacons sent out. On the down side, association time may be a little longer.  
(Main Menu>>Radio Configuration>>Beacon Period)
3. Change the **Fragmentation Threshold** to the maximum of 1600. Longer packets will be sent over the air reducing overhead. On the other hand, if a packet is corrupted it will take longer to be retransmitted.  
(Main Menu>>Radio Configuration>>Fragmentation Threshold)
4. Increase the **RTS Threshold** to 1600. RTS mechanism is used to reserve a time slot if packets exceed this number. On the other hand, a hidden-node might interfere more often than if RTS was not used.  
(Main Menu>>Radio Configuration>>RTS Threshold)

Decreasing the **RTS Threshold**, to the 100 to 200 range, may improve throughput on a busy network. It will add small packets, but reduce collisions (and resulting re-tries) of large packets.

(Main Menu>>Radio Configuration>>RTS Threshold)

5. Activate compression on the Radio Configuration Menu (**Compression enabled**).
6. Use the **Performance Information Menu** to check the packets received by zone. (Remotes Only: **Main Menu>>Performance Information>>Packet Statistics>>Packets Received by Zone**)

Readings should be close in value. A significantly lower value (2% reduction) probably indicates interference. Performance can be improved by blocking the affected zones at the Access Point. (**Main Menu>>Radio Configuration>>Skip Zone Option**)

7. Use the **Performance Information Menu** to check for errors, retries and dropped packets. Do the same with Ethernet traffic.

With weak signals, interference, or hidden nodes, the optimal performance may be lower due to collisions and retries.

## 4.4.9 Placing an iNET Radio Behind a Firewall

iNET-II and iNET radios use the port numbers listed below. If you place the radio behind a firewall, make sure these port numbers are included in the allowed list:

- SSH: 22 <- Management
- TELNET: 23 <- Management
- SMTP: 25 <- DF1
- TFTP: 69 <- Reprogramming
- HTTP: 80 <- Management
- NTP: 123 <- Time server
- SNMP: 161 <- Management
- SNMP-TRAP: 162 <- Event management via traps
- HTTPS: 443 <- Management
- SYSLOG: 514 <- Event management via remote syslog server

These well-known port numbers follow the recommendation of IANA. For more information, go to <http://www.iana.org/assignments/port-numbers>.

## 4.5 SNMPv3 NOTES

### 4.5.1 Overview

The transceiver's SNMP Agent supports SNMP version 3 (SNMPv3). The SNMPv3 protocol introduces Authentication (MD5/SHA-1), Encryption (DES), the USM User Table, and View-Based Access (Refer to RFC2574 for full details). The SNMP Agent has limited SNMPv3 support in the following areas:

- Only MD5 Authentication is supported (no SHA-1). SNMPv3 provides support for MD5 and SHA-1. Currently, only MD5 Authentication is supported in the SNMP Agent.
- Limited USM User Table Manipulation. The SNMP Agent starts with 5 default accounts. New accounts can be added (SNMPv3 adds new accounts by cloning existing ones), but they will be volatile (will not survive a power-cycle).

New views cannot be configured on the SNMP Agent. Views will be inherited for new accounts from the account that was cloned.

The SNMP Agent uses one password pair (Authentication / Privacy) for all accounts. This means that when the passwords change for one user, they change for all users.

## SNMPv3 Accounts

The following default accounts are available for the SNMP Agent:

**enc\_mdadmin**—Read/write account using Authentication and Encryption

**auth\_mdadmin**—Read/write account using Authentication

**enc\_mdsvviewer**—Read only account using Authentication and Encryption

**auth\_mdsvviewer**—Read only account using Authentication

**def\_mdsvviewer**—Read only account with no Authentication or Encryption

## Context Names

The following Context Names are used (please refer to RFC2574 for full details):

Admin accounts: **context\_a** / Viewer accounts: **context\_v**

All accounts share the same default passwords:

Authentication default password: **MDSAuthPwd** / Privacy default password: **MDSPrivPwd**

Passwords can be changed either locally (via the console) or from an SNMP Manager, depending on how the Agent is configured. If passwords are configured and managed locally, they are non-volatile and will survive a power-cycle. If passwords are configured from an SNMP manager, they will be reset to whatever has been stored for local management on power-cycle.

This behavior was chosen based on RFC specifications. The SNMP Manager and Agent don't exchange passwords, but actually exchange *keys* based on passwords. If the Manager changes the Agent's password the Agent doesn't know the new password; just the new key. In this case, only the Manager knows the new password. This could cause problems if the Manager loses the password. If that happens, the Agent becomes unmanageable. Resetting the Agent's passwords (and therefore keys) to what is stored in flash memory upon power-cycle prevents the serious problem of losing the Agent's passwords.

If passwords are managed locally, they can be changed on the Agent (via the console). Any attempts to change the passwords for the Agent via an SNMP Manager will fail when the Agent is in this mode. Locally defined passwords will survive a power-cycle.

In either case, the SNMP Manager needs to know the initial passwords that are being used in order to talk to the Agent. If the Agent's passwords are configured via the Manager, then they can be changed from the Manager. If the passwords are managed locally, then the Manager must be re-configured with any password changes in order to continue to talk to the Agent.

## Password-Mode Management Changes

When the password management mode is changed, the active passwords used by the Agent may also change. Some common scenarios are discussed below:

### Common Scenarios

- Passwords are currently being handled by the Manager. The assigned passwords are **Microwave** (Auth), and **Rochester** (Priv). Configuration is changed to manage the passwords locally. The passwords stored on the radio were Fairport (Auth), and Churchville (Priv) (If local passwords have *never* been used, then MDSAAuthPwd and MDSPrivPwd will be used). These passwords will now be used by the Agent to re-generate keys. The Manager will need to know these passwords in order to talk to the Agent.
- Passwords are currently being managed locally. The local passwords are **Fairport** (Auth) and **Churchville** (Priv). Configuration is changed to handle the passwords from the Manager. The same passwords will continue to be used, but now the Manager can change them.
- Passwords are currently being managed locally. The local passwords are **Fairport** (Auth) and **Churchville** (Priv). Passwords are changed to **Brighton** (Auth) and **Perinton** (Priv). The Agent will immediately generate new keys based on these passwords and start using them. The Manager will have to be re-configured to use these new passwords.
- Passwords are currently being managed locally. The local passwords are **Fairport** (Auth) and **Churchville** (Priv). Configuration is changed to handle the passwords from the Manager. The Manager changes the passwords to **Brighton** (Auth) and **Perinton** (Priv). The radio is then rebooted. After a power-cycle, the radio will use the passwords stored in flash, which are **Fairport** (Auth) and **Churchville** (Priv). The Manager will have to be re-configured to use these new passwords.

**Table 4-5. SNMP Traps (Sorted by Code)**

<b>SNMP Trap</b>	<b>Severity</b>	<b>Description</b>
systemBoot(32)	INFORMATIONAL	SNR Within threshold/Below threshold
systemReboot(33)	MAJOR	Telnet User Logged Out/Logged In
startScan(34)	INFORMATIONAL	Reprogramming Started
rxBeaconErrored(35)	INFORMATIONAL	Received Beacon - Netname Does Not Match
rxBeaconWrongNetworkName (36)	INFORMATIONAL	Received Beacon - AP is Blacklisted
rxBeaconFromBlacklistAP(37)	MAJOR	Max Beacon Wait Time Exceeded
expectedSync(38)	INFORMATIONAL	Expected Sync Lost/Established
hopSync(39)	INFORMATIONAL	Hop Sync Lost/Established
snr(41)	INFORMATIONAL	Scanning Started
ber(42)	INFORMATIONAL	Bit Error Rate Below threshold/Above threshold
associated(43)	MAJOR	Association Lost/Established
apParmChange(44)	MINOR	Association Lost - AP Hop Parameter Changed
reprogStarted(45)	MAJOR	Reprogramming Failed
reprogComplete(46)	MAJOR	Rem Ethernet Link Connected/Disconnected
reprogFailed(47)	INFORMATIONAL	Reprogramming Complete
telnetLogin(48)	MAJOR	Telnet Access Locked for 5 Min
httpLogin(49)	MAJOR	HTTP User Logged Out/Logged In
countrySkipZoneMismatch(50)	INFORMATIONAL	Country/SkipZone Mismatch
desiredAPIPMismatch(51)	INFORMATIONAL	Desired AP IP Addr Mismatch
eventLogCleared(52)	INFORMATIONAL	Log Cleared
authDemoMode(53)	MAJOR	Auth Demo Mode Expired -- Rebooted Radio/Enabled
keyEntered(54)	MAJOR	Auth Key Entered - Key Valid/Key Invalid
apEthLinkDown(55)	MAJOR	Association Lost - AP's Ethernet Link Down
noBeacons(56)	MAJOR	MAC Param Changed
apNotApproved(57)	MAJOR	Current AP No Longer Approved
netnameChanged(58)	MAJOR	Association Lost - Local Network Name Changed
ipAddrChanged(59)	MAJOR	Association Lost - Local IP Address Changed
assocTryFail(60)	MAJOR	Association Attempt Success/Failed
remEthLinkLost(61)	INFORMATIONAL	Received Beacon - Valid/Errored
consoleLogin(62)	MAJOR	Console User Logged Out/Logged In
consoleLockdown(63)	MAJOR	Console Access Locked for 5 Min
telnetLockdown(64)	INFORMATIONAL	System Bootup (power on)
httpLockdown(65)	MAJOR	HTTP Access Locked for 5 Min
eventRemote(66)	INFORMATIONAL	Remote added/removed from internal database
eventEndpoint(67)	INFORMATIONAL	Endpoint added/removed from internal database
routeAdded(68)	INFORMATIONAL	Radio attempted but failed to add a route to its internal routing table



**Table 4-5. SNMP Traps (Sorted by Code) (Continued)**

<b>SNMP Trap</b>	<b>Severity</b>	<b>Description</b>
routeDeleted(69)	INFORMATIONAL	Radio attempted but failed to delete a route from its internal routing table
sinRemSwitch(70)	INFORMATIONAL	Remote mode was switched (serial to ethernet, ethernet to serial)
ChanCnt(71)	INFORMATIONAL	Number of channels defined does not match (Channel 130 only)
tftpConnection(73)	INFORMATIONAL	TFTP Server on AP started or finished a transfer
apNetNameChanged(74)	MAJOR	Remote lost association due to a change in the AP's netname
ipConnectivityOK(75)	INFORMATIONAL	Radio is associated AND 1) has an IP address statically defined, OR 2) received an IP address via DHCP
compressionChanged(76)	INFORMATIONAL	Compression state has changed (enabled, disabled)
macDecryptError(77)	INFORMATIONAL	MAC has received a packet that it could not decrypt
lanPortStatus(78)	INFORMATIONAL	Ethernet port has changed (enabled, disabled)
tftpConnFailed(79)	INFORMATIONAL	TFTP server on AP failed to transfer
sdbError(80)	INFORMATIONAL	AP encountered an internal database error

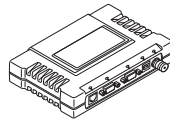




# 5 TECHNICAL REFERENCE

## Contents

5.1 DATA INTERFACE CONNECTORS .....	155
5.1.1 LAN Port .....	155
5.1.2 COM1 Port .....	156
5.1.3 COM2 Port .....	156
5.2 FUSE REPLACEMENT PROCEDURE .....	157
5.3 TECHNICAL SPECIFICATIONS .....	158
5.4 CHANNEL HOP TABLE .....	161



## 5.1 DATA INTERFACE CONNECTORS

Three data interface connectors are provided on the face of the transceiver. The first, the LAN Port, is an RJ-45 connector. The other two use two DB-9 interface connectors that use the RS-232 (EIA-232) signaling standard. Note that the connector for COM1 Port is DCE (Female DB-9) and the COM2 Port is DTE (male DB-9).



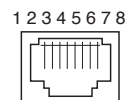
The transceiver meets U.S.A.'s FCC Part 15, Class A limits when used with shielded data cables.

### 5.1.1 LAN Port

The transceiver's LAN Port is used to connect the radio to an Ethernet network. The transceiver provides a data link to an Internet Protocol-based (IP) network via the Access Point station. Each radio in the network must have a unique IP address for the network to function properly.

- To connect a PC directly to the radio's LAN port, an RJ-45 to RJ-45 cross-over cable is required.
- To connect the radio to a Ethernet hub or bridge, use a straight-through cable.

The connector uses the standard Ethernet RJ-45 cables and wiring. For custom-made cables, use the pinout information in Figure 5-1 and Table 5-1.



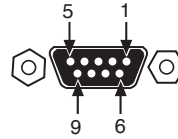
**Figure 5-1. LAN Port (RJ-45) Pinout**  
(Viewed from the outside of the unit)

**Table 5-1. LAN Port (IP/Ethernet)**

Pin	Functions	Ref.
1	Transmit Data (TX)	High
2	Transmit Data (TX)	Low
3	Receive Data (RX)	High
4	Unused	
5	Unused	
6	Receive Data (RX)	Low
7	Unused	
8	Unused	

### 5.1.2 COM1 Port

To connect a PC to the transceiver’s COM1 port use a DB-9M to DB-9F “straight-through” cable. These cables are available commercially, or may be constructed using the pinout information in Figure 5-2 and Table 5-2.



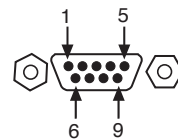
**Figure 5-2. COM1 Port (DCE)**  
*(Viewed from the outside of the unit.)*

**Table 5-2. COM1 Port Pinout, DB-9F/RS-232 Interface**

Pin	Functions	DCE
1	Unused	
2	Receive Data (RXD)	<-[Out
3	Transmit Data (TXD)	->[In
4	Unused	
5	Signal Ground (GND)	
6-9	Unused	

### 5.1.3 COM2 Port

To connect a PC to the transceiver’s COM2 port use a DB-9F to DB-9M “straight-through” cable. These cables are available commercially, or may be constructed using the pinout information in Figure 5-3 and Table 5-3.



**Figure 5-3. COM2 Port (DTE)**  
*Viewed from the outside of the radio*

**Table 5-3. COM2 Port, DB-9M/EIA-232 Interface**

Pin	Functions	DTE
1	Data Carrier Detect (DCD)	In]←-
2	Receive Data (RXD)	In]←-
3	Transmit Data (TXD)	Out]→
4	Data Terminal Ready (DTR)	Out]→
5	Signal Ground (GND)	

**Table 5-3. COM2 Port, DB-9M/EIA-232 Interface**

Pin	Functions	DTE
6	Data Set Ready (DSR)	In]←—
7	Request-to-Send (RTS)	Out]—>
8	Clear-to-Send (CTS)	In]←—
9	Unused	

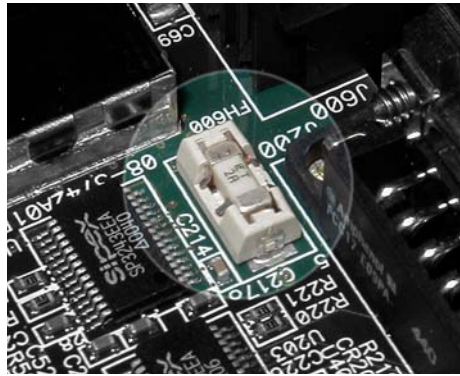
## 5.2 FUSE REPLACEMENT PROCEDURE

An internal fuse protects the transceiver from over-current conditions or an internal component failure. It should not be replaced until you are certain you are in a safe (non-flammable) environment.

1. Disconnect the primary power source and all other connections to the unit.
2. Place the radio on its back and remove the four Phillips screws on the bottom cover.
3. Carefully separate the top and bottom covers. There is a flat ribbon cable between the top cover's LEDs and the unit motherboard. You do not need to disconnect the ribbon cable.
4. Locate the fuse and fuse holder between the COM1 port and the power connector. See Figure 5-4 for details.
5. Loosen the fuse from the holder using a very small screwdriver. Use a small pair of needle-nose pliers to pull the fuse straight up and remove it.
6. Using an Ohmmeter, or other continuity tester, verify the fuse is blown.
7. Install a new fuse by reversing the process.

Littelfuse P/N: 0454002; 452 Series, 2 Amp SMF Slo-Blo  
GE MDS P/N: 29-1784A03

8. Install the covers and check the transceiver for proper operation.



**Figure 5-4.  
Internal Fuse and Holder  
Assembly Location**

## 5.3 TECHNICAL SPECIFICATIONS

### GENERAL

---

Temperature Range:	-30° C to +60° C (-22° F to 140° F)
Humidity:	95% at +40° C (104° F); non-condensing
Primary Power:	10–30 Vdc (13.8 Vdc Nominal)
External Power Supply Options:	110–120/210–220 Vac
Supply Current (typical):	(9 Watts Maximum @ 1 Watt RF Output)
Transmit:	7 watts (10.5-24 Vdc) 9 watts (24.5-30 Vdc)
Receive:	2.8 watts (10.5-24 Vdc) 3.5 watts (24.5-30 Vdc)
MTBF:	35 Years (Telcordia Method 1, Case 3)
Size (Excluding mtg. hardware):	1.25" x 6.75" x 4.5" (H x W x D) 3.15 x 17.15 x 11.43 cm
Mounting w/Optional Hardware:	<ul style="list-style-type: none"> <li>• DIN Rail</li> <li>• Flat surface mounting brackets</li> <li>• 19" rack (1U high)</li> </ul>
Weight:	908 g / 2 lb
Case:	Cast Aluminum
Boot Time:	≈ 30 sec
Time Required to Associate with Access Point:	≈ 20 sec

### APPROVALS/HOMOLOGATION

- 
- FCC Part 15.247  
iNET FCC identifier: E5MDS-NH900  
iNET-II FCC identifier: E5MDS-INETII
  - Industry Canada RSS-210  
iNET certification no.: 3738A 12098  
iNET-II certification no.: 3738A-INETII



- UL/CSA Class 1, Div. 2; Groups A, B, C and D hazardous locations
- Complies with the following IEEE Std 1613™-2003 Communications Networking Devices in Electric Power Substations classifications:
  - 4.1.1 Environmental Class B
  - 4.1.2 Environmental Storage Class A
  - 7.12 Device Performance Class 1
- Contact factory for information on availability and governmental approvals in other countries

## MANAGEMENT

---

- HTTP, HTTPS (Embedded Web server)
- Telnet, SSH, COM1 serial port (Text-based menu)
- SNMP v1/v2/v3
- SYSLOG
- GE MDS NETview MS™

## DATA CHARACTERISTICS

---

### PORTS:

#### Ethernet:

Interface Connectors:	RJ-45 Standard
Data Rate:	10BaseT (10 Mbps)

#### Serial (2 Ports):

Signaling Standard:	EIA-232/V.24
Interface Connectors:	DB-9
Interface:	COM1: DCE / COM2: DTE
Data Rate:	1200–115,200 bps asynchronous
Data Latency:	< 10 ms typical
Byte Formats:	7 or 8-bit; even, odd, or no-parity; 1 or 2 stop bits

### OPERATING MODES:

### PROTOCOLS:

- Configurable as Access Point or Remote Station
- Wireless: CSMA/CA (Collision Avoidance)
- Ethernet: IEEE 802.3, Ethernet II, Spanning Tree (Bridging), IGMP
- TCP/IP: DHCP, ICMP, UDP, TCP, ARP, Multicast, SNMP, TFTP
- Serial: PPP, Encapsulation over IP (tunneling) for serial async multidrop protocols including Modbus, DNP.3, DF1, BSAP
- Special: Allen-Bradley EtherNet/IP\* - Modbus/TCP (optional)

## CYBER SECURITY

---

- Cyber Security, Level 1 (iNET-II only):
- Cyber Security, Level 2:
- AES-128 encryption (optional)
- RC4-128 encryption (iNET only)
  - Automatic rotating key algorithm
  - Authentication: 802.1x, EAP/TLS, PKI, PAP, CHAP
  - Management: SSL, SSH, HTTPS
  - Approved AP/Remotes list (local authentication)
  - Failed login lockdown
  - 900 MHz operation and proprietary data framing

## RADIO CHARACTERISTICS

---

### GENERAL:

Frequency Range:	902–928 MHz ISM Band
Frequency Hopping Range:	iNET: Ten user-configurable 2.5 MHz-wide zones, each containing 8 frequencies (iNET) iNET-II: From one and up to 75 overlapping channels
Hop Patterns:	8192, based on network name
Frequency Stability:	20 ppm

### TRANSMITTER:

Power Output (at antenna connector):	0.1 to 1.0 watt (+20 dBm to +30 dBm) $\pm$ 1.0 dB, <i>set by user</i>
Duty Cycle:	Continuous
Modulation Type:	Binary CPFSK
Output Impedance:	50 Ohms
Spurious:	–67 dBc
Occupied Bandwidth:	GE MDS iNET: 316.5 kHz GE MDS iNET-II: 600 kHz

### RECEIVER:

Type:	Double conversion superheterodyne
Sensitivity:	GE MDS iNET: –92 dBm @ 512 kbps < $1 \times 10^{-6}$ BER GE MDS iNET: –99 dBm @ 256 kbps < $1 \times 10^{-6}$ BER GE MDS iNET-II: –92 dBm @ 1 Mbps < $1 \times 10^{-6}$ BER GE MDS iNET-II: –97 dBm @ 512 kbps < $1 \times 10^{-6}$ BER
Intermodulation:	59 dB Minimum (EIA)
Desensitization:	70 dB
Spurious:	60 dB

### TRANSMIT/RECEIVE RANGE (Nominal)

	<u>GE MDS iNET-256 kbps</u>	<u>GE MDS iNET-II-512</u>
Fixed Range (typical):	15 miles (24 km)	12 miles (19 km)
Fixed Range (maximum):	60 miles (97 km)	30 miles (48 km)
Mobile Range (parked):	5 miles (8 km)	3 miles (5 km)
Mobile Range (moving):	3 miles (5 km)	1 mile (2 km)
	<u>GE MDS iNET-512 kbps</u>	<u>GE MDS iNET-II-1024</u>
Fixed Range (typical):	8 miles (13 km)	8 miles (13 km)
Fixed Range (maximum):	15 miles (24 km)	15 miles (24 km)

*Note: Specifications subject to change without notice or obligation.*

**NOTE:** Range calculations for fixed locations assume a 6 dBd gain Omnidirectional antenna on a 100 ft tower at the AP, a 10 dBd gain Yagi on a 25 ft mast at the remote with output power decreased to yield maximum allowable EIRP (36 dBm), a 10 dB fade margin, and a mix of agricultural and commercial terrain with line of sight.

Range calculations for mobile units assume a 6 dBd gain Omni on a 100 ft tower at the AP, a 5 dBd gain Omni with 1 watt output power at 6 ft height, a 10 dB fade margin, and 90% confidence with near line-of-sight in a mix of agricultural and commercial terrain.

Actual performance is dependent on many factors including antenna height, blocked paths, and terrain.

## 5.4 CHANNEL HOP TABLE

The GE MDS iNET transceiver's hop table consists of 80 channels, numbered 0 to 79 as listed in Table 5-4. Center frequencies are calculated as follows (where  $F_n$  is the center frequency of channel  $n$ ):

$$F_n = 902.5 \text{ MHz} + n * 316.5 \text{ kHz}$$

The GE MDS iNET-II transceiver operates on the same channel assignments, but because the modulation bandwidth is 600 kHz instead of 316.5 kHz it is recommended that the installer restrict channel usage to every other channel for units operating in the same area.

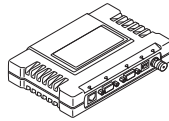
**NOTE:** Channels 24, 26, and 55 are not used.

**Table 5-4. Channel Hop Table**

<b>Zone</b>	<b>Channel</b>	<b>Frequency</b>
1	0	902.5000 <i>(iNET FHSS lowest channel)</i>
1	1	902.8165 <i>(iNET-II DTS lowest channel)</i>
1	2	903.1330
1	3	903.4495
1	4	903.7660
1	5	904.0825
1	6	904.3990
1	7	904.7155
2	8	905.0320
2	9	905.3485
2	10	905.6650
2	11	905.9815
2	12	906.2980
2	13	906.6145
2	14	906.9310
2	15	907.2475
3	16	907.5640
3	17	907.8805
3	18	908.1970
3	19	908.5135
3	20	908.8300
3	21	909.1465
3	22	909.4630
3	23	909.7795
4	24	910.0960
4	25	910.4125
4	26	910.7290
4	27	911.0455
4	28	911.3620
4	29	911.6785
4	30	911.9950
4	31	912.3115
5	32	912.6280
5	33	912.9445
5	34	913.2610
5	35	913.5775
5	36	913.8940
5	37	914.2105
5	38	914.5270
5	39	914.8435

**Table 5-4. Channel Hop Table (Continued)**

<b>Zone</b>	<b>Channel</b>	<b>Frequency</b>
6	40	915.1600
6	41	915.4765
6	42	915.7930
6	43	916.1095
6	44	916.4260
6	45	916.7425
6	46	917.0590
6	47	917.3755
7	48	917.6920
7	49	918.0085
7	50	918.3250
7	51	918.6415
7	52	918.9580
7	53	919.2745
7	54	919.5910
7	55	919.9075
8	56	920.2240
8	57	920.5405
8	58	920.8570
8	59	921.1735
8	60	921.4900
8	61	921.8065
8	62	922.1230
8	63	922.4395
9	64	922.7560
9	65	923.0725
9	66	923.3890
9	67	923.7055
9	68	924.0220
9	69	924.3385
9	70	924.6550
9	71	924.9715
10	72	925.2880
10	73	925.6045
10	74	925.9210
10	75	926.2375
10	76	926.5540
10	77	926.8705
10	78	927.1870 <i>(iNET-II DTS highest channel)</i>
10	79	927.5035 <i>(iNET FHSS highest channel)</i>





# 6 GLOSSARY OF TERMS AND ABBREVIATIONS

If you are new to wireless IP/Ethernet systems, some of the terms used in this guide may be unfamiliar. The following glossary explains many of these terms and will prove helpful in understanding the operation of your radio network.

**Access Point (AP)**—The transceiver in the network that provides synchronization information to one or more associated Remote units. AP units may be configured for either the Access Point (master) or Remote services. (See “Network Configuration Menu” on Page 37.)

**Active Scanning**—See *Passive Scanning*

**Antenna System Gain**—A figure, normally expressed in dB, representing the power increase resulting from the use of a gain-type antenna. System losses (from the feedline and coaxial connectors, for example) are subtracted from this figure to calculate the total antenna system gain.

**AP**—See *Access Point*

**Association**—Condition in which the frequency hopping pattern of the Remote is synchronized with the Access Point station and is ready to pass traffic.

**Authorization Key**—Alphanumeric string (code) that is used to enable additional capabilities in the transceiver.

**Bit**—The smallest unit of digital data, often represented by a one or a zero. Eight bits (plus start, stop, and parity bits) usually comprise a byte.

**Bits-per-second**—See *BPS*.

**BPDU**—Bridge Protocol Data Units

**BPS**—Bits-per-second (bps). A measure of the information transfer rate of digital data across a communication channel.

**Byte**—A string of digital data usually made up of eight data bits and start, stop and parity bits.

**CSMA/CA**—Carrier Sense Multiple Access/Collision Avoidance

**CSMA/CD**—Carrier Sense Multiple Access/Collision Detection

**Cyclic Redundancy Check (CRC)**—A technique used to verify data integrity. It is based on an algorithm which generates a value derived

from the number and order of bits in a data string. This value is compared with a locally-generated value and a match indicates that the message is unchanged, and therefore valid.

**Datagram**—A data string consisting of an IP header and the IP message within.

**dBi**—Decibels referenced to an “ideal” isotropic radiator in free space. Frequently used to express antenna gain.

**dBm**—Decibels referenced to one milliwatt. An absolute unit used to measure signal power, as in transmitter power output, or received signal strength.

**DCE**—Data Circuit-terminating Equipment (or Data Communications Equipment). In data communications terminology, this is the “modem” side of a computer-to-modem connection. COM1 Port of the transceiver is set as DCE.

**Decibel (dB)**—A measure of the ratio between two signal levels. Frequently used to express the gain (or loss) of a system.

**Delimiter**—A flag that marks the beginning and end of a data packet.

**DHCP (Dynamic Host Configuration Protocol)**—An Internet standard that allows a client (i.e. any computer or network device) to obtain an IP address from a server on the network. This allows network administrators to avoid the tedious process of manually configuring and managing IP addresses for a large number of users and devices. When a network device powers on, if it is configured to use DHCP, it will contact a DHCP server on the network and request an IP address.

The DHCP server will provide an address from a pool of addresses allocated by the network administrator. The network device may use this address on a “time lease” basis or indefinitely depending on the policy set by the network administrator. The DHCP server can restrict allocation of IP addresses based on security policies. An Access Point may be configured by the system administrator to act as a DHCP server if one is not available on the wired network.

**DTE**—Data Terminal Equipment. A device that provides data in the form of digital signals at its output. Connects to the DCE device.

**Encapsulation**—Process in by which, a complete data packet, such as Modbus frame or any other polled asynchronous protocol frame, is placed in the data portion of another protocol frame (in this case IP) to be transported over a network. Typically this action is done at the receiving end, before being sent as an IP packet to a network. A similar reversed process is applied at the other end of the network extracting the data from the IP envelope, resulting in the original packet in the original protocol.



**Endpoint**—IP address of data equipment connected to the ports of the radio.

**Equalization**—The process of reducing the effects of amplitude, frequency or phase distortion with compensating networks.

**Fade Margin**—The greatest tolerable reduction in average received signal strength that will be anticipated under most conditions. Provides an allowance for reduced signal strength due to multipath, slight antenna movement or changing atmospheric losses. A fade margin of 15 to 20 dB is usually sufficient in most systems.

**Fragmentation**—A technique used for breaking a large message down into smaller parts so it can be accommodated by a less capable media.

**Frame**—A segment of data that adheres to a specific data protocol and contains definite start and end points. It provides a method of synchronizing transmissions.

**Frequency Hopping**—The spread spectrum technique used by the transceiver, where two or more associated radios change their operating frequencies several times per second using a set pattern. Since the pattern appears to jump around, it is said to “hop” from one frequency to another.

**Frequency Zone**—The radio uses up to 80 discrete channels in the 902 to 928 MHz spectrum. A group of 8 channels is referred to as a zone; in total there are 10 zones.

**Hardware Flow Control**—A transceiver feature used to prevent data buffer overruns when handling high-speed data from the connected data communications device. When the buffer approaches overflow, the radio drops the clear-to-send (CTS) line, that instructs the connected device to delay further transmission until CTS again returns to the high state.

**Hop Pattern Seed**—A user-selectable value to be added to the hop pattern formula in an unlikely event of nearly identical hop patterns of two collocated or nearby radio networks to eliminate adjacent-network interference.

**Host Computer**—The computer installed at the master station site, that controls the collection of data from one or more remote sites.

**HTTP**—Hypertext Transfer Protocol

**IAPP (inter-Access Point Protocol)**—A protocol by which access points share information about the stations that are connected to them. When a station connects to an access point, the access point updates its database. When a station leaves one access point and roams to another

access point, the new access point tells the old access point, using IAPP, that the station has left and is now located on the new access point.

**ICMP**—Internet Control Message Protocol

**IGMP (Internet Gateway Management Protocol)**—Ethernet level protocol used by routers and similar devices to manage the distribution of multicast addresses in a network.

**IEEE**—Institute of Electrical and Electronic Engineers

**Image (File)**—Data file that contains the operating system and other essential resources for the basic operation of the radio's CPU.

**LAN**—Local Area Network

**Latency**—The delay (usually expressed in milliseconds) between when data is applied at the transmit port at one radio, until it appears at the receive port at the other radio.

**MAC**—Media Access Control

**MD5**—A highly secure data encoding scheme. MD5 is a one-way hash algorithm that takes any length of data and produces a 128 bit “fingerprint.” This fingerprint is “non-reversible,” it is computationally infeasible to determine the file based on the fingerprint. For more details review “RFC 1321” available on the Internet.

**MIB**—Management Information Base

**Microcontroller Unit**—See *MCU*.

**Mobile IP**—An emerging standard by which access points and stations maintain network connectivity as the stations move between various IP networks. Through the use of Mobile IP a station can move from its home IP network to a foreign network while still sending and receiving data using its original IP address. Other hosts on the network will not need to know that the station is no longer in its home network and can continue to send data to the IP address that was assigned to the station. Mobile IP also uses DHCP when the station moves into a foreign network.

**Mobile Station**—Refers to a station that moves about while maintaining active connections with the network. Mobility generally implies physical motion. The movement of the station is not limited to a specific network and IP subnet. In order for a station to be mobile it must establish and tear down connections with various access points as it moves through the access points' territory. To do this, the station employs roaming and Mobile IP.

**MTBF**—Mean-Time Between Failures

**Multiple Address System (MAS)**—See *Point-Multipoint System*.

**Network Name**—User-selectable alphanumeric string that is used to identify a group of radio units that form a communications network. The Access Point and all Remotes within a given system should have the same network address.

**Network-Wide Diagnostics**—An advanced method of controlling and interrogating GE MDS radios in a radio network.

**NTP**—Network Time Protocol

**Packet**—The basic unit of data carried on a link layer. On an IP network, this refers to an entire IP datagram or a fragment thereof.

**Passive Scanning**—Scanning is a process used by stations to detect other access points on network to which it may connect if it needs to roam. Passive scanning is a slower process in which it listens for information offered by the access points on a regular basis. Active scanning is a faster process in which the station sends out probe message to which the access points respond. Passive scanning can be done while maintaining the current network connectivity. Active scanning affects the RF configuration of the radio and therefore, at least temporarily, disconnects the station from the access point.

**PING**—Packet Internet Groper. Diagnostic message generally used to test reachability of a network device, either over a wired or wireless network.

**Point-Multipoint System**—A radio communications network or system designed with a central control station that exchanges data with a number of remote locations equipped with terminal equipment.

**Poll**—A request for data issued from the host computer (or master PLC) to a remote radio.

**Portability**—A station is considered connected when it has successfully authenticated and associated with an access point. A station is considered authenticated when it has agreed with the access point on the type of encryption that will be used for data packets traveling between them. The process of association causes a station to be bound to an access point and allows it to receive and transmit packets to and from the access point. In order for a station to be associated it must first authenticate with the access point. The authentication and association processes occur automatically without user intervention.

Portability refers to the ability of a station to connect to an access point from multiple locations without the need to reconfigure the network settings. For example, a remote transceiver that is connected to an access point may be turned off, moved to new site, turned back on, and,

assuming the right information is entered, can immediately reconnect to the access point without user intervention.

**PLC**—Programmable Logic Controller. A dedicated microprocessor configured for a specific application with discrete inputs and outputs. It can serve as a host or as an RTU.

**PuTTY**—A free implementation of Telnet and SSH for Win32 and Unix platforms. It is written and maintained primarily by Simon Tatham. Refer to <http://www.pobox.com/~anakin/> for more information.

**Remote**—A transceiver in a network that communicates with an associated Access Point.

**RFI**—Radio Frequency Interference

**Roaming**—A station's ability to automatically switch its wireless connection between various access points (APs) as the need arises. A station may roam from one AP to another because the signal strength or quality of the current AP has degraded below what another AP can provide. When two access points are co-located for redundancy, roaming allows the stations to switch between them to provide a robust network. Roaming may also be employed in conjunction with Portability where the station has been moved beyond the range of the original AP to which it was connected. As the station comes in range of a new AP, it will switch its connection to the stronger signal. Roaming refers to a station's logical, not necessarily physical, move between access points within a specific network and IP subnet.

**RSSI**—Received Signal Strength Indicator

**RTU**—Remote Terminal Unit. A data collection device installed at a remote radio site.

**SCADA**—Supervisory Control And Data Acquisition. An overall term for the functions commonly provided through an MAS radio system.

**SNMP**—Simple Network Management Protocol

**SNR**—Signal-to-Noise Ratio. A measurement of the desired signal to ambient noise levels. This measurement provides a relative indication of signal quality. Because this is a relative number, higher signal-to-noise ratios indicate improved performance.

**SNTP**—Simple Network Time Protocol

**SSL**—Secure Socket Layer

**SSH**—Secure Shell

**STP**—Spanning Tree Protocol

**SWR**—Standing-Wave Ratio. A parameter related to the ratio between forward transmitter power and the reflected power from the antenna system. As a general guideline, reflected power should not exceed 10% of the forward power ( $\approx 2:1$  SWR).

**TCP**—Transmission Control Protocol

**TFTP**—Trivial File Transfer Protocol

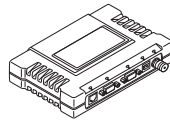
**Trap Manager**—Software that collects SNMP traps for display or logging of events.

**UDP**—User Datagram Protocol

**UTP**—Unshielded Twisted Pair

**WINS**—Windows Internet Naming Service. Part of Microsoft Windows NT and 2000 servers that manages the association of workstation names and locations with Internet Protocol addresses. It works without the user or an administrator having to be involved in each configuration change. Similar to DNS.

**Zone**—See *Frequency Zone*.



---

# INDEX

---

## Numerics

100BaseT 129  
10BaseT 129  
802.11b 10

## A

Access Point (AP), defined 165  
accessories 17  
Active Scanning, defined 165, 169  
Actual Data Rate 86  
Add Associated Remotes 82  
AgeTime 96, 97  
alarm conditions 120  
    correcting 122  
Alarmed 118  
Antenna  
    aiming 141  
    directional 136  
    Minimum Feedline Length versus Antenna Gain 135  
    omnidirectional 133  
    polarization 133  
    selection 132  
    SWR check 140  
    system gain 165  
    system gain vs. power output setting 138  
    system gain, defined 165  
    Yagi 134  
AP  
    Auto Upgrade 95  
    Reboot when Upgraded 95  
application  
    IP-to-Serial 71  
    Mixed-Modes 76  
    Point-to-Multipoint Serial-to-Serial 72  
    Point-to-Point Serial-to-Serial 74  
    Serial Port 76  
Approved  
    Access Points/Remotes List 81  
    Remotes/Access Points List 81  
Associated 118  
Association  
    Date 95  
    defined 165  
    Process 94  
    Time 95  
Auth Traps Status 49  
Authorization Key 108, 111  
    defined 165  
Authorized Features 108  
Auto Data Rate Menu  
    SNR Threshold/Delta 58  
Auto Key Rotation 81  
Auto-Upgrade/Remote-Reboot 108

## B

Backhaul  
    for Serial Radio Networks 8  
    Network 9  
bandpass filter 137  
Beacon  
    Period 53, 145, 146  
    signal 94  
Begin Wizard 64  
Bit, defined 165  
Bits-per-second (bps), defined 165  
BPDU 144  
    defined 165  
BPS, defined 165  
bridging 159  
    remote-to-remote 39  
Bytes  
    defined 165  
    in on port 99  
    in on socket 99  
    out on port 99  
    out on socket 99  
    received 92  
    sent 92

## C

cable  
    feedlines 134  
Clear  
    Com# statistics 99  
    Ethernet stats 92  
    Log 89  
    Wireless stats 92  
Client Inactivity Timeout 68  
Collocating Multiple Radio Networks 14  
Commit Changes and Exit Wizard 66, 67, 69, 70, 71  
compression 52, 145  
configuration 65, 67, 68, 70, 71  
    basic device parameters 35  
    DHCP server 46  
    editing files 107  
    Ethernet Port 45  
    file 115  
    PPP Mode 70  
    radio parameters 51  
    scripts 105  
    security 78  
    SNMP Agent 47  
    TCP Mode 68  
    UDP mode 64  
Connection Status 95  
connectors 155  
Contact 36

- cost of deployment 9
- Count 111
- CRC (Cyclic Redundancy Check), defined 165
- CSMA
  - CA, defined 165
  - CD, defined 165
- Current
  - Alarms 89
  - AP IP Address 95
  - AP Mac Address 95
- Custom Data Buffer Size 66, 67, 69, 70, 71

## D

- data
  - baud 71
  - baud rate 65, 67, 68, 70
  - buffering 63, 69
  - compression 145
  - rate 52
- Datagram, defined 166
- DataRate 96
- Date 35
  - Format 35
- dB, defined 166
- dB<sub>i</sub>, defined 166
- dBm
  - defined 166
  - watts-volts conversion 143
- DCE, defined 166
- defaults
  - reset to factory 111
- Delete
  - All Remotes 82
  - Remote 82
- Delimiter, defined 166
- deployment costs 9
- Description 36
- Device
  - IP Address 71
  - Mode 32
  - Name 32, 36
  - Status 32, 118
- DHCP
  - defined 166
  - Netmask 47
- Diagnostic Tools 120
- dimensions 129
- DKEY command 140
- DNS Address 47
- DTE 11, 60
- Dwell Time 52, 146

## E

- EIA-232 11
- Encapsulation, defined 166
- Encryption 81
  - Phrase 81
- Ending Address 47
- Endpoint
  - defined 167

- Listing 87
- Listing Menu 97
- ENI, MDS iNET 900 3
- Equalization, defined 167
- Ethernet
  - Link (H/W) Watch 46
  - Link Poll Address 46
  - Packet Statistics 92
  - port enabled/disabled 45
  - Rate Limit 45
- Event Log 86, 88, 118, 120, 122, 123

## F

- Fade Margin 167
- Feedline
  - selection 132, 134
- Filename 90, 101
- firewall 147
- firmware
  - installing 102
  - upgrade 102, 109
  - version 33, 35
- Flow Control 63, 65, 67, 68, 70, 71
  - hardware, defined 167
- Force Key Rotation 81
- Force Reboot 109
- Fragmentation
  - defined 167
  - Threshold 53, 146
- Frame, defined 167
- Frequency 110
  - zone, defined 167
- fuse replacement 157

## G

- gain
  - antenna, defined 165
  - system 137
- Glossary 165–171
- Go 111

## H

- Hardware
  - flow control, defined 167
  - Version 33, 35
- Hop
  - Format 54
  - pattern 137
  - Pattern Seed 53
  - Sync 118
- Hopping
  - channels 161
- HTTP
  - defined 167
  - Security Mode 80



**I**

- IETF standard RFC1213 47
- IGMP 62
  - defined 168
- Image
  - Copy 102
  - file, defined 168
  - Verify 102
- iNET II, differences of 3, 51, 52, 57, 59, 98, 132, 135, 141
- Installation
  - antenna & feedline 132
  - feedline selection 134
  - general information 3
  - planning 129
  - requirements 129
  - site selection 131
  - site survey 136
- Interference 136
- Internet
  - Assigned Numbers Authority 62
- IP 46
  - Addr 111
  - Address 32, 96, 97, 107
  - Gateway 107
  - Mobile, defined 168
  - Protocol 65, 66, 68, 69, 71
  - tunneling 61

**K**

- Key
  - transmitter, for antenna SWR check 140
- KEY command 140

**L**

- LAN
  - defined 168
- Latency 145
- Latency, defined 168
- Latest AP Firmware Version 95
- LED
  - LAN 116
  - LINK 116, 136, 141
  - PWR 88, 90, 116, 120, 123
  - use during troubleshooting 115
- Link Established 71
- Local
  - Area Network, defined 168
  - IP Port 65, 66
  - Listening IP Port 69
- Location 36, 107
- Logged Events 123
- Lost Carrier Detected 92, 119

**M**

- MAC Address 96, 97, 144
- Management System
  - user interfaces 23
- MD5, defined 168
- MDS iNET 900 ENI 3
- MDS Security Suite 15
- measurements
  - radio 139
- MIB
  - defined 168
  - files 47
- Mobile IP, defined 168
- Mobility 58
- Mobility Capability 11
- MODBUS 69
- Mode
  - serial gateway interface 11
  - TCP 11
  - UDP 11
- Model Number 35
- MTBF, defined 168
- Multicast
  - IP Address 65
  - IP Port 65
- multiple
  - protocols 9
  - services 9

**N**

- NEMA 10
- Network
  - Name 14, 32
  - Name, defined 169
  - Time Protocol (NTP), defined 169
- network
  - maintenance 99
  - performance verification 85
- network design 12
  - antennas 13
  - collocating multiple radio networks 14
  - network name 13
  - repeaters 12
  - using multiple Access Points 14
  - Using the AP as a Store-and-Forward Packet Repeater 13
  - using two transceivers to form a repeater station 12
- NTP (Network Time Protocol), defined 169

**O**

- Owner 36

**P**

- Packet
  - defined 169
  - Redundancy Mode 65, 67
  - Size 111
  - Statistics 87, 91, 119
- Packets
  - Dropped 92, 119
  - Packets-per-Second 145
  - Received 91, 92
  - Received by Zone 93
  - Sent 92
- Passive Scanning, defined 169
- Password Reset 111
- Performance Information Menu 146
- PING 136
  - defined 169
- Ping Utility 111
- PLC 10
  - defined 170
- Point-Multipoint System, defined 169
- Point-to-Point
  - LAN Extension 8
  - Link 8
- Poll, defined 169
- port
  - antenna 140
  - COM1 11, 60, 72, 132, 156
  - COM2 11, 60, 72, 156
  - IP 72
  - LAN 155
  - not Enabled 71
  - well-known 147
- Portability, defined 169
- ports
  - serial 9
- power
  - how much can be used 135
  - transmitter power output 140
- PPP 63
- Primary Host Address 68
- Primary IP Port 68
- Programmable Logic Controller 10
- protocol
  - BPDU 144
  - IP 46, 60
  - MODBUS 69
  - PPP 63
  - SNMP 23, 47, 147
    - defined 170
  - SNTP 170
  - STP 144
  - STP, defined 170
  - TCP 61, 68, 71, 75, 145
    - defined 171
  - TFTP 102
    - defined 171
  - UDP 61, 62, 71, 74, 75, 145
- PuTTY usage 27
  - defined 170

**R**

- Radio
  - Frequency Interference 15, 136
  - Remote, defined 170
  - Test 110
- range, transmission 10
- Read Community String 48
- Reboot
  - Device 102
  - on Upgrade 109
- Receive errors 92, 119
- Received Signal Strength Indicator 132
  - defined 170
- Redundancy
  - Using multiple Access Points 14
- Remote
  - IP Address 66
  - IP Port 66
  - Listing 87
  - Listing Menu 96
  - Performance Listing 87, 98
  - radio, defined 170
  - Terminal Unit 10
  - Terminal Unit, defined 170
- Repeater 12
  - antennas 13
  - Network Name 13
  - Using the AP as a Store-and-Forward Packet Repeater 13
  - Using two transceivers to form a repeater station 12
- reprogramming 100
- Resetting the Password 111
- Restart DHCP Server 47
- Retries 92, 119
- Retrieve File 102, 106
- Retry errors 92, 119
- RetryEr 98
- RF Output Power 52, 86
- RFI 15
  - defined 170
- Roaming, defined 170
- RSSI 111, 119, 132, 141
  - by Zone 86, 87
  - defined 170
  - Threshold 54
- RTS Threshold 53, 146
- RTS/CTS handshaking 65
- RTU 10, 60, 72, 75
  - defined 170
- RxBMCM 98
- RxPkts 97, 98
- RxRate 98
- RxViaEP 98

**S**

- Save Changes 82
- SCADA 9, 10, 62
  - defined 170
- Scanning 118
  - Active, defined 169
  - Passive, defined 169
- Seamless Inter-Frame Delay 65, 67, 69, 70, 71
- Secondary
  - Host Address 68
  - IP Port 68
- security
  - Approved Access Points/Remotes List 81
  - Auto Key Rotation 81
  - encryption 81
  - Encryption Phrase 81
  - Force Key Rotation 81
  - general information 4
  - HTTP Security Mode 80
  - risks 16
  - suite 15
  - Telnet Access 80
  - Two-Way Authentication 79
  - User Password 79
- Send
  - File 106
  - Log 89
- Sending LCP Requests 71
- Serial
  - Configuration Wizard 63
  - Data Statistics 99
  - encapsulation 61
  - Mode 65, 67, 69, 70, 71
  - Number 33, 35
  - Port Statistics 119
  - radio networks, backhaul 8
- Server Status 47
- Signal strength 132
- Signal-to-Noise Ratio 86
  - defined 170
- Simple Network
  - Management Protocol, defined 170
  - Time Protocol, defined 170
- Site selection 131
- SNMP 23
  - defined 170
  - Mode 49, 80
  - traps 150
  - usage 147
  - V3 Passwords 49
- SNR 54
  - defined 170
  - Threshold 54
- SNTP
  - defined 170
- Spanning Tree Protocol 144
- Spanning Tree Protocol, defined 170
- Specifications 158–161
- SSH, defined 170
- SSL, defined 170

- Standing Wave Ratio 171
- Starting
  - Address 47
  - Information Screen 34
- State 96
- Status 32, 64, 66, 68, 69, 71
- STP, defined 170
- SWR 140, 171
  - performance optimization 140
- Syslog Server 90
- system gain, antenna 165
- system gain, antenna (defined) 165

**T**

- TCP 11, 75, 145
  - Client 62
  - defined 171
  - Server 62
- Telnet 72
  - Access 80
- Test Mode 110
- TFTP
  - defined 171
  - Host Address 89, 101, 106
  - Time-out 90
  - Timeout 102, 106
- Time 35
- Time to Live (TTL) 65
- Transmission
  - Control Protocol, defined 171
  - range 10
- transparent encapsulation 61
- Trap
  - Community String 48
  - Manager 49
  - Manager, defined 171
  - Version 49
- Troubleshooting 115–125
  - Using the Embedded Management System 116
- Two-Way Authentication 79
- TX Output Power 110
- TxKey 110
- TxPkt 97
- TxPkts 98
- TxViaEP 98

**U**

- UDP 11, 62, 74, 75, 145
  - defined 171
  - mode 64
- Unit Name 107
- Uptime 33, 35
- User Password 79
- Using multiple Access Points 14

**V**

V3

Authentication Password 49

Privacy Password 49

via Remote 97

View

Approved Remotes 82

Current Alarms 90

Current Settings 64

Event Log 91

Log 89

VLAN 38, 39, 40, 77

Configuring for operation with 41

Configuring IP Address with VLAN disabled 43

Configuring IP Address with VLAN enabled 42

volts-dBm-watts conversion 143

**W**

watts-dBm-volts conversion 143

WINS

Address 47

defined 171

Wireless

Network Status 87, 94

Packet Statistics 91

wizard

serial configuration 63

Write community String 48

**Y**

Yagi antenna 134

**Z**

Zone, defined 171

## ***IN CASE OF DIFFICULTY...***

---

GE MDS products are designed for long life and trouble-free operation. However, this equipment, as with all electronic equipment, may have an occasional component failure. The following information will assist you in the event that servicing becomes necessary.

### **TECHNICAL ASSISTANCE**

---

Technical assistance for GE MDS products is available from our Technical Support Department during business hours (8:00 A.M.—5:30 P.M. Eastern Time). When calling, please give the complete model number of the radio, along with a description of the trouble/symptom(s) that you are experiencing. In many cases, problems can be resolved over the telephone, without the need for returning the unit to the factory. Please use one of the following means for product assistance:

Phone: 585 241-5510      E-Mail: [TechSupport@GEmds.com](mailto:TechSupport@GEmds.com)  
FAX: 585 242-8369      Web: [www.GEmds.com](http://www.GEmds.com)

### **FACTORY SERVICE**

---

Component level repair of radio equipment is not recommended in the field. Many components are installed using surface mount technology, which requires specialized training and equipment for proper servicing. For this reason, the equipment should be returned to the factory for any PC board repairs. The factory is best equipped to diagnose, repair and align your radio to its proper operating specifications.

If return of the equipment is necessary, you will be issued a Service Request Order (SRO) number. The SRO number will help expedite the repair so that the equipment can be repaired and returned to you as quickly as possible. Please be sure to include the SRO number on the outside of the shipping box, and on any correspondence relating to the repair. No equipment will be accepted for repair without an SRO number.

A statement should accompany the radio describing, in detail, the trouble symptom(s), and a description of any associated equipment normally connected to the radio. It is also important to include the name and telephone number of a person in your organization who can be contacted if additional information is required.

The radio must be properly packed for return to the factory. The original shipping container and packaging materials should be used whenever possible. All factory returns should be addressed to:

GE MDS  
Product Services Department  
(SRO No. XXXX)  
175 Science Parkway  
Rochester, NY 14620 USA

When repairs have been completed, the equipment will be returned to you by the same shipping method used to send it to the factory. Please specify if you wish to make different shipping arrangements. To inquire about an in-process repair, you may contact our Product Services Group at 585-241-5540 (FAX: 585-242-8400), or via e-mail at [ProductServices@GEmds.com](mailto:ProductServices@GEmds.com).



GE MDS

industrial wireless networks

GE MDS, LLC  
175 Science Parkway  
Rochester, NY 14620  
General Business: +1 585 242-9600  
FAX: +1 585 242-9620  
Web: [www.GEmds.com](http://www.GEmds.com)

