

GE  
Sensing & Inspection Technologies

# Druck PV 62x

## pneumatic/hydraulic pressure stations

user manual - K0457



## Quick reference data

### A1.1

<b>PV 621: Pneumatic pressure station</b>
-950 mbar to 20 bar (-13.5 to 300 psi)
<b>PV 622: Pneumatic pressure station</b>
-950 mbar to 100 bar (-13.5 to 1500 psi)
<b>PV 623: Hydraulic pressure station</b>
0 to 1000 bar (0 to 15000 psi)

### A1.2 PV 62x + DPI 620 + PM 620

<b>Recommended pressure modules (PM 620) *</b>	
PV 621 models	25 mbar to 20 bar (0.36 to 300 psi)
PV 622 models	25 mbar to 100 bar (0.36 to 1500 psi)
PV 623 models	70 to 1000 bar (1000 to 15000 psi)

**\*Caution: To prevent damage to the PM 620 module, only use it within the specified pressure limit on the label.**

### A1.3 PV 62x pressure relief valves (PRV)

(Recommended options)

<b>Parts: IO620-PRV-P1 to P5 (Pneumatic)</b>	
PV 621 models	1 to 30 bar (14.5 to 435 psi)
PV 622 models	1 to 100 bar (14.5 to 1500 psi)
<b>Parts: IO620-PRV-H1 to H5 (Hydraulic)</b>	
PV 623 models	50 to 1000 bar (725 to 15000 psi)

## Copyright

© 2008 General Electric Company. All rights reserved.

## Trademarks

All product names are trademarks of their respective companies.

---

## Safety

Before you use the instrument, make sure that you read and understand all the related data. This includes: the applicable local safety procedures, this publication, and the instructions for the accessories/options/equipment you are using it with.

---

### General warnings

---

#### **⚠ WARNING ⚠**

---

- **It is dangerous to ignore the specified limits for the instrument or to use the instrument when it is not in its normal condition. Use the applicable protection and obey all safety precautions.**
- **Do not use the instrument in locations with explosive gas, vapour or dust. There is a risk of an explosion.**

---

### Pressure warnings

- **It is dangerous to attach an external source of pressure to a PV 62x series pressure station. Use only the internal mechanisms to set and control the pressure in the pressure station.**
- **Some liquid and gas mixtures are dangerous. This includes mixtures that occur because of contamination. Make sure that the equipment is safe to use with the necessary media.**
- **Pressurized gases and fluids are dangerous. Before you attach or disconnect pressure equipment, safely release all the pressure.**
- **To prevent a dangerous release of pressure, make sure that all the related pipes, hoses and equipment have the correct pressure rating, are safe to use and are correctly attached.**

---

### Electrical warnings

If you use the DPI 620 calibrator with your pressure station, these warnings are also applicable:

- **To prevent electrical shocks or damage to the DPI 620 calibrator, do not connect more than 30V between the terminals, or between the terminals and the ground (earth).**
- **This instrument uses a Lithium-Polymer (Li-Polymer) battery pack. To prevent an explosion or fire, do not short circuit, do not disassemble, keep it safe from damage.**

*Continued*

- To prevent an explosion or fire, use only the GE specified battery, power supply and battery charger.
- To make sure the display shows the correct data, disconnect the test leads before you set the power to on or change to another measure or source function.

**Cautions**

**To prevent damage to the instrument, do not let dirt get into the pressure mechanism. Before you attach equipment, make sure it is clean.**

**To prevent damage to the instrument when you move it, hold the body of the pressure station or use the carry strap (or specified accessories).**

**PV 621/PV 622 models only. Before you turn the pressure/vacuum selector to + or -, release all the pressure. Sudden high pressure in the pump mechanism can cause damage.**







**PV 623 models only. Ice in the pressure mechanism can cause damage. If the temperature is less than 4°C (39°F), drain all water from the instrument.**

**In its normal condition, the PV 623 model contains hydraulic fluid. To make sure it does not spill out, seal the system and put it on its side before you install a PRV.**

**To prevent damage to the PM 620 module, only use it within the specified pressure limit on the label.**

Before you start an operation or procedure in this publication, make sure that you have the necessary skills (if necessary, with qualifications from an approved training establishment). Follow good engineering practice at all times.

**Marks and symbols on the instrument**

	Complies with European Union directives		
	Read the manual		Warning - refer to the manual
PRV	Pressure relief valve (Refer to Chapter 1; item    )		
	Do not dispose of this product as household waste. Refer to Chapter 6 (Maintenance procedures).		
More marks and symbols are specified in this manual			

## Overview

PV 621



PV 622



PV 623



There are three pressure stations in the PV 62x series:

- two pneumatic pressure stations to give you accurate and controlled pressure and vacuum conditions:

PV 621: -950 mbar to 20 bar (-13.5 to 300 psi) version

PV 622: -950 mbar to 100 bar (-13.5 to 1500 psi) version

- one hydraulic pressure station to give you accurate and controlled hydraulic pressure conditions:

PV 623: 0 to 1000 bar (15000 psi)

To give the attached equipment overpressure protection, there are pressure relief valves (PRV) available for all the pressure stations; refer to Section 1.5 (Accessories).

## Other module options



Pressure calibrator

The pressure stations are part of a set of hand-held modules that you can quickly put together to include a wide range of calibrator functions.

**Pressure calibrator (this user manual):** You can use the pressure stations on their own or you can attach the DPI 620 calibrator and a PM 620 module to make a fully integrated pressure calibrator instrument.



DPI 620

**Advanced modular calibrator, DPI 620 (user manual - K0449):** *Optional item.* This is a battery-powered instrument for electrical measure and source operations and HART® communications. It also supplies the power and user interface functions for all the add-on modules. You can use the touch-screen to display up to six different parameters.



PM 620

**Pressure modules, PM 620 (this user manual):** *Optional item.* These modules attach to a pressure station (PV 62x) to give the DPI 620 calibrator the necessary pressure measurement functionality. They are fully interchangeable “plug and play” modules with no initial set-up or user calibration.

**Software (user manual - K0449):** The DPI 620 calibrator includes the following software:

- documenting software
- HART® communications software

**Other accessories and options:** For part numbers (P/N), refer to Section 1.5 (Accessories).

## Summary of functions

This table gives a summary of the available functions with the PV 62x pressure stations.

### PV 62x - pressure station functions

PV 621



PV 622



PV 623



Pressure calibrator

Function
<b>Pneumatic pressure stations</b>
* PV 621: Pressure from vacuum (95%) to 20 bar (300 psi);
* PV 622: Pressure from vacuum (95%) to 100 bar (1500 psi)
Selector switch to change the pump operation from pressure generator to vacuum generator
Needle point pressure release valve to control the release of pressure.
<b>Hydraulic pressure station</b>
* PV 623: Hydraulic pressure from 0 to 1000 bar (15000 psi)
Internal hydraulic reservoir: 100 cm <sup>3</sup> (6.1 in <sup>3</sup> )
Self sealing pressure module connection to prevent fluid leaks.
Fast thermal stability for devices attached directly to the pressure test connection (≤ one minute)
<b>All pressure stations</b>
“Quick fit” pressure adaptors for the device under test
** Pressure connection for a PM 620 module
Volume adjuster to give accurate control of pressure conditions.
Latch mechanism to attach the DPI 620 calibrator to make a fully integrated pressure calibrator instrument
** Pressure relief valves (PRV) to give overpressure protection.
<b>** Pressure station + DPI 620 calibrator + PM 620 module</b>
Measure pressure/Leak test
Documenting software
HART <sup>®</sup> (Highway Addressable Remote Transducer) communications software to set up and calibrate devices that use the HART <sup>®</sup> field communications protocol.

\* Refer to Chapter 7 (Specification)

\*\* Optional item



---

## About this manual

This user manual is set up for you to use on a computer or similar device that has the necessary software to read a Portable Document Format (PDF) file.

It is supplied as a PDF on a compact disc (CD) but you can copy or save the PDF onto a computer or similar device that has the necessary PDF software.

To navigate between related items of information, the user manual includes cross references and links; for example:

- text cross references: ... Figure 1-1; Table 1-1; Chapter 1; Section 1.5 (Accessories)
- some (but not all) symbols:   

**Note:** *If you move the PDF software cursor over an item that has a link, the cursor symbol normally changes.*

When you click (or tap) on a link, your PDF software shows the applicable page.





## Table of Contents

Quick reference data .....	ii
Safety .....	iii
Overview .....	v
Other module options .....	v
Summary of functions .....	vi
About this manual .....	vii
<b>Chapter 1: Instrument parts, accessories and options</b>	
<b>1.1 Introduction .....</b>	<b>1-1</b>
<b>1.2 PV 621 models .....</b>	<b>1-1</b>
1.2.1 Pressure relief valve (PRV) .....	1-2
1.2.2 Test port .....	1-2
1.2.3 Pneumatic pressure release valve .....	1-2
1.2.4 Volume adjuster .....	1-2
1.2.5 Selector (pressure/vacuum) .....	1-3
1.2.6 Pump (pressure/vacuum) .....	1-3
<b>1.3 PV 622 models .....</b>	<b>1-4</b>
1.3.1 Pressure relief valve (PRV) .....	1-4
1.3.2 Test port .....	1-5
1.3.3 Pneumatic pressure release valve .....	1-5
1.3.4 Pneumatic refill valve .....	1-5
1.3.5 Volume adjuster wheel .....	1-5
1.3.6 Selector (pressure/vacuum) .....	1-7
1.3.7 Pump (pressure/vacuum) .....	1-7
<b>1.4 PV 623 models .....</b>	<b>1-8</b>
1.4.1 Pressure relief valve (PRV) .....	1-8
1.4.2 Test port .....	1-9
1.4.3 Hydraulic pressure release valve/reservoir access .....	1-9
1.4.4 Hydraulic refill valve .....	1-9
1.4.5 Volume adjuster wheel .....	1-10
<b>1.5 Accessories .....</b>	<b>1-11</b>

**Chapter 2: Pneumatic pressure operation (PV 621)**

**2.1 Introduction . . . . . 2-1**

**2.2 Release the pressure. . . . . 2-1**

**2.3 Attach/Remove the device under test . . . . . 2-1**

    2.3.1 Procedure (to attach) . . . . . 2-2

    2.3.2 Procedure (to remove) . . . . . 2-2

**2.4 Attach/Adjust a PRV . . . . . 2-2**

    2.4.1 Procedure (to attach) . . . . . 2-3

    2.4.2 Procedure (to adjust) . . . . . 2-3

**2.5 Vacuum or pressure operation. . . . . 2-3**

    2.5.1 Vacuum procedure . . . . . 2-4

    2.5.2 Pressure procedure . . . . . 2-4

**Chapter 3: Pneumatic pressure operation (PV 622)**

**3.1 Introduction . . . . . 3-1**

**3.2 Release the pressure. . . . . 3-1**

**3.3 Attach/Remove the device under test . . . . . 3-1**

    3.3.1 Procedure (to attach) . . . . . 3-2

    3.3.2 Procedure (to remove) . . . . . 3-2

**3.4 Attach/Adjust a PRV . . . . . 3-2**

    3.4.1 Procedure (to attach) . . . . . 3-3

    3.4.2 Procedure (to adjust) . . . . . 3-3

**3.5 Vacuum or pressure operation. . . . . 3-3**

    3.5.1 Vacuum procedure . . . . . 3-4

    3.5.2 Pressure procedure . . . . . 3-4

**Chapter 4: Hydraulic pressure operation (PV 623)**

**4.1 Introduction . . . . . 4-1**

**4.2 Fill the reservoir. . . . . 4-1**

**4.3 Release the pressure. . . . . 4-2**

**4.4 Attach/Remove the device under test . . . . . 4-2**

    4.4.1 Procedure (to attach) . . . . . 4-2

    4.4.2 Procedure (to remove) . . . . . 4-3

**4.5 Attach/Adjust a PRV . . . . . 4-3**

    4.5.1 Procedure (to attach) . . . . . 4-3

    4.5.2 Procedure (to adjust) . . . . . 4-3

**4.6 Pressure operation . . . . . 4-4**

    4.6.1 Hydraulic pressure procedure. . . . . 4-4

    4.6.2 Add more hydraulic fluid . . . . . 4-5

    4.6.3 Drain hydraulic fluid from the device under test . . . . . 4-5

<b>4.7 Drain all the hydraulic fluid.</b> .....	<b>4-6</b>
4.7.1 Preparation .....	4-6
4.7.2 Procedure .....	4-6
<b>Chapter 5: Pressure calibrator operation (DPI 620)</b>	
<b>5.1 Introduction</b> .....	<b>5-1</b>
<b>5.2 Parts and assembly</b> .....	<b>5-1</b>
5.2.1 DPI 620 calibrator parts .....	5-1
5.2.2 PM 620 module parts .....	5-2
5.2.3 Assembly instructions .....	5-2
<b>5.3 Measure pressure/vacuum</b> .....	<b>5-3</b>
5.3.1 Procedure overview .....	5-3
5.3.2 DPI 620 calibrator: Set the pressure function .....	5-4
5.3.3 DPI 620 calibrator: Set the pressure units .....	5-5
5.3.4 DPI 620 calibrator: Set up a Leak Test .....	5-5
5.3.5 DPI 620 calibrator: Set the PM 620 module to zero .....	5-6
5.3.6 Example procedure: Gauge/indicator calibration .....	5-7
5.3.7 Example procedure: Transmitter calibration .....	5-8
5.3.8 Example procedure: Switch test .....	5-9
<b>Chapter 6: Maintenance procedures</b>	
<b>6.1 Introduction</b> .....	<b>6-1</b>
<b>6.2 Clean the unit</b> .....	<b>6-1</b>
<b>6.3 Drain the unit (PV 623 models)</b> .....	<b>6-1</b>
<b>6.4 Leak test</b> .....	<b>6-1</b>
6.4.1 Preparation .....	6-1
6.4.2 Procedure .....	6-2
<b>Chapter 7: Specification</b>	
<b>7.1 PV 62x models</b> .....	<b>7-1</b>
7.1.1 Pressure data (PV 62x models) .....	7-2
<b>7.2 PM 620 modules</b> .....	<b>7-3</b>
7.2.1 Pressure data (PM 620 modules) .....	7-3
<b>Customer service</b> .....	<b>Back cover</b>



# Chapter 1: Instrument parts, accessories and options

## 1.1 Introduction

This chapter gives a description of the different parts of each instrument and the accessories/options available.

## 1.2 PV 621 models

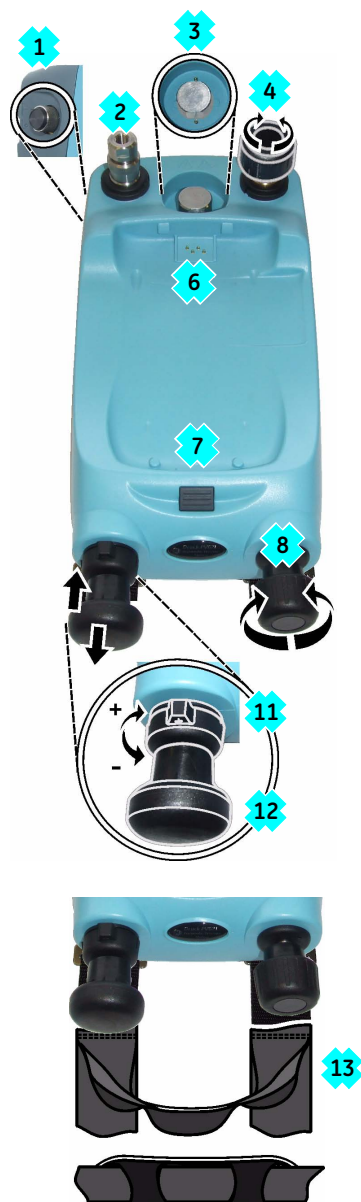

1.	Optional accessory: Pressure connection for a pressure relief valve (PRV); see Section 1.2.1. A blanking plug is standard.
2.	Test port: Pressure connection (G1/8 or 1/8NPT) to attach the device under test; see Section 1.2.2.
3.	Pressure and electrical connections for a PM 620 module. Seal the pressure connection with a blanking plug (P/N IO620-BLANK) or a PM 620 module that has the correct pressure rating.
4.	Pneumatic pressure release valve to release pressure in the system; see Section 1.2.3.
6.	Moulded compartment for the DPI 620 calibrator with electrical connections and a mechanism to hold it in position.
7.	Push-button mechanism to release the DPI 620 calibrator.
8.	Pneumatic volume adjuster; see Section 1.2.4.
11.	Pressure/vacuum selector to set the pump operation: pressure (+), vacuum (-); see Section 1.2.5.
12.	Pump mechanism; see Section 1.2.6.
13.	Carrying strap with a carry handle and a shoulder strap.

Items 5, 9, 10: Not applicable

Figure 1-1: General views

### 1.2.1 **Pressure relief valve (PRV)**



To give your attached devices overpressure protection (device under test, PM 620 module), we recommend you use one of our range of optional pneumatic PRVs; see Section 1.5 (Accessories).

To attach or adjust a PRV, see Section 2.4.

### 1.2.2 **Test port**



To attach the device under test, the test port uses “Quick fit” pressure adaptors; see Section 1.5 (Accessories). These are easy to remove, change and install; see Section 2.3 (Attach/Remove the device under test).

### 1.2.3 **Pneumatic pressure release valve**



This is a needle point valve that lets you release the pressure or vacuum, or seal the system. You can also use it to control a change in pressure conditions; for example, to go to or through another test pressure.



: Open



: Close

### 1.2.4 **Volume adjuster**



This control increases or decreases the pressure/vacuum. Before you seal the system (Section 1.2.3), turn this control to the necessary position:

- for equal adjustment, turn it to the middle of its range
- for maximum adjustment, turn it fully clockwise or counterclockwise

When you have set the necessary pressure or vacuum with the pump (Section 1.2.6), use the volume adjuster to make the last adjustments.

### 1.2.5 11 Selector (pressure/vacuum)



**Caution:** Before you turn the pressure/vacuum selector to + or -, release all the pressure. Sudden high pressure in the pump mechanism can cause damage.

This control sets the operation of the instrument (pressure or vacuum). To prevent a pressure leak, turn it fully clockwise or counterclockwise.

+ : Pressure      - : Vacuum

### 1.2.6 12 Pump (pressure/vacuum)



When you have set the operation to pressure or vacuum (Section 1.2.5), seal the system (Section 1.2.3) and use the pump to set the necessary pressure or vacuum.

You can then make the last adjustments with the volume adjuster (Section 1.2.4).

### 1.3 PV 622 models



1.	Optional accessory: Pressure connection for a pressure relief valve (PRV); see Section 1.3.1. A blanking plug is standard.
2.	Test port: Pressure connection (G1/8 or 1/8NPT) to attach the device under test; see Section 1.3.2.
3.	Pressure and electrical connections for a PM 620 module. Seal the pressure connection with a blanking plug (P/N IO620-BLANK) or a PM 620 module that has the correct pressure rating.
4.	Pneumatic pressure release valve to release pressure in the system; see Section 1.3.3.
5.	Pneumatic refill valve. Close it to seal off all the pressure and refill the pressure mechanism; see Section 1.3.4.
6.	Moulded compartment for the DPI 620 calibrator with electrical connections and a mechanism to hold it in position.
7.	Push-button mechanism to release the DPI 620 calibrator.
9.	Volume adjuster wheel with fold-in handle; see Section 1.3.5.
11.	Pressure/vacuum selector to set the pump operation: pressure (+), vacuum (-); see Section 1.3.6.
12.	Pump mechanism; see Section 1.3.7.
13.	Carrying strap with a carry handle and a shoulder strap.

Items 8, 10: Not applicable

Figure 1-2: General views

#### 1.3.1 2 Pressure relief valve (PRV)



To give your attached devices overpressure protection (device under test, PM 620 module), we recommend you use one of our range of optional pneumatic PRVs; see Section 1.5 (Accessories).

To attach or adjust a PRV, see Section 3.4.



### 1.3.2 **2** Test port



To attach the device under test, the test port uses “Quick fit” pressure adaptors; see Section 1.5 (Accessories). These are easy to remove, change and install; see Section 3.3 (Attach/Remove the device under test).

### 1.3.3 **4** Pneumatic pressure release valve



This is a needle point valve that lets you release the pressure or vacuum, or seal the system. You can also use it to control a change in pressure conditions; for example, to go to or through another test pressure.



Open



Close

**Note:** To release all the pressure in the system, you must open the refill valve (Section 1.3.4) one turn and then open the pressure release valve one turn.

### 1.3.4 **5** Pneumatic refill valve



When the refill valve is open, you have full control to increase or decrease the pressure/vacuum with the volume adjuster (Section 1.3.5).

If you increase pressure and the volume adjuster gets to the limit of travel, close the refill valve. This seals off all the pressure in the test port and the pressure module connection. You can then use the pump and volume adjuster to refill the pressure mechanism (Section 1.3.5).



Open (1 turn): Full control



Close: Refill

**Note:** To release all the pressure in the system, you must open the refill valve one turn and then open the pressure release valve (Section 1.3.3) one turn.

### 1.3.5 **9** Volume adjuster wheel



The refill valve (Section 1.3.4) sets the operation of the Volume adjuster wheel: Full control or refill

**Full control** When the refill valve is open, you have full control to increase or decrease the pressure/vacuum. Before you seal the system (Section 1.3.3), turn the wheel to the necessary position:

- for equal adjustment, turn it to the middle of its range
- for maximum adjustment, turn it fully clockwise or counterclockwise



When you have set the applicable pressure or vacuum with the pump (Section 1.3.7), use the volume adjuster.

At higher pressures, it is easier to turn the wheel if you fold in the handle:

1. Pull the handle out from the recess that locks it in position.
2. Fold the handle back against the wheel.

**Refill** If you increase pressure and the volume adjuster gets to the limit of travel, close the refill valve (Section 1.3.4). You can then use the pump and volume adjuster to refill the pressure mechanism:

1. Close the refill valve and wind the volume adjuster fully counterclockwise. There is no change in pressure to the device under test or the PM 620 module (if applicable).
2. Refill the pressure mechanism with the pump ( $\approx 15$  cycles) and wind the volume adjuster clockwise until the pressure starts to increase.
3. Open the refill valve to get full control again.



### 1.3.6 11 Selector (pressure/vacuum)



**Caution:** Before you turn the pressure/vacuum selector to + or -, release all the pressure. Sudden high pressure in the pump mechanism can cause damage.

This control sets the operation of the instrument (pressure or vacuum). To prevent a pressure leak, turn it fully clockwise or counterclockwise.

+ : Pressure      - : Vacuum

### 1.3.7 12 Pump (pressure/vacuum)



When you have set the operation to pressure or vacuum (Section 1.3.6), seal the system (Section 1.3.3) and use the pump to set an applicable pressure or vacuum:

You can then make the last adjustments with the volume adjuster (Section 1.3.5).

## 1.4 PV 623 models



1.	Optional accessory: Pressure connection for a pressure relief valve (PRV); see Section 1.4.1. A blanking plug is standard.
2.	Test port: Pressure connection (G1/8 or 1/8NPT) to attach the device under test; see Section 1.4.2.
3.	Pressure and electrical connections for a PM 620 module. PV 623 models only: The pressure connection seals itself.
4.	Hydraulic pressure release valve to release pressure in the system. It also gives access to the hydraulic fluid reservoir; see Section 1.4.3.
6.	Moulded compartment for the DPI 620 calibrator with electrical connections and a mechanism to hold it in position.
7.	Push-button mechanism to release the DPI 620 calibrator.
9.	Volume adjuster wheel with fold-in handle; see Section 1.4.5.
10.	Hydraulic refill valve. Close it to seal off all the pressure and refill the pressure mechanism with fluid; see Section 1.4.4.
13.	Carrying strap with a carry handle and a shoulder strap.

Items 5, 8, 11, 12: Not applicable

Figure 1-3: General views

### 1.4.1 Pressure relief valve (PRV)



To give your attached devices overpressure protection (device under test, PM 620 module), we recommend you use one of our range of optional hydraulic PRVs; see Section 1.5 (Accessories).

To attach or adjust a PRV, see Section 4.5.

## 1.4.2 Test port



To attach the device under test, the test port uses “Quick fit” pressure adaptors; see Section 1.5 (Accessories). These are easy to remove, change and install; see Section 4.4 (Attach/Remove the device under test).

## 1.4.3 Hydraulic pressure release valve/reservoir access



This valve lets you release the pressure or seal the system.



Open



Close

**Note:** To release all the pressure in the system, you must open the refill valve (Section 1.4.4) one turn and then open the pressure release valve one turn.

If you remove the valve (counterclockwise), you can also do these operations:

- add hydraulic fluid to the reservoir; see Section 4.2
- drain all the hydraulic fluid from the instrument; see Section 4.7

## 1.4.4 Hydraulic refill valve



When the refill valve is open, you have full control to increase or decrease the pressure with the volume adjuster (Section 1.4.5).

If you increase pressure and the volume adjuster gets to the limit of travel, close the refill valve. This seals off all the pressure in the test port and the pressure module connection. You can then use the volume adjuster to refill the pressure mechanism (Section 1.4.5).



Open (1 turn): Full control



Close: Refill

**Note:** To release all the pressure in the system, you must open the refill valve one turn and then open the pressure release valve (Section 1.4.3) one turn.

1.4.5 **9** *Volume adjuster wheel*



The refill valve (Section 1.4.4) sets the operation of the Volume adjuster wheel: Full control or refill

**Full control** When the refill valve is open, you have full control to increase or decrease the pressure.

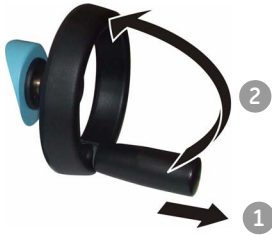

At higher pressures, it is easier to turn the wheel if you fold in the handle:

1. Pull the handle out from the recess that locks it in position.
2. Fold the handle back against the wheel.

**Refill** If you increase pressure and the volume adjuster gets to the limit of travel, close the refill valve (Section 1.4.4). You can then use the volume adjuster to refill the pressure mechanism:

1. Close the refill valve and then wind the volume adjuster fully counterclockwise and clockwise until the pressure starts to increase.

The counterclockwise operation refills the pressure mechanism without a change in pressure to the device under test or the PM 620 module (if applicable).

2. Open the refill valve to get full control again.



## 1.5 Accessories

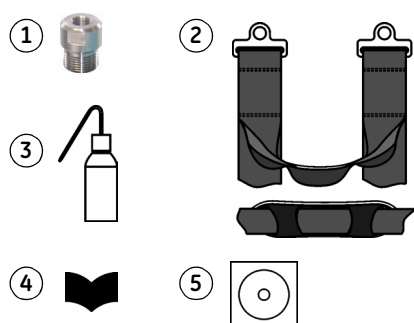

**Figure 1-4:** Accessories included

1.	“Quick fit” pressure adaptors (G1/8 and 1/8NPT); easy to remove, change and install
2.	Carrying strap with a shoulder strap and a carry handle
3.	PV 623 models only: Refill bottle for hydraulic fluid
4.	Safety and quick reference guide
5.	CD with the user manual

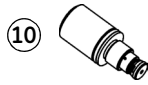

**Figure 1-5:** Optional accessories for the PV 62x pressure stations

6.	P/N IO620-CASE-3. Fabric carry case with a shoulder strap and a large pocket for accessories. It can hold one PV 62x pressure station; one DPI 620 calibrator; one PM 620 module.
7.	P/N IO620-CASE-4. Rigid trolley case to hold a set of units: one DPI 620 calibrator; two PV 62x pressure stations; MC 620 module carrier; all the related accessories.  The case includes: an extendable handle; 7 double-step latches that lock the lid down onto a neoprene o-ring; an automatic pressure equalisation valve.
8.	Pressure modules (PM 620); refer to Chapter 7 (Specification)
9.	Pneumatic PRVs to give attached devices overpressure protection; see Table 1-1

**Table 1-1:** Recommended PRVs (Pneumatic)

PRV P/N	Recommended for:	Factory setting		Adjustable range	
		Bar	PSI	Bar	PSI
IO620-PRV-P1	PV 621, PV 622	1	15	0.4 to 1	6 to 15
IO620-PRV-P2		7	100	3 to 7	45 to 100
IO620-PRV-P3		30	435	15 to 30	220 to 435
IO620-PRV-P4	PV 622 only	60	870	30 to 60	435 to 870
IO620-PRV-P5		100	1500	50 to 100	725 to 1500



- 10. Hydraulic PRVs to give attached devices overpressure protection; see Table 1-2.

**Table 1-2: Recommended PRVs (Hydraulic)**

PRV P/N	Recommended for:	Factory setting		Adjustable range	
		Bar	PSI	Bar	PSI
IO620-PRV-H1	PV 623 only	50	725	10 to 50	145 to 725
IO620-PRV-H2		200	3000	50 to 200	725 to 2900
IO620-PRV-H3		400	6000	200 to 400	2900 to 5800
IO620-PRV-H4		700	10000	300 to 700	4350 to 10000
IO620-PRV-H5		1000	15000	600 to 1000	8700 to 15000

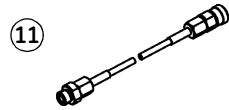

- 11. Pneumatic hose kit rated to 400 bar (5800 psi) with “Quick fit” connectors for the test port.  
P/N IO620-HOSE-P1: 1 metre (≈ 39”)  
P/N IO620-HOSE-P2: 2 metre (≈ 78”)



- 12. Hydraulic hose kit rated to 1000 bar (15000 psi) with “Quick fit” connectors for the test port.  
P/N IO620-HOSE-H1: 1 metre (≈ 39”)  
P/N IO620-HOSE-H2: 2 metre (≈ 78”)



- 13. Pressure adaptor sets:  
P/N IO620-BSP: G1/8, G1/4 male; G1/4, G3/8 and G½ female  
P/N IO620-NPT: 1/8NPT, ¼NPT male, ¼NPT, 3/8NPT, and ½NPT female  
P/N IO620-MET: M14 x 1.5 and M20 x 1.5 female



- 14. P/N IO620-BLANK. Blanking plug to seal the pressure port for the PM 620 module.

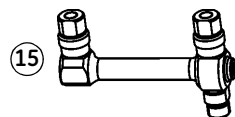

- 15. P/N IO620-COMP. Comparator. Attach it to the test port and then use it to compare the device under test with a reference device.

**Figure 1-5: Optional accessories for the PV 62x pressure stations (Continued)**



# Chapter 2: ❖ Pneumatic pressure operation (PV 621)

---

## 2.1 Introduction



Chapter 1 gives a description of the different parts of the instrument: ❖ 1 to ❖ 13

This chapter gives examples of how to connect and use the PV 621 pressure station to give the necessary pressure or vacuum conditions.

Before you start:

- Read and understand the “Safety” section.
- Make sure that there is no damage to the instrument, and that there are no missing items.

**Note:** Use only original parts supplied by the manufacturer.

---

## 2.2 Release the pressure



To release all the pressure in this instrument, open the pressure release valve counterclockwise (1 turn).

To control a change in pressure conditions (for example, to go to or through another test pressure) use the volume adjuster (Section 1.2.4) or open and close the pressure release valve.

---

## 2.3 Attach/Remove the device under test



**WARNING: Pressurized gases and fluids are dangerous. Before you attach or disconnect pressure equipment, safely release all the pressure.**

**Caution: To prevent damage to the instrument, do not let dirt get into the pressure mechanism. Before you attach equipment, make sure it is clean.**

The test port uses “Quick fit” pressure adaptors; see Section 1.5 (Accessories). These are easy to remove, change and install (Section 2.3.1).

### 2.3.1 Procedure (to attach)

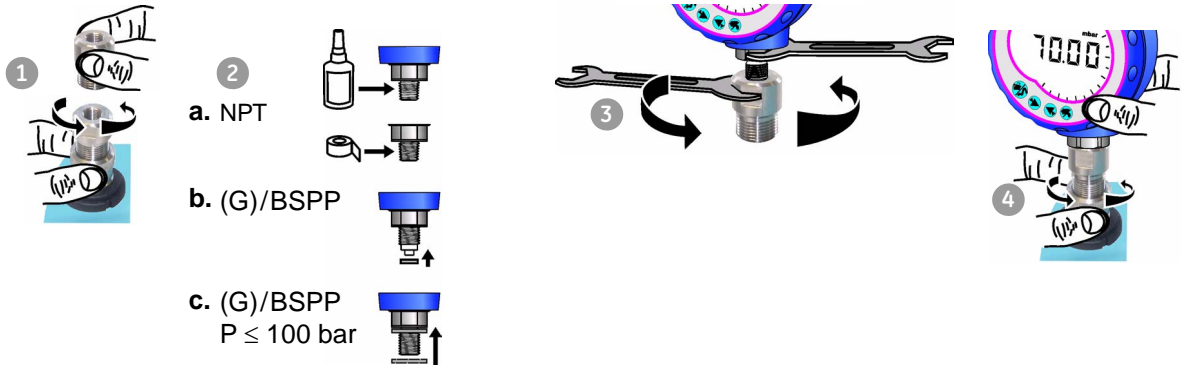

Step	Procedure
1.	Remove the adaptor
2.	Use an applicable seal for the pressure connection: <b>a.</b> NPT type: Use an applicable sealant on the thread. <b>b.</b> BSP (parallel) type: We recommend a bonded seal at the bottom. <b>c.</b> BSP (parallel) type, 100 bar (1500 psi) or less: a bonded seal at the top is permitted.

Step	Procedure
3.	Attach the adaptor to the device; if necessary use one of the alternative adaptors in Section 1.5 (Accessories), then tighten to the applicable torque.
4.	Re-attach the adaptor to the test port and tighten it until it is hand tight only.

### 2.3.2 Procedure (to remove)

To remove a device, release the pressure first (Section 2.2). You can then do steps 4, 3, and 1 in Section 2.3.1 but do the operations in the opposite direction.

## 2.4 Attach/Adjust a PRV

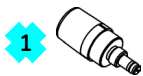

**WARNING: Pressurized gases and fluids are dangerous. Before you attach or disconnect pressure equipment, safely release all the pressure.**

*Optional accessory; see Section 1.5 (Accessories).* Use a pneumatic pressure relief valve (PRV) to set a limit to the pressure you can apply to the pressure devices attached to the pressure station. The PRV is set at the factory to operate at the maximum pressure specified on the label.

If the pressure in the instrument is more than the relief pressure set for the PRV, the PRV controls a slow release of the unwanted pressure. The correct PRV helps prevent overpressure and damage to the attached devices.

To adjust the PRV, see Section 2.4.2.

### 2.4.1 Procedure (to attach)

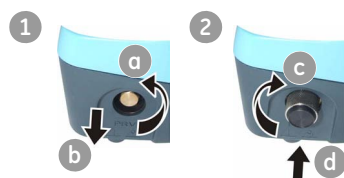

- Steps (a) and (b): Remove the blanking plug or, if applicable, the PRV you are using.

**Note:** Before you put it into storage, make sure it is clean and dry.

- Steps (c) and (d): Choose a clean, dry PRV with the correct pressure value for the devices you are using and tighten it into position (hand tight only).

### 2.4.2 Procedure (to adjust)

**Note:** We only guarantee the pressure setting on the product set at our factory.

The PRV is set at the factory to operate at the maximum pressure specified on the label (on the plastic cap). For the adjustable range, refer to Table 1-1.

If necessary, use these steps to adjust the relief pressure:

- Attach an applicable pressure indicator to the test port (Section 2.3) or use a DPI 620 calibrator with a PM 620 module (Chapter 5).
- Remove the plastic cap from the end of the PRV.
- Loosen the locknut counterclockwise.
- Set the necessary pressure with the pressure station (see Section 2.5.2).
- When the pressure in the pressure station is at the new PRV pressure, turn the adjustment screw until the PRV operates:
  - counterclockwise* decreases the operating pressure
  - clockwise* increases the operating pressure
- Do steps 4 and 5 until the PRV operates at the correct pressure. Then tighten the locknut and press the plastic cap back into position.

## 2.5 Vacuum or pressure operation

After you correctly attach an applicable device to the test port (Section 2.3), use these steps to set the necessary vacuum or pressure. If applicable, attach the correct PRV (Section 2.4).

### 2.5.1 Vacuum procedure



Step	Procedure (Vacuum)	
1.	Set the pressure/vacuum selector to vacuum (-); fully counterclockwise.	11
2.	To do equal adjustments (up or down) at the end of the procedure, turn the volume adjuster to the middle of its range of operation. To get the maximum vacuum, turn the volume adjuster fully clockwise.	8
3.	Seal the system.	4
4.	Use the pump to set the maximum vacuum or set the vacuum you want to adjust.	12
5.	Adjust the vacuum: + decrease; - increase.	8

### 2.5.2 Pressure procedure



Step	Procedure (Pressure)	
1.	Set the pressure/vacuum selector to pressure (+); fully clockwise.	11
2.	To do equal adjustments (up or down) at the end of the procedure, turn the volume adjuster to the middle of its range of operation.	8
3.	Seal the system.	4
4.	Use the pump to set the approximate pressure.	12
5.	Adjust the pressure: + decrease; - increase.	8

# Chapter 3: ● Pneumatic pressure operation (PV 622)

## 3.1 Introduction



Chapter 1 gives a description of the different parts of the instrument: ● 1 to ● 13

This chapter gives examples of how to connect and use the PV 622 pressure station to give the necessary pressure or vacuum conditions.

Before you start:

- Read and understand the “Safety” section.
- Make sure that there is no damage to the instrument, and that there are no missing items.

**Note:** Use only original parts supplied by the manufacturer.

## 3.2 Release the pressure



To release all the pressure in this instrument:

Step	Procedure
1.	Open the refill valve counterclockwise (1 turn). ● 5
2.	Open the pressure release valve counterclockwise (1 turn). ● 4

To control a change in pressure conditions (for example, to go to or through another test pressure) use the volume adjuster wheel (Section 1.3.5) or open and close the pressure release valve.

## 3.3 Attach/Remove the device under test



**WARNING:** Pressurized gases and fluids are dangerous. Before you attach or disconnect pressure equipment, safely release all the pressure.

**Caution:** To prevent damage to the instrument, do not let dirt get into the pressure mechanism. Before you attach equipment, make sure it is clean.

The test port uses “Quick fit” pressure adaptors; see Section 1.5 (Accessories). These are easy to remove, change and install (Section 3.3.1).

### 3.3.1 Procedure (to attach)

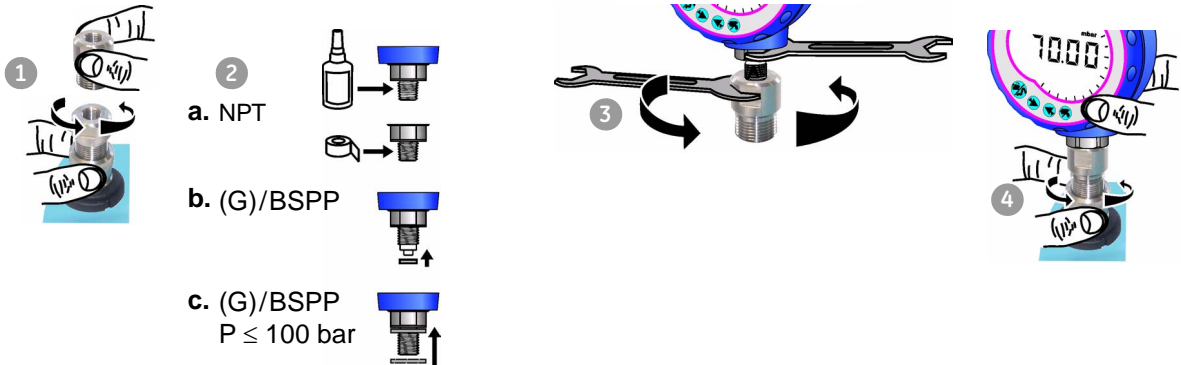

Step	Procedure
1.	Remove the adaptor
2.	Use an applicable seal for the pressure connection: <b>a.</b> NPT type: Use an applicable sealant on the thread. <b>b.</b> BSP (parallel) type: We recommend a bonded seal at the bottom. <b>c.</b> BSP (parallel) type, 100 bar (1500 psi) or less: a bonded seal at the top is permitted.

Step	Procedure
3.	Attach the adaptor to the device; if necessary use one of the alternative adaptors in Section 1.5 (Accessories), then tighten to the applicable torque.
4.	Re-attach the adaptor to the test port and tighten it until it is hand tight only.

### 3.3.2 Procedure (to remove)

To remove a device, release the pressure first (Section 3.2). You can then do steps 4, 3, and 1 in Section 3.3.1 but do the operations in the opposite direction.

### 3.4 Attach/Adjust a PRV



**WARNING: Pressurized gases and fluids are dangerous. Before you attach or disconnect pressure equipment, safely release all the pressure.**

*Optional accessory; see Section 1.5 (Accessories).* Use a pneumatic pressure relief valve (PRV) to set a limit to the pressure you can apply to the pressure devices attached to the pressure station. The PRV is set at the factory to operate at the maximum pressure specified on the label.

If the pressure in the instrument is more than the relief pressure set for the PRV, the PRV controls a slow release of the unwanted pressure. The correct PRV helps prevent overpressure and damage to the attached devices.

To adjust the PRV, see Section 3.4.2.

### 3.4.1 Procedure (to attach)

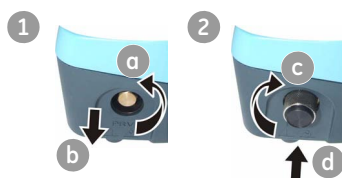

- Steps (a) and (b): Remove the blanking plug or, if applicable, the PRV you are using.

**Note:** Before you put it into storage, make sure it is clean and dry.

- Steps (c) and (d): Choose a clean, dry PRV with the correct pressure value for the devices you are using and tighten it into position (hand tight only).

### 3.4.2 Procedure (to adjust)

**Note:** We only guarantee the pressure setting on the product set at our factory.

The PRV is set at the factory to operate at the maximum pressure specified on the label (on the plastic cap). For the adjustable range, refer to Table 1-1.

If necessary, use these steps to adjust the relief pressure:

- Attach an applicable pressure indicator to the test port (Section 3.3) or use a DPI 620 calibrator with a PM 620 module (Chapter 5).
- Remove the plastic cap from the end of the PRV.
- Loosen the locknut counterclockwise.
- Set the necessary pressure with the pressure station (see Section 3.5.2).
- When the pressure in the pressure station is at the new PRV pressure, turn the adjustment screw until the PRV operates:
  - counterclockwise* decreases the operating pressure
  - clockwise* increases the operating pressure
- Do steps 4 and 5 until the PRV operates at the correct pressure. Then tighten the locknut and press the plastic cap back into position.

## 3.5 Vacuum or pressure operation

After you correctly attach an applicable device to the test port (Section 3.3), use these steps to set the necessary vacuum or pressure. If applicable, attach the correct PRV (Section 3.4).

### 3.5.1 Vacuum procedure



Step	Procedure (Vacuum)	
1.	Set the pressure/vacuum selector to vacuum (-); fully counterclockwise.	11
2.	Open the refill valve (1 turn).	5
3.	To do equal adjustments (up or down) at the end of the procedure, turn the volume adjuster wheel to the middle of its range of operation.  To get the maximum vacuum, turn the volume adjuster wheel fully clockwise.	9
4.	Seal the system.	4
5.	Use the pump to set the maximum vacuum or set the vacuum you want to adjust.	12
6.	Adjust the vacuum: + decrease; - increase.	9

### 3.5.2 Pressure procedure



Step	Procedure (Pressure)	
1.	Set the pressure/vacuum selector to pressure (+); fully clockwise.	11
2.	To do equal adjustments (up or down) at the end of the procedure, turn the volume adjuster wheel to the middle of its range of operation.	9
3.	Seal the system.	4
4.	Use the pump to set a pressure up to $\approx 20$ bar (300 psi).	12
5.	Open the refill valve (1 turn). You now have full control to increase (+) or decrease (-) the pressure with the volume adjuster.  <b>Note:</b> At higher pressures, it is easier to turn the wheel if you fold in the handle; see Section 1.3.5.	5 9
6.	If you increase pressure and get to the limit of travel, close the refill valve and wind the volume adjuster fully counterclockwise.  There is no change in pressure to the device under test or the PM 620 module (if applicable).	5 9
7.	Refill the pressure mechanism with the pump ( $\approx 15$ cycles) and wind the volume adjuster clockwise until the pressure starts to increase.  Continue this sequence (clockwise/counterclockwise operation and then pump) until you get the necessary pressure <b>OR</b> for full control, go back to step 5.	12 9



# Chapter 4: ♦ Hydraulic pressure operation (PV 623)

## 4.1 Introduction



Chapter 1 gives a description of the different parts of the instrument: ♦ 1 to ♦ 13

This chapter gives examples of how to connect and use the PV 623 pressure station to give the necessary hydraulic pressure conditions.

Before you start:

- Read and understand the “Safety” section.
- Make sure that there is no damage to the instrument, and that there are no missing items.

**Note:** Use only original parts supplied by the manufacturer.

## 4.2 Fill the reservoir

**Caution:** Ice in the pressure mechanism can cause damage. If the temperature is less than 4°C (39°F), drain all water from the instrument.

The first time you want to use the hydraulic pressure station, use this procedure to fill the reservoir:

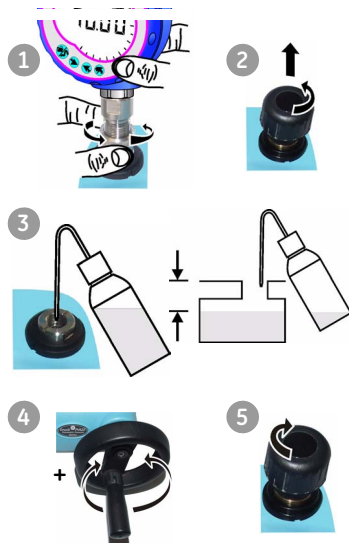

Step	Procedure	
1.	Use the applicable adaptor to attach the device (Section 4.4).	♦ 2
2.	Remove the hydraulic pressure release valve.	♦ 4
3.	Use the refill bottle to add the necessary hydraulic fluid* but leave a small air gap.	♦ 4
4.	To remove air from the pressure mechanism, wind the volume adjuster through one full cycle (counterclockwise then clockwise).	♦ 9
5.	Seal the system and continue with the normal pressure operation; see Section 4.6.	♦ 4

\* Refer to Chapter 7 (Specification)

After a period of operation, if it is necessary to add more fluid to the reservoir, use this procedure again.

To add more fluid during a pressure procedure, refer to Section 4.6.2.

To drain the hydraulic fluid, refer to Section 4.7.

### 4.3 Release the pressure



To release all the pressure in this instrument:

Step	Procedure	
1.	Open the refill valve counterclockwise (1 turn).	10
2.	Open the pressure release valve counterclockwise (1 turn).	4

To control a change in pressure conditions (for example, to go to or through another test pressure) use the volume adjuster wheel (Section 1.4.5).

### 4.4 Attach/Remove the device under test



**WARNING: Pressurized gases and fluids are dangerous. Before you attach or disconnect pressure equipment, safely release all the pressure.**

**Caution: To prevent damage to the instrument, do not let dirt get into the pressure mechanism. Before you attach equipment, make sure it is clean.**

The test port uses “Quick fit” pressure adaptors; see Section 1.5 (Accessories). These are easy to remove, change and install.

#### 4.4.1 Procedure (to attach)

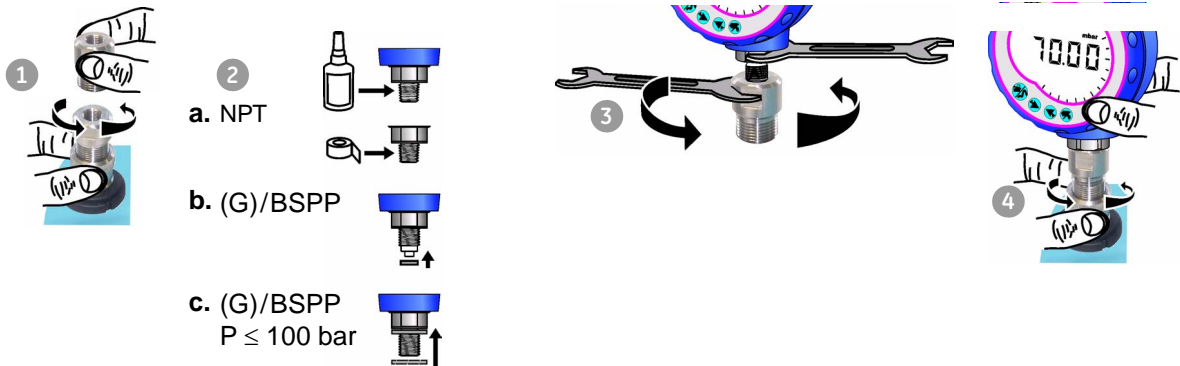

Step	Procedure
1.	Remove the adaptor
2.	Use an applicable seal for the pressure connection: <ul style="list-style-type: none"> <li>a. NPT type: Use an applicable sealant on the thread.</li> <li>b. BSP (parallel) type: We recommend a bonded seal at the bottom.</li> <li>c. BSP (parallel) type, 100 bar (1500 psi) or less: a bonded seal at the top is permitted.</li> </ul>

Step	Procedure
3.	Attach the adaptor to the device; if necessary use one of the alternative adaptors in Section 1.5 (Accessories), then tighten to the applicable torque.
4.	Re-attach the adaptor to the test port and tighten it until it is hand tight only.

#### 4.4.2 Procedure (to remove)

To remove a device, release the pressure first (Section 4.3).

You can then do steps 4, 3, and 1 in Section 4.4.1 but do the operations in the opposite direction.

### 4.5 Attach/Adjust a PRV

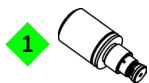

**WARNING: Pressurized gases and fluids are dangerous. Before you attach or disconnect pressure equipment, safely release all the pressure.**

**Caution: In its normal condition, the PV 623 model contains hydraulic fluid. To make sure it does not spill out, seal the system and put it on its side before you install a PRV.**

*Optional accessory; see Section 1.5 (Accessories).* Use a hydraulic pressure relief valve (PRV) to set a limit to the pressure you can apply to the pressure devices attached to the pressure station. The PRV is set at the factory to operate at the maximum pressure specified on the label.

If the pressure in the instrument is more than the relief pressure set for the PRV, the PRV controls a slow release of the unwanted pressure. The correct PRV helps prevent overpressure and damage to the attached devices.

To adjust the PRV, see Section 4.5.2.

#### 4.5.1 Procedure (to attach)



1. Seal the system.
2. Put the instrument on its side.
3. Steps (a) and (b): Remove the blanking plug or, if applicable, the PRV you are using. To collect possible drops of hydraulic fluid, put it in a container.

**Note:** Before you put it into storage, make sure it is clean and dry.

4. Steps (c) and (d): Choose a clean, dry PRV with the correct pressure value for the devices you are using and tighten it into position (hand tight only).

#### 4.5.2 Procedure (to adjust)

**Note:** We only guarantee the pressure setting on the product set at our factory.

The PRV is set at the factory to operate at the maximum pressure specified on the label (on the plastic cap). For the adjustable range, refer to Table 1-2.

If necessary, use these steps to adjust the relief pressure:

1. Attach an applicable pressure indicator to the test port (Section 4.4) or use a DPI 620 calibrator with a PM 620 module (Chapter 5).

2. Remove the plastic cap from the end of the PRV.
3. Set the necessary pressure with the pressure station (see Section 4.6.1).
4. When the pressure in the pressure station is at the new PRV pressure, turn the adjustment screw until the PRV operates:  
*counterclockwise* decreases the operating pressure  
*clockwise* increases the operating pressure
5. Do steps 3 and 4 until the PRV operates at the correct pressure. Then press the plastic cap back into position.

## 4.6 Pressure operation

After you correctly attach an applicable device to the test port (Section 4.4), use these steps to set the necessary pressure. If applicable, attach the correct PRV (Section 4.5).

**Note:** To operate correctly, make sure the reservoir contains the correct amount of hydraulic fluid; see Section 4.2.

During the procedure, you can add more hydraulic fluid; see Section 4.6.2. When the procedure is complete, you can then drain this fluid back out of the device; see Section 4.6.3.

### 4.6.1 Hydraulic pressure procedure



Step	Procedure	
1.	Seal the system.	4
2.	Close the refill valve and then wind the volume adjuster fully clockwise and counterclockwise until the pressure starts to increase.  Continue the clockwise/counterclockwise sequence until you get the necessary pressure <b>OR</b> for full control, go to step 3.  The counterclockwise operation refills the pressure mechanism but there is no change in pressure to the device under test or the PM 620 module (if applicable).  <b>Note:</b> At higher pressures, it is easier to turn the wheel if you fold in the handle; see Section 1.4.5.	10 9
3.	For full control, open the refill valve (1 turn). You can now increase (+) or decrease (-) the pressure with the volume adjuster.	10 9
4.	If you increase pressure and get to the limit of travel, close the refill valve again and wind the volume adjuster fully counterclockwise.	10 9
5.	Continue to do steps 2 to 4 until you get the necessary pressure.	

## 4.6.2 Add more hydraulic fluid

If the device under test has a large fluid capacity, you can add hydraulic fluid during the pressure procedure.

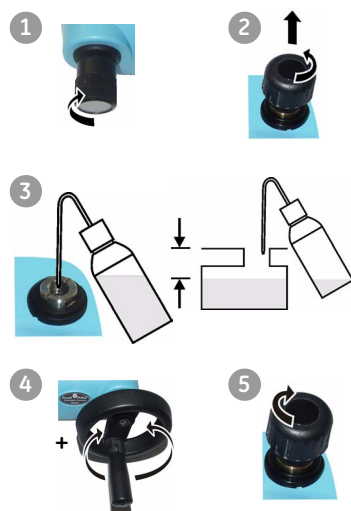

Step	Procedure	
1.	To seal off all the pressure in the test port and the pressure module connection, close the refill valve.	10
2.	Remove the hydraulic pressure release valve.	4
3.	Use the refill bottle to add the necessary hydraulic fluid* but leave a small air gap. <b>Note:</b> To prevent contamination use only one type of hydraulic fluid in the instrument.	4
4.	To remove air from the pressure mechanism, wind the volume adjuster through one full cycle (counterclockwise then clockwise).	9
5.	Seal the system and continue with the normal pressure procedure; see Section 4.6.1.	4

\* Refer to Chapter 7 (Specification)

## 4.6.3 Drain hydraulic fluid from the device under test

If you add more hydraulic fluid during the pressure procedure, drain this fluid out of the device when the pressure procedure is complete.

**Note:** If it is safe and there is no risk of contamination, you can leave the hydraulic fluid inside the device.

**Preparation** To drain the device, we recommend these items:

- the applicable skin and eye protection
- a container that is large enough to hold the hydraulic fluid and prevent contamination of the work surface
- applicable materials to make sure the instrument and the area stay clean; see Chapter 6 (Maintenance procedures)

- Procedure**
1. Release the pressure (Section 4.3).
  2. Remove the device (Section 4.4) but do not let fluid spill onto the PV 62x instrument.
  3. If necessary, drain the hydraulic fluid from the device under test.

**Note:** To discard the hydraulic fluid, obey all the local health and safety procedures.

## 4.7 Drain all the hydraulic fluid

In some conditions, it is necessary to fully drain the hydraulic fluid from your PV 62x pressure station; for example:

- if you are using water and the storage or operating temperature is going to be less than 4°C (39°F)
- if there is a long period of storage
- if there is unwanted material in the hydraulic fluid

### 4.7.1 Preparation

To drain the instrument, we recommend these items:

- the applicable skin and eye protection
- a container that is large enough to hold the hydraulic fluid and prevent contamination of the work surface
- applicable materials to make sure the instrument and the area stay clean; see Chapter 6 (Maintenance procedures)

### 4.7.2 Procedure

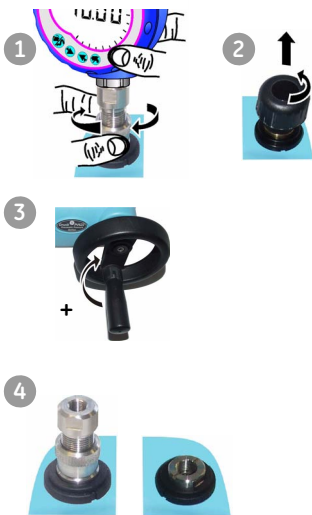

Step	Procedure (Drain all the fluid)
1.	If applicable, release the pressure (Section 4.3) and remove the device (Section 4.4). <b>Note:</b> If it is attached, we also recommend you remove the DPI 620 calibrator; see Chapter 5 (Pressure calibrator operation (DPI 620)).
2.	Remove the hydraulic pressure release valve.
3.	Wind the volume adjuster wheel fully clockwise; this moves the fluid out of the pressure mechanism.
4.	Put a container below the instrument then tilt the instrument up until <b>all</b> the fluid has come out. To discard the hydraulic fluid, obey all the local health and safety procedures. <b>Note:</b> Fluid comes out of the test port and the connection for the pressure release valve.
5.	To flush out fluids that contain unwanted material, refill the system and repeat steps 3 and 4. <b>Note:</b> To prevent contamination use only one type of hydraulic fluid in the instrument.

# Chapter 5: Pressure calibrator operation (DPI 620)

## 5.1 Introduction



This section gives examples of how to connect and use the pressure stations to do pressure calibrations with the DPI 620 calibrator and the applicable pressure modules (PM 620).

Before you start:

- Read and understand the “Safety” section.
- Do not use a damaged instrument.

**Note:** Use only original parts supplied by the manufacturer.

## 5.2 Parts and assembly

To make a fully integrated pressure calibrator instrument, use these items:

- a PV 62x pressure station; see Chapter 1 (Instrument parts, accessories and options)
- a DPI 620 calibrator; see Section 5.2.1
- an applicable PM 620 module for the pressure station; see Section 5.2.2

### 5.2.1 DPI 620 calibrator parts

Refer to the user manual - K0449: Druck DPI 620 Advanced modular calibrator.



1.	On or off button. Press and hold the button down until the power comes on.
2.	Channel 1 (CH1) connectors for electrical measure and source operations; refer to the user manual - K0449
3.	Isolated channel 2 (CH2) connectors for electrical measure and source operations and a 24V loop power supply (24Vo); refer to the user manual - K0449
4.	Rubber pull-down cover for the USB type A connector; USB mini-type B connector and +5V DC power input socket.
5.	Colour display with touch-screen. The number of windows you see on the display is set by the number of task selections and external modules you are working with (maximum: 6). To make a selection, lightly tap on the applicable display area; refer to the user manual - K0449
6.	Sealed speaker unit.

### 5.2.2 PM 620 module parts



**Caution: To prevent damage to the PM 620 module, only use it within the specified pressure limit on the label.**

- |    |   |
|----|---|
| 1. | Pressure module (PM 620) with a pressure connection, reference port (a) and a label. The label includes:<br><i>Pressure range. Example: 20 bar g (g: gauge; a: absolute); serial number (S/N); manufacturer: name, address, website</i> |
|----|---|

**Table 5-1: Recommended pressure modules (PM 620)**

PV 62x model	PM 620 module range
PV 621 models	25 mbar to 20 bar (0.36 to 300 psi)
PV 622 models	25 mbar to 100 bar (0.36 to 1500 psi)
PV 623 models	70 to 1000 bar (1000 to 15000 psi)

### 5.2.3 Assembly instructions



Step	Procedure
1.	Lower the DPI 620 calibrator into the moulded compartment.
2.	Press on the bottom end of the calibrator until it latches in position.
3.	Attach a PM 620 module with the correct range and type.
4.	Tighten it until it is hand tight only.  When this symbol flashes at the top of the display, it shows there is communication between the module and the calibrator.
5.	If applicable, attach one of the optional PRVs; see Chapter 1 (Instrument parts, accessories and options).



## 5.3 Measure pressure/vacuum

When the pressure calibrator assembly is complete (Section 5.2), use the calibrator to measure the pressure or, if applicable, the vacuum in the pressure station; for example: to calibrate a gauge or indicator.

### 5.3.1 Procedure overview

To use the pressure calibrator, complete these procedures:

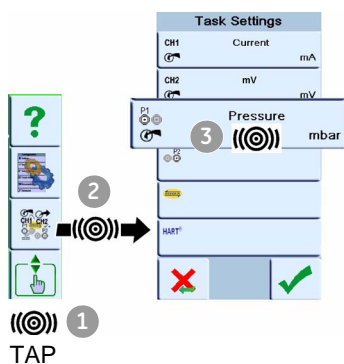

- Set the calibrator functions you want to use on the display:
  - a. Pressure function (P1): item **A** ; see Section 5.3.2
  - b. CH1: Channel 1 electrical function (input or output); refer to the user manual - K0449
  - c. CH2: Channel 2 electrical function (input or output); refer to the user manual - K0449
  - d. other functions (maximum: 6 functions); refer to the user manual - K0449

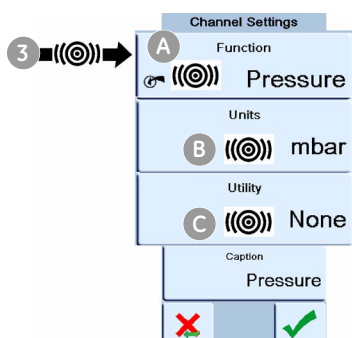

- If necessary, change the *Units* for the function: item **B** ; see Section 5.3.3
- If necessary, set a *Utility* for the function: item **C**
  - a. *Max/Min/Avg*; refer to the user manual - K0449
  - b. *Switch Test*; refer to the user manual - K0449
  - c. *Leak Test*; see Section 5.3.4

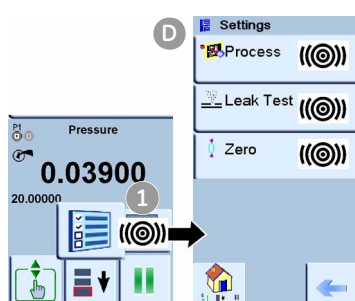

- If necessary, change the *Settings* for the pressure function: item **D**
  - a. *Process (Tare, Alarm, Filter, Flow, Scaling)*; refer to the user manual - K0449
  - b. *Leak Test (Only when the Utility is set)*; see Section 5.3.4
  - c. *Zero*; see Section 5.3.5

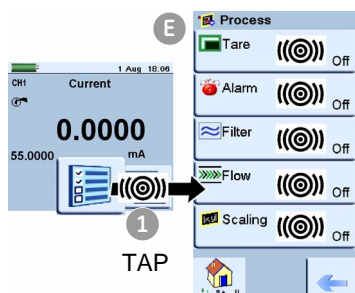

- If necessary, change the *Process* for the CH1 and/or CH2 input functions: item **E**
- This includes: *Tare, Alarm, Filter, Flow, Scaling*; refer to the user manual - K0449

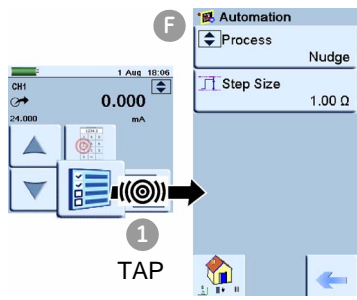

- If necessary, change the *Automation* options for the CH1 and/or CH2 output functions: item **F**

This includes: *Nudge*, *Span Check*, *Percent Step*, *Defined Step*, *Ramp*; refer to the user manual - K0449

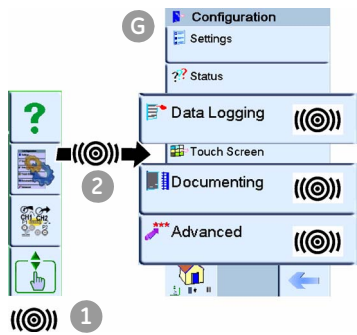

- If necessary, change the *Configuration*: item **G**  
This includes: *Data Logging*, *Documenting*, and *Advanced* options; refer to the user manual - K0449

- When all the software selections are complete, make the applicable pressure and electrical connections. Examples: Gauge/indicator calibration (Section 5.3.6); Transmitter calibration (Section 5.3.7); Switch test (Section 5.3.8)

### 5.3.2 DPI 620 calibrator: Set the pressure function

This example shows the sequence to set the pressure function. It is a similar procedure for other functions; refer to the user manual - K0449.

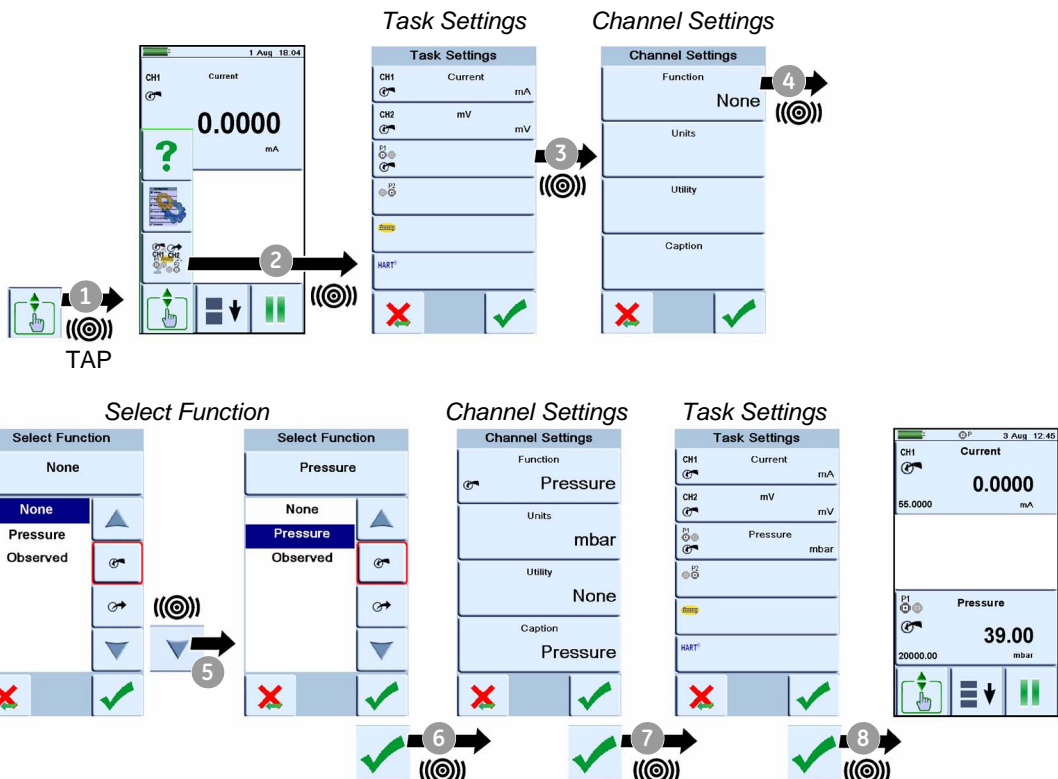

### 5.3.3 DPI 620 calibrator: Set the pressure units

This example shows the sequence to set the pressure units. It is a similar procedure for other units.

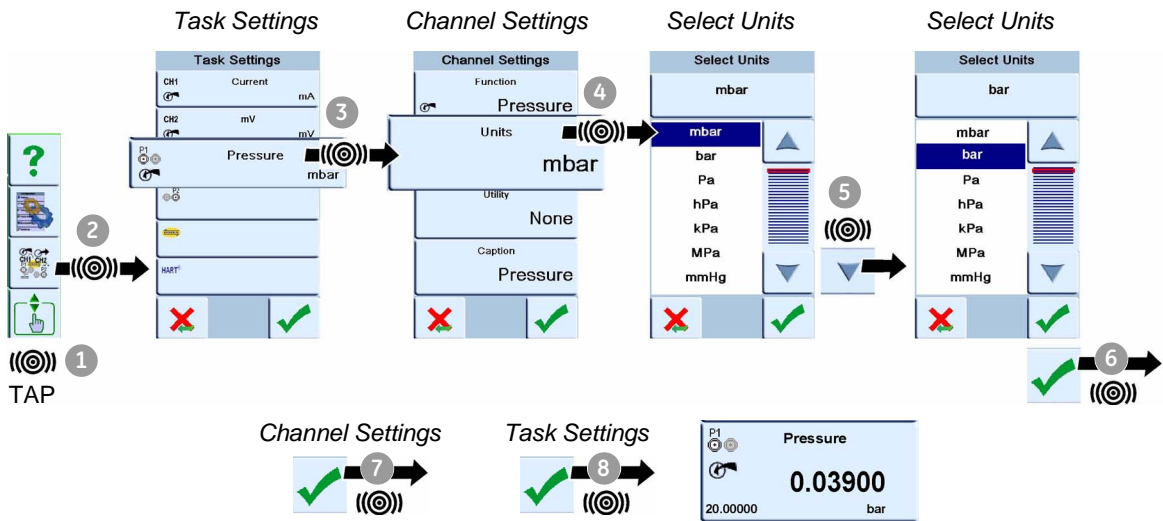

### 5.3.4 DPI 620 calibrator: Set up a Leak Test

To do a leak test, set the *Utility* to *Leak Test* and then set the *Leak Test* options in *Settings*:

(1) Set the Utility

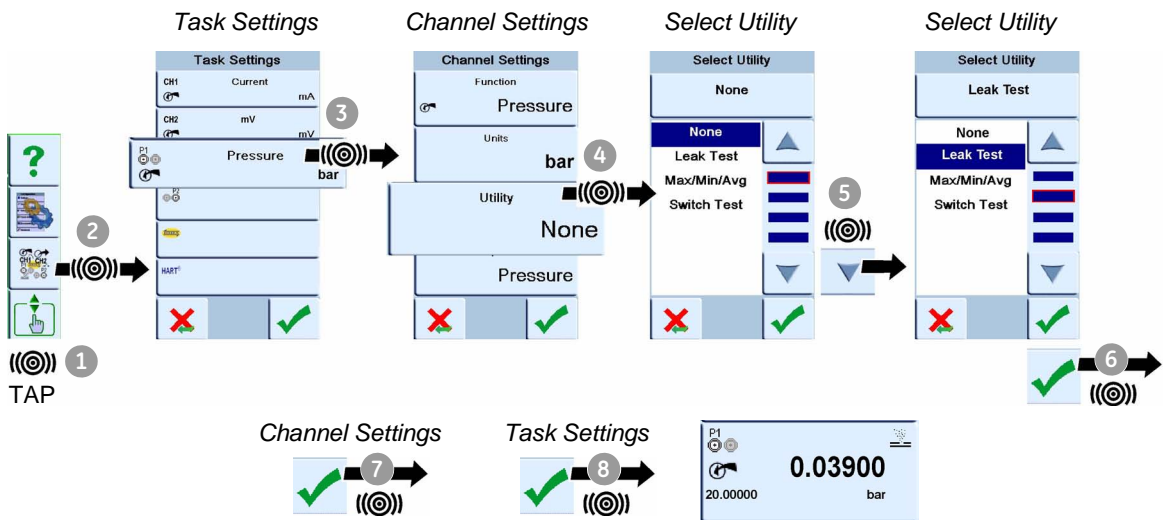

(2) *Set the Leak Test options* When you have set the *Utility* to *Leak Test*, you can set these options:

**Wait Time:** The time before the test starts in hours:minutes:seconds (hh:mm:ss)

**Test Time:** The period of the leak test in hours:minutes:seconds (hh:mm:ss)

**Note:** To set the Leak Test options, you must have a PM 620 module correctly installed (Section 5.2.3).

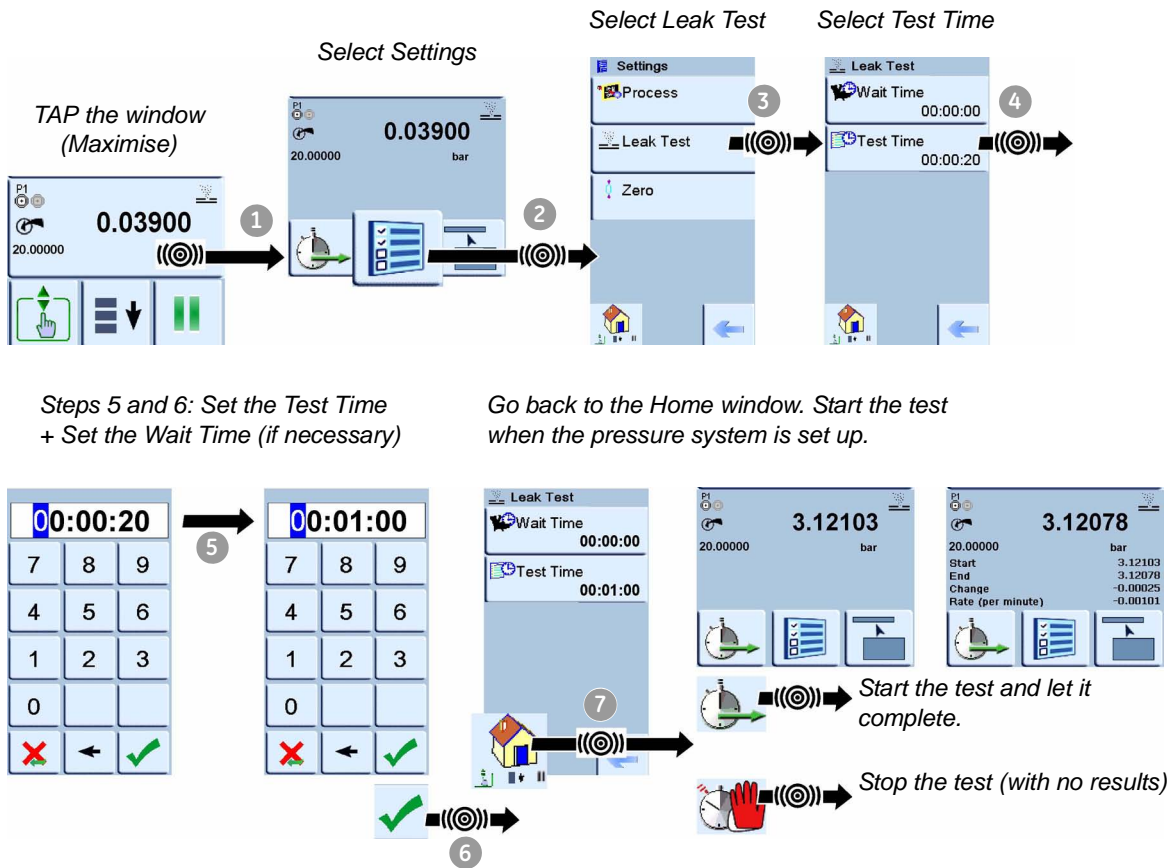

### 5.3.5 DPI 620 calibrator: Set the PM 620 module to zero

Use this option to write a new zero pressure value to the PM 620 module you are using. This option only affects gauge type modules.

**Note:** To make a temporary adjustment for zero, you can use the *Tare* function: *Select Settings > Process > Tare* (refer to the user manual - K0449).

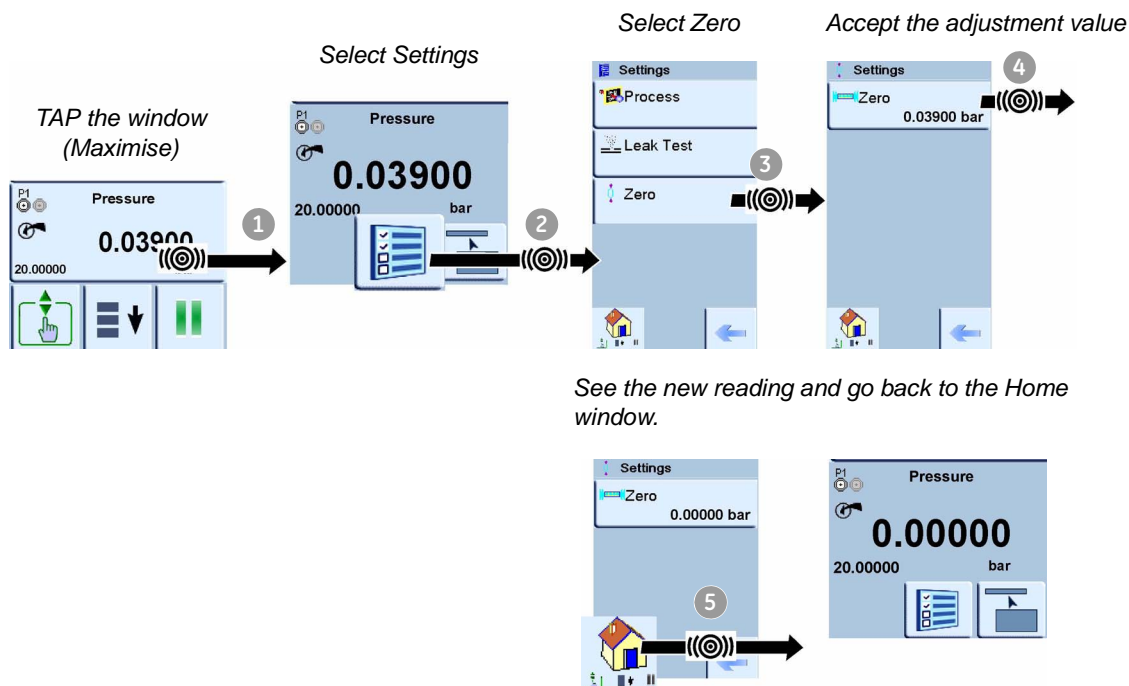

### 5.3.6 Example procedure: Gauge/indicator calibration



1. Assemble the pressure calibrator with the correct PM 620 module and PRV (if applicable); see Section 5.2.3.
2. Set the applicable software options; see Section 5.3.1 (Procedure overview). This example shows one function:
  - Pressure (P1) is set to measure the pressure supplied by the pressure station.
3. To attach the device under test, use the specified procedures for your PV 62x pressure station\*.

4. To set the necessary pressure or vacuum for the calibration, use the specified procedures for your PV 62x pressure station\*.

- \* Reference
- PV 621 models: see Chapter 2 (Pneumatic pressure operation (PV 621))
  - PV 622 models: see Chapter 3 (Pneumatic pressure operation (PV 622))
  - PV 623 models: see Chapter 4 (Hydraulic pressure operation (PV 623))

### 5.3.7 Example procedure: Transmitter calibration

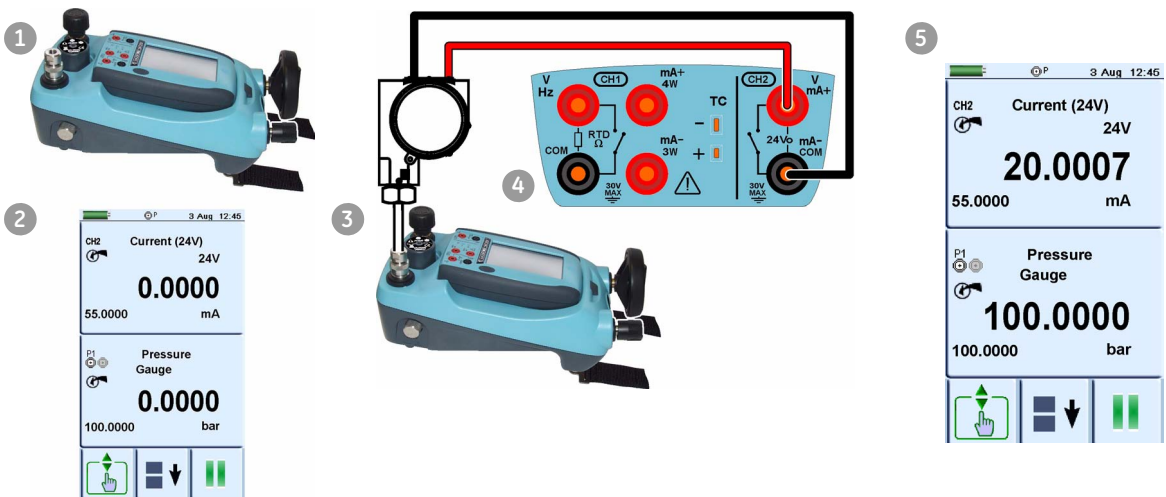

1. Assemble the pressure calibrator with the correct PM 620 module and PRV (if applicable); see Section 5.2.3.
2. Set the applicable software options; see Section 5.3.1 (Procedure overview). This example shows two functions:
  - Channel 2 (CH2) is set to measure current with 24V loop power.
  - Pressure (P1) is set to measure the pressure supplied by the pressure station.
3. To attach the device under test, use the specified procedures for your PV 62x pressure station\*.

- \* *Reference*
- PV 621 models: see Chapter 2 (Pneumatic pressure operation (PV 621))
  - PV 622 models: see Chapter 3 (Pneumatic pressure operation (PV 622))
  - PV 623 models: see Chapter 4 (Hydraulic pressure operation (PV 623))
- 
4. Complete the electrical connections. This example shows Channel 2 (CH2) set up to measure current with 24V loop power.
  5. To set the necessary pressure or vacuum for the calibration, use the specified procedures for your PV 62x pressure station\*.

### 5.3.8 Example procedure: Switch test

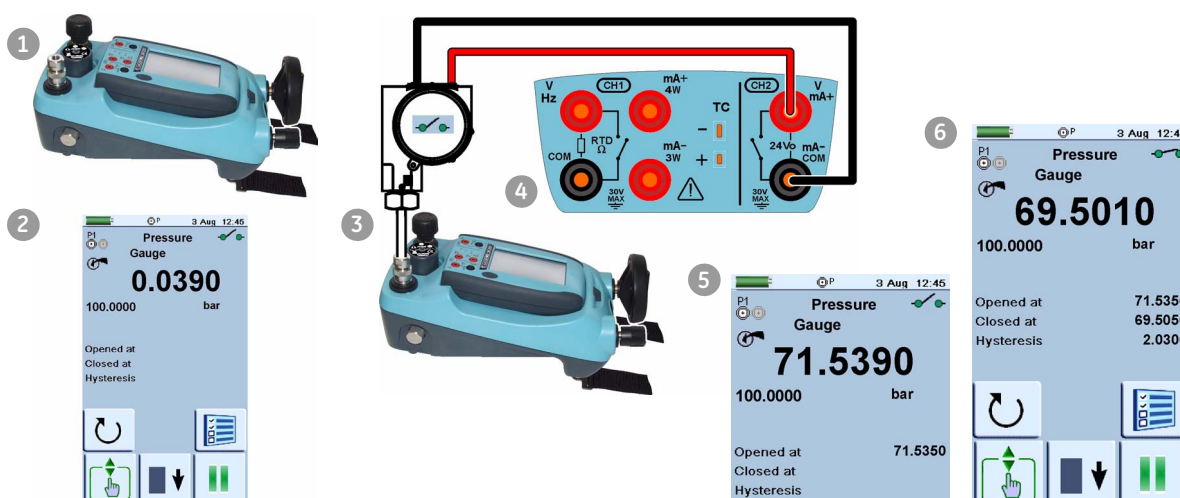

1. Assemble the pressure calibrator with the correct PM 620 module and PRV (if applicable); see Section 5.2.3.
2. Set the applicable software options; see Section 5.3.1 (Procedure overview). This example shows one function:
  - Pressure (P1) is set to measure the pressure. The *Utility* is set to *Switch Test*.
3. To attach the device under test, use the specified procedures for your PV 62x pressure station\*.

- \* *Reference*
- PV 621 models: see Chapter 2 (Pneumatic pressure operation (PV 621))
  - PV 622 models: see Chapter 3 (Pneumatic pressure operation (PV 622))
  - PV 623 models: see Chapter 4 (Hydraulic pressure operation (PV 623))
- 



Open



Closed



Reset

4. Complete the electrical connections. This example shows Channel 2 (CH2) set up to monitor the switch condition.
5. Slowly apply pressure to the system until the switch changes condition (open or closed) - use the specified procedures for your PV 62x pressure station\*.
6. Slowly release the pressure until the switch changes condition again. The display shows:
  - the pressure values to open and close the switch
  - the hysteresis value
7. To do the test again, use the reset button.



# Chapter 6: Maintenance procedures

---

## 6.1 Introduction

This section gives procedures to maintain the unit in a good condition. Return the instrument to the manufacturer or an approved service agent for all repairs.

Do not dispose of this product as household waste. Use an approved organisation that collects and/or recycles waste electrical and electronic equipment.

For more information, contact one of these:

- our customer service department:  
(Contact us at [www.gesensinginspection.com](http://www.gesensinginspection.com))
- your local government office.

---

## 6.2 Clean the unit

Clean the case with a moist, lint-free cloth and a weak detergent. Do not use solvents or abrasive materials.

**Caution: To prevent damage to the instrument, do not let dirt get into the pressure mechanism. Before you attach equipment, make sure it is clean.**

---

## 6.3 Drain the unit (PV 623 models)

**Caution: Ice in the pressure mechanism can cause damage. If the temperature is less than 4°C (39°F), drain all water from the instrument.**

Refer to Section 4.7 (Drain all the hydraulic fluid).

---

## 6.4 Leak test

Table 7-2 gives the maximum leak rates for each type of PV 62x pressure station.

### 6.4.1 Preparation

To do a leak test, we recommend these items:

- a DPI 620 calibrator
- the applicable PM 620 module for the pressure station:
  - PV 621 models: P/N IPM620-13G (20 bar)
  - PV 622 models: P/N IPM620-165G (100 bar)
  - PV 623 models: P/N IPM620-23A (1000 bar)
- an applicable blanking adaptor to seal the test port connection
- PV 623 models only. Demineralised water.

## 6.4.2 Procedure

1. Seal the test port connection with the blanking plug.
2. Attach the applicable PM 620 module  
 PV 621 models: P/N IPM620-13G (20 bar)  
 PV 622 models: P/N IPM620-165G (100 bar)  
 PV 623 models: P/N IPM620-23A (1000 bar)
3. Attach a DPI 620 calibrator and set the power on.
4. Do the test for maximum pressure or maximum vacuum.

### *Maximum pressure test*

1. Use the applicable procedure for the pressure station to set the maximum pressure.  
 PV 621 models: Chapter 2. Set the pressure to 20 bar.  
 PV 622 models: Chapter 3. Set the pressure to 100 bar.  
 PV 623 models: Chapter 4. Set the pressure to 1000 bar.
2. Set the DPI 620 calibrator to do a Leak Test: Chapter 5  
**Channel Settings:** *Units = Bar ; Utility = Leak Test*  
**Settings:** *Test Time = 00:01:00 (1 minute)*
3. Let the pressure become stable for 1 minute.
4. Start the test. When it finishes, compare the result with the specified leak rate; see Table 7-2.

### *Maximum vacuum test*

1. PV 621/PV 622 *models only*. Use the applicable procedure for the pressure station to set the maximum vacuum.  
 PV 621 models: Chapter 2. Set the pressure to -950 mbar.  
 PV 622 models: Chapter 3. Set the pressure to -950 mbar.
2. Set the DPI 620 calibrator to do a Leak Test: Chapter 5  
**Channel Settings:** *Units = Bar ; Utility = Leak Test*  
**Settings:** *Test Time = 00:01:00 (1 minute)*
3. Let the pressure become stable for 1 minute.
4. Start the test. When it finishes, compare the result with the specified leak rate; see Table 7-2.

# Chapter 7: Specification

## 7.1 PV 62x models

For a full specification of the PV 62x pressure stations, refer to the datasheet supplied on the CD (CD: P/N UD-0002)

**Table 7-1: General specification (PV 62x)**

Operating temperature	-10 to 50°C (14 to 122°F) <i>PV 623 models only: See Caution *</i>
Storage temperature	-20 to 70°C (-4 to 158°F) <i>PV 623 models only: See Caution *</i>
Humidity	0 to 90% relative humidity (RH) non-condensing
Shock/Vibration	Def Stan 66-31, 8.4 cat III
EMC	Electromagnetic compatibility: BS EN 61326-1:2006
Electrical safety	Electrical - BS EN 61010:2001
Pressure safety	Pressure Equipment Directive - Class: Sound Engineering Practice (SEP)
Approved	CE Marked
Size (L: W: H)	PV 621 and PV 623: ≈ 350 x 160 x 150 mm (13.8 x 6.3 x 5.9 in) PV 622: ≈ 350 x 160 x 160 mm (13.8 x 6.3 x 6.3 in)
Weight (Pressure stations, calibrator and pressure module)	PV 621 only: ≈ 2.65 kg (5.8 lb) PV 622 only: ≈ 3.30 kg (7.3 lb) PV 623 only: ≈ 3.75 kg (8.3 lb)  DPI 620 only: ≈ 0.57 kg (1.3 lb) - battery included. PM 620 only: ≈ 0.11 kg (0.2 lb)
Pressure connections	Test port: G1/8 or 1/8NPT "Quick fit" pressure adaptors supplied. Other options are available; see Section 1.5 (Accessories).  Other connections: For specified accessories only.
Hydraulic fluid (PV 623 models only)	Reservoir capacity: 100 cm <sup>3</sup> (6.1 in <sup>3</sup> )  Fluid type: Demineralised water or a mineral oil (Recommended ISO viscosity grade ≤ 22)
Power supply	None. If you attach a DPI 620 calibrator to make a pressure calibrator, all the power comes from the DPI 620 calibrator.
<b>*Caution: PV 623 models only. Ice in the pressure mechanism can cause damage. If the temperature is less than 4°C (39°F), drain all water from the instrument.</b>	

## 7.1.1 Pressure data (PV 62x models)

Table 7-2: Pressure specification (PV 62x)

	PV 621 (Pneumatic)	PV 622: (Pneumatic)	PV 623: (Hydraulic)
Range	-950 mbar to 20 bar (-13.5 to 300 psi)	-950 mbar to 100 bar (-13.5 to 1500 psi)	0 to 1000 bar (0 to 15000 psi)
Minimum resolution with a typical test volume	0.001 bar (0.0145 psi)	0.005 bar (0.0725 psi)	0.1 bar (1.45 psi)
Pressure system volume			
V1: Volume adjuster	≈ 9.6 cm <sup>3</sup> (0.6 in <sup>3</sup> )	≈ 16.8 cm <sup>3</sup> (1.0 in <sup>3</sup> )	≈ 1.7 cm <sup>3</sup> (0.1 in <sup>3</sup> )
V2: Pump	≈ 14.3 cm <sup>3</sup> (0.9 in <sup>3</sup> )	≈ 14.3 cm <sup>3</sup> (0.9 in <sup>3</sup> )	<i>Not applicable</i>
V3: Other	≈ 3.0 cm <sup>3</sup> (0.2 in <sup>3</sup> )	≈ 3.0 cm <sup>3</sup> (0.2 in <sup>3</sup> )	≈ 2.0 cm <sup>3</sup> (0.1 in <sup>3</sup> )
Total: V1 + V3	≈ <b>12.6 cm<sup>3</sup> (0.8 in<sup>3</sup>)</b>	≈ <b>19.8 cm<sup>3</sup> (1.2 in<sup>3</sup>)</b>	≈ <b>3.7 cm<sup>3</sup> (0.2 in<sup>3</sup>)</b>
Material of wetted parts	Aluminium, brass, stainless steel, nitrile and polyurethane seals, PTFE, acetal, nylon	Aluminium, brass, stainless steel, nitrile and polyurethane seals, PTFE, acetal, nylon	Brass, stainless steel, phosphor bronze, nitrile and polyurethane seals, PTFE, polyethylene
Leak rates:			
1) at maximum pressure	0.01 bar/min (0.145 psi/min)	0.02 bar/min (0.29 psi/min)	1 bar/min (14.5 psi/min)
2) at maximum vacuum	0.005 bar/min (0.073 psi/min)	0.01 bar/min (0.145 psi/min)	<i>Not applicable</i>

## 7.2 PM 620 modules

For a full specification of the PM 620 module, refer to the datasheet supplied on the CD (CD: P/N UD-0002)

**Table 7-3: General specification (PM 620)**

Operating temperature	-10 to 50°C (14 to 122°F) Calibrated range: 0 to 50°C (32 to 122°F)
Storage temperature	-20 to 70°C (-4 to 158°F)
Ingress Protection	IP65
Humidity 0 to 30°C (32 to 86°F): 30 to 50°C (86 to 122°F):	Relative humidity (RH) 0 to 95% RH non-condensing 0 to 60% RH non-condensing
Shock/Vibration	Def Stan 66-31, 8.4 cat III
EMC	Electromagnetic compatibility: BS EN 61326-1:2006
Electrical safety	Electrical - BS EN 61010:2001
Pressure safety	Pressure Equipment Directive - Class: Sound Engineering Practice (SEP)
Approved	CE Marked
Size	Length, Diameter $\approx$ 58 x 44 (2.3 x 1.7 in)
Weight	Maximum: $\approx$ 0.11 kg (0.2 lb)
Pressure connections	Positive (male) port: Attaches to PV 62x pressure stations only M5 (female) reference pressure port.

### 7.2.1 Pressure data (PM 620 modules)

**Table 7-4: Maximum working pressure (PM 620 modules)**

Ranges:	MWP
$\leq$ 350 mbar (5 psi)	2 x FS
$>$ 350 mbar (5 psi)	1.25 x FS



---

**Customer service**

Visit our web site: [www.gesensinginspection.com](http://www.gesensinginspection.com)

---