

GEBERIT INSTALLATION SYSTEMS

Systems for Wall-Hung Toilets for Sigma 2x6 Installation

Geberit Duofix Carrier, Sigma 2x6 Installation

| Model No. | Description | List Price \$ |
|--------------|--|---------------|
| 111.335.00.5 | Carrier frame with 1.60/0.8 GPF Sigma Concealed Tank | 587.00 |
| 111.902.00.5 | Carrier frame with 1.28/0.8 GPF Sigma Concealed Tank | 587.00 |

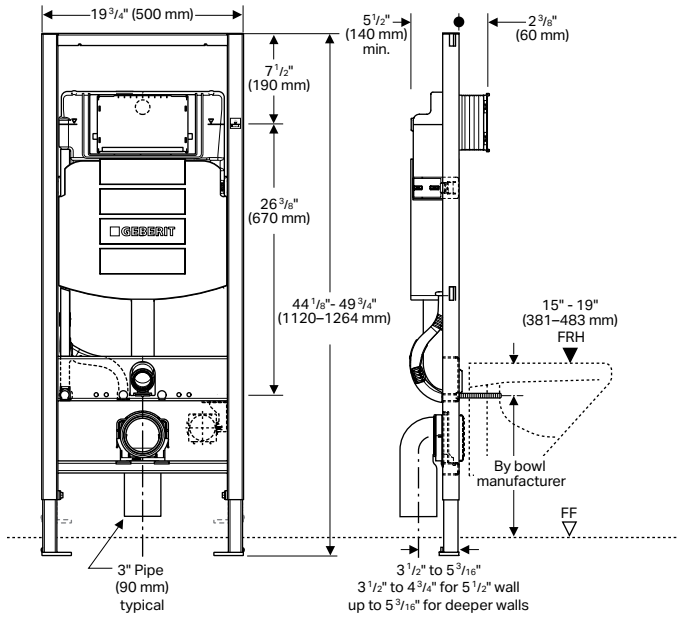



NOTES:







1. Concealed tank shipped dual-flush ready
2. Geberit Duofix Carrier for 2-hole washdown style wall-hung toilet fixtures only
3. Refer to geberit.us for latest list of code approved compatible toilet fixtures, including certified WaterSense® combinations

Note: For System Accessories see pages 26-28.

Dual-Flush Actuators, Sigma 2x6 Installation

| Style | Material | Finish | Model No. | List Price \$ |
|---|--------------|--|--------------------------------------|---------------|
|  | Plastic | Alpine White | 115.770.11.5 | 98.00 |
| | | Polished Chrome | 115.770.21.5 | 135.00 |
| | | Matte Chrome | 115.770.JQ.5 | 135.00 |
| | | Brass Galvanized NEW! | 115.770.DT.5 | 430.00 |
| | | Jet Black NEW! | 115.770.DW.5 | 119.00 |
|  | Stainless | Brushed Nickel-Polished Nickel-Brushed Nickel* | 115.882.ID.1 | 277.00 |
| | | Brushed Stainless Steel-Polished Stainless Steel-Brushed Stainless Steel* | 115.882.SN.1 | 278.00 |
| | | Brushed Nickel-Polished Nickel-Brushed Nickel* Vandal Resistant | 115.889.ID.1 | 324.00 |
| | | Brushed Stainless Steel-Polished Stainless Steel-Brushed Stainless Steel* Vandal Resistant | 115.889.SN.1 | 324.00 |
| | | Plastic | White Matte Coated-White NEW! | 115.882.01.1 |
| White-Matte White NEW! | 115.882.11.1 | | 143.00 | |
| Matte Black-Polished Chrome-Matte Black* | 115.882.14.1 | | 246.00 | |
| Black Matte Coated-Black NEW! | 115.882.16.1 | | 246.00 | |
| Black-Matte Black NEW! | 115.882.DW.1 | | 176.00 | |
| Matte Chrome-Polished Chrome-Matte Chrome* | 115.882.JQ.1 | | 268.00 | |
| Matte White-Polished Chrome-Matte White* | 115.882.JT.1 | | 246.00 | |
| Polished Chrome-Matte Chrome-Polished Chrome* | 115.882.KH.1 | | 207.00 | |
| White-Polished Chrome-White* | 115.882.KJ.1 | | 143.00 | |





Dual-Flush Actuators, Sigma 2x6 Installation (continued)

| Style | Material | Finish | Model No. | List Price \$ |
|---|----------|---|--------------|---------------|
|  | Plastic | White-Polished Gold-White* | 115.882.KK.1 | 398.00 |
| | | Black-Polished Chrome-Black* | 115.882.KM.1 | 176.00 |
|  | Zinc PVD | Customizable | 115.650.00.1 | 683.00 |
| | | Red | 115.650.JM.1 | 854.00 |
| | | Gold | 115.650.JV.1 | 854.00 |
| | | Color NEW! | 115.650.JX.1 | 1,164.00 |
| | | Black Walnut | 115.650.SL.1 | 750.00 |
| | | White | 115.650.SJ.1 | 750.00 |
| | | Black | 115.651.00.1 | 683.00 |
| | | Black | 115.651.JM.1 | 854.00 |
| | | Chrome | 115.651.JV.1 | 854.00 |
| | | Color NEW! | 115.651.JX.1 | 1,164.00 |
|  | Zinc PVD | Customizable | 115.651.00.1 | 683.00 |
| | | Black | 115.651.JM.1 | 854.00 |
| | | Chrome | 115.651.JV.1 | 854.00 |
| | | Color NEW! | 115.651.JX.1 | 1,164.00 |
| | | Black Walnut | 115.651.SL.1 | 750.00 |
| | | White | 115.651.SJ.1 | 750.00 |
| | | Black | 115.652.00.1 | 683.00 |
| | | Brass | 115.652.JM.1 | 854.00 |
| | | Color NEW! | 115.652.JV.1 | 854.00 |
| | | Concrete Look | 115.652.JX.1 | 1,164.00 |
|  | Zinc PVD | Customizable | 115.652.00.1 | 683.00 |
| | | Brass | 115.652.JM.1 | 854.00 |
| | | Color NEW! | 115.652.JV.1 | 854.00 |
| | | Concrete Look | 115.652.JX.1 | 1,164.00 |
| | | Black Walnut | 115.652.SL.1 | 750.00 |
| | | White | 115.652.SJ.1 | 750.00 |
| | | Black | 115.761.00.4 | 521.00 |
| | | Zinc | 115.761.00.5 | 521.00 |
| | | Chrome | 115.761.00.6 | 521.00 |
| | | Color NEW! | 115.761.00.7 | 521.00 |
|  | Plastic | White Matte Coated-Coated-White NEW! | 115.883.01.1 | 273.00 |
| | | White-Matte White NEW! | 115.883.11.1 | 166.00 |
| | | Matte Black-Polished Chrome-Matte Black*** | 115.883.14.1 | 273.00 |
| | | Black Matte Coated-Black NEW! | 115.883.16.1 | 273.00 |
| | | Black-Matte Black NEW! | 115.883.DW.1 | 187.00 |
| | | Matte Chrome-Polished Chrome-Matte Chrome*** | 115.883.JQ.1 | 285.00 |
| | | Matte White-Polished Chrome-Matte White*** | 115.883.JT.1 | 273.00 |
| | | Polished Chrome-Matte Chrome-Polished Chrome*** | 115.883.KH.1 | 232.00 |
| | | White-Polished Chrome-White*** | 115.883.KJ.1 | 145.00 |
| | | White-Polished Gold-White*** | 115.883.KK.1 | 187.00 |
|  | Zinc PVD | Customizable | 115.670.00.2 | 683.00 |
| | | Red | 115.670.11.2 | 683.00 |
| | | Gold | 115.670.DW.2 | 683.00 |
| | | Color NEW! | 115.670.JM.2 | 854.00 |
| | | Black | 115.670.JV.2 | 854.00 |
| | | Mustang Slate | 115.670.JX.2 | 1,164.00 |
| | | Concrete Look | 115.671.00.2 | 683.00 |
| | | Black Walnut | 115.671.11.2 | 683.00 |
| | | Chrome | 115.671.DW.2 | 683.00 |
| | | Color NEW! | 115.671.JM.2 | 854.00 |
|  | Zinc PVD | Customizable | 115.671.00.2 | 683.00 |
| | | Black | 115.671.11.2 | 683.00 |
| | | Chrome | 115.671.DW.2 | 683.00 |
| | | Color NEW! | 115.671.JM.2 | 854.00 |
| | | Mustang Slate | 115.671.JV.2 | 854.00 |
| | | Concrete Look | 115.671.JX.2 | 1,164.00 |

Products marked with  comply with the American Disabilities Act (ADA) when installed per the requirements of the latest ADA Accessibility Guidelines (ADAAG) and/or ICC/ANSI A117.1.

The information contained in this document is subject to change without notice.

Dual-Flush Actuators, Sigma 2x6 Installation 

| Style | Material | Finish | Model No. | List Price \$ |
|--|---|---|--------------|---------------|
|  | Zinc PVD Brass Color <i>NEW!</i> | Customizable | 115.672.00.2 | 683.00 |
| | | White | 115.672.11.2 | 683.00 |
| | | Black | 115.672.DW.2 | 683.00 |
| | | Mustang Slate | 115.672.JM.2 | 854.00 |
| | | Concrete Look | 115.672.JV.2 | 854.00 |
|  | Zinc Chrome Color | Black Walnut | 115.672.JX.2 | 1,164.00 |
| | | Concrete Look <i>NEW!</i> | 115.788.JV.2 | 521.00 |
| | | Black Walnut <i>NEW!</i> | 115.788.JX.2 | 818.00 |
| | | Customizable | 115.788.00.2 | 409.00 |
| | | White | 115.788.11.2 | 409.00 |
| | | Bright Chrome | 115.788.21.2 | 526.00 |
| | | Black | 115.788.DW.2 | 409.00 |
| | | Brushed Chrome | 115.788.GH.2 | 526.00 |
| | | Lava Glass <i>NEW!</i> | 115.788.JK.2 | 526.00 |
| | | Grey Sand Glass <i>NEW!</i> | 115.788.JL.2 | 526.00 |
| | | Mustang Slate | 115.788.JM.2 | 526.00 |
| Smoked Glass | 115.788.SD.2 | 526.00 | | |
|  | Zinc Glass | Brushed Chrome | 115.640.GH.1 | 690.00 |
| | | Lava Glass <i>NEW!</i> | 115.640.JK.1 | 690.00 |
| | | Grey Sand Glass <i>NEW!</i> | 115.640.JL.1 | 690.00 |
| | | White Glass | 115.640.SL.1 | 690.00 |
| | | Black Glass | 115.640.SJ.1 | 690.00 |
| | | Rough-in set (REQUIRED accessory) | 243.168.00.1 | 17.00 |
| | | Cover frame (optional accessory) Polished Chrome | 115.641.21.1 | 186.00 |
| | | Cover frame (optional accessory) Brushed Chrome | 115.641.GH.1 | 186.00 |
|  | Plastic Stainless Glass | Customizable | 115.620.00.1 | 584.00 |
| | | Brushed Stainless Steel | 115.620.FW.1 | 774.00 |
| | | Lava Glass <i>NEW!</i> | 115.620.JK.1 | 683.00 |
| | | Grey Sand Glass <i>NEW!</i> | 115.620.JL.1 | 683.00 |
| | | White Glass | 115.620.SL.1 | 683.00 |
| Black Glass | 115.620.SJ.1 | 683.00 | | |



Single-Flush Actuators, Sigma 2x6 Installation 

| Style | Material | Finish | Model No. | List Price \$ | |
|---|-----------|--|---|---------------|--------|
|  | Stainless | Matte Black-Polished Chrome-Matte Black* | 115.758.14.5 | 386.00 | |
| | | Matte White-Polished Chrome-Matte White* | 115.758.JT.5 | 386.00 | |
| | | Brushed Stainless Steel-Polished Stainless Steel-Brushed Stainless Steel* | 115.758.SN.5 | 282.00 | |
| | | Brushed Stainless Steel-Polished Stainless Steel-Brushed Stainless Steel* Vandal Resistant | 115.787.SN.5 | 320.00 | |
| | | Plastic | Polished Chrome-Matte Chrome- Polished Chrome* | 115.758.KH.5 | 207.00 |
| | | | White-Polished Chrome-White* | 115.758.KJ.5 | 144.00 |
| | | | White-Polished Gold-White* | 115.758.KK.5 | 410.00 |
| | | | Black-Polished Chrome-Black* | 115.758.KM.5 | 176.00 |
| | | | Matte Chrome-Polished Chrome-Matte Chrome* | 115.758.JQ.5 | 207.00 |

Single-Flush Actuators, Sigma 2x6 Installation 

| Style | Material | Finish | Model No. | List Price \$ |
|---|----------|---|--------------|---------------|
|  | Zinc | Matte Black-Polished Chrome-Matte Black*** | 115.893.14.1 | 368.00 |
| | | Matte White-Polished Chrome-Matte White*** | 115.893.JT.1 | 368.00 |
| | | Polished Gold*** | 115.893.45.1 | 2,978.00 |
| | | White-Polished Chrome-White*** | 115.893.KJ.1 | 274.00 |
| | | Brushed Chrome-Polished Chrome- Brushed Chrome*** | 115.893.KX.1 | 403.00 |
| | | Polished Chrome-Brushed Chrome- Polished Chrome*** | 115.893.KY.1 | 403.00 |

Dual-Flush Hands-Free Actuators and Transformer, Sigma 2x6 Installation 

| Style | Material | Finish | Model No. | List Price \$ | |
|---|-----------|---|---|---------------|--------|
|  | Stainless | Brushed Stainless Steel-Polished Stainless Steel-Brushed Stainless Steel* Vandal Resistant (AC Power with manual override) | 115.890.SN.5 | 967.00 | |
| | | Brushed Stainless Steel-Polished Stainless Steel-Brushed Stainless Steel* Vandal Resistant (Battery/DC Power with manual override) | 115.891.SN.5 | 996.00 | |
|  | Plastic | Polished Chrome-Matte Chrome* (AC Power) | 115.907.KH.1 | 789.00 | |
| | | White-Polished Chrome* (AC Power) | 115.907.KJ.1 | 789.00 | |
| | | White-Polished Gold* (AC Power) | 115.907.KK.1 | 789.00 | |
| | | White-Matte Chrome* (AC Power) | 115.907.KL.1 | 789.00 | |
| | | Black-Polished Chrome* (AC Power) | 115.907.KM.1 | 789.00 | |
| | | Matte Chrome-Polished Chrome* (AC Power) | 115.907.KN.1 | 789.00 | |
| | | Stainless | Brushed Stainless Steel-Polished Stainless Steel* (AC Power) | 115.907.SN.1 | 846.00 |
| | | | Required Transformer for AC powered hands-free actuator (order separately) | 115.861.00.1 | 165.00 |
| | | | Polished Chrome-Matte Chrome* (Battery) | 115.908.KH.1 | 811.00 |
| | | | White-Polished Chrome* (Battery) | 115.908.KJ.1 | 811.00 |
|  | Glass | Black (AC Power) | 116.090.SG.1 | 1,616.00 | |
| | | Mirror (AC Power) | 116.090.SM.1 | 1,616.00 | |
| | | Note: Sigma80 not recommended for bidet seat applications | | | |
| | | Required Transformer for AC powered hands-free actuator (order separately) | 115.861.00.1 | 165.00 | |
| | | Plastic | Extension mains cable (optional accessory for Sigma10 and Sigma80) length 78-3/4" (2 m) | 241.831.00.1 | 79.00 |

Remote Programming Accessory for Hands-Free Actuators

| | | | |
|---|---|--------------|--------|
|  | "Service Handy" remote programming device for Geberit touch-free devices | 115.860.00.1 | 388.00 |
|---|---|--------------|--------|

* Finishes follow this pattern = Plate-Ring-Button
 ** Finishes follow this pattern = Frame-Button
 ***Finishes follow this pattern = Frame-Button Edge Trim-Button
 † Note: For tile, stone or other hard surfaced walls only!
 ‡ Not intended to be sold in California with 1.6 GPF units











The information contained in this document is subject to change without notice.

Products marked with  comply with the American Disabilities Act (ADA) when installed per the requirements of the latest ADA Accessibility Guidelines (ADAAG) and/or ICC/ANSI A117.1.



GEBERIT INSTALLATION SYSTEMS

Systems for Wall-Hung Toilets for Sigma 2x6 Installation

Dual-Flush Buttons for Concealed Installations, Sigma 2x6 Installation

| Style | Material | Finish | Model No. | List Price \$ |
|--|-----------|---|--------------|---------------|
| Type 01  | Plastic | Alpine White | 116.042.11.1 | 131.00 |
| | | Polished Chrome | 116.042.21.1 | 171.00 |
| Type 10  | Plastic | Alpine White  | 116.044.11.1 | 131.00 |
| | | Matte Chrome-Polished Chrome** | 116.055.KH.1 | 187.00 |
| | | Polished Chrome-White** | 116.055.KJ.1 | 171.00 |
| Type 70  | Stainless | Brushed Stainless Steel  | 115.630.FW.1 | 871.00 |
| | | Lava Glass NEW! | 115.630.JK.1 | 741.00 |
| | Glass | Grey Sand Glass NEW! | 115.630.JL.1 | 741.00 |
| | | White Glass  | 115.630.SI.1 | 741.00 |
| | | Black Glass  | 115.630.SJ.1 | 741.00 |
| Rectangle  | Plastic | Polished Chrome-Matte Chrome** | 116.051.KA.1 | 171.00 |
| | | Black-Chrome NEW! | 116.051.KV.1 | 171.00 |
| | Zinc | Brushed Chrome | 116.051.GH.1 | 295.00 |
|  | Plastic | Polished Chrome  | 116.052.21.1 | 171.00 |

Dual-Flush Buttons for Furniture Installations, Sigma 2x6 Installation



| Style | Material | Finish | Model No. | List Price \$ |
|--|----------|--------------------------------|--------------|---------------|
| Type 01  | Plastic | Alpine White | 116.050.11.1 | 131.00 |
| | | Polished Chrome | 116.050.21.1 | 171.00 |
| | | Matte Chrome | 116.050.46.1 | 171.00 |
| Type 10  | Plastic | Matte Chrome-Polished Chrome** | 116.057.KH.1 | 187.00 |
| | | Polished Chrome-White** | 116.057.KJ.1 | 171.00 |

Single-Flush Buttons for Concealed Installations, Sigma 2x6 Installation



| | | | | |
|---|---------|-----------------|--------------|--------|
| Type 01†  | Plastic | Alpine White | 116.040.11.1 | 112.00 |
| | | Polished Chrome | 116.040.21.1 | 131.00 |

Extension Hoses for Flush Button Installations

(For Flush Buttons located beyond 6' from carrier)

| | | | |
|---|--|--------------|------|
|  | Double pneumatic hose for dual-flush 78.74" (2 m) (Blue/Clear for Type01/Type10/Rectangle) | 240.575.00.1 | 9.00 |
|  | Double pneumatic hose, 78.74" (2 m), dual-flush (Green/Clear for Type70) | 243.297.00.1 | 9.00 |
|  | Pneumatic hose 137.80" (3.5 m) for single flush | 256.000.00.1 | 8.00 |

Cover Plates for Sigma Concealed Tank, Sigma 2x6 Installation, for use with Flush Buttons

| | | | | |
|---|-----------|-------------------------|--------------|--------|
|  | Glass | White | 115.766.SI.1 | 229.00 |
| | Stainless | Brushed Stainless Steel | 115.764.FW.1 | 183.00 |
| | | Vandal Resistant | 115.766.00.1 | 183.00 |
|  | Plastic | Alpine White | 115.768.11.1 | 80.00 |
| | | Polished Chrome | 115.768.21.1 | 105.00 |
| | | Matte Chrome | 115.768.46.1 | 105.00 |

Surface Even Cover Plates for Sigma Concealed Tank, 2x6 Installation, for use with Flush Buttons

| | | | | |
|---|---------|---|--------------|--------|
|  | Plastic | Customizable† | 115.696.00.1 | 229.00 |
| | | Customizable with frame† | 115.697.00.1 | 289.00 |
| | | Rough-in set (REQUIRED accessory. Purchase with one of above) | 243.168.00.1 | 17.00 |

* Finishes follow this pattern = Plate-Ring-Button

** Finishes follow this pattern = Frame-Button

***Finishes follow this pattern = Frame-Button Edge Trim-Button

† Note: For tile, stone or other hard surfaced walls only!

‡ Not intended to be sold in California with 1.6 GPF units

The information contained in this document is subject to change without notice.

GEBERIT INSTALLATION SYSTEMS

Replacement Parts

Geberit Duofix Carrier 111.335.00.5 and 111.902.00.5, Sigma 2x6 Installation

| Item | Model No. | Description | List Price \$ |
|------|------------------------------|---|---------------|
| 1 | 242.314.00.1 | Materials for Concealed Carrier and Tank installation | 62.00 |
| 2 | 242.315.00.1 | Splash guard protection cover for Sigma Concealed Tank | 9.00 |
| 3 | 243.345.00.1 or 243.168.00.1 | Mud guard protection housing for Sigma Concealed Tanks 2x6 and 2x4, plastic | 17.00 |
| 4 | 362.771.00.1 | Seal for concealed flush pipe, EPDM | 3.00 |
| 5 | 362.796.92.1 | Protection plug, plastic | 6.00 |
| 6 | 240.189.00.1 | Threaded rod for wall-mounted toilet or bidet installation | 5.00 |
| 7 | 152.404.46.1 | Connector set with mounting hardware (bowl installation kit), HDPE; Matte Chrome cover caps | 47.00 |
| 7 | 152.404.11.1 | Connector set with mounting hardware (bowl installation kit), HDPE; Matte White cover caps (accessory only) | 47.00 |
| 7.1 | 217.713.46.1 | Cover caps with leveling washer, plastic, Matte Chrome | 7.00 |
| 7.2 | 119.668.00.1 | Seal for supply inlet tube, EPDM | 3.00 |
| 7.3 | 152.424.00.1 | Seal for toilet outlet connector, EPDM | 5.00 |
| 8 | 366.061.16.1 | HDPE waste fitting outlet bend, 1 x 90° bend with socket for Ø3.50" (Ø90 mm) push fit piping and Ø3.50" (Ø90 mm) outlet | 24.00 |
| 8.1 | 387.282.00.1 | Seal for outlet bends, EPDM | 5.00 |
| 9 | 366.820.92.1 | Protection plug, plastic | 4.00 |
| 10 | — | Flexible coupling FERNCO 3005-33 | — |
| 11 | 242.012.00.1 | Outlet pipe bracket (complete) | 6.00 |

| Item | Model No. | Description | List Price \$ |
|------|--------------|--|---------------|
| 12 | 242.886.00.1 | Conduit pipe for shower toilet water supply with Sigma Concealed Tank 2x6, Omega Concealed Tank or Kappa Concealed Tank (from 2013 on) | 13.00 |
| 13 | 111.892.00.1 | Frame mounting screws for steel stud construction, galvanized, self-tapping | 6.00 |
| 14 | 240.853.00.1 | Supply angle stop (black handle) | 14.00 |
| 14.1 | 240.851.00.1 | Drop ear elbow, copper | 14.00 |
| 15 | 240.921.00.1 | Connection hose for Sigma Concealed Tank, 3/8" | 16.00 |
| 15.1 | 240.922.00.1 | Set of seals for RFB hose | 4.00 |
| 16 | 240.923.00.1 | Fixation clip for filling valve | 6.00 |
| 17 | 241.469.00.1 | Filling valve Type 380 for Sigma, Omega and Kappa Concealed Tanks | 30.00 |
| 17.1 | 240.771.00.1 | Seal kit for filling valve Type 380 | 11.00 |
| 18.1 | 241.167.00.1 | Yoke set for flush valves | 11.00 |
| 18.2 | 816.418.00.1 | Geberit flat gasket for flush valve | 3.00 |
| 19.1 | 241.868.00.1 | U-cup seal for valve basket | 3.00 |
| 20 | 241.829.00.1 | Flush actuator gear box | 9.00 |
| 21 | 240.269.00.1 | Angle stop valve to concealed tank (blue handle) | 22.00 |
| 21.1 | 240.298.00.1 | Spindle to angle stop valve | 17.00 |
| 21.2 | 241.857.00.1 | Counter nut, plastic | 5.00 |
| 21.3 | 240.347.00.1 | Handle for angle stop valve (blue) | 5.00 |
| 22 | 244.125.00.1 | Foot plate set | 16.00 |
| 23 | 242.698.00.1 | Concealed Flush Bend for Sigma tank | 36.00 |
| 24A | 245.380.00.1 | 1.6/0.8 GPF dual flush valve for Sigma Tanks | 22.00 |
| 24B | 245.400.00.1 | 1.28/0.8 GPF dual flush valve for Sigma Tanks | 22.00 |
| 24.1 | 244.844.00.1 | Handle set | 13.00 |
| 24.2 | 244.244.00.1 | Flat gasket seal | 3.00 |
| 24.3 | 241.868.00.1 | U-cup seal for valve basket | 3.00 |

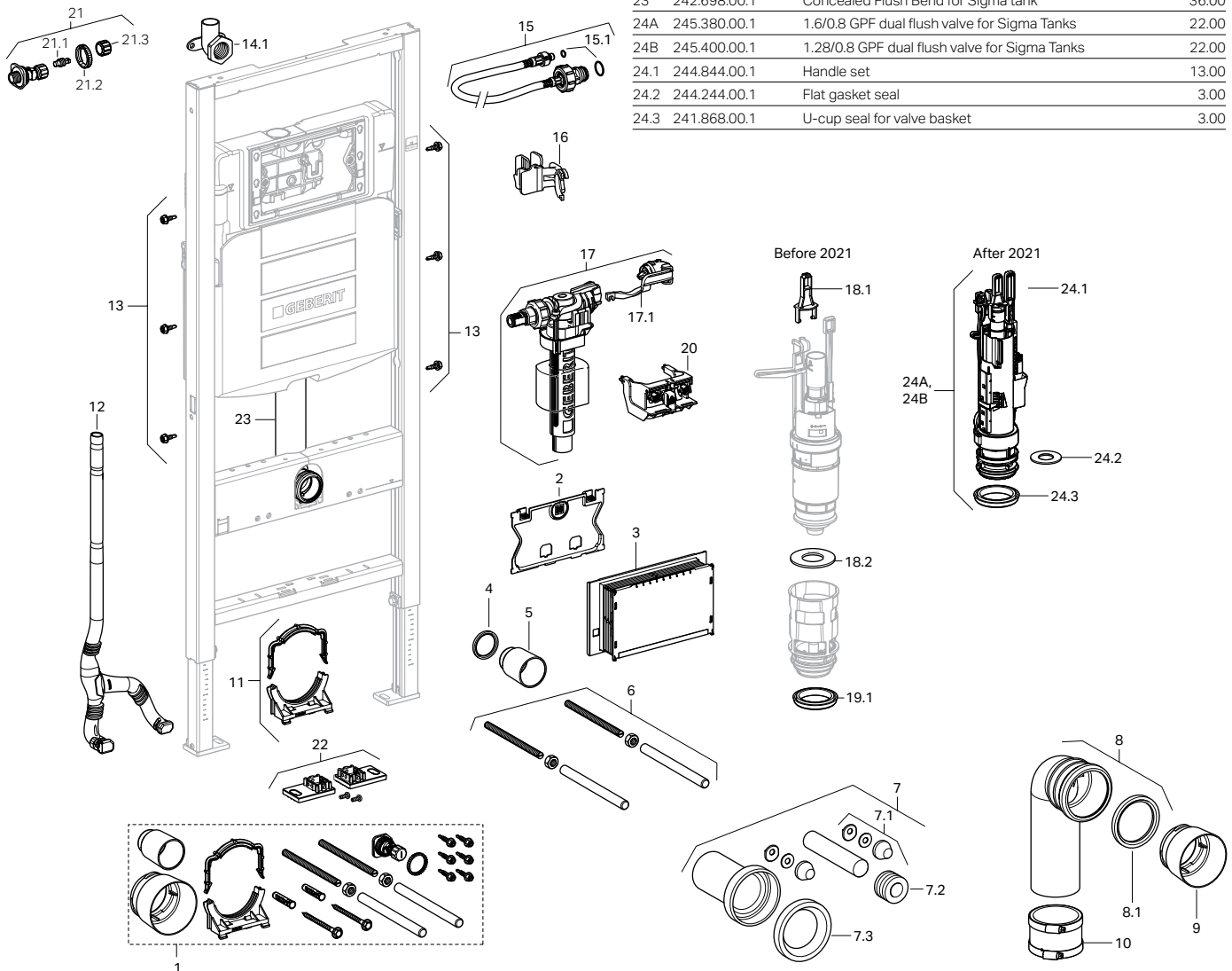

The information contained in this document is subject to change without notice.



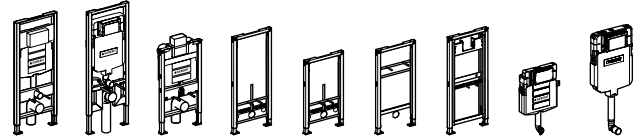

GEBERIT SYSTEM ACCESSORIES

Geberit Optional and Required Accessories for Installation



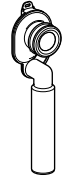

| Description | Model Number | List Price \$ | 111.335 | 111.798 | 111.012 | | | | | | 109.304 | | |
|-------------|--------------|---------------|---------|---------|---------|---------|---------|---------|---------|---------|---------|--|--|
| | | | 111.902 | 111.597 | 111.018 | 111.520 | 111.524 | 111.490 | 111.625 | 109.307 | 109.797 | | |

OPTIONAL Connection Sets and Accessories for Finished Walls up to 3.5" (9cm) Thick

| | | | | | | | | | | | | | | | |
|---|--|--------------|--------|---|---|---|---|---|---|--|--|--|---|---|---|
|  | PE syphon trap with horizontal outlet and seal; Ø1.96" (Ø50 mm) outlet | 152.950.11.1 | 38.00 | | | | | | | | | | ✓ | | |
|  | PE syphon trap with vertical outlet and seal; Ø1.97" (Ø50 mm) outlet | 152.951.11.1 | 38.00 | | | | | | | | | | ✓ | | |
|  | Acoustic insulation set for wall-hung toilets and bidets | 156.050.00.1 | 20.00 | ✓ | ✓ | ✓ | ✓ | ✓ | | | | | | | |
|  | Cover caps with leveling washer, plastic, Alpine White | 217.713.11.1 | 9.00 | ✓ | ✓ | ✓ | ✓ | ✓ | ✓ | | | | | | |
|  | HDPE connection set with 1" (2.5 cm) offset and mounting hardware (bowl installation kit); with socket for Ø3.50" (Ø90 mm) push fit piping and Ø55 supply inlet; Matte Chrome cover caps | 405.116.00.1 | 238.00 | ✓ | ✓ | ✓ | | | | | | | | ✓ | ✓ |

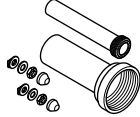
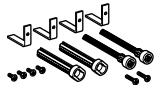
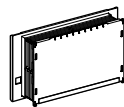
REQUIRED Connection Sets and Accessories for Finished Walls 3.5" - 7.0" (9-18cm) Thick

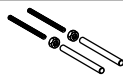
| | | | | | | | | | | | | | | | |
|---|---|--------------|-------|---|---|---|---|---|--|---|--|---|---|---|---|
|  | HDPE Connector set for extended installation and mounting hardware (bowl installation kit), with socket for Ø3.50" (Ø90 mm) push fit piping and Ø2.16" (Ø55 mm) supply inlet; Matte Chrome cover caps | 152.438.46.1 | 59.00 | ✓ | ✓ | ✓ | | | | | | | | ✓ | ✓ |
|  | Extension set for actuator plates for Sigma Concealed Tanks 2x6 and 2x4, Kappa and Omega Concealed Tanks | 240.938.00.1 | 26.00 | ✓ | ✓ | ✓ | | | | | | | | ✓ | ✓ |
|  | Mud guard protection housing for Sigma Concealed Tanks 2x6 and 2x4, plastic, 4 inch (10 cm) | 241.826.00.1 | 14.00 | ✓ | ✓ | | | | | | | | | ✓ | ✓ |
|  | Mud guard protection housing and extension set for urinal carrier | 241.930.00.1 | 21.00 | | | | | | | | | | ✓ | | |
|  | Mounting rod M12 x 10" long. Not supplied. | M12 x 10" | — | ✓ | ✓ | ✓ | ✓ | ✓ | | | | | | | |
| | Mounting rod M10 x 10" long. Not supplied. | M10 x 10" | — | | | | | | | ✓ | | | | | |
| | Mounting rod M8 x 10" long. Not supplied. | M8 x 10" | — | | | | | | | | | ✓ | | | |

The information contained in this document is subject to change without notice.

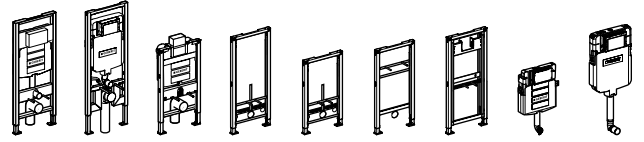

| Description | Model Number | List Price \$ | 111.335 | 111.798 | 111.012 | | | | | | 109.304 | |
|-------------|--------------|---------------|---------|---------|---------|---------|---------|---------|---------|---------|---------|--|
| | | | 111.902 | 111.597 | 111.018 | 111.520 | 111.524 | 111.490 | 111.625 | 109.307 | 109.797 | |

OPTIONAL Installation Accessories for Bidet Seats

| | | | | | | | | | | | | | |
|--|---|--------------|--------|---|---|---|--|--|--|--|--|--|--|
| | Water supply hose for bidet seat for Kappa and Omega Concealed Tank pre-wall. For adding bidet seat to an installed carrier. For complete installation, must order with 249.801.00.1. | 240.839.00.1 | 68.00 | | | ✓ | | | | | | | |
| | Water supply hose for bidet seat for 111.597.00.1 and 111.798.00.1 carrier with Sigma Concealed Tank 2x4. For adding bidet seat to an installed carrier. For complete installation, must order with 249.801.00.1. | 243.173.00.1 | 51.00 | | ✓ | | | | | | | | |
| | Water supply hose for bidet seat add-on after finished installation of Sigma 2x6 and 2x4, Kappa and Omega Concealed Tanks. | 249.801.00.1 | 123.00 | ✓ | ✓ | ✓ | | | | | | | |

OPTIONAL Installation Accessories for Geberit Duofix Carrier Frames

| | | | | | | | | | | | | | |
|--|---|--------------|--------|---|---|---|---|---|---|---|---|--|--|
| | Frame to wall anchoring for 5.125"-7.875" (13-20 cm) thick unfinished pre-wall | 111.013.00.1 | 25.00 | | ✓ | | | | | | | | |
| | Frame to wall anchoring for 5.125"-7.875" (13-20 cm) thick unfinished pre-wall | 111.815.00.1 | 37.00 | ✓ | | ✓ | ✓ | ✓ | ✓ | ✓ | | | |
| | Frame to wall anchoring for 5.125"-7.875" (13-20 cm) thick unfinished pre-wall corner installations | 111.835.00.1 | 37.00 | ✓ | ✓ | ✓ | ✓ | ✓ | ✓ | ✓ | | | |
| | Support brackets for wall-hung toilets with small contact surface (thin profiles) | 111.847.00.1 | 51.00 | ✓ | | ✓ | | | | | | | |
| | Fire protection set for Sigma Concealed Tank 90 min. fire resistance to DIN EN 1364-1:1999-10 | 111.863.00.1 | 553.00 | ✓ | | | | | | | | | |
| | Frame to wall anchoring where foot installations into floor are not allowed for 5.125"-9.50" (13-24 cm) | 111.064.00.1 | 70.00 | ✓ | ✓ | ✓ | ✓ | ✓ | ✓ | ✓ | | | |
| | Fastening set for sinks with 14.9"-22.8" (38-58 cm) mounting centers | 111.868.00.1 | 121.00 | | | | | | | ✓ | | | |
| | Frame to stud fastening set for extended stud spacing from 19.75"-25.56" (50-65 cm) | 111.869.00.1 | 37.00 | ✓ | ✓ | ✓ | ✓ | ✓ | ✓ | ✓ | | | |
| | Frame to wall anchoring extensions for 7.875"-15.75" (20-40 cm) thick (unfinished pre-wall) | 111.887.00.1 | 16.00 | ✓ | ✓ | ✓ | ✓ | ✓ | ✓ | ✓ | | | |
| | Crossbar for inlet 1/2" thread | 242.042.00.1 | 114.00 | | | | | | | | ✓ | | |
| | Retrofit adapter for inlet, 1/2" thread | 242.309.00.1 | 114.00 | | | | | | | | ✓ | | |
| | Elbow supply fitting set, Gun Metal | 465.034.00.2 | 40.00 | | | | ✓ | ✓ | ✓ | | | | |

The information contained in this document is subject to change without notice.

