

**Bureau of Mines Report of Investigations/1975**

**Geologic Investigations  
of Underground Coal Mining Problems**



**UNITED STATES DEPARTMENT OF THE INTERIOR**

**Report of Investigations 8022**

# **Geologic Investigations of Underground Coal Mining Problems**

**By C. M. McCulloch, P. W. Jeran, and C. D. Sullivan  
Pittsburgh Mining and Safety Research Center, Pittsburgh, Pa.**



**UNITED STATES DEPARTMENT OF THE INTERIOR  
Rogers C. B. Morton, Secretary**

**Jack W. Carlson, Assistant Secretary—Energy and Minerals**

**BUREAU OF MINES  
Thomas V. Falkie, Director**

This publication has been cataloged as follows:

**McCulloch, Charles M**

Geologic investigations of underground coal mining problems, by C. M. McCulloch, P. W. Jeran, and C. D. Sullivan. [Washington] U.S. Bureau of Mines [1975]

30 p., illus. (U.S. Bureau of Mines. Report of investigations 8022)

Includes bibliography.

1. Coal mines and mining. I. Jeran, Paul W., jt. auth. II. Sullivan, C. D., jt. auth. III. U.S. Bureau of Mines. IV. Title. (Series)

TN23.U7      no. 8022      622.06173

U.S. Dept. of the Int. Library.

## CONTENTS

	<u>Page</u>
Abstract.....	1
Introduction.....	1
Acknowledgments.....	2
Geologic mine survey techniques.....	2
Maps of mine problem areas and their preparation.....	2
Underground surveys.....	3
Surface fieldwork.....	3
Documentation.....	3
Surveys of six mines and their problems.....	5
Marianna No. 58 mine.....	5
Lucerne No. 6 mine.....	7
Somerset No. 60 mine.....	10
Federal No. 2 mine.....	14
Howe mine.....	16
Beatrice-Pocahontas mine.....	18
Summary.....	25
References.....	27
Glossary of terms.....	28

## ILLUSTRATIONS

1. Fence diagram of strata above the Pittsburgh coalbed, Marianna No. 58 mine.....	4
2. Structure drawn on base of the Pittsburgh coalbed, Marianna No. 58 mine.....	5
3. Overlay of mine streams on surface related to underground falls....	6
4. Isopach of the wild coal interval over the Pittsburgh coalbed in the Marianna No. 58 mine.....	6
5. Location of clay veins in the Marianna No. 58 mine.....	7
6. Surface joint data above the Marianna No. 58 mine.....	8
7. Fault exposure at Lucerne No. 6 mine.....	9
8. Generalized sketch of typical thrust fault exposure at the Lucerne No. 6 mine.....	9
9. Structure map drawn on the base of the Upper Freeport coalbed, Lucerne No. 6 mine.....	10
10. Fence diagram of strata above the Upper Freeport coalbed, Lucerne No. 6 mine.....	11
11. Structure map drawn on the base of the Pittsburgh coalbed at Somerset No. 60 mine.....	12
12. Fence diagram of strata above the Pittsburgh coalbed, Somerset No. 60 mine.....	13
13. Lithologic change between drill holes TH1 and TH2.....	14
14. Location of possible sand channel washout, Somerset No. 60 mine....	14
15. Isopach of the draw slate unit above the Pittsburgh coalbed, Somerset No. 60 mine.....	14
16. Outline of the Federal No. 2 mine.....	15
17. Structure map drawn on the base of the Pittsburgh coalbed, Federal No. 2 mine.....	16

## ILLUSTRATIONS --Continued

	<u>Page</u>
18. Structure map drawn on the base of the Lower Hartshorne coalbed, Howe mine.....	17
19. Fence diagram of the strata above the Lower Hartshorne coalbed, Howe mine.....	18
20. Map of Keen Mountain fault in the Pocahontas No. 3 coalbed, Beatrice-Pocahontas mine.....	19
21. Cleat rotation in relation to shear fault, Beatrice-Pocahontas mine	20
22. Structure map drawn on the base of the Pocahontas No. 3 coalbed, Beatrice-Pocahontas mine.....	21
23. Fence diagram of the strata above the Pocahontas No. 3 coalbed, Beatrice-Pocahontas mine.....	22
24. Nature of sandstone above Pocahontas No. 3 coalbed, Beatrice- Pocahontas mine.....	23
25. Isopach of Pocahontas No. 3 coalbed (inches), Beatrice-Pocahontas mine.....	24
26. Isopach of interval between Pocahontas No. 3 coalbed and sandstone above Beatrice-Pocahontas mine.....	25
27. Overburden isopach map of interval from Pocahontas No. 3 coalbed to surface, Beatrice-Pocahontas mine.....	25

# GEOLOGIC INVESTIGATIONS OF UNDERGROUND COAL MINING PROBLEMS

by

C. M. McCulloch,<sup>1</sup> P. W. Jeran,<sup>1</sup> and C. D. Sullivan<sup>2</sup>

---

## ABSTRACT

A series of geological surveys were completed in six coal mines in connection with a Bureau of Mines research program on methane control. The aim of these surveys was twofold: First, to study the overall geology of the coalbed, and second to use the resulting data to evaluate the influence of the geological characteristics of the coalbed on safe and efficient coal extraction.

This report explains the advantages of geologic maps and fence diagrams in coal mining, and how the knowledge gained from such geologic investigations of mines can help control many underground problems.

## INTRODUCTION

In connection with a Bureau of Mines research program on methane control in coal mines, a series of geological surveys were completed in six mines: Three in the Pittsburgh coalbed and one each in the Upper Freeport, Pocahontas No. 3, and Lower Hartshorne coalbeds. The aim of these surveys was twofold: First, to study the overall geology of the coalbed area and second to use the resulting data to evaluate the influence of the geological characteristics of the coalbed on safe and efficient coal extraction.

Such geological investigations can help to alleviate many underground mining problems (3).<sup>3</sup> They can locate sand channels that may intersect and cut out the coal in advance of mining. They can determine trends of channels, making it possible to predict their probable course and influence on future mining operations.

Clay veins can be located and their trends sometimes established. Thus, the high gas concentrations that frequently occur with clay veins can be anticipated.

---

<sup>1</sup>Geologist.

<sup>2</sup>Physical science aid.

<sup>3</sup>Underlined numbers in parentheses refer to items in the list of references preceding the glossary of terms.

A detailed map of the rock above the coalbed can be used to determine the length of bolts needed to support the roof and to locate competent strata into which the bolts can be anchored. Because certain rocks deteriorate rapidly when exposed to air, such a map can also help to determine areas where rock is of the type in which experimental resin bolts can be used.

An abnormal accumulation of water can be evaluated, and in many cases related to fracturing of the roof rock, or to a fault zone which can also be responsible for high gas concentrations.

A detailed joint pattern in the area of the mine can be established and examined for a possible relation with the coal cleat directions and with joints present in the roof. Local deviations in joint and cleat directions can serve as a basis for modifying mining conditions. The cleat and joints can also supply information on roof stability. Excessive spalling of ribs when mining with the cleat direction can sometimes be corrected by a 45° rotation of this direction.

#### ACKNOWLEDGMENTS

The authors wish to thank the staffs of Bethlehem Mines Corp., Island Creek Coal Co., Eastern Associated Coal Corp., Helvetia Coal Co., and Howe Coal Co., without whose assistance a report of this type could not have been prepared. These companies all supplied data for the preparation of maps and met with Bureau personnel to discuss the company mines. Bureau personnel worked underground in all mines and were escorted by company officials to any of the sections of the mine requested.

#### GEOLOGIC MINE SURVEY TECHNIQUES

##### Maps of Mine Problem Areas and Their Preparation

Maps of problem areas within mines are a necessary preliminary to an underground survey. Such maps are sometimes supplied by the company. They may show (1) zones of roof fall, (2) zones of excessive spalling of ribs, (3) zones of channel washouts, (4) zones of abnormal concentrations of clay veins, and (5) zones of excessive accumulations of water and gas. Very few maps show clay veins, sandstone channels, and so forth, but many companies do have maps of zones of bad roof or areas where a specific feature occurs with an abnormally high frequency.

When company maps were not available or were inadequate, Bureau personnel constructed their own maps. The majority of all maps were prepared from data taken from the corehole logs supplied by the company. The accuracy of the resulting data relates to the accuracy of the driller's log. Coreholes should be spaced at not more than 3,000 feet and when possible should be drilled on a suitable grid system. Interpretation of the driller's logs can be a problem, and it is helpful if the same driller has logged most of the holes, although when a number of holes have been drilled over a period of years, this may not be possible. Corehole logs can be used to prepare a variety of maps, including isopach maps of given intervals, structure maps, percent maps of rock

units, lithologic frequency maps, lithofacies maps, and fence diagrams. The analysis of inherent problems is dependent upon such maps.

### Underground Surveys

The geologists planning an underground survey first consult with company personnel as to the specific problems that may exist in the mine. Once underground, the geologic features of particular interest to the geologist himself are (1) orientation of coal cleats, (2) occurrence of clay veins, (3) occurrence of faults, (4) sandstone-or claystone-filled channels, (5) abnormally high concentrations of gas and water, and (6) roof falls.

Coal cleat measurements are used to determine the face and butt orientations of individual mines. The cumulative information is used for correlation with local and regional structure (4).

Clay veins or sedimentary dikes are a particular problem in mining because they may intersect so as to form isolated blocks of coal that may act as gas cells. When a continuous miner cuts through such a clay vein, the sudden rush of methane into the working area can greatly increase the fire and explosion hazard. Clay veins are also areas of mine roof instability. In the Pittsburgh coalbed, at sites where there are large numbers of clay veins, they appear to be controlled by structure, but additional evidence is needed to confirm this.

Where sandstone channels are encountered in mining, they must be penetrated by driving rock tunnels by drilling and blasting. This is a time-consuming operation that interrupts coal production. In particular, the plough-type longwall miner requires an area relatively free of sand channels and clay veins, while the shearer type may be able to mine through these areas without too much trouble.

Faults may displace a coalbed and also create areas of abnormally high gas and water accumulation. In many mines faults are hard to detect because they are of the strike-slip type, with no vertical offset. Moreover, the cleat readings near a fault can differ greatly from the overall pattern of the area. A rotation of local cleat direction has been detected to 2,000 feet from the fault itself.

### Surface Fieldwork

Generally a quick check is also made of the surface geologic features around the mine. Joints in the rocks are measured following guidelines of Lahee (2). Surface areas directly above underground problem areas are of special interest. When faults are encountered underground, the trend is plotted and its expression on the surface is sought.

### Documentation

All available aerial photographs, IR photographs, SLAR mosaics, and photo index sheets of the area were examined for linears. The State geological



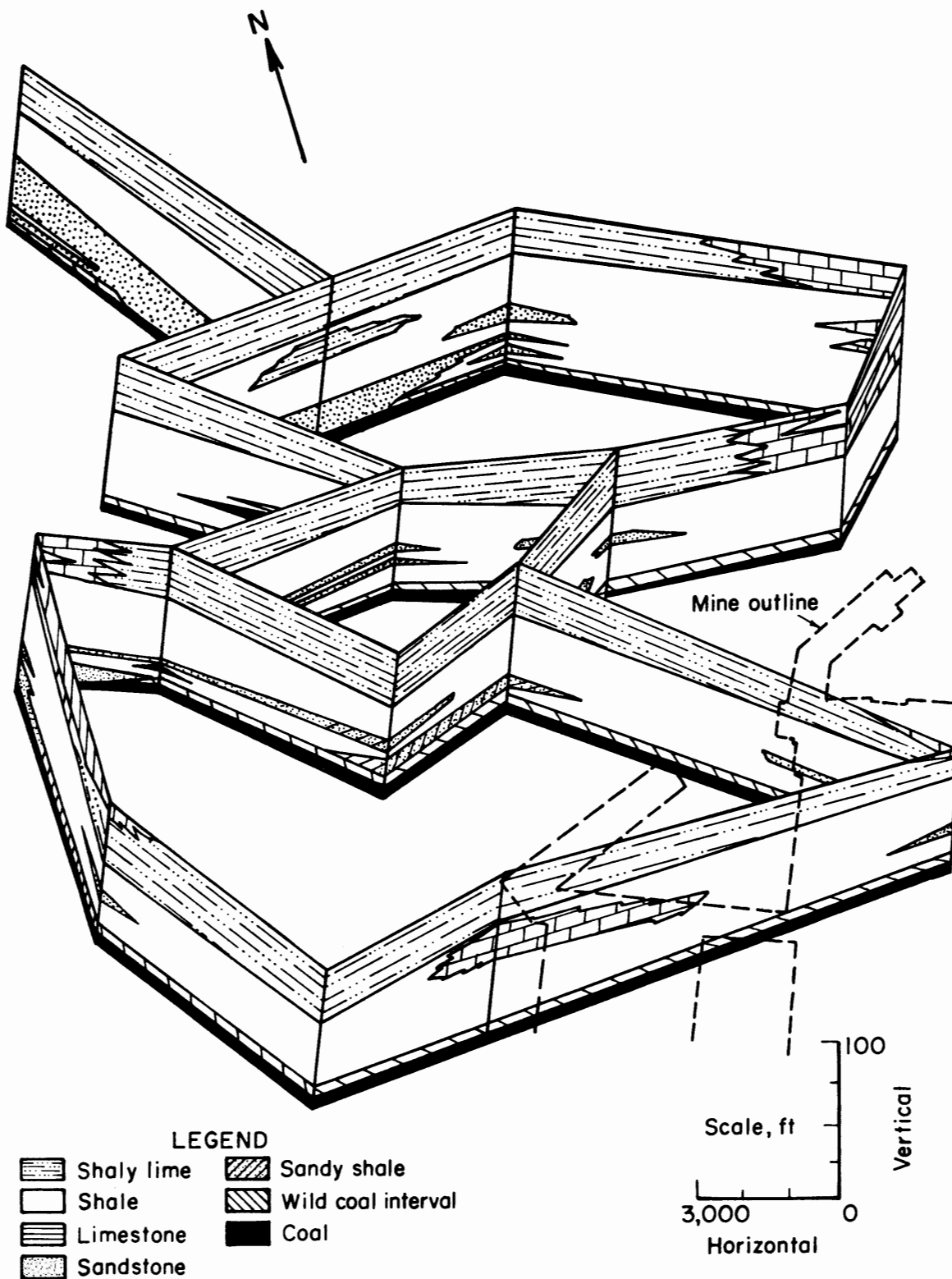

FIGURE 1. - Fence diagram of strata above the Pittsburgh coalbed, Marianna No. 58 mine.

surveys were contacted for any additional information on the study area, and the literature was checked for pertinent information.

SURVEYS OF SIX MINES AND THEIR PROBLEMS

Surveys were conducted in the following mines: Marianna No. 58 and Somerset No. 60, Bethlehem Mines Corp.; Lucerne No. 6, Helvetia Coal Mining Co.; Beatrice, Island Creek Coal Co.; Federal No. 2, Eastern Associated Coal Corp.; and Howe, Howe Coal Co. Each mine presented different structural problems.

Marianna No. 58 Mine

The mine is located near Ten Mile, Pa. off Interstate Highway 79. It operates in the Pittsburgh coalbed. The survey, conducted in September 1972,

showed the main directions of the cleat to be N68°W (face) and N28°E (butt). Mining is by the room-and-pillar method, and average methane emission per day is 2.3 MM ft<sup>3</sup>. They are now mining at 45° to the cleat direction because of excessive spalling of the pillars and some roof control problems when mining parallel to the cleat directions. This change in direction has greatly reduced the amount of spalling and has caused no slow-down in mining.

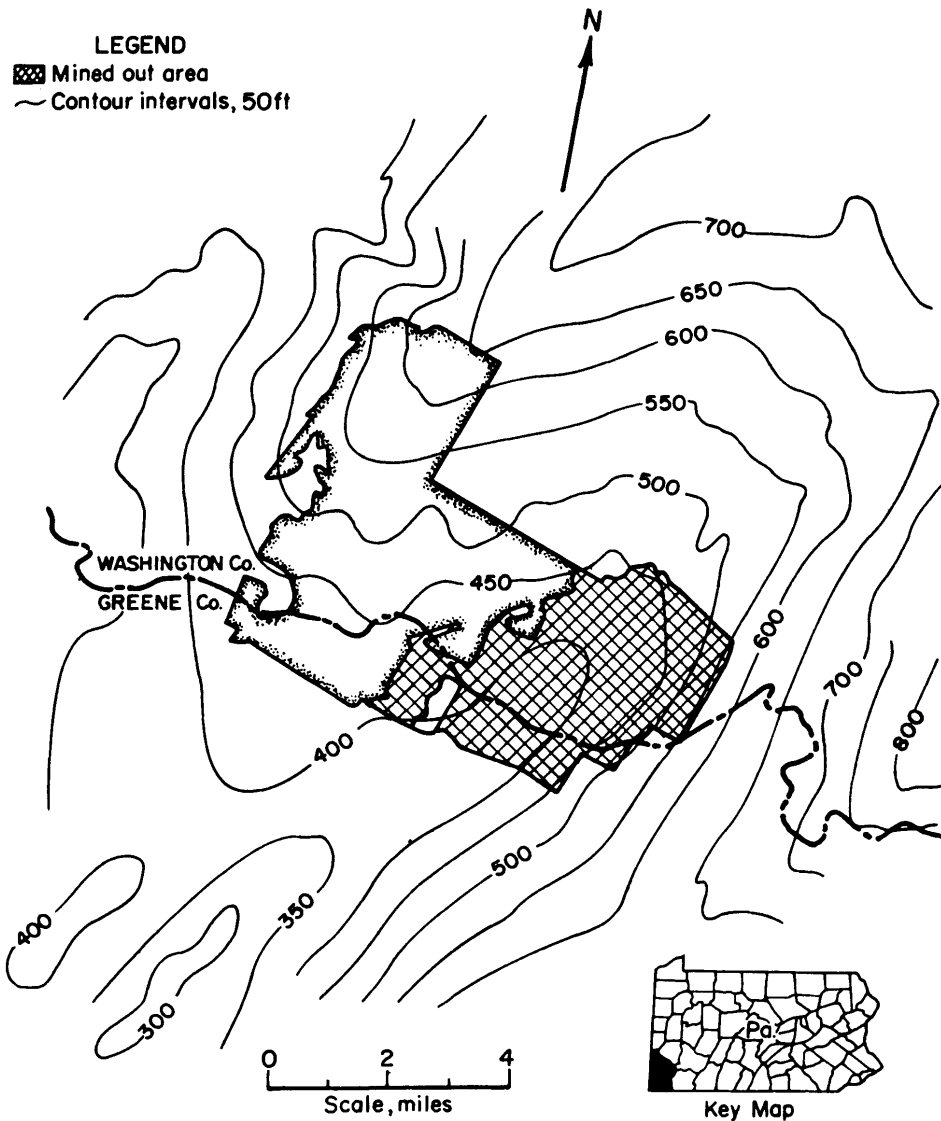

FIGURE 2. - Structure drawn on base of the Pittsburgh coalbed, Marianna No. 58 mine.

A panel (see glossary) or fence diagram (fig. 1) and a structure map (fig. 2) of the property were prepared. A topographic map was overlaid on the mine map to correlate the

topography over the mine with problems encountered underground. A number of falls seem to align with and occur under streams in the area. Because most streams form along zones of weakness, it was felt that this zone parallel to the stream would be a problem whenever it was encountered (fig. 3). Research currently underway further supports this idea. Another zone of falls associated with abnormally high gas emissions was found where the cover changed abruptly from 300 to 700 feet. This was attributed tentatively to differential overburden pressures.

The major problem throughout the mine was the wild coal interval formed by alternating thin bands of claystone and coal that overlay the coal. The interval ranged in thickness from 1 to 9 feet and could not support itself. The company was using roof bolts with a minimum length of 6 feet and a standard length of 7 feet; these were adequate where the wild coal was less than 6 feet thick. An isopach map of the wild coal interval (fig. 4) showed where this unit is greater than 6 feet thick; longer roof bolts would be needed in these areas.

A section affected by clay veins was carefully mapped. Comparison with a structure map of the area revealed the presence of a syncline with the clay veins located along its axis (fig. 5). As some of the mine entries had

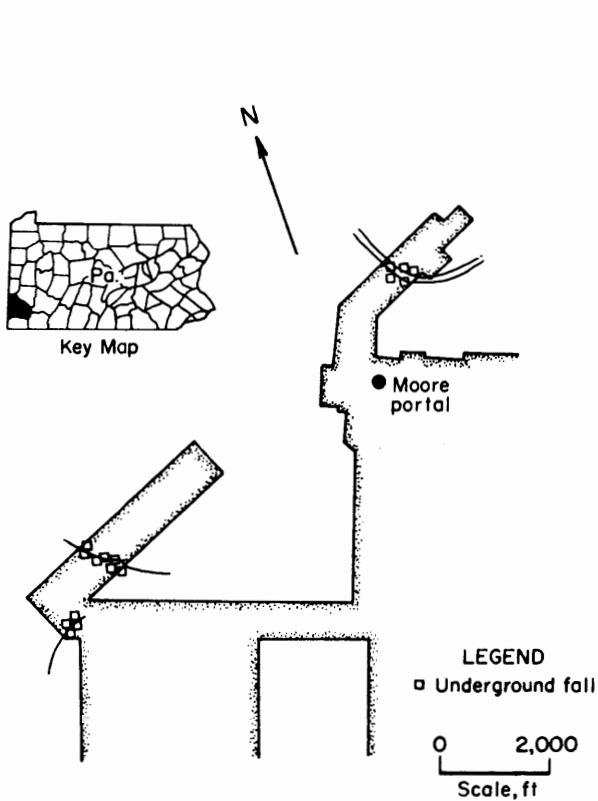

FIGURE 3. - Overlay of mine streams on surface related to underground falls.

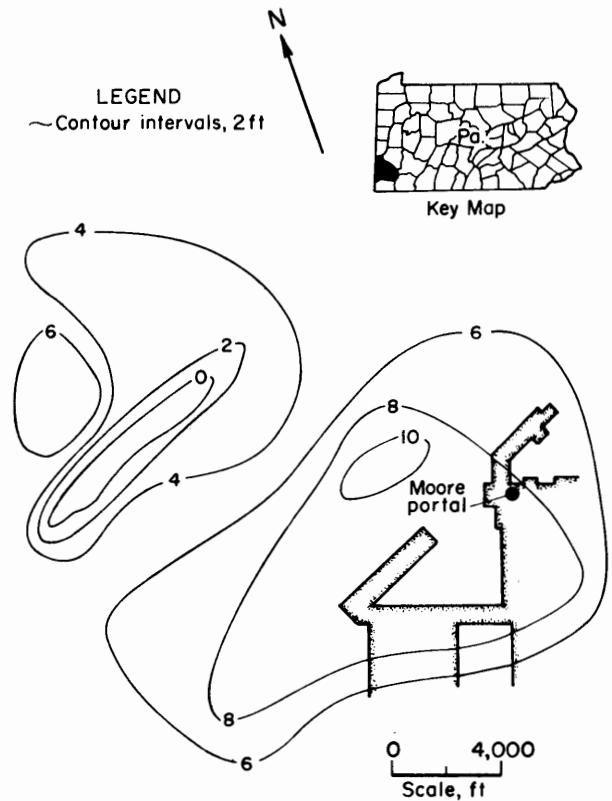

FIGURE 4. - Isopach of the wild coal interval over the Pittsburgh coalbed in the Marianna No. 58 mine.

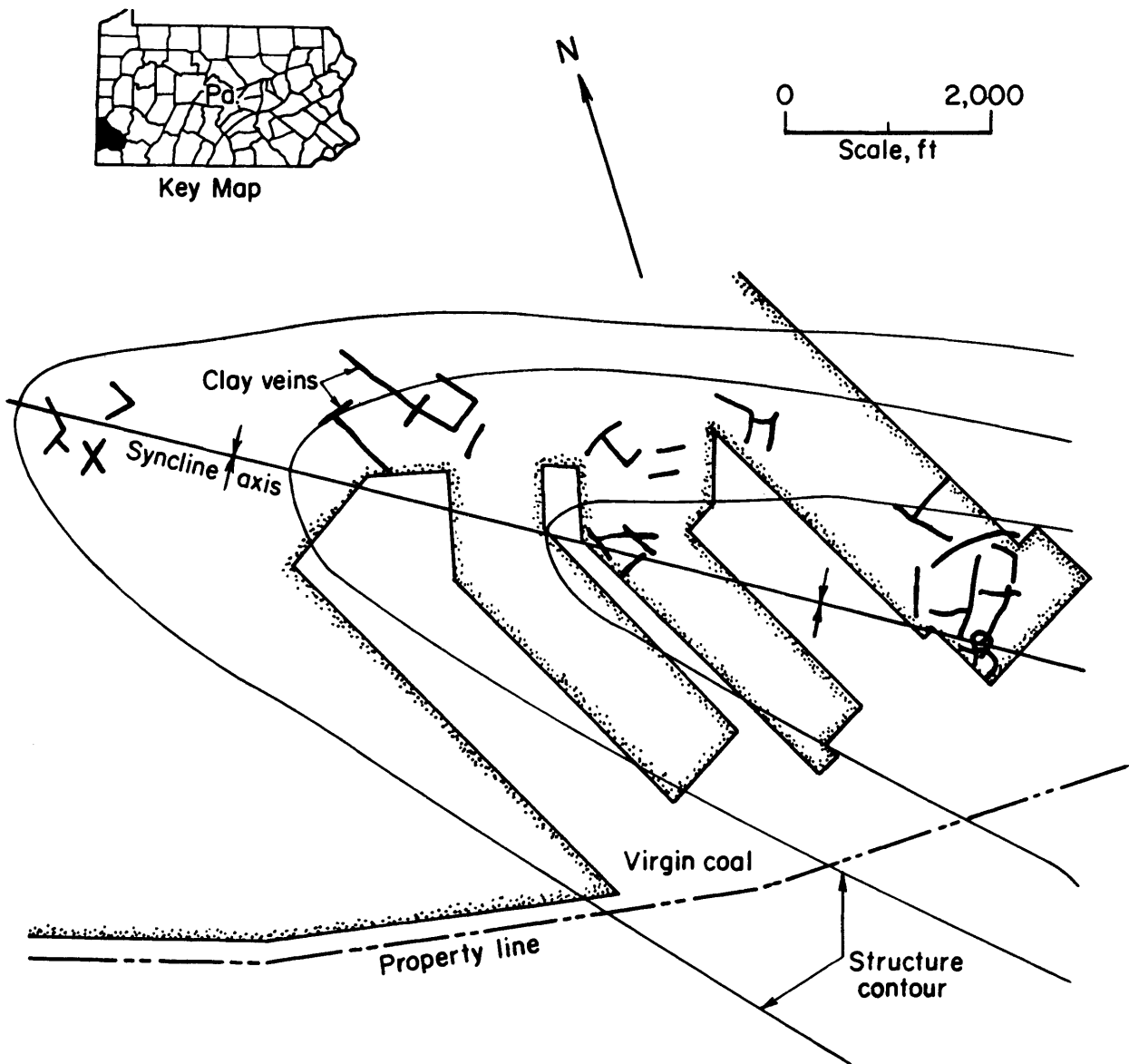

FIGURE 5. - Location of clay veins in the Marianna No. 58 mine.

already passed through the axis and were now encountering few clay veins, it was anticipated that when mining approached the axis of this syncline the occurrence of clay veins would increase.

Joints were measured on the surface (fig. 6) to evaluate correlations between the principal fracture directions underground and those on the surface. Correlation was excellent.

#### Lucerne No. 6 Mine

The mine is located approximately 2 miles southwest of Homer City, Pa., and operates in the Upper Freeport coalbed. A geological survey was conducted

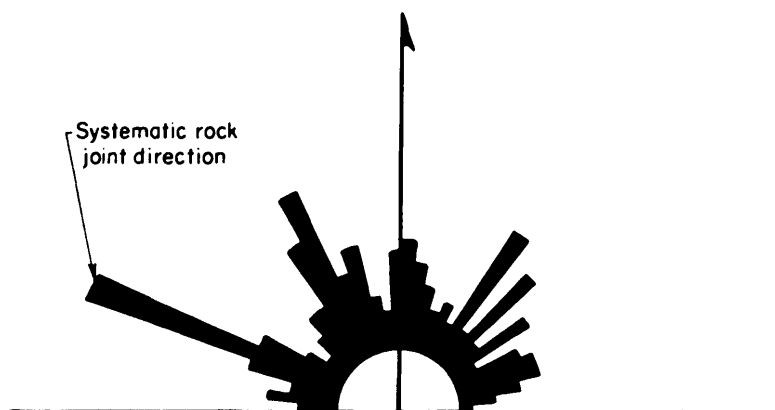

FIGURE 6. - Surface joint data above the Marianna No. 58 mine.

They are low-angle thrust faults which offset the coal only a few feet along the fault plane (fig. 8). They affected both coal and roof rock, but did not appear to disturb the floor rock. These faults are not the result of sedimentary slumping. They occur at regular intervals and can be traced to the surface. When encountered by mining, the fault zones emitted large quantities of gas and water. There is insufficient evidence to conclude that all the faults observed were laterally connected. It is more probable that they were a group of small thrust faults occurring within a narrow thrust zone.

Aerial photographs were analyzed for linears. Two groups were identified,  $N47^{\circ}E$  to  $N65^{\circ}E$  and  $N25^{\circ}W$  to  $N56^{\circ}W$ , and interpreted as the regional joint pattern. In addition, poorly developed groups of linears striking  $N13^{\circ}W$  to  $N05^{\circ}E$  were present locally in 500-foot-wide bands at 6,000-to 7,000-foot intervals. The first of these lies about 2,000 feet west of the fault encountered in the West Mains. This may be the surface expression of the underground fault. If so, then additional faults or water zones could be expected as mine workings progress further to the west.

A structure map (fig. 9) of the base of the Upper Freeport seam, drawn from corehole data, shows a synclinal structure with axis bearing approximately  $N30^{\circ}E$  and passing through the easternmost section of the mine. The largest part of the mine workings and reserves lies in the western limb of the syncline. The data points were too widely spaced to determine more than the gross structure of this area.

The core logs were studied with particular attention to the transition zone between the thick and normal Upper Freeport coal. The thick coal is east of the transition zone. This local thickening, limited in extent, is due to deposition. The thick Freeport coal is split from the main coal by a wedge of shale that thickens to the southwest. The general strike of the transition

in March 1972. Cleat measurements showed a uniform pattern with the face cleat striking  $N56^{\circ}W$  and the butt cleat  $N32^{\circ}E$ . The dip was essentially vertical. The spacing of the face cleat, on the order of an inch, appeared to be uniform throughout the mine, except near the fault exposures, where the cleat was more closely spaced. The most significant geologic features of the mine were the fault exposures (fig. 7).

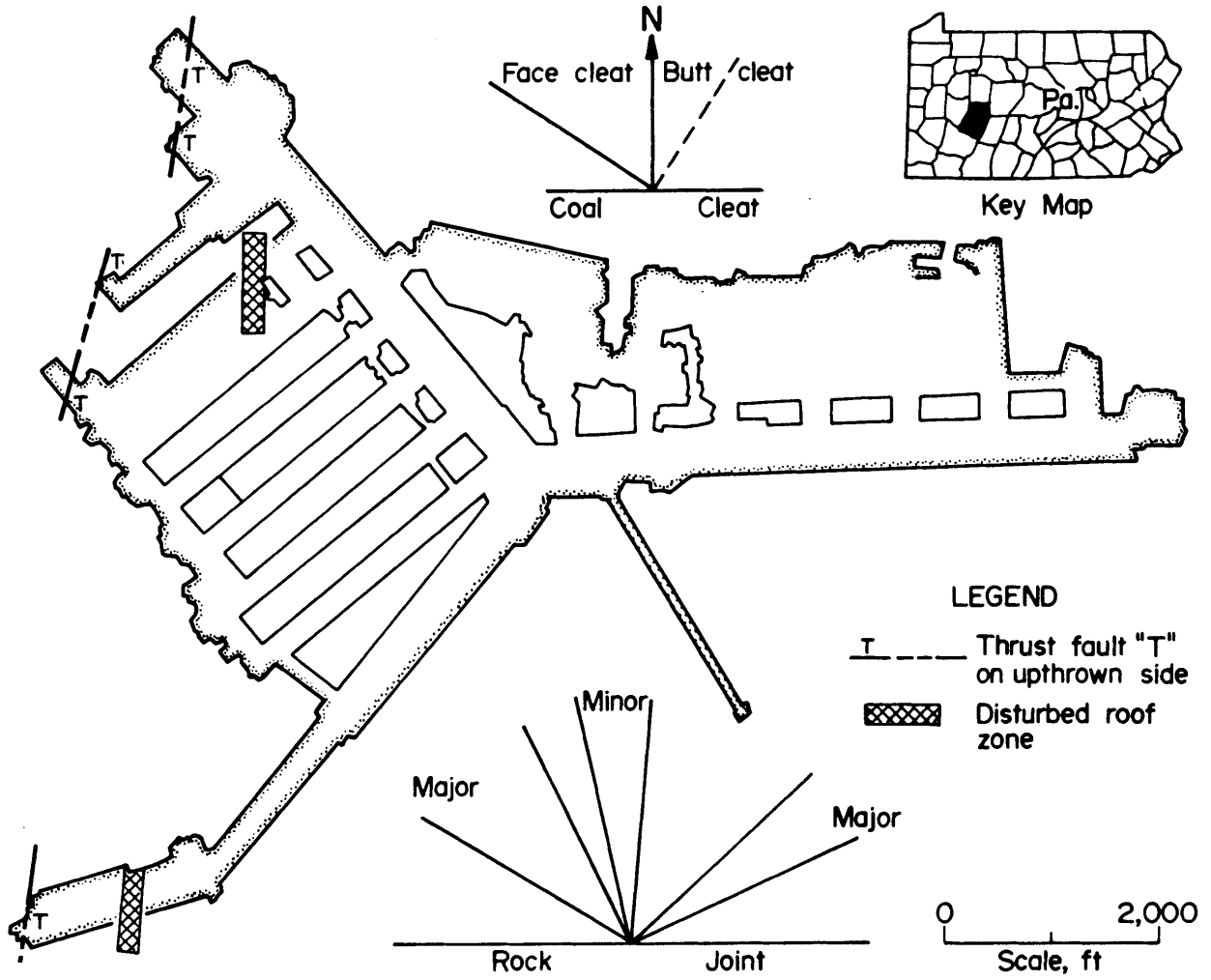

FIGURE 7. - Fault exposure at Lucerne No. 6 mine.

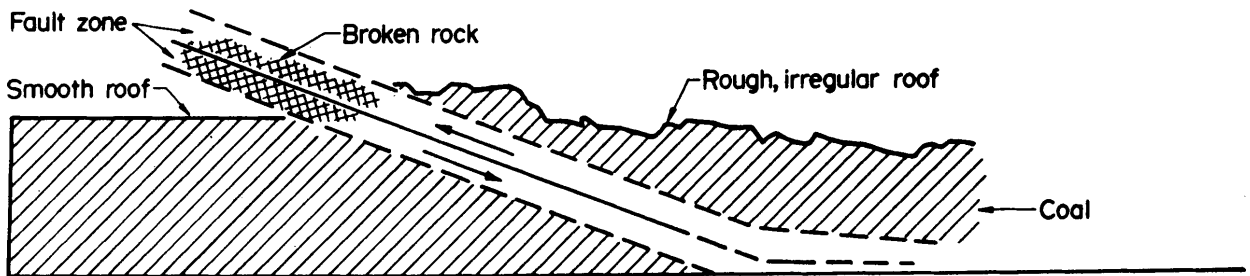

FIGURE 8. - Generalized sketch of typical thrust fault exposure at the Lucerne No. 6 mine.

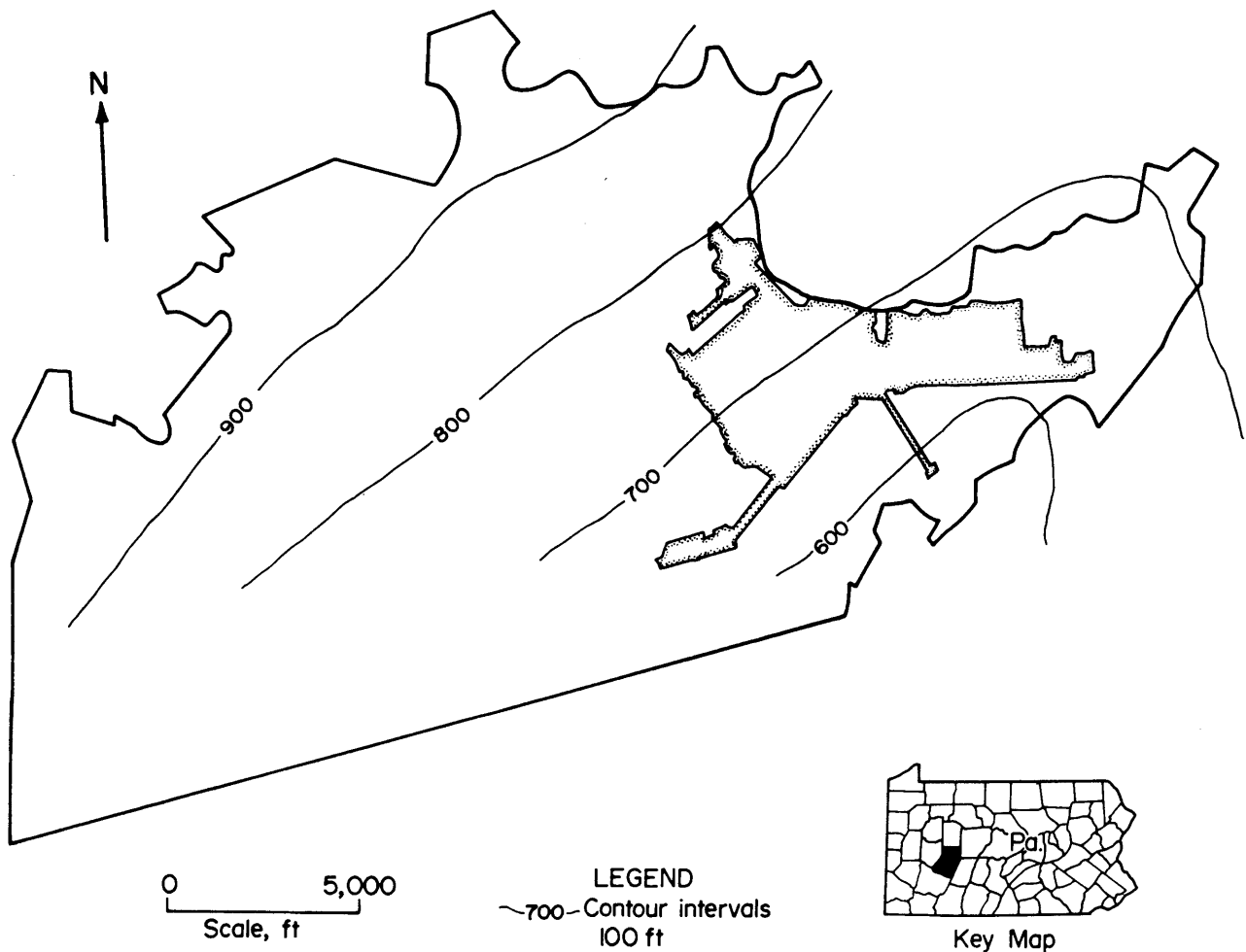

FIGURE 9. - Structure map drawn on the base of the Upper Freeport coalbed, Lucerne No. 6 mine.

zone is  $N30^{\circ}W$ . This is illustrated by the fence diagram (fig. 10) constructed from the core log descriptions of the first 40 feet of rock above the coal. Within this interval, sandstone is present throughout almost the entire area. This sandstone is separated from the coal locally by shales and sandy shales. Its large lateral extension makes it a probable water and gas reservoir. Thick sandstone directly overlying coal often exhibits deformations due to compaction which appears locally to be thrust faults, but this was not the case here. The core logs were examined for records of broken rock, but they yielded no pattern indicative of possible fault zones.

#### Somerset No. 60 Mine

The mine is located several miles west of Ellsworth, Pa. It is working in the Pittsburgh coalbed and produces  $1.5 \text{ MM ft}^3$  of gas per day. A geological survey was conducted in February 1973.

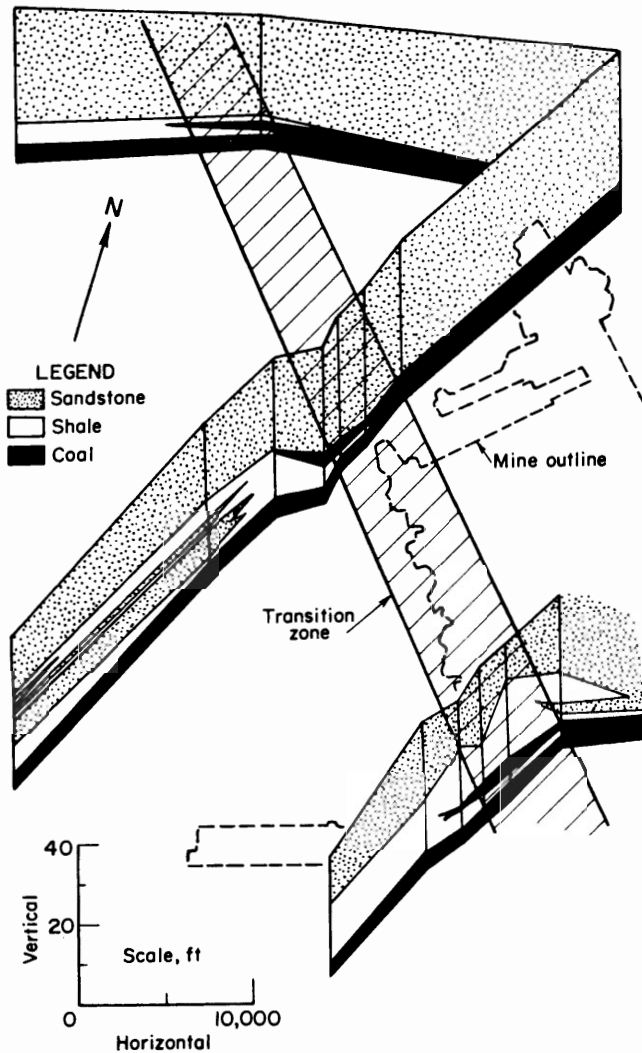

FIGURE 10. - Fence diagram of strata above the Upper Freeport coalbed, Lucerne No. 6 mine.

that mining is preceding down the northwest flank of the Amity anticline towards a syncline (fig. 11). Water is reportedly accumulating at the face of entries being driven to the northwest. This condition may be expected as long as the entries dip into the working face. Once they advance on the axis of the syncline, the floor will dip away from the face and water should no longer accumulate there.

A fence diagram of the 40 feet of strata immediately above the main bench of the Pittsburgh coalbed (fig. 12) in the 84 field directly to the west of the present mining was constructed, because of the occurrence of sand channels cutting out coal in the western part of the active mine workings. The data were taken from the company core logs. There was an abrupt change in this interval from north to south, with shale predominating in the north and sandstone in the south. The abruptness of this change is shown by drill

The cleat system is orthogonal; the main direction of the cleat is  $N57^{\circ}W$  (face) and  $N30^{\circ}E$  (butt). The coal cleats are well developed with spacing ranging from 1 to 6 inches. Mining had been parallel to the cleat, but at present is  $45^{\circ}$  to the previous workings which gives a more stable roof.

The immediate roof is generally coal because a slickensided claystone or draw slate, generally 12 inches or less, overlying in the coal, is removed during mining, leaving the stable rider coal. Roof falls show the weak strata to be either micaceous sandstone with thinly interbedded shale, or alternating coals and slickensided claystones.

The measured rock joint orientations were between  $N57^{\circ}W$  and  $N75^{\circ}W$ , corresponding roughly to face cleat orientation.

The structural map of the area, based on the Pittsburgh coalbed, shows



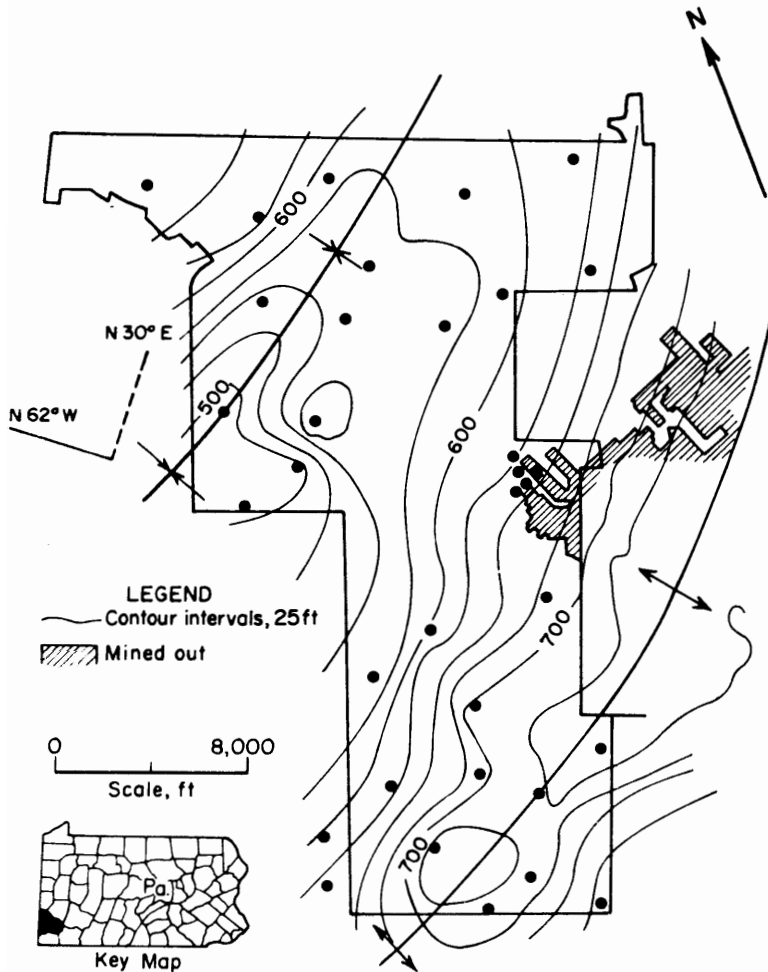

FIGURE 11. - Structure map drawn on the base of the Pittsburgh coalbed at Somerset No. 60 mine.

holes TH1 and TH2 (fig. 13) drilled 620 feet apart. The change in lithology is due to stream erosion of strata that were originally deposited over the coalbed in the same way as in the northern part of the area. Subsequently, sand was deposited in these erosion channels. The depth of erosion varied from place to place so that the coal is only removed locally. The thinner the interval between the coalbed and the overlying sandstone, the greater the probability that erosion will affect the coalbed. A map based on present drill hole data shows areas where cutouts may be expected (fig. 14).

Overlying the main bench (mined portion) of the Pittsburgh coalbed is an interval of variable thickness composed of alternating slickensided claystones and coals (fig. 15). The interval has very little strength and can fall, causing gas emissions as well as haulage

problems. Most mines prefer to anchor roof bolts in the more competent rock above this interval. Figure 15 can be used in a general way to determine the minimum length of bolt that would be necessary to bolt through the interval in any given area.

The geological data from core holes spaced more than 3,000 feet apart are difficult to correlate. More closely spaced drilling is necessary to delineate the northern limit of the sandstone. This zone is of particular importance in mining because it represents the northern limit of stream erosion of the strata overlying the Pittsburgh coalbed. Zones of abrupt lithology change can also coincide with areas of unstable roof, high gas emission, and related mining problems.

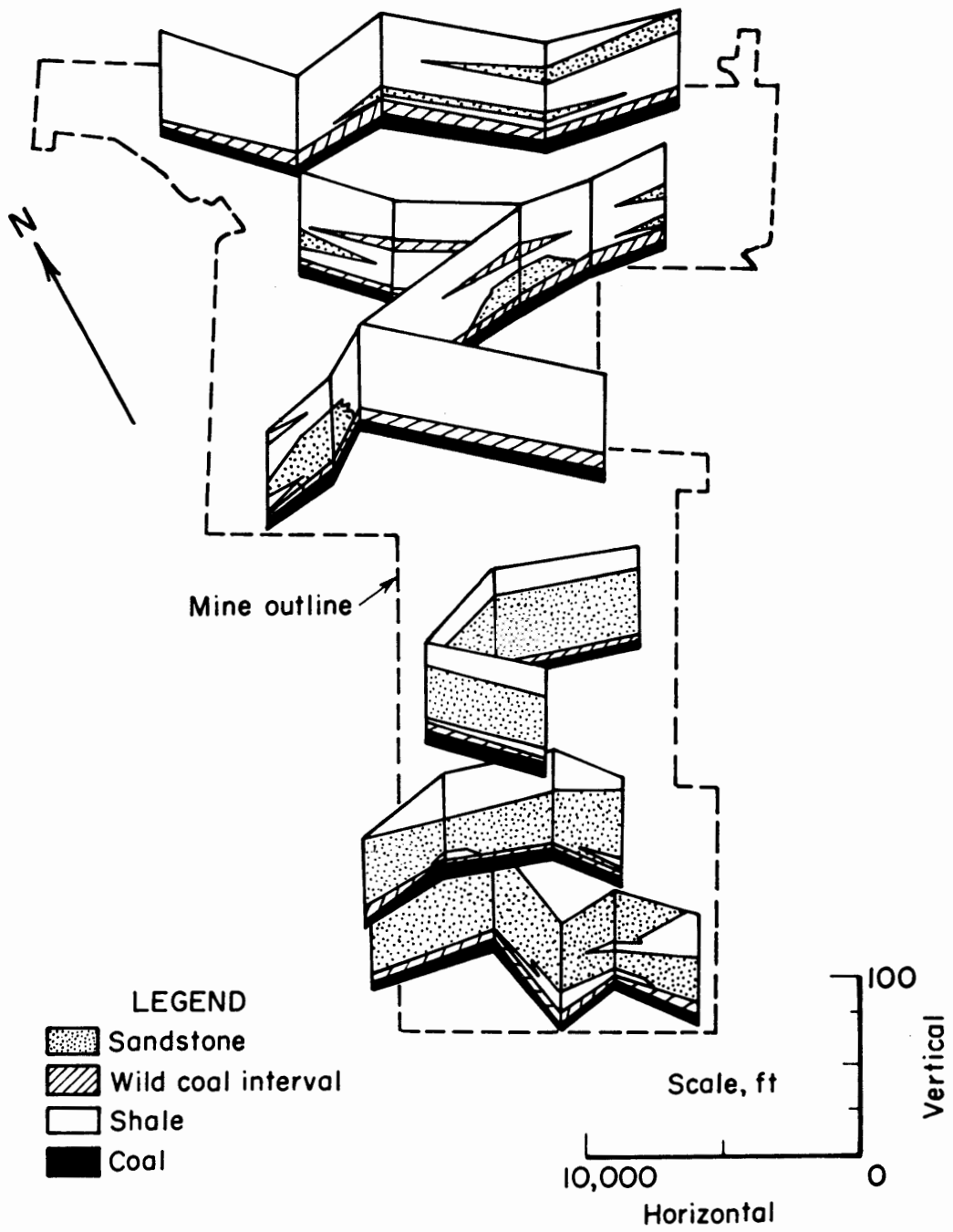

FIGURE 12. - Fence diagram of strata above the Pittsburgh coalbed, Somerset No. 60 mine.

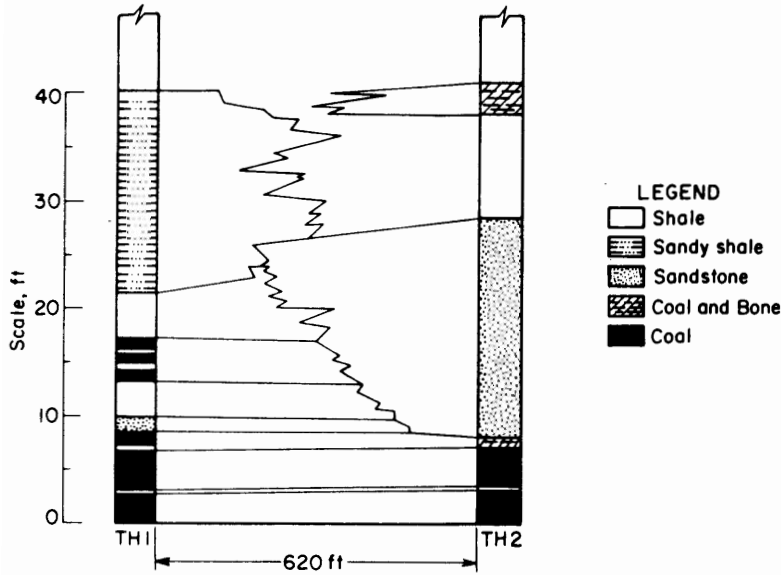

FIGURE 13. - Lithologic change between drill holes TH1 and TH2.

Federal No. 2 Mine

The mine is located in the Batelle district of Monongalia County, W. Va., where the Pittsburgh coal-bed averages 7-1/2 to 9 feet thick. The mine produces an average of 8.1 MM ft<sup>3</sup> of gas per day. The rocks above the coal are sandstones, sandy shale, shales, limestones, and coals. The present mine outline is shown in figure 16.

In August 1970, a geological reconnaissance and a fracture survey were made of the mine. The company had no topographic map showing the location of

the coreholes. The drillers' log data were plotted on an overlay of the

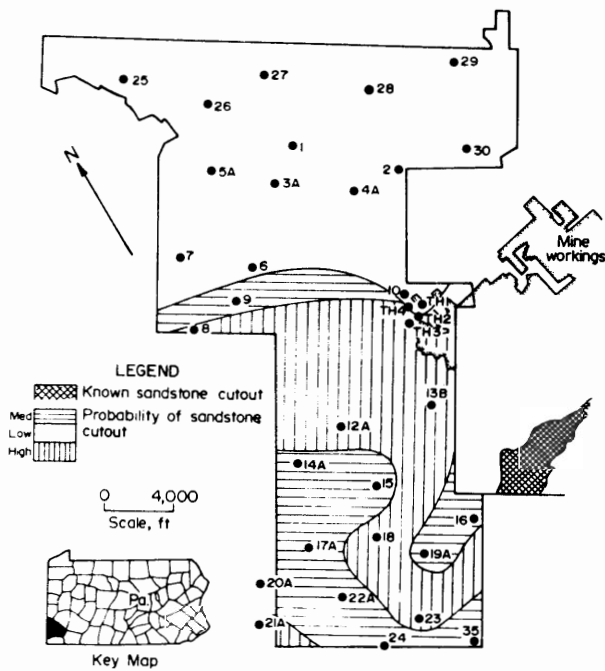

FIGURE 14. - Location of possible sand channel washout, Somerset No. 60 mine.

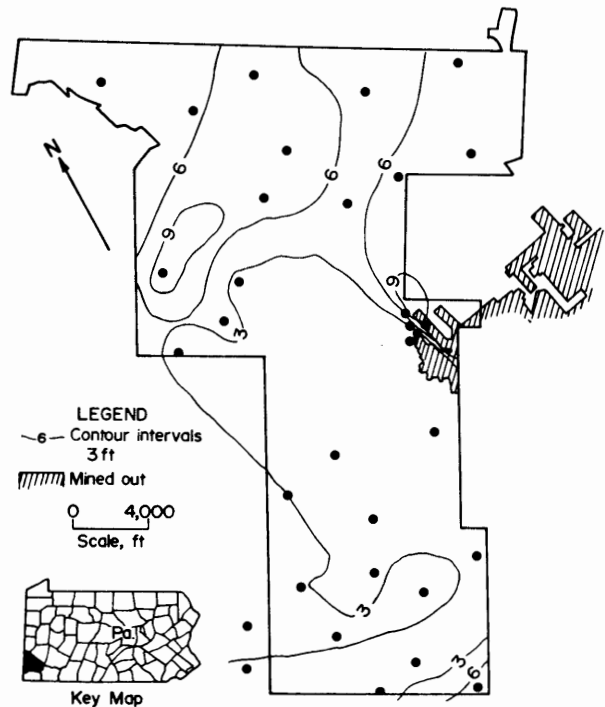

FIGURE 15. - Isopach of the draw slate unit above the Pittsburgh coalbed, Somerset No. 60 mine.

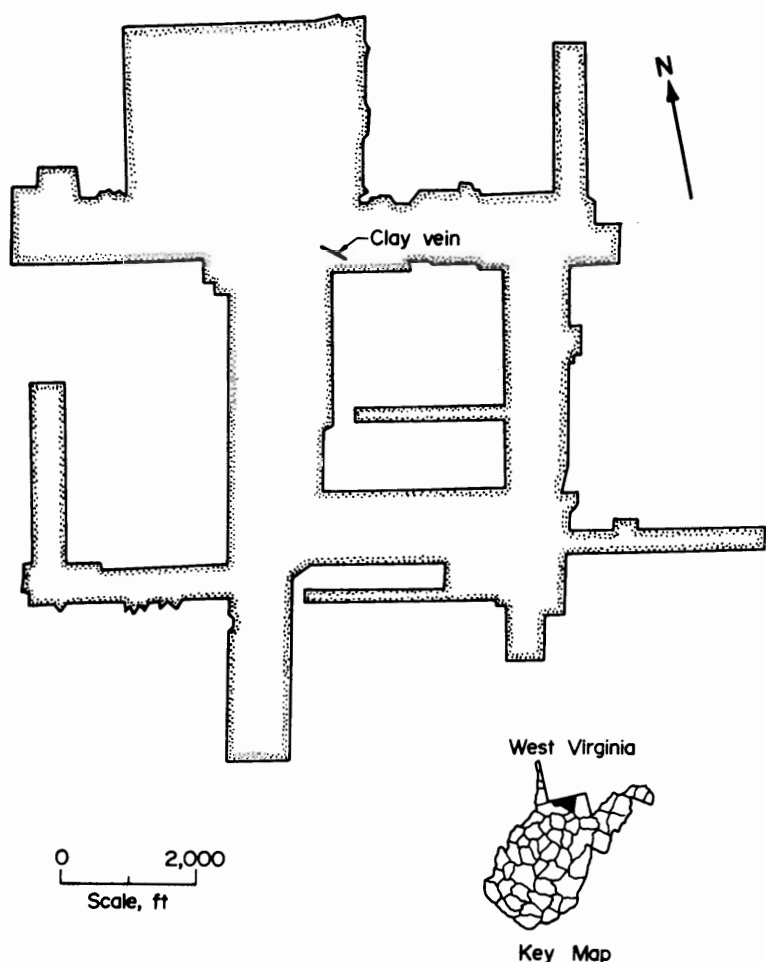

FIGURE 16. - Outline of the Federal No. 2 mine.

Analysis of the cleat data showed uniformity within the present mine development. The face cleat strikes  $N68^{\circ}W$ , the butt cleat strikes  $N22^{\circ}E$ , and the dip is essentially vertical. A series of slump fractures were observed in the East Bleeder, and one clay vein (fig. 16) approximately 150 feet long extends from the roof 2 feet into the coalbed near the mouth of the East Mains. The slump feature may be due to some local channel erosion or to differential compaction. Geologically related mining problems are methane emissions and roof instability, which go hand-in-hand in many instances. Driving north-south tends to develop high gas by intersecting face cleats. Roof control problems are probably due to bolting into the incompetent alternating coals and shales (draw slate interval).

Blacksville and Mannington 15-minute quadrangles, using the drillers' location descriptions. The surface elevation for each hole was roughly determined from the contours on the topographic maps.<sup>4</sup>

An isopach of the interval between the Pittsburgh and Redstone coalbeds showed a thinning to the southwest; the interval thickness ranged from 22 to 42 feet.

A structure map (fig. 17) shows the axis of the Waynesburg syncline passing through the western extremity of the mine property. The Pittsburgh coalbed dips generally west-northwest towards the axis. The Belle Vernon anticline and the Whitely syncline are well developed northeast of the mine area. In the central portion of the mine property, there is a local upwarping which interrupts the gentle westerly dip.

<sup>4</sup>The drillers' location descriptions were general, and with the high relief in the area, it is possible for elevations to be in error by as much as 50 feet.

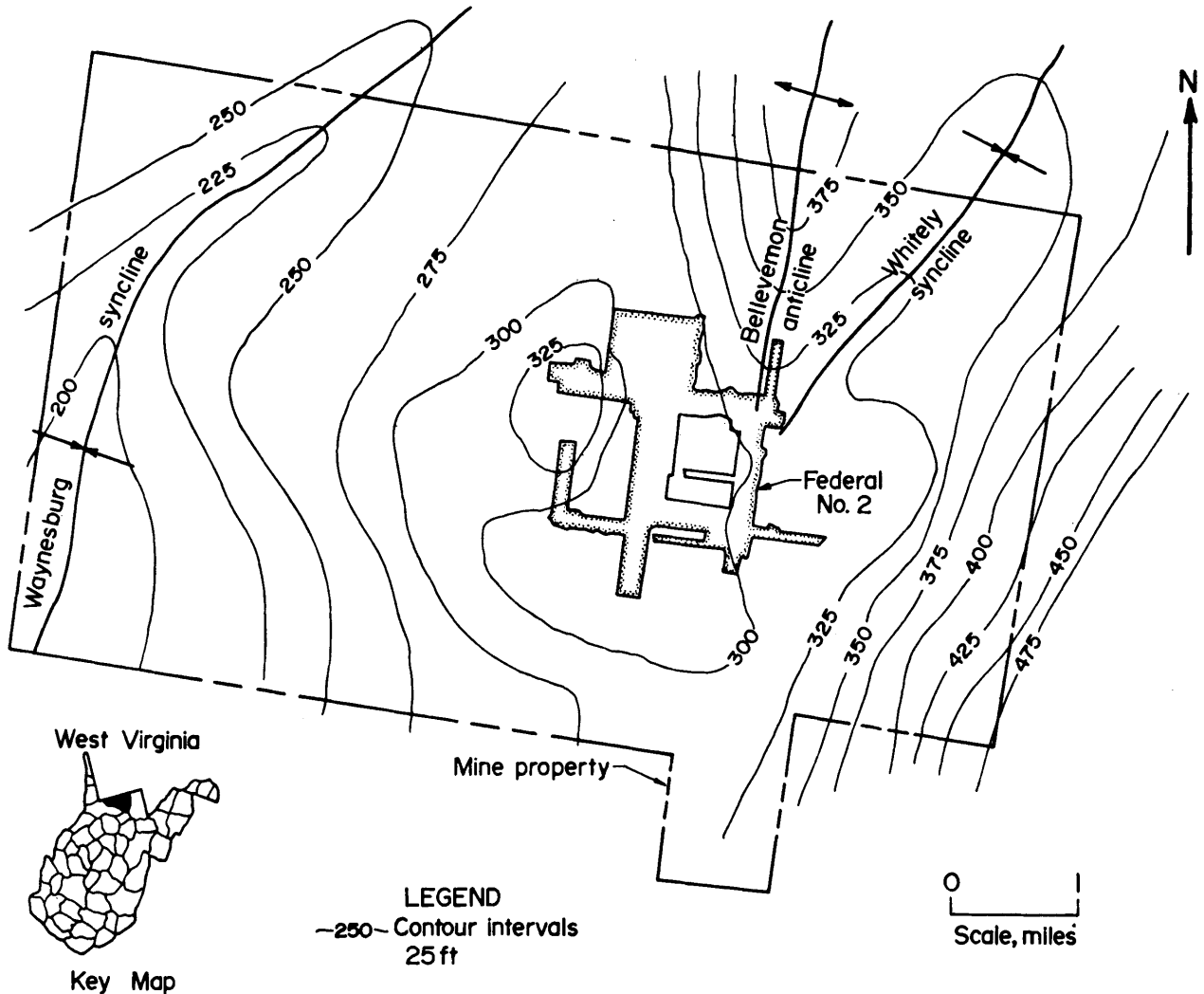

FIGURE 17. - Structure map drawn on the base of the Pittsburgh coalbed, Federal No. 2 mine.

#### Howe Mine

The mine is located 6 miles south of Poteau, La Flore County, Okla. It is on the south side of the Arkoma Basin, which is described as a synclinorium. Figure 18 shows the generalized structure of the Lower Hartshorne coalbed and the two major structures present in the area--the Howe anticline and Poteau syncline--with the cleat orientations. The Hartshorne coalbed consists of an upper bench averaging about 32 inches in thickness, below which there is a shale parting up to 24 inches thick, followed by several thin layers of usually impure coal laminated with black, carbonaceous shale.

A panel diagram (fig. 19) constructed from core logs of the test holes drilled by the company shows that the immediate roof over most of the property is sandstone. According to Bureau research, the absence of shale between the coal and sandstone greatly increases the probability of sandstone channels.

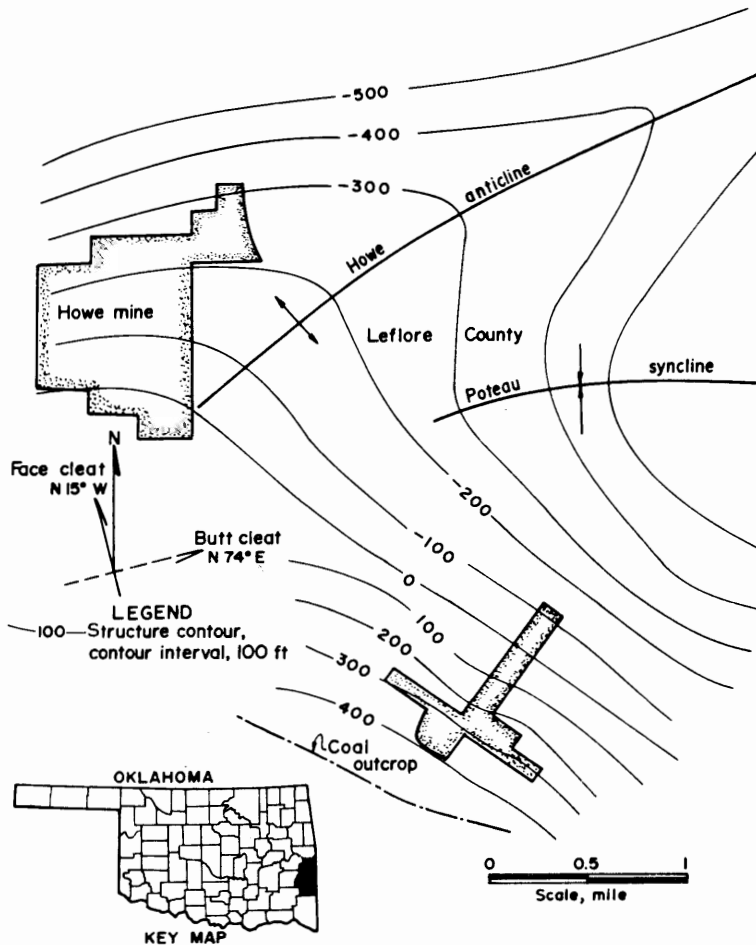

FIGURE 18. - Structure map drawn on the base of the Lower Hartshorne coalbed, Howe mine.

joint direction in the roof and floor rocks in the mine,  $N23^{\circ}W$ . This is parallel to one mode of the bimodal face cleat. The surface rocks have two joint directions approximately  $90^{\circ}$  apart,  $N15^{\circ}W$  and  $N72^{\circ}E$ . These directions correspond closely with face and butt cleats in the Hartshorne coalbed.

The inclination of the coalbed makes it very difficult to work. Where the coal is overlain by sandstone, the bed is undulatory so that the continuous miner must be backed up and floor rock taken to obtain a proper angle of attack. The presence of shale roof to the west indicates that the undulation of the coalbed may disappear in this direction.

Water is a nuisance but does not affect production significantly. It appears to enter the sands from older mine workings and the outcrop, and migrate down dip to the present mine workings. This has been alleviated by pumping out the abandoned workings up dip. Possibly where the immediate roof is solid shale, the water influx will be less, but it is believed that anything short of sealing the roof will not eliminate the water.

The coalbed within the mine dips about  $7^{\circ}$  in a northerly direction. Locally, dips between  $2^{\circ}$  and  $12^{\circ}$  have been recorded within the mine. The minor apparent folding is probably due to differential compaction between the sands and shales that forced the Lower Hartshorne coal to conform to the irregular shapes of the sand channel bottoms, where they come in contact with the coalbed. Where the coalbed and sandstone were separated by sufficient shale, the shale acted as buffer and the coalbed was not deformed.

Coal cleat orientations were measured throughout the mine, as were roof and floor rock joints. Orientations of rock joints were measured at surface outcrops. The coal (fig. 18) displayed a bimodal face cleat  $N15^{\circ}W$  and  $N25^{\circ}W$ , and a single butt cleat approximately perpendicular to these at  $N74^{\circ}E$ . There was only one primary

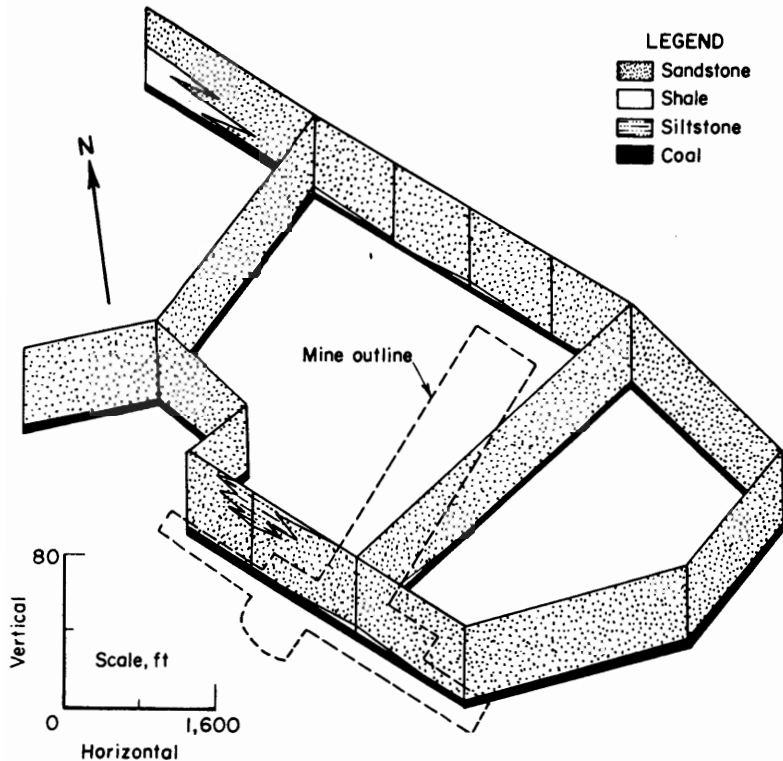

FIGURE 19. - Fence diagram of the strata above the Lower Hartshorne coalbed, Howemine.

Province and less than 15 miles northwest of the Pine Mountain overthrust block. It is operating in the Pocahontas No. 3 coalbed and produces an average of 13.2 MM ft<sup>3</sup> of methane per day. A geologic survey was conducted in April 1973.

A shear fault (fig. 20) of 2 to 18 feet vertical displacement, but unknown horizontal displacement, was encountered within the mine, trending northwest-southeast at 145° and 155° alignment and dipping 60° to the southwest. Slickensides on the faulted rock surfaces were parallel to bedding, indicating that the major movement was horizontal rather than vertical. Further evidence from surface exposures, together with data from mine operations in seams above the Pocahontas No. 3, permitted the delineation of a strike-slip fault at least 9 miles long. A more detailed study of the area using side-looking airborne radar (SLAR) was done by Elder (1).

Cleat measurements showed face cleat trending N18°W and butt cleat trending N67°E. On the northeast side of the fault, a rotation of the cleat (fig. 21) indicated that this side had acted as a buttress against which the southwest block moved.

The Arkoma Basin is a prolific gas producer. Practically every anticlinal structure penetrated by drilling has produced gas from porous and permeable strata. This would indicate that the gas problem in the Howe mine is not a simple one, and Howe is a gassy mine. Most of the gas appears to come from the coal, but there is occasional bubbling from the floor. Until detailed measurements can be made, both roof and floor rocks must be considered as possible gas producers.<sup>5</sup>

#### Beatrice-Pocahontas Mine

The mine is located in Buchanan County, Va., in the gently folded Allegheny Plateau Province, approximately 8 miles northeast of the Valley and Ridge

<sup>5</sup>This survey was made in March 1971. This mine has since closed down, but there is a strong possibility that it will reopen in 1975.

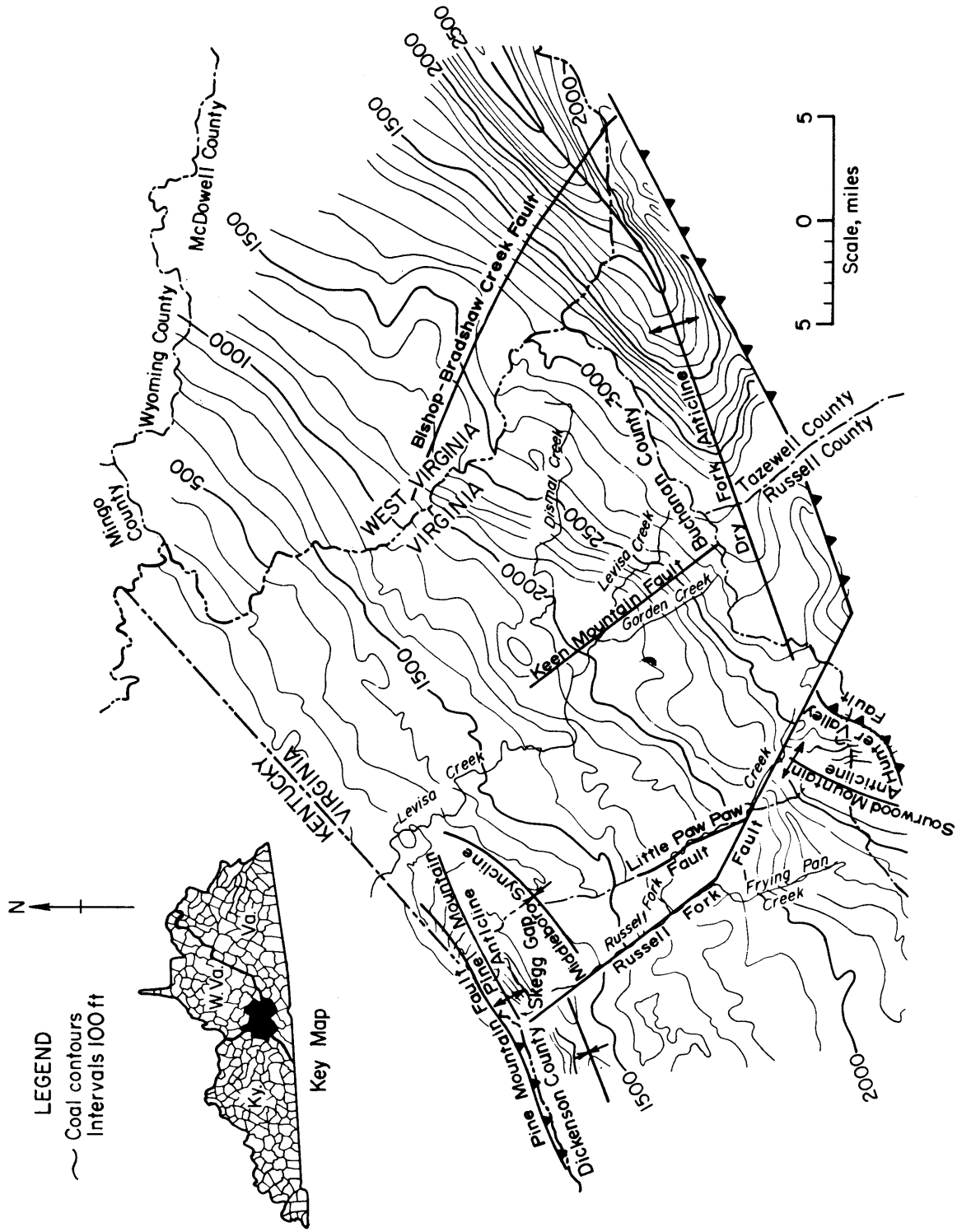

FIGURE 20. - Map of Keen Mountain fault in the Pocahontas No. 3 coalfield, Beatrice-Pocahontas mine.



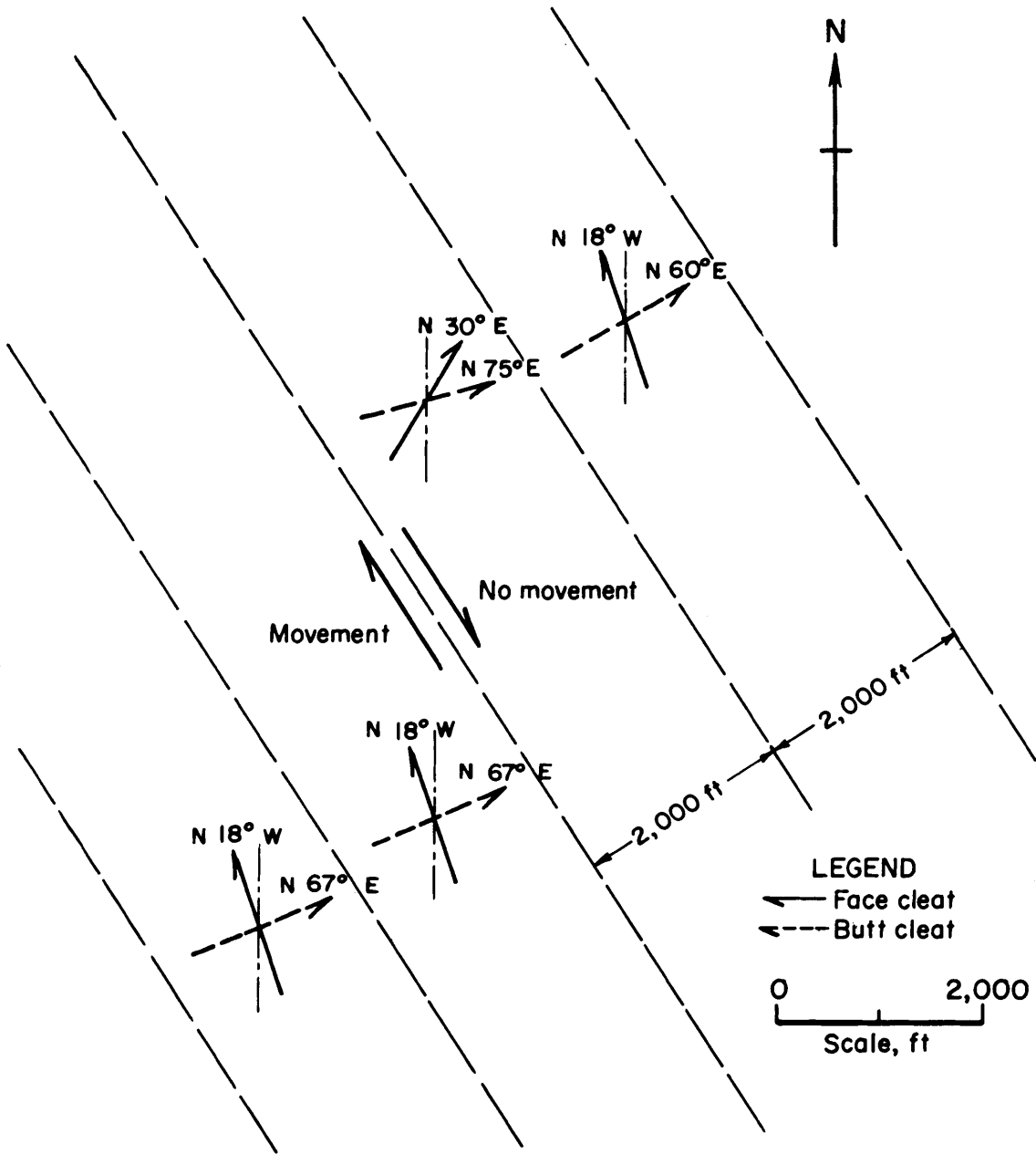

FIGURE 21. - Cleat rotation in relation to shear fault, Beatrice-Pocahontas mine.

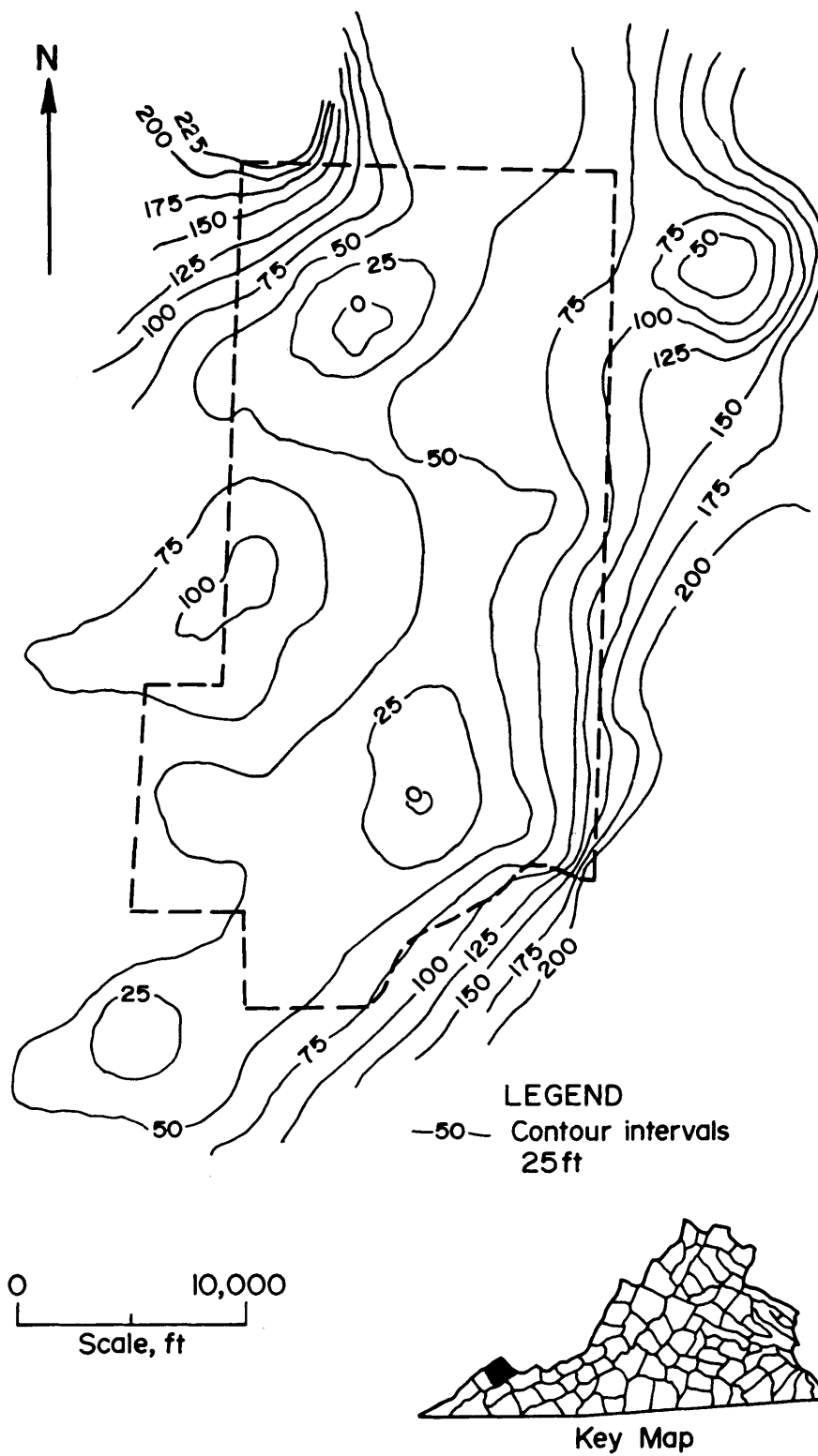

FIGURE 22. - Structure map drawn on the base of the Pocahontas No. 3 coalbed, Beatrice-Pocahontas mine.

According to a structure map (fig. 22), the mine is located on the flank of a monocline with a west-southwest dip. A fence diagram (fig. 23) showed two possible sandstone channels, one running southeast and the other northeast. The one trending southeast has already been encountered in mining and did cut out the coal. The one trending northeast has not yet been reached, but it is expected to cause much the same type of problem as the first one.

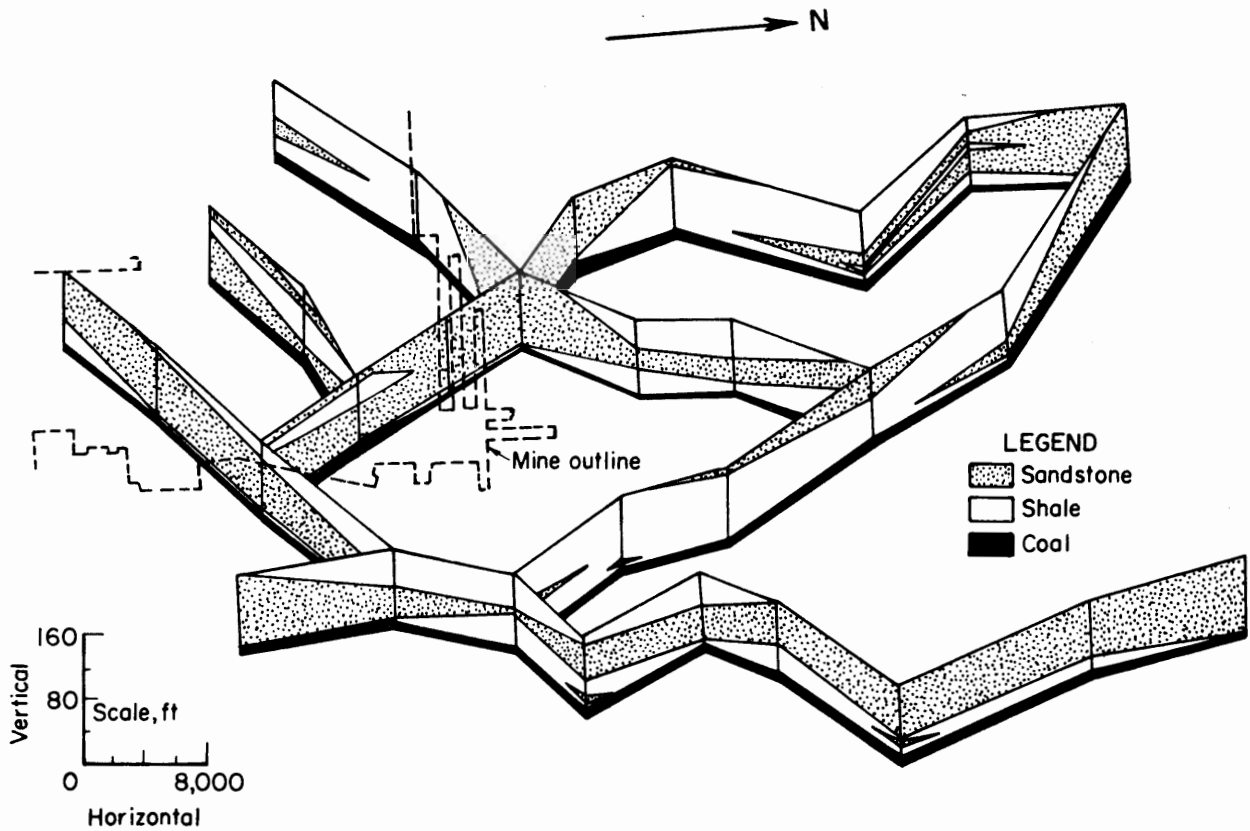

FIGURE 23. - Fence diagram of the strata above the Pocahontas No. 3 coalbed, Beatrice-Pocahontas mine.

During the survey, it was noted that washouts occurred with massive sands, and a majority of the falls observed had micaceous sands composing the fall unit. A map of the type of sandstone (massive or micaceous) found above the coal (fig. 24) should anticipate such problems and make it possible to modify mining techniques before problem zones are encountered.

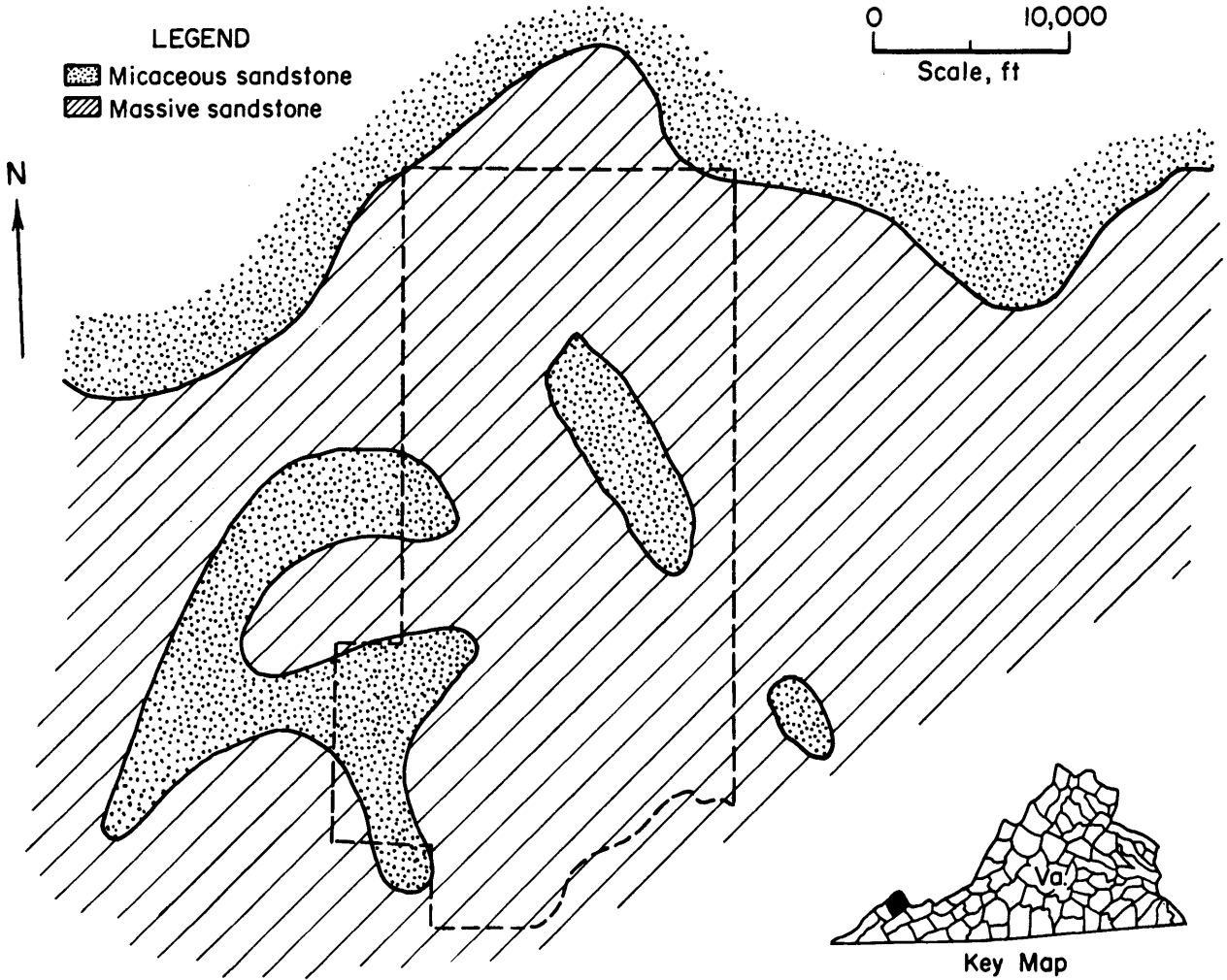

FIGURE 24. - Nature of sandstone above Pocahontas No. 3 coalbed, Beatrice-Pocahontas mine.

An isopach map (fig. 25) of the coal thickness was prepared to determine if any washouts could be located. A second isopach from the coal to the sandstone above (fig. 26) was constructed to determine if the roof falls and gas content correlated with proximity to the sands and as an additional aid in locating washouts and channels.

Finally an overburden isopach (fig. 27) was drawn to verify a Bureau of Mines theory that relates the amount of gas to the thickness of the overburden.

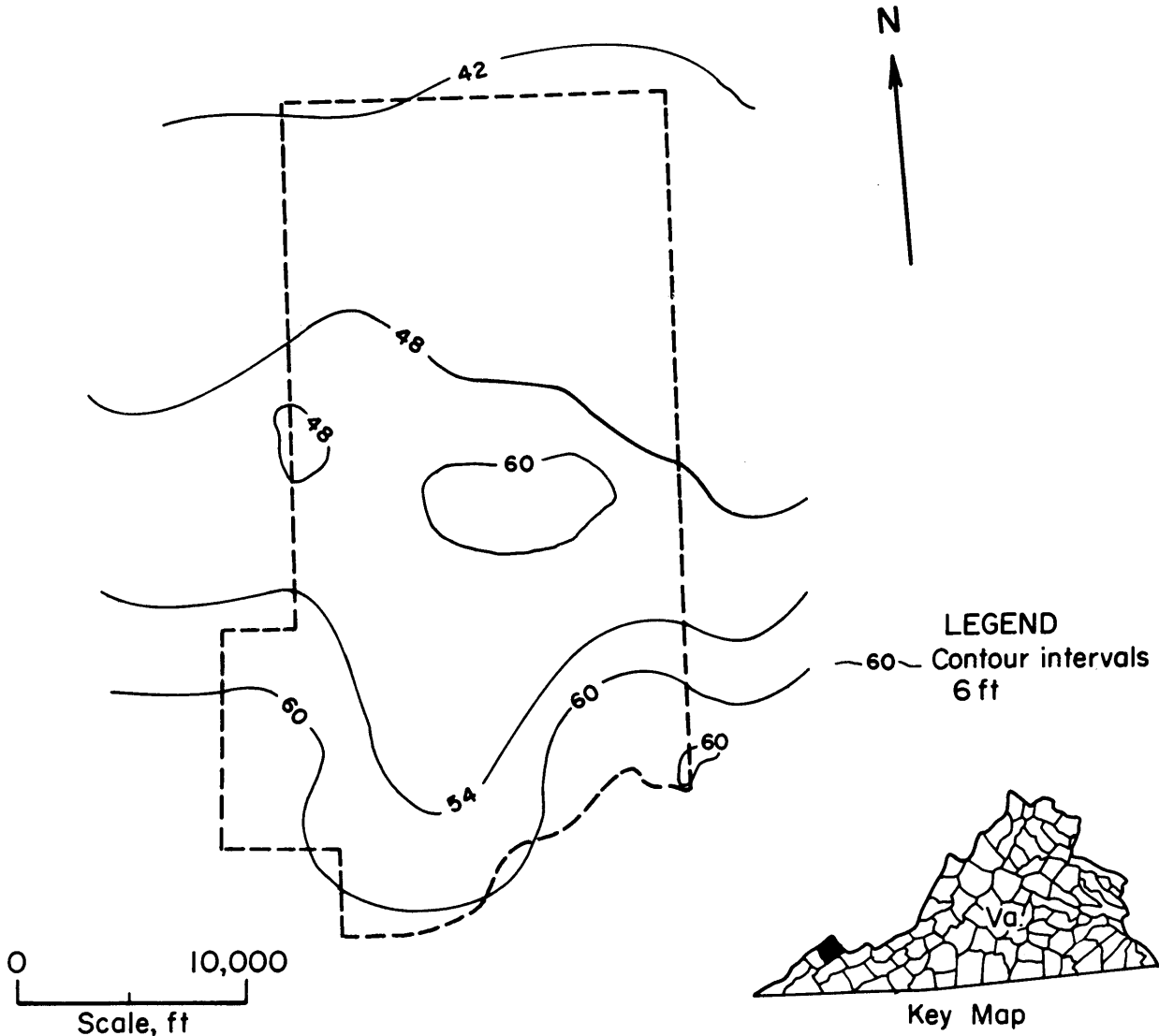

FIGURE 25. - Isopach of Pocahontas No. 3 coalbed (inches), Beatrice-Pocahontas mine.

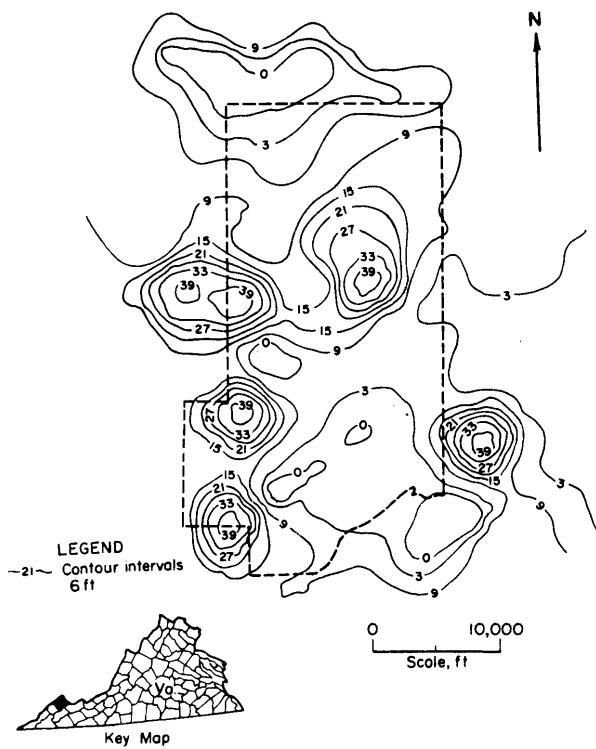

FIGURE 26. - Isopach of interval between Pocahontas No. 3 coalbed and sandstone above Beatrice-Pocahontas mine.

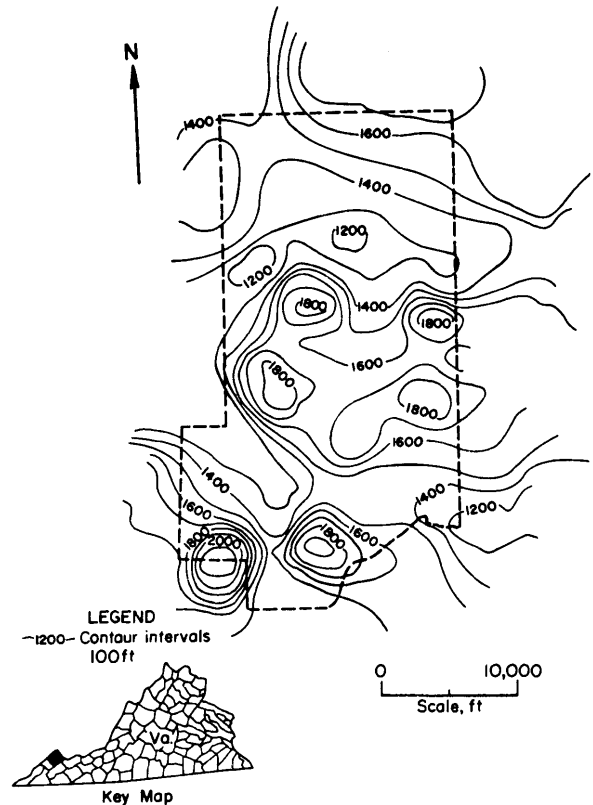

FIGURE 27. - Overburden isopach map of interval from Pocahontas No. 3 coalbed to surface, Beatrice-Pocahontas mine.

#### SUMMARY

The knowledge gained from geologic investigations of mines can help control many underground problems. It is of primary importance for the coal companies to have accurate core logs from closely spaced drill holes. A grid system with not more than 3,000-foot centers, and preferably with 2,000-foot centers, is recommended for obtaining useful geologic information.

Basic to the investigation of the various types of mining problems encountered is the construction of geologic maps and fence diagrams. They can help predict areas of probable roof instability and trends of sandstone channels that may cut through the coalbed.

Clay veins can be mapped in underground surveys and their trends predicted into future areas of mining. Predicting trends of clay veins has been somewhat less successful than predicting sandstone channels.

The sources of water accumulations can be evaluated for possible geologic influence. Fault zones and roof fracturing have been shown to induce the production of water, as well as gas, into a mine.

A detailed joint pattern of the area above a mine can be established and its relationship to coal cleat direction and roof fractures underground evaluated. Excessive spalling of ribs when mining is with the cleat direction can sometimes be corrected by a 45° rotation in the mining direction. Joint information can also be of benefit when degasification wells are planned for virgin coal areas. Local deviations in the joint and cleat directions can be an indicator of geologic irregularities that might adversely affect mining conditions underground.

## REFERENCES

1. Elder, C. H., P. W. Jeran, and D. A. Keck. Geologic Structure Analysis Using Radar Imagery of the Coal Mining Area of Buchanan County, Va. BuMines RI 7869, 1974, 29 pp.
2. Lahee, F. H. Field Geology. McGraw-Hill Book Co., Inc., 6th ed., 1961, 926 pp.
3. McCulloch, C. M., and M. Deul. Geologic Factors Causing Roof Instability and Methane Emission Problems: The Lower Kittanning Coalbed, Cambria County, Pa. BuMines RI 7769, 1973, 25 pp.
4. McCulloch, C. M., M. Deul, and P. W. Jeran. Cleat in Bituminous Coalbeds. BuMines RI 7910, 1974, 25 pp.



## GLOSSARY OF TERMS

- Anticline:** A fold that is convex upward or had such an attitude at some stage of development.
- Axis:** A straight line, real or imaginary, passing through a body or system around which the parts are symmetrically arranged.
- Bimodal:** A frequency distribution characterized by two localized modes, each having a higher frequency of occurrence than other immediately adjacent individuals or classes.
- Butt cleat:** A short, poorly defined cleavage plane in a coalbed, usually oriented at right angles to the face cleat and sometimes terminating against it.
- Buttress:** A part of the rock near a fault along which no movement has occurred. The movement has taken place against this wall.
- Clay vein:** A body of clay, usually roughly tabular in form like an ore vein, which fills a crevice in a coal seam. It is believed to originate where pressure has been sufficient to force clay from the roof or floor into small fissures and in many cases to alter and enlarge them.
- Coal cleat:** A joint or system of joints along which the coal fractures. There are usually two cleat systems developed perpendicular to each other.
- Draw slate:** Soft shale that occurs above a coalbed and collapses after the removal of the coal.
- Differential compaction:** The relative change in thickness of mud and sand (or limestone) after burial due to reduction in pore space.
- Dip:** The angle at which a stratum or any planar feature is inclined from the horizontal. The dip is at a right angle to the strike.
- Face cleat:** A well-defined joint or cleavage plane in a coal seam. The major joint in a coal seam.
- Fault:** A fracture or fracture zone along which there has been displacement of the sides relative to one another parallel to the fracture.
- Fence diagram:** A diagram that is a drawing in perspective of three or more geologic sections with their relationship to one another (also called panel diagram).
- Isopach map:** A map that shows the varying of the interval (thickness) between two designated stratigraphic units or horizons; for example, a map prepared directly from two structure-contour maps by subtracting the elevations of the lower surface from those of the upper surface at each control point and drawing contours of equal interval between the two surface.

**Joints:** Fracture in rock, generally more or less vertical or transverse to bedding, along which no appreciable movement has occurred.

**Linears:** A straight or gently curved physiographic feature on the earth's surface.

**Lithofacie map:** A map that is based on lithologic attributes, showing variation in the overall lithologic character of a given stratigraphic unit. The map may emphasize the dominant, average, or specific lithologic aspect of the unit, and it gives information on the changing composition of the unit throughout its geographic extent.

**Lithologic frequency map:** A map that shows the number of rock types or the frequency of times that different rock types occur in a given vertical sequence over a given horizontal distance.

**Monocline:** Strata that dip for an indefinite or unknown length in one direction, and which do not apparently extend from sides of ascertained anticlines or synclines.

**Orthogonal:** A combining form meaning straight, at right angles.

**Percent map:** A map that depicts the relative amount (thickness) of a single rock type in a given stratigraphic unit as a percent of the total rocks in that vertical interval.

**Rider coal:** A thin unminable coal found closely above a thicker minable coalbed. Normally only a few inches thick.

**Sandstone channel:** A sandstone body that ranges in thickness from several inches to many feet and in length up to several miles and that cuts across structure and bedding of the enclosing rocks. Also called a clastic dike.

**Shear fault:** A fracture that results from stresses which tend to shear one part of a specimen past the adjacent part.

**Slickenside:** Polished and striated (scratched) surface that results from friction along a plane. The movement can be very slight.

**Spalling of ribs:** Relatively thin, commonly curved and sharp-edged, piece of rock (coal) produced by weathering.

**Strike:** The course or bearing of the outcrop of an inclined bed or structure on a level surface. It is perpendicular to the direction of the dip. (Also, the bearing of a horizontal trace on the bedding plane.)

**Structure contour map:** A map that portrays the subsurface configuration of structure of a unit by means of contour lines.

**Syncline:** A fold in rocks in which the strata dip inward from both sides toward the axis.

**Synclitorium:** A broad regional syncline on which are superimposed minor folds.

**Thrust fault:** A reverse fault that is characterized by a low angle of inclination with reference to a horizontal plane.

**Washout:** A channel cut into or through a coal seam at some time during or after the formation of the seam, and generally filled with sandstone.