



SIR[®] 3000 Manual

MN72-433 Rev M

Geophysical Survey Systems, Inc.

40 Simon Street • Nashua, NH 03060-3075 USA • www.geophysical.com



Copyright© 2003-2017 Geophysical Survey Systems, Inc.
All rights reserved
including the right of reproduction
in whole or in part in any form

Published by Geophysical Survey Systems, Inc.
40 Simon Street
Nashua, New Hampshire 03060-3075 USA

Printed in the United States

SIR, RADAN and UtilityScan are registered trademarks of Geophysical Survey Systems, Inc.

Limited Warranty, Limitations Of Liability And Restrictions

Geophysical Survey Systems, Inc. hereinafter referred to as GSSI, warrants that for a period of 24 months from the delivery date to the original purchaser this product will be free from defects in materials and workmanship. EXCEPT FOR THE FOREGOING LIMITED WARRANTY, GSSI DISCLAIMS ALL WARRANTIES, EXPRESS OR IMPLIED, INCLUDING ANY WARRANTY OF MERCHANTABILITY OR FITNESS FOR A PARTICULAR PURPOSE. GSSI's obligation is limited to repairing or replacing parts or equipment which are returned to GSSI, transportation and insurance pre-paid, without alteration or further damage, and which in GSSI's judgment, were defective or became defective during normal use.

GSSI ASSUMES NO LIABILITY FOR ANY DIRECT, INDIRECT, SPECIAL, INCIDENTAL OR CONSEQUENTIAL DAMAGES OR INJURIES CAUSED BY PROPER OR IMPROPER OPERATION OF ITS EQUIPMENT, WHETHER OR NOT DEFECTIVE.

Before returning any equipment to GSSI, a Return Material Authorization (RMA) number must be obtained. Please call the GSSI Customer Service Manager who will assign an RMA number. Be sure to have the serial number of the unit available

FCC Class B Compliance

This device complies with Part 15 of the FCC Rules. Operation is subject to the following two conditions: (1) this device may not cause harmful interference, and (2) this device must accept any interference received, including interference that may cause undesired operation.

Warning: Changes or modifications to this unit not expressly approved by the party responsible for compliance could void the user's authority to operate the equipment.

Note: This equipment has been tested and found to comply with the limits for a Class B digital device, pursuant to Part 15 of the FCC Rules. These limits are designed to provide reasonable protection against harmful interference when the equipment is operated in a commercial environment or residential installation. This equipment generates, uses, and can radiate radio frequency energy and, if not installed and used in accordance with the introduction manual, may cause harmful interference to radio communications. However, there is not guarantee that interference will not occur in a particular installation.

Shielded cables must be used with this unit to ensure compliance with the Class B FCC limits.

Canadian Emissions Requirements

This Class B digital apparatus complies with Canadian ICES-003.

Cet appareil numérique de la classe B est conforme a la norme NMB-003 du Canada.

Notice

Operation is subject to the following two conditions: (1) this device may not cause interference, and (2) this device must accept any interference, including interference that may cause undesired operation of the device.

Table of Contents

Chapter 1: Introduction	1
1.1: Unpacking Your System	1
1.2: General Description	1
1.3 Cautions and Warnings.....	5
Chapter 2: Getting Started and TerraSIRch Module Setup	7
2.1: Hardware Setup.....	7
2.2: Boot-Up and Display Screen.....	9
2.3: System Modes and Menus: A General Description	10
2.4: The Command Bar	21
Chapter 3: Setting Up Your System for Data Collection in TerraSIRch Mode.....	25
3.1: Setting Up for 2-D Data Collection	25
3.2: Setup for Single Line 3-D Collection in TerraSIRch.....	29
3.3: Setting Up for Time-Based Data Collection	30
3.4: Setting Up for Point Data Collection	31
Chapter 4: Using the Quick3D Collection Mode	33
4.1: Quick3D File Structure	33
4.2: Setting Up Quick3D Data Grids	34
4.3: Setting Up the SIR 3000 for Quick3D Collection	35
4.4: Step By Step Software Setup	36
4.5: Collecting Data	38
4.6: Playing Back Quick 3D Data on the SIR 3000.....	38
Chapter 5: Data Transfer and File Maintenance.....	44
5.1: Transfer to a PC via USB Connection	44
5.2: Transfer to a PC via the External Compact Flash.....	44
5.3: Transfer to a PC via an External USB Flash/Keychain/ Pen Drive (HD)	45
5.4: Deleting Data from the System	45
Chapter 6: Summary of Pre-Set Mode Parameters.....	46
6.1: ConcreteScan	46
6.2: StructureScan	47
6.3: UtilityScan.....	48
6.4: GeologyScan.....	49
Chapter 7: Using a GPS with your SIR 3000.....	50
7.1: Attaching a GPS	50
7.2: Understanding GPS.....	51
7.3: Using the G30L with the SIR 3000 and RADAN 6.0.....	53
Appendix A: TerraSIRch SIR 3000 System Specifications.....	58
Appendix B: The How-To's of Field Survey	60
Appendix C: Mounting Your SIR 3000 on a Cart	66
Appendix D: Dielectric Values For Common Materials.....	72
Appendix E: Listing of Antenna Parameters.....	74
Appendix F: Glossary of Terms and Suggestions for Further Reading	84
Appendix G: Installing Microsoft ActiveSync on Your PC.....	88

Chapter 1: Introduction

This manual is designed for both the novice and experienced user of ground penetrating radar. It is intended as both a reference and a teaching tool and it is recommended that you read the entire manual, regardless of your level of GPR experience. For information about GPR theory, please see the list of general geophysics references that can be found in Appendix F.

If you experience operation problems with your system, GSSI Tech Support can be reached Monday-Friday, 9 am - 5 pm EST, at 1-800-524-3011, or at (603) 893-1109 (International).

1.1: Unpacking Your System

Thank you for purchasing a GSSI TerraSIRch SIR® System-3000 (hereafter referred to as SIR 3000). A packing list is included with your shipment that identifies all of the items that are in your order. You should check your shipment against the packing list upon receipt of your shipment. If you find an item is missing or was damaged during the shipment, please call or fax your sales representative immediately so that we can correct the problem.

Your SIR 3000 system contains the following items:

- 1- Digital Control Unit (DC-3000) with preloaded operating system.
- 1 - Transit Case
- 2 - Batteries
- 1 - Charger
- 1 - AC Adaptor
- 1- Sunshade
- 1- Operation Manual

Your choice of antenna, cables, and post-processing software is available for an additional purchase.

1.2: General Description

The SIR 3000 is a lightweight, portable, single-channel ground penetrating radar system that is ideal for a wide variety of applications. The various components of the SIR 3000 are described below.

The major external features of the control unit are the keypad, color SVGA video screen, connector panel, battery slot, and indicator lights. The video screen allows you to view data in real time or in playback mode. It is readable in bright sunlight, although an optional sunshade for the unit is available. Prolonged exposure to direct sunlight will cause the screen to heat up and may affect screen visibility.

Note: Do not use Windex or other ammonia-based glass cleaner to clean the display screen as this may damage the coating. Use only a clean, slightly damp cloth to gently clean the screen. Due to the screen's special coating for direct sun viewing, it is very susceptible to scratches. Take extreme care not to use any abrasive materials or any solvents to clean the screen. The only recommended cleaning tool is a camera quality lens cloth. Screen replacement due to scratching is not covered under the system's warranty.

The battery slot in the front of the unit accepts the 10.8 V Lithium-Ion rechargeable battery provided. Survey time with a fully charged battery is approximately 3 hours. Batteries are recharged with the optional battery charger or by simply leaving the battery in the unit and connecting the unit to a standard AC source and leaving the system in standby mode. Time to recharge a battery is approximately 4-5 hours. Be sure to keep the battery slot cover on the unit while in use to ensure that no dust or dirt enters the unit's interior.

Hardware Connections

On the back edge of the unit, the SIR 3000 has six connectors and one slot for the memory card. The five top-row connectors are, from left to right: AC Power, Serial I/O (RS232), Ethernet, USB-B, and USB-A.

Memory Card: Data can be stored on Compact Flash cards, USB key drives (Compact Flash format), or IBM Microdrives for transfer to PC for processing. These cards are widely available and are the same type used in other digital devices such as cameras, MP3 players, and camcorders. The amount of system card memory is totally dependent on your choice of memory card size.

- Since radar profiles can sometimes be several megabytes in size, GSSI recommends that you purchase a high capacity card.
- If there is no memory card inserted when the system is first turned on, the system will save the data profile to its internal system memory and data will have to be transferred with the USB connection or by later inserting a memory card. The internal memory capacity is approximately 1 gigabyte. Please see Chapter 4: Data Transfer and File Maintenance for additional information on transfer.

Antenna Connector: The large, protruding 19-pin connector at the back of the system is for the antenna control cable. You will notice that antenna connection on the SIR 3000 has five notches cut from the metal. These mate with the five raised nubs on the control cable to ensure that the pins line up properly.

- Screw the cable connector collar onto the SIR 3000 to make proper contact. The cable should only be *hand-tightened*. *Do not use a wrench* to tighten the connection as over-tightening will result in damage. The cable connector collar should be screwed down far enough to cover the red line on the SIR 3000 connector.
- The only proper time to attach or detach an antenna is with system power off. Be sure to unplug any external power and to remove the battery before attaching or detaching antennas. Putting the SIR 3000 in Sleep Mode is not sufficient.

Warning: Use of a Model 3207 pair (100 MHz) or a Model 3200 Multiple Low Frequency antenna without a TR fiber optic link will cause damage to the SIR 3000's transmit circuitry. Always be sure to use a Model 570 Fiber Optic Transmit Link with the Model 3207 pair and use the fiber optic transmit cable for the 3200 MLF.

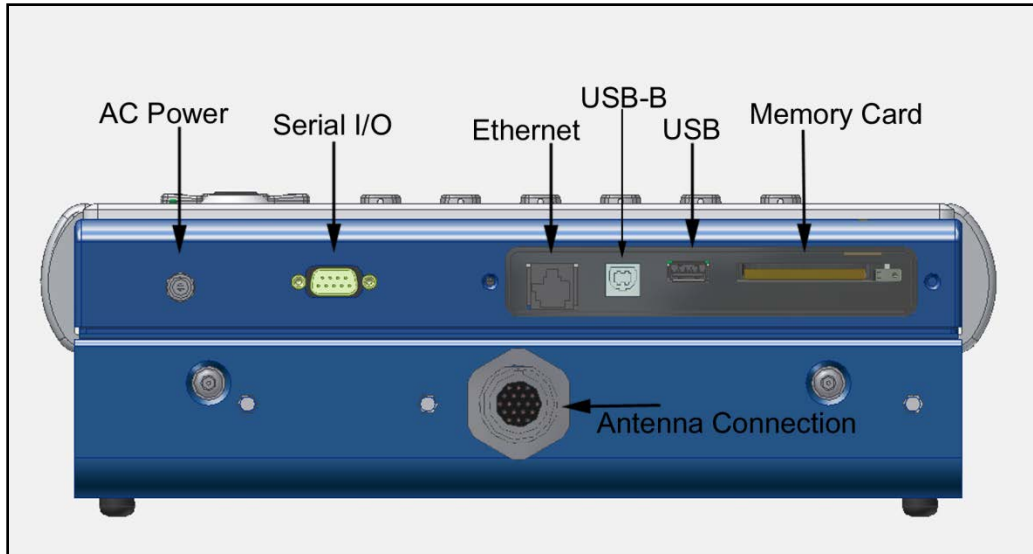

AC Power: Plug in the supplied universal AC power adaptor to run the system from 110-240 V, 47-63 Hz power.

Serial I/O (RS232): This is a standard serial connection that can be used to establish communication between the SIR 3000 and a GPS. Please see Chapter 7: Using a GPS with your SIR 3000 for additional information. This port is also used to connect the serial lead from the StructureScan Optical barcode reader cart to the SIR 3000.

Ethernet: Functionality for this port is not currently available.

USB-B and USB-A: These ports are for connection to a variety of USB peripherals, including a keyboard and memory device.

Keypad

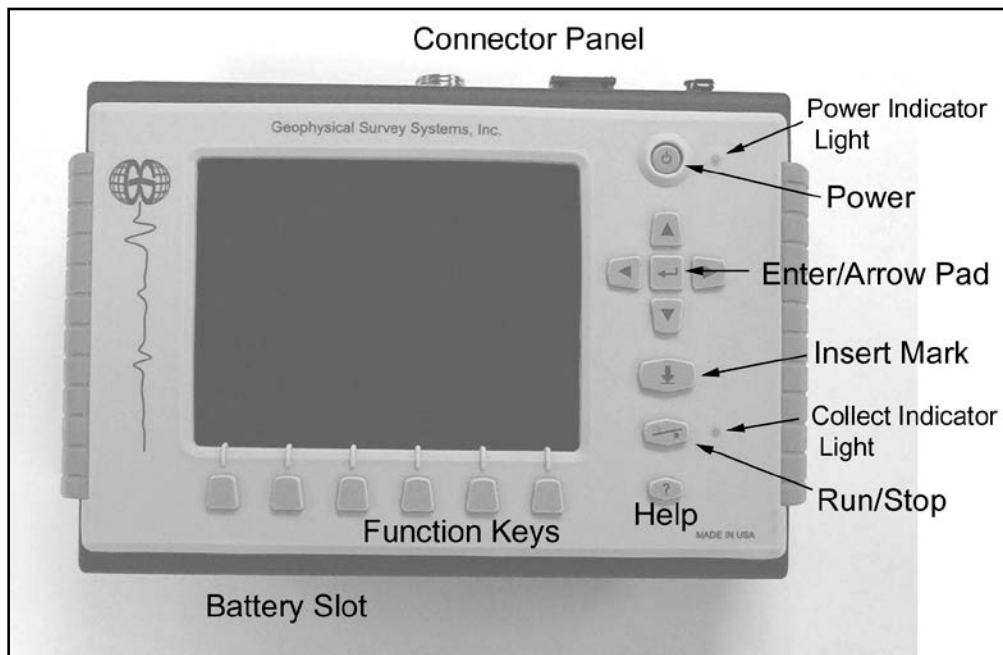

The keypad on the front of the unit has fifteen (15) buttons and two indicator lights.

Power: This button turns the SIR 3000 on and off. To start up the system, insert a battery or connect AC power and push the power button.

Enter/Arrow Pad: This grouping of five buttons is located right below the power button. The Enter key is the one in the center. These buttons allow you to navigate through the menu tree.

- Highlighting a menu item by pushing Up or Down on the menu tree and then pushing the Right arrow will open any menus that are under that menu choice. Left arrow will collapse those menu items to refresh the menu tree.
- Pushing the Enter key on some menu items will cause a pop-up menu to appear so you can toggle between two or more parameter choices.

For example: To setup data collection mode, pushing Enter when COLLECT > RADAR > MODE is highlighted will bring up a pop-up menu which will allow you to choose from Time (continuous data collect), Distance (survey wheel), or Point measurement. Highlight your choice and push Enter to see your choice applied, and then Right arrow to accept and cause the pop-up menu to disappear.

Insert Mark: This button is located below the Enter/Arrow Pad. Pushing this button while collecting data will cause the system to set a User mark in the data.

- User marks are helpful for noting distance traveled if you are not using a survey wheel and for noting the location of obstacles such as columns, trees, pits, etc.
- User marks will appear as long, dashed, vertical white lines through the data window.

Run/Stop: This button is located below the Insert Mark button. Pushing the Run/Stop button in COLLECT > RUN stops data collection and brings up a set of crosshairs. Clicking this button again closes a data collection file and causes the system to ask if you want to save that file. Clicking this button during Setup in modes other than TerraSIRch or Quick 3D will cause the system to re-initialize the gain and position servos. This will reset the gains to the area under the antenna and could minimize clipping.

Help: This button is located under the Start/Stop button. Pushing the Help button will bring up a menu of help topics. **The onscreen help is only accessible from the TerraSIRch splash screen.** Use the Mark button to highlight links and Enter to jump to a help topic. Pushing the Run/Stop button on the right hand side of the unit will take you back to the previously viewed screen.

Function Keys: These six (6) buttons are located below the video screen. Pushing one of these from the initial start screen will cause the SIR 3000 to operate in the desired software module.

1.3 Cautions and Warnings

- 1 The Display Screen:** Do not use Windex or other ammonia-based glass cleaner to clean the display screen as this may damage the glare reduction coating. Use only a clean, slightly damp cloth to gently clean the screen. Due to the screen's special coating for direct sun viewing, it is very susceptible to scratches. Take extreme care not to use any abrasive materials or any solvents to clean the screen. The only recommended cleaning tool is a camera quality lens cloth. Screen replacement due to scratching is not covered under the system's warranty
- 2 Power off before connection/disconnecting an antenna:** Antennas are not hot-swappable. You must turn off the SIR 3000 before connecting or disconnecting an antenna. Failure to remove power may cause damage to the SIR 3000.
- 3 Weatherproofing:** The SIR 3000 is weather resistant, but not weather proof. Try to avoid getting the system wet. If you believe that water has gotten inside of the system, disconnect power, open the battery compartment and input connector compartment on the back and allow the system to thoroughly dry.
- 4 100 MHz (3207) and 3200 MLF antennas:** Use of a Model 3207 pair (100 MHz) or a Model 3200 Multiple Low Frequency antenna without a TR fiber optic link will cause damage to the SIR 3000's transmit circuitry. Always be sure to use a Model 570 Fiber Optic Transmit Link with the Model 3207 pair and use the fiber optic transmit cable for the 3200 MLF.

Chapter 2: Getting Started and TerraSIRch Module Setup

In Chapter 2, you will find instructions for connecting all of the hardware inputs and an introduction to the different menus and functions that are available to you in TerraSIRch mode. TerraSIRch mode allows you total control over all collection parameters and is the most versatile data collection method, usable for all GPR applications. If desired, these 2-D profiles can later be transferred to a PC for processing in GSSI's RADAN™ post-processing software.

2.1: Hardware Setup

Hardware setup for the SIR 3000 is very simple. We will assume the 400 MHz (Model 5103) antenna for this example, but the hardware connections are the same for other GSSI antennas, and the cable connections are clearly marked. Follow the steps below.

- 1 Attach the survey handle between the two vertical mounting plates on the top of the antenna with the two removable pins, adjust the angle for comfort, and connect the marker cable to the antenna at the MARK port.

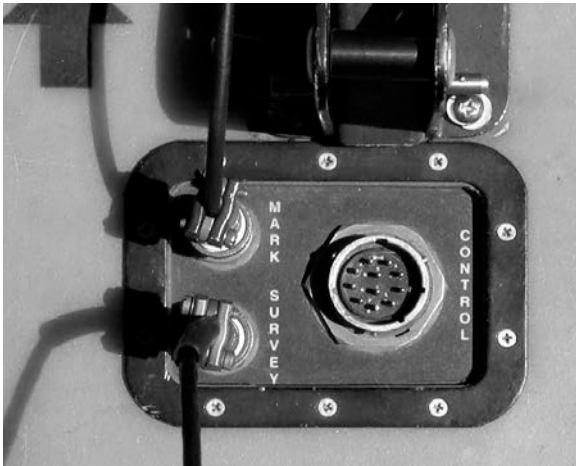



- 2** Connect the female end of the antenna control cable to your antenna. Then connect the male end to the antenna connection on the back of the SIR 3000. Connect the two protective caps together. Attach the survey wheel to the brackets at the back of the antenna (as shown below) and connect the cable to the SURVEY port on the top of the antenna. Be sure that the triangular plate protecting the survey wheel encoder faces down.

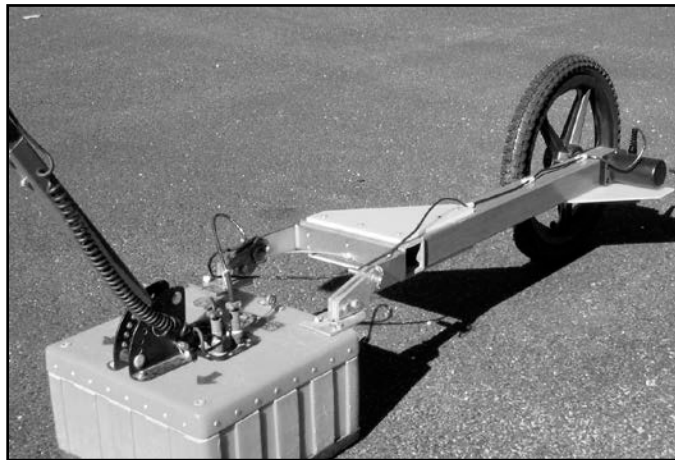

- 3** Connect power source (battery or AC) to the SIR 3000 and push the power button to turn on the system.

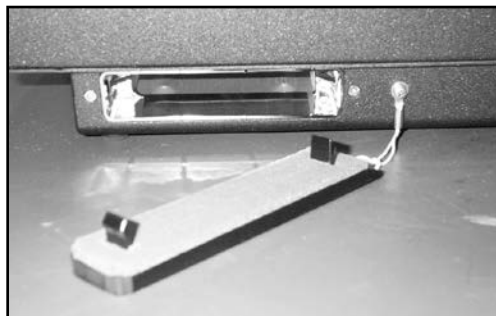

If you purchased your SIR 3000 with a cart as in the UtilityScan System, or purchased the cart system separately, please see Appendix C: Mounting your SIR 3000 on a Cart. The cart also incorporates a survey wheel that is used in place of the survey wheel pictured earlier. If you have a StructureScan™ Standard or StructureScan™ Optical system, please consult the hardware setup instructions in the small, laminated QuickStart Guides that came with the system.

2.2: Boot-Up and Display Screen

After the SIR 3000 boots up, you will see the introductory screen. There will be 6 icons positioned over the Function Keys. The first one is TerraSIRch.

Pushing the Mark button switches your desired units between English and Metric.

TerraSIRch mode gives you complete control over all data collection parameters. Quick Start guides are available for StructureScan and UtilityScan. The StructureScan Quick Start guide also covers the ConcreteScan functionality. Push the TerraSIRch button. After a moment, you will see a screen divided into three windows and there will be a bar running across the bottom with commands above each of the 6 Function Keys.

After entering one of the six data collection modes, you can return to this screen by either clicking the Power button twice or by removing the battery and AC power and reinserting it to re-boot.

Note: For information on other modes, please see Chapter 6.

Data Display Windows

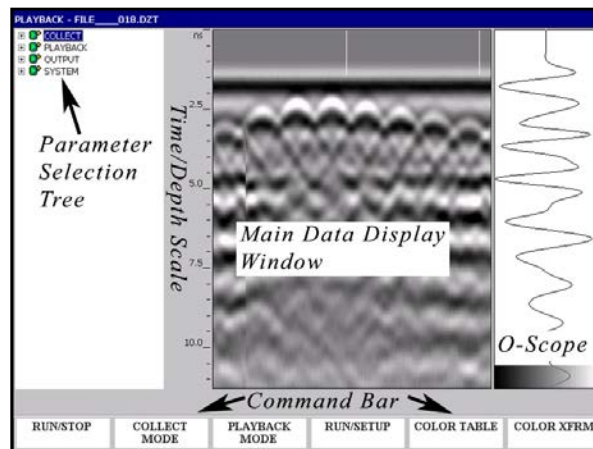

O-Scope (right): On the far right of the screen you will see a window that shows a single radar scan in an oscilloscope-style (O-scope) depiction. This will show successive single scans as you move your antenna across an area while in Setup mode.

- Time (depth) increases down the screen.
- At the bottom of the window you will see a color bar. This shows you the distribution of colors across the range of reflection amplitudes (size of the peaks of the scan to the left and the right of center). The exact color and distribution depends on your choice of color table and color transform.

Main Display (center): The main data display window in the center shows a radar profile in linescan format. In this depiction, successive single scans are assigned color values and stacked next to each other in sequence to form a continuous image.

- The vertical scale on the left of this data display window shows time, depth, or sample number.
- New scans will be placed at the right side of the window and data will scroll from right to left.

Command Bar (bottom): The bar across the bottom of the screen is the Command bar and allows you different toggles and functions depending on whichever system mode you are in at the time. You can activate these commands by pushing the function key right below the wording. These commands are each explained in more detail later on when the different system modes are discussed.

Parameter Selection (left): To the left of the main data display window is the parameter selection tree window. This window is where you will navigate through the various commands, set system parameters, and enter file name information. The tree is similar to the basic folder and file browser seen in many Windows-based applications. Upon setup, you will see three choices that indicate the three modes of the SIR 3000, COLLECT, PLAYBACK, and OUTPUT, as well as the SYSTEM menu used to change system parameters.

2.3: System Modes and Menus: A General Description

The SIR 3000 has four main system menus, Collect, Playback, Output, and System. We will first look briefly at the System menu.

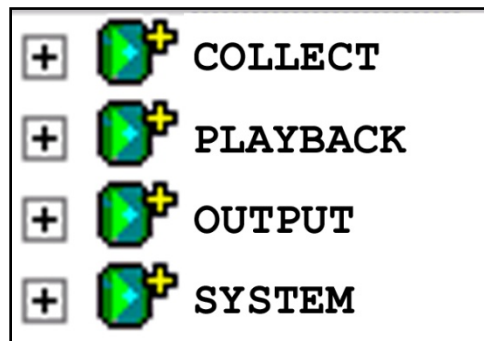

The SYSTEM Menu

If you are using your SIR 3000 for the first time or if you need to change some system parameters, you should enter this menu first. Highlighting SYSTEM and pushing the Right arrow will bring out seven additional menu choices:

- UNITS (page 11)
- SETUP (page 11)
- PATH (page 11)
- BACKLIGHT (page 11)
- DATE/TIME (page 12)
- BATTERY (page 12)
- LANGUAGE (page 12)
- VERSION (page 12)

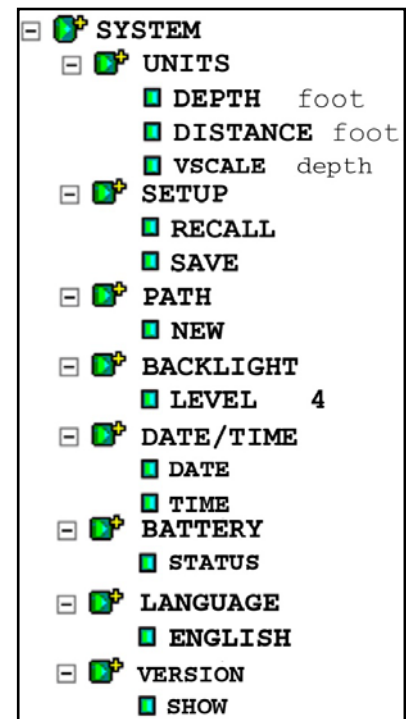

UNITS

You can select appropriate units for DEPTH and DISTANCE, as well as the appropriate scale. For example, if you are using a very high frequency antenna to scan 18 inches into concrete, you may choose to display depth in inches and distance in feet. Under VSCALE, you can choose to display in depth, time, or height. Time is measured in units of nanoseconds (ns). When set to time, the vertical scale displays two way travel time (TWTT). If you set to depth, then the SIR 3000 will perform a time to depth conversion based on the dielectric value that you have set in COLLECT > SCAN. It will then display the vertical scale in depth. Height will invert the screen so that time-zero is at the bottom. This can be a useful display if you are scanning upside-down.

SETUP

This allows you to either save the current list of data collection parameters (hereafter called a setup), recall saved setup, or a factory loaded one.

- Factory setups cannot be overwritten, but the system has 16 slots where single user setups can be saved.
- After choosing your antenna under the COLLECT mode, you will have to find the correct setup for that antenna and recall it.
- These are named SETUP01 to SETUP16. SETUP00 is a default setup that contains the parameters the system was collecting the last time that it was used.

PATH

Think of this as the location in which your files are stored on the SIR 3000. There are two basic types of paths: Common and User-defined.

- Each file in the Common path will be named with the word FILE and then a number. For example, the first data file will be FILE001, then FILE002, and so on.
- The user-defined path allows you to change the root name (instead of FILE) and the location of your data. This is useful if you are surveying multiple areas or if you prefer to name your files during collection with a site name instead of doing it later after download.
- To create a user-defined path, select NEW from the Path menu. This will bring up a window with six letters and an Up/Down arrow. Enter the new name by scrolling through the letters with the Up/Down arrow. You can advance to the next 'digit' by using the Enter button. Once you are finished, click the Right arrow.
- To delete a Path you must first delete all of the data files. Then select TRANSFER > DELETE again, the Remove Files window will pop-up, and you will see an option to REMOVE PATH. Click Enter to put a check in that box and then Right Arrow to accept. The path will be removed and the system will default to the Common path.

BACKLIGHT

This controls screen brightness. The scale runs from 1 to 4 with 4 being the brightest. The darker the screen is, the longer the battery will last because powering the screen is a large draw on the power supply.

DATE/TIME

Use this selection to set the system's internal clock to the current date and local time. The SIR 3000 will attach this information to each radar profile you collect. This information is saved and will not be lost each time you turn the system off or remove the battery.

BATTERY

This selection allows you to check the remaining charge on the battery. The value here is rough estimation of the remaining time until the battery is too low to power the SIR 3000. If you have external power connected, the window will say External Power Supply.

LANGUAGE

This allows you to change the display language of the SIR 3000 to a number of pre-loaded language packs. If your native language is not available, check the GSSI website periodically to see if the language patch is available for download.

VERSION

This allows you to check the current version of the TerraSIRch operating software. You should check the GSSI website for updates to the Graphical User Interface (GUI) software. The GUI is listed at the bottom of the Version pop-up window. Note which GUI version you have, then go to the GSSI Technical Support website at <http://support.geophysical.com>, and click on the SIR 3000 Updates tab. You should also download the instructions for the download. You will need a USB cable to link your SIR 3000 to your PC, and you will also need a password and username for the secure section of GSSI's website. You may register for a password on the Technical Support section of the website.

The COLLECT Menu

The COLLECT menu is similar to the Collect Setup mode on the older GSSI SIR 2 and SIR 2000. If you are familiar with those systems, you will notice a lot of similarities here. Under COLLECT, there are five main sub-menus that can each be accessed by pushing the Down arrow to highlight the sub-menu, then the Right arrow to see additional menus inside the sub-menu. These are:

- SCAN (page 14)
- GAIN (page 16)
- POSITION (page 17)
- FILTERS (page 17)

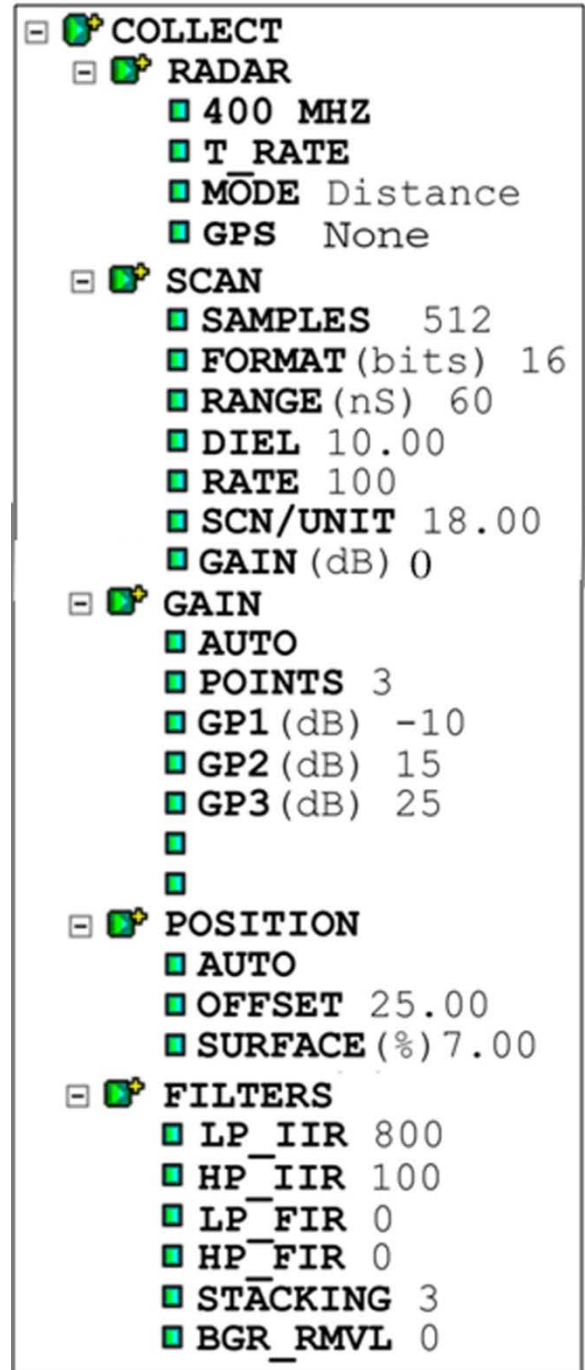

RADAR

This sub-menu has four main choices: Antenna, T_RATE, MODE, and GPS.

Antenna Choice: Under this menu, you will be able to enter the center frequency of the particular antenna you are using. This will allow the SIR 3000 to perform the auto-surface operation.

T_RATE: The T_RATE is the antenna transmit rate in KHz. This rate is capped at 100 KHz. A higher transmit rate equals faster data collection ability. Some older antennas however, are not capable of transmitting at high speeds and setting them at a high transmit rate may cause error. Please consult your antenna documentation or call GSSI Tech Support if you have any question about transmit rate. All GSSI 5100 and 52000 series antennas (2.6 GHz, 2.0 GHz Palm, 1.6 GHz, 1.5 GHz, 1.0 GHz, 400 MHz, 270 MHz, 200 MHz) can be driven at 100 KHz. If you are using another GSSI antenna, consult Appendix E for the proper transmit rate.

Note: If your SIR 3000 beeps repeatedly with an older/high power antenna, you may have your T_RATE set too high. This beeping is a high-voltage overload warning. A prolonged overload could damage your system. Lower your T_RATE until the beeping stops.

MODE: The MODE selection allows you to collect data as point, distance, or time based. Point data collection is commonly selected only for very deep applications or very difficult terrain. The system will record one scan every time the external marker or Run/Stop button is pressed. The antenna is then moved to the next location and the next scan is taken. In time based data collection, the system is recording a certain amount of scans per second. The data density over an area depends on the speed that the antenna is moved over the ground. The rate (scans/second) is set in the SCAN submenu. Distance-based collection is performed with a survey wheel. The system records a certain number of scans per unit of distance. This is the most accurate data collection method and it is strongly recommended that you collect data in this mode if possible. Distance-based data is required for 3D files

GPS: This selection allows you to toggle the GPS capability on and off. Connect the GPS to the serial port, and toggle this either to G30L if you are using the GPS receiver obtained from GSSI, or to CUSTOM if you are using another GPS receiver.

If you are using the Acumen SDR Data Bridge/Logger purchased from GSSI, attach the serial lead from the GPS to the Data port and attach the lead from the SIR 3000 to the Config port, and then select SDR from the list under RADAR > GPS.

Consult Chapter 7 of this manual for additional instructions and setting up the GPS and working with it. GSSI publishes information about GPS integration as Technical Notes that are available on the GSSI Technical Support website at <http://support.geophysical.com>.

SCAN

Scan contains six additional menus: SAMPLES, FORMAT, RANGE, DIEL, RATE, and SCN/UNIT.

SAMPLES: Each scan curve is made up of a set number of individual data points, called Samples. The more samples you collect, the smoother the scan curve and the better your vertical resolution will be.

- You can choose from a preset list of 256, 512, 1024, 2048, 4096, or 8192 samples per scan. FIR filters should not be used with 4096 or 8192 samples per scan.
- Note that as sample number increases, maximum scan rate drops and file size increases.
- GSSI recommends sampling at 512 or 1024 samples per scan for most applications. More samples will be required for deep geologic or polar ice thickness applications.

FORMAT: Data can be collected in either 8-bit or 16-bit format. 16-bit data is recommended for most applications because it has a greater dynamic range, meaning there is more information in the data. If you are only collecting data to be viewed on the screen (no processing), or are collecting very high samples/scan data, you should set this to 8-bit data. 16-bit data profiles are twice as large in terms of computer storage.

RANGE: RANGE is the time window in nanoseconds (ns) that the SIR 3000 will record reflections. The time range is proportional to depth viewed because a longer range will allow more time for energy to penetrate deeper and give reflections from deeper down.

- It is important to remember that the range is two-way travel time, so that a range of 50 ns means that the deepest reflector is 25 ns deep.
- Bear in mind that you still have a set number of samples to draw a curve and a very long range may require a greater number of samples. The range can be set from 5-8000 ns.
- Please see Appendix B for a list of common ranges for individual antennas.

DIEL: DIEL refers to the dielectric constant of a material. Basically it reflects the velocity that radar energy moves through a material.

- If you know the dielectric value of the material that you are surveying through, you can enter it here and get an in-field time to depth calculation.
- Higher dielectric values mean slower travel time and shallower penetration.
- Generally speaking, water raises a material's dielectric constant, and surveys should be performed on dry material whenever possible.
- Please see Appendix D for a chart of dielectric values of common materials and a deeper discussion of dielectrics. Possible values are 1-81.

Example: In air, which has a dielectric constant of 1, radar energy will travel at 12 inches per ns. Since the time range is two-way travel time, 1 ns on the vertical scale translates to 6 inches if the DIEL is set to 1. The distance traveled per ns is reduced by the square root of the dielectric constant. The dielectric constant of water is 81, so that water slows down the radar wave by a factor of 9 ($\sqrt{81}=9$). The range in water is thus 6/9 inches per ns.

RATE: The next selection is scan RATE. This value is the number of scans the system will record in its RAM memory per second.

- If you are collecting data based on time, this is the number of scans that will be saved each second.
- If you are collecting data based on distance with a survey wheel, this number should be set very high.

If you tell the system that you want to collect 60 scans a foot, and you move more than one foot per second, the system is going to look for scans which aren't available. This is called dropping a scan. Assuming your T_RATE is 100 KHz, this setting should be at 120 whenever you are collecting with a survey wheel and are collecting a max of 512 samp/scan.

If you set this value higher than possible given the 100 KHz T_RATE and the number of samples/scan, the SIR 3000 will automatically lower it to the maximum possible.

SCN/UNIT: The last choice is SCN/UNIT, or scans per unit of horizontal distance. This parameter is the scan spacing when you are collecting with the survey wheel.

- Having a smaller scan spacing produces higher resolution data, but larger file sizes. The number here is the number of scans that the system will collect per unit of distance. So for example, if you see a 12 here and the system is set to English feet, rather than Metric units, you will collect 12 scans per foot, or 1 per inch.
- The StructureScan setting for shallow structural features in concrete is 60 scans/foot or 5 scans/inch. The StructureScan setting also allows you to set to 7.5 and 10 scans/inch. Ten per inch is the densest recommended scan spacing, and it is only meant for the 1.5/1.6 GHz, 2.0 GHz Palm and the 2.6 GHz antennas.
- Lower frequency antennas, like the 400 MHz will require coarser scan densities (12-24 scans/foot).

GAIN: This value is for display purposes. It will apply a display gain to the data that may make the data easier to view while collecting. This will not be saved with the data file.

GAIN

Gain is the artificial addition of signal in order to counteract the natural effects of attenuation. As a radar scan travels into the ground, some of the scan is reflected, some of it is absorbed, and some of it keeps traveling down. As the scan gets deeper, it becomes weaker. We apply gain to the scan to make the subtle variations in weaker data more visible. The two choices under the gain menu are a MANUAL/AUTO toggle and a listing of point numbers.

- Setting the GAIN to MANUAL will allow you to change the number of gain points and to add strength to the signal at your own discretion. This is not recommended for inexperienced users as it is possible to ‘create’ features in the data by over-gaining areas.
- Setting the gain back to Auto will cause the system to re-initialize and adjust its gains to the area under the antenna. This is useful if you find that your data is clipped (over-gained) over a particular section of your survey area. Just place the antenna on the area where the data is clipped area and toggle the gain to Manual, and then back to Auto. This will cause the system to reset the gains to a lower level, and prevent clipping.
- Gain is applied at a number of evenly spaced points throughout the data scan. You can select up to 5 gain points, and then manually add or subtract gain values from individual points.
- The gain curve is visually represented by a red line in the O-Scope window on the Setup screen. Values increase from left to right and the location of gain points is shown by a change in the slope of the curve.
- Use caution not to add too much gain to a single point because you may create what will look like a layer in the data. The software will automatically adjust lower gain points to be equal to or greater than higher points. This is done to avoid a negative gain slope.

Note: The SIR 3000 is only displaying about 25% of the amplitude range. This means that even if your data appears slightly clipped, the SIR 3000 is likely still recording the full amplitude range of the reflection. If you use a –12 dB display gain, you will see an accurate representation of the recorded scan. This also means that when you view your data in RADAN, it will appear under-gained and you will need to add some display gain.

POSITION

This menu controls the position of Time-Zero. Time-Zero is the location of the beginning of the time range, and thus the beginning of the scan. Typically, having the system auto locate itself is enough to adequately set the position. If however, you need to manually adjust the location of Time-Zero, this is the place to do it. Position contains three additional menus: MANUAL/AUTO, OFFSET, and SURFACE.

MANUAL/AUTO: The MANUAL/AUTO toggle will allow you to make adjustments in manual mode and cause the system to re-servo (just like in the gain menu) when switched back to auto. GSSI recommends that inexperienced users keep the position set to Auto. This choice is automatically set to MANUAL if you are using sample densities of 4098 or 8192.

OFFSET: This is an internal system parameter that describes the time lag (in ns) from the SIR 3000 triggering the pulse inside of the control unit until we consider it to have transmitted from the antenna itself. Since there is no way to accurately measure the exact moment the pulse leaves the antenna, we use the antenna's direct coupling to figure out the appropriate point to set the offset (and thus the transmit pulse). The direct coupling is the pulse that travels inside of the antenna housing, directly from the transmitter to the receiver, and it is generally considered to be the first response in the data.

As long as the antenna dipoles are not very far apart, as is the case with a separated bistatic antenna pair, the direct coupling happens before any reflections from the ground. So if we make sure that we have the direct coupling visible in the data, we can be sure that we have 100% of our data and most importantly, the ground surface to perform a depth calculation. The number here is nanoseconds from trigger pulse inside the SIR 3000. If you need to adjust this parameter, use caution not to lose that direct coupling wave.

SURFACE: SURFACE, is a useful display option and is new to the SIR 3000. This allows you to visually 'cut out' the flat part of the scan and the direct wave, and show the scan from the first reflected target, which should be the ground surface. The other information is still collected and saved, but not displayed. This allows you to set the display to show an in-field time to depth calculation. For simplicity, the value is set as a percentage of the total vertical window. The SIR 3000 will examine the offset and the antenna type you entered under RADAR to find the proper surface automatically. It will set near to the first positive peak of the direct coupling. In the image at the right, the antenna was moved up and down over the ground surface. Notice how the surface reflection moves up to join the direct wave.

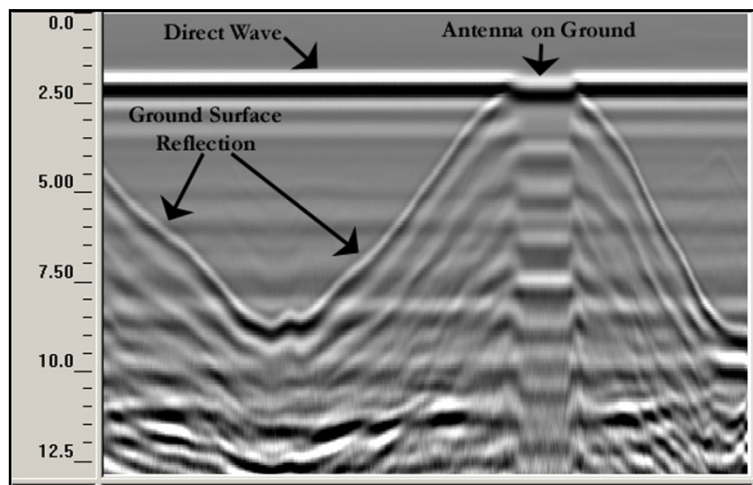

FILTERS

This menu allows you to set data collection filters to either remove interference or smooth noise. Many of these are antenna-specific, especially the High and Low Pass filters. In ConcreteScan, StructureScan, UtilityScan, and GeologyScan, these will be automatically set when you choose your antenna under the RADAR menu. **In order to set factory values for the filters you must recall a factory setup for the antenna you are using under SYSTEM > SETUP > RECALL.** There are six menu selections here:

- LP_IIR
- HP_IIR
- LP_FIR
- HP_FIR
- STACKING
- BGR_REMOVAL

LP_IIR, HP_IIR, LP_FIR, HP_FIR: The first four are frequency filters and the values are all expressed in MHz.

The two types of filters that we are using are the Finite Impulse Response (FIR), and Infinite Impulse Response (IIR). We are using these to downplay external interference, and thus clean up the signal. The FIR filter does this without altering the phase of the signal. For some antennas we also use a very low IIR filter to clean certain characteristics of that antenna's signal. These filters are antenna-specific and are set automatically when you recall the proper setup for your antenna.

FIR filters should not be used with 4096 or 8192 samples per scan.

- LP stands for low-pass, which means that any frequency lower than the one entered here will be allowed to pass by and be recorded by the system.
- HP stands for high pass, which means that any frequency higher than the one entered here will be allowed to pass by and be recorded by the system.
- By setting these at different ends of the antenna's bandwidth, you are determining the range of frequencies that the antenna is filtering out.
- The default values will be adequate in almost all situations.

STACKING: After the frequency filters, the next choice is Stacking. Stacking is a high-frequency noise reduction technique. It is an IIR filter which operates in the horizontal direction. Each new scan has a 1/n influence in the data, so this filter has a tendency to smooth high frequency targets and accentuate low frequency horizontal features, such as layers. As the number of scans you stack (n) increases, the influence of each new scan drops. If you put in a very high number, you will filter out high frequency targets in your data. This might lead to missing real targets in your data.

- High frequency noise generally has a 'snowy' appearance.
- The larger the number you put in here, the smoother the data will be. It is possible to over smooth and 'smudge' out real data.
- A larger number also means that the system is performing a great deal of extra calculations and data collection speed will then be reduced.

BGR_REMOVAL: The Background Removal filter is a horizontal high pass (remove low frequency noise) operation meant to remove flat-lying noise associated with antenna ringing.

The input number here is scans, so in order to use this filter, find the length in scans of the feature that you want to remove and put that number into the system. Features of this size or larger will be removed from the data.

- Also please note that this filter will remove your direct coupling, making positive identification of Time Zero difficult. To preserve data integrity it is best to collect data without this filter and then apply it in playback or post-processing if needed.

The PLAYBACK Menu

If you want to review the data you just collected or access any of the Playback functions, push the Down arrow to highlight the particular menu choice.

If you would like to review a previously collected file, pushing the Playback function key will bring up a window that lists stored data files.

If you select a single file, it will cycle through that one, or you can choose multiple files and the system will play them back in sequence.

The playback menu has two sub-menus:

- SCAN (page 19)
- PROCESS (page 19)

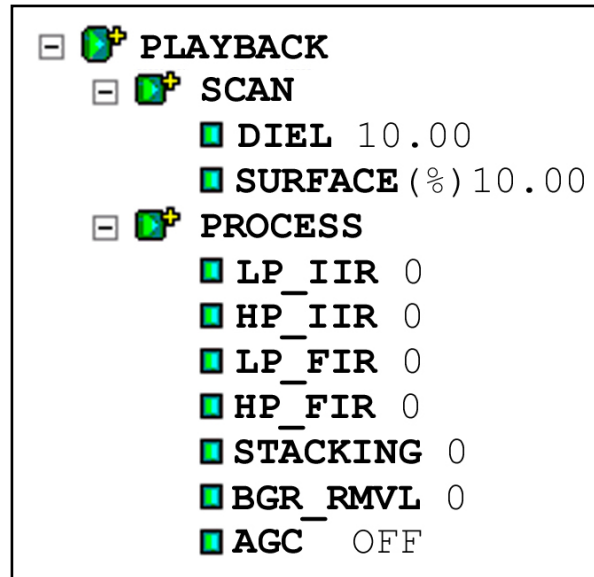

SCAN

The scan sub-menu contains two parameters: DIEL, and SURFACE.

SURFACE: Surface operates just like the surface item in the Position sub-menu of Collect menu, and it has been duplicated here for convenience. Once again, this input is percentage based. Changing the surface position here will not permanently eliminate any data.

DIEL: The Diel parameter allows you to input the dielectric constant so that the system can do a time to depth calculation. Once again, for convenience, this parameter is duplicated from the Scan sub-menu of the Collect menu. Possible values are 1-81.

PROCESS

This menu allows you to apply different filters and mathematical operations to the data in order to remove noise or make subtle features more visible. These functions do not permanently alter the data, but are only for display purposes.

STACKING: Stacking in Playback Mode differs from the Stacking function in Collect Mode. The Playback Stacking is also a horizontal, high-frequency noise reduction technique, but here it is an FIR filter with a boxcar shape.

BGR_REMOVAL: The Background Removal filter is a horizontal high pass (removes low frequency noise) operation meant to remove flat-lying noise associated with antenna ringing.

The input number here is scans, so in order to use this filter, find the length in scans of the feature that you want to remove and put that number into the system. Features of this size or larger will be removed from the data.

AGC: AGC stands for Automatic Gain Control. AGC lets you choose a set number of gain points (2, 3, or 5) distributed evenly through the vertical scale. The object of AGC is to normalize (make even-looking) the scan by reducing the gain for areas where the signal is very strong (usually near the surface), but adding gain with increasing attenuation (usually with depth). This dramatically slows the scroll speed of the data, especially if 5 points are used. A faster option is Display Gain, located under the Display sub-menu in Output.

The OUTPUT Menu

This menu controls the data display, printing, and file maintenance. There are two sub-menus to the Output menu:

- DISPLAY (page 20)
- TRANSFER (page 21)

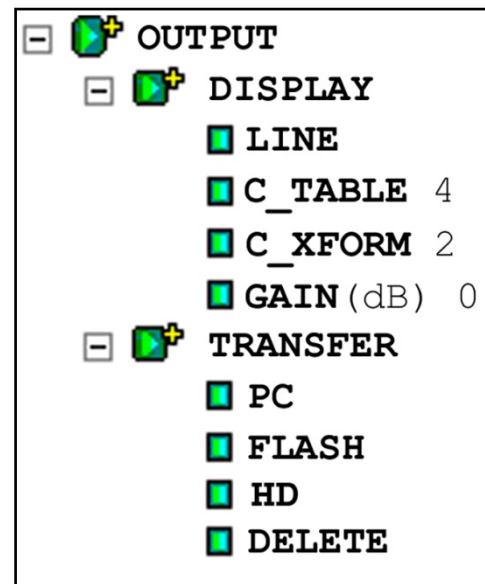

DISPLAY

This sub-menu controls the ‘look and feel’ of the data displayed on the screen. Here is where you can change the mode of display, color table and distribution (transform), and add screen gain. There are four parameter inputs here: Mode (LINE/SCOPE), C_TABLE, C_XFORM, and GAIN(dB).

LINE: This is really the Mode option which allows you to toggle between Linescan and Scope display modes. Linescan is the conventional way of looking at GPR data with each scan stacked next to its neighbor and amplitude values along that scan assigned a color value. Scope, or oscilloscope, mode shows you the waveform of the individual scan.

C_TABLE: This option lets you choose which of the pre-loaded color tables to use to view your data. In addition to grayscale, there are several full color tables. It is sometimes useful to examine your data in a number of different palettes because altering the colors may help you to see different aspects of your data. There are 5 tables to choose from.

C_XFORM: Once you have the data displayed in the proper color table, you may alter the distribution of color shades across your data by changing the color transform under the C_XFORM option. This will spread out your color shades over different sections of the scan’s amplitude range. You would do this to show more color shades over the extremes or the mid-range values, or just a simple black to white. Stretching more colors over a particular value ranges allows you to see more subtle variations in the data. Bear in mind that not every transform is available for every color table. There are up to 4 different transforms available.

GAIN: The final display option is GAIN. This is often referred to as display gain, because it basically just increases the amplitude of your data by multiplying every sample throughout your scan by a constant value. The result is that you will be able to better see weaker reflections, but those already strong reflections will be over-gained. This function is useful for a quick viewing of data that is attenuated or otherwise under-gained to guarantee that it was not clipped.

Transfer

This sub-menu allows you to perform file maintenance. The four options for this sub-menu are: PC, FLASH, HD (hard drive), and DELETE. PC, HD, and FLASH allow you to move data from the internal system memory to an external device, such as a PC, flash card, Microdrive, or an external USB keychain drive. Transfer to a PC will be controlled by the external computer through Microsoft ActiveSync, while transfer to the removable Flash card can be done using the SIR 3000's buttons. For detailed instructions on data transfer, please see Chapter 5: Data Transfer and File Maintenance.

2.4: The Command Bar

The six keys across the bottom of the data display window have different functions depending on whether you are in Setup (3 display windows) mode or in Run (1 display window) mode.

In Setup Mode

You are in Setup mode if you can see 3 display windows with the parameter selection tree at the left. If you only see a single data screen (and no parameter selection tree), you are in Run mode.

You can only collect data in Run mode.

In Setup mode, the Command Bar will look like this:



Setup Mode Command Bar

RUN/STOP: This button stops the transmitter. The green light to the right of the Run/Stop button will turn off. If you are in Setup mode (3 display windows), this will stop data from continuously scrolling across the screen. If you are in RUN mode (a single display window), this will stop the data collection and bring up crosshairs. You can then use the arrow keys to move the crosshairs over your data. You will see two sets of numbers at the bottom-right of the screen. These give the location of the crosshairs. The first number is the distance from the beginning of the profile, and the second is depth. Pushing this button again will bring up the Save File window. After selecting YES or NO, you will automatically begin collecting the next profile. The Run/Stop button under the marker button on the right hand side of the system has the same function as this key.

COLLECT: This button has three main functions. The first is to toggle between the Collect and Playback modes. You will know which mode you are in by looking at the top-left corner of the screen. It will say either COLLECT or PLAYBACK, then the File that you are on.

The second function is only in Collect Setup mode. From Collect Setup (3 display windows), pushing this button will cause the transmitter to momentarily turn off, then back on. This dumps the display buffer and restarts the data scroll.

The third function is during the Collect Run mode (1 data window). Pushing this button while collecting data stops data collection, brings up the Save File dialog, then immediately opens another data file collection.

PLAYBACK: Pushing this button from the Collect Setup mode (3 display windows, COLLECT in the top-left corner), brings up the File Open window. This window shows stored data files that are in the current directory on the memory card. Highlight a data file with the arrow keys and push Enter to put a check in the box next to it. Click the Right arrow to enter and accept. The data will start to scroll across the screen. Make any necessary changes under the Process menu and then click Run/Setup to toggle to the Playback Run screen (1 display window). The whole data profile will scroll across the screen. When it has finished scrolling, it will stop and crosshairs will come up. This will allow you to check distance and depth of targets and to scroll back and forth through your data.

RUN/SETUP: This button toggles between Run mode (1 window) and Setup mode (3 windows). Pushing this while in Collect Setup begins data collection. The TerraSIRch will beep twice, then switch to Run mode. It will then beep twice again, and then it is ready to accept data. Pushing this while collecting data will cause it to beep twice again and bring up the Save File dialog. It will then go to Setup (3 windows) mode.

Pushing this while in Playback Setup will open the Playback Run mode (1 window). The data file you selected in the Open File window will scroll to the end, then stop. Crosshairs will come up. Pushing this again will take you back to the Playback Setup (3 windows).

COLOR TABLE: Pushing this key will allow you to scroll through the 5 available color tables. The TerraSIRch will redraw the data from the beginning of the display buffer in that new color. You can also change the color table under the OUTPUT > DISPLAY menu. This function is only available in Setup Mode.

COLOR XFORM: This button allows you to scroll through the different color transforms available for some of the color tables. A color transform is a different spread of the same colors over the amplitude range of the scan. You might use a transform that has a lot of colors spread over the middle if you want to highlight variation in weak targets. Only 3 of the 5 color tables have transforms available. The red/white/blue and one of the grayscales are linear color tables and cannot be transformed. You can also change the color transform under the OUTPUT > DISPLAY menu. This function is only available in Setup Mode.

In COLLECT RUN Mode

This is what the Command Bar will look like if you are in Collect Run mode. You are in Collect Run mode if you can see 1 display window. If you see 3 data display windows and the parameter selection tree), you are in Setup mode.

You can only collect data in Run mode.

In Run mode, the Command Bar will look like this:

RUN/STOP	NEXT FILE	PLAYBACK MODE	RUN/SETUP	DISPLAY	DEPTH
-----------------	----------------------	--------------------------	------------------	----------------	--------------

Collect Run Mode Command Bar

RUN/STOP: Pushing this button in Collect mode will stop data collection and bring up crosshairs. Pushing this again will close the data file, bring up the Save File window, then start a new data file collection.

Pushing this in Playback mode will toggle the system from Stop to Run and the selected file will scroll across the screen to the end and bring up crosshairs. Clicking the button after the file has stopped will cause it to scroll through again.

NEXT FILE: Clicking this button in Collect Run will stop the current data and bring up the File Save dialog. After saving the file, the system will immediately begin collecting the next file. This command is unavailable in Playback Mode.

PLAYBACK MODE: Clicking this button in Playback Run will bring up the Open File dialog so that you can select another file to view. Clicking this in Collect Run will close the current collection, ask you to save the data, and open the Open File window so you can choose a file to view. Clicking this in Playback Mode will bring up the playback file selection box.

RUN/SETUP: Pushing this in Collect mode will cause the Save File window to come up and close the current data file. You will then toggle to Setup Mode (3 windows). In Playback mode this key toggles between Run and Setup.

DISPLAY: Pushing this key toggles between a linescan data display and a single scan O-scope style display. The function is the same in Collect or Playback.

DEPTH: This button allows you to calibrate the system to a target with known depth. This will update the vertical scale and the dielectric and give you a more accurate depth calculation than simply guessing dielectric or soil type.

- 1** Scan over your area and find a target. Once you do, do not stop data collection, but just move the system away from that area.
- 2** Drill or dig down and measure the depth.
- 3** Back at the system, click Run/Stop to bring up crosshairs.
- 4** After the crosshairs come up, target them on the first positive peak of that target if it is metal, and the first negative peak if it is air. Positive peaks stick out to the right (white in a grayscale color table), and negative peaks stick out to the left (black in a grayscale color table). Push DEPTH and scroll to the correct depth. Click right to take effect.

Note: If you are on dirt, the dielectric value may only be an approximation.

If you are on a homogenous material, like concrete, this calibration is good for all like material. If you are on soils, know that the dielectric of the soils can change dramatically with depth and across an area, so this is only an approximation.

Calibrating the depth in TerraSIRch mode updates the dielectric constant but keeps the fixed time range. This function in ConcreteScan, StructureScan, UtilityScan, and GeologyScan keeps the entered depth (under scan) but updates the time range required to scan to that depth given the new dielectric. After calibrating in one of these four programs (not TerraSIRch) click Run/Stop twice to reinitialize the gains.

In PLAYBACK RUN Mode

This is what the Command Bar will look like in Playback Run mode. This mode is accessible from the Playback Setup screen by clicking Run/Setup. After clicking Run/Setup the data file will scroll out to the end and a set of crosshairs will appear. You can use the arrow keys on the keypad to scroll left and right to view long data files. The functions here operate very similarly to Collect Setup with two main differences. These differences are in Run/Stop and Save Image.

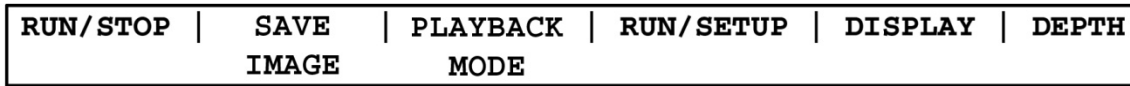

Playback Run Mode Command Bar

RUN/STOP: This button functions as a screen refresh in Playback Run. Pressing this will cause the data file to re-scroll from the beginning.

SAVE IMAGE: This function will take a screen shot of the data file and save it as a bitmap (.bmp) in your working directory. Although bitmaps cannot be viewed on the SIR 3000, you can transfer them to a PC and view, email, or print them later. Bitmaps do not require any special software to view on the PC and anyone with a PC or Mac will be able to view them. They are automatically transferred when you transfer a data file and are automatically deleted when you delete that data file. The filename of the bitmap is similar to the radar data file name. For example, if you are playing back FILE____020.DZT and want to save an image, then the bitmap will be called FILE____020A.BMP. The “A” tag is there if you want to take multiple images of the same file. The next bitmap will be called “B”. The Save Image function will only take a view of the current screen, so if you have a very long data file, then multiple image saves will be required.

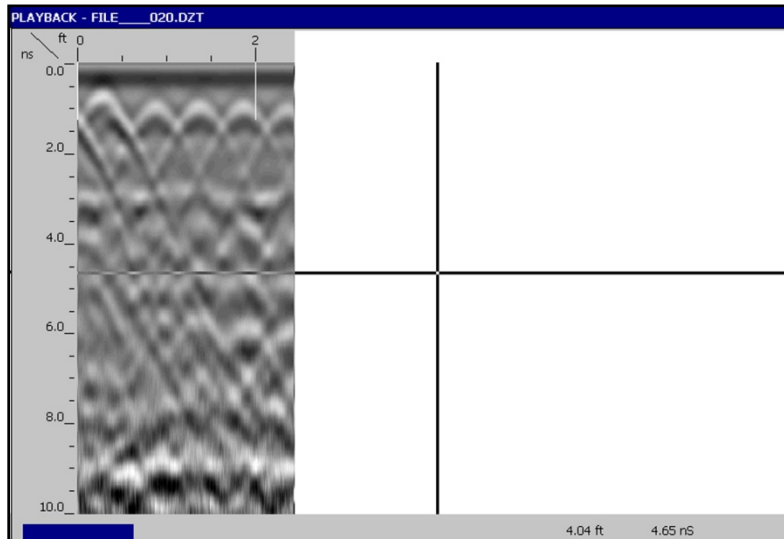

Save Image Example

Chapter 3: Setting Up Your System for Data Collection in TerraSIRch Mode

In this chapter you will find instructions for configuring your SIR 3000 to collect single 2-D profiles of data that can be interpreted by themselves or stacked together in software to produce a 3-D image. You will find instructions for setting up and collecting a 3-D project using the Quick3D Collection mode in Chapter 4.

The first section of this chapter includes a step-by-step checklist to set up your system. This refers to the software setup only, not the hardware setup. If you are using a survey cart, please see Appendix C, otherwise see section 2.1.

These first two parts also assume that you are collecting distance-based data with the survey wheel. If you are collecting data where the scan spacing is based on time (Time-based), see section 3.3, and if you are collecting single Point data, please see section 3.4.

Note: If the external memory card is inserted into the system before you turn it on, all data files will be *automatically* collected to that memory card. They will *not* be saved to the internal memory.

Note: Due to constraints on the internal memory, the largest single profile you can collect is 64 MB. At 512 samples/scan and 12 scans/foot, this translates to 5200 feet, or roughly one mile.

Note: You can collect up to 70 files before you need to power down the system and restart it. If you collect more than 70 without restarting the system, the SIR 3000 will hang up and you will lose that data profile that you are collecting and will need to restart the system. Remember to reload any saved setups and recheck your collection parameters to be sure that they are the same as they were before you powered down. This may also corrupt your setup file.

3.1: Setting Up for 2-D Data Collection

Step 1:

After system boot-up, press the TerraSIRch function key. After a few seconds, you will see a split screen with a wiggle trace on the right, the parameter selection tree on the left, and the main data display window in the center. If you have an antenna connected, a blue wait bar will scroll twice across the bottom left corner of the screen (initializing the antenna), and data will appear in the center window.

Step 2:

Examine the parameters in the Collect tree to ensure that the system is properly configured for the antenna you are using.

1 Load SETUP

Under the System menu, open SETUP and RECALL a factory setup for the antenna that you are using or a saved setup that you have worked with previously. A setup will also sometimes contain a preloaded survey wheel calibration value that makes it easier to use your antenna with a survey cart. These setups will have the antenna frequency value and then “cart” or “sw.” Setups with cart are for the large three wheeled survey cart. Those with sw are for the tow-behind survey wheel. For example, if you have a 400 MHz, use a setup which begins with 400.

Helpful Hint: If you are using the 1500 MHz or the 1600 MHz antenna with the blue metal minicart, use setup 1500BlueCart or 1600BlueCart.

2 Survey Wheel Calibration

Make sure that MODE is set to DISTANCE. Once you select DISTANCE, the survey wheel calibration dialogue will come up. You can either enter the factory setting (for smooth terrain) or calibrate it to local conditions. If DISTANCE already is shown as the selection, you should still check that the calibration is correct by selecting another choice and then selecting DISTANCE.

In order to manually calibrate the antenna for difficult terrain, you will need to lay out a measured line on your survey surface. It can be of any length, but the longer the line, the more accurate the calibration.

Enter the calibration distance and position the antenna at the start of the calibration line. The exact part of the antenna (front, center, rear) that is positioned at the beginning of the line must finish at the end of the survey line. This is critical for an accurate calibration. Follow the onscreen instructions to calibrate the wheel. Once you are satisfied with the calibration value, click the right arrow to save this value and exit the calibration window. Repeat this procedure several times and take the average result.

If you prefer to enter in the value manually, click the mark button to highlight the New Calibration Value choice and use the up and down arrows to enter in the correct value. Then click the right arrow to save and exit.

Default Settings for the Survey Wheel are:

Helpful Hint: These default values are provided for convenience, but it is always advisable to calibrate your survey wheel to obtain a more accurate value.



Model 611 (3 5/6" wheel):

Model 613 StructureScan Cart or single wheel (900 MHz)

2000 ticks/meter

609.6 ticks/foot



Model 620 (16" wheel):

400 MHz and 200 MHz tow-behind

417 ticks/meter

127 ticks/foot



Model 623 Survey Cart

UtilityScan Cart:

-1785 ticks/meter

-544 ticks/foot



Model 643 Survey Cart

3140 ticks/meter

960 ticks/foot

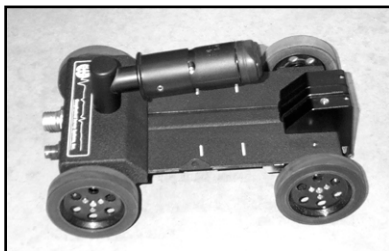

Model 614/615 Survey Minicart

Blue metal StructureScan Cart with or without bar code reader

4030 ticks/meter

1229 ticks/foot

Note: If you set the horizontal units on the SIR 3000 (under SYSTEM > UNITS > DISTANCE) to inches or cm, you will need to input the calibration default in ticks/inch(cm). For inches, divide the ticks/ft by 12 and for cm, divide by 100.

To quickly input a default calibration number, open the calibration dialogue and simply spin the wheel until the total number of ticks is equal to 10 times the default value.

3 Check RANGE

With the system in Collect Setup mode and data scrolling across the screen, drag the antenna over the area and find a target that you want to image. Note its position on the screen and at what time/depth it occurs. Ideally, it should be halfway down the screen so that you can image targets above and below it. If it is not properly located, change the range under the Scan menu. You may also take one quick profile over your targets and note where they fall on the data window. If your vertical scale is set to depth, you can change it to Time under SYSTEM > UNITS > VSCALE. This may help you to estimate the correct range value.

4 Check SCN/UNIT

Generally you need a minimum of 10 scans to draw a recognizable hyperbola. The rule of thumb is to have 10 scans divided by the depth of the shallowest object. So if you want to image something 10 feet deep, 10 scans / 10 feet = 1 scan/foot. For 5 feet, 10 scans / 5 feet = 2 scans/foot.

For locating structural features in concrete with the 1.5/1.6 GHz antenna, we usually recommend 90/ft. For utility and tank location, we usually recommend 6-24/ft. While this is more than the minimum rule of thumb, GSSI has found these densities to work well in the widest variety of situations.

The image below shows hyperbolas from objects of similar size. The hyperbolas vary in size because, due to the spreading of the radar signal, a deeper target shows reflections in more scans than a shallow one,

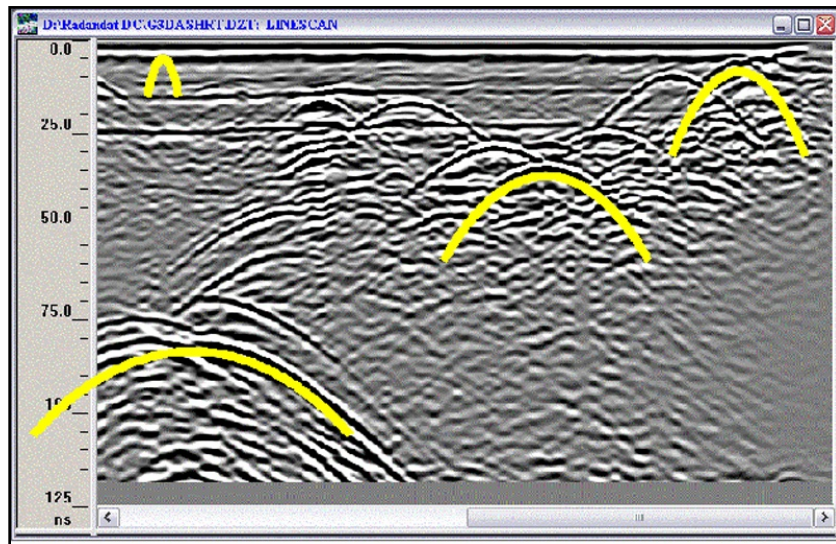

5 Check GAIN

The thin, red line superimposed over the scan in the O-Scope window is the gain curve. The centerline of the scan is zero and to the left of it is negative (decreasing gain) and the right is positive (adding gain). Ensure that the scan is visible (you can see curves). Gain is applied in dB along an exponential function to more closely model loss.

If not, select AUTO under the Gain menu. This will cause the system to re-initialize and add/subtract gain to produce a visible signal. Drag the antenna over the area and look for evidence of clipping. If your data becomes clipped, leave the antenna over the area where it is occurring and re-initialize by changing AUTO to MANUAL and then back to AUTO. This will depress the gains so that the data will not clip. Once you find gain settings which are workable (you can see targets and the signal does not clip), it is usually best to set the gain to MANUAL. This will allow you to collect multiple profiles that you will be able to compare without the gains being altered automatically.

Step 3:

Push the function key under RUN/SETUP to begin collecting a profile of data. The system will beep twice to open the Collect Run window (1 display window) and then beep again when it is ready to receive data. You can also click the marker button on your antenna handle to open a data collection. At the end of your profile, push and hold down the Run/Setup key to stop data collection. The profile will be saved and can be viewed in Playback mode.

If you wish to collect another profile with the same settings, you can click NEXT FILE. The SIR 3000 will ask you if you want to save the data. The system is in a paused state, so with that dialog open, move the system to the beginning of the next profile line and then click Right arrow to save. The SIR 3000 will save the data and then begin collecting another profile.

3.2: Setup for Single Line 3-D Collection in TerraSIRch

Follow these instructions if you want to build a 3D area out of multiple individual survey profiles. You will save each profile as a different file and create the 3D project in RADAN's 3D QuickDraw module. This is an alternative to the Quick3D Data Collection mode discussed in section 3.5.

Step 1:

Follow all the above steps for 2D in order to set your SIR 3000 to local conditions and antenna choice.

After you have set the gains so that you do not clip, set the POSITION and GAIN under the Collect menu to MANUAL. This will ensure that you do not accidentally auto-gain or auto-position over a different area while collecting. Gaining over a different area will produce data that is 'mosaicd.' Gain differences will mask features and create edge-effects.

Step 2:

You must lay out your survey grid so that you can cross your targets with at least 3 profiles. Three profiles will allow you to tell the difference between a point target and a linear target. For example, if you are looking for graves 2 meters in length, your survey profiles should be spaced no more than 0.5 m apart, and try to orient your survey grid so that you cross the graves perpendicular to their long axis in order to have the greatest possibility of hitting them.

Step 3:

In order for your data to be properly positioned in RADAN 5.0 (or higher), you must be able to tell the software your survey grid origin, line direction, and line orientation. You may begin your survey in any corner of the grid and survey either in one direction, or zig-zig back and forth.

Step 4:

Collect the data. Collect each survey profile as a separate file. Do not reset the gains or do anything to cause the system to re-initialize the gains. If you accidentally reset the gains, either reinitialize the system over the area that you originally set the gains on, or manually enter the gain values you have used previously. It is best to set the gain to manual before beginning a 3D survey. That way, if you need to change batteries in the middle of a grid, you will not cause the system to auto-gain. Be sure to keep accurate notes showing the location of each file in relation to other files and immovable objects. You will assemble the 3D project in RADAN and 3D QuickDraw after downloading the data to a PC.

3.3: Setting Up for Time-Based Data Collection

The scan spacing (horizontal resolution) of Time-based data profiles is a function of the speed that the system is collecting data and the rate that the antenna is moving over the survey surface. The higher you set the RATE (in scans/second) and the slower you move the antenna, the denser the data will be.

Time-based data has no real distance tag, so the software has no idea how far you actually traveled. It is extremely important to move the antenna at a constant speed and to add user marks (by clicking the mark button) at consistent intervals. Time-based data requires additional processing in RADAN to create a 3-D image. If 3-D imaging is your goal, you should collect Distance based data with a survey wheel.

Step 1:

After system boot-up, press the TerraSIRch function key. After a few seconds, you will see a split screen with a wiggle trace on the right, the parameter selection tree on the left, and the main data display window in the center. If you have an antenna connected, a blue wait bar will scroll twice across the bottom left corner of the screen (initializing the antenna), and data will appear in the center window.

Step 2:

Examine the parameters in the Collect tree to ensure that the system is properly configured for the antenna you are using.

1 Load SETUP

Under the System menu, open SETUP and RECALL a factory setup for the antenna that you are using or a saved setup that you have worked with previously.

2 Check MODE

Under the Collect > Radar menu, ensure that MODE is set to TIME.

3 Check RANGE

With the system in Collect Setup mode and data scrolling across the screen, drag the antenna over the area and find a target that you want to image. Note its position on the screen and at what time/depth it occurs. Ideally, it should be halfway down the screen so that you can image targets above and below it. If it is not properly located, change the range under the Scan menu.

4 Check RATE

This number will be scans per second. Your data density now depends on the rate you move the antenna over the survey surface. Typically this value is set much lower than the maximum.

5 Check GAIN

The thin, red line superimposed over the scan in the O-Scope window is the gain curve. The centerline of the scan is zero and to the left of it is negative (removing gain) and the right is positive (adding gain). Ensure that the scan is visible (you can see curves). If not, select AUTO under the GAIN menu. This will cause the system to re-initialize and ADD/REDUCE gain to produce a visible signal. Drag the antenna over the area and look for evidence of clipping. If your data becomes clipped, leave the antenna over the area where it is occurring and re-initialize by changing AUTO to MANUAL and then back to AUTO. This will depress the gains so that the data will not clip.

Step 3:

Push the function key under RUN/SETUP to begin collecting a profile of data. The system will emit a beep when it is ready to receive data. At the end of your profile, push and hold down the Run/Setup key to stop data collection. The profile will be saved and can be viewed in Playback mode.

3.4: Setting Up for Point Data Collection

The third data collection mode on the SIR 3000 is for Point data collection. This mode is most useful for deep geophysical investigations or data collection over difficult, broken terrain.

In Point mode, we are recording single scans over an area. The scan spacing (horizontal resolution) of Point-based data profiles is a function of how far apart you set your collection points.

Step 1:

After system boot-up, press the TerraSIRch function key. After a few seconds, you will see a split screen with a wiggle trace on the right, the parameter selection tree on the left, and the main data display window in the center. If you have an antenna connected, a blue wait bar will scroll twice across the bottom left corner of the screen (initializing the antenna), and data will appear in the center window.

Step 2:

Examine the parameters in the Collect tree to ensure that the system is properly configured for the antenna you are using.

1 Load SETUP

Under the System menu, open SETUP and RECALL a factory setup for the antenna that you are using or a saved setup that you have worked with previously.

2 Check MODE

Under the Collect > Radar menu, ensure that MODE is set to POINT.

3 Check RANGE

With the system in Collect Setup mode and data scrolling across the screen, drag the antenna over the area and find a target that you want to image. Note its position on the screen and at what time/depth it occurs. Ideally, it should be halfway down the screen so that you can image targets above and below it. If it is not properly located, change the range under the Scan menu.

4 Check GAIN

The thin, red line superimposed over the scan in the O-Scope window is the gain curve. The centerline of the scan is zero and to the left of it is negative (reducing gain) and the right is positive (adding gain). Ensure that the scan is visible (you can see curves). If not, select AUTO under the Gain menu. This will cause the system to re-initialize and add/reduce gain to produce a visible signal. Drag the antenna over the area and look for evidence of clipping. If your data becomes clipped, leave the antenna over the area where it is occurring and re-initialize by changing AUTO to MANUAL and then back to AUTO. This will depress the gains so that the data will not clip.

5 Check STACKING

Point data is typically collected with some static stacking. The default value here is 64. The system will take 64 scans at that location and average them together to output a single scan. This is done to minimize high-frequency, random noise.

Step 3:

Position the antenna at the first data point station and press Run/Setup. You will see the blank, 1-pane Run screen. Press Run/Stop to collect a point of data. The blue wait bar will scroll at the bottom-left of the screen while the system is busy recording and stacking your data. When it is finished, the collected scan number will appear above the Command Bar. Re-position your antenna at the next collection point and push Run/Stop to collect another point. When finished with the collection, press Run/Setup to return to the setup screen and save your data.

Chapter 4: Using the Quick3D Collection Mode

This mode is designed to help you easily collect 3D data on an area of any size and surface. This will allow you to enter in a grid size and profile spacing and the SIR 3000 will show your current survey location and guide you through your survey position. During the survey, each individual survey profile is saved as it is collected, and at the end, the SIR 3000 will create a special folder and file which will contain positioning information that RADAN needs to display your data. In essence, Quick3D allows you to skip the 3D file creation step in RADAN.

The next section explains the file structure of a Quick3D file and the sections following explain the field use and implementation in RADAN of Quick3D files.

4.1: Quick3D File Structure

The Quick3D data collection mode creates a folder on your SIR 3000 memory card with the name of the grid followed by the extension .3DS. Inside of that folder are all of the DZT files and a file with the extension B3D (Build 3D).

DZT files are your actual survey profiles. When you open a radar file in RADAN, you are opening up the DZT file. In the Windows XP screenshot example below, a 25 foot wide area was surveyed in one direction only with profiles every 1 foot. We end up with 26 DZT files (1 every foot and the beginning line) and 1 B3D file. The Grid was named GRID__006.3DS. This grid name was automatically generated by the SIR 3000.

Note: The example window is not a SIR 3000 screen image. It is an image from a PC after the data were downloaded.

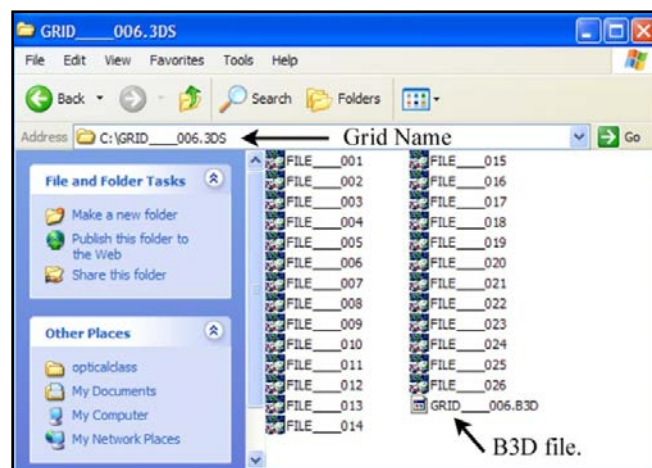

The B3D file is an information file which tells the RADAN software where each of your DZT files is positioned and allows the software to create your 3D file with the proper positioning information. To open the grid in RADAN, you need to open the B3D file. In RADAN go to FILE > OPEN and change the Save as Type to 3D Project File. It will have defaulted to DZT file. You may have to click Open once in order for Windows to display the B3D file.

When you transfer your data from the SIR 3000 to a PC running RADAN, you must transfer the whole Grid folder. Furthermore, do not remove the files from the Grid folder. Keep all files pertaining to that grid in the Grid folder.

So, to sum up: each grid you collect is a separate folder. Inside that folder are all of your radar data lines (DZT files). Also inside that folder is the B3D file which you will open in RADAN. Once RADAN reads that B3D file, it will know which of your data lines to put where. **You must keep that B3D file and all of you data files together in the same grid folder.**

4.2: Setting Up Quick3D Data Grids

Collecting data for 3D imaging is easiest when you have a guide grid laid out to follow. You should lay out a grid with chalk, paint, ropes, or some other method. Your grid can be any size, but your data quality will be much better if you make sure that your grid corners are square. Your grid itself does not have to be a square, it can be a rectangle, or can be irregularly shaped, but if you follow the tips below, you will save yourself a lot of trouble.

Tips for Grid Setup

- If you are scanning in one direction only with a normal profile order (one direction only), you need the grid edge that you start your profiles from (the baseline) to be straight. We understand ‘one direction only’ to mean scanning along only the X or the Y axis, but not both. A ‘normal’ profile order is one where you are collecting data along your profile in one direction. In other words, you start at the baseline, collect your data until the end of the line, pick up your system and move it back to the baseline to collect the next profile in the same direction. This is different from zig-zag where you are simply turning around and collecting the next data file in the opposite direction from the previous. If you are collection with a zig-zag order, both the start and finish baselines should be straight.
- Your grid can be irregular, but as long as the line that your profiles start from is straight, the RADAN software will have no problem lining things up.
- Make sure that your grid corners are right angles and that your grid lines are actually perpendicular to your baseline. The graphic below illustrates how to put together a square, 10×10 grid.

- 1** Locate the origin point (0,0) and pull a tape measure 10 to find the point 10,0 (blue line: a). This is your baseline.
- 2** Pull one tape measure 10 from 0,0 (line b) to 0,10. Pull the other one from 10,0 to 0,10 (line c).
- 3** Move both tapes together so that 10 on line b connects to 14.14 on line c. The point that they connect is the grid corner. You will know that the corner at 0,0 is square because this method produces a right triangle.
- 4** Repeat for the corner 10,10.

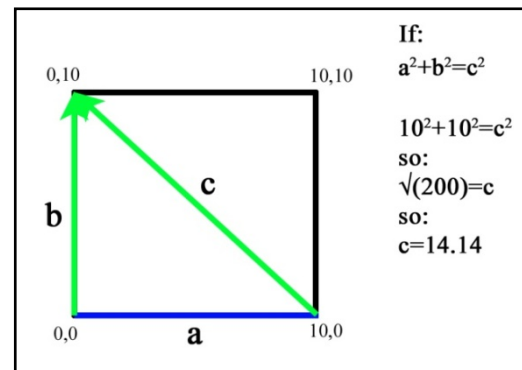

- You can use this method for grids of any size. You can also use this for rectangular grids.
- Make sure to assign X to one axis and Y to the other.
- Photograph or make a sketch map of the grid.

4.3: Setting Up the SIR 3000 for Quick3D Collection

Pictured at the right is the full Collect Menu tree from the Quick3D mode. The blue boxes enclose the menu choices which are new to the Quick3D. The following sections explain what they are and present a step by step guide to set up the software.

New Menu Items

3D-GRID: This menu controls the grid size, profile line spacing, and survey direction.

ORDER: Normal/Zig-Zag. This controls the survey line direction. Normal profiles are all surveyed in one direction. At the end of each line, you must move the antenna back to the starting baseline before moving to the next line and collect along that same direction. A zig-zag order allows you to collect data in both directions.

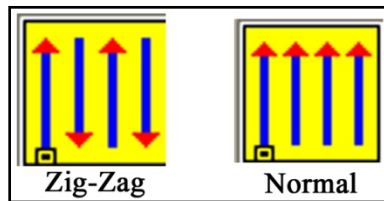

X/Y START: These two items tell the system the coordinate of your origin point. Typically these will both be 0. If you are working on a pre-existing site grid and you want your survey grid origin to have that coordinate, you can put it in here.

X/Y END: The SIR 3000 uses this coordinate to figure out the size of your grid. In the menu tree, the numbers for both the X and Y are 20. This means that the X axis and the Y axis both end at 20, and since the origin is at 0,0 the grid is 20x20.

Note: These numbers are coordinates, not line length. So if you have a 20x20 grid and X/Y START is 10x10, then X/Y END is 30x30.

Xln/Yln_SPC: This is the spacing between your survey lines. X lines are parallel to the X axis and Y lines are parallel to the Y axis. The X spacing can be different from the Y spacing, but the spacing must be regular. For example, you cannot start your grid at one interval and change halfway through to another. If you need to change the line spacing, you must start a new grid with the new parameters. If you only want to collect on the X or the Y, set the line spacing of the direction you are not collecting to 0.

Note: If you intend to collect data in both X and Y and to process that data, you must collect the grid twice: once in X and once in Y, and then combine them in RADAN.

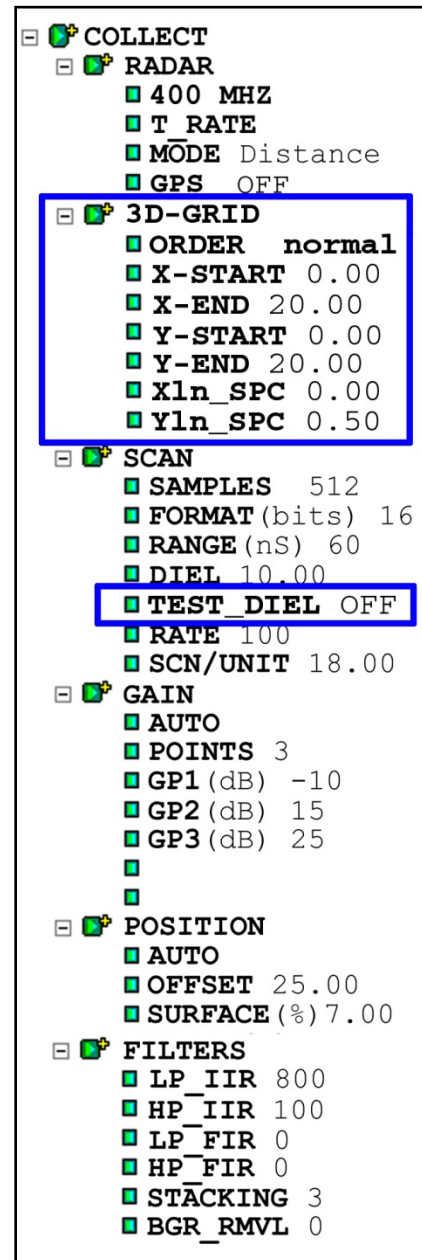

TEST_DIEL: This function allows you to test the dielectric of the material you are scanning through by collecting a section of data and then performing a migration on that data. This is important because if your dielectric is correct, then you know what depth you are scanning to. Highlight this choice and click Enter to bring up a pop-up menu. You will notice that data has stopped scrolling across the screen. With that pop-up menu on the screen, collect a profile of at least 10 feet in length. This profile must go over known targets and must cut across those targets at a right angle. You will now use the Up and Down arrows to adjust the dielectric value so that those hyperbolas collapse to points. After selecting a dielectric value, press Enter to see that take effect. Once you have established the correct dielectric value, click the Right arrow. This will also cause the system to re-initialize.

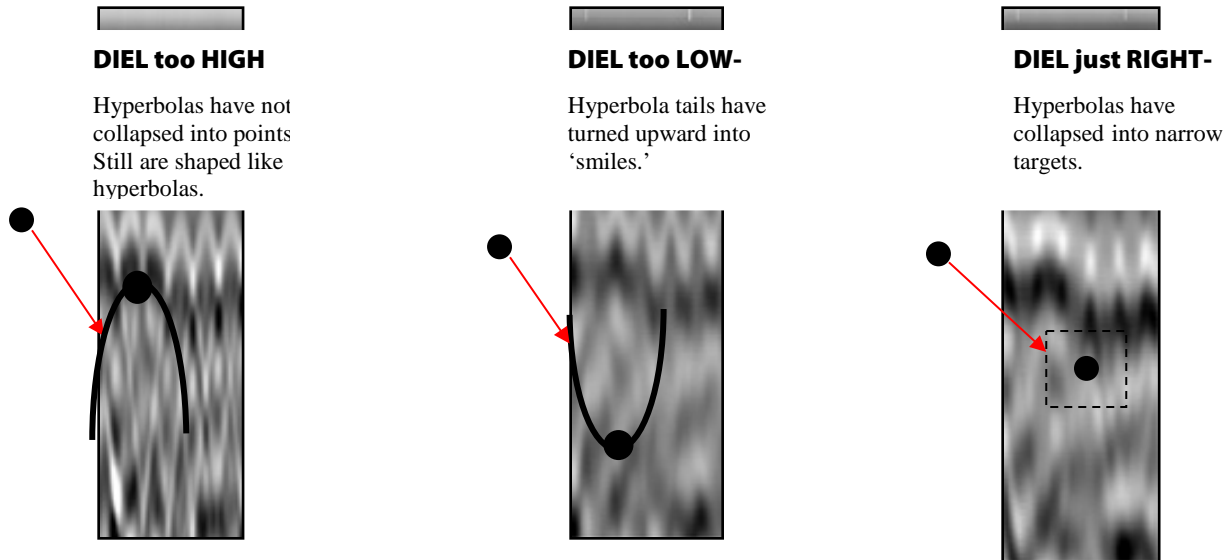

Note: Dielectrics in soils are rarely constant. This method is best suited to find the dielectric in engineered or homogenous materials. Do not use this method to establish a depth approximation in soils.

4.4: Step By Step Software Setup

Step 1:

After system boot-up, press the Quick3D function key. After a few seconds, you will see a split screen with a wiggle trace on the right, the parameter selection tree on the left, and the main data display window in the center. If you have an antenna connected, a blue wait bar will scroll twice across the bottom left corner of the screen (initializing the antenna), and data will appear in the center window.

Step 2:

Load Setup

Under SYSTEM > SETUP > RECALL, find the appropriate Setup. Highlight the one that you want and click the Right arrow to load it. Note that the SIR 3000 will reinitialize. Wait for the data to start scrolling across the screen before continuing. Please see Appendix E for a list of saved Setups. If you do not wish to use one of the saved Setups, you should still recall the Setup that closely matches your antenna's frequency. You should then modify that Setup accordingly.

Step 3:

Perform Survey Wheel Calibration

This is a critical step in 3D file collection because proper positioning of your data is so important.

Make sure that MODE is set to DISTANCE. Once you select DISTANCE, the survey wheel calibration dialogue will come up. You can either enter the factory setting (for smooth terrain) or calibrate it to local conditions. If DISTANCE already is shown as the selection, you should still check that the calibration is correct by selecting another choice and then selecting DISTANCE.

In order to manually calibrate the antenna for difficult terrain, you will need to lay out a measured line on your survey surface. It can be of any length, but the longer the line, the more accurate the calibration.

Enter the calibration distance and position the antenna at the start of the calibration line. The exact part of the antenna (front, center, rear) that is positioned at the beginning of the line must finish at the end of the survey line. This is critical for an accurate calibration. Follow the onscreen instructions to calibrate the wheel. Once you are satisfied with the calibration value, click the right arrow to save this value and exit the calibration window. Repeat this procedure several times and take the average result.

Step 4:

Set 3D-GRID limits

Under the COLLECT > 3D-GRID menu, set your grid limits and line spacing. Normally the X-START and the Y-START should both be set to 0. If your grid is not starting at 0,0 you should put in the coordinates of the origin point here. The only time that you would not want your grid to start at 0 is if it is just a small part of a larger site grid. If you are going to combine grids later in Super3D, you can just leave this number at 0,0 and add real coordinates later. Just remember that your X-END and Y-END are coordinates, not line lengths. If you intend to process the data, you should only collect a 3D file along either the X or the Y, not both. If you want 3D with both directions, you must collect the area twice. For the X, set up the file with a 0 in the Y line spacing, and vice versa if you want to collect for the Y. Collect and save the file, then collect and save a separate file for the other direction. You will thus end up with two 3D files.

Step 5:

Push the function key under RUN/SETUP to begin data collection. The system will beep twice to open the Collection Run window (2 display windows). You will see the Linescan window at the right (it will be blank at first), the Position window at the left, and the Prompt Area at the top. Position your antenna so that its center is in the middle of your start line and push the Mark button.

The 'MARK TO START' message will turn into a 'COLLECT DATA' message. Move the antenna along your survey line. You will see data scrolling across the screen. Once the SIR 3000 has collected enough data (based on your setup parameters), it will stop recoding automatically. Reposition your antenna at the beginning of the next line and continue by following the instructions shown in the Prompt Area.

4.5: Collecting Data

Step 1:

After you have clicked RUN/SETUP from the setup screen, you will see the Run screen (2 windows at right). **You will need to click the Mark button on the SIR 3000 to start data collection.** Each successive line can be started with the remote marker switch on your antenna.

The Prompt Area tells you positioning information and also what to do during collection. The image at the right tells you that you are on your second line, you are scanning parallel to the X direction, and that you should be on the 1 foot mark along your Y baseline.

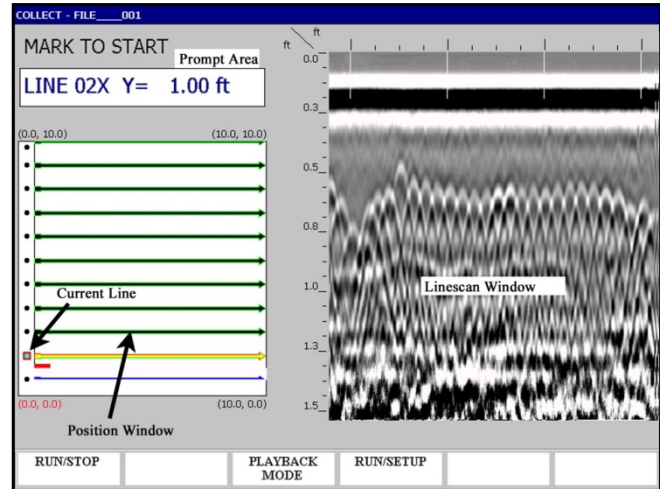

Step 2:

Once you have clicked the Mark button, you will see COLLECT DATA in the prompt area. **Wait for the green light to come on next to the RUN/STOP button.** Collect the profile line. Once you have gone the distance that you specified in the Setup, the SIR 3000 will stop collecting data automatically. It will save the file and automatically increment to the next line.

Step 3:

If you need to skip or redo a profile, use the arrow keys to highlight that file and then press Mark. The new data file will then be stored with the proper positioning info and any old data will be overwritten.

4.6: Playing Back Quick 3D Data on the SIR 3000

From the Collect Run Screen (previous section, 2 windows)

You can go directly into Playback by clicking the Playback Mode button.

- Your data will be automatically saved and it will generate a top-down view.
- Depending on the size of your collected area, this could take anywhere from seconds to minutes. Be patient.

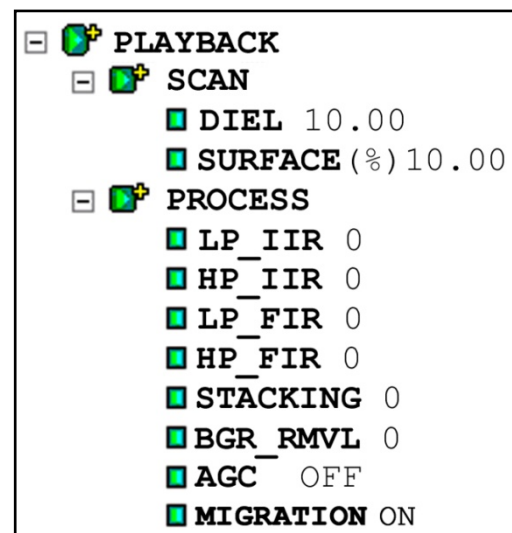

From the Collect Setup Screen (3 windows with the parameter selection tree at the left)

- 1** Click the Playback Mode button. You will see a pop-up window with all of the stored data.
- 2** Choose the grid file you want to play back and click the Right arrow. The data will scroll across the screen.
 - You can change the Display Gain setting (OUTPUT > DISPLAY > GAIN) or any of the process settings, including toggling the Migration on and off and selecting the proper material dielectric for that migration.
 - A table of dielectrics of common materials can be found in Appendix D.
- 3** When you have made the necessary changes, click Run/Setup to go to Playback Run. The SIR 3000 will generate the top-down view of your area.
 - Depending on the size of your collected area, this could take anywhere from seconds to minutes. Be patient.

The SIR 3000 will also process the data by applying a background removal filter to take out constant horizontal banding (including the direct wave). If you have the Migration process turned on under the PLAYBACK > PROCESS menu, then the computer migrates with the dielectric that you have specified under PLAYBACK > SCAN. Just like under the Test_Diel function in Collect Setup, if you have too low a dielectric specified, the hyperbolas will turn into ‘smiles.’ If you have too high a number, they will remain hyperbolas.

Note: The SIR 3000 is only performing a constant velocity migration.

Understanding the 3D Playback Screen

Once you get to this display you can toggle to different color tables or transforms by using the Command Bar buttons, or go back to the Setup (3 windows) screen by clicking Run/Setup.

The C-scan (top-down) display window is split into 3 important areas.

Linescan Window: At the right is the Linescan window which shows a 2D vertical profile. Depth is shown on the vertical axis and distance along the survey profile is shown on the horizontal. Underneath this display are two coordinates. The first is distance, and the second is depth.

Top-Down C-Scan: At the left is the Top-Down C-Scan map. This map shows the location of targets as if you were standing above your survey area and looking straight down. At the lower left corner is 0,0. The X axis is horizontal and the Y is vertical. The black dots along two of the sides are the locations of profiles. You will also see a red box (Axis Indicator) covering one of the dots. That is the currently selected profile and the one that will be displayed in the linescan window if you press Show Profile.

Locator Window: Above the C-Scan window is the Locator Window. This window gives positioning information for the C-Scan crosshairs and also shows the highest (Z0) and lowest (Z1) points of the depth slice shown in the C-Scan.

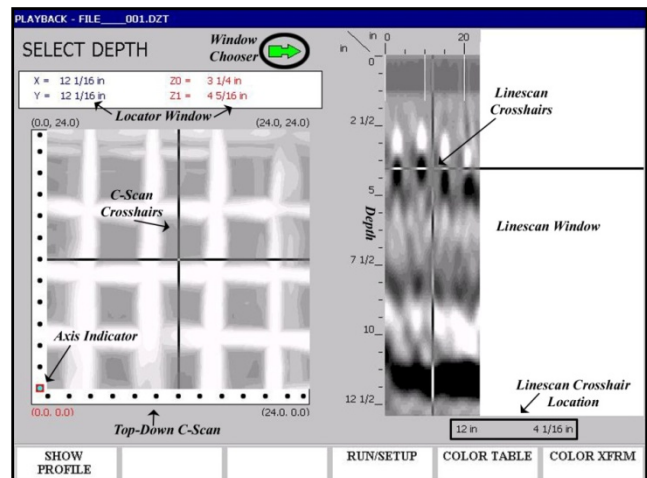

Working with the C-Scan Display

The C-Scan display has three main functions: Select Depth, Select Profile, and Select X/Y Position. You toggle between each one by clicking Enter. When you click Enter, the window chooser arrow changes. This arrow shows you which window (Linescan or C-Scan) to browse with the arrow keys.

- For example, if you click Enter until the Select X/Y Position wording appears, you will notice that the window chooser arrow points down to the C-Scan window. Now if you click the arrow keys, you will notice that the C-Scan crosshairs move and you will get location information in the Locator Window.
- You may also see the first number change in the Linescan Crosshair locator, but the locator window information is more accurate. Each of the modes are explained below.

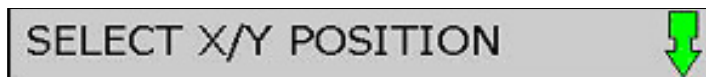

Select X/Y Position: This mode allows you to find the horizontal location of targets or clear areas to drill. The window chooser arrow will point down to the C-Scan window, telling you that you should only work with this window to make decisions.

- You can move the C-Scan crosshairs around with the arrow keys to get locations on anything you see in the data.
- You will also notice that the vertical crosshair on the Linescan Window is also moving and that it is giving a location below that window (right above the Color Table button). That location is not as accurate as the one on the C-Scan window. You should always read X/Y coordinates from the C-Scan Locator Window.

Note: You MUST pay close attention to the Z0 and Z1 numbers on the C-Scan Locator Window. The C-Scan is only showing targets within that depth range. For example, in the screenshot on the previous page, that map is of targets between $3 \frac{1}{4}$ and $4 \frac{5}{16}$ only. Anything above or below that depth is not being displayed.



Select Depth: This mode allows you to find out how deep something is and to change the display depth of the C-Scan window. You will notice that the Window Chooser arrow is pointed to the Linescan Window on the right.

- If your scan is 12" (or up to 50 cm) deep, then it will be divided into 12 equal slices.
- If it is deeper than this, then it will be divided into 15 slices.
- You will use the Up/Down arrow to move the horizontal crosshair on the Linescan Window up and down. That will give you depth information which will be displayed below the Linescan Window (above the Color Xform button).

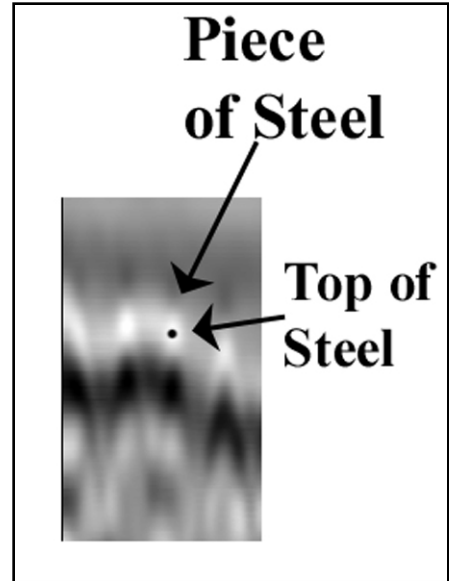

- Remember that the top of a piece of metal is the middle of the first bright white part of the target. In the example on the right, the black dot is at the middle of the white target which is the location of the top edge of the metal target. In order for this to be true, make sure that you are in the grayscale color table and that the positive amplitudes are being displayed as white. To get the depth of that you should set the horizontal linescan crosshair at that location.
- If you scroll to the top or the bottom of the image, you will get a C-Scan display of the full depth range. The image is displaying strongest targets in the full range. If you look at the C-Scan Locator Window, you will see that Z0 is set to 0 and that Z1 shows the maximum depth.
- Otherwise as you scroll up and down the profile, these numbers will change once the horizontal crosshair on the Linescan Window crosses a distance threshold. The C-Scan will then change to show the new slice data and the Z0 and Z1 will update to give you the new depth range.

Note: The accuracy of the depth reading is 100% dependent on your accurate guess of the dielectric. Remember that dielectrics in soils often change with depth, and since the SIR 3000 is performing a constant velocity migration, then it will not take those changes into account.



Select Profile: This mode lets you display individual profiles in the Linescan Window at the right. You would do this to show a target that you can then find the depth of by using the Select Depth mode. You will notice that the window chooser arrow is now pointing down to the C-Scan window.

- You can select the X profiles by clicking Up/Down and the Y profiles by clicking Left/Right. The profile line number will be displayed in the C-Scan Locator Window.
- Once you have selected your profile, click the Show Profile button on the Command Bar to display it in the Linescan Window. Each profile begins at the red box and ends at the tip of the arrow. In the Linescan Window, the profiles read from left to right with the beginning (red box location) being at the left.

Chapter 5: Data Transfer and File Maintenance

This section describes how to transfer data from the SIR 3000 to a PC for processing and interpretation, and also how to clear unwanted data from the system's memory. These functions are all accomplished under the Output menu.

Note: If the external memory card was inserted into the system before you turned it on, all data files were *automatically* collected to that memory card. They were *not* saved to the internal memory.

5.1: Transfer to a PC via USB Connection

If this is your first time transferring data via the USB connection, please see Appendix G: Installing Microsoft ActiveSync on Your PC.

- 1** Turn on PC and SIR 3000. (If SIR 3000 has been running, stop all collection and playback functions prior to continuing) Connect Master (rectangular) end of USB cable to computer. Connect Slave (square) end of USB cable to SIR 3000.
- 2** Enter the TerraSIRch mode and click Run/Stop to pause the system.
- 3** Under the OUTPUT > TRANSFER submenu, click on PC.

From the PC...

- 4** Wait for ActiveSync light to turn green and then right click on green ActiveSync icon located in system tray. Next click Explore; you will see the mobile device explorer. You are now accessing the SIR 3000's memory.
- 5** Navigate to My Computer > Storage Card and go to the folder containing your projects. You will now be able to copy from one location on the storage card to the external storage card or to a folder on the PC by 'drag and drop.' When transfer is complete (wait a couple of seconds after completion) disconnect USB cable from SIR 3000.

5.2: Transfer to a PC via the External Compact Flash

- 1** Turn on PC and SIR 3000. If the SIR 3000 has been running, stop all collection and playback functions prior to continuing. Make sure that your Flash card is inserted AFTER powering up the system.
- 2** Enter the TerraSIRch mode and click Run/Stop to pause the system.
- 3** Under the OUTPUT > TRANSFER submenu, click on FLASH.
- 4** A window will appear showing all files on the internal memory. Highlight the files and click Enter once on each file to add a 'check' next to them. Once all files are 'checked,' click the Right arrow to begin the transfer. This process will not delete the data from the internal memory.
- 5** Remove Compact Flash card from the SIR 3000 and insert it into a USB CF card reader or similar and attach the card reader to your computer. You can now access the data as if you had another disk drive on your computer.

- 6 If you get an Error #3, this indicates that the SIR 3000 has not recognized the card. Pop the card out, wait 5 seconds and reinsert.

5.3: Transfer to a PC via an External USB Flash/Keychain/ Pen Drive (HD)

This choice is available to allow you to use a USB ‘memory stick’ to transfer your data.

Note: Any keychain drive that requires installation, drivers, or restart of a computer in order to have it recognized will not work with the SIR 3000. GSSI has tested the Attaché USB 2.0 Flash drive by PNY Technologies and has found it to work.

- 1 Turn on PC and SIR 3000. If the SIR 3000 has been running, stop all collection and playback functions prior to continuing. Make sure that your memory stick is inserted AFTER powering up the system.
- 2 Enter the TerraSIRch mode and click Run/Stop to pause the system.
- 3 Under the OUTPUT > TRANSFER submenu, click on HD.
- 4 A window will appear showing all files on the internal memory. Highlight the files and click Enter once on each file to add a ‘check’ next to them. Once all files are ‘checked,’ click the Right arrow to begin the transfer. This process will not delete the data from the internal memory.
- 5 Remove the USB Keychain/Pen Drive from the SIR 3000 and insert it into a USB port on your computer. You can now access the data as if you had another disk drive on your computer.

5.4: Deleting Data from the System

While it is always advisable to keep the data on your system until you have downloaded it (if desired) and checked the integrity of the data, eventually the memory may fill up or you may simply want to do some ‘housecleaning.’ GSSI suggests that you download all of the data from a particular jobsite and completely delete the data before starting a new job. This will help to avoid confusion over which files belong to specific projects.

- 1 Highlight Delete under the TRANSFER submenu, and push Enter. You will see a window with a list of files.
- 2 Using the Up and Down arrow keys, highlight the file to be deleted and push Enter to place a ‘check’ in the empty box to the left of the file name.
- 3 Repeat until there are ‘checks’ next to all of the files you want to delete. Click the Right arrow key to accept and delete those files.

Note: When you attempt to collect a new file, the system will find the lowest number it can to assign to the new file. For example: if you have 25 files, and you delete File_001, the next file will not be File_026, it will be File_001. In other words, it will fill in any gaps in the memory before adding new files.

Chapter 6: Summary of Pre-Set Mode Parameters

The section briefly describes four out of the six operation modes for the SIR 3000. These modes are more limited in their customization because they are meant for specific applications or to collect data for on-screen target location as opposed to post-processing. As noted earlier, TerraSIRch mode allows you full reign over all collection parameters. The 3Dscan mode is similar to TerraSIRch in that it is fully customizable, but with the added feature of defining an easy 3D data collection project. Please note that some of these modes may require additional equipment purchase in order to get full functionality.

Expanded instructions for each of these modes are available in the form of separate QuickStart manuals. Contact your GSSI sales consultant for more details. The four additional modes are:

- ConcreteScan
- StructureScan
- UtilityScan
- GeologyScan

6.1: ConcreteScan

ConcreteScan is meant for a ‘quick and dirty’ scan of concrete. You would use this mode to locate shallow structural features in concrete and mark their location directly on the survey surface prior to any cutting, coring, or drilling. It works with the 2.6 GHz, 1.6 GHz, 1.5 GHz, 1.0 GHz and 900 MHz antennas.

First choose English or Metric units and then click on the ConcreteScan button. You will then see the data display screen and, if an antenna is connected, it will initialize and data will start to scroll across.

ConcreteScan includes the backup cursor function. This allows you to back the antenna over the line you just surveyed and get an on-screen cursor that will help you relate the location of targets in the data back to the slab. The backup line in the data is the location of the midpoint of the antenna.

What You Can Customize

You will choose your antenna (2.6 GHz, 2.0 GHz Palm 1.6 GHz, 1.5 GHz, 1.0 GHz or 900 MHz) under the RADAR submenu, and also select DISTANCE or TIME based collection under MODE. Remember to check the survey wheel calibration if you are using DISTANCE.

Under the Scan submenu, choose your maximum penetration depth from a number of presets: 6, 12, 18, 36 inches, or 15, 30, 50, 100 cm.

Select your SCN/UNIT from 5/7.5/10 per inch or 2/4/5 per cm.

Also set your concrete type from a number of presets ranging from Dry to Wet. This sets the dielectric constant and gives you a rough depth calculation.

What is Preset

- T_RATE: 100
- Samples/Scan: 512 deep, 256 shallow (12” and less)
- Format/Bits: 16
- RATE: 100 (deep) 200 Shallow (12” and less)
- Gain: 5 point Auto
- Filters (All)
- Offset position
- Surface position

6.2: StructureScan

This mode is for collecting very high-resolution 3D data over a concrete slab or wall with the 2.6 GHz, 1.6 GHz, 1.5 GHz or 1.0 GHz antenna and GSSI’s patented scan pad. This will produce a 3D cube of data that can be viewed in planview at differing depths so as to note clear locations for coring and cutting. You must use the scan pad for this mode and collect data in a prescribed fashion. Consult the StructureScan QuickStart guide for more details.

What You Can Customize

Under the Scan submenu, choose your maximum penetration depth from a number of presets: 6, 12, or 18 inches, or 20, 30, 50 cm.

Also set your concrete type from a number of presets ranging from Dry to Wet. This sets the dielectric constant and gives you a rough depth calculation.

What is Preset

- T_RATE: 100
- Samples/Scan: 512 deep, 256 shallow (12” and less)
- Mode: Distance
- Format/Bits: 16
- RATE: 100 (deep), 200 shallow (12” and less)
- Scn/Unit: 5/inch, 2/cm
- Gain: 1 point Auto
- Filters (All)
- Offset position
- Surface position

6.3: UtilityScan

UtilityScan is meant for a quick examination of an area in order to locate utilities in soils under concrete slabs or asphalt. UtilityScan can be used with the 270 MHz, 400 MHz, and 900 MHz antennas. Both the 400 MHz and the 270 MHz can be used with the survey cart. UtilityScan will allow you to create 2D profiles so that you can mark the location of utilities on pavement prior to trenching or excavation.

Upon clicking the UtilityScan button, you will be asked to click Right for English or Left for Metric units. You will then see the data display screen and, if an antenna is connected, it will initialize and data will start to scroll across.

UtilityScan includes the backup cursor function. This allows you to back the antenna over the line you just surveyed and get an on-screen cursor that will help you relate the location of targets in the data back to the slab. The backup line in the data is the location of the midpoint of the antenna.

What You Can Customize

Choose your antenna by selecting the proper center frequency from the list under the Radar submenu. Select DISTANCE based or TIME based data collection under MODE. Remember to check the survey wheel calibration. Choose 512 (recommended) or 256 samples/scan under the SAMPLES submenu, and then choose 16 (default) or 8 bit data collection under FORMAT.

Next select your maximum depth of penetration from the list of 5 presets (3, 5, 10, 15, 20 ft) (1, 3, 5, 7 meters). Select the appropriate soil type from the list of 4 presents (Soil Type 1-4). This will set your dielectric and affect your maximum depth of penetration.

Then select your scans per unit from the list of presets. GSSI recommends a scan density of either 12 or 18 per foot, or 25 per meter.

Soil Types

- Type 1: Dielectric 4, dry sand or dry grade
- Type 2: Dielectric 8, damp sand or grade, dry silt
- Type 3: Dielectric 16, agricultural fields, sandy silt, wet sand
- Type 4: Dielectric 32, wet conditions, clay

What is Preset

- T_RATE: 100
- RATE: 100
- Gain: 3 point Auto
- Filters (All)
- Offset position
- Surface position

6.4: GeologyScan

This mode is optimized for 2D profiling of shallow geological features such as high bedrock, sediment bedding, water tables, etc. It is also useful for archaeological profiling. GeologyScan works with the 400 MHz, 270 MHz, 200 MHz, and 100 MHz antennas, though only the 400 and 270 MHz are small enough to be mobilized on the survey cart. Other antennas will need to be dragged over the ground surface.

Upon clicking the GeologyScan button, you will be asked to click Right for English or Left for Metric units. You will then see the data display screen and, if an antenna is connected, it will initialize and data will start to scroll across.

There is no QuickStart Guide available for GeologyScan.

What You Can Customize

Choose your antenna by selecting the proper center frequency from the list under the RADAR submenu. Select DISTANCE based or TIME based data collection under MODE. Remember to check the survey wheel calibration. Choose 1024 (recommended), 512, or 256 samples/scan under the Samples submenu, and then choose 16 (default) or 8 bit data collection under FORMAT.

Select the appropriate soil type from the list of 4 presents. This will set your dielectric and affect your maximum depth of penetration.

Then select your scans per unit from the list of presets. The presets are 6, 12, 18 per foot for English, or 10, 25, 50 per meter for Metric units.

What is Preset

- T_RATE: 100
- RATE: 80
- Range: Max for antenna
- Gain: 5point Auto
- Filters (All)
- Offset position
- Surface position

Chapter 7: Using a GPS with your SIR 3000

Your SIR 3000 is capable of attaching GPS coordinates to individual data profiles. This will allow you to place the beginning and the end of your survey lines into a larger, real-world coordinate system provided that you: 1) Survey in straight lines and 2) Have a GPS with sufficient accuracy for your application.

GSSI will publish specific integration information as a series of Technical Notes available on the GSSI Technical Support website at <http://support.geophysical.com>.

Attaching a GPS with its own data logger, such as the G30L available from GSSI, will allow you to collect GPS data points with a much finer resolution. RADAN 6 will then be able to wrap data files and show coordinates with a GPR X, Y, and Z.

The GPS you do choose must have the following:

1. Provide data output through a serial (RS232) port.
2. Output data at a baud rate of 4800.
3. Output the NMEA GGA data string.

Note: GSSI only supports the G30L receiver or integration with the Acumen serial data bridge logger available from GSSI.

7.1: Attaching a GPS

- 1** Try your GPS to determine if you are getting a good position and an adequate number of satellites.
- 2** Setup and power up your SIR 3000 as normal.
- 3** Under COLLECT > RADAR, highlight the GPS menu choice and click Enter. Toggle to G30L for the GSSI provided receiver or to CUSTOM for any other receiver and click the Right arrow.
- 4** The Enable GPS dialogue box will pop up. Follow the instructions in the window to connect your GPS. You should ensure that your receiver is tracking at least 4 satellites. If you are using the G30L, 4 is the minimum number of satellites you can use.
- 5** When you start a data profile, the SIR 3000 will capture a GPS coordinate and place it in the file header. It will do the same when you stop the data file and save it. These coordinates will be visible when you view the file header in RADAN 5.0 or higher.

Some other Concerns:

- The .TMF file. You will notice that the SIR 3000 has created 2 files: the data profile (.DZT) and another file with the same name but a different extension (.TMF). This file will be used for some added GPS functionality which is not yet available.
- East vs. West. The SIR 3000 is set to capture Latitude and Longitude coordinates rather than UTM. It does not however tag a North/South or East/West to those numbers. If you are west of the Prime Meridian, the Longitude will be negative and if you are south of the Equator, the Latitude will be negative.

7.2: Understanding GPS

This is a brief description of GPS and how to use it with our SIR 3000. GPS information gets attached to our data two different ways. First, the start and end positions are stored in the header of each *.DZT file. Second, the timing of each marked scan is stored in a separate *.TMF file, which RADAN 6.0 incorporates into its database.

This paper gives a quick GPS overview and then describes what you need to know in order to effectively use the SIR 3000 with a GPS.

What is it?

GPS is a satellite navigation system (provided free by the USDoD) designed to provide instantaneous position, velocity and time information almost anywhere on the globe at any time, and in any weather. It typically provides positioning accuracies ranging from 3 meters (costing \$150) to 1cm (\$15,000). Since it needs to see much of the sky, it works poorly indoors, in woods and in “concrete canyons” like Manhattan.



Why do I need it?

You probably don't! In fact for many Ground Penetration Radar applications you can just use a survey wheel to measure your distance and take simple notes about your start and stop locations. And since digging or drilling often requires more precision than 3meters, knowing “sort of” where you are is not helpful.

However, as surveys become larger and as technologies improve, GPS can be very helpful in telling you where you are on a map, or what road you turned onto, or what section of the avalanche you have already covered, or even where you were in the middle of a lake. And of course if you actually need expensive survey-grade GPS accuracy, we want to give you the hooks you need to place our RADAR data correctly. Increasingly GPS is claiming a legitimate place in the ever increasing size and variety of GPR applications.

How does it work?

GPS works by triangulating the distance from satellites in space. Like our RADARs, these satellites just transmit time very accurately and estimate the distance using the speed of light. Getting the travel-time from just three satellites is enough to know where you are on the earth. Getting the travel-time from 12 satellites greatly decreases the uncertainty of your position. Typically around buildings and trees you might “see” six satellites, plenty to know where you are to within 3 meters. The degree of precision depends on many things, like how well distributed the satellites are in the sky, or the travel path the signal took to get to your receiver.

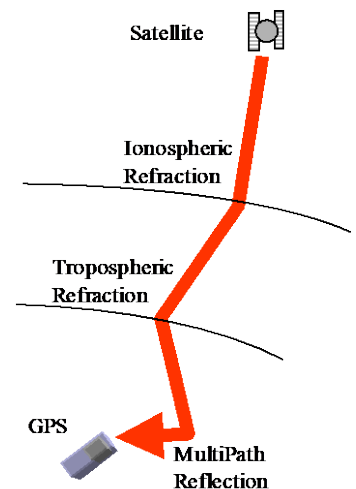

Main sources of error

GPR and GPS share a lot in common. The travel times and paths are directly affected by the medium. For GPS, this means the signal from the satellites to your receiver can get slowed down and bent by changes in the Ionosphere, the Troposphere and even nearby objects. These sources of error can be reduced using expensive tricks like dual frequency, Klobuchar modeling and Real-Time Kinematic (RTK) solutions.

The least expensive way to correct for these errors is through Differential GPS (DGPS), where data from a second stationary “Base” GPS is subtracted from a Roving GPS. Compared to the distance from the satellite, distance between Base and Rover is insignificant, which means the travel paths through the ionosphere and troposphere are basically identical. So the difference between the two positions subtracts out atmospheric effects, leaving just the Rover position.

What is WAAS?

The Wide Area Augmentation System (WAAS) is a form of differential GPS that uses geostationary satellites to transmit an error correction estimate back down to your receiver. The measured positions of ground reference stations, strategically positioned across the country, are sent up to the WAAS satellites. Your receiver reads the reference station closest to you.

“WAAS testing in September 2002 confirmed accuracy performance of 1 – 2 meters horizontal and 2 –3 meters vertical throughout the majority of the continental U.S. and portions of Alaska.”

(<http://gps.faa.gov/Programs/WAAS/waas.htm>) This is with a clear view of the sky. Typically WAAS can improve your error from less than 5 meters 95% of the time to less than 3 meters. WAAS is now available even in the less expensive GPS units and is recommended.

What is NMEA?

The National Marine Electronics Association ([NMEA](#), pronounced “NEE’ma”) has generated a standard set of messages for communicating GPS information. We use the NMEA 0183 version 2.1 protocol.

So which one should I get?

We have chosen to go with a GPS Datalogger, mostly because it is so simple. No buttons, nothing to control and everything is handled automatically inside the SIR 3000. Yet it produces results as good as the other consumer-grade, WAAS enabled units.

However if you already have a GPS, we have tested the Garmin eTrex, GPS Map76S, Magellan SporTrak Pro, Teletype PocketPC GPS, and a few others. These should all work fine, but not as seamlessly.

Our requirements are rather flexible. Any unit that sends the NMEA GGA command should work. Since each company sells its own interface, we have chosen to work with the popular shareware, OziExplorer (www.ozieplorer.com), as our interface. Oziexplorer can talk to Garmin, Magellan, Eagle, Lowrance, Brunton/Silva and MLR units. It will even interface with other NMEA compatible units that output waypoints in the NMEA sentences:

\$GPRMC or

\$GPGGA and \$GPVTG or

\$GPGLL and \$GPVTG

If your GPS outputs a GGA command every second in a standard serial fashion (4800 baud, 8 bit, no parity, 1 stop bit), and if you can get your tracklog into OziExplorer, then we can talk to your GPS with RADAN 6.0.

7.3: Using the G30L with the SIR 3000 and RADAN 6.0

The G30L was an optional accessory to our SIR 3000. It is no longer available new and this section is presented for those who had previously purchased the G30L. It is a GPS datalogger with no external controls. It will store up to 15 hours of GPS data that can be downloaded at any time. The only caveat is that once it fills its memory, it stops. For this reason, we stop and clear its internal memory at the end of each survey. To simplify the interface we also needed to make changes in RADAN, which will next appear in version 6.0. Here's all you need to do.

- Turn on your SIR 3000.
- Plug your GPS unit in the serial port and the USB port (for power)
- Enable GPS in the RADAR Menu (always off on Startup).

GPS Start/Stop positions and times go in the header of your DZT data file. (see Addendum A). These positions are all you'll need for most surveys.

The GPS positions between Start and Stop get matched up with the Mark positions in RADAN 6.0 and are stored in the new database (Microsoft Access compatible).

Matching Your Own GPS/GPR Data

With other GPS units, the match up can be done, but it's a bit complicated. Here's how.

- 1** First Collect the GPS/GPR Data.
- 2** Turn on your SIR 3000.
- 3** Plug your GPS unit in the serial port.
- 4** Enable GPS in the RADAR Menu (always off on Startup).
- 5** Set your GPS to output NMEA (the standard 0183 version 2.1) at 4800 baud.
- 6** Set your GPS to start logging track data. On the Garmin units this means going to the "Track" menu, turning it on and setting the track interval (i.e. every 2 seconds or every 10meters.)
- 7** Start Data Acquisition:
- 8** Stop Data Acquisition and Close the file.
 - GPS Start and Stop positions and times go in the header. In our header, *rh_version* is set to 2. (see Addendum A).

So far this is not complicated at all. And since most surveys will require nothing more than these two begin/end positions, any standard GPS outputting GGA will do this job nicely.

Next Time-Synchronize GPS/GPR files.

But if the survey is along a curve, you will need to work out the GPS position of each scan.

This can be done in Microsoft Visual Basic or with Simulink MatLab to get the two data files together.

Our Binary file extension is *.TMF. The tracklog output of your GPS software will have a unique extension. (that's why we prefer the Oziexplorer *.plt file so that all the various GPS's can output data in one format).

- For **Time** based data acquisition.

Match GPS Start/Stop position/time with records in the GPS log.

The scan rate is used to time tag individual scans.

- For **Distance** based data acquisition or data with user marks.

Match GPS Start/Stop position/time and file *filename.TMF* (see Addendum B) to synchronize marked scans with the time/position records from the GPS log. Interpolate time/distance data between the marked scans as necessary.

Please see the protocols listed below in the following Addenda for help on how to extract the necessary information.

Addendum A

RADAN File Header Format (SIR 3000)

Please Note: This information is being provided for informational use only. It is not supported by GSSI technical support and is only provided for those users who are already comfortable working in a C programming environment.

A. Internal structures

```

struct tagRFDate                                // File header date/time structure
{
    unsigned sec2 : 5;                          // second/2 (0-29)
    unsigned min  : 6;                          // minute (0-59)
    unsigned hour : 5;                          // hour (0-23)
    unsigned day  : 5;                          // day (1-31)
    unsigned month: 4;                          // month (1=Jan, 2=Feb, etc.)
    unsigned year : 7;                          // year-1980 (0-127 = 1980-2107)
};

struct tagRFCoords                              // Start/End position
{
    float   rh_fstart;
    float   rh_fend;
};

struct RGPS                                    // GPS record/system time SYNC
{
    char      RecordType[4];                   // "GGA"
    DWORD     TickCount;                       // CPU tick count
    double     PositionGPS[4];                 // Latitude (positive if 'N'), Longitude (positive if 'E'),
                                                // Altitude, FIXUTC
};

```

B. Constants and macros

```

// constants
const int  MINHEADSIZE   =    1024;
const int  PARAREASIZE   =    128;
const int  GPSAREASIZE   =    2 * sizeof(RGPS);
const int  INFOAREASIZE = (MINHEADSIZE - PARAREASIZE - GPSAREASIZE) ;

// structure member alignment macros
#define TYPEBYTE(x,n)      BYTE x##[n]
#define SHORTBYTE(x)      TYPEBYTE(x,2)           // short int (16 bit)
#define FLOATBYTE(x)      TYPEBYTE(x,4)           // float
#define RFDATEBYTE(x)     TYPEBYTE(x,4)           // tagRFDate
#define COORDBYTE(x)      TYPEBYTE(x,8)           // tagRFCoords

```

C. RADAN Header structure

```

struct tagRFHeader
{
    // Offset in bytes
    short  rh_tag;           // 0x00ff if header, 0xfnff for old file           00
    short  rh_data;         // constant 1024 (obsolete)                                       02
    short  rh_nsamp;        // samples per scan                                                04
    short  rh_bits;         // bits per data word (8 or 16)                                    06
    short  rh_zero;         // Offset (0x80 or 0x8000 depends on rh_bits)                     08
    FLOATBYTE(rhf_sps);     // scans per second                                               10
    FLOATBYTE(rhf_spm);     // scans per meter                                                14
    FLOATBYTE(rhf_mpm);     // meters per mark                                                18
    FLOATBYTE(rhf_position); // position (ns)                                                  22
    FLOATBYTE(rhf_range);   // range (ns)                                                      26
    short  rh_npass;        // num of passes for 2-D files                                     30
    RFDATEBYTE(rhb_cdt);    // Creation date & time                                           32
    RFDATEBYTE(rhb_mdt);    // Last modification date & time                                   36
    short  rh_rgain;        // offset to range gain function                                   40
    short  rh_nrgain;       // size of range gain function                                     42
    short  rh_text;         // offset to text                                                  44
    short  rh_ntext;        // size of text                                                    46
    short  rh_proc;         // offset to processing history                                    48
    short  rh_nproc;        // size of processing history                                      50
    short  rh_nchan;        // number of channels                                              52
    FLOATBYTE(rhf_epsr);    // average dielectric constant                                    54
    FLOATBYTE(rhf_top);     // position in meters                                             58
    FLOATBYTE(rhf_depth);   // range in meters                                                62
    COORDBYTE(rh_coordX);   // X coordinates                                                  66
    FLOATBYTE(rhf_servo_level); // gain servo level                                             74
    char   reserved[3];     // reserved                                                        78
    BYTE   rh_accomp;       // Ant Conf component                                             81
    short  rh_sconfig;      // setup config number                                            82
    short  rh_spp;         // scans per pass                                                 84
    short  rh_linenum;     // line number                                                    86
    COORDBYTE(rh_coordY);   // Y coordinates                                                  88
    BYTE   rh_lineorder:4;  //                                                                    96
    BYTE   rh_slicetype:4;  //                                                                    96
    char   rh_dtype;        //                                                                    97
    char   rh_antname[14];  // Antenna name                                                  98
    BYTE   rh_pass0TX:4;    // Activ Transmit mask                                           112
    BYTE   rh_pass1TX:4;    // Activ Transmit mask                                           112

    BYTE   rh_version:3;    // 1 – no GPS; 2 - GPS                                           113
    BYTE   rh_system:5;     // 3 for SIR3000                                                 113
    char   rh_name[12];     // Initial File Name                                             114
    short  rh_chksum;       // checksum for header                                           126
    char   variable[INFOAREASIZE]; // Variable data                                               128
    RGPS   rh_RGPS[2];     // GPS info                                                       944
}; // End of tagRFHeader

```

Addendum B

Time Marks File Format (SIR 3000)

A. Internal structures

```

struct RGPS // GPS record/system time SYNC
{
    char      RecordType[4]; // "GGA"
    DWORD    TickCount;      // CPU tick count
    double   PositionGPS[4]; // Latitude (positive if 'N'),
                             // Longitude (positive if 'E'),
                             // Altitude, FIXUTC
};
struct RDMT // Distance mark/system time SYNC
{
    DWORD    ScanNumber;     // 24 bit scan number
    DWORD    TickCount;     // 32 bit internal clock tick count in mS
};

```

B. Constants and macros

```

// constants
const int  GPSAREASIZE  = 2 * sizeof(RGPS);

```

C. Time Marks File (.TMF)

```

struct RGPS  startGPSpos; // the same as in RADAN file header
struct RDMT markTime[nMarks]; // one record for every distance or user mark
struct RGPS  endGPSpos // the same as in RADAN file header

```

Minimum file size is GPSAREASIZE. // Header and footer only; file has no marks
nMarks can be calculated from file size as (FileSize – GPSAREASIZE)/ sizeof(RDMT); v

Appendix A: TerraSIRch SIR 3000 System Specifications

A.1: System Hardware

Antennas: Compatible with all GSSI Antennas

Number of Channels: 1 (one)

Data Storage:

- Internal memory 1 GB
- Compact Flash port: Accepts industry standard Compact Flash memory or IBM Microdrive up to 2 GB (user provided)

Processor: Marvell PXA 320 with 128 MB of RAM, 806 MHz

Display: Enhanced 8.4" TFT, 800 × 600 resolution, 64K colors
Linescan and O-scope display modes.

Input/Output:

- Antenna input (control cable)
- DC power
- Ethernet I/O
- RS232 Serial I/O (GPS port)
- Compact Flash memory
- USB master
- USB slave

Mechanical:

- Dimensions: 31.5 cm × 22 cm × 10.5 cm (2.4" × 8.7" × 4.1")
- Weight: 4.1 kg (9 lbs) including battery

Operating:

- Temperature: -10°C to 40°C
- Charging Power Requirements: 15 V DC, 4 amps
- Battery: 10.8 V DC, internal
- Transmit Rate: Up to 100 KHz

Note: The SIR 3000 will not work with the short, orange attenuated control cable that was sold with the SIR 2000. The SIR 3000 will only work with non-attenuated cables (blue or black in color).

A.2: Data Acquisition and Software

Data Format: RADAN (.dzt)

Scan Rate Examples:

- 220 scans/sec at 256 samples/scan
- 120 scans/sec at 512 samples/scan

Sample Size: 8-bit or 16-bit, user-selectable

Scan Interval: User-selectable

Number Of Samples Per Scan: 256, 512, 1024, 2048, 4096, 8192

Operating Modes: Free Run, Survey Wheel, Point Collection

Time Range: 5-8000 nanoseconds full scale, user selectable

Manual or automatic gain, 1-5 points, (-20 to +80 dB)

Filters:

- Vertical: Low-Pass and High-Pass IIR and FIR
- Horizontal: Stacking, Background Removal

System Includes:

- SIR 3000 control unit
- Transit case
- AC adaptor
- User manual
- 2 batteries
- Sun shade

Fully FCC Compliant.

Appendix B: The How-To's of Field Survey

As the old saying goes: “Garbage in, Garbage out”. The biggest single factor affecting the quality of your data and your ability to make decisions based on it, is the accuracy of your data collection. This appendix has instructions and helpful hints to get you into the habit of collecting quality data from the beginning. While many of these points are only relevant to data collection over the ground, as opposed to concrete structures, you may find this section helpful no matter what your application.

B.1: Site Selection

Radar is not the proper technique for every situation. If you are unable to inspect the site, have prospective clients send a photograph of the area. As you gain experience, you will find it easy to judge an area's or an application's suitability. In the meantime, consider the four following issues before deciding whether you should conduct work at an area:

- Topography
- Ground Cover
- Subsurface Conditions
- Site Accessibility

Topography

One of the first things you should consider about a new survey area is the topography. In the first place, you need to be able to physically move the antenna over the ground surface in a fairly smooth fashion. Areas that are full of trenches or extreme slopes are not ideal. You can still survey an area of broken terrain, but it may require collecting point data rather than continuous data profiles.

Radar energy travels into the ground perpendicular to the surface. This means that if the antenna is flat on the ground, and level, you are reading right under the antenna. This forward-scanning of the antenna could lead to serious position errors.

Ground Cover

If your antenna is floating on top of thick grass or a layer of gravel, you may get errors in your data because the signal is taking too long to couple (penetrate) with the ground. When this happens, more of the signal than was intended bounces off of the ground surface instead of going into the ground. Always try to keep your antenna flat on the ground surface. The systems will have no problem penetrating carpeting or low grass. A good rule of thumb for the 1500 MHz is no thicker than low carpet, and for the 400 MHz, no more than 1 inch. NEVER survey through standing water, no matter how shallow the puddle.

Subsurface Conditions

If you are working with concrete, try to make sure that the concrete has had some curing time. Three months is usually adequate for a standard slab on grade, while a suspended slab may cure faster. The best solution is to practice on slabs of different ages so that you have a first-hand feel of the way they will look. Concrete that is not well cured will be difficult to see into.

Try and find out some information about the area's soil and water content. Generally speaking, clay and water cause attenuation and impede penetration. Finding out the soil grain size (sand, silt, clay) will help you to guess the dielectric constant of the material to help you set up survey parameters and make time to depth estimations. If you have never worked with soils before, you should consult the US Department of Agriculture soils website at <http://soils.usda.gov/>. The site has a number of free and low cost resources including soil maps of most of the United States and guides to help you understand soils.

Site Accessibility

Simply put, can you feasibly work in the proposed area? Is the site in the middle of a dense thicket of trees, or is it the outside of a tall building, or a tight elevator shaft? Remember that GPR and geophysics depends on your ability to see contrasts in the data. The area has to be large enough for you to collect enough data to be able to make an interpretation. For example, if you need to survey an area in advance of an 18" utility trench, you want to make sure that you have some coverage over areas outside of that trench so you can see normal conditions. Always give yourself some elbow room.

B.2: Targets

The type of targets you are trying to find will govern your choice of antennas, setup parameters, or even the feasibility of radar for the application. There are two main criteria to consider:

- Target Size
- Target Composition

Target Size

All things being equal, antenna choice determines how deeply you are able to penetrate and the minimum size of the targets that you are able to see. Lower frequency antennas see deep, but the minimum target size that they can see is larger. Rather than focus on what each antenna can see, the table below lists the appropriate antenna by application and depth range.

Frequency	Sample Applications	Typical Max Depth Feet (meters)	Typical Range (ns)
2.6 GHz	Structural Concrete, Roadways, Bridge Decks	1 (0.3)	10
1.6 GHz	Structural Concrete, Roadways, Bridge Decks	1.5 (0.5)	10-15
900 MHz	Concrete, Shallow Soils, Archaeology	3 (1)	10-20
400 MHz	Shallow Geology, Utility, Environmental, Archaeology	9 (3)	20-100
200 MHz	Geology, Environmental	25 (8)	70-300
100 MHz	Geology, Environmental	60 (20)	300-500

Antennas by Application

Radar is also not a continuous measurement along a survey line. The system takes readings (scans) at a set spacing. If your scan spacing is too wide, you risk not hitting your target with enough scans to draw a recognizable hyperbola, or worse, missing the target altogether.

Generally you need a minimum of 10 scans to draw a recognizable hyperbola. The rule of thumb is to have 10 scans divided by the depth of the shallowest object. So if you want to image something 10 feet deep, 10 scans / 10 feet = 1 scan/foot. For 5 feet, 10 scans / 5 feet = 2 scans/foot.

For locating structural features in concrete with the 1.6 GHz antenna, we usually recommend 60-90/ft. For utility and tank location, we usually recommend 6-24/ft. While this is more than the minimum rule of thumb, GSSI has found these densities to work well in the widest variety of situations.

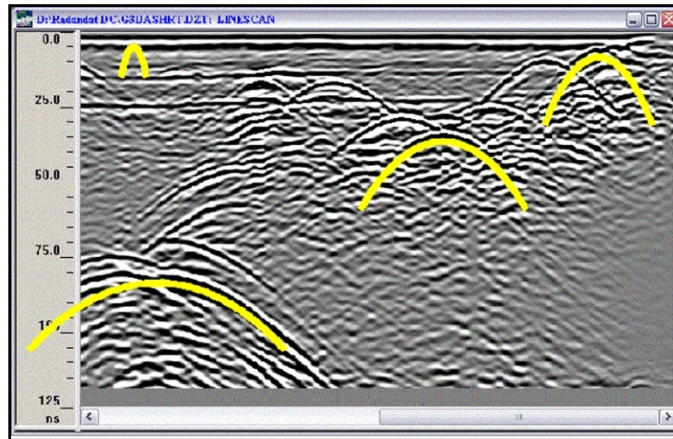

The image above shows hyperbolas from objects of similar size. The hyperbolas vary in size because, due to the spreading of the radar signal, a deeper target shows reflections in more scans than a shallow one.

Lower frequency antennas, like the 200 MHz and 400 MHz, will sometimes not image targets close to the surface very well. While not strictly a ‘dead zone’ you should be aware that it may be difficult (but not impossible!) to see targets in this area. As a general rule of thumb, this zone is equal to the spacing between the transmitter and receiver dipoles, but this can vary with soil composition. See the chart at right for a general idea. If your application requires you to see deep and shallow, consider surveying the area with two different antennas.

Frequency	“Hazy” Zone inches (cm)
2.6 GHz	0.5 (1)
1.6 GHz	1 (2.5)
900 MHz	4 (10)
400 MHz	6 (15.25)
200 MHz	12 (30.5)

Target Composition

Your ability to see a target depends on the contrast between the dielectric values of the target’s material and the material that the radar energy was traveling through just before it hit the target. The greater the contrast between the dielectric values, the more visible the target is. For applications which involve finding metal targets like rebar, pipes, and drums, this is not a great issue because there will always be a great contrast. The dielectric of metals is so high that the actual number is meaningless. You will always have a visible contrast where metals are concerned.

Composition can affect your ability to see things in different ways. For example, the contact between a dry sand (3-6) and a water table (water being 81) will be easy to image, while the contact between sandstone (6) and limestone (7-8) will be much more difficult. Also remember that it is the electrical property of the material that most governs dielectric. Even though concrete and grade are qualitatively very different, they are made of similar materials and react to radar energy similarly. It is usually extremely difficult to tell the top of grade from the bottom of the slab. You should practice trying to image different materials so that you can build up a body of experience. See Appendix D for a chart of the dielectric constants of different materials.

B.3: Data Collection Methods: 2D vs. 3D

Time is money. Whether you are a university-based researcher working off a grant or performing NDT work for pay, the faster you can get the survey done the better off you will be. Those charging by the hour understand the fine balance between a price that reflects a realistic estimate of how long it will take to get the job done, and padding the cost with unnecessary work. The point of this discussion is to get you to think about how much information you really need to make a decision.

2D

Two-dimensional data collection means that you will be collecting and interpreting single profiles of data. This is useful for quickly following a pipe by scanning over an area, noting the location of the pipe hyperbola on the ground, then moving some distance away and scanning again for the pipe. The real benefit of 2D data collection is speed and ease of use. Processing is certainly possible on 2D data to clean up the image, but most clients will only use it for visually noting the presence/absence of targets in the field. 2D data collection is also useful for geologic applications such as bedrock and water table mapping.

3D

Collecting data for 3D imaging obviously takes more time than 2D collection. While the SIR 3000 makes it faster and easier than it has ever been before, it can still add significant time (and cost) to a job. It also requires some software processing to produce an interpretable image. These two issues may frighten some users away from 3D data collection, but like GPR in general, it only requires some practice to gain confidence.

Three-dimensional data can be a great aid in interpretation. The question many people ask is “When do I use 3D?” Aside from producing a 3D map for its own sake, there are really only three main reasons: a complicated area, prospecting, or dangerous targets in the subsurface. A complicated area might be a city street with many different types of pipes running in different directions. In a situation like that, the best option is usually to do 3D data collection so that you are able to visually track targets as they twist and turn around other targets. Prospecting is mainly what those doing Archaeology will face. In this case, you don’t have any concrete information about the subsurface so you will need to do 3D over the area and look for human-made patterns that could be targets. An example of the final reason would be coring or cutting into an area that has live high-voltage in the floor. When the safety of your crew is at stake, the more information, the better.

Appendix C: Mounting Your SIR 3000 on a Cart

Mobilizing your system on the GSSI Model 623 survey cart allows you to cover ground much more easily and conveniently than with the conventional system configuration described in Chapter 2.1. The cart can accommodate the 400 MHz, 900 MHz, 1.5/1.6 GHz and 2.6 GHz antennas. It also incorporates a survey wheel for high-precision distance measurements. If you have purchased a 643 cart, please see the assembly instruction cart shipped with it.



- 1** Unfolding the cart and attaching the wheels.
- 2** Mounting the antenna.
- 3** Attaching the SIR 3000.
- 4** Optional mounting of the 400MHz on the front
of
the cart.

C.1: Unfolding the Cart and Attaching The Wheels



Unfold the cart frame and insert the black tips of the top assembly into the receivers on the front wheel fork. Secure with the attached pin.



Squeeze the silver wheel-lock clamps, and insert the wheel shaft into the axle. It will slide all the way in and lock securely. To remove wheels, squeeze the wheel-lock clamp again and pull the wheel straight out. Note: The wheels are foam filled and do not require inflation.



Slide the front wheel onto the front wheel fork and tighten clamp. When the clamp is slightly tight, turn the handle to the locked position (shown). This will further tighten the clamp. Exercise care not to over-tighten the front wheel as this may result in damage to the front fork.



Ensure that the survey wheel encoder is correctly positioned on the inside of rear left wheel and that the survey wheel is making contact with the tire's rim.

C.2: Mounting the Antenna

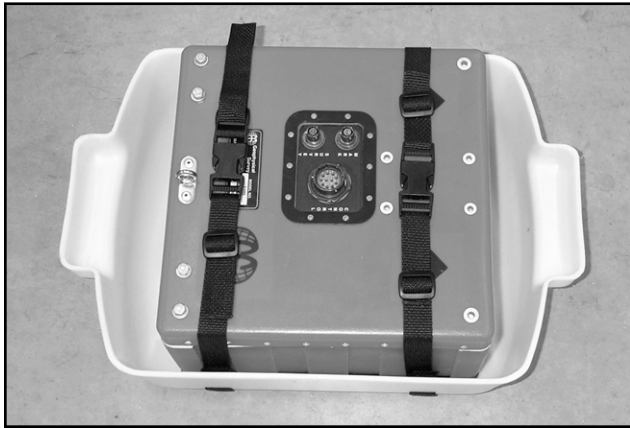

Place the antenna into the white plastic tub and secure with the attached straps. If you are using the cart system with the 1.5 GHz (Model 5100) antennas, place the antenna in the tub, and then sandwich it between the bottom of the tub and the white plastic Velcro plate. Fix the straps over the top of the plate to secure.



With the arrows on the top of the antenna housing pointing toward the front of the cart, place the tub under the cart so that the tub handles face the front and the back of the cart.

Lift the tub to fit the brackets under the handle and insert them through the 2 double holes on the frame.

Secure with the metal pins.



The antenna tub should just touch the ground surface. It is intended to be loose because it needs to be able to float over small obstacles. If you are using a small, higher frequency antenna, be sure that the antenna is centered in the tub.



Connect the female end of the control cable to port that is labeled CONTROL and connect the lead from the survey wheel (4 pin) to the SURVEY port. These leads should only be hand tightened.

C.3: Attaching the SIR 3000



Hold the SIR 3000 in the mounting bracket so that all of the holes line up. Beginning with the top 2 holes, attach the SIR 3000 with the thumb screws. Pivot the SIR 3000 back and forth to get the most comfortable viewing position, and screw in the bottom 2 thumb screws. Be sure to only hand-tighten the screws. If you purchased the optional sunshade, be sure that it is positioned on the outside of the bracket rather than being sandwiched between the mounting bracket and the SIR 3000.



Attach the male end of the control cable to the antenna port on the back of the SIR 3000. Be sure to only hand-tighten this connection as over tightening may cause system damage.

C.4: Optional Mounting of the 400 MHz on the Front of the Cart

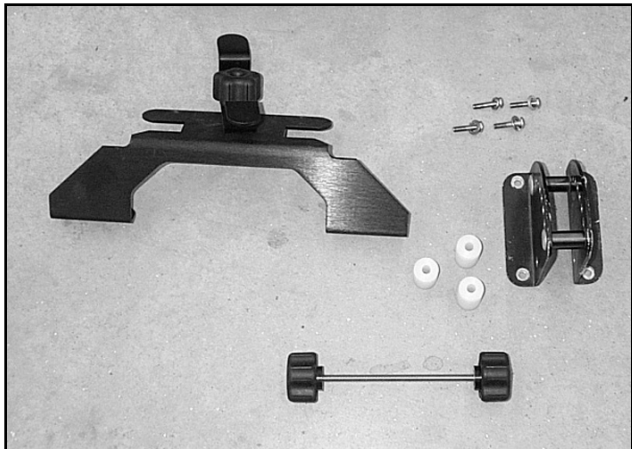

Collect the front mount kit parts.

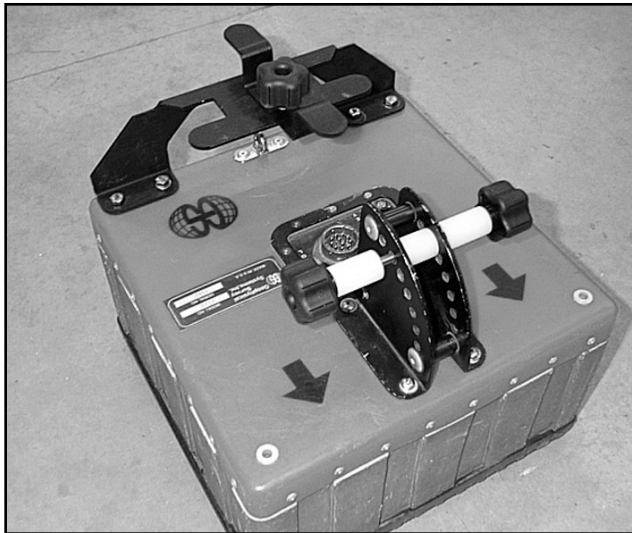

Attach the kit to the 400 MHz antenna as shown.

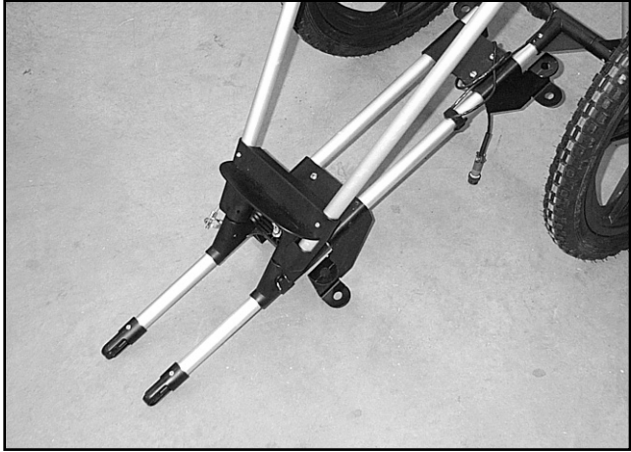

Remove the front wheel from the cart by loosening the front axel release.

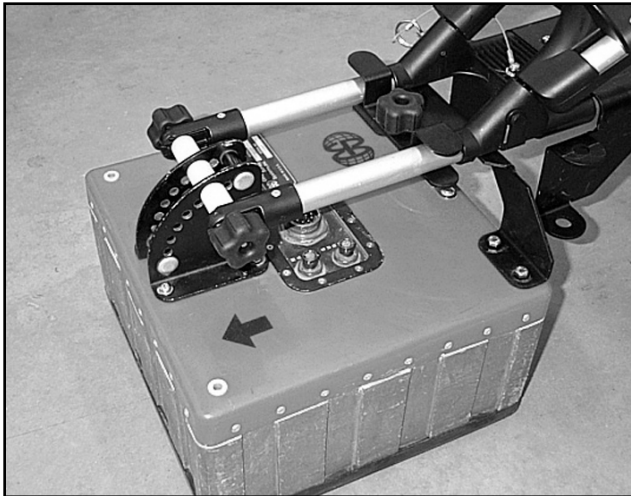

Attach the front fork of the cart to the antenna as shown. Tighten down the clamp at the rear of the antenna. All screws should be lightly snugged down.



Completed mount. This configuration allows you to scan much closer to a curbside or building.

Appendix D: Dielectric Values For Common Materials

Material	Dielectric	Velocity (mm/ns)
Air	1	300
Water (fresh)	81	33
Water (sea)	81	33
Polar snow	1.4 – 3	194 - 252
Polar ice	3 - 3.15	168
Temperate ice	3.2	167
Pure ice	3.2	167
Freshwater lake ice	4	150
Sea ice	2.5 – 8	78 – 157
Permafrost	1 – 8	106 – 300
Coastal sand (dry)	10	95
Sand (dry)	3 – 6	120 - 170
Sand (wet)	25 – 30	55 – 60
Silt (wet)	10	95
Clay (wet)	8 – 15	86 – 110

Clay soil (dry)	3	173
Marsh	12	86
Agricultural land	15	77
Pastoral land	13	83
“Average soil”	16	75
Granite	5 – 8	106 – 120
Limestone	7 – 9	100 – 113
Dolomite	6.8 – 8	106 – 115
Basalt (wet)	8	106
Shale (wet)	7	113
Sandstone (wet)	6	112
Coal	4 – 5	134 – 150
Quartz	4.3	145
Concrete	5 – 8	55 – 120
Asphalt	3 – 5	134 – 173
PVC	3	173

**Meter to English conversion factor: 2.54 cm in 1 inch.

** Table of Dielectric values adapted from:

Reynolds, John M.

1997 *An Introduction to Applied and Environmental Geophysics*, John Wiley & Sons, New York.

Appendix E: Listing of Antenna Parameters

The SIR 3000 comes with preloaded setups to fit the system's data collection parameters and filters to the most commonly used, currently available GSSI antennas. Settings for additional antennae are also provided below to assist you in creating a setup for an older or specialized antenna. Please note that these are only generalized setups, and it may be necessary to alter these to your particular situation. For example, deeper penetration can be set by increasing the range in the COLLECT > SCAN menu. Please note that this is not an exhaustive list and you should consult the antenna documentation saved on the Manual CD Compendium or on the GSSI Support Website, www.support.geophysical.com.

E.1: Preloaded Setups

2.6 GHz (Model 52600)

2.6 GHz ground coupled antenna. Depth of viewing window is approximately 10 inches in concrete. Setting is optimized for scanning of structural features in concrete.

Range: 8 ns
Samples per Scan: 512
Resolution: 16 bits
Number of gain points: 2
Vertical High Pass Filter: 400 MHz
Vertical Low Pass Filter: 5000 MHz
Scans per second: 100
Vertical IIR High Pass $N=2F=10$ MHz
Transmit Rate: 100 KHz

1.5/1.6 GHz (Model 5100)

1.5 GHz ground coupled antenna. Depth of viewing window is approximately 18 inches in concrete. Setting is optimized for scanning of structural features in concrete.

Range: 12 ns
Samples per Scan: 512
Resolution: 16 bits
Number of gain points: 5
Vertical High Pass Filter: 250 MHz
Vertical Low Pass Filter: 3000 MHz
Scans per second: 100
Vertical IIR High Pass $N=2F=10$ MHz
Transmit Rate: 100 KHz

900 MHz (Model 3101D)

900 MHz ground coupled antenna. Depth of viewing window is approximately 1 m assuming a dielectric constant of 5.

Range: 15 ns
Samples per Scan: 512
Resolution: 16 bits
Number of gain points: 2
Vertical High Pass Filter: 225 MHz
Vertical Low Pass Filter: 2500 MHz
Scans per second: 120
Transmit Rate: 100 KHz

500-MHz (Model 3102)

500 MHz antenna. Not Model 3102 HP or 3102 DP

Data Collection Mode: Continuous
Range: 60ns
Samples per Scan: 512
Resolution: 16 bits
Number of gain points: 3
Vertical High Pass Filter: 125 MHz
Vertical Low Pass Filter: 1000 MHz
Scans per second: 120
Transmit Rate: 100 KHz

400 MHz (Model 5103)

400 MHz ground coupled antenna. Depth of viewing window is approximately 3m assuming a dielectric constant of 5.

Range: 50 ns
Samples per Scan: 512
Resolution: 16 bits
Number of gain points: 3
Vertical High Pass Filter: 100 MHz
Vertical Low Pass Filter: 800 MHz
Scans per second: 120
Transmit Rate: 100 KHz

270 MHz (Model 5104)

270 MHz ground coupled antenna. Depth of viewing window is approximately 4m assuming a dielectric constant of 5.

Range: 75 ns
Samples per Scan: 512
Resolution: 16 bits
Number of gain points: 3
Vertical High Pass Filter: 75 MHz
Vertical Low Pass Filter: 700 MHz
Scans per second: 120
Transmit Rate: 100 KHz

200 MHz (Model 5106)

200 MHz ground coupled antenna. Lower frequency antenna optimized for mid-range profiling.

Range: 100ns
Samples per Scan: 512
Resolution: 16 bits
Number of gain points: 5
Vertical High Pass Filter: 50 MHz
Vertical Low Pass Filter: 600 MHz
Scans per second: 64
Transmit Rate: 100 KHz

100 MHz (Model 3207)

100 MHz ground coupled antenna. Low frequency for deeper profiling.

Range: 500ns
Samples per Scan: 512
Resolution: 16 bits
Number of gain points: 5
Vertical High Pass Filter: 25 MHz
Vertical Low Pass Filter: 300 MHz
Scans per second: 16
Transmit Rate: 50 KHz

E.2: Parameter Listing for Older/Specialty Antennae

The following list of antenna setups is provided to assist you in using the SIR 3000 with additional antennae. To use this list, you must enter the correct parameters. You may wish to save any special parameters in a separate setup (under the System menu) to help you easily recall them. Some of these are no longer commercially available, but the system does function with all older antennas. They are designated by their center frequency, and in some cases a D or S which noted whether that setup is for Deep or Shallow prospecting. Please note that many of these antennae have a different listed transmit rate than the default one on the SIR 3000. The transmit rate listed here is the rate that the antenna was tested and rated at. It may function correctly at a higher transmit rate and allow you to collect data faster, but you must pay careful attention to your data to decide if the antenna is functioning correctly at the different rate.

If your system is beeping, it indicates that your T_RATE is too high for this antenna.

300-Deep

Old 300 MHz antenna.

Data Collection Mode: Continuous
Range: 300ns
Samples per Scan: 1024
Resolution: 16 bits
Number of gain points: 5
Vertical High Pass Filter: 100 MHz
Vertical Low Pass Filter: 1000 MHz
Scans per second: 32
Horizontal Smoothing: 5 scans
Transmit Rate: 50 KHz

300-Shallow

Old 300 MHz antenna.

Data Collection Mode: Continuous
Range: 150ns
Samples per Scan: 512
Resolution: 16 bits
Number of gain points: 5
Vertical High Pass Filter: 100 MHz
Vertical Low Pass Filter: 1000 MHz
Scans per second: 32
Horizontal Smoothing: 5 scans
Transmit Rate: 50 KHz

120-Deep-Unshielded

120 MHz standard antenna.

Data Collection Mode: Continuous
 Range: 400ns
 Samples per Scan: 512
 Resolution: 16 bits
 Number of gain points: 5
 Vertical High Pass Filter: 30 MHz
 Vertical Low Pass Filter: 240 MHz
 Scans per second: 32
 Horizontal Smoothing: 5 scans
 Transmit Rate: 50 KHz

120-Shallow-Unshielded

120 MHz standard antenna.

Data Collection Mode: Continuous
 Range: 200ns
 Samples per Scan: 512
 Resolution: 16 bits
 Number of gain points: 5
 Vertical High Pass Filter: 30 MHz
 Vertical Low Pass Filter: 240 MHz
 Scans per second: 32
 Horizontal Smoothing: 5 scans
 Transmit Rate: 50KHz

100 High Power

100 MHz antenna with high power transmitter.

Data Collection Mode: Continuous
 Range: 500ns
 Samples per Scan: 512
 Resolution: 16 bits
 Number of gain points: 5
 Vertical High Pass Filter: 25 MHz
 Vertical Low Pass Filter: 200 MHz
 Scans per second: 16
 Horizontal Smoothing: 5 scans
 Transmit Rate: 12 KHz

100 Very High Power

100 MHz antenna with very high power transmitter.

Data Collection Mode: *Continuous*
 Range: 500ns
 Samples per Scan: 512
 Resolution: 16 bits
 Number of gain points: 5
 Vertical High Pass Filter: 25 MHz
 Vertical Low Pass Filter: 200 MHz
 Scans per second: 16
 Horizontal Smoothing: 5 scans
 Transmit Rate: 6 KHz

Subecho 70

70 MHz antenna with high power transmitter.

Data Collection Mode: Continuous
 Range: 500ns
 Samples per Scan: 512
 Resolution: 16 bits
 Number of gain points: 5
 Vertical High Pass Filter: 15 MHz
 Vertical Low Pass Filter: 150 MHz
 Scans per second: 16
 Horizontal Smoothing: 5 scans
 Transmit Rate: 12 KHz

Subecho 40

Data Collection Mode: Continuous
 Range: 1000ns
 Samples per Scan: 512
 Resolution: 16 bits
 Number of gain points: 5
 Vertical High Pass Filter: 10 MHz
 Vertical Low Pass Filter: 80 MHz
 Scans per second: 32
 Transmit Rate: 12KHz

80 MHz

80 MHz folded bow-tie antenna. Note: The 80 MHz antenna is unshielded.

Data Collection Mode: Continuous
Range: 500ns
Samples per Scan: 512
Resolution: 16 bits
Number of gain points: 5
Vertical High Pass Filter: 25 MHz
Vertical Low Pass Filter: 200 MHz
Scans per second: 32
Stacking: 32 scans
Transmit Rate: 50 KHz

MLF 120 cm

Low Frequency antenna 1.2m length. Note: The MLF antennas are unshielded.

Data Collection Mode: Point
Range: 250ns
Samples per Scan: 512
Resolution: 16 bits
Number of gain points: 5
Vertical High Pass Filter: 30 MHz
Vertical Low Pass Filter: 160 MHz
Scans per second: 32
Stacking: 32 scans
Transmit Rate: 12 KHz

MLF 240 cm

Low Frequency antenna length 2.4m

Data Collection Mode: Point
Range: 500ns
Samples per Scan: 512
Resolution: 16 bits
Number of gain points: 5
Vertical High Pass Filter: 15 MHz
Vertical Low Pass Filter: 90 MHz
Scans per second: 32
Stacking: 32 scans
Transmit Rate: 12 KHz

MLF 360 cm

Low Frequency antenna length 3.6m

Data Collection Mode: Point
Range: 750ns
Samples per Scan: 512
Resolution: 16 bits
Number of gain points: 5
Vertical High Pass Filter: 10
Vertical Low Pass Filter: 60
Scans per second: 32
Stacking: 32 scans
Transmit Rate: 12 KHz

MLF 480 cm

Low Frequency antenna set to a length of 4.8m

Data Collection Mode: Point
Range: 1000ns
Samples per Scan: 512
Resolution: 16 bits
Number of gain points: 5
Vertical High Pass Filter: 6
Vertical Low Pass Filter: 40
Scans per second: 32
Stacking: 32 scans
Transmit Rate: 12KHz

MLF 600 cm

Low Frequency antenna set to a length of 6.0m

Data Collection Mode: Point
Range: 1000ns
Samples per Scan: 512
Resolution: 16 bits
Number of gain points: 5
Vertical High Pass Filter: 1
Vertical Low Pass Filter: 50
Scans per second: 32
Stacking: 32 scans
Transmit Rate: 12 KHz

Borehole 120 MHz

Borehole antenna frequency 120 MHz. Note:
The borehole antennas are unshielded.

Data Collection Mode: Point
Range: 500ns
Samples per Scan: 512
Resolution: 16 bits
Number of gain points: 5
Vertical High Pass Filter: 30 MHz
Vertical Low Pass Filter: 240 MHz
Scans per second: 32
Stacking: 32 scans
Transmit Rate: 64 KHz

Borehole 300 MHz

Borehole antenna frequency 300 MHz.

Data Collection Mode: Point
Range: 300ns
Samples per Scan: 512
Resolution: 16 bits
Number of gain points: 5
Vertical High Pass Filter: 38 MHz
Vertical Low Pass Filter: 600 MHz
Scans per second: 32
Stacking: 32 scans
Transmit Rate: 64 KHz

Glossary of Terms in Pre-loaded Quick3D Setups

Note: You can alter any of these parameters after you have recalled them. The saved Setups represent common settings and are a good start point template.

Setup Descriptions:

1. 200_SW: A Model 5106 200 MHz antenna using the tow-behind Model 620 survey wheel (16" diameter).
2. 400_Cart A Model 5103 400 MHz antenna with the three-wheeled survey cart.
3. 900_Cart: A Model 3101D 900 MHz antenna with the three-wheeled survey cart.
4. 1600_B_5x or 1600_B_10x: A Model 5100 1.5 GHz antenna with the blue metal survey minicart. The final value before the x denotes grid size. Setups with the "G" designation in their name are optimized for the gray plastic model 613 minicart.

Antenna: Center frequency of the antenna you are using.

SW Cal: Calibration number in ticks/unit for the survey wheel you are using. See Chapter 3 of this manual for the factory supplied number for different wheels.

You may need to re-calibrate your survey wheel for local conditions.

Order: Either Zig-zag (scanning during the "up and back" directions of a survey) or Normal (scanning only in one direction).

Size: Default grid size.

Spacing: Default profile spacing.

Direction: Survey profile direction. The choice here is parallel to the listed axis. For example, "Yonly," means the profiles are parallel to the grids Y axis.

Range: The default time range in nanoseconds. You can change this under COLLECT > SCAN > RANGE.

DIEL: The default dielectric value. This is needed if you want the SIR 3000 to do a time to depth calculation during data collect. This is also used for the auto migrate display during data collection and playback. This has no bearing over depth of investigation.

Rate: The number of scans/second that the system is able to collect. The recommended number is 120 per second at 512 samples/scan. A higher sample density will slow this down automatically.

SCN/UNIT: The number of scans per unit that the system is collecting along your profile line.

Gain: Either Auto or Manual.

Points: The number of gains points evenly distributed along the vertical range.

LP IIR: Infinite Impulse Response Low Pass frequency filter. Contains antenna-specific information that the SIR 3000 needs to use with the selected antenna.

HP IIR: Infinite Impulse Response High Pass frequency filter. Contains antenna-specific information that the SIR 3000 needs to use with the selected antenna.

LP FIR: Finite Impulse Response Low Pass frequency filter. Contains antenna-specific information that the SIR 3000 needs to use with the selected antenna.

HP FIR: Finite Impulse Response High Pass frequency filter. Contains antenna-specific information that the SIR 3000 needs to use with the selected antenna.

Stacking: A horizontal high pass noise reduction filter.

BGR RMVL: Background Removal is a horizontal low pass noise reduction filter.

MIG-COL: Toggles the migration display during data collection on and off.

MIG-PB: Toggles the migration display during data PLAYBACK on and off.

C Table: Toggles the default color table.

C XFORM: Toggles the default color transform.

Gain(db): Indicates added display gain.

Path: Default data pathway.

Appendix F: Glossary of Terms and Suggestions for Further Reading

Antenna: a paired transmitter and receiver that sends electromagnetic energy into a material and receives any reflections of that energy from materials in the ground. Also called a transducer. Antennae are commonly referred to by their center frequency value (i.e. 400MHz, 1.5Ghz). This frequency determines the depth of penetration and the size of the objects or layers visible.

Attenuation: the weakening of a radar pulse as it travels through different materials.

Center Frequency: the median transmit frequency of an antenna. The antenna will also transmit energy at a frequency range of 0.5-2 times its center value. For example, a 400 MHz antenna may actually transmit at a range from 200-800 MHz.

Clipping: occurs when the amplitude of a reflection is greater than the maximum recordable value. The system disregards the true value of the reflection and writes in the maximum allowable value. Clipping appears in the O-Scope as signal that “goes off the scale” at the sides of the window.

Dielectric permittivity: the capacity of a material to hold and pass an electromagnetic charge. Varies with a material’s composition, moisture, physical properties, porosity, and temperature. Used to calculate depth in GPR work.

EM: Acronym for electro-magnetic.

FCC: Acronym for Federal Communications Commission. The United States governmental body that oversees the UWB industry of which GPR is a part.

Gain: amplifying the signal to certain section of a radar pulse in order to counteract the effects of attenuation and make features more visible.

GHz: Acronym for Gigahertz. A measurement of frequency equal to one billion cycles per second.

GPR: Acronym for Ground Penetrating Radar.

Ground-coupling: the initial entry of a radar pulse into the ground.

Hyperbola: an inverted “U.” The image produced in a vertical linescan profile as the antenna is moved over a discrete target. The top of the target is at the peak of the first positive (white in a grayscale color table) wavelet.

Interface: the surface separating materials with differing dielectric constants or conductivity values.

KHz: Acronym for Kilohertz. A measurement of frequency equal to one thousand cycles per second.

Linescan: commonly used method of depicting a radar profile. Linescans are produced by placing adjacent scans next to each other and assigning a color scheme to their amplitude values.

Macro: a preset list of processing options that may be applied to perform repetitive functions on an entire dataset. Macros may be created and edited to include different functions (see RADAN manual for addition information).

Mark: point inserted along a survey line manually by the operator or at preset intervals.

MHz: Acronym for Megahertz. A measurement of frequency equal to one million cycles per second.

Migration: mathematical calculation used to remove outlying tails of a hyperbola and to accurately fix the position of a target.

Nano-second: unit of measurement for recording the time delay between transmission of a radar pulse and reception of that pulse's reflections. Equal to one one-billionth of a second.

Noise: unwanted background interference that can obscure true data.

Noise floor: time depth at which the noise makes target identification impossible.

nS: see Nano-Second.

Oscilloscope: device used to view and measure the strength and shape of energy waves. Common term in GPR industry for a method of data display showing actual radar wave anatomy.

Passband: the frequency range at which the antenna is emitting energy. It is roughly equivalent to 0.5-2 times the center frequency.

RAM: Acronym for random access memory. Temporary memory in which a computer stores information used with a running program, or temporarily stored data before it is written to a hard drive.

Range: the total length of time (in nanoseconds) for which the control unit will record reflections. Note: indicates two-way travel time.

RF: Acronym for radio frequency.

Sample: a radar data point with two attributes: time and reflection amplitude. A third attribute, position, is assigned by the user. Under-sampling will produce a scan wave that does not contain enough information to draw a smooth curve. It may miss features. Over-sampling will produce a larger data file.

Samples/Scan: the number of samples recorded from an individual radar scan. Commonly set to 512.

Scan: one complete reflected wave from transmission to reception, sometimes called a trace.

Survey wheel: wheel attached to an antenna and calibrated to record precise distances. Necessary for accurate data collection.

Time-slice: a horizontal planview of amplitude values drawn from adjacent vertical profiles. The time-slice is produced for a particular time-depth and is vital for understanding the horizontal positions of features in a survey area.

Time window: the amount of time, in nano-seconds, that the control unit will count reflections from a particular pulse. Set by the operator.

Transect: a line of survey data. An area is systematically surveyed by recording transects of data at a constant interval. The transects are then placed in their correct position relative to each other in a computer and horizontal time-slices are produced.

UWB: Acronym for Ultra-Wide Band. Refers to the wide frequency band of emissions put out by a GPR device.

Wiggle trace: method of GPR data display showing oscilloscope trace scans placed next to each other to form a profile view. Commonly used method in seismic studies.

Further Reading

- Davis, J.L., Annan, A.P.
Ground-penetrating radar for high-resolution mapping of soil and rock stratigraphy. *Geophysical Prospecting* 37, 531–551.
- Conyers, Lawrence B., and Dean Goodman
Ground Penetrating Radar: An Introduction for Archaeologists. Altamira Press.
- Hatton, L., Worthington, M.H., and Makin, J.
1986 *Seismic Data Processing Theory and Practice*, Blackwell Scientific Publications, Boston, MA., 177p.
- Jackson, J.D.
1975 *Classical Electrodynamics*. Wiley & Sons.
- Jordan, E.C., Balmain, K.G.
1968 *Electromagnetic Waves and Radiating Systems*. Prentice-Hall, NJ, pp. 139–144.
- Oppenheim, Willsky and Young
1983 *Signal and Systems*. Prentice Hall.
- Reynolds, John M.
1997 *An Introduction to Applied and Environmental Geophysics*. Wiley and Sons.
- Roberts, R.L., Daniels, J.J.
1996 Analysis of GPR Polarization Phenomena. *JEEG* 1 2 , 139–157.
- Sheriff, R.E., and Geldart, L.P.
1985 *Exploration Seismology Volume 1 - History, Theory, and Data Acquisition*, Cambridge University Press, New York, 253 p.
- Sheriff, R.E., and Geldart, L.P.
1985 *Exploration Seismology Volume 2 - Data-Processing and Interpretation*, Cambridge University Press, New York, 221 p.
- Telford, W.M., Geldart, L.P., Sheriff, R.E.
Applied Geophysics. Cambridge Univ. Press, MA, p. 291.
- Wait, J.R.
Geo-Electromagnetism. Academic Press, New York.
- Yilmaz, Oz
Seismic Data Analysis: Processing, Inversion, and Interpretation of Seismic Data. Investigations in Geophysics No. 10, Society of Exploration Geophysicists, Tulsa, OK.

Useful Websites:

- 1** Geophysical Survey Systems, Inc.:
www.geophysical.com
- 2** United States Department of Agriculture Soils Website:
<http://soils.usda.gov/>
- 3** USDA-Natural Resources Conservation Service, Ground Penetrating Radar Program:
<http://nesoil.com/gpr/>
- 4** USDA – Natural Resources Conservation Service, GPR Soil Suitability
http://www.nrcs.usda.gov/wps/portal/nrcs/detail/soils/use/maps/?cid=nrcs142p2_053622
- 5** USDA-Natural Resources Conservation Service, Web Soil Survey
<http://websoilsurvey.sc.egov.usda.gov/App/HomePage.htm>
- 6** North American Database of Archaeological Geophysics:
www.cast.uark.edu/nadag

Appendix G: Installing Microsoft ActiveSync on Your PC

Connecting your SIR 3000 to your PC for the first time, and Installing Microsoft ActiveSync.

Warning: RADAN 4.0.2.0 and 5.0.0.0 CDs have an older version of the SIR 3000 USB Transfer software that will significantly limit your transfer speed. If you had already installed the transfer software from one of these disks or from the previous version on the web site, please contact GSSI software technical support.

Part 1: Having your PC recognize the SIR 3000 unit

- 1** Please download the latest transfer software and instructions from <https://support.geophysical.com>. Navigate to the SIR 3000 software downloads. Download the SIR 3000 USB transfer software file “ASUSBwoMSASYNC.exe” and extract it to the root directory (typically C:\). Please note the location where you extracted it. You will need this information for a later step.
- 2** With both PC and SIR 3000 running, but not collecting or playing back data...
- 3** Plug Master (rectangular) end of USB cable into PC.
- 4** Plug Slave (square) end of USB cable into SIR 3000.
- 5** Your PC will generate a dialog stating that a new USB Device has been found.

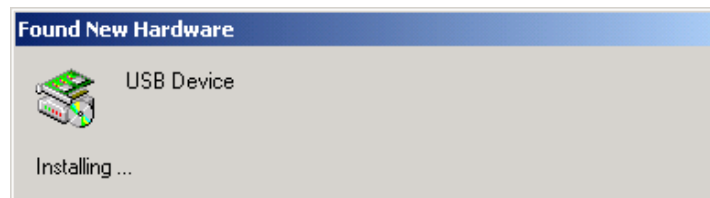

The remaining steps vary depending on operating system. Steps for both Windows 2000 and Windows XP are both included in two sections below:

Windows 2000:

- 1 At the Found New Hardware Wizard, click Next >.
- 2 At the Install Hardware Device Drivers dialog, select Search for a suitable driver for my device and click Next >.



- 3 At the Locate Driver Files dialog, deselect floppy and CD-ROM drives and select Specify a location.
Click Next >.

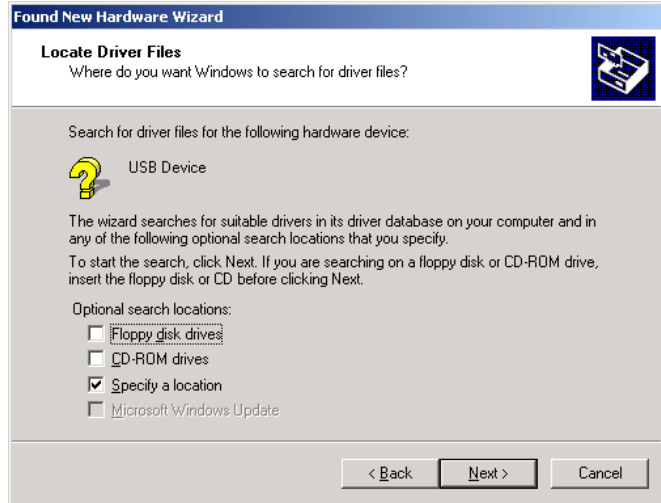

- 4 When directed to Insert the manufacturer's installation disk..., click Browse. Find the directory you extracted the ASUSBwoMSAS drivers to earlier (either C:\ASUSB or C:\ASUSBwoMSAS directory by default) and select wceusbsh.inf.
Click OK.



- 5 If you selected the correct directory, you get the following dialog.
Click Next >.

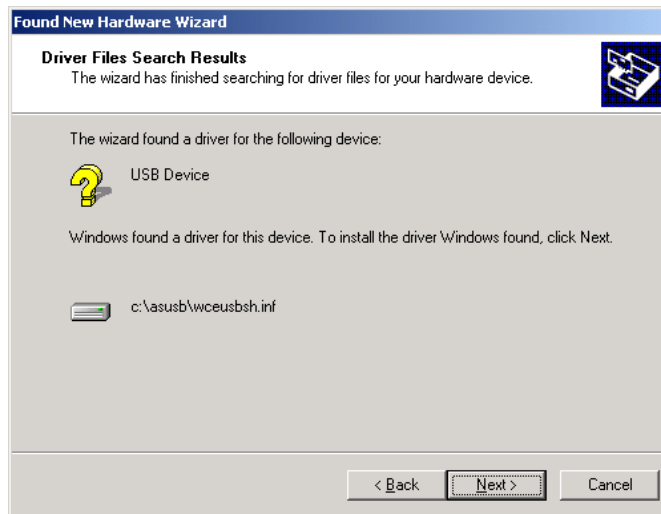

- 6 The installation is complete. Click Finish.

Windows XP:

- 1 At the Found New Hardware Wizard, select Install from a list or specific location and click Next >.



- 2 At the search and installation options dialog, select Search for the best driver in these locations in these locations and Include this location in the search. Click Browse. Find the directory you extracted the ASUSBwoMSAS drivers to earlier (either C:\ASUSB or C:\ASUSBwoMSAS directory by default) and select wceusbsh.inf. Click OK.

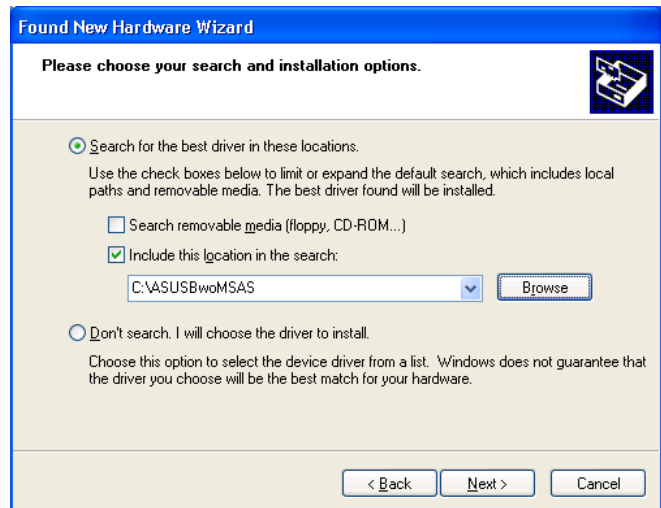

- 3 Finish the driver installation by following the onscreen instructions. You will see the following dialog. Select Continue Anyway.



Part 2: Installing Microsoft ActiveSync

After the USB connection is installed, install the latest version of MS ActiveSync. It can be downloaded from Microsoft's web site.

- 1 Using a web browser go to <http://www.microsoft.com/>. Search for Active Sync or ActiveSync.
- 2 Download the latest version of MS ActiveSync. If saved to disk, double click on the MSASYNC.exe icon directory to start the installation. It will copy files and then begin setup.



- 3 Follow the onscreen instructions to complete the Microsoft ActiveSync setup. Use the default folder if possible. It is likely that the installation will appear to hang at approx. 91% for a few minutes. Allow it to continue.
- 4 After completion you may see the New Partnership dialog. In order to successfully transfer SIR 3000 data via USB you will need to set up a guest connection with the SIR 3000. Select No at this dialog each time you connect your SIR 3000, as you do not synchronize any information with the PC. Synchronization is for Pocket PC users (and similar) who need to synchronize information. You should configure MS ActiveSync to bypass this dialog by following Step 1 of Part 3 below.

Part 3: Configuring Microsoft ActiveSync

If you have trouble with your MS ActiveSync connection to the SIR 3000 check your configuration.

- 1 If you do not want to respond to the New Partnership dialog each time you connect the SIR 3000 to your PC, find and double click on ActiveSyncKeys.exe in the ASUSB or ASUSBwoMSAS directory. Select Force Guest Only connections, and click okay.

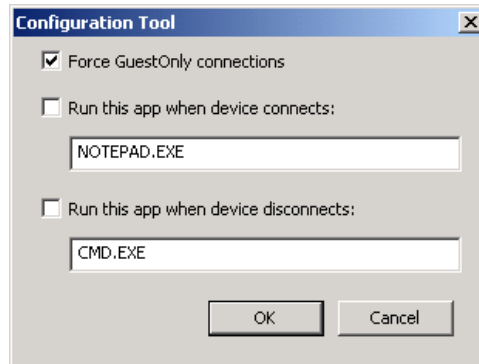

- 2 Double click on Microsoft ActiveSync icon. Go to File > Connection Settings... Make the selections shown below. Click Next >.

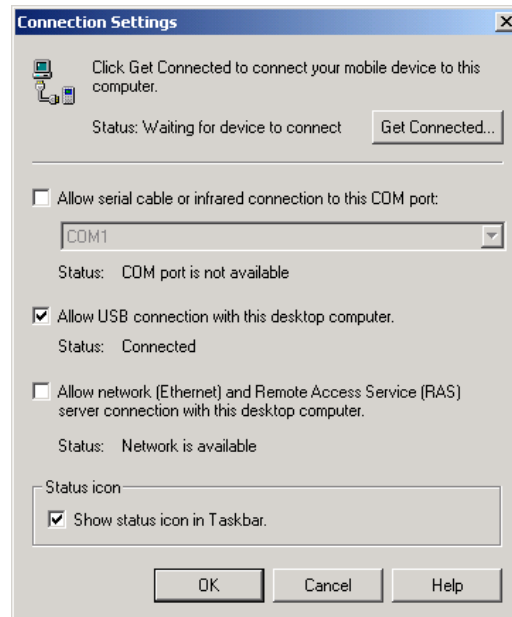

- 3 At this point you should disconnect the USB cable from the SIR 3000 and reboot the SIR 3000. After the SIR 3000 starts reconnect the USB cable.
- 4 You should see the ActiveSync symbol turn green in the system tray at this point you can right click on that icon and select Explore.
- 5 You can now Transfer data to your PC through the USB connection.