



Getting Started with Mastercam Lathe

May 2016

Mastercam 2017[®]

Mastercam® 2017 Lathe: Getting Started

Date: May 2016

Copyright © 2016 CNC Software, Inc.— All rights reserved.

Software: Mastercam 2017

TERMS OF USE

Use of this document is subject to the Mastercam End User License Agreement. The Mastercam End User License Agreement can be found at:

<http://www.mastercam.com/companyinfo/legal/LicenseAgreement.aspx>

Be sure you have the latest information!

Information might have been changed or added since this document was published. The latest version of this document is installed with Mastercam or can be obtained from your local Reseller. A ReadMe file (ReadMe.pdf)—installed with each release—includes the latest information about Mastercam features and enhancements.

Contents

Introduction	5
▶ Tutorial Goals.....	6
General Tutorial Requirements.....	6
1. General Setup.....	7
▶ Lesson Goals	7
▶ Getting Ready to Work.....	7
▶ Exercise 1: Loading a Machine Definition	10
▶ Exercise 2: Orienting the Part.....	12
▶ Exercise 3: Using a Lathe Coordinate System.....	15
▶ Exercise 4: Creating 2D CAD Geometry	17
▶ Exercise 5: Setting Up the Stock in the Main Spindle	19
▶ Exercise 6: Defining the Chuck Jaws	23
2. Facing, Roughing, and Finishing the Outer Diameter	27
▶ Lesson Goals	27
▶ Exercise 1: Facing the Part	27
▶ Exercise 2: Roughing the Outer Diameter.....	30
▶ Exercise 3: Finishing	36
▶ Exercise 4: Backplotting the Toolpaths	39
3. Adding Grooves and Threads	43
▶ Lesson Goals	43
▶ Exercise 1: Grooving on the Outer Diameter: Multiple Chains	43
▶ Exercise 2: Grooving on the Outer Diameter: Rough Pass Only.....	49
▶ Exercise 3: Finishing with Plunge Cuts	51
▶ Exercise 4: Adding a Thread Toolpath.....	56

- ▶ Exercise 5: Verifying the Toolpaths 62
- 4. C-Axis Drilling Operations..... 67**
 - ▶ Lesson Goals 67
 - ▶ Exercise 1: Making Drill Geometry 67
 - ▶ Exercise 2: Adding a New Toolpath Group 70
 - ▶ Exercise 3: Creating a C-Axis Drill Operation..... 71
 - ▶ Exercise 4: Copying the Drilling Operation..... 77
 - ▶ Exercise 5: Modifying the Drilling Parameters..... 78
- 5. Cutoff and Stock Flip..... 83**
 - ▶ Lesson Goals 83
 - ▶ Exercise 1: Cutting Off the Part 83
 - ▶ Exercise 2: Programming a Stock Flip 87
- 6. Machining the Inner Diameter 93**
 - ▶ Lesson Goals 93
 - ▶ Exercise 1: Creating New Tools in the Lathe Tool Manager 93
 - ▶ Exercise 2: Facing the Back of the Part..... 101
 - ▶ Exercise 3: Drilling the First Inner Diameter 102
 - ▶ Exercise 4: Drilling the Second Inner Diameter..... 104
 - ▶ Exercise 5: Roughing and Finishing the Third Inner Diameter..... 107
 - ▶ Exercise 6: Adding an ID Thread 112
 - ▶ Exercise 7: Refining Your Verification Results 115
- 7. Post Output..... 121**
 - ▶ Lesson Goals 121
 - ▶ Exercise 1: Renumbering Tools 121
 - ▶ Exercise 2: Posting..... 123
- Conclusion..... 124**
 - ▶ Mastercam Resources 124
 - ▶ Mastercam Documentation..... 125
 - Contact Us..... 125

Introduction



Mastercam Lathe delivers comprehensive turning software with powerful toolpaths and techniques. In this tutorial, you create general turning, milling (c-axis), and miscellaneous operations to program the interior core of a hose nozzle in Mastercam 2017. The part requires basic lathe operations such as facing, roughing, and finishing as well as grooving and threading toolpaths.

Starting with Lesson 2, a blueprint at the beginning of each lesson provides the necessary dimensions you need to create the toolpaths. Within the parts folder that is delivered with this tutorial, you will find the original SOLIDWORKS™ part used in the tutorial.

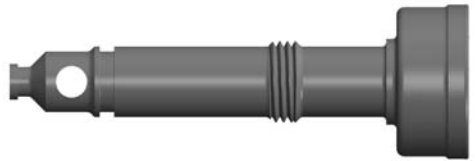

- `Nozzle - 2.SLDPRT`

For your reference, the folder also provides a sample of the part after each lesson:

- `Hose Nozzle - Inner Core - L1.mcam`
- `Hose Nozzle - Inner Core - L2.mcam`
- `Hose Nozzle - Inner Core - L3.mcam`
- `Hose Nozzle - Inner Core - L4.mcam`
- `Hose Nozzle - Inner Core - L5.mcam`
- `Hose Nozzle - Inner Core - L6.mcam`
- `Hose Nozzle - Inner Core - L7.mcam`

Place these files (extracted from `MCAM Lathe Getting Started-2017.zip`) anywhere on your system, but be sure to also keep unmodified copies.

Mastercam is a comprehensive CAD/CAM software program, with solutions for a wide array of machining applications. While this tutorial requires only a basic familiarity with Mastercam, its intention is to provide you with an introduction to the Lathe product. Use the resources listed at the end of this tutorial to explore and learn more about other features and functions in Lathe and in Mastercam.

Tutorial Goals

- Set up the job by creating a stock model and fixtures.
- Move the solid model to its machine orientation and create any necessary 2D geometry.
- Create and edit tools as required by the part operations and dimensions.



NOTE: The tool numbers called out in this tutorial are the defaults listed in the default library: `Lathe_mmm.Tooldb`. Your tools may have different tool numbers.

- Program operations to work on a part's inner and outer diameter.
- Use Mastercam's verification tools and posting to check your work.

Estimated time to complete this tutorial: 5 hours

General Tutorial Requirements

All Mastercam tutorials have the following general requirements:

- You must be comfortable using the Windows[®] operating system.
- The tutorials cannot be used with Mastercam Demo/Home Learning Edition (HLE). The Demo/HLE file format (`emcam`) is different from the Mastercam file format (`mcam`), and basic Mastercam functions, such as file conversions and posting, are unavailable.
- Each lesson in the tutorial builds on the mastery of preceding lesson's skills. We recommend that you complete them in order.
- Additional files may accompany a tutorial. Unless the tutorial provides specific instructions on where to place these files, store them in a folder that can be accessed from the Mastercam workstation, either with the tutorial or in any location that you prefer.
- You will need an internet connection to view videos that are referenced in the tutorials. All videos can be found on our YouTube channel: www.youtube.com/user/MastercamTechDocs.
- All Mastercam tutorials require you to configure Mastercam to work in a default metric or English configuration. The tutorial provides instructions for loading the appropriate configuration file.

LESSON 1

General Setup

Before generating toolpaths for the part, you must prepare Mastercam and the part file. This preparation includes such tasks as selecting a machine definition and defining the stock.

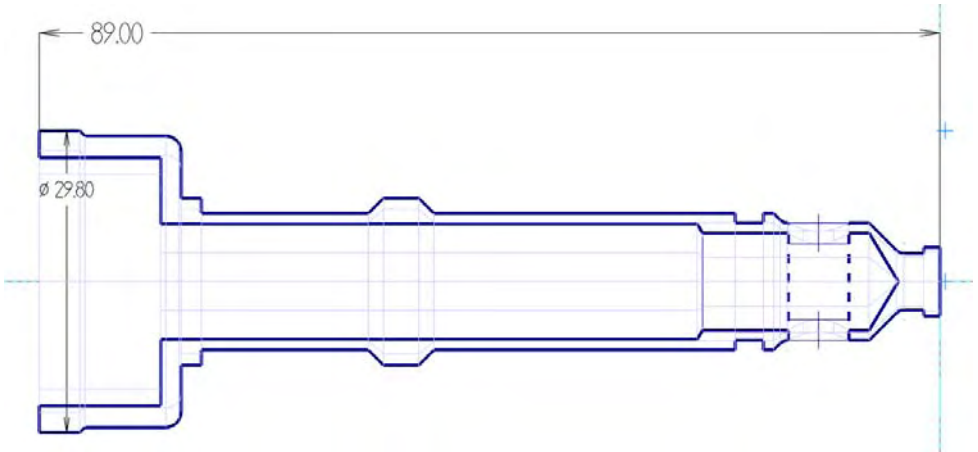

Lesson Goals

- Open and orient the part.
- Select a machine.
- Create 2D CAD part geometry.
- Define stock boundaries.
- Add chuck jaws.

Getting Ready to Work

This tutorial includes the files you need to complete the exercises. You can find these files in the tutorial's Parts folder. Place these files on your system wherever convenient, but be sure to keep an unmodified set. In preparation for this tutorial, set up Mastercam as described here.

► Select configuration file

- 1 Start Mastercam using your preferred method:
 - Double-click Mastercam's desktop icon.
 - Or
 - Launch Mastercam from the Windows Start menu.
- 2 Select the default metric configuration file:



- a Click the **File** tab.

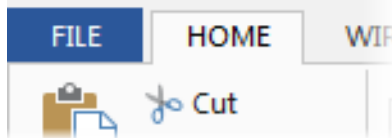

- b Choose **Configuration** from Mastercam's Backstage View to open the System Configuration dialog box.

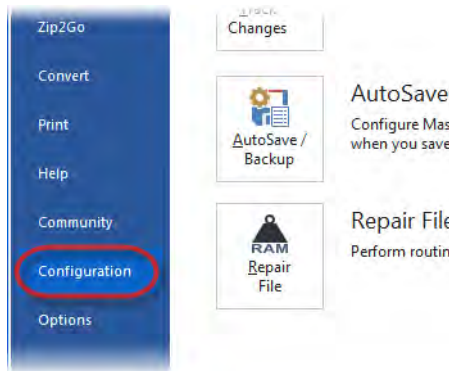

- c Choose ...**mcamxm.config** <Metric> from the **Current** drop-down list.

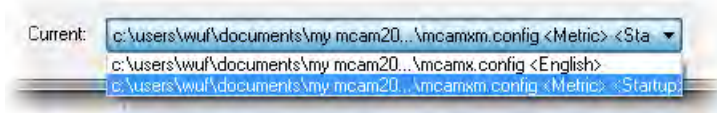

- d Click **OK**.

► Enable Backplot in Mastercam Simulator

This tutorial takes advantage of features in the Backplot mode available in Mastercam Simulator. Mastercam 2017 allows you to open either this version of Backplot or an earlier version (Classic Backplot) when you access it via the Backplot button in the Toolpaths Manager. Use the following procedure to ensure that Mastercam defaults to the more recent application.

- 1 From your Windows Start menu, select **All Programs, Mastercam 2017, Utilities, Advanced Configuration**.

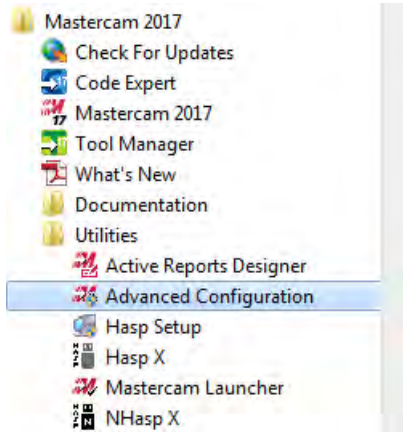

- 2 Select **Backplot**.
- 3 If necessary, choose the option to disable Classic Backplot from the drop-down menu.
- 4 Select **OK**.

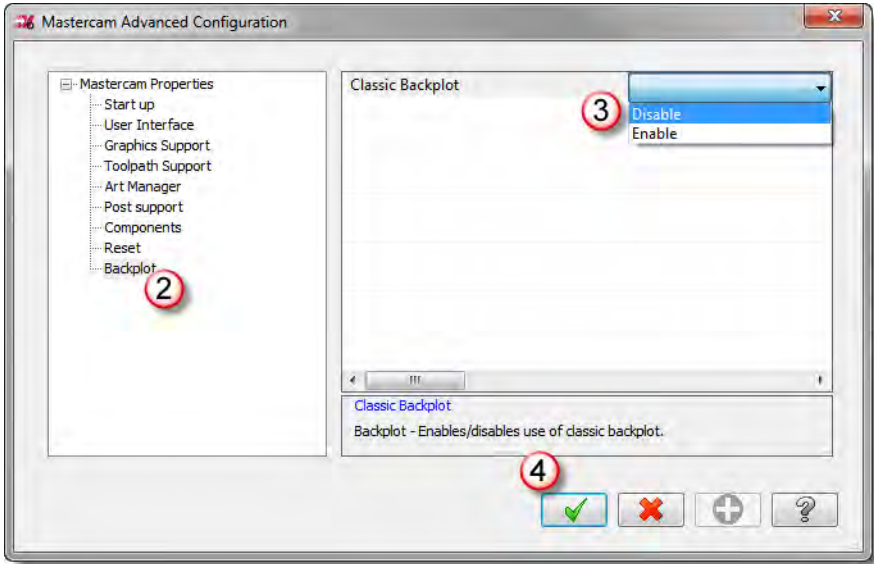

Exercise 1: Loading a Machine Definition

Your part file needs at least one machine group before you can create toolpaths on the part. Mastercam automatically creates a machine group for each machine you select from the machine selection menu item. To see how machine selection works, complete the following exercise.

- 1 Open the part file, `Nozzle-2.SLDprt`, which was provided with this tutorial.

Select **All Files (*.*)** from the file type drop-down to display all the files in the folder, regardless of file type.

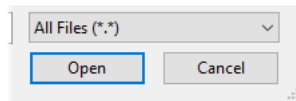

- 2 Save the part as `Hose Nozzle - Inner Core.mcam`.



Saving the part under a new name helps prevent you from accidentally modifying the original.

3 From the Machine tab, choose the **Lathe** machine type, and select **Default**.

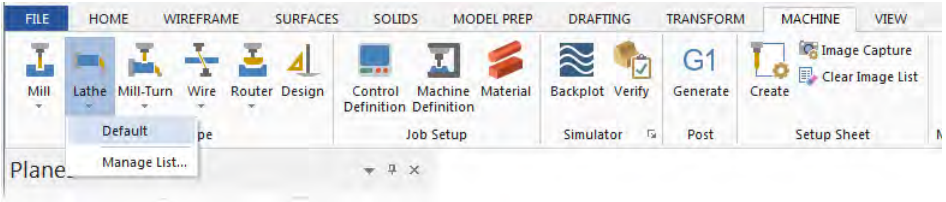

The menu lists all available machine definitions. This tutorial uses Mastercam's default Lathe machine. Normally, you would select the machine on which you plan to cut the part from the list displayed here.



TIP: To customize the Machine Selection lists, choose a machine type from the menu and **Manage List**. For more information on the dialog box that displays, click the dialog box's Help button.

► Rename the Machine Group

Machine groups store complete jobs for a specific machine. For example, if some toolpaths will be cut on a lathe, and other toolpaths on a mill, you can simply create a second machine group. Each machine group can store its own job setup information and tools, and use a different set of toolpath defaults. The toolpaths from each group will post to separate NC files.

Mastercam lets you create as many machine groups as you need to organize your work.

- 1 Right-click the machine group, and select **Groups, Rename** from the pop-up menu.

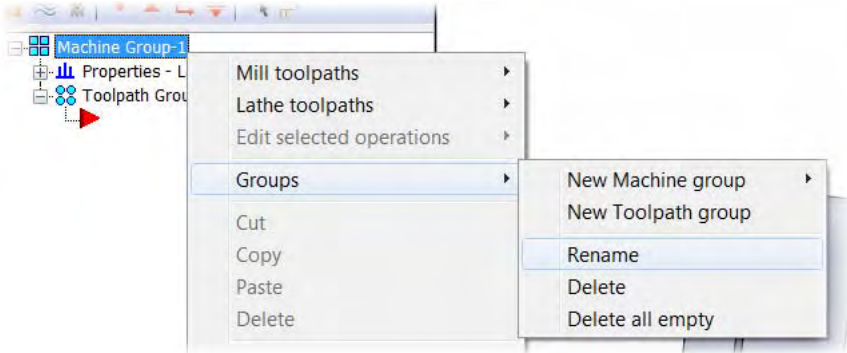

Mastercam highlights the current group name.

- 2 Type a new machine group name.

The machine group name can be anything you want, but it's best to choose a name that describes the machine and its operations.

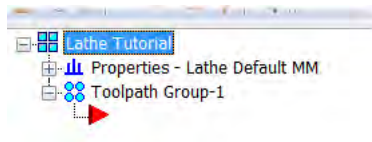

- 3 Select **File, Save** to save the file.

Exercise 2: Orienting the Part

Before you can machine the part, you need to move the geometry to its machine orientation. In this exercise, you use Mastercam's dynamic gnomon to re-align the part geometry to a typical horizontal lathe.

- 1 If necessary, press **[F9]** to display axes.

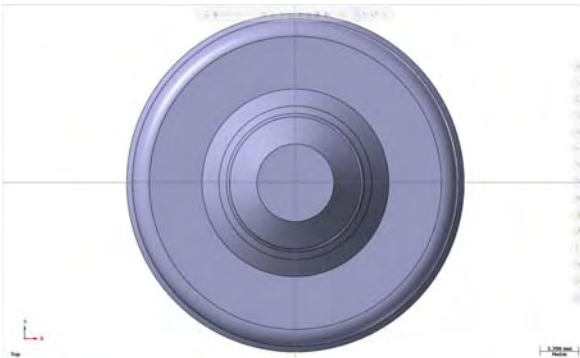

- 2 Right-click and change the GView to **Isometric** to view the entire part from another angle. You may wish to unzoom to get a clearer view of the origin.
- 3 Select **Dynamic** from the Transform tab.

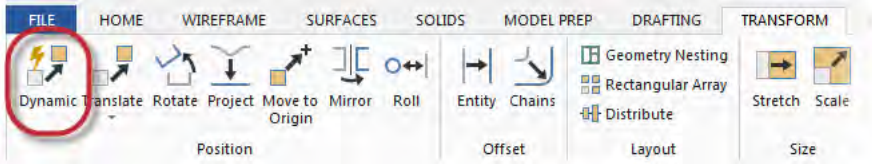

The Dynamic function panel displays.

- 4 Select the part and press [**Enter**], or click the **End Selection** button.

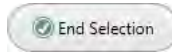

- 5 Use the AutoCursor to place the dynamic gnomon on the origin.

See Mastercam Help for more information on the AutoCursor.

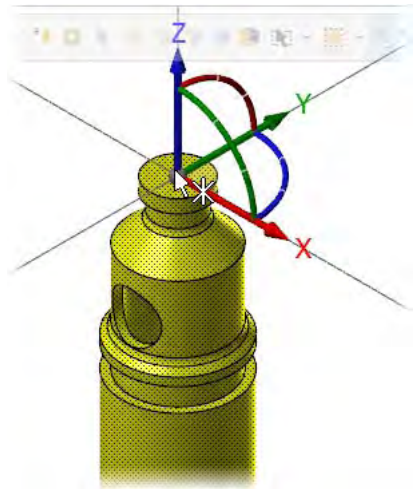

TIP: The interactive gnomon allows you to move, rotate, and align the selected geometry or the gnomon relative to the geometry. Toggle the button next to the gnomon to select either of these options.

By default, the geometry manipulation button is active when the gnomon is placed.



- 6 Confirm that **Move** is selected in the function panel.

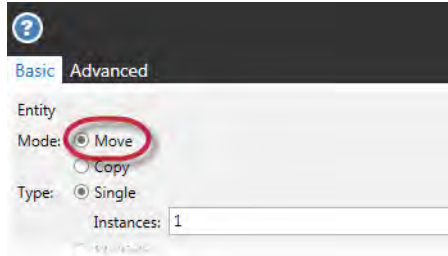

- 7 Select the center segment of the curved control to rotate the part 90 degrees so that it's length lies on the X axis.

Use your mouse to rotate the gnomon, or enter a value into the on-screen input box.

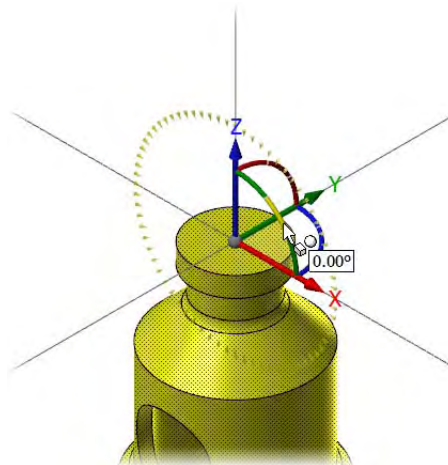

The graphics window will display a preview of the action..

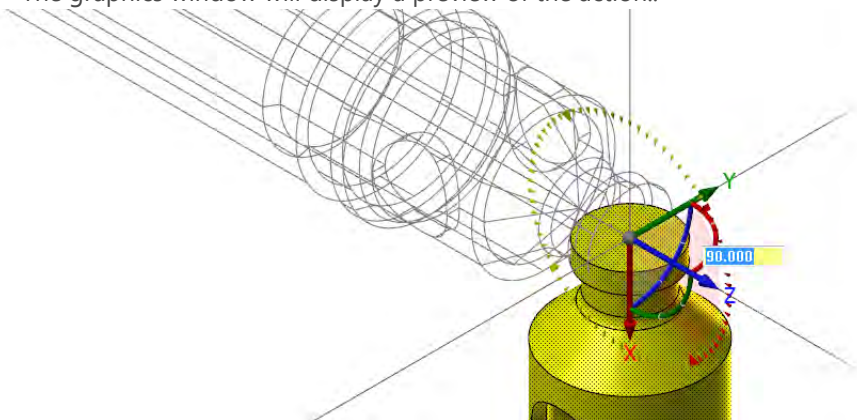

- 8 On the function panel, click **OK and Create New Operation**.



- 9 Select the part again, and rotate it 90 degrees so that the hole aligns with the Z axis.

Use the same method you used in Steps 4 – 7.

- 10 Click **OK** to accept the transformation.

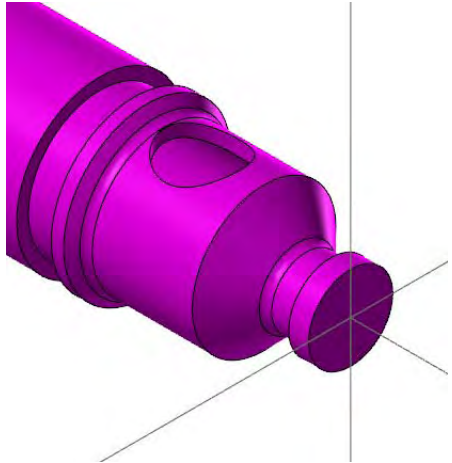

- 11 Right-click and choose the **Clear Colors** command from the mini-toolbar to remove the result colors from the translated geometry.

- 12 Save the file.

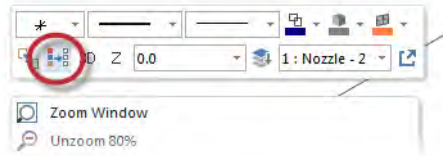

Exercise 3: Using a Lathe Coordinate System

The coordinate system for a traditional lathe turning application differs from the coordinate system for milling applications. Instead of a 3D/XYZ space, a lathe coordinate system for typical turning applications is 2D, with the tool axis perpendicular to the spindle (Z axis) instead of parallel to it. In other words,

- The D (diameter) axis in Lathe is equal to the Y axis in Mill.
- The Z (length) axis in Lathe is equal to the X axis in Mill.

Mastercam includes special lathe construction planes that let you work in radius or diameter coordinates. For conventional 2D turning applications, use the options in the Planes Manager to select the desired coordinate system.

- 1 Select the **Planes** tab to open the Planes Manager.

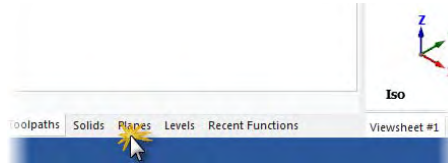

TIP: If a Managers tab is not available, select it from the Managers group on the View tab.

- 2 Click in the **+D +Z** row of the C column to use the upper-left diameter coordinates.

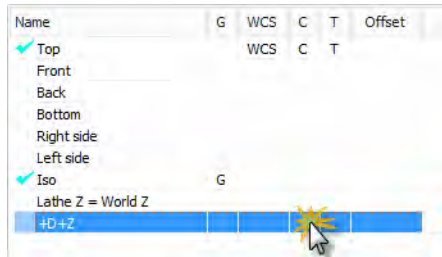

The Status bar indicator updates to reflect the new settings. The Gview gnomon in the lower-left corner of the graphics window displays the current coordinate system.

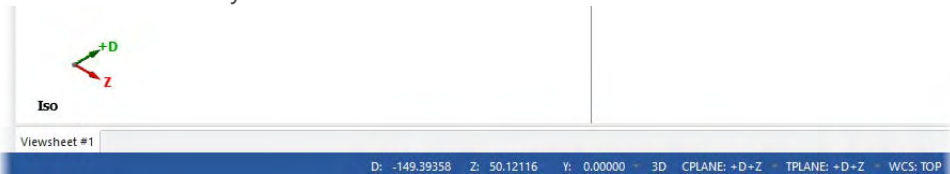

By default the Tplane follows the Cplane setting. For conventional 2D turning applications, you can leave the WCS as the system Top plane.



TIP: To work in a different quadrant or in a radius coordinate system (XZ), choose an option from the Planes Manager's **Select lathe plane** drop-down.

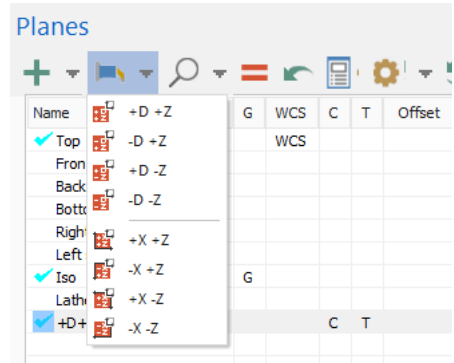

Exercise 4: Creating 2D CAD Geometry

Hose Nozzle - Inner Core.mcam is an imported solid with no wireframe geometry. To create Lathe toolpaths in Mastercam, you need two-dimensional geometry. This exercise teaches you how to create a two-dimensional profile from a solid part.

► Create a level for the new profile geometry

Use levels to organize part geometry. By organizing your files into levels, you can more easily control which areas of the drawing are visible at any time and what is selectable. In this section, you create a level specifically for the 2D profile geometry that you will create in the next section.

- 1 Click the **Levels** tab to open the Levels Manager.



- 2 Create a new main level by typing **2** and **Turn Profile** in the Number and Name fields.

The new level displays in the table with zero entities. A blue check indicates that it is the new main level.

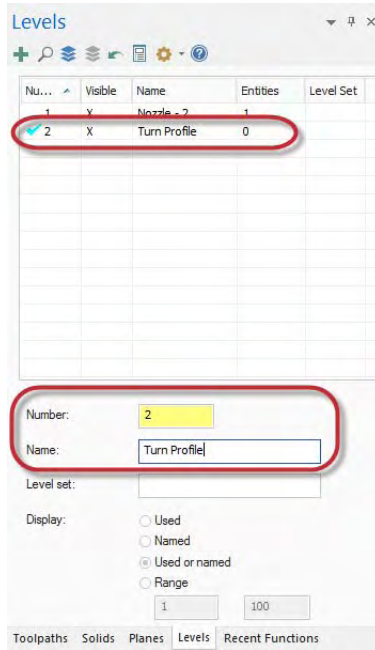

The current level displays on the Home tab.

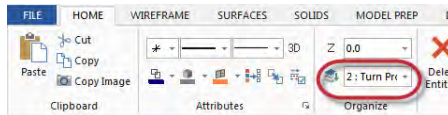

► Create the profile

- 1 From the **Wireframe** tab, select **Turn Profile**.

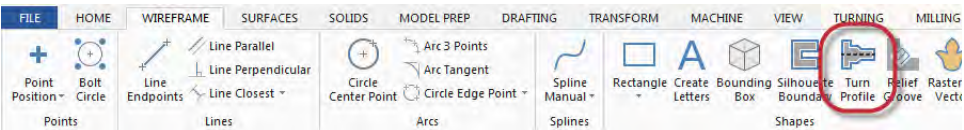

- 2 Select the part as prompted. Press **[Enter]**, or click the **End Selection** button.
The Turn Profile dialog box opens.

- 3 Use the **Spin** computation method.
 - The Spin method creates a profile by spinning the geometry about an axis.
 - The Slice method produces a profile by creating a cross-section through the geometry on the XY plane.
- 4 Reduce the Tessellation tolerance to **0.01**.
- 5 If necessary, choose the **Upper profile** option.
- 6 Click **OK**.

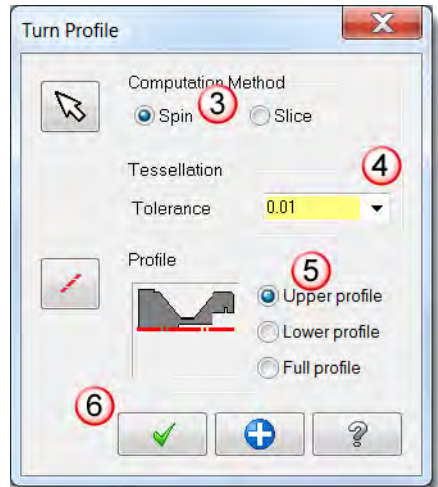

- 7 Return to the Levels Manager, and hide **Level 1** (click the **X** in the Visible column) to view the profile.

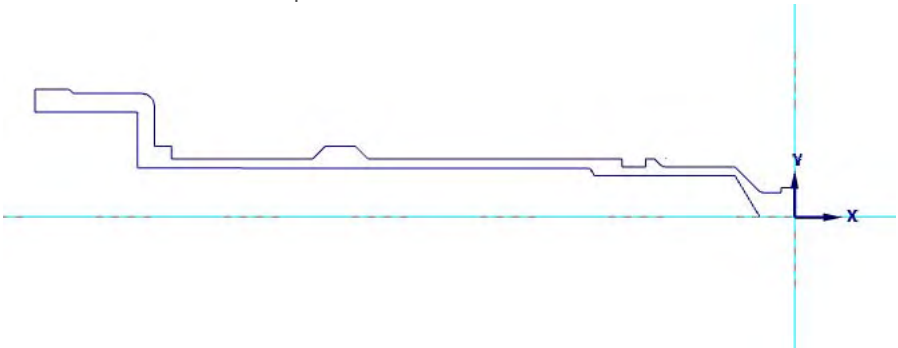

The illustration above shows the part from the TOP view.

- 8 Save the file.

Exercise 5: Setting Up the Stock in the Main Spindle

This exercise teaches you how to create the stock for the part, set the parameters for the stock to create stock margins and grip length, and place the stock in the correct Z position.

Creating the stock before creating the chuck jaws makes it easier to locate the stock relative to your part. Then, when you create the jaws, you can choose to automatically position them relative to the stock.

- 1 In the Toolpaths Manager, expand the **Properties** group and click **Stock setup** to open the Stock Setup tab of the Machine Group Properties dialog box.

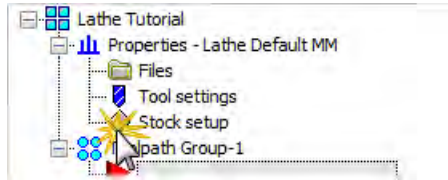

- 2 In the Stock section, select **Left Spindle** and click **Properties**.

The Machine Component Manager - Stock dialog box opens.

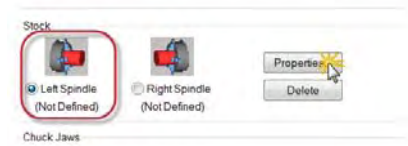

- 3 In the Name field, type in **Lathe Tutorial Stock** to name the stock setup for the main spindle.

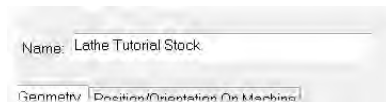

- 4 Choose **Cylinder** from the Geometry drop-down selections.

Cylinder lets you create 3D bar stock by entering or selecting its dimensions. This is suitable for most turning operations.

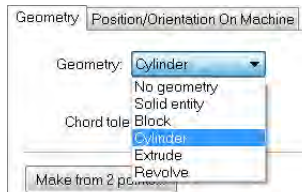

- 5 Click the **Make from 2 points** button.

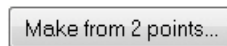

- 6 In the graphics window, select the origin and the top of the part's back face. If you have not already done so, change the GView to **TOP**.

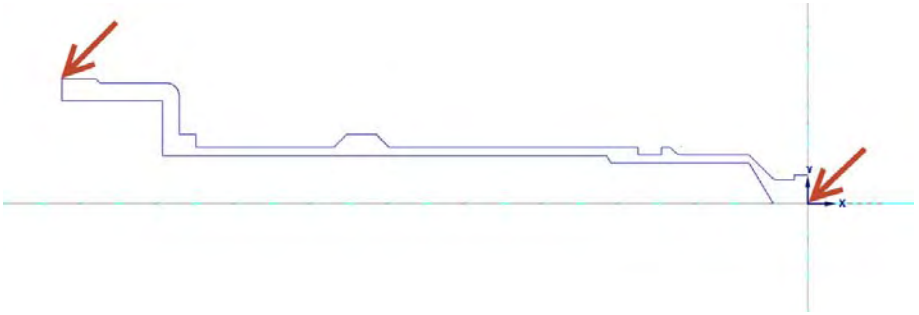

Mastercam 2017 calculates the distance between the points and enters the values of the part's outer diameter (OD) and length directly into the fields in the Machine Component Manager - Stock dialog box.

Measure from 2 points...

OD: 29.8

ID: 0.0

Length: 89.0

- 7 Add an additional **30** mm to the Length field.

The additional stock (about 30 percent) provides enough material for the main spindle chuck to hold the stock in place during machining.

Length: 119.0



TIP: Fields that take number values have a built-in calculator that let you enter simple formulas directly into the field.

ID: []

Length: 89+30

- 8 Confirm that the Position Along Axis is set to **0.0**, and the Axis field has **-Z** for the stock direction.

These two values determine the location and orientation of the cylinder. The center of the part's face lies on the origin, and the part is positioned along -Z.

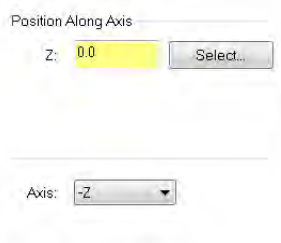

- 9 Select the **Use Margins** option to activate the stock margin fields.
- Enter **4.2** mm in the OD margin field and **1.0** mm in the Right Margin field.

This extra material protects against collisions. Mastercam will add the margin to the stock boundary when calculating Tool Clearance warnings.

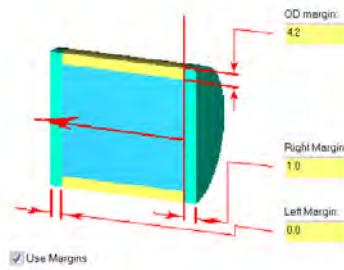

- 10 Click the **Position/Orientation On Machine** tab, and make sure the option, **Stock is drawn in position on the machine** is selected.

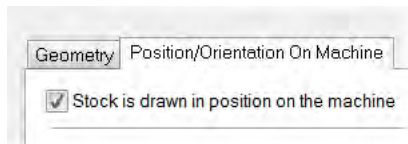

- 11 Return to the Geometry tab and click the **Preview Lathe Boundaries** button to view your results.



- 12 Press **[Enter]** to return to the Machine Component Manager - Stock dialog box.
- 13 Click **OK** to accept your lathe stock setup settings.
- The left spindle stock is defined.



Exercise 6: Defining the Chuck Jaws

In this exercise you will define the position and grip length for the chuck jaws. You can only use the method described below after the stock has been set up.

- 1 In the Chuck Jaws section, select **Left Spindle** and click **Properties**.

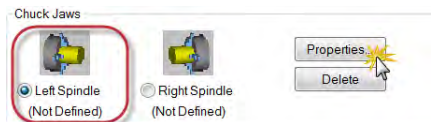

2 In the Position section:

- Select **From stock**.
- Enter **25 mm** in the Grip length field.

Mastercam uses these settings to calculate the chuck jaw's position in space using the defined stock, and to determine how much stock is being held by the chuck jaw.

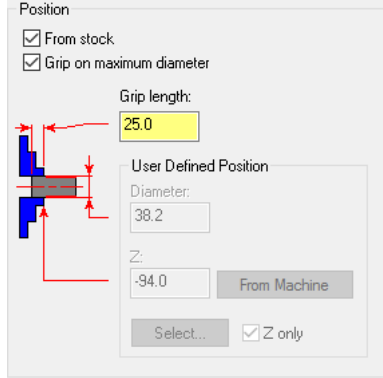

Your settings in the Machine Component Manager - Chuck Jaws dialog box should match the following graphic.

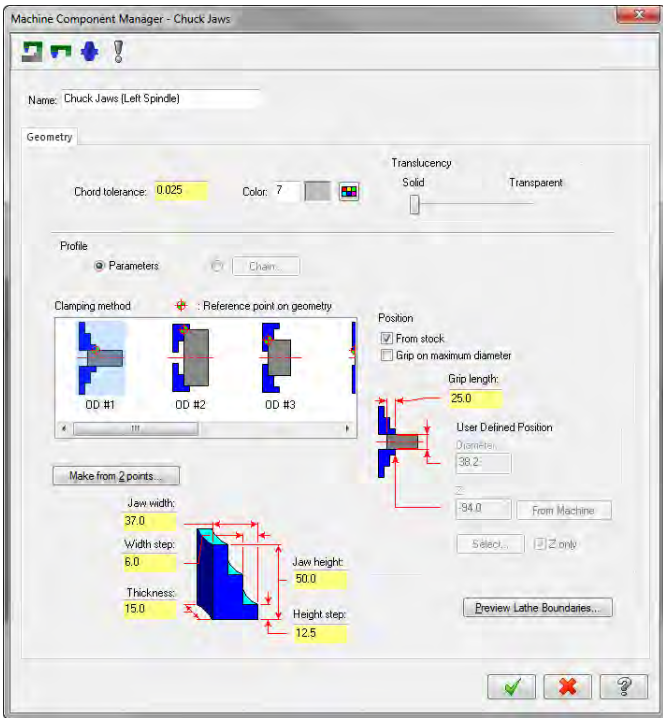



NOTE: If any of the other values you have differ from the values shown above, make changes to your values to match the graphic.

- 3 Click **OK** to accept these settings.

The Stock Setup tab displays with the left spindle's chuck jaws defined.

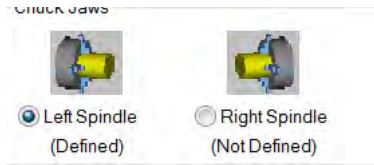

- 4 Select the **Shade boundaries** option to more easily see the stock boundaries and chuck jaws you have created.

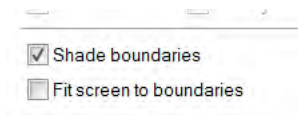

- 5 Click **OK** to close the Machine Group Properties dialog box.

- 6 Save the file.

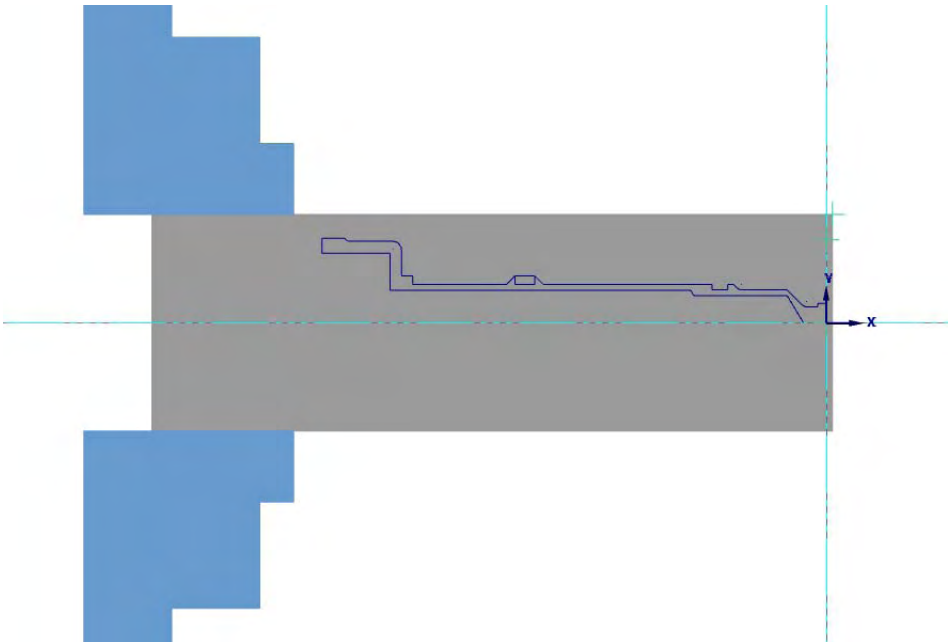

You have prepared your part. Now you can create toolpaths.

LESSON 2

Facing, Roughing, and Finishing the Outer Diameter

Once you have set up your job, you can begin creating toolpaths. Several toolpaths are normally involved in machining a lathe part. In this lesson you create the toolpaths necessary to shape the outer diameter (OD) of the part. Then, you backplot the operations you created to check your work.

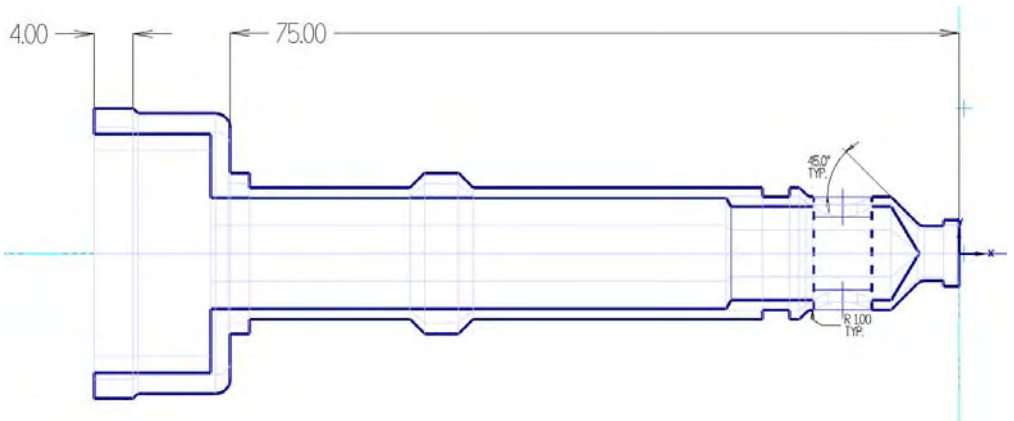

Lesson Goals

- Apply basic lathe toolpaths to the outer diameter of the part.
- Select tools and enter cutting values for each toolpath.
- Use Backplot and its functions to check your work.

Exercise 1: Facing the Part

Face toolpaths prepare the face of the part for further machining. Once the face of the part is clean, you can use it to set tools or determine tool offsets.

You do not need to chain geometry to create a face toolpath. Mastercam can create the toolpath entirely from parameters you enter in the Lathe Face dialog box.

1 Choose **Face** from the Lathe Turning tab.

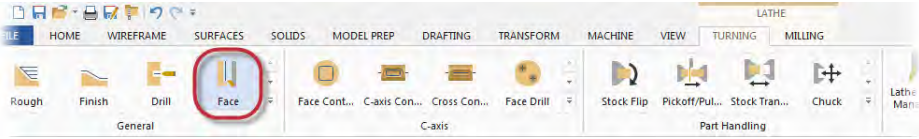

2 Click **OK** to accept the NC Name.
The Lathe Face dialog box opens.

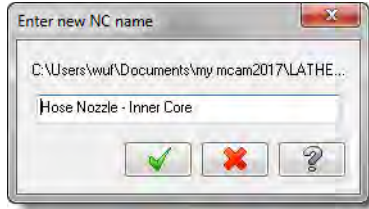

▶ Select the tool

1 From the Toolpath parameters tab, select the default OD roughing tool: **T0101 R0.8 OD ROUGH RIGHT - 80 DEG.**



TIP: Mastercam uses different colors to represent the orientation of lathe tool inserts.

- The tool has a red insert when the insert faces away from you.
- The tool has a yellow insert when the insert faces towards you.

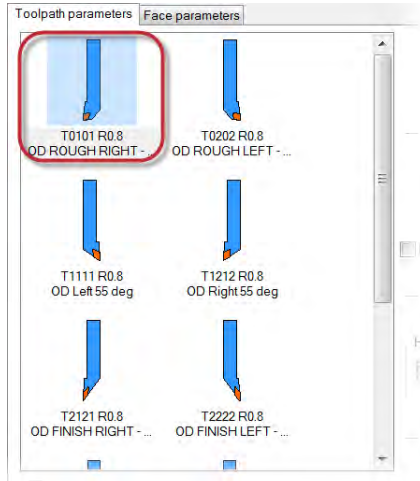

2 Keep all other parameters on this page at their default values.

▶ Enter the cutting values

1 Click the **Face parameters** tab.

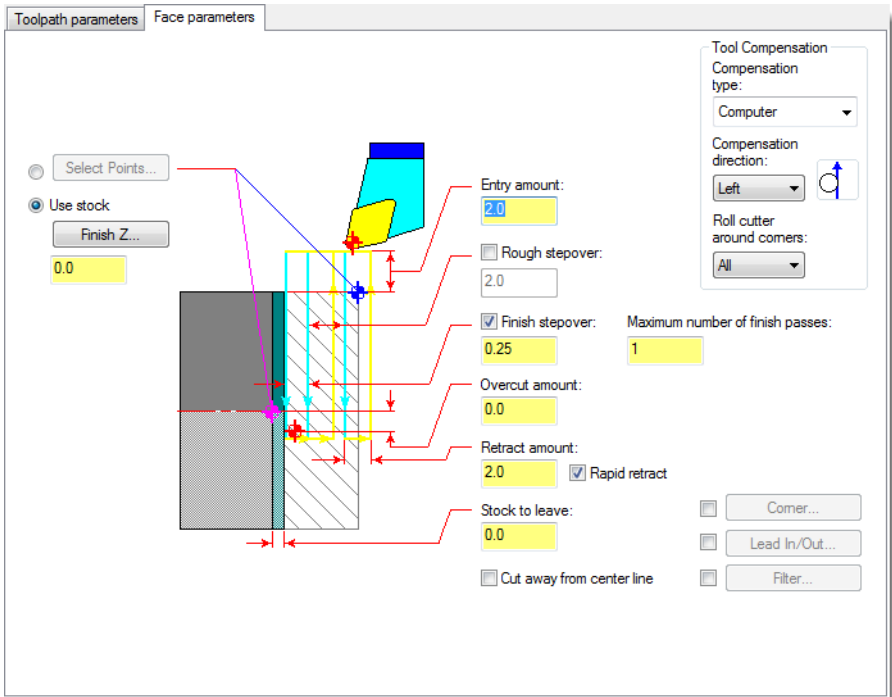

- 2 Confirm that **Use stock** is selected.

Use stock is available only if you have defined the stock boundary in Stock Setup. (See page 19.)

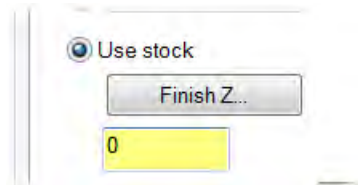

- 3 If necessary, enter **0** in the text box, or click **Finish Z** and select the origin from the graphics window to place the finished face at the origin.
- 4 Keep all other parameters on this page at their default values.
- 5 Click **OK** to create the toolpath.





NOTE: If you use the stock model for the start and end positions of each pass and the stock changes, the start and end positions of each pass are automatically updated when you regenerate the toolpath.

Exercise 2: Roughing the Outer Diameter

Use rough toolpaths to quickly remove large amounts of stock in preparation for a finish pass. Roughing passes are typically straight cuts parallel to the Z-axis.

Mastercam includes several types of roughing toolpaths:

- standard rough toolpaths, which let you access all of Mastercam's roughing options
- canned rough toolpaths, which use your machine tool's canned cycles to create the most efficient code (however, these do not offer as many options as the standard rough toolpaths)
- canned pattern repeat toolpaths, which create roughing passes in the shape of the part contour, rather than cutting parallel to the Z-axis
- dynamic rough toolpaths, which remain engaged in the material more effectively, and use more of the surface of your insert, extending the tool life and increasing the cutting speed
- contour rough toolpaths, which are useful for parts where the initial stock shape is similar to the final part shape, such as using a casting for stock

In this exercise, you create a standard rough toolpath.



VIDEO: Click the icon to see the difference between a dynamic rough toolpath and a standard rough toolpath.

▶ Chain the geometry

- 1 Right-click in the Toolpaths Manager. Select **Lathe toolpaths, Rough**.

The Chaining dialog box displays, and you are prompted to select an entry point.

Mastercam Lathe defaults to partial chaining.

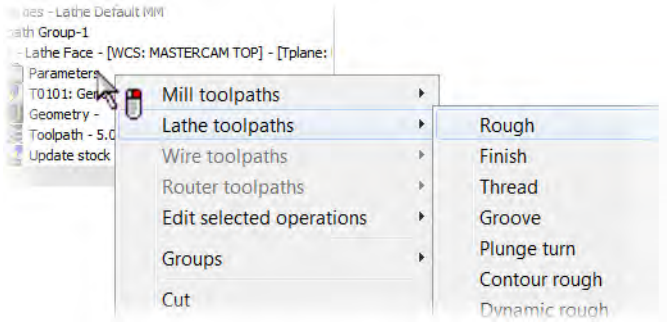

TIP: Access an extensive list of commands from the Toolpaths Manager's right-click menu.

- 2 Click the geometry at the first entity (a) and then, at the last entity (b) to create a partial chain.

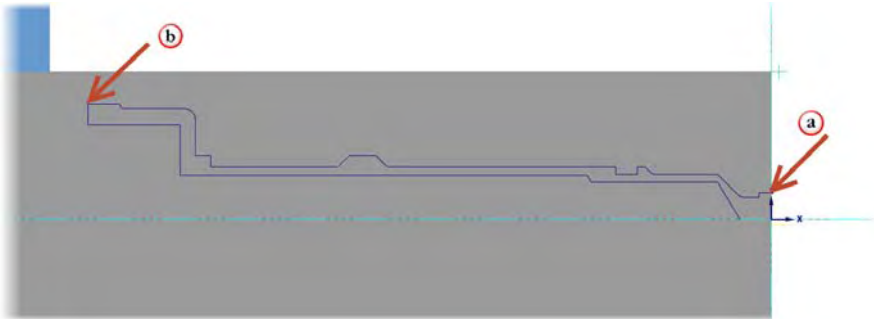

- 3 Click **OK** in the Chaining dialog box to accept the chain.



The Lathe Rough dialog box opens.

► Enter the toolpath parameters

Like many other toolpaths in Mastercam, you create the rough toolpath by entering tool and cutting values.

Select the tool

Use the Toolpath parameters tab to select a tool, set feeds and speeds, and modify other general toolpath parameters. This tab is similar for most Lathe toolpaths.

The tool numbers called out in this tutorial are the defaults listed in the default library: `Lathe_mm.Tooldb`. Your tools may have different tool numbers.

- 1 From the Toolpath parameters tab, select the default OD roughing tool: **T0101 R0.8 OD ROUGH RIGHT - 80 DEG.**

This is the same tool you used to face the part (page 28).



TIP: A green check next to the tool indicates that it is used in another operation.

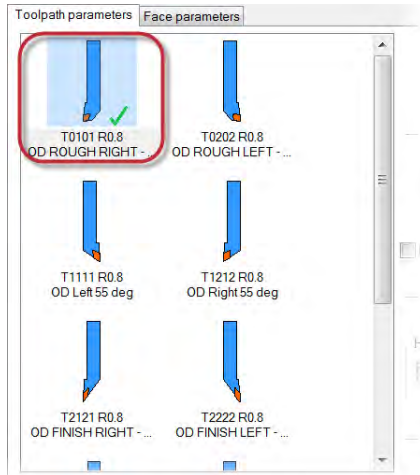

- 2 Type **OD - Rough** in the Comment field.

Comments help identify the operation in the Toolpaths Manager. They can be output to the NC file when you post.

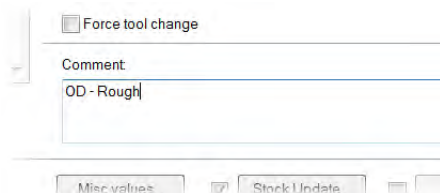

NOTE: Use of comments are optional. In this tutorial, not all operations will have comments.

- 3 Keep all other parameters on this page at their default values.

Enter the cutting values

- 1 Click the **Rough parameters** tab.

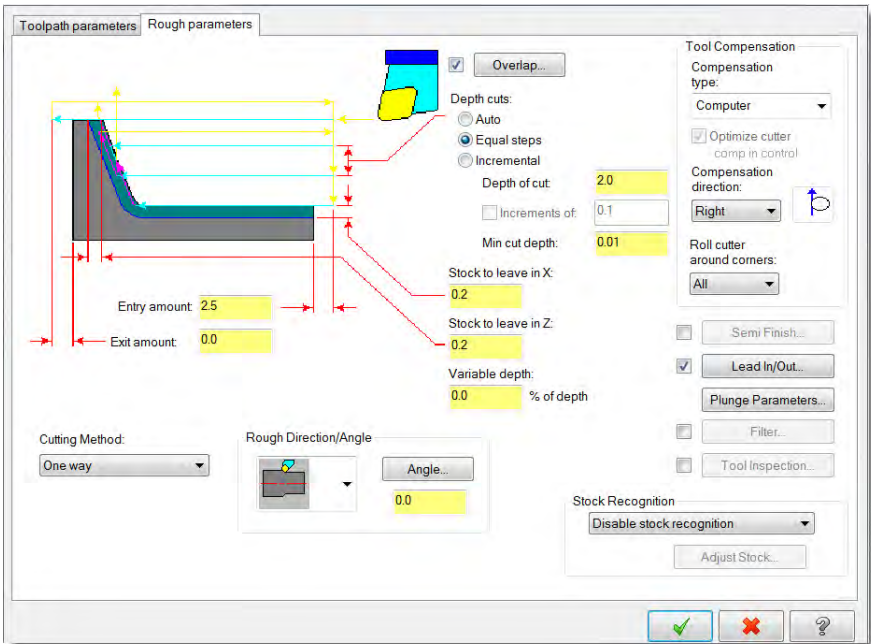

- 2 Increase the Stock to leave in X to **0.5**.

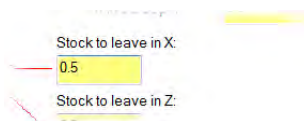

- 3 Select **Use stock for outer boundary** from the Stock Recognition drop-down.

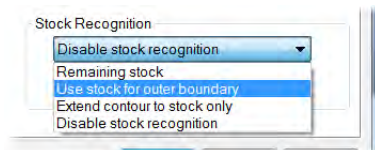

Stock recognition lets you adjust how the stock is removed by the roughing operation. When you select **Use stock for outer boundary**, the operation uses more passes to remove material and avoids excessive cut depths.

- 4 Click the **Lead In/Out** button.

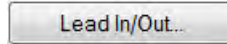

The Lead In/Out dialog box opens.

The parameters in this dialog box control how the tool approaches and/or retracts from the part for each pass in the toolpath. This eliminates the need to create extra geometry for this purpose.

- a Click the **Lead out** tab.

The Lead in and Lead out tabs have identical options for creating entry and exit moves. This allows you to set different values for each move and to combine different types of moves.

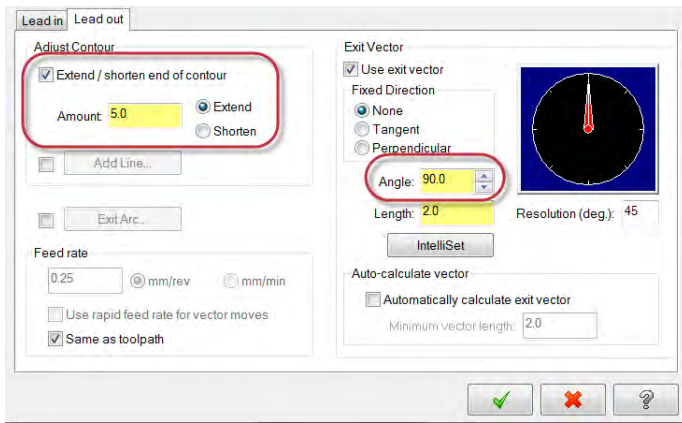

- b Select **Extend/shorten end of contour**.

- c Extend the distance of the chained contour by **5.0** mm.

Extending the distance of the part's contour will stabilize it during the cutoff operation.

- d Enter **90** in the Angle field.

This is the angle the tool follows as it retracts from the part.

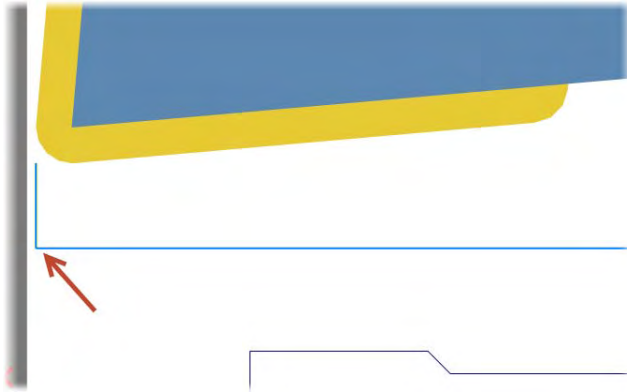

TIP: Set the angle of the entry or exit vector by dragging the pointer to the desired orientation. Mastercam automatically enters the new angle in the Angle field.



- e Click **OK** to return to the Lathe Rough dialog box.
- 5 Keep all other parameters on this page at their default values.
- 6 Click **OK** to create the toolpath.



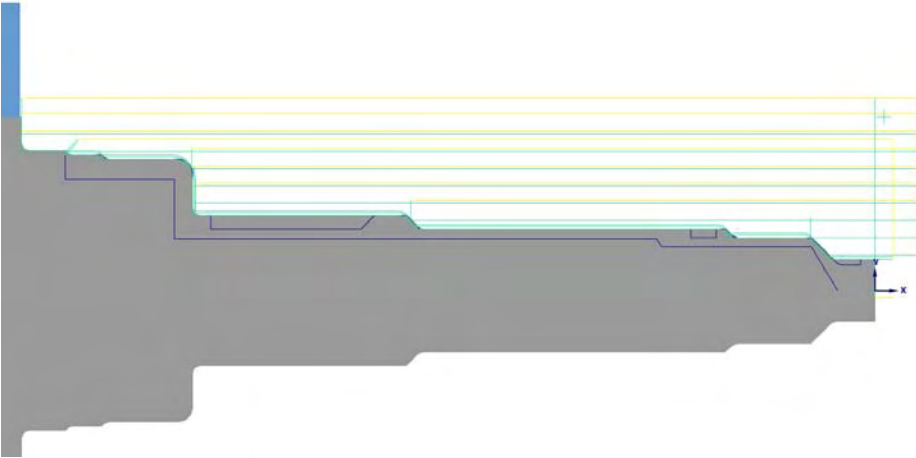

- 7 Save the part.

Exercise 3: Finishing

Use finish toolpaths to have the tool follow the contour of chained geometry. Typically, a finish toolpath follows a roughing toolpath.

- 1 Choose **Finish** from the Lathe Turning tab.

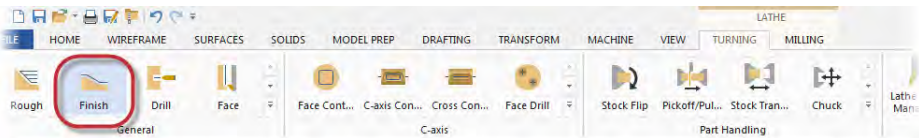

The Chaining dialog box displays, and you are prompted to select a point or chain a contour.

- 2 Select the geometry to be used in the toolpath.

Select the same geometry that you selected for the rough toolpath. (See "Chain the geometry" on page 30.)

- 3 Click **OK** in the Chaining dialog box to accept the chain.



The Lathe Finish dialog box opens.

▶ Enter the toolpath parameters

Entering the toolpath parameters for any finish toolpath uses the same workflow as other lathe toolpaths: first you select the tool and tool options, and then you enter the cutting values.

- 1 Select the finishing tool:
T2121 R0.8 OD FINISH RIGHT - 35 DEG.

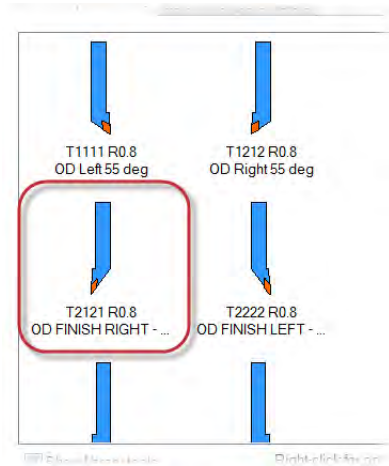

- 2 Decrease the feed rate to **0.2**.

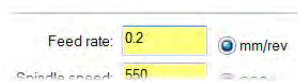

- 3 Keep all other parameters on this page at their default values.

4 Click the **Finish** parameters tab.

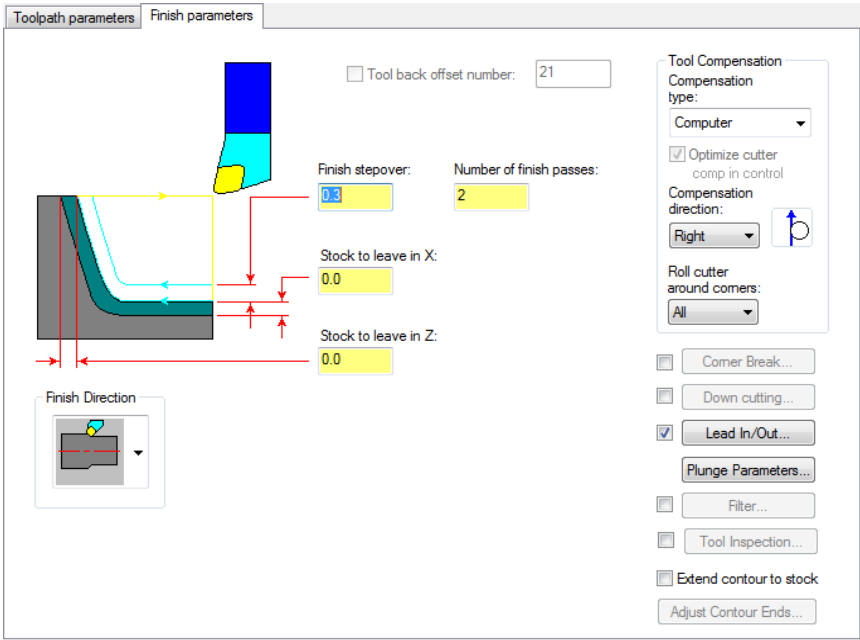

5 Change the Finish stepover to **0.3** and the Number of finish passes to **2**.

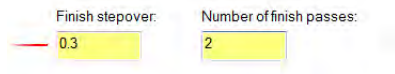

The operation makes two, finer finish passes and avoids excessive cut depths.

6 Leave all other parameters on this page at their default values.

7 Click **OK**.



Mastercam creates a finish operation on top of the previous roughing operation.

8 Save the part.

Exercise 4: Backplotting the Toolpaths

Backplotting shows the path the tools take to cut your part and lets you spot errors in the program before you send it to the machine. In this exercise, you use Backplot to check the work that you have done.

- 1 Click the **Select all operations** button in the Toolpaths Manager to select the Face, Rough, and Finish toolpaths that you created.



- 2 Click the **Backplot selected operations** button.



Mastercam Simulator opens in a separate window.

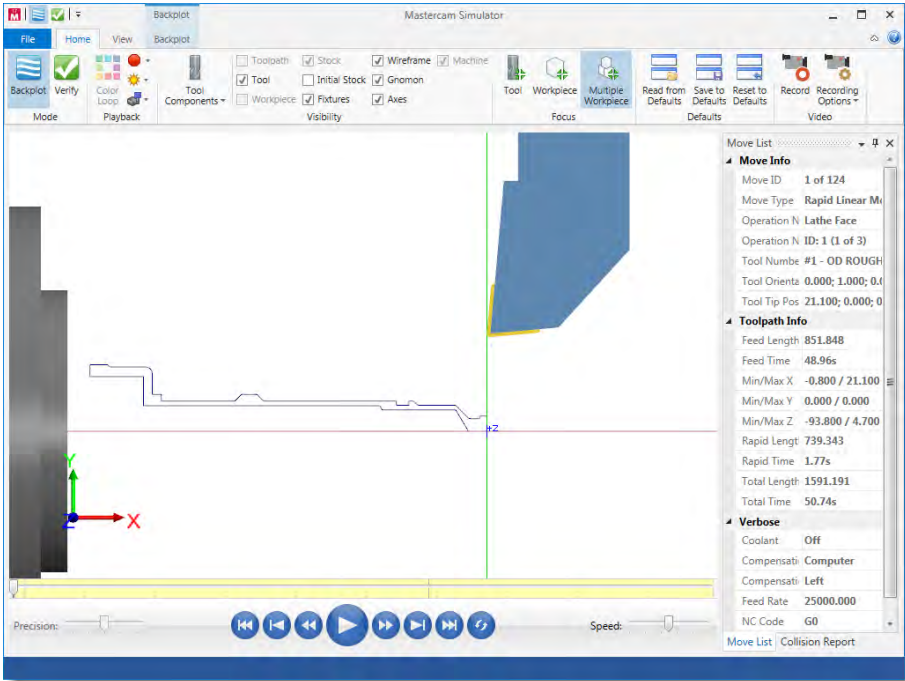

- 3 Select the **Initial Stock** option in the ribbon bar's Visibility group to see the stock before machining.

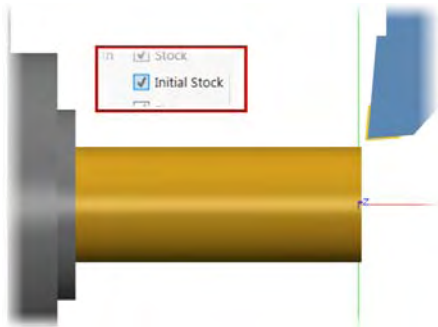

- 4 Select the **Initial Stock** option again to view the part profile against a translucent display of the initial stock.



TIP: Click to cycle through to view the visibility options in three states: on, translucent, and off.

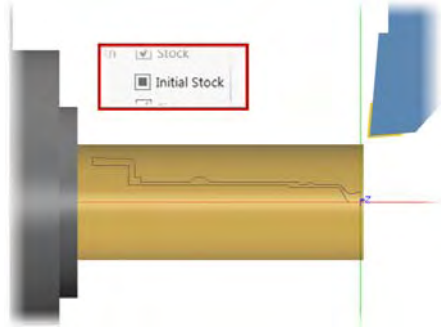

- 5 For a better view of the operations in the Mastercam Simulator, use the **Page Up** key to zoom into the part and **[Ctrl + Arrows]** to pan the view.

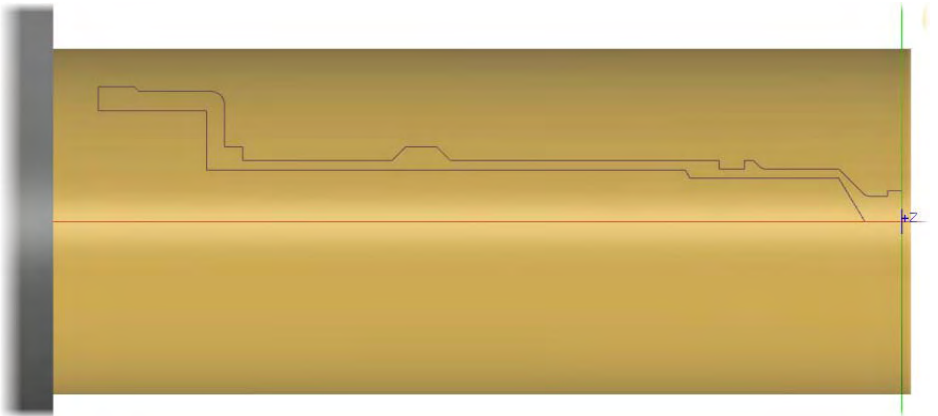

By default, the views in Mastercam and Mastercam Simulator are synchronized. Turn this option on or off from the View tab of Mastercam Simulator.

- 6 Click the **Play** button at the bottom of the Simulator screen.



Simulator backplots all three toolpaths with information about the current toolpath motion displayed in the Move List on the right-side of the screen.

- 7 To pause the simulator at the end of each operation, select **Operation Change** from the Stop Conditions drop-down.



- 8 Use the Play [R], Step Forward [S], and Step Backward [B] keys to view the operations again at your own pace.



TIP: There are several shortcut keys in Mastercam Simulator that can make your workflow more efficient. See Help for a complete list.

- 9 Minimize the Mastercam Simulator, or move it to another monitor.
 - You can dock the Mastercam Simulator on a second monitor, and refresh your toolpaths as you make changes.
 - When you close the Mastercam Simulator window, the current layout is saved and used at the application's startup.

The face, rough, and finish operations reveal the basic shape of the outer diameter of the hose nozzle. In the next lesson, you further refine the outer diameter with grooves and threads. You also check your work against Mastercam Simulator's Verify option.

LESSON 3

Adding Grooves and Threads

Grooves and threads are common features on a lathe part. A groove is an indented or recessed area in a workpiece. They can be very difficult to machine with a roughing toolpath or a roughing tool. A thread is the helical ridge of a screw. Both groove and thread toolpaths require that you define the shape and orientation of the operation as well as their cutting values. In this lesson, you create groove and thread toolpaths on the outer diameter of the part. You also see how you can employ plunge parameters to efficiently remove material in a finish operation. To analyze the viability of these operations, you use advanced verification features in the Mastercam Simulator.

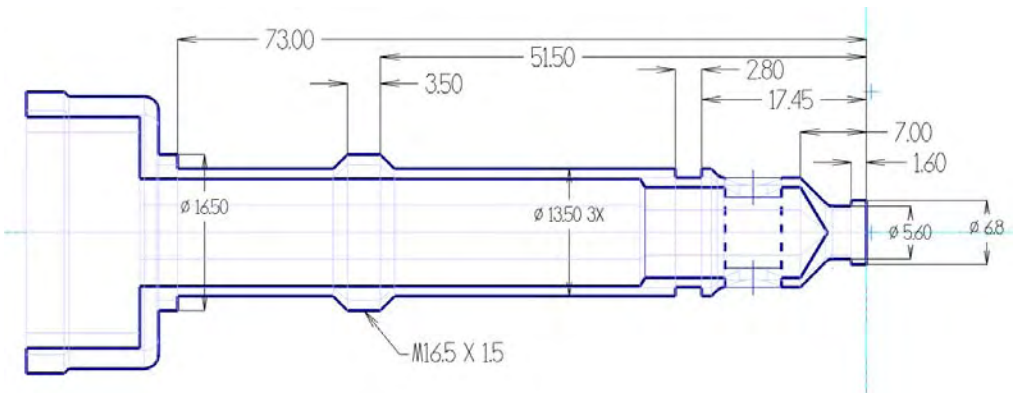

Lesson Goals

- Create groove operations on a single chain and on non-adjacent geometry.
- Use plunge cuts in a finish operation to efficiently remove material.
- Manually enter thread parameters to create a thread on the outer diameter.
- Use Verify and its functions to check your work.

Exercise 1: Grooving on the Outer Diameter: Multiple Chains

Groove toolpaths are useful for machining indented or recessed areas that are not otherwise machinable by roughing toolpaths or tools. You can machine several grooves in a single operation, even if their geometry never connects. In this exercise, you create one groove operation from two distinct chains.

- 1 Expand the General gallery, and select **Groove** from the Lathe Turning tab.

The Grooving Options dialog box opens.

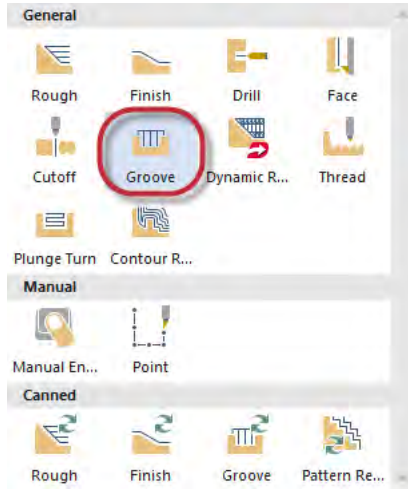

- 2 Select the **Multiple chains** option.



- 3 Click **OK**.



The Chaining dialog box displays and you are prompted to select an entry point.

- 4 Chain two of the three grooves by selecting the first and last entities of each chain as shown in the illustration.

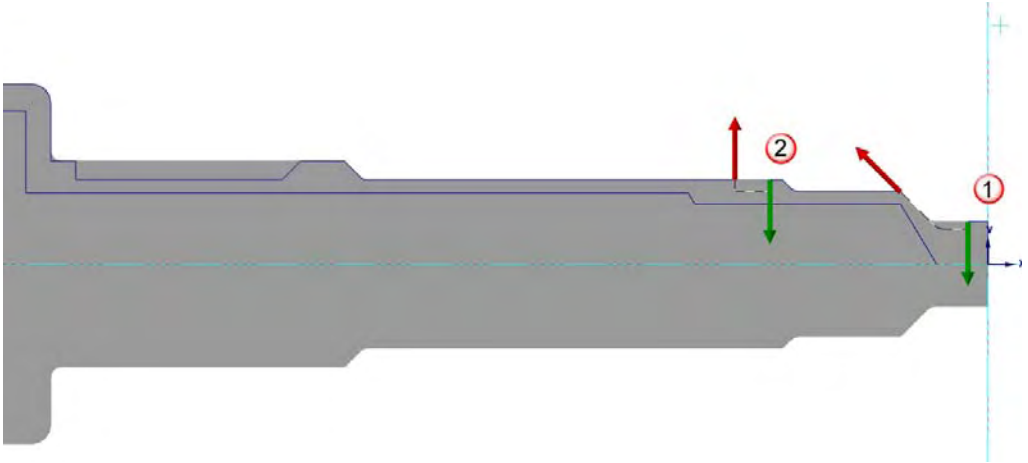

TIPS:

- Right-click in the graphics window, and use **Zoom Window** to more easily select the groove geometry.
- The shortcut [**Alt + T**] toggles the tool-path geometry display.

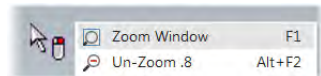

- 5 Click **OK** in the Chaining dialog box to accept the chains.

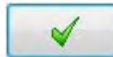

The Lathe Groove (Chain) dialog box opens.

- 6 From the Toolpath parameters tab, select the grooving tool: **T4141 R0.1 W1.85 OD GROOVE CENTER - NARROW.**

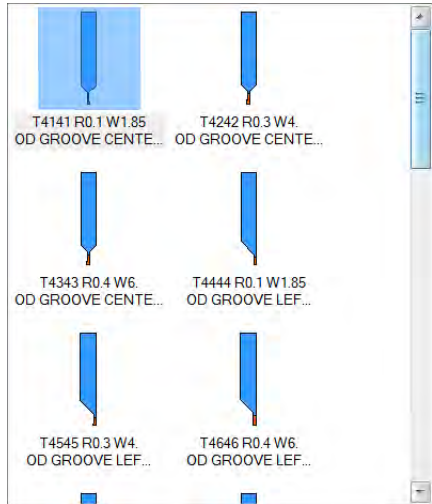

- 7 Keep all other parameters on this page at their default values.
- 8 Click the **Groove shape parameters** tab, and make sure that all values are as shown.

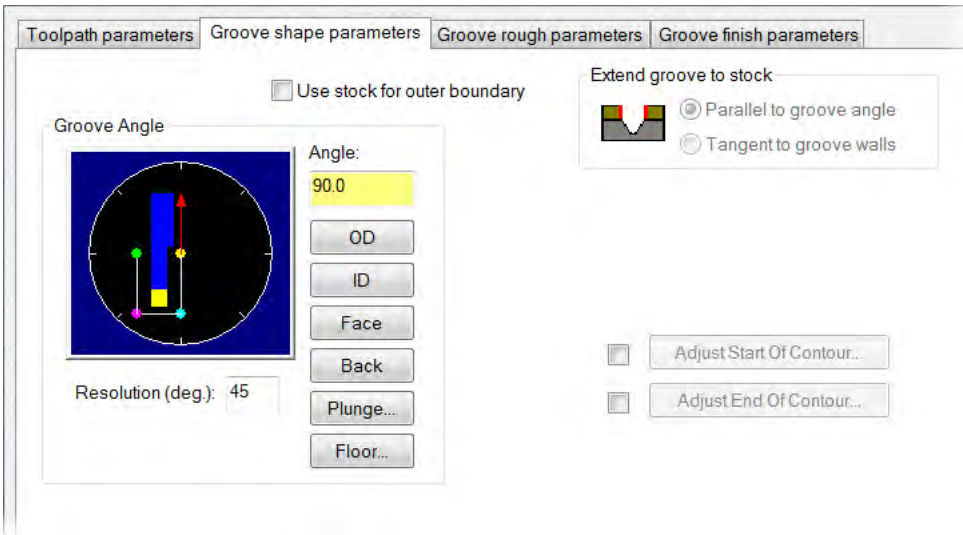



NOTE: The **Use stock for outer boundary** option can remain unchecked since the roughing operation already removed any stock past the end of the chained geometry.

- Click the **Groove rough parameters** tab, and make sure that all values are as shown.

The screenshot displays the **Groove rough parameters** tab of a software interface. The interface is divided into several sections:

- Checkboxes:** Rough, Finish each groove before roughing next.
- Cut Direction:** A dropdown menu set to **Bi-Directional**.
- Stock clearance:** A text input field containing **2.0**.
- Stock amount:** A text input field containing **0.0**.
- Rough step:** A dropdown menu set to **Percent of tool width**, with a text input field containing **75.0**.
- Backoff %:** A text input field containing **10.0**.
- Stock to leave in X:** A text input field containing **0.2**.
- Stock to leave in Z:** A text input field containing **0.2**.
- Face Groove:**
 - Maximum start diameter: **5000.0**
 - Minimum start diameter: **0.0**
- Retraction Moves:**
 - Rapid
 - Feed rate: **0.01** (mm/rev or mm/min)
- First Plunge Feed Rate:**
 - Plunge: **0.05** (mm/rev or mm/min)
 - Retract: **0.2** (mm/rev or mm/min)
- Dwell Time:**
 - None
 - Seconds: **1.0**
 - Revolutions
- Groove Walls:**
 - Steps
 - Smooth
- Buttons:** Peck Groove..., Depth Cuts..., Filter..., Tool Inspection...
- Bottom Bar:** (Green checkmark), (Red X), (Question mark)

- Click the **Groove finish parameters** tab, and make sure that all values are as shown.

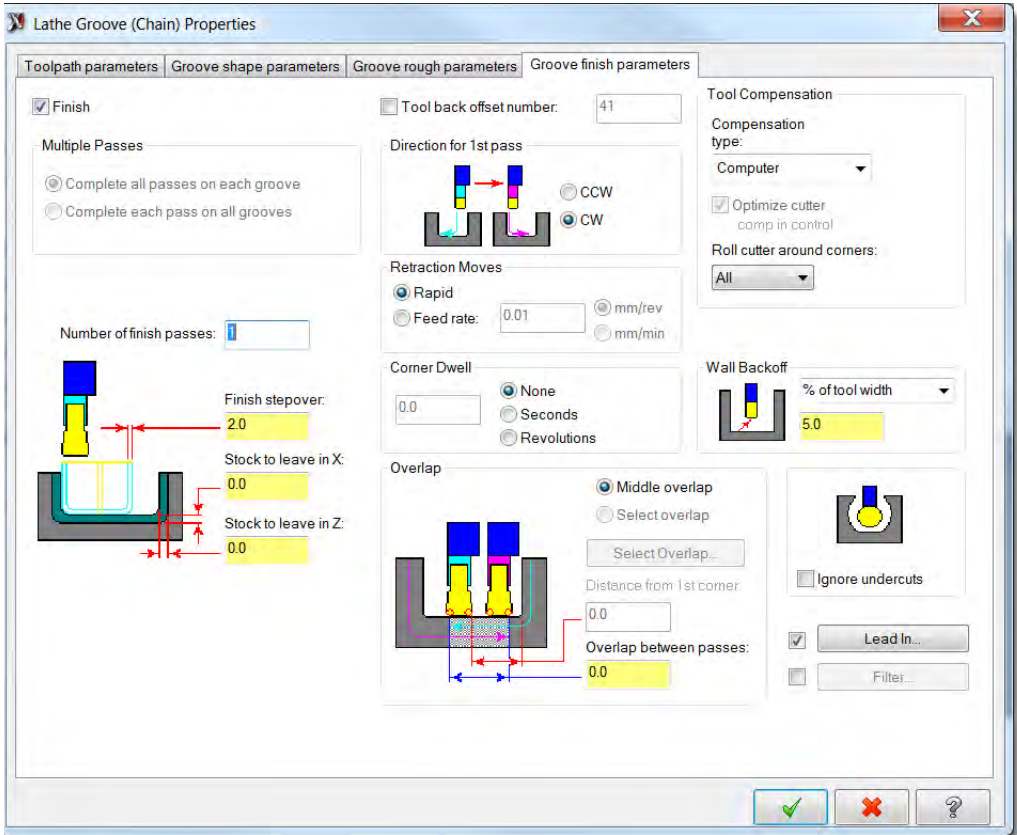

- Click **OK** to create the toolpath.



Click **Only display selected toolpaths** to view the toolpath geometry.



Exercise 2: Grooving on the Outer Diameter: Rough Pass Only

In this exercise, you restrict a second groove toolpath to machine just a rough pass on a single, recessed area.

- 1 Select **Groove** from the Lathe Turning tab.
- 2 Select the **Chain** option from the Grooving Options dialog box.

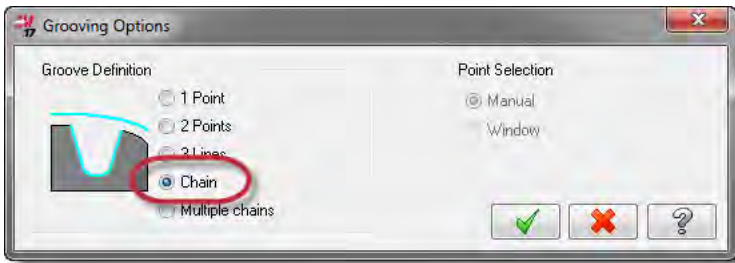

- 3 Click **OK**.

The Chaining dialog box displays and you are prompted to select an entry point.

- Chain the third groove by selecting the first and last entity of the chain as shown in the illustration, and click **OK**.

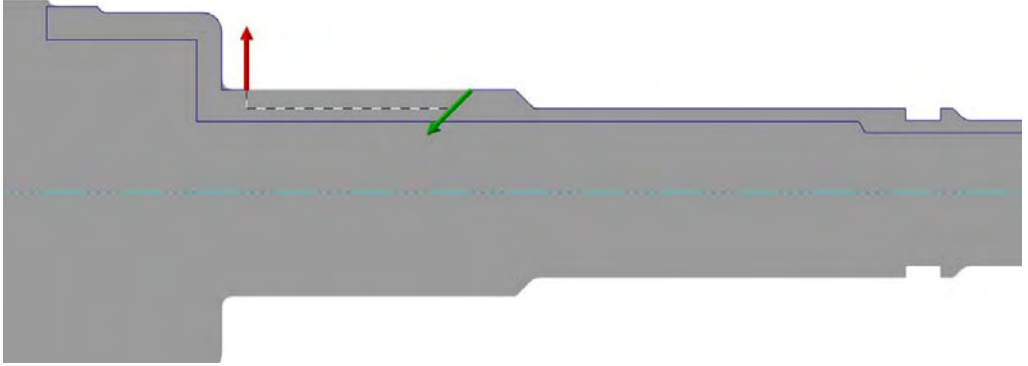

The Lathe Groove (Chain) dialog box opens.

- Keep **T4141 R0.1 W1.85 OD GROOVE CENTER - NARROW** selected.

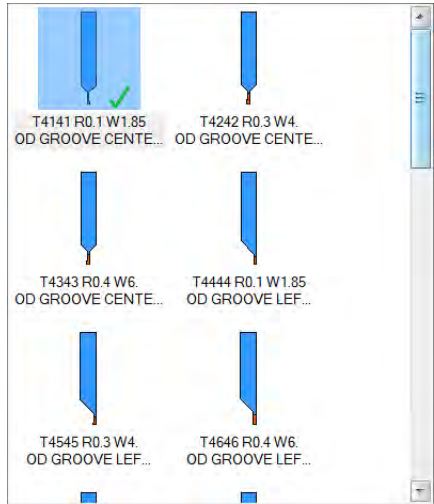

- 6 Open the **Groove finish parameters** page, and clear the **Finish** option.

In the next exercise, you use a standard finish operation to remove remaining stock from this groove.

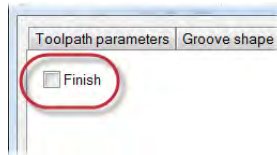

- 7 Click **OK** to create the toolpath.

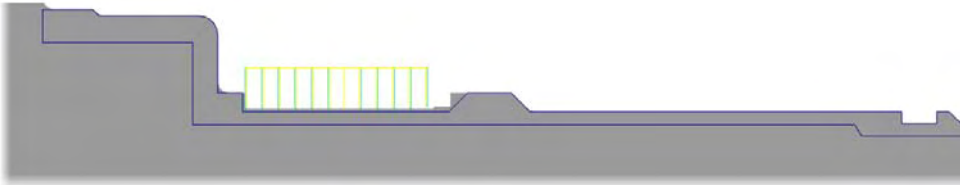

Exercise 3: Finishing with Plunge Cuts

In this exercise, you finish the groove you created. To more efficiently remove the material, you activate plunging in both directions.

- 1 Expand the General gallery and select **Finish**.

The Chaining dialog box displays, and you are prompted to select a point or chain a contour.

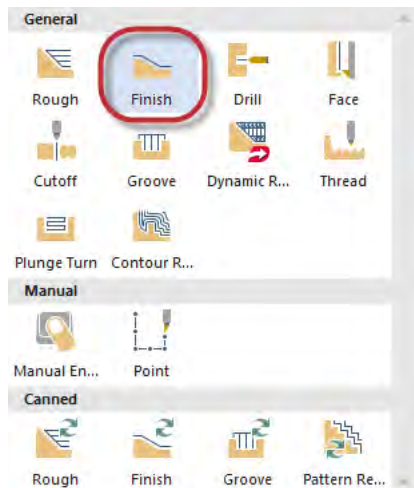

- 2 Select the **Last** button to reselect the geometry chained for the previous grooving operation.



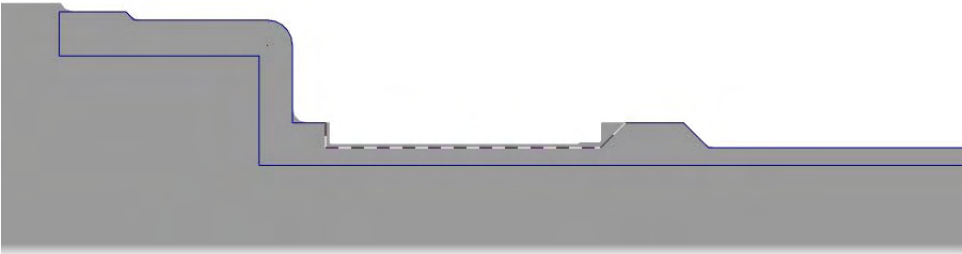

- 3 Click **OK** in the Chaining dialog box to accept the chain.



The Lathe Finish dialog box opens with the finish tool used in Operation 3 already selected.

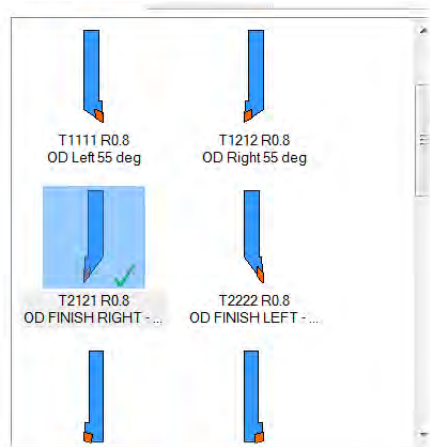

- 4 Type **OD - Finish with Plunge** in the Comment field.

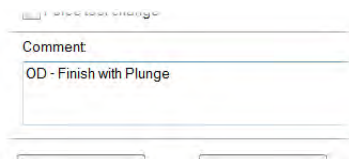

5 Open the **Finish parameters** page.

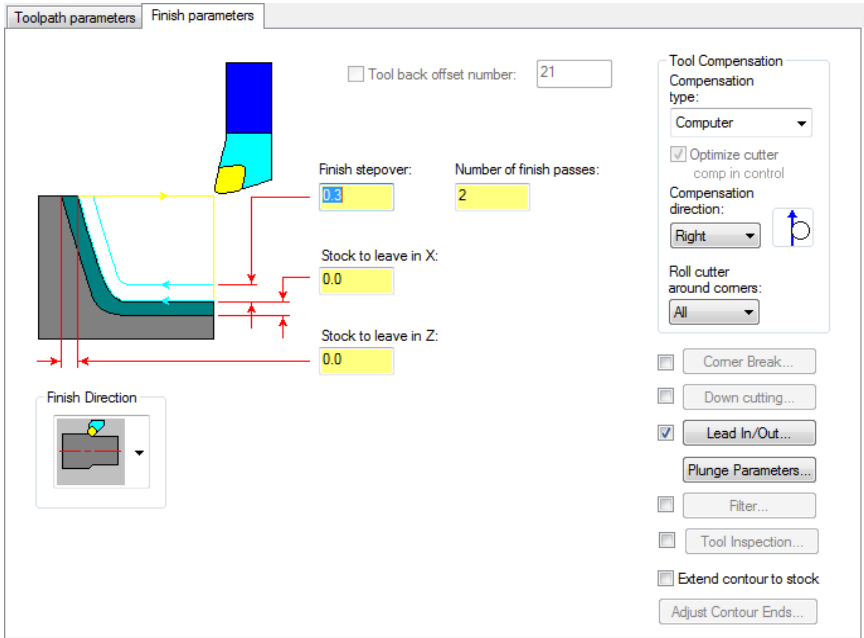

You do not need to edit any fields on this page.

6 Click the **Lead In/Out** button.

Lead In/Out...

The Lead In/Out dialog box opens.

- a Enter **-135** in the Angle field, or drag the angle dial to define the entry vector.

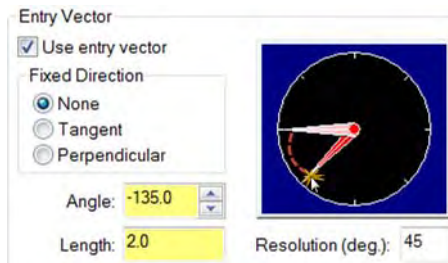

The tool will follow this angle as it enters the cut.

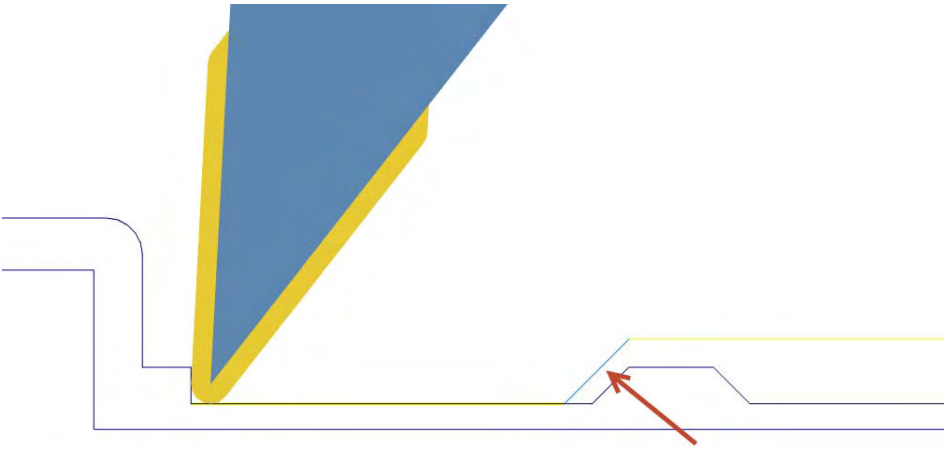

b Click **OK** to return to the Lathe Finish dialog box.

7 Click the **Plunge Parameters** button.



The Plunge Cut Parameters dialog box opens. Use this dialog box to define how you want the tool to handle plunges along the toolpath. You can choose to plunge in either or both axes.

- a** Select the option to allow plunging in both directions.
 - The tool plunges into all sections on the chained path.
 - Choosing to plunge in both directions activates the Front and Back clearance angle fields.
- b** Keep the default values for both clearance angle fields.

Clearance angles control how the tool plunges and give additional clearance at the undercut wall.

- The front clearance angle prevents the tool front from cutting with the entire length of the insert's front as the tool cuts up to the wall.

- The back clearance angle prevents the tool back from cutting with the entire length of the insert's back as the tool plunges to the next cut depth.

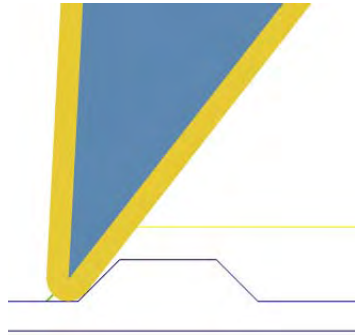

- c Click **OK** to return to the Lathe Finish dialog box.

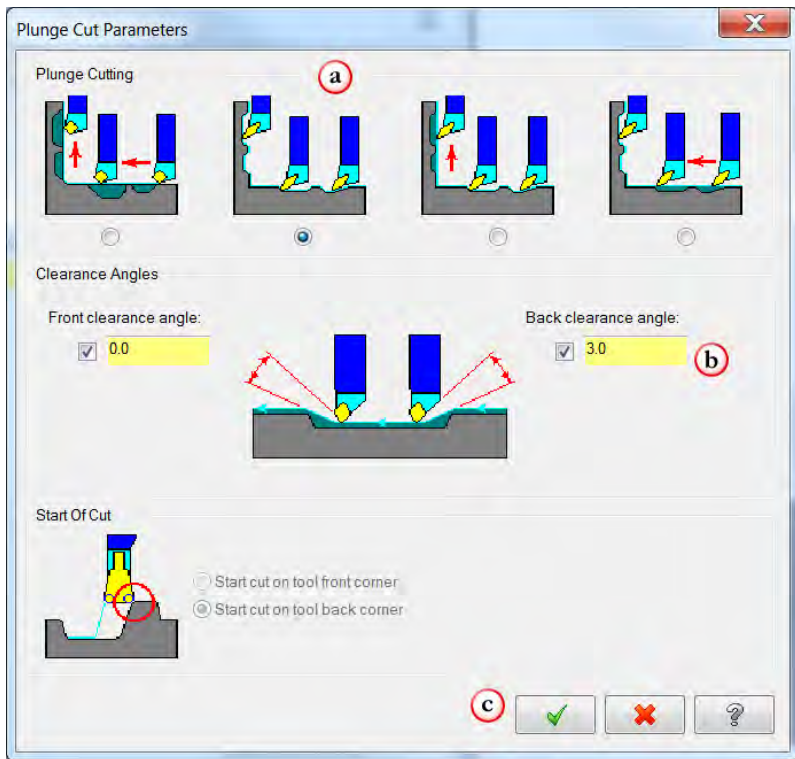

8 Click **OK** to create the toolpath.



9 Save the part.

10 (Optional) Backplot the groove and finish toolpaths that you have created in this lesson.



Exercise 4: Adding a Thread Toolpath

A threading toolpath is typically the last toolpath performed on a lathe part because of the need for accuracy. A threaded part has to fit precisely into another part. You can program threads on the OD or ID to secure parts to each other.

With Mastercam, you can directly enter toolpath parameters or select geometry to create a thread toolpath.

In this exercise, you use part geometry to create an OD thread toolpath.

- 1 Expand the General gallery, and choose **Thread**.

The Lathe Thread dialog box opens.

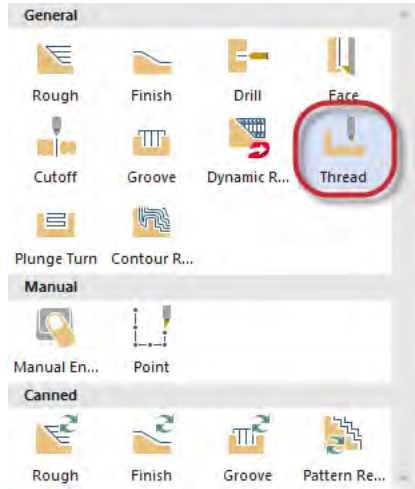

► **Select the tool**

- 1 From the Toolpath parameters tab, select the thread tool: **T9191 OD THREAD LEFT - SMALL**.

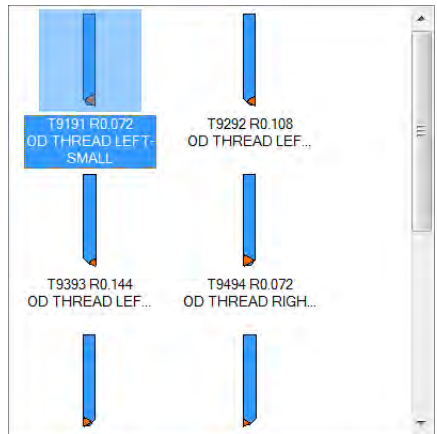

- 2 Enter **400** into the Spindle speed field, and select the **mm/rev** option for the Feed rate.

The feed and speed rates you enter here overwrite the default settings for this operation.



3 Change the tool's Home Position.

The home position is where the spindle typically travels for tool changes. Mastercam lets you control the home position from several different sources.

In this case, the operation defaults to using the D (250) and Z (250) coordinates defined in the machine definition. The following procedure shows you how to override the default home position.

- a Choose **User defined** from the drop-down menu.

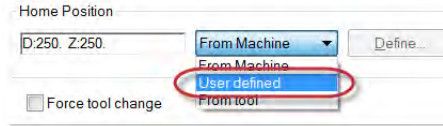

- b Click the **Define** button.

The Home Position - User Defined dialog box displays.



- c Change the D coordinate to **0**.
- d Click **OK** to return to the Lathe Thread dialog box.

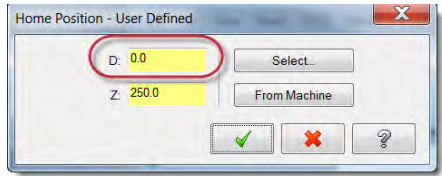

4 Keep all other parameters on this page at their default values.

▶ Enter thread shape parameters

The values you enter into this tab determine the following:

- Thread shape
- Cut location
- Amount of variation

- 1 Click the **Thread shape parameters** tab.

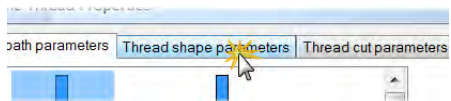

- 2 In the Lead field, enter **1.5** mm.

The blueprint on page 43 shows the lead value.

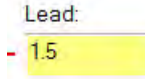

- 3 Click the **Major Diameter** button.

You are prompted to select a point in the graphics window.



- 4 Click the thread's largest diameter.

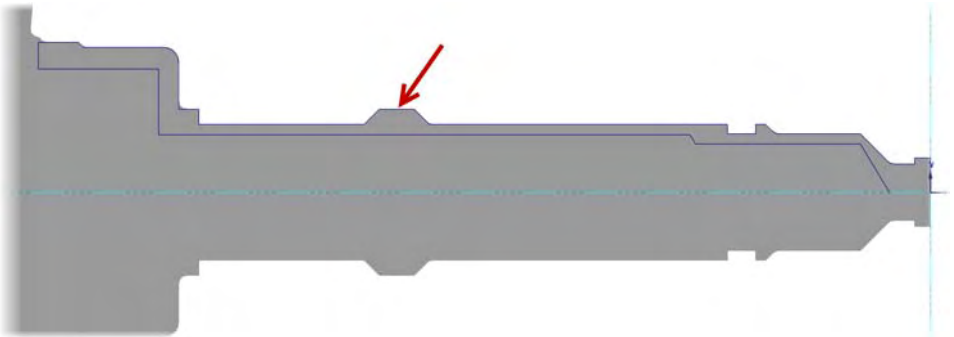

- 5 Click the **Minor Diameter** button.

You are prompted to select a point in the graphics window.

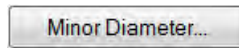

- 6 Click the thread's smallest diameter.

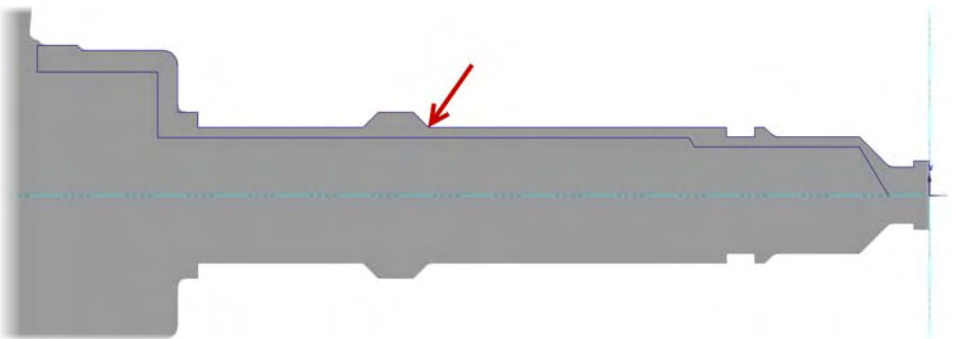

- 7 Make sure that your major and minor values are as shown.

Mastercam automatically calculates the **Thread depth** from the major and minor diameter values.

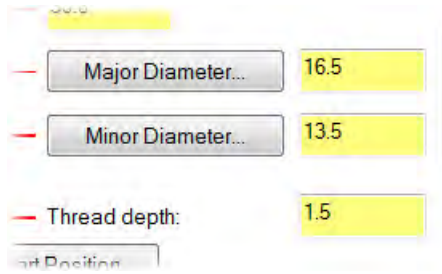

- 8 Click the **Start Position** button and select the beginning of the thread from graphics window. **OK** your selection.
- 9 Click the **End Position** button and select the end of the thread from graphics window. **OK** your selection.

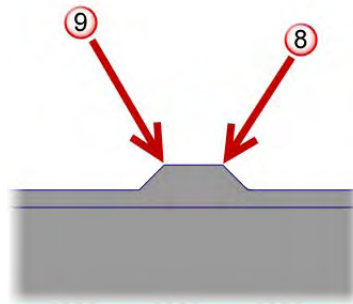

The fields on the tab show the location of the start and end of the thread on the Z axis.



- 10 Confirm that the Thread orientation is **OD**.

Thread orientation determines whether the thread is created on the inner or outer diameter of the part.

- 11 Click the **Draw Thread** button to preview the thread geometry in the graphics window.

Mastercam creates an outline of the thread.

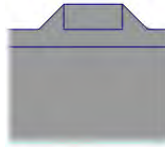

12 Choose **Yes** to save it with your part.

▶ Enter thread cut parameters

The values entered in this tab define how Mastercam will cut the material.

- 1 Click the **Thread cut parameters** tab.

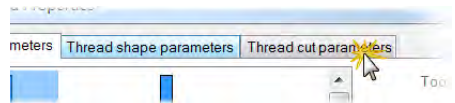

- 2 Select the **Compute** option on the right side of the dialog box.

Mastercam automatically calculates the required acceleration clearance from the lead and main spindle speed.

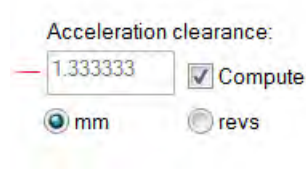

3 Keep all other parameters on this page at their default values.

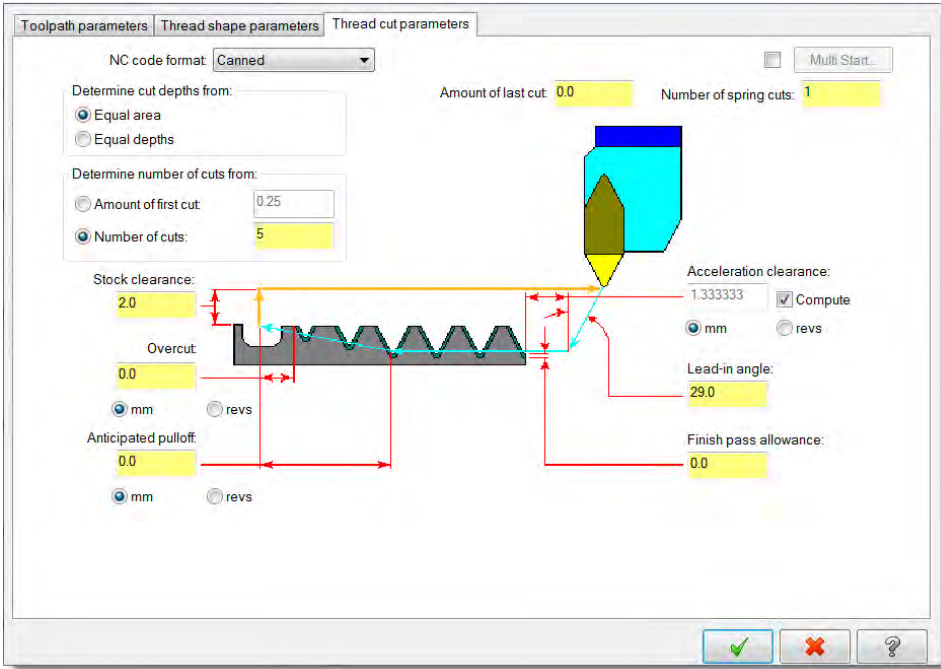

4 Click **OK** to create the toolpath.



5 Save the file.

Exercise 5: Verifying the Toolpaths

Verifying your toolpaths allows you to use solid models to simulate part machining against a selected stock definition. The result Verify creates represents the surface finish, and shows collisions, if any exist. You can identify and correct program errors before they reach the shop floor.

In this exercise, you use some of Verify's features to check the thread operation you created in this lesson.

- 1 Make sure that the Thread operation is selected in the Toolpaths Manager.

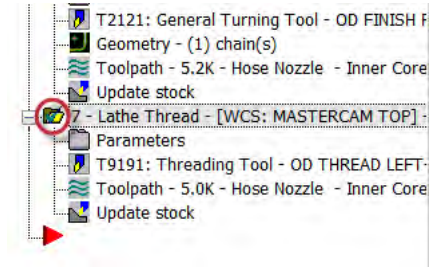

- 2 Click the **Verify selected operations** button.

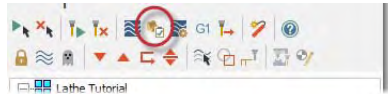

Verify displays in the Mastercam Simulator window.

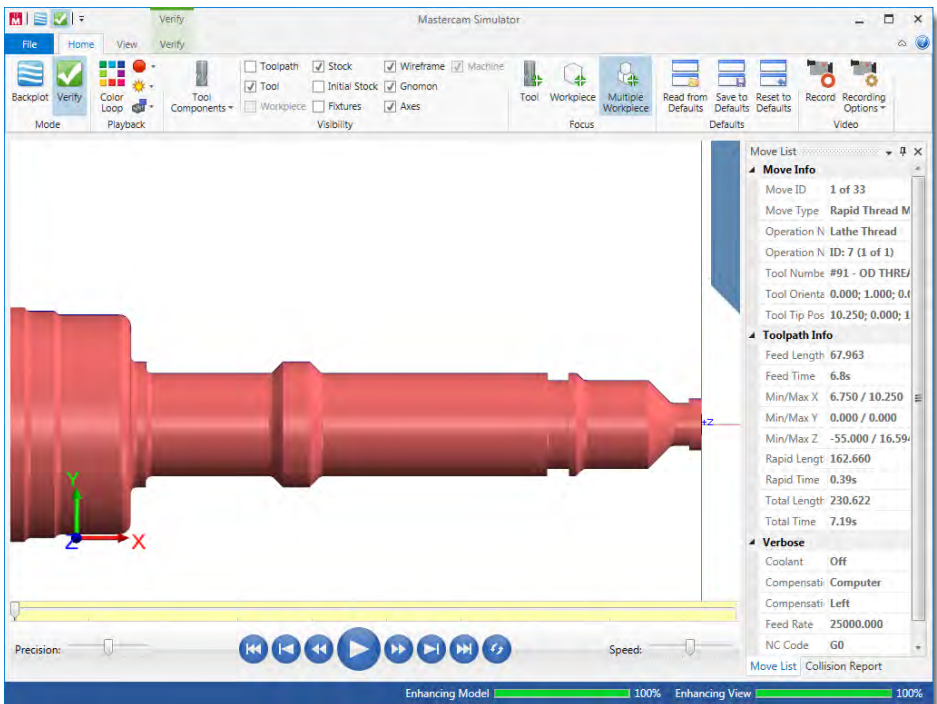

- 3 Right-click in the graphics window and change the view to **Isometric**. Pan and zoom into the area that will be threaded.

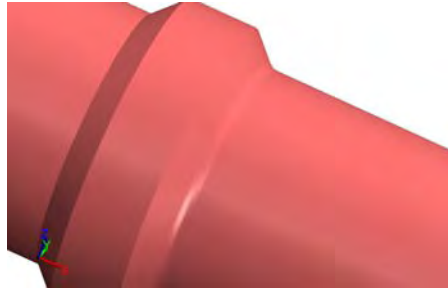

NOTE: The illustrations here show the part displayed with Initial Stock turned off.

- 4 Click the **Play** button or press [R] to verify the toolpath. Mastercam Simulator verifies the toolpath.

- 5 Select the **Verify** tab.



- 6 Click **Accurate Zoom**.

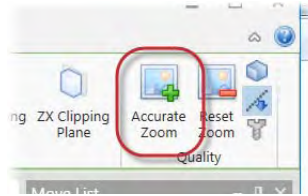

Accurate Zoom smooths surfaces when you view the part in close-up.

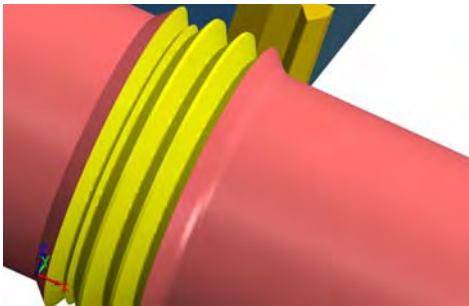

Accurate Zoom Off

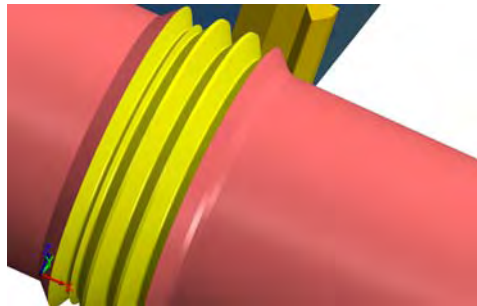

Accurate Zoom On



TIP: Click **Reset Zoom** to restore the original magnification result.

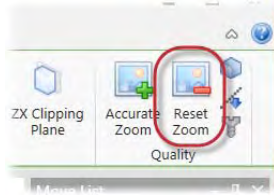

- 7 Click the **True Thread** button, and click **OK** to continue.

True Thread requires that you re-verify the operation.



- 8 Click the **Play** button or press **[R]** to restart verification.

True Thread displays a more realistic threading motion and helical screw threads, instead of concentric circles and grooves.

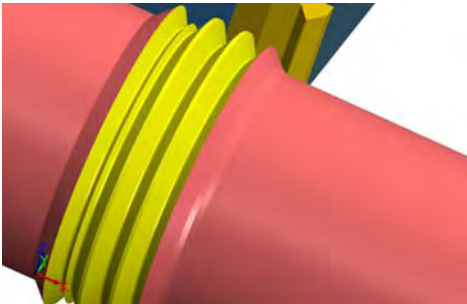

True Thread Off

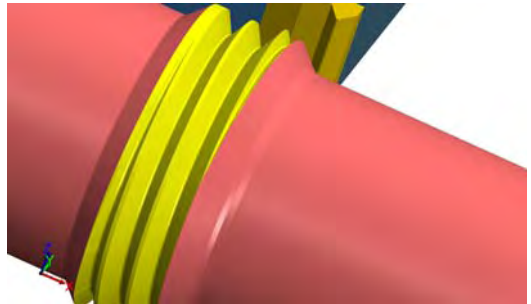

True Thread On

Toggle the **True Thread** button to return to a quicker, but less accurate verification.

- 9 Minimize the Mastercam Simulator, or move it to another monitor.

You have completed machining the outer diameter. In the next lesson, you will create drilling operations using the C-axis.

LESSON 4

C-Axis Drilling Operations

Lathe C-axis toolpaths are included with Mastercam for most common contour and drill applications. When you select one of these toolpaths, Mastercam automatically sets the Tplane and Cplane to the appropriate settings for the desired application. These toolpaths also support Y-axis rotation and axis substitution. To use C-axis toolpaths, the active machine definition must support the appropriate axes. In this lesson, you use two operations to drill a hole through the part on the C-axis.

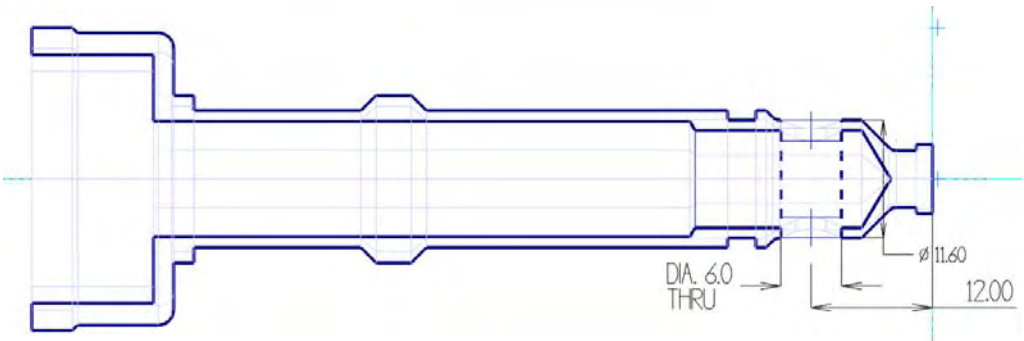

Lesson Goals

- Create 2D geometry from circular holes in the solid body.
- Add a toolpath group.
- Create a C-axis drill operation.
- Copy and modify an existing operation to create a new one.

Exercise 1: Making Drill Geometry

The drill toolpath requires the selection of two-dimensional geometry. Because the method you used to create 2D geometry on page 17 did not create a cross section of the part, the geometry for the drilled hole was not created. In this exercise, you use Mastercam's Hole Axis function to create the necessary geometry from circular holes in the solid body.

- 1 Open the **Levels Manager**, and make **Level 1** visible.

The solid model displays in the graphics window.

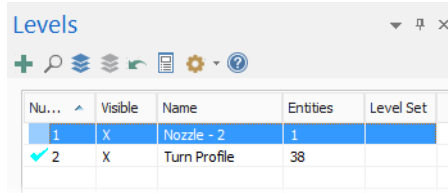

- 2 Create a Level 3. Name this level, **C-Axis Geometry**.

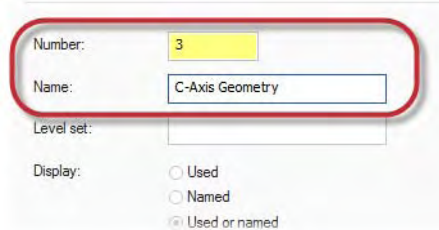

- 3 From the View tab, turn on translucent shading to view the interior of the solid.

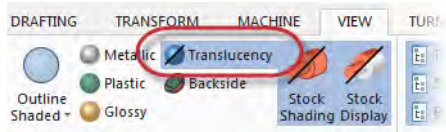

- 4 Use the Isometric Gview and Zoom to more easily see the model's drilled hole.

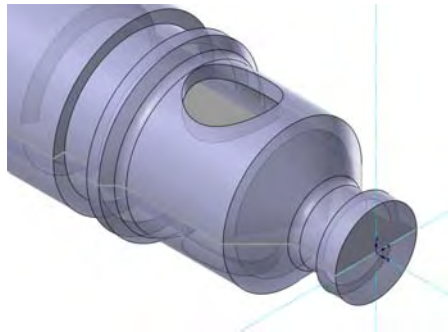

- 5 Create the C-Axis geometry.
 - a Select **Model Prep, Hole Axis**.

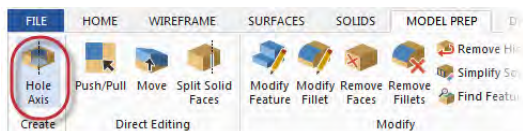

- b** [Ctrl + click] the internal face of the upper hole to select both openings of the through hole.

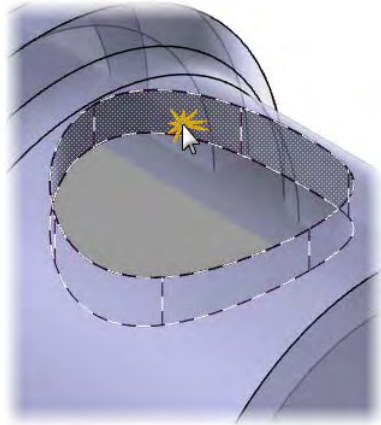

TIP: Use [Ctrl +click] to select faces with matching diameters.

- c** Place points and circles at both the top and bottom of the holes.
- d** Click **OK** to accept your selection.

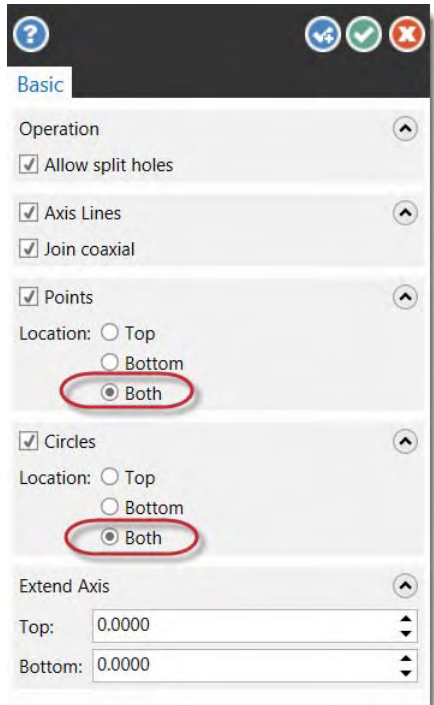

Mastercam creates geometry for both ends of the through hole.

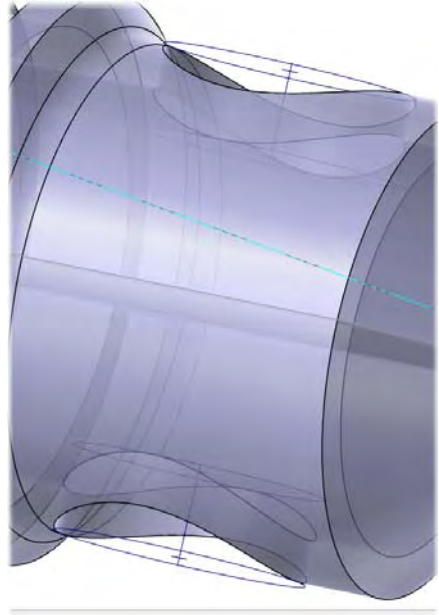

Exercise 2: Adding a New Toolpath Group

Toolpath groups are subgroups that are “children” of machine groups. They inherit machining properties and other important properties from their parent groups. Toolpath groups house toolpath operations as well as other subgroups. They are useful for creating sets of toolpaths on the same machine that you will want to post separately. Mastercam supports unlimited subgroups.

In this exercise you organize your operations into two different toolpath groups: Outer Diameter and C-Axis Drill.

- 1 In the Toolpaths Manager, right-click **Toolpath Group-1**, and select **Groups, Rename** from the pop-up menu.
- 2 Change the name of Toolpath Group-1 to **Outer Diameter**, and press **[Enter]**.

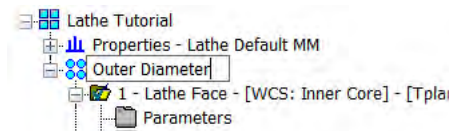

3 Create the C-Axis Drill toolpath group.

- a Right-click the machine group and select **Groups, New Toolpath group** from the menu.

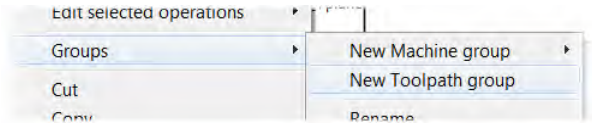

A new toolpath group is created.

- b If necessary, move the insert arrow past the new toolpath group.

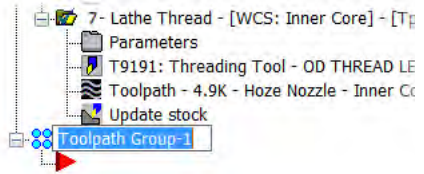

- c Rename the new toolpath group: **C-Axis Drill**, and press [Enter].

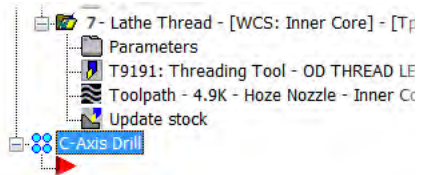

Exercise 3: Creating a C-Axis Drill Operation

In this exercise, you create a center drill operation with a C-axis drill toolpath.

- 1 Expand the C-axis gallery, and select **C-axis Drill** from the Lathe Turning tab.

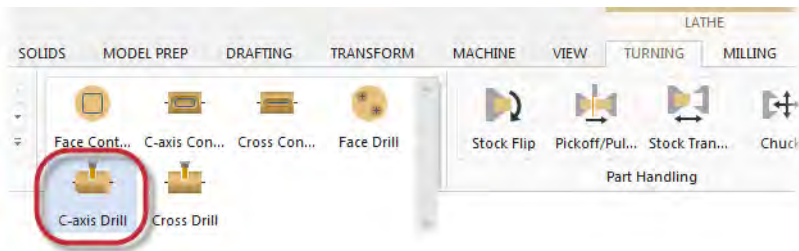

The Drill Point Selection dialog box opens.

- 2 Use the **Manual** button to select the top point or the **Entities** button to select the top arc.

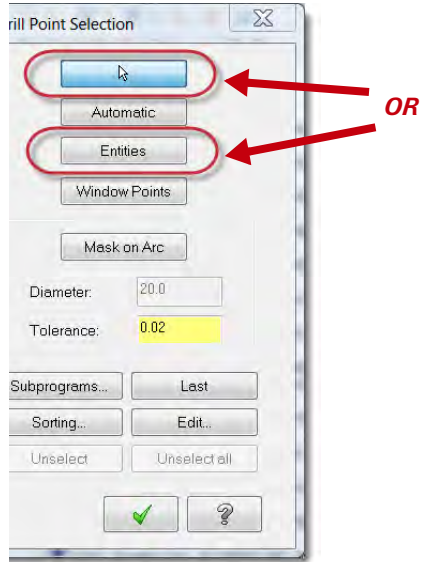

NOTE: The illustration shows the top arc selected. When you select open or closed arcs, the drill points are placed in the center of the arcs.

When finished, confirm your selection.

- Manual selection: press **[ESC]**.
- Entity selection: press **[Enter]**.
- Press the **End Selection** button.

Mastercam confirms that you have one point defined and that point sorting and the duplicate point filter are off.

- 3 Click **OK**.

The C-Axis Toolpath - C-Axis Drill dialog box opens.

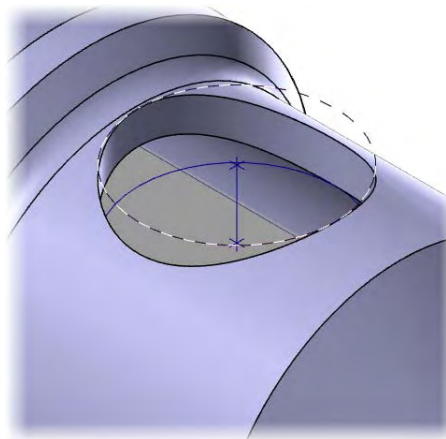

► Enter the Toolpath Parameters

In addition to selecting tools and entering cutting values, the C-axis drill operation requires that you define the rotary axis motion.

Select the tool

- 1 From the Tree View, open the **Tool** page.

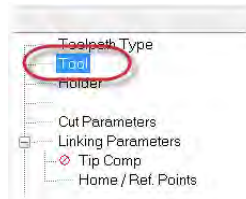

- 2 Click the **Select library tool** button.
The Tool Selection dialog box opens.

Select library tool...

- 3 Choose **5.CENTER DRILL** from the list, and click **OK** to return to the Tool page.

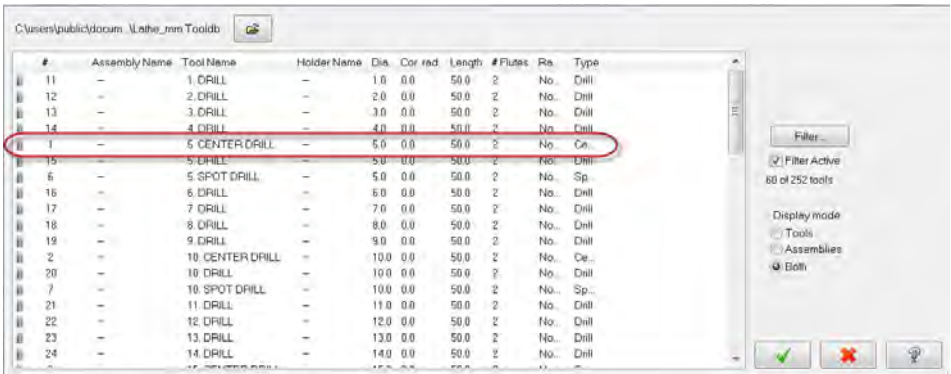

TIP: Use the Tool List Filter to narrow the tools displayed in the list.

Filter...

4 In the Comment window, type **C-axis Drill - Center Drill**.

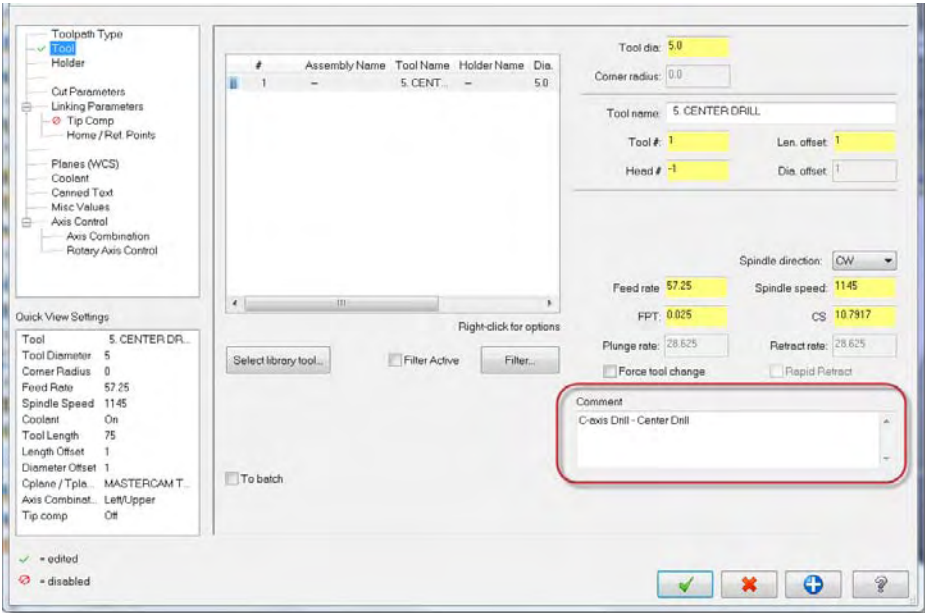

Define Hole Depth

1 Open the **Linking Parameters** page.

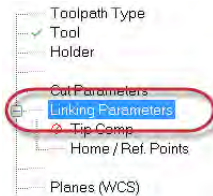

2 Enter an incremental cutting depth of -3.0.

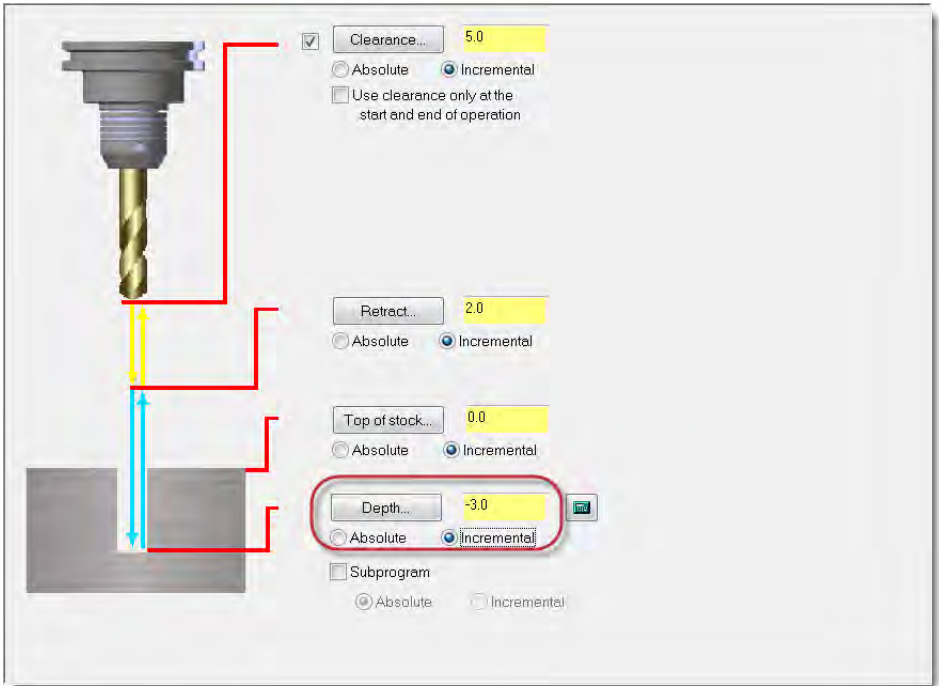

3 Keep all other options on the Linking Parameters page at their default values.

Configure Rotary Axis Motion

C-axis toolpaths automatically set the rotation type to **Axis substitution** around the Z axis. This gives you the choice of chaining either flat geometry which will be rolled around the cylinder, or geometry which is already properly positioned in 3D space.

1 Open the **Rotary Axis Control** page.



The **Axis substitution** option is the only rotation type available for C-axis drill operations.

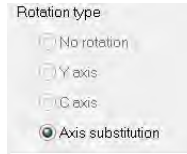

- 2 Set Rotation direction to **CW** (clockwise), and confirm that **Unroll** is selected.

Mastercam unrolls the geometry on to a flat plane in a clockwise direction relative to the selected axis. When you post the toolpath, the geometry wraps back onto the cylinder using the axis substitution and rotary diameter parameters.

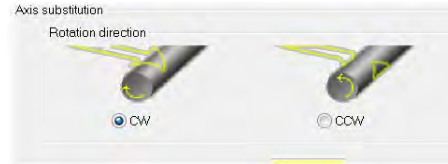

- 3 Enter the **Rotary diameter**. Use the dimension from the blueprint on page 67, or follow the procedure below.

- a Right-click in the **Rotary diameter** field, and select **D = Diameter of an arc**.

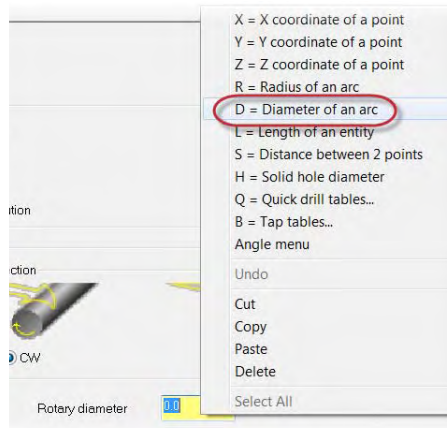

- b** Select the circular edge of the stock.

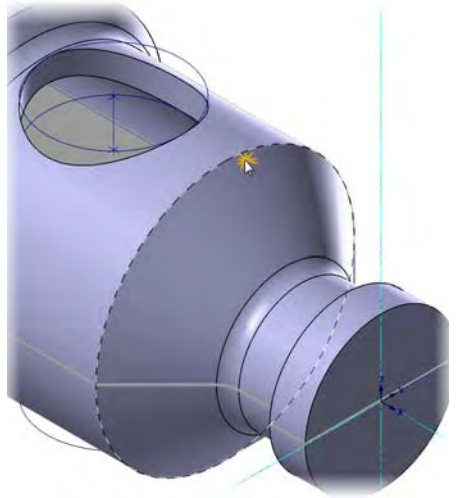

A built-in calculator reads the dimensions of the selected arc directly into the Rotary diameter field.

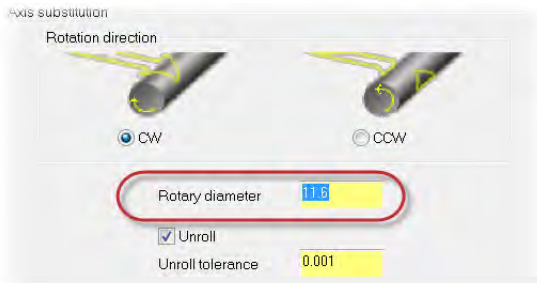

- 4** Click **OK** to create the toolpath.
- 5** Save the part.
- 6** Backplot and/or Verify this toolpath following the procedures you learned in Lessons 2 and 3.

Exercise 4: Copying the Drilling Operation

The final drill operation uses the same geometry and many of the same parameters as the center drill operation you created in Exercise 3. In this exercise, you copy and paste one operation in the Toolpaths Manager in order to quickly create a new one.

- 1 Right-click and drag the drill toolpath you just created to the bottom of the operation list.
- 2 Release the mouse button and choose **Copy after** from the right-click menu.

Mastercam creates a new operation.

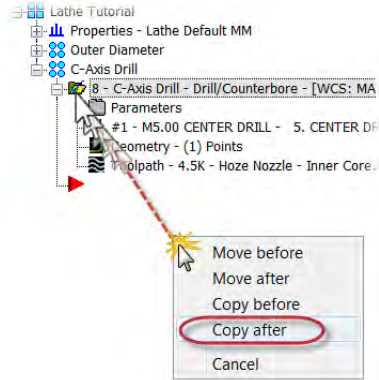

- 3 If necessary, move the insert arrow past the new toolpath.

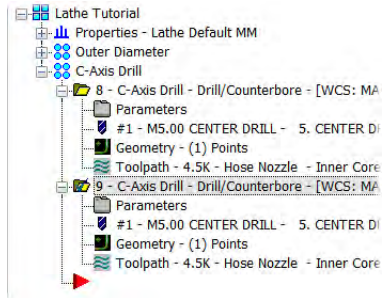

Exercise 5: Modifying the Drilling Parameters

In this exercise, you create the drill through operation by modifying the parameters in the center drill operation that you copied.

- 1 Click new toolpath's **Parameters** folder to open the dialog box.

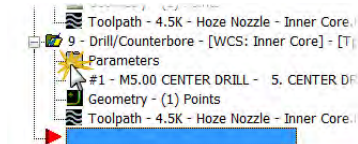

2 Open the **Tool** page.

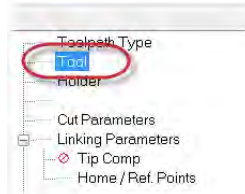

3 Click the **Select library tool** button, and select the 6 mm drill.

4 Type **C-axis Drill** in the Comment field.

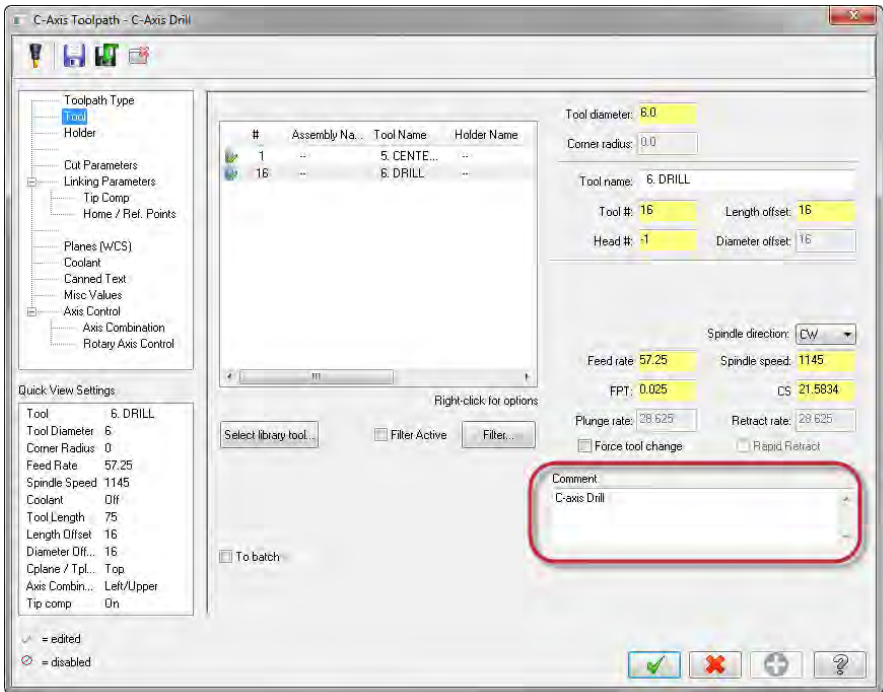

5 Open the **Linking Parameters** page.

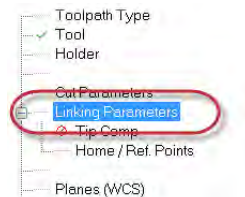

- 6 Using the dimension on page 67, enter the cut depth.



- 7 Open the **Tip Comp** page.

Use this page to configure how the tool drills all the way through the stock.



- a Select the **Tip Comp** checkbox to activate the parameters on the page.

- b Enter a **1.0** mm breakthrough amount.

This insures that the full diameter of the tool breaks through the bottom of the stock.

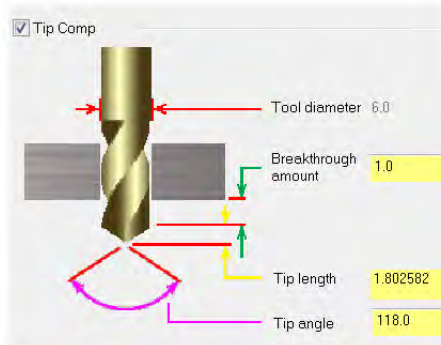

- 8 Click **OK**.

- 9 The new toolpath is marked dirty in the Toolpaths Manager.

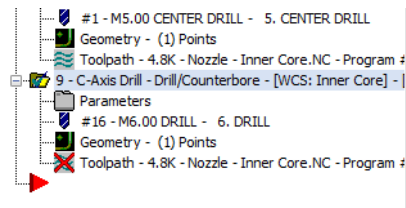

- 10 Regenerate the toolpath, and save your part.



You have completed machining the outer diameter of the hose nozzle. In the next lesson, you prepare for machining the inner diameter with Mastercam's cutoff and stock flip operations.

LESSON 5

Cutoff and Stock Flip

Lathe's part handling operations manipulate the stock and reposition chucks, tail-stocks, and steady rests. Operations can output a comment and a program stop in the NC code to let the operator manually reposition the stock or a peripheral, or they can output code to automatically control peripherals. Mastercam Lathe currently supports the following part handling operations:

- Stock flip (reposition stock on the same spindle)
- Stock transfer (reposition stock to a different spindle)
- Stock advance (program a bar feeder)
- Chuck (clamp/unclamp/reposition)
- Tailstock (advance/retract)
- Steady rest reposition

In this lesson, you prepare for machining the inner diameter with Mastercam's cutoff and stock flip operations.

Lesson Goals

- Create a cutoff operation.
- Program a stock flip.

Exercise 1: Cutting Off the Part

Cutoff toolpaths vertically cut off pieces of the part, such as sections of bar stock. You do not need to chain any geometry for a cutoff toolpath. Instead, you select the point where the part is cut off.

In this exercise, you use the options in the cutoff toolpath to separate the part from the bar stock.

- 1 Expand the General gallery, and select **Cutoff** from the Lathe Turning tab.

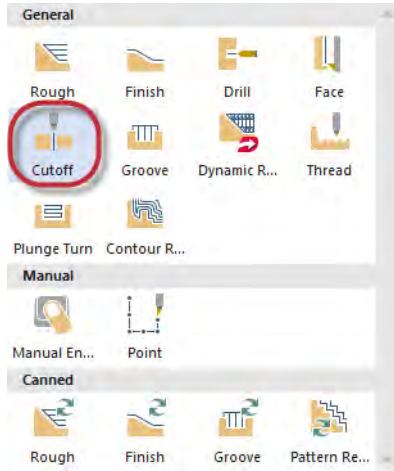

- 2 Select the cutoff boundary point at the point indicated.

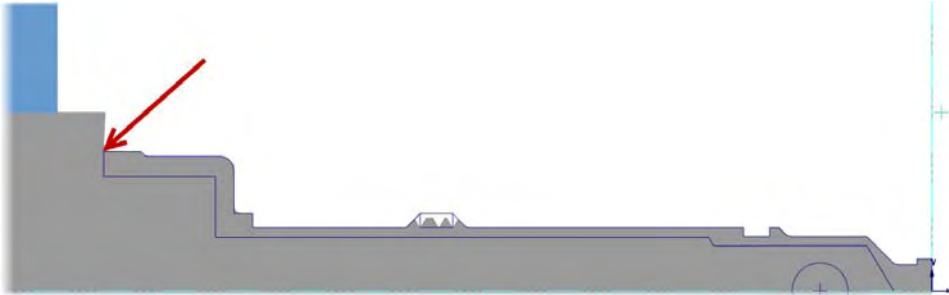

TIP: To more easily select the cutoff boundary point:

- change the GView to **Top**
- hide Level 1
- turn off the toolpath display [**Alt + T**]

The Lathe Cutoff dialog box opens.

- 3 Select the cutoff tool: **T151151 R0.4 W4. OD CUTOFF RIGHT.**

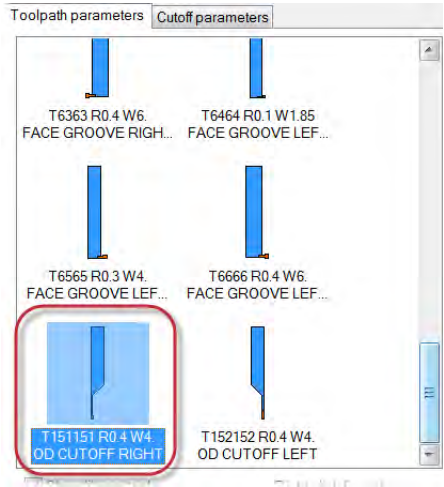

- 4 Click the **Stock Update** button to open the Stock Update Parameters dialog box.

Use this dialog to define whether the stock model will be based on the finished part or leftover stock after the cutoff operation.

- a Select the **Keep separated piece** option.

Mastercam will display the part boundary after the part is cut from the stock.

- b Click **OK**.

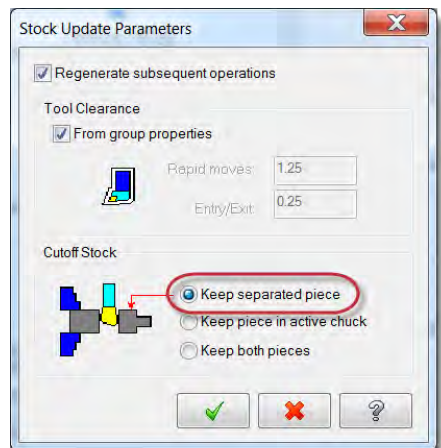

5 Open the **Cutoff parameters** tab.

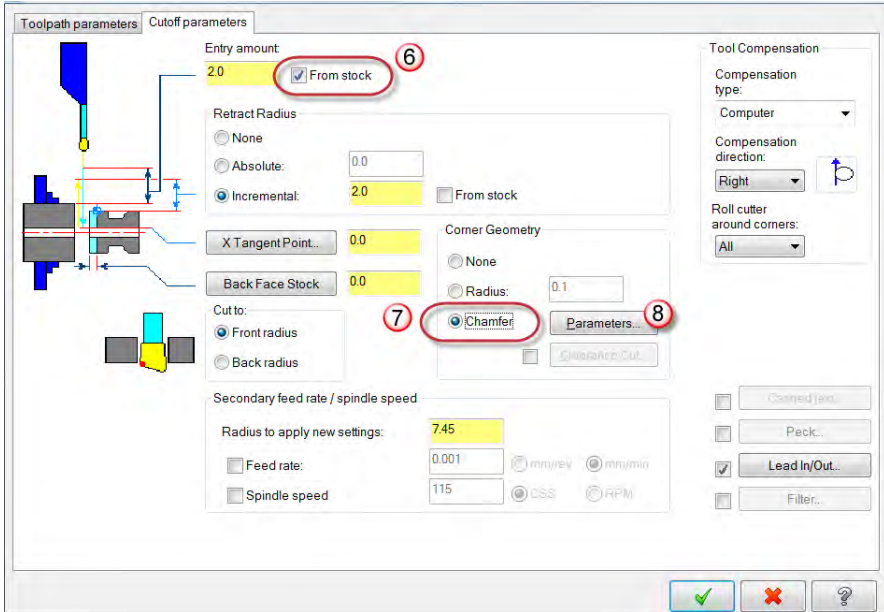

6 Select the **From stock** option.

Mastercam computes the **Entry amount** from the maximum stock diameter at the Z coordinate of the cutoff boundary point.

7 Select **Chamfer** to cut a chamfer on the corner of the part.

8 Click **Parameters** to enter chamfer dimensions in the Cutoff Chamfer dialog box.

- a** Enter **0.25** in the Width field.

The chamfer is defined by its width. Mastercam automatically calculates the height from this dimension and the angle.

- b** Click **OK** to return to the Cutoff parameters tab.

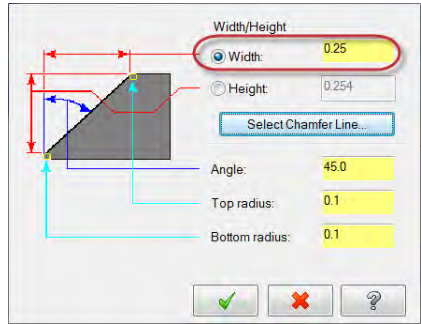

- 9** Click **OK** to create the operation.
Mastercam cuts the part from the stock.
- 10** Save the part.

Exercise 2: Programming a Stock Flip

A stock flip lets you program operations on the opposite side or back of a lathe part in the same Mastercam file. Stock flip operations output a comment and program stop in the NC code, which lets the operator manually remove the stock and reposition (flip) it in the chuck.

In this exercise, you program the new stock and chuck position.



IMPORTANT: You can only program part handling operations such as a stock flip when they are supported by the active machine definition.

- 1 Use the procedure on page 71 to create a new toolpath group. Rename the group **Back/Inner Diameter**.

The new toolpath group will include the stock flip and the operations machining the back and inner diameter of the part.

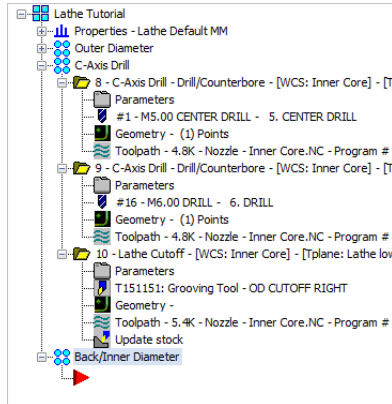

- 2 Select **Stock Flip** from the Part Handling group on the Lathe Turning tab.

The Lathe Stock Flip dialog box opens.

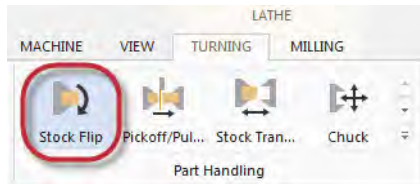

► Re-align Part Geometry

Use the options in the Lathe Stock Flip dialog box to make a copy of part geometry that is aligned with the new stock model and to remove the original geometry from view.



NOTE: Mastercam blanks the original entities. They are not deleted. (See Help for more information on blanked entities.)

- 1 If necessary, select the **Transfer geometry** and **Blank original geometry** options.
- 2 Click the **Select** button under the Transfer geometry option.

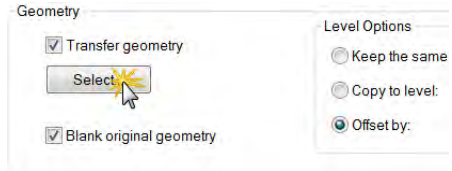

Mastercam returns you to the graphics window.

- 3 Window-select the entire part, and press **[Enter]** or the **End Selection** button.

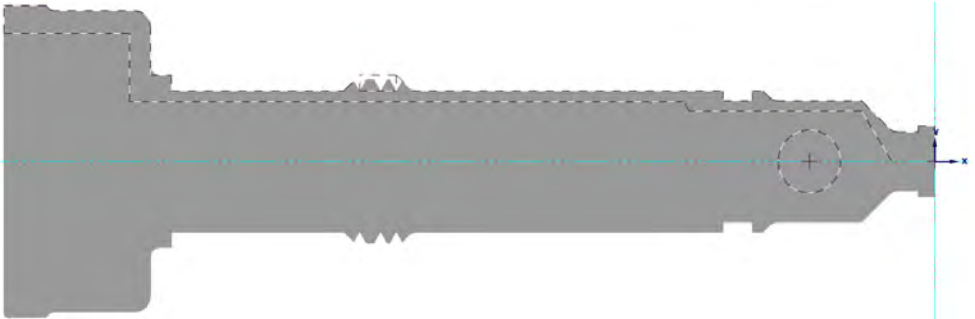

All entities are selected.

- 4 In the Level Options section, offset the level of the transfer geometry by **100**.

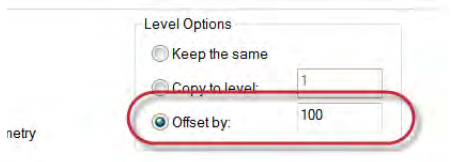

► Enter new stock and chuck jaw positions

Use this procedure to define the new stock position and the final position of the chuck jaws after the stock flip.

- 1 To position the transferred stock, click the **Select** button under Transferred Position, and choose any point on the back edge of the part.

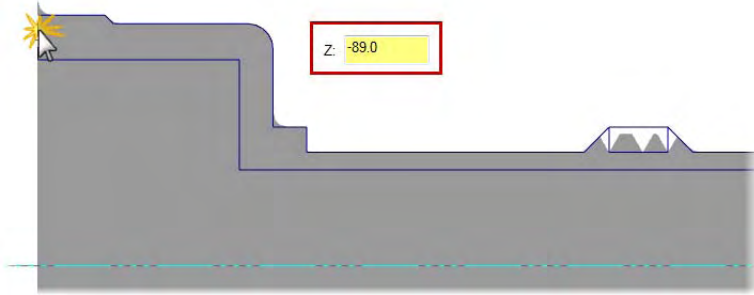
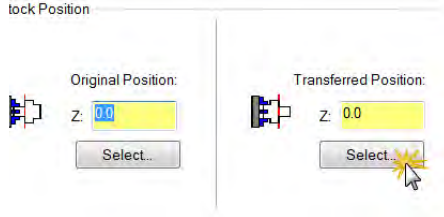

As indicated by the image in the dialog box, the point you select (Z -89.0) will be transferred to Z0 after the stock flip operation

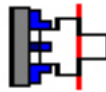

TIP: The point you choose does not have to be on the face of the stock. You can choose any convenient reference point.

- 2 To set the final position of the chuck jaws, click the **Select** button under Final Position, and choose the point from the graphics window, as indicated in the graphic on page 91.

This is where the chuck jaws will grip the stock after the stock flip operation.

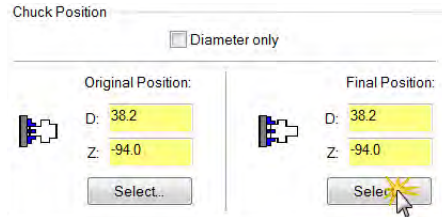

LESSON 6

Machining the Inner Diameter

In this lesson you create the toolpaths necessary to machine the inner diameter (ID) of the hose nozzle. You may notice that many of the toolpaths need only slight adjustments applied to work on the inner diameter. After you have completed creating the toolpaths, use Verify's display tools to inspect your work.

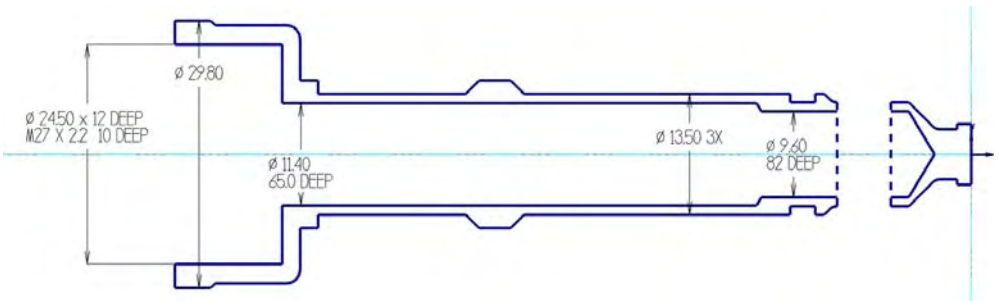

Lesson Goals

- Create new tools based on existing tools
- Create toolpath operations on the inner diameter of the part
- Use Verify's display tools to inspect your work

Exercise 1: Creating New Tools in the Lathe Tool Manager

The interior of the hose nozzle part is hollow. You use two drill operations to cut the longest two inner diameters. Both operations require creating new tools that match the diameter of each drill hole (9.6 mm and 11.4 mm). The third and widest inner diameter requires roughing and finishing tools that fit within dimensions of the bore (24.5 mm), as well as an ID threading tool that can cut to the thread standard for garden hoses (GHT).

Although your shop may choose to use standard tools to cut these toolpaths, in this exercise, you create all of these tools in the Lathe Tool Manager.

► Create the 9.6 mm drill

The 9.6 mm drill is based upon a 9 mm drill that is already in the tool library.

- 1 Select **Lathe Tool Manager** from the Utilities group on the Lathe Turning tab.

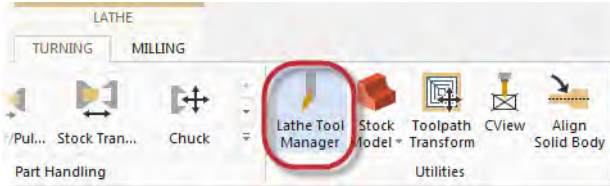

The Tool Manager opens. The upper window displays the tools used in the current Mastercam file.

- 2 Click and drag **T123123 9. Dia DRILL 9. DIA** from the library window to the part window.

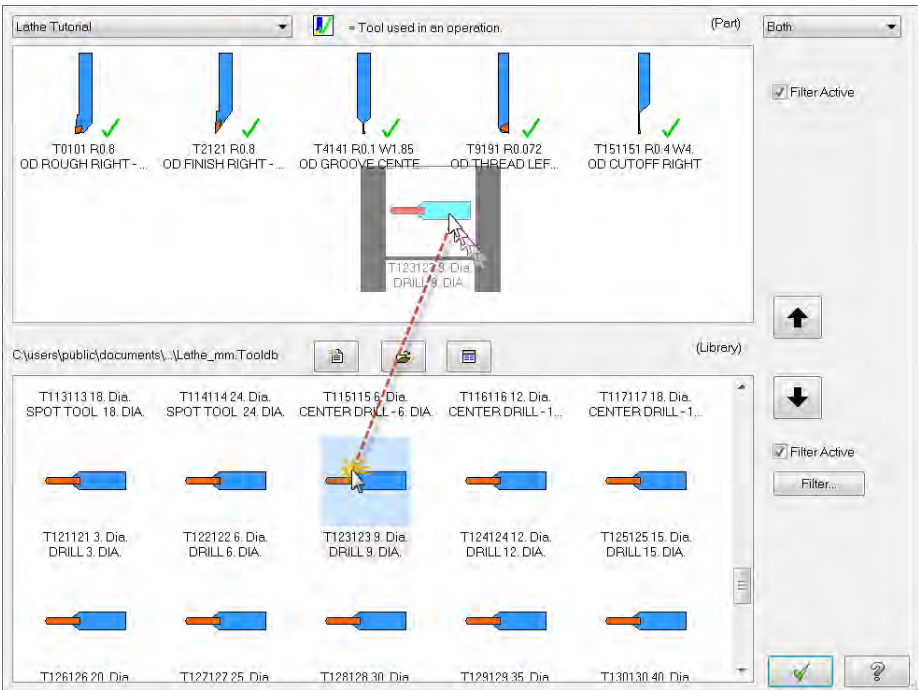

When you create or work on a tool in the part window, you are working on a the tool definition that is stored in the machine group. That means if you edit a tool from the part window, you are only changing the definition in the machine group and not the tool library. If you import the tool from another Mastercam file, the changes you make here will not appear in the original file.



TIP: Select the **Filter Active** option to filter the list of tools. Click the **Filter** button to change the filter criteria with the Lathe Tool Filter dialog box.

- 3 Using the right-click menu, copy and paste the 9 mm drill in the part window.
- 4 When prompted, click **Yes** to add a similar tool.

A copy of the 9 mm drill is added to the part window.

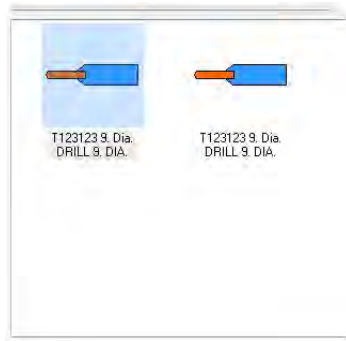

- 5 Right-click the copied tool, and select **Edit tool** from the menu.

The Define Tool dialog box opens.

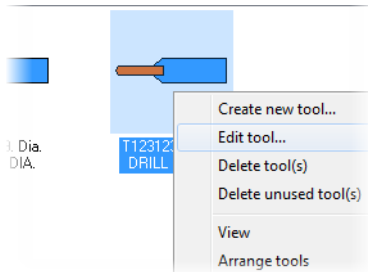

- 6 Edit the tool geometry as shown.
These values define the dimensions of the new tool insert.

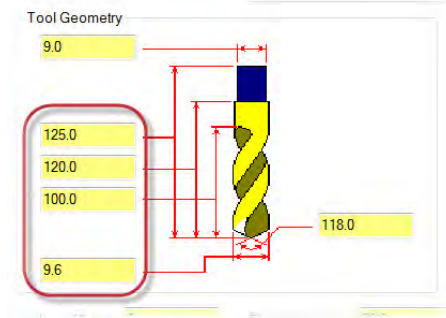

- 7 Click the **Holders** tab, and edit the dimensions of the holder.

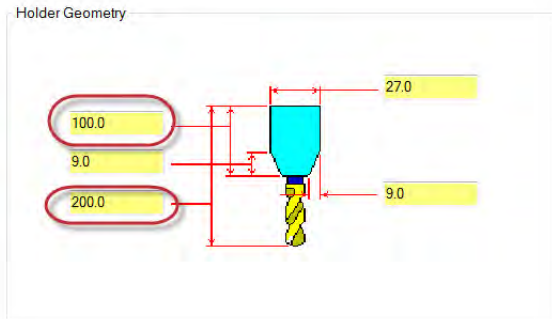

- 8 Click the **Parameters** tab and rename the tool.

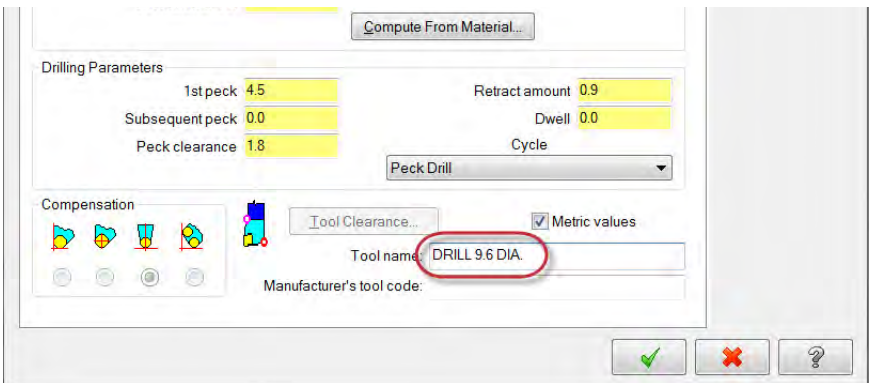

- 9 Click **OK** to finalize your changes.

The new tool profile displays in the part window.



► Create the 11.4 mm drill

Repeat Steps 3 – 9 to create the 11.4 mm drill.

- Enter the following values to create the tool and holder dimensions.
- Rename the tool: **DRILL 11.4 DIA.**

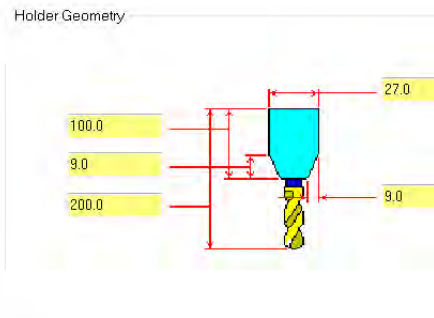
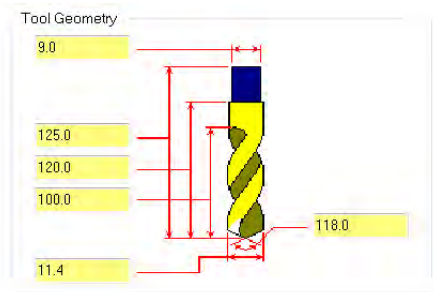

The original tool and the two new tools display in the part window.



► Create the ID roughing tool

- 1 Click and drag **T7171 R0.4 ID ROUGH MIN 16. DIA - 80 DEG.** from the library window to the part window.
- 2 Right-click the tool, and select **Edit tool** from the menu.
The Define Tool dialog box opens.
- 3 Choose **05** from the IC Dia./Length drop-down.

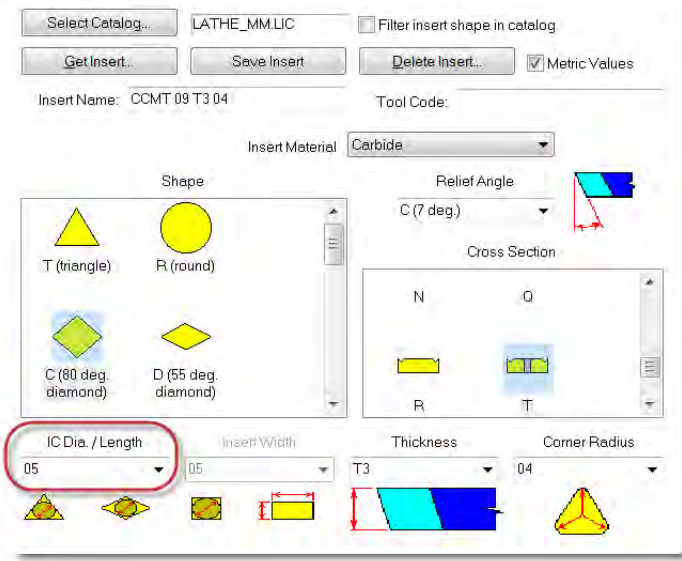

This value defines the insert's IC diameter or length (depending on the selected shape). The IC diameter (IC = inscribed circle) is determined by placing a circle in the insert shape and measuring the circle's diameter.

- 4 Leave the other parameters on this tab at their default values, and click the **Boring Bars** tab.



- 5 Change the holder geometry as shown to fit the newly edited insert.

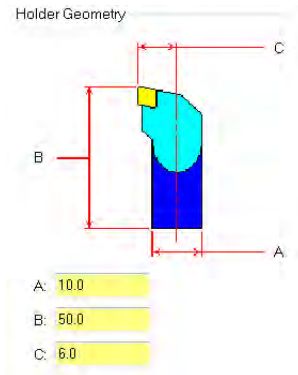

- 6 Click the Parameters tab, and rename the tool: **ID ROUGH MIN. 10. DIA. - 80 DEG.**

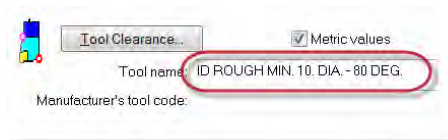

- 7 Click **OK** to finalize your changes.

▶ Create the ID finishing tool

Create a finishing tool for the bore you will turn.

- 1 In the part window, use the right-click menu to copy and paste the tool you just edited (ID ROUGH MIN. 10. DIA. - 80 DEG).
 - 2 When prompted, click **Yes** to add a similar tool.
 - 3 Right-click the copied tool, and select **Edit tool** from the menu.
- The Define Tool dialog box opens.

- Enter the following values to create the insert's inscribed circle diameter and a smaller corner radius.

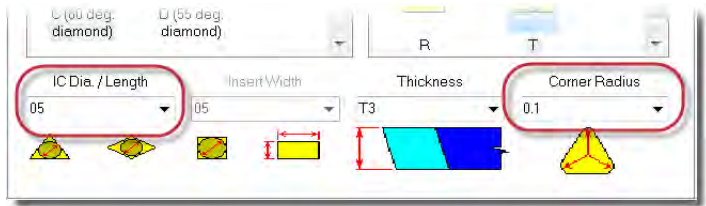

TIP: You can either enter dimensions directly or select them from the drop-down menu.

- Keep the holder geometry as shown to fit the newly edited insert.

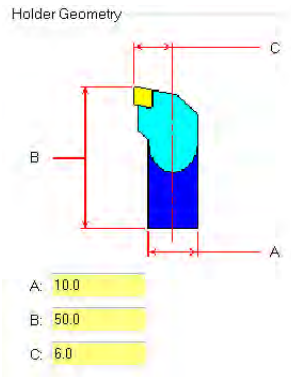

- Name the new tool: **ID FINISH MIN. 10. DIA. - 80 DEG.**
- Click **OK** to finalize your changes.

► Create the ID threading tool

- Click and drag **T101101 R0.036 ID THREAD MIN. 20. DIA.** from the library window to the part window.
- Right-click the tool, and select **Edit tool** from the menu.
The Define Tool dialog box opens.

- 3 Edit the insert geometry by increasing the lead (mm/thread) and cutting depth (C) of the insert.

Mastercam uses these values to calculate the default feed rate based on the spindle speed value entered on the Parameters page.

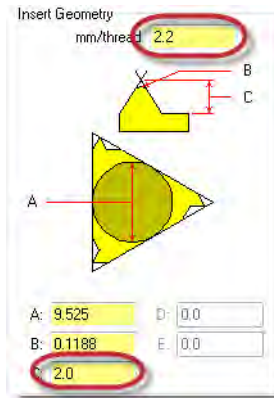

- 4 On the Holders tab, decrease the diameter of the holder (A) to 12.0.

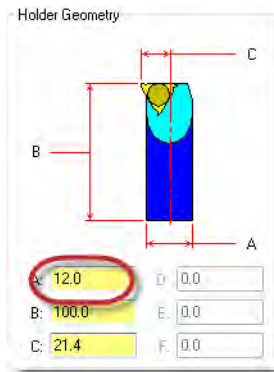

- 5 Click the Parameters tab, and rename the tool: **ID THREAD MIN. 12. DIA.**
- 6 Click **OK** to finalize your changes.

You have now finished creating the tools that you need to machine the inner diameter of the part.

- 7 Click **OK** to exit the Lathe Tool Manager.

Exercise 2: Facing the Back of the Part

It is a best practice to prepare the back face of the part for further machining. Create a Face toolpath using the default roughing tool (T0101 R0.8 OD ROUGH RIGHT - 80 DEG) to finish the back face of the part to Z0.

Use the same procedure to face the back of the part as you used to face the front. If you feel you still need instruction to create this operation, refer back to Lesson 2, Exercise 1 (page 27).

Exercise 3: Drilling the First Inner Diameter

Drill operations in Lathe are on the center line of the part and are placed by default at the part origin.

- 1 Select **Drill** from the Lathe Turning tab.

The Lathe Drill dialog box opens.

Unlike most toolpaths, lathe drill toolpaths do not require you to select geometry before entering the toolpath parameters.

- 2 Select the 9.6 mm drill from the tool window.

If desired, enter comments for the toolpath.

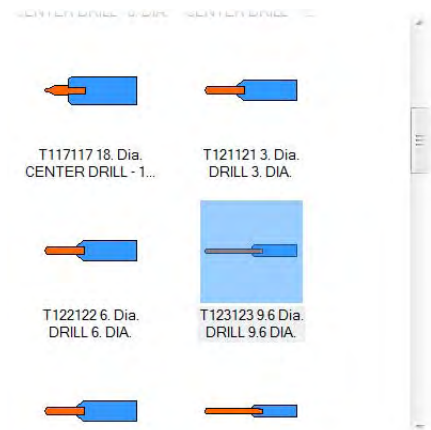
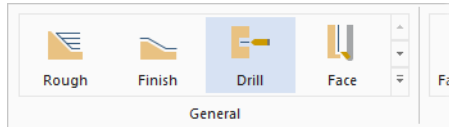

- 3 Click the **Simple drill - no peck** tab.

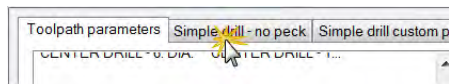

- 4 Click the **Depth...** button to define the bottom of the drill hole from a point in the graphics window.

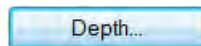

- 5 Select the point indicated.

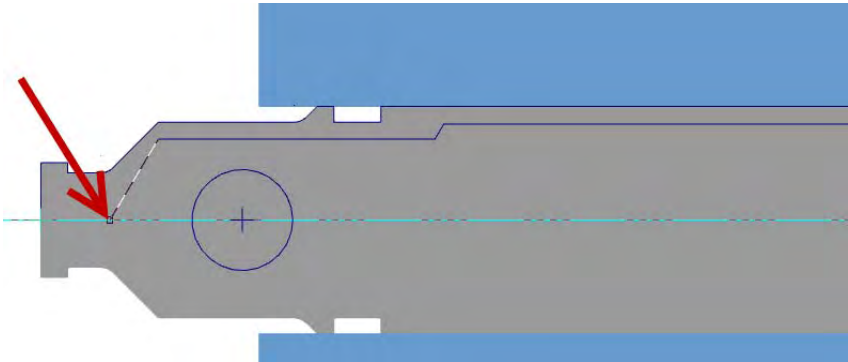

Mastercam returns you to the Lathe Drill dialog box and automatically enters the correct value in the Depth field.

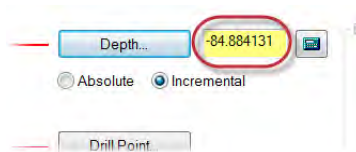

- 6 Choose **Peck Drill** from the Cycle drop-down list.

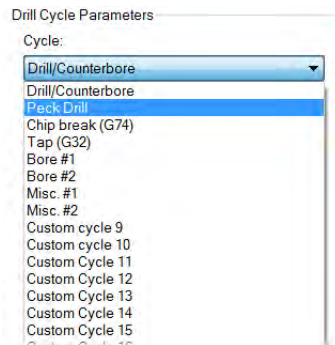

The parameters tab changes from **Simple drill - no peck** to **Peck drill - full retract**.

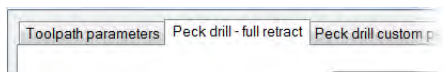

The name that appears on this tab depends on the cycle you select in the Drill Cycle Parameters drop-down list. The cycles which are available to you depend on the active control definition.

- 7 Set the depth for the first and all subsequent peck moves to **2.0** mm.

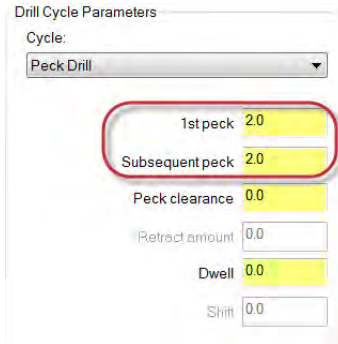

- 8 Click **OK** to complete the operation.

The graphics window displays how the first inner diameter is drilled.

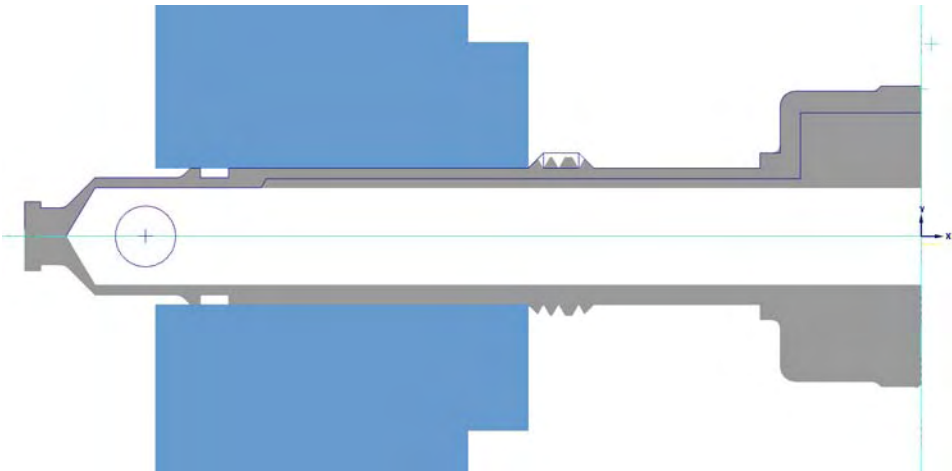

Exercise 4: Drilling the Second Inner Diameter

This operation uses the depth calculator to adjust the drilling depth of the tool.

- 1 Select **Drill** from the Lathe Turning tab.

- 2 Select the 11.4 mm drill from the tool window.

If desired, enter comments for the toolpath.

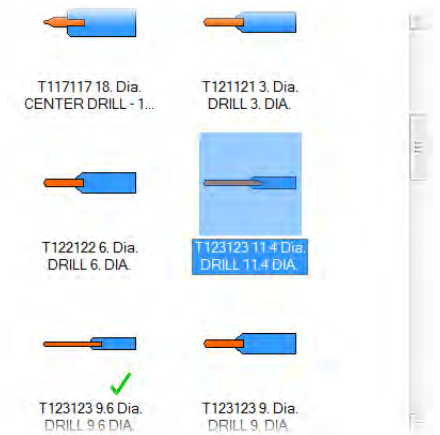

- 3 Click the **Peck drill - full retract** tab.

Mastercam remembers the last drill cycle you selected.

- 4 Click the **Depth** button to define the bottom of the new toolpath's drill hole.
- 5 Select the point indicated.

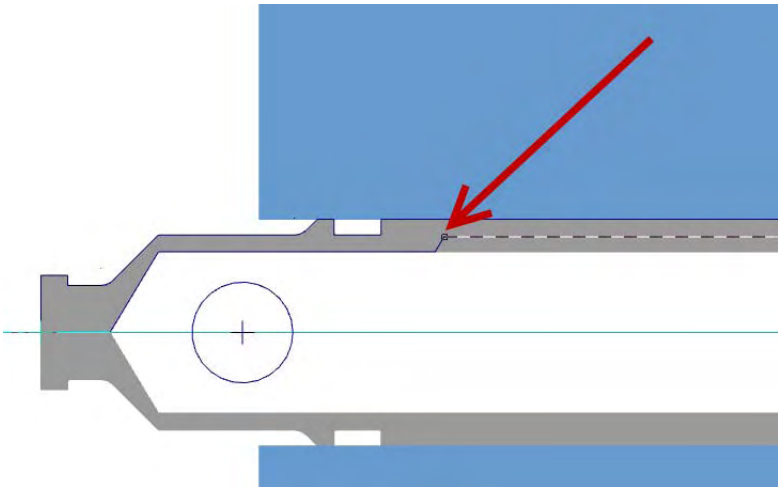

The depth of the drill hole at the selected point is automatically entered in the Depth field.

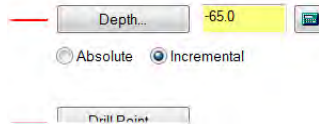

Although you did not select the tip of the drill hole, you can use Mastercam's depth calculator to calculate the proper drilling depth based on the finish diameter and drill size.

- 6 Click the **Depth Calculator** button.

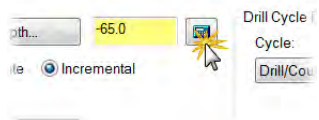

The Depth Calculator dialog box opens.

With the **Use current tool values** option selected, Mastercam displays the tool diameter, tool tip included angle, and tool tip diameter for the tool you choose on the Toolpath page. It calculates the proper drilling depth and adds it to the existing depth.

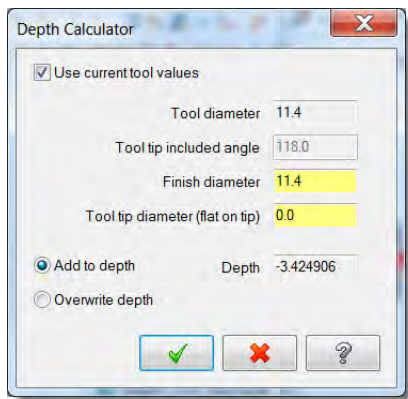

- 7 Click **OK** to return to the Lathe Drill dialog box.

The depth of the bottom of the drill point is entered into the field.

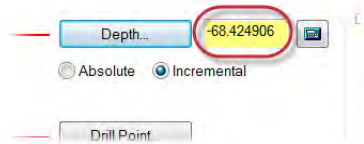

- 8 Leave all other parameters in the dialog box as is, and click **OK** to create the operation.

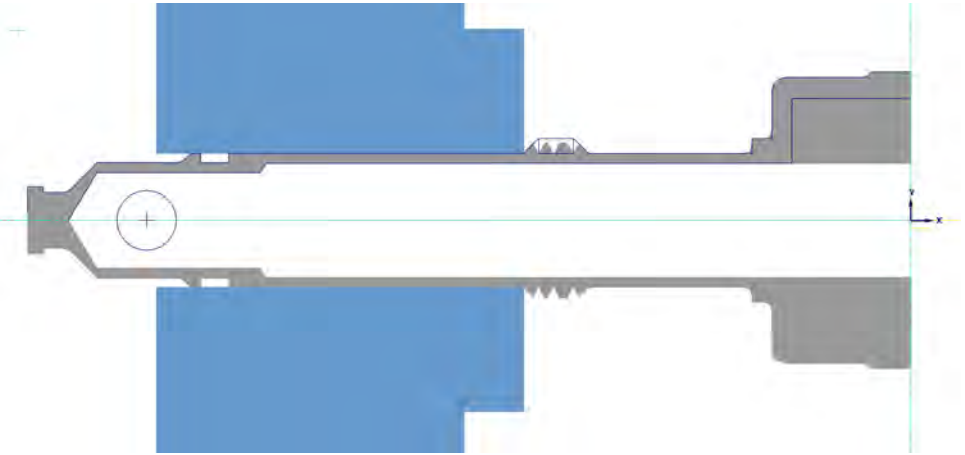

Exercise 5: Roughing and Finishing the Third Inner Diameter

In this exercise, you bore the third inner diameter with roughing and finishing operations. With the exception of a standard finish toolpath, the roughing and finishing operations that you create on the inner diameters are very similar to the toolpaths you created on the outer diameter (Lesson 2).

- 1 Select the **Rough** toolpath from the Lathe Turning tab.

The Chaining dialog box displays and you are prompted to select an entry point.

- 2 Click the geometry to create a partial chain as shown.

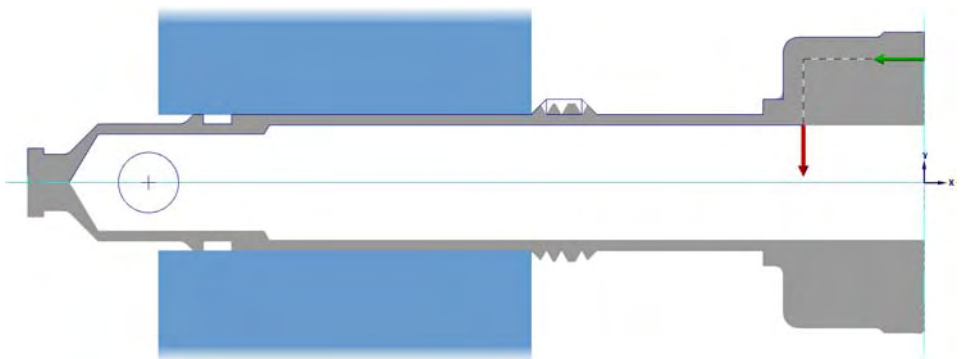

- 3 Click **OK** in the Chaining dialog box to accept the chain.



The Lathe Rough dialog box opens.

- 4 Select the ID roughing tool you created on page 98: **ID ROUGH MIN 10. DIA - 80 DEG.**

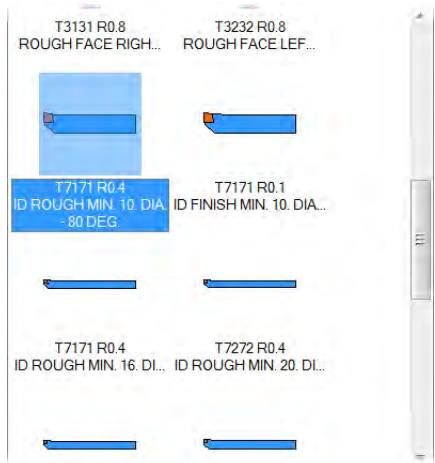

- 5 Type **ID - Rough** in the Comment field.

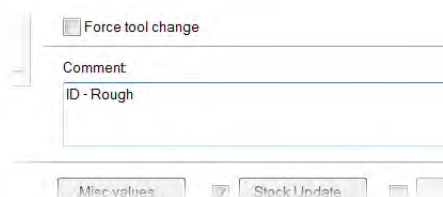

6 Change the following cutting values on the **Rough parameters** tab.

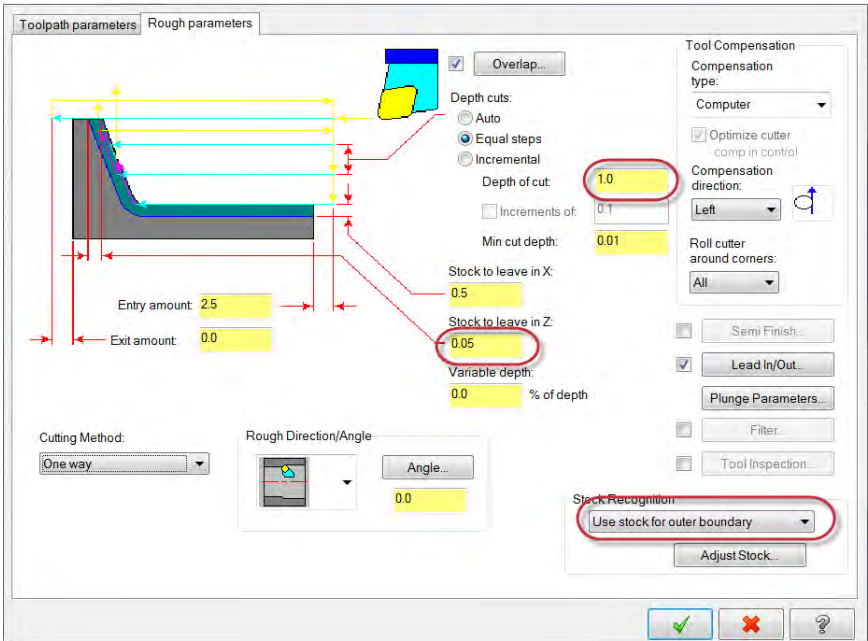

- Change the Depth of cut to **1.0**.
- Decrease the Stock to leave in Z to **0.05**.
- Select **Use stock for outer boundary** from the Stock Recognition drop-down.

7 Click the **Lead In/Out** button.

The Lead In/Out dialog box opens.

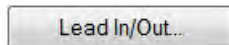

a Click the **Lead out** tab.

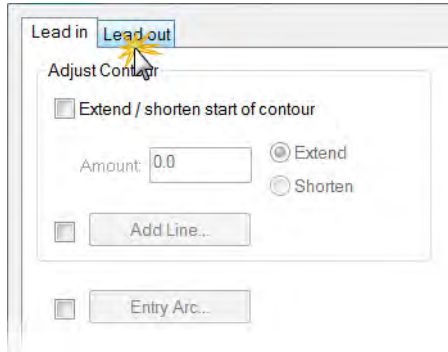

b Enter **0.5** in the Length field.

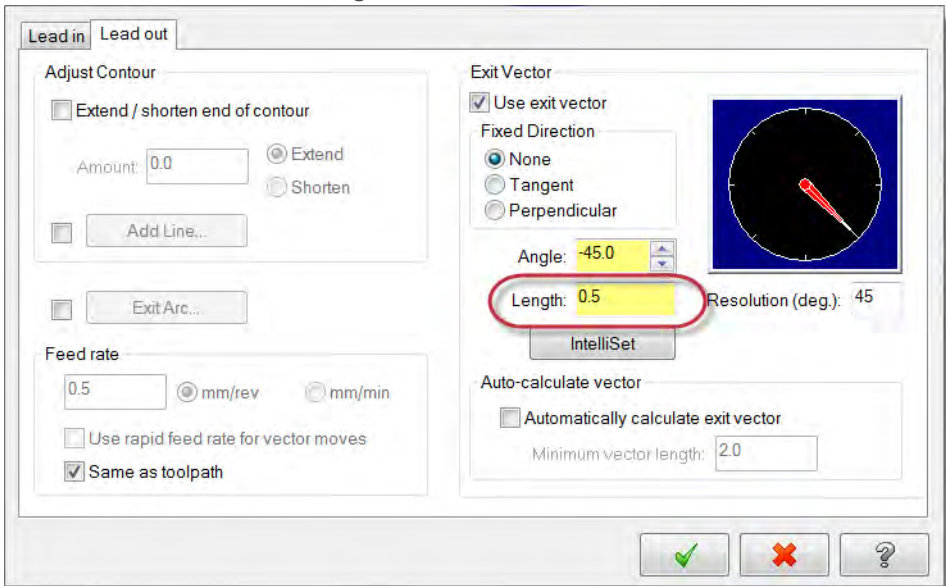

This is the length of the vector the tool follows as it retracts from the part.

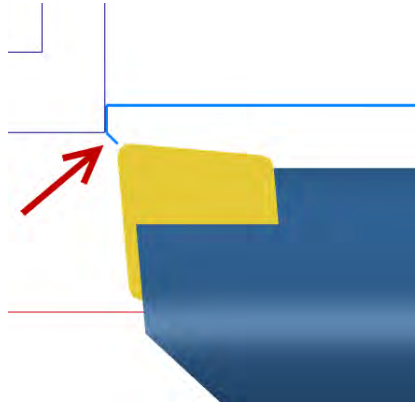

- c Click **OK** to return to the Lathe Rough dialog box.
- 8 Keep all other parameters in the dialog box at their default values.
- 9 Click **OK** to create the rough toolpath.



- 10 Create a finishing toolpath. Use **ID FINISH MIN. 10. DIA. - 80 DEG** to finish the bore you just roughed. (This is the finishing tool you created on page 99.) Leave all settings at their default values.
- 11 Save the part.

Exercise 6: Adding an ID Thread

- 1 Expand the General gallery, and choose **Thread** from the Lathe Turning tab.
The Lathe Thread dialog box opens.



NOTE: You do not need to select geometry to create a thread toolpath.

- 2 From the Toolpath parameters tab, select the thread tool you created on page 100: **ID THREAD MIN 12 DIA.**

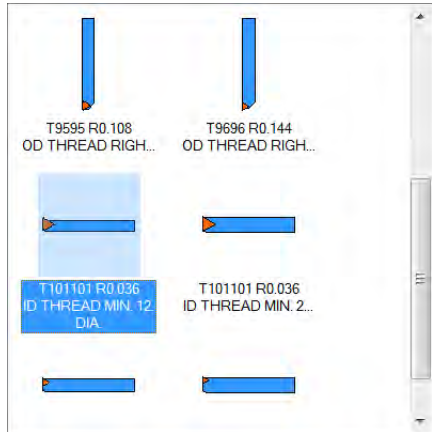

- 3 Enter **400** into the Spindle speed field, and select the **mm/rev** option for the Feed rate.

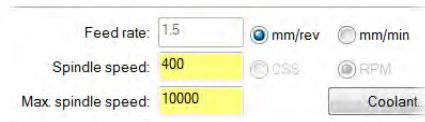

- 4 Type **ID - Thread** in the Comment field.

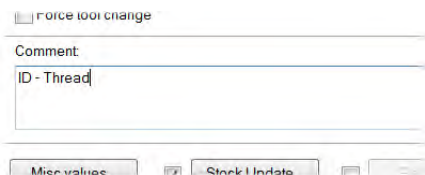

- 5 Keep all other parameters on this page at their default values.

6 Click the **Thread shape parameters** tab.

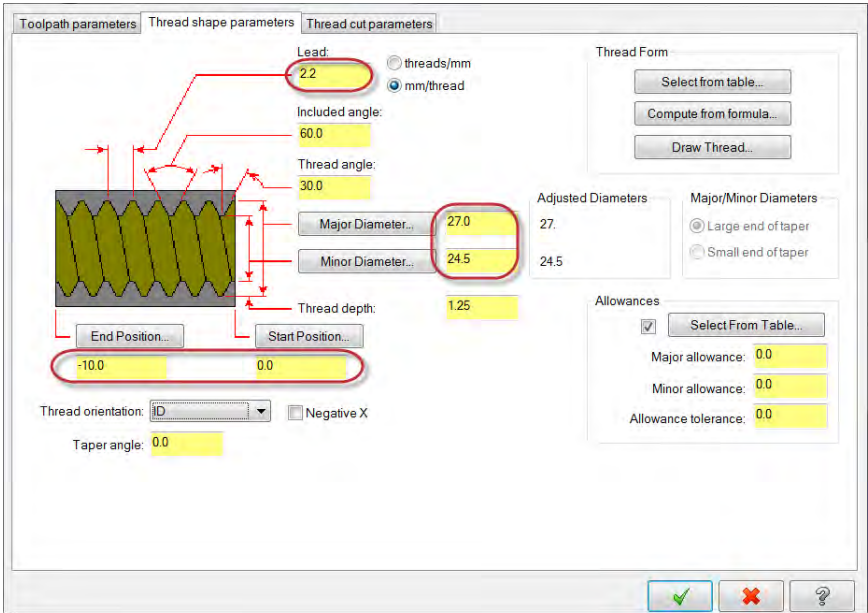
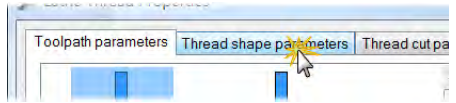

7 Refer to the illustration above to enter the following thread dimensions:

- lead
- major and minor diameters
- start and end positions

The blueprint on page 93 also shows these values.



TIP: If you are cutting a standard thread, click **Select from table** to display a list of standard thread tables. Mastercam will automatically fill in the fields for the thread dimensions with values from these tables. See Mastercam Help for more information.

- 8 Confirm that the thread orientation is **ID**.
- 9 Click the **Thread cut parameters** tab.

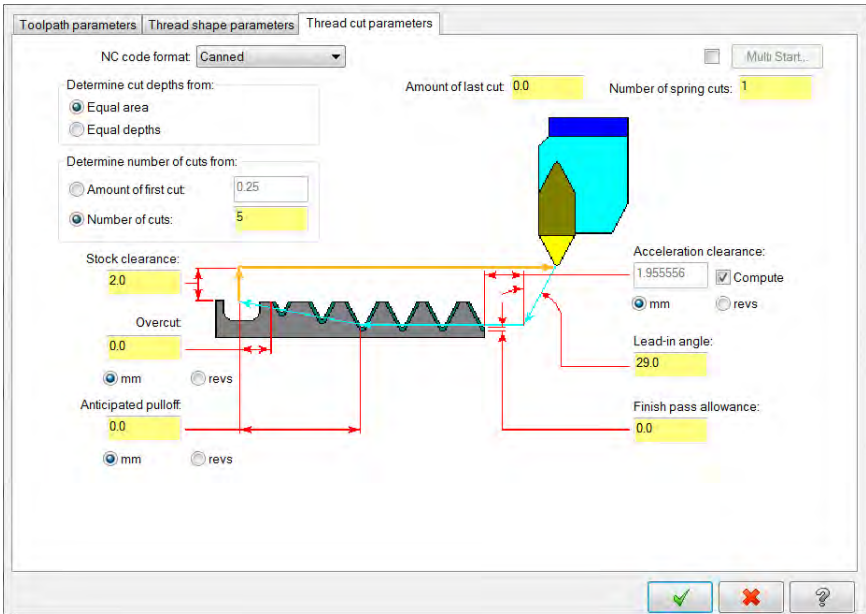

- 10 If necessary, select the **Compute** option to calculate the required acceleration clearance.
- 11 Keep all other parameters on this page at their default values.

12 Click **OK** to create the toolpath.

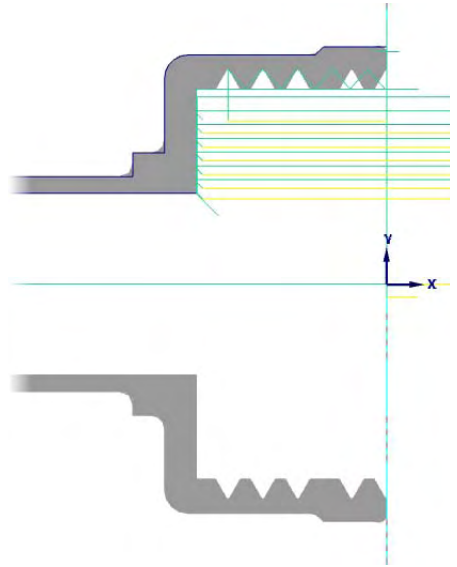

13 Save the part.

Exercise 7: Refining Your Verification Results

In Lesson 3, you used Accurate Zoom and True Thread to more clearly see your work. In this exercise, you use Verify's Part Sectioning tools to view the cuts you made along the inner diameter.

- 1 Select operations 12 through 17 in the Toolpaths Manager.

These are all the operations you created on the inner diameter.

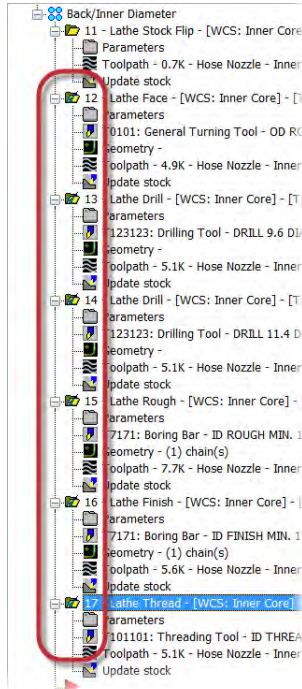

- 2 Click the **Verify selected operations** button.

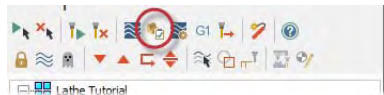

Verify displays in the Mastercam Simulator window.

- 3 Hide the fixture, and change the stock opacity to translucent.

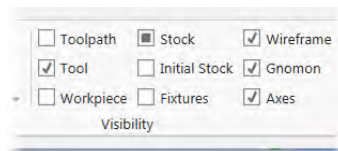

- 4 Turn the **Color Loop** on to view each operation's change to the stock as a different color.

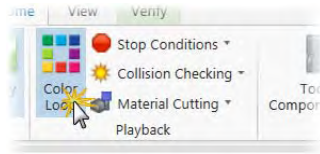

The color of each operation is also represented as a different color on the playback bar.



TIP: Improve your view by panning, zooming, and rotating.

- 5 Click the **Play** button or press [R] to verify the toolpath.

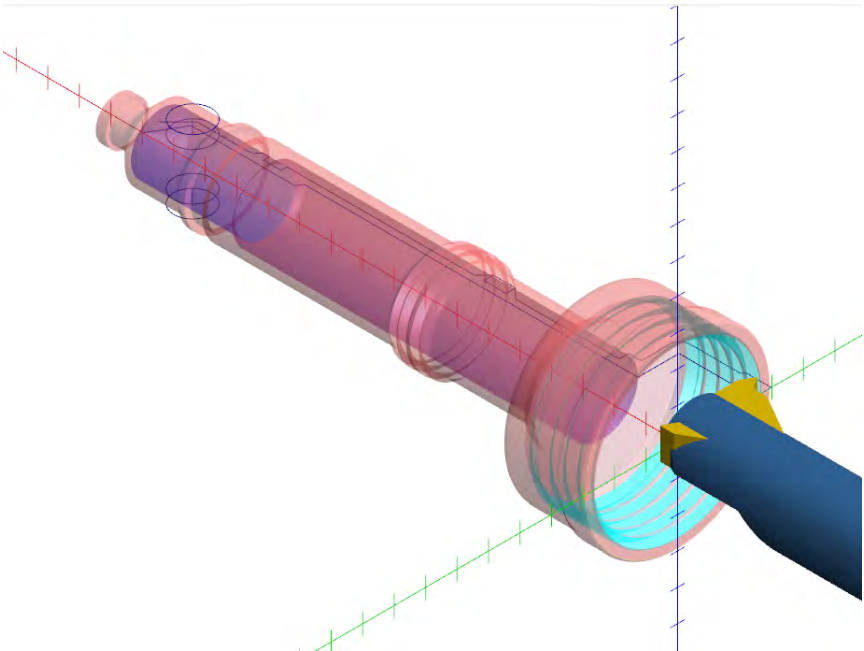

Although you are able to view the operations through the translucent stock, Mastercam Simulator's clipping plane and part sectioning tools offer an even better view of the part's interior.

- 6 Change the stock back to opaque.

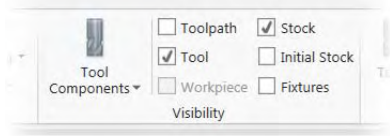

- 7 Select the **Verify** tab.



- 8 Select the **ZX Clipping Plane** button, and select **Clip Front** from the drop-down menu.

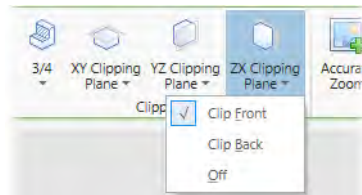

A cross-section is drawn through the stock's ZX plane.



TIP: Click and drag the plane to position the cross-section.

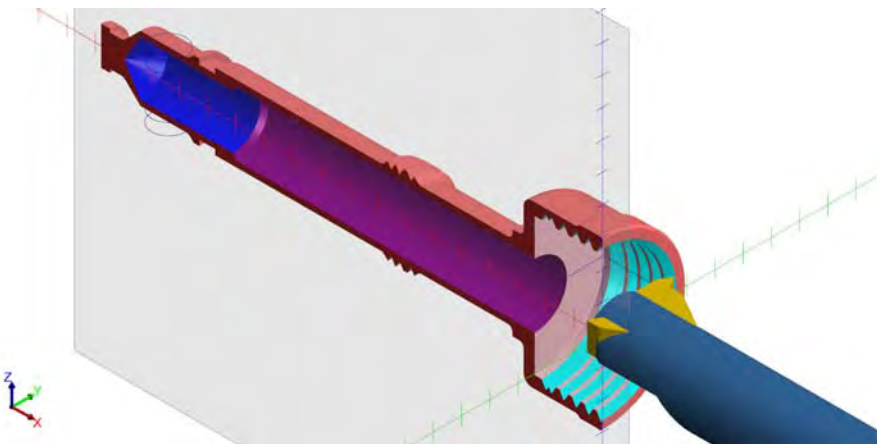

- 9 Select **Off** from the drop-down menu to stop displaying the clipping plane.
- 10 Select a quadrant from the **3/4** sectioning menu.

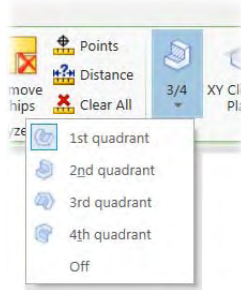

Part sectioning displays your stock in 3/4 sections using a combination of two clipping planes. Once you select a section, you can click and drag either plane to adjust the view.

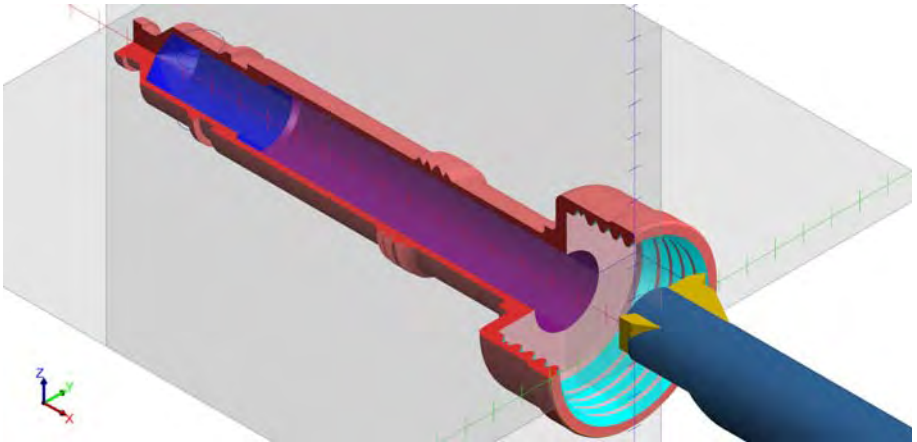

- 11 Click **3/4, Off** to turn off part sectioning.

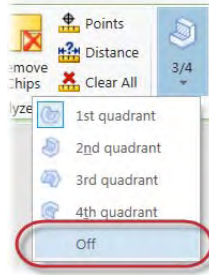

- 12 Close the Machine Simulator.

You have finished cutting the part. In the next lesson, you organize your tools and post your work to the machine.

LESSON 7

Post Output

Posting refers to the process by which the toolpaths in your Mastercam part files are converted by a specialized processing program to a format that can be understood by your machine tool's control.

Tool numbers that are output to your NC file come from the Toolpath parameters tab or Tool page for each operation. When you select a tool for an operation, Mastercam generates a default tool number and default tool offsets. If your machine only accepts a limited range of tool numbers, Mastercam lets you reassign tool numbers for operations in a machine group.

In the final lesson of this tutorial, you renumber the tools used in the operations you created, and then post the entire set to the NC file.

Lesson Goals

- Renumber all tools used to cut the part
- Post your work for inspection

Exercise 1: Renumbering Tools

In this exercise, you renumber the tools for each operation.

- 1 Select all operations in the Toolpaths Manager.



- 2 Right-click the machine group.

3 Select **Edit selected operations, Renumber tools** from the menu.

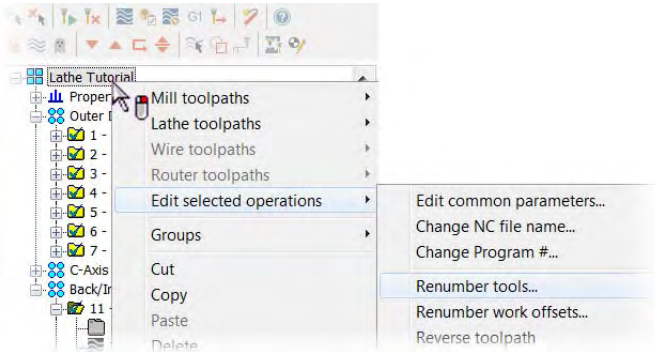

The Renumber tools dialog box displays.

4 Clear the last option to renumber tools that are not used in any operation.

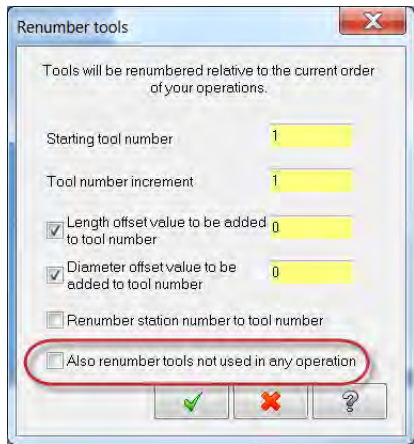

5 Click **OK**.

The tools in the Toolpaths Manager are renumbered relative to the current order of the operations.



TIP: Use the procedure above to reassign tool numbers after you have already created toolpaths. To number tools in the machine group by operation before you create toolpaths, select the option on the Tool Settings tab in the Machine Group Properties dialog box.

Exercise 2: Posting

In this exercise, you post the operations in the machine group.

- 1 If necessary, select all operations in the Toolpaths Manager.
- 2 Click the **Post selected operations** button in the Toolpaths Manager.



If you have not selected all the operations in a machine group, Mastercam will ask if you want to post all the operations.

The Post processing dialog box displays. Mastercam uses these settings to handle the files that are generated when posting.

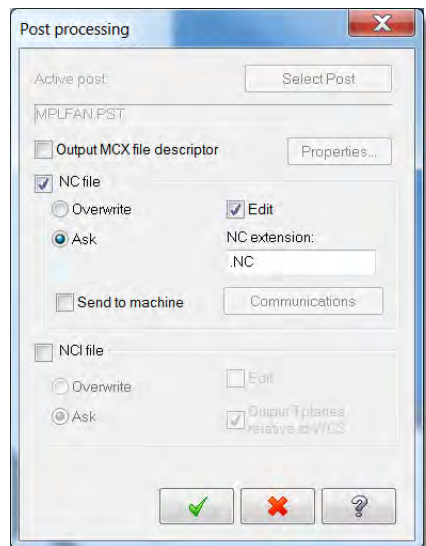

- 3 Click **OK**.

The Save As dialog box displays.

- 4 Rename the file, or click **Save** to accept the default NC file name.

Mastercam posts the file, and it is opened in your default file editor. Use the generated text file to evaluate your post before sending it to the machine.

Conclusion

Congratulations! You have completed the *Getting Started with Mastercam Lathe* tutorial. Now that you have mastered the skills in this tutorial, explore Mastercam's other features and functions.

You may be interested in other tutorials that we offer. The Mastercam tutorial series is in continual development, and we will add modules as we complete them. Visit our website, or select **Help, Tutorials** from the **File** tab to see the latest publications.

Mastercam Resources

Enhance your Mastercam experience by using the following resources:

- *Mastercam Help*—Access Mastercam Help by selecting **Help, Contents** from Mastercam's **File** tab or by pressing **[Alt+H]** on your keyboard. Also, most dialog boxes, function panels, and ribbon bars feature a Help button that opens Mastercam Help directly to related information.
- *Mastercam Reseller*—Your local Mastercam Reseller can help with most questions about Mastercam.
- *Technical Support*—CNC Software's Technical Support department (860-875-5006 or support@mastercam.com) is open Monday through Friday from 8:00 a.m. to 5:30 p.m. USA Eastern Standard Time.
- *Mastercam Tutorials*—CNC offers a series of tutorials to help registered users become familiar with basic Mastercam features and functions. The Mastercam tutorial series is in continual development, with new modules added as we complete them. Visit our website, or select **Help, Tutorials** from Mastercam's **File** tab to see the latest publications.
- *Mastercam University*—CNC Software sponsors Mastercam University, an affordable online learning platform that gives you 24/7 access to Mastercam training materials. Take advantage of more than 180 videos to master your skills at your own pace and help prepare yourself for Mastercam Certification. For more information on Mastercam University, please contact your Authorized Mastercam Reseller, visit www.mastercamu.com, or email training@mastercam.com.

- *Online communities*— You can find a wealth of information, including many videos, at www.mastercam.com. For tech tips and the latest Mastercam news, follow us on Facebook (www.facebook.com/mastercam), Twitter (www.twitter.com/mastercam), or Google+ (plus.google.com/+mastercam). Visit our YouTube channel to see Mastercam in action (www.youtube.com/user/MastercamCadCam)!

Registered users can search for information or ask questions on the Mastercam Web forum, forum.mastercam.com, or use the knowledge base at kb.mastercam.com.

To register, select **Community**, **Link Account** from the **File** tab, and follow the instructions.

Mastercam Documentation

Mastercam installs the following documents in the \Documentation folder of your Mastercam installation:

- *What's New in Mastercam 2017*
- *Mastercam 2017 Installation Guide*
- *Mastercam 2017 Administrator Guide*
- *Mastercam 2017 Transition Guide*
- *Mastercam 2017 Quick Reference Card*
- *Mastercam 2017 ReadMe*

Contact Us

For questions about this or other Mastercam documentation, contact the Technical Documentation department by email at techdocs@mastercam.com.



**Attention! Updates may be available.
Go to Mastercam.com/Support for the latest downloads.**

cnr software, inc.

671 Old Post Road
Tolland, CT 06084 USA
www.mastercam.com