

Getting started with your silhouette  
portrait®



# Connecting your Silhouette Portrait®

## 1

### Check Included Items

The Silhouette Portrait® comes with the items shown in the following list. Check that all the items have been included before starting. If you are missing any items listed below, please contact [support@silhouetteamerica.com](mailto:support@silhouetteamerica.com).

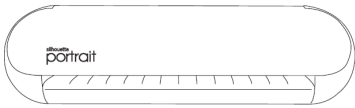

Silhouette Portrait®  
desktop cutting tool

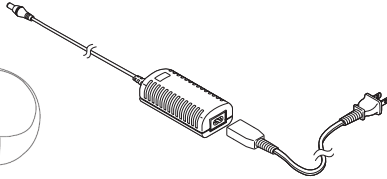

A/C adapter and  
power cable



USB Cable

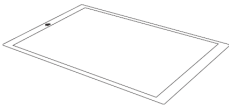

8" x 12" cutting mat

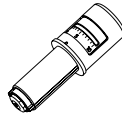

AutoBlade

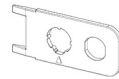

Bluetooth®  
removal tool

Take the Silhouette Portrait® from the box and remove the strips of packing tape and foam as indicated by the following diagram. These strips of tape and foam are used to hold the moving parts of the Silhouette in place during shipment.

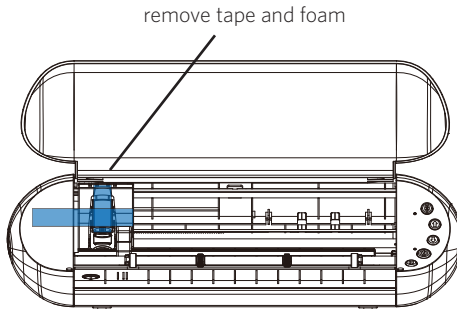

## 2

## Install the Silhouette Studio® Software

### Installation

1. Navigate to [silhouetteamerica.com](http://silhouetteamerica.com).
2. Click the blue “Update Software” button at the top of the screen.
3. Under “Silhouette Studio,” go to the row labeled “Current Version.” Click either “Mac®” or “Windows,” depending on your operating system, listed under the “Link” column.

**FOR WINDOWS:** Proceed through the installation process by following the on-screen prompts. If the installation window does not automatically appear, open the Downloads folder in My Computer and double-click the setup.exe program to run it. If a “New Hardware Found” dialog box appears, follow the recommended instructions to accept your system’s installation of the Silhouette driver.

**FOR MAC®:** Drag and drop the Silhouette Studio® application icon into the Applications folder to install Silhouette Studio®.

## 3

## Connect the Silhouette Portrait®

Once the Silhouette Studio® software is installed, connect the Silhouette Portrait® to the power supply. Then connect the Silhouette to your computer with the included USB cable as shown in the diagram.

1

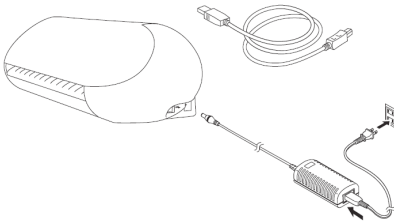

2

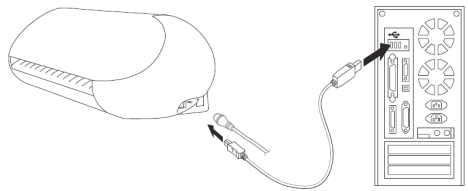

Turn the machine on by pressing the power button. If your PC displays a “New Hardware Found” dialog box, follow the recommended instructions to accept your system’s installation of the Silhouette driver.

## Opening the Silhouette Studio® Software



Locate the Silhouette Studio® icon on the desktop or in the Start Menu on your PC or in the Applications folder on your Mac®. Double-click the icon to run the application.

Once Silhouette Studio® has loaded, you will notice a blank 8” x 12” page on your screen.



If you would like to change the page dimensions or orientation, you will find the page setup options already opened in a panel on the right-hand side of the screen.

To access these page setup options in the future, click the Design Page Settings icon in the options toolbar in the upper right-hand corner of your screen.

# Navigation Tabs

There are four tabs along the top right-hand side:



## Design

This design area is your workspace to create projects. This area houses the toolbars, the white design page, and the gray holding area. When you are in the Library, the Silhouette Design Store, or the Send menu, click the Design tab to return to your design page.

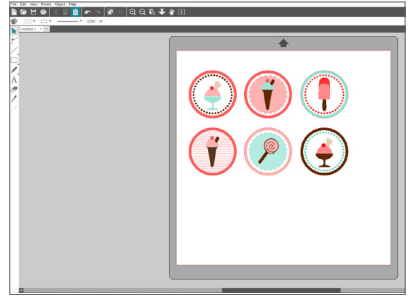

## Store

When you are connected to the internet, the Store tab takes you to the Silhouette Design Store where you can browse and purchase designs.

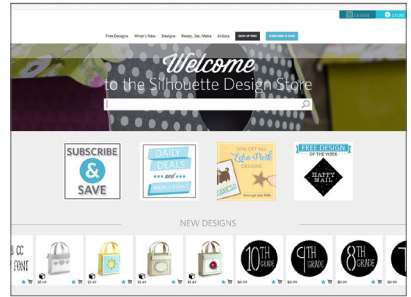

## Library

You can access your stored designs from the Library tab. Sort and organize your designs any way you would like by adding folders and subfolders. Designs can be stored on your computer or on the Silhouette Cloud.

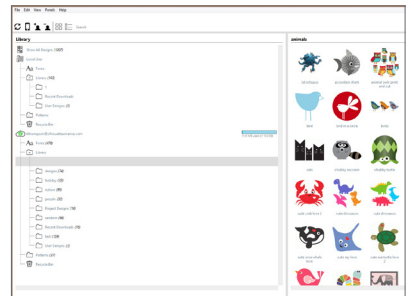

## Send

The Send tab allows you to adjust the cut settings for your designs and send them to your Silhouette. This menu works similar to a Send to Print menu in other programs.

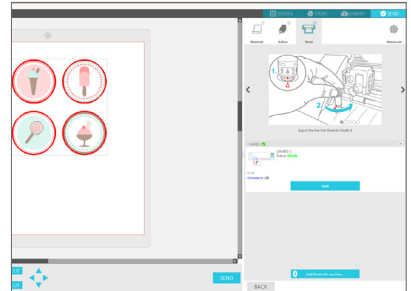

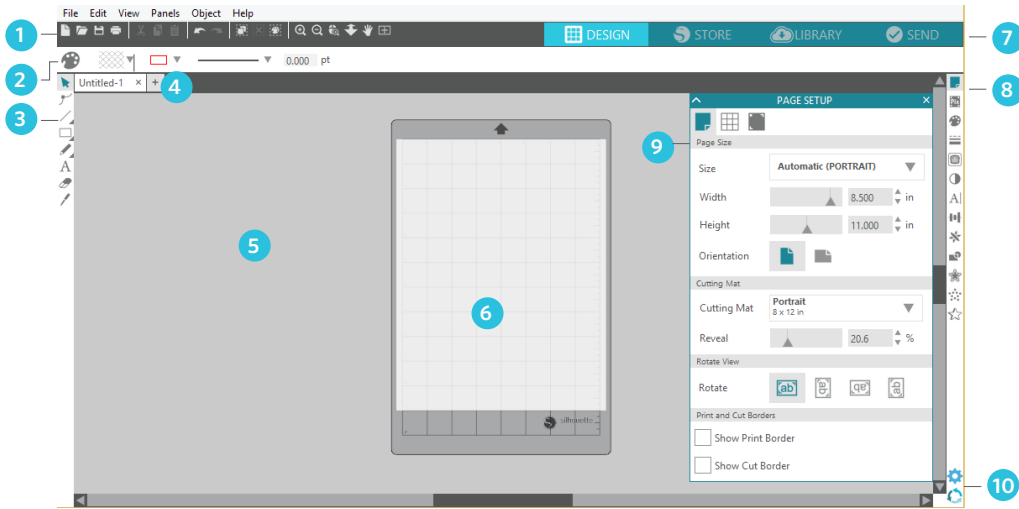

## Work Area Overview

1. Document Tools
2. Quick-access Toolbar
3. Drawing Tools
4. Document Tabs
5. Holding Area (Gray)
6. Active Cut Area
7. Navigation Tabs
8. Silhouette Studio® Tools
9. Panels
10. Preferences and Themes

## Cutting/Drawing Area

There are two different sections in your workspace: the white design page or cutting area and the gray holding area. Images and designs can be placed on both the gray holding area and the cutting space, but only designs or images within the active cut area (bound inside the red box on the white page) will be sent to your Silhouette. The gray area can be used to place your extra work.

## Document Tabs

Your document tabs are located at the top of your workspace. When you open a new document while you already have a document open, a new tab will open. The document tab highlighted in white shows which document is open in your workspace. The other open documents are shown with grayed-out tabs.

Your document tabs allow you to move easily back and forth between multiple documents and let you know at a glance what projects you currently have open. When you save a file, the document tab automatically updates to the file name.

# Panels

Silhouette Studio® design icons open their own panels. Panels open on the right-hand side of the screen when you click a design icon. The first panel you open will be at the top. Any panels you open after the first will replace the panel currently open as long as it is in the default position. If you move the panel from the default location, you can open a new panel and it will snap to the default location. Using this method, you can have as many panels open as you want, and you can move them anywhere in your design screen.

## Collapsing Panels

Panels can be collapsed by clicking the arrow on the left-hand side of the panel. Collapse, move, and rearrange the panels to set up your screen exactly as you like.

When you close panels, the ones underneath will jump up to fill their place.

## Sticky Panels

Panels are sticky, meaning they snap to the top of the design area or to each other. But panels don't need to stick to each other. You can move groups of panels or individual panels anywhere on your screen. Depending on your project, you might want lots of panels open to make adjustments using a wide variety of tools, or you might only want a single panel open at a time.

## Panels Housing Multiple Icons

Some panels are single icon panels, such as PixScan™ or Offset. Other panels consist of a group of related icons. These icons are available within the panel via separate tabs. For example, the Transform panel includes the Align, Scale, Rotate, Move, and, if you have the Designer Edition, Shear icons.

## Panel Mode

You can customize the panel mode in the Preferences panel. Under Defaults, you can choose how you want your panels to open.

- ▶ **Single Panel Mode:** Only one panel can be open at a time. If you have a panel open and you click another icon, that new panel will open in place of the panel that was previously open.
- ▶ **Flexible Panel Mode:** Default. Similar to Single Panel Mode, Flexible will seemingly not allow you to have multiple panels open at once. But, if you move a panel from the default location, it will remain open when you click another panel icon. If you leave the panel in the default location and click another icon, the new panel will open in its place.
- ▶ **Multiple Panel Mode:** All new panels will open no matter how many panels are already open.

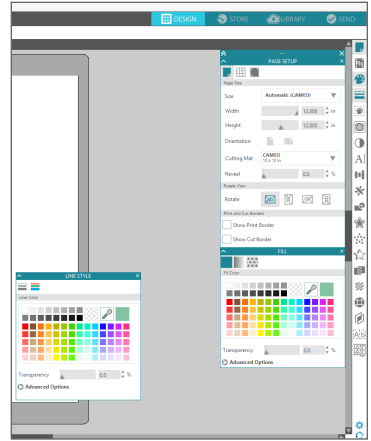
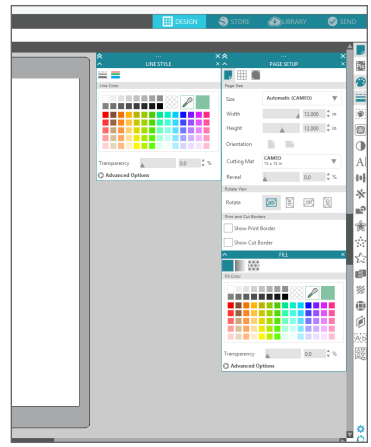

# Drawing Text

**A** To cut letters or words using any font on your computer, choose the Text tool from the toolbar on the left-hand side of the screen. With the Text tool selected, click anywhere on the page and begin typing.

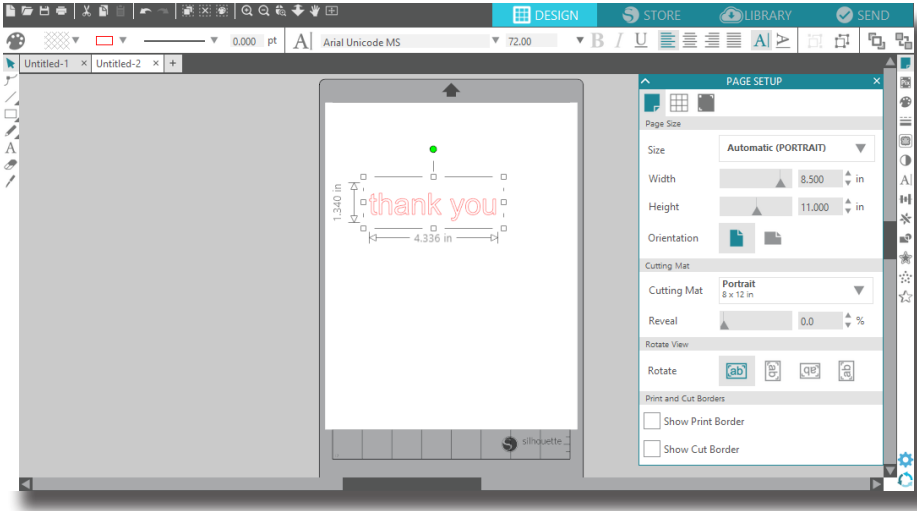

After clicking on the page with the Text tool, a blinking cursor will appear. Begin typing any letters, words, or phrases you choose.

While you are typing or editing text, the Text Style Panel will appear on the right-hand side of the screen. In this panel, you can change the font, text size, weight, justification, character spacing, and line spacing. Use the mouse to highlight your text before making adjustments to the font, size, weight, etc.

To finish typing your text, click anywhere off the page. This will end the text-editing mode and deselect the text. If you need to make a change to the text, double-click the text on the page using the Select Tool (found on the left-hand toolbar).

**To move your text** around the page, click and drag it to a new location.

**To resize your text**, select the text and then click and drag one of the corner control handles.

**To rotate your text**, select the text, then click and drag the green circle displayed above the object.

# Drawing Simple Shapes

Silhouette Studio® has built-in functions to draw simple shapes such as circles, squares, rectangles, lines, polygons, and freehand line art. Each of these tools can be found in the toolbar on the left-hand side of the Silhouette Studio® window.

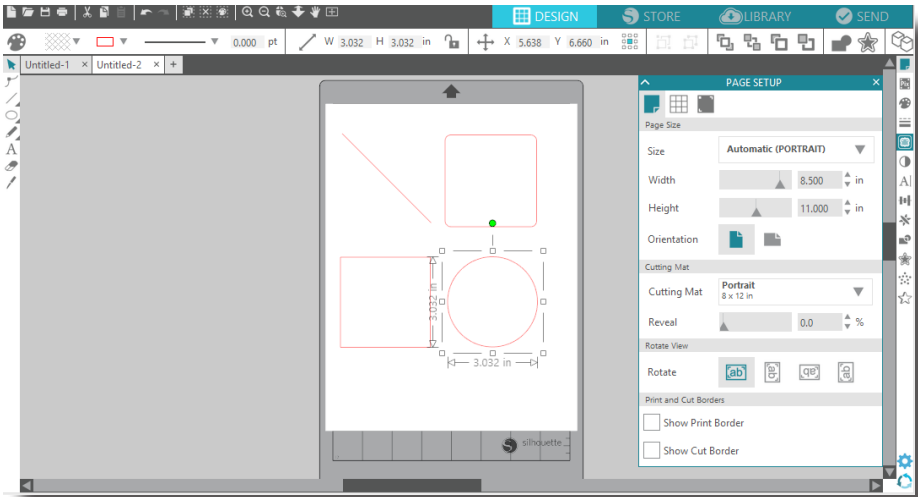

## Lines



To draw a line, choose the Line tool on the left-hand toolbar. Either click and drag with the mouse to draw a line, or click once to start a line and click a second time to end the line.

Hold SHIFT while creating a line to make a perfectly vertical, horizontal, or 45° line.

## Rectangles/Squares



To draw a rectangle, choose the Rectangle tool from the left-hand toolbar. Either click and drag with the mouse to draw a rectangle, or click once to set one corner and click a second time to set the opposite corner.

Hold SHIFT while creating a rectangle to make a perfect square.

Hold ALT (or OPTION on Mac®) to draw the rectangle from the center instead of one corner.

Hold SHIFT + ALT (or SHIFT + OPTION on Mac®) to draw a perfect square centered on your original click.



# Store Tab

The Silhouette Design Store contains thousands of designs, ranging from simple cutouts to intricate patterns and designs, to cut with your Silhouette. Most shapes are only 99¢. Generally, a free shape is posted every week as well.

To access the Silhouette Design Store, click the Store tab in the upper-right corner of the software.

The free design of the week will be displayed on the home page that appears.

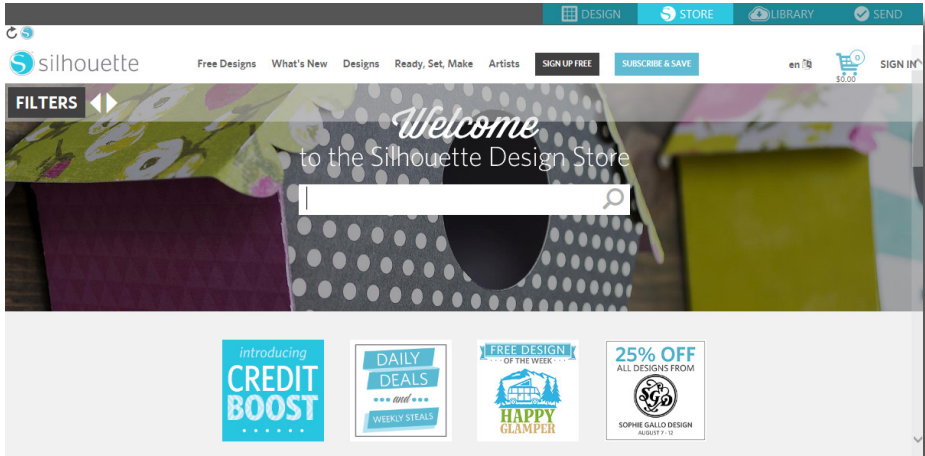

# Browsing for New Designs

The Silhouette Design Store works like any other web page and can be navigated by clicking on various links to browse new releases, popular designs, etc. The home page contains popular and new designs that you may be interested in.

For now, try downloading a free design by clicking this week's free design button on the home page or searching the Free Design tab.

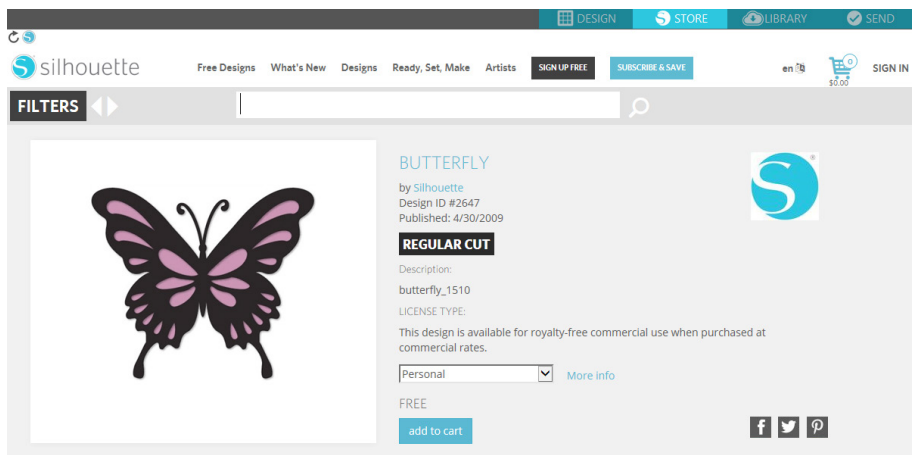

Click on the design in the search results to view details about the design.  
Click the Add to Cart button to add this free design to your shopping cart.



Locate the shopping cart icon in the upper right-hand corner of the window and click it to view your shopping cart. Your shopping cart total should be \$0.00.

Click the Checkout button to proceed. At this time the system will ask you to sign in before downloading. Creating a new account only takes a few seconds. Click the "Sign up FREE" link on the login page to create a new account.

# Creating an Account

Several different account types exist. Once you're more familiar with the Silhouette Design Store, you may wish to purchase a subscription and download dozens of designs each month.

The screenshot shows the 'CHOOSE YOUR SUBSCRIPTION' page on the Silhouette Design Store. The page features a navigation bar with 'DESIGN', 'STORE', and 'LIBRARY' tabs. Below the navigation bar, there are links for 'Free Designs', 'What's New', 'Designs', 'Ready, Set, Make', 'Artists', 'WISHLIST', and 'MY SUBSCRIPTION'. A search bar and a 'FILTERS' button are also visible. The main content area is titled 'CHOOSE YOUR SUBSCRIPTION' and displays three subscription plans: 'BASIC', 'DELUXE', and 'DIAMOND'. The 'BASIC' plan is highlighted with a blue arrow. The 'BASIC' plan details are: 12 Month length, \$9.99 per month, and features including 60 day credit rollover, Digital Silhouette Handbook, and \$0.40 average cost per download\*. The 'DELUXE' plan is \$25.00 per month. The 'DIAMOND' plan is not fully visible. A 'continue' button is located at the bottom right of the subscription selection area. A note at the bottom states: '\* Most downloads are \$0.99 per file. Pricing may vary due to promotions, and other discounts. Click here to compare all of the subscription plans.'

In order to create a free account and buy designs one at a time, choose the "Sign up FREE" option.

You will be asked for your name, email address, and password in order to create an account. Type your information and click the Sign Up button.

The screenshot shows the 'SIGN UP FOR A FREE ACCOUNT' page on the Silhouette Design Store. The page features a navigation bar with 'DESIGN', 'STORE', 'LIBRARY', and 'SEND' tabs. Below the navigation bar, there are links for 'Free Designs', 'What's New', 'Designs', 'Ready, Set, Make', 'Artists', 'SIGN UP FREE', and 'SUBSCRIBE & SAVE'. A search bar and a 'FILTERS' button are also visible. The main content area is titled 'SIGN UP FOR A FREE ACCOUNT' and contains a form for creating a free account. The form fields are: name (Jane Doe), email (jane@doe.net), password (masked with dots), confirm password (masked with dots), and country (United States). A 'Good' status indicator is shown next to the password field. A checkbox for 'Send me newsletters about new Silhouette products and information' is present. A 'Sign up' button is located at the bottom of the form.



Once your account is created, you will need to access your shopping cart again and try the checkout process once more. You will be asked to validate your password each time you download designs.

Type your password to authorize the download.

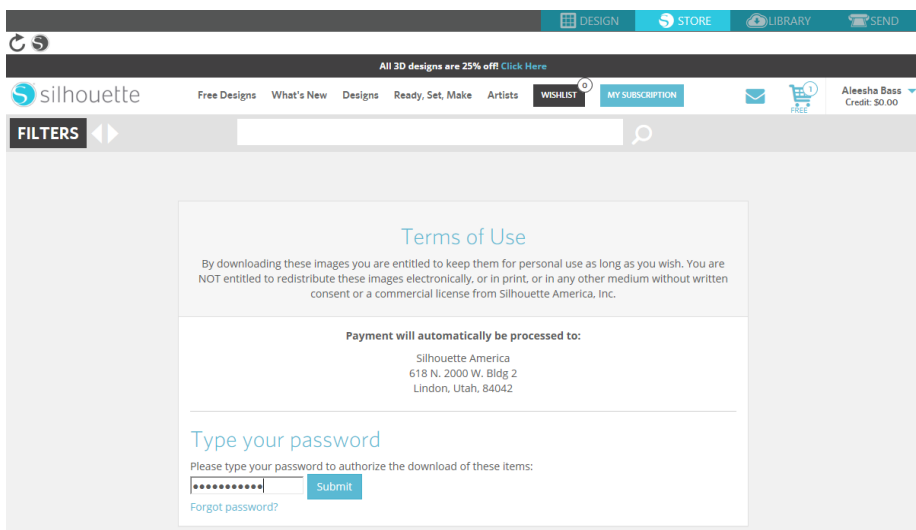

## Using Your Trial Subscription Card

If your Silhouette came with a trial subscription card, you may use it to purchase designs from the Silhouette Design Store. After registering your machine at [silhouetteamerica.com/setup](http://silhouetteamerica.com/setup), you will receive an email with a unique code that entitles you to a one-month Basic subscription to the Silhouette Design Store. Follow the directions within the email to activate your trial subscription and begin enjoying the Silhouette Design Store.

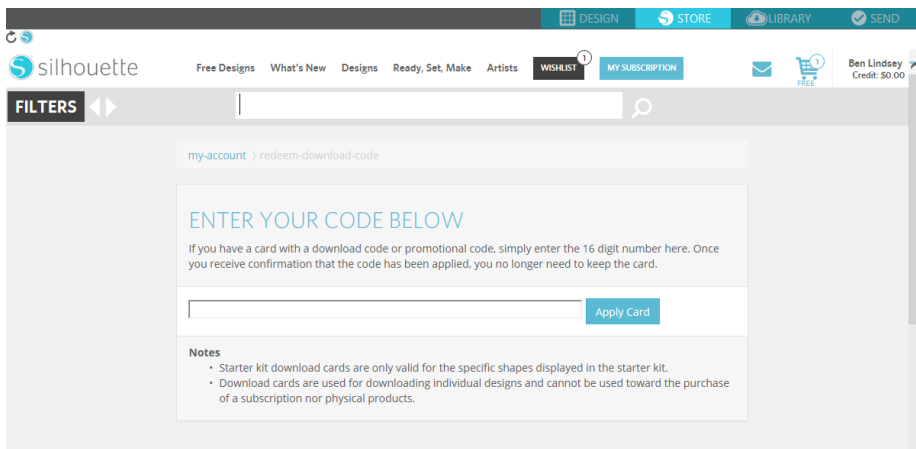

Your available subscription credits can be viewed in the upper right-hand corner of the screen below your name.

## Browsing Designs

Click the My Library button to view the Silhouette designs you have on your computer. Silhouette Studio® includes 50 free designs to help you get started. Connect your Portrait to your computer and power it on to get your 50 free designs.

Click the Show All Designs shortcut in the left panel of My Library to view all 50 designs included with your software.

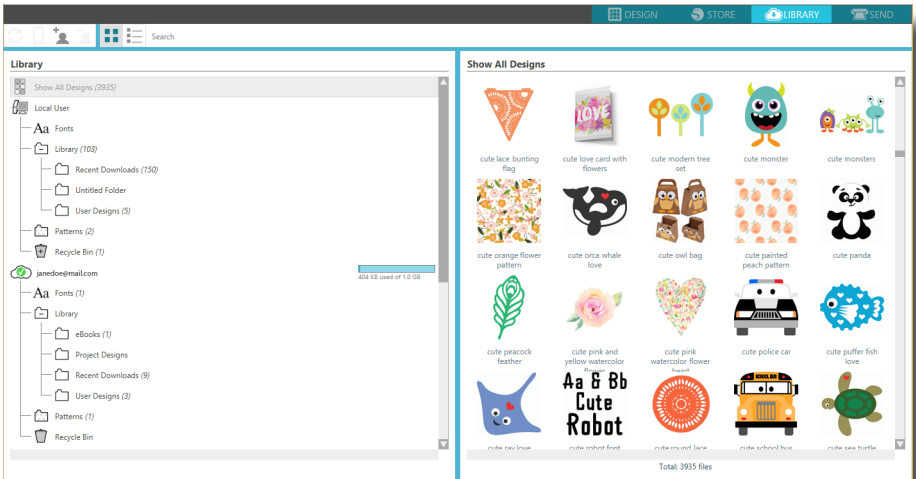

Click the icon next to the Library folder to expand the folder and view its contents. This folder initially contains the 50 free designs included.

Use the View as Icons button and View as List button near the top left-hand side of the window to change the view of your designs in the right panel. In the list view, you can sort by the file name,



design type, artist name, and date the design was downloaded.

# Organizing Designs

You can organize your designs within your Library for your convenience by creating new folders for your designs.

With the Library folder highlighted, right-click and select New Folder. Then type a name for your new folder.

Select the Library folder again to reveal the 50 designs you already have.

Drag any design from the right panel into your newly created folder in the Folders panel on the left. The numbers in parentheses next to each folder indicate how many shapes are included in each folder.

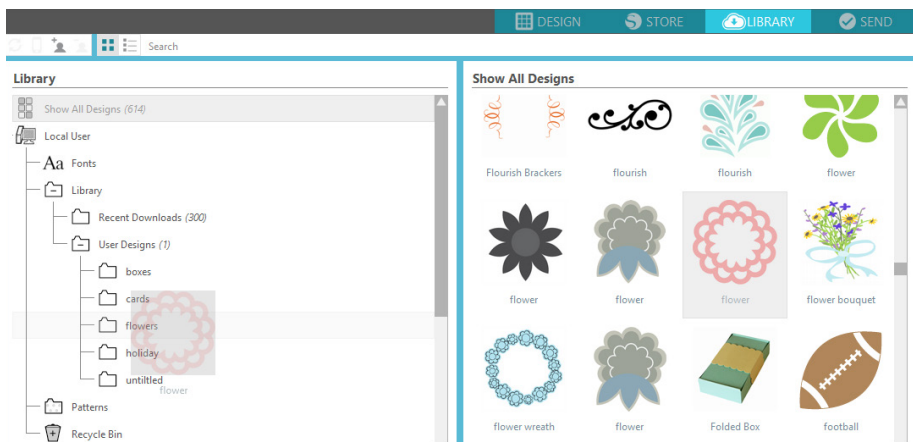

## Silhouette Cloud

Silhouette Cloud works hand in hand with Silhouette Studio® to keep all of your designs synced on multiple devices. You can sync up to five devices with your cloud account. If you aren't using multiple devices, Silhouette Cloud is useful in backing up your designs and preventing the need for recoveries.

In Silhouette Cloud, there is unlimited storage available for Silhouette Design Store downloads. There is 1 GB available for custom content. Club Silhouette Members receive 5 GB of storage for custom content.

To sync your files, drag them into the cloud icon in your Library folder. The software will prompt you to sign into the cloud with your Silhouette account. Once you sign in, your cloud will start syncing your designs.

Your cloud library will remain as its own folder in your Library. You have the option to save things under your Local User folder or into your cloud library, which is titled with your Silhouette Account email address. Files saved in your Local User folder will be available only from the device you are using.

# Searching Designs

At the top of the My Library window, you will find a Search box. Click in the text box and type a keyword to search your library of images. Search results will display in the right panel.

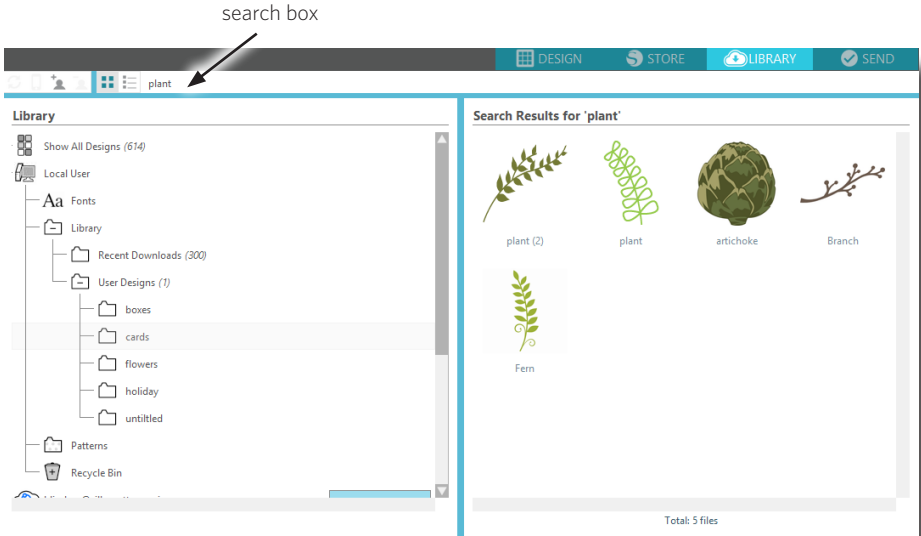

If you would like to view the keywords and description for a shape used for searching, right-click (or Control + Click on Mac®) and choose Show Properties. A window with details about the highlighted shape will appear. Shapes downloaded from the Silhouette Design Store will contain several keywords and a description or instructions.

## Using Designs in Library

Using the folders in Library, navigate to a design that you'd like to cut. Double-click the design to place it on your page in the software.

This will automatically close the Library tab, which can be easily reopened by clicking the Library tab again.

To close your Library without pasting a design, click any of the other tabs in the upper right-hand corner of the window.

# Cutting Your Design

## Preparing the Cutting Mat

Remove the nonstick liner from the cutting mat.

Position your paper or other media on the cutting mat according to the diagram shown in Silhouette Studio®.

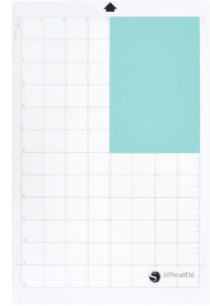
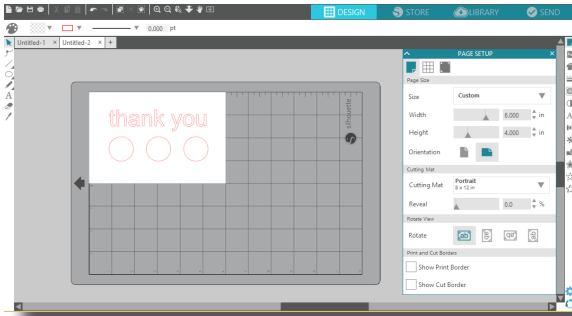
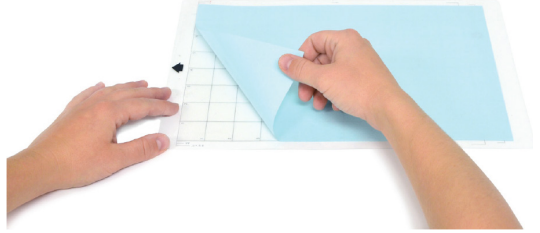

If you don't see an image of the cutting mat under your document on the screen, click the Page Setup button in the options toolbar in the upper right-hand corner of the window.

Position your image on the screen where you want it to cut on the mat. **Be sure to keep your design within the red margins on your page.**

## Preparing the Silhouette to Cut

Turn the Silhouette Portrait® on by pressing the Power button under the lid and waiting for the machine to start up. To feed a cutting mat into the Silhouette, center the mat between the white rollers and press the Load button.

blade adjustment socket

white rollers

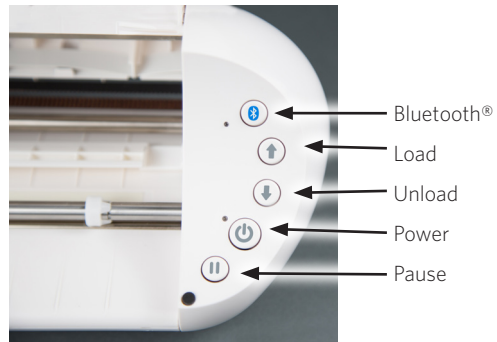
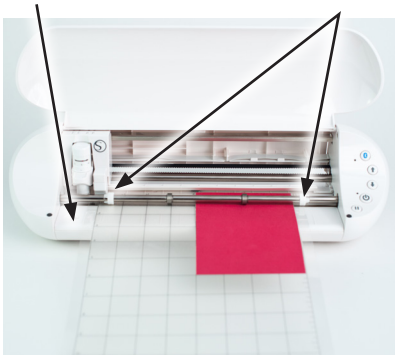



# Blades

Different styles of blades are adjusted by different methods. Instructions for adjusting alternate blade types will be included on the blade packaging. In all cases, higher blade settings expose more of the blade and are for cutting thicker materials. Refer to Silhouette Studio® for recommended blade settings for different materials.

Blade setting	Material
1	Thin materials, such as vinyl and smooth heat transfer material
2-3	Medium-weight materials, such as paper, cardstock, and flocked heat-transfer material
4-6	Thicker materials, such as textured cardstock and pattern papers
7-10	Thick materials, such as canvas

The AutoBlade can adjust automatically according to your software cut settings. To adjust the AutoBlade manually, insert the tip of the blade into the blade adjustment socket as shown. Gently press the AutoBlade up and down into the adjustment socket until the red indicator line points to the desired setting.

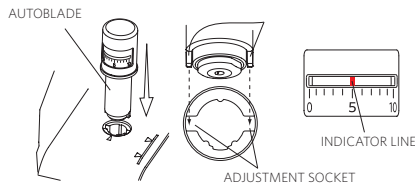

**WARNING:** The Silhouette blade is sharp. Handle the blade housing with care and do not touch the blade itself.

To load a tool into the carriage, unlock the tool holder by gently pulling on the tool holder. Place the tool into the tool holder and push the extended part back to secure the tool. Be sure the tool is pressed completely into the holder.

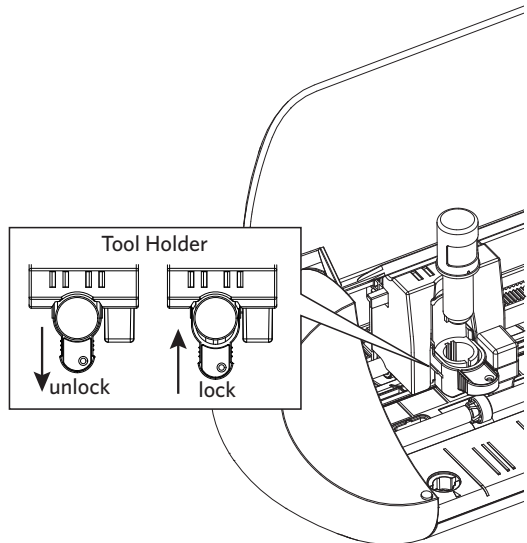

# Send Tab

The Send tab is very similar to Cut Settings of the past, but it is divided by actions. The Send tab was designed to streamline the cutting process and make cutting even easier.

There are four actions you can choose in the Send tab: Simple, Line, Fill, and Layer.

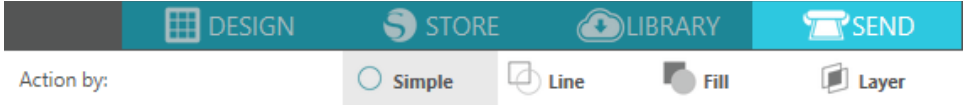

Each action allows you to adjust specific cut settings. Cutting is as easy as choosing your material, your action, and your blade in the Simple panel and clicking "Send."

The Send screen has two parts: the panel on the right-hand side and the screen displaying your design on the left. The panel on the right-hand side includes the action tabs as well as the action options. When you enter the Send tab, cut lines in your design will become thicker and bolder so you can see exactly what your Silhouette is going to cut.

If you want to make any adjustments to your design, you must go back to the Design screen by clicking on the Design tab. You can move your design while you are in the Send tab, but you cannot make any other adjustments to the design.

## The Action Options

The first option on the Action panel is the Simple tab. This is where you can select the material type, the action you want your Silhouette to perform, what kind of blade you are using, what lines you want to be cut, etched, scored, embossed, or stippled.

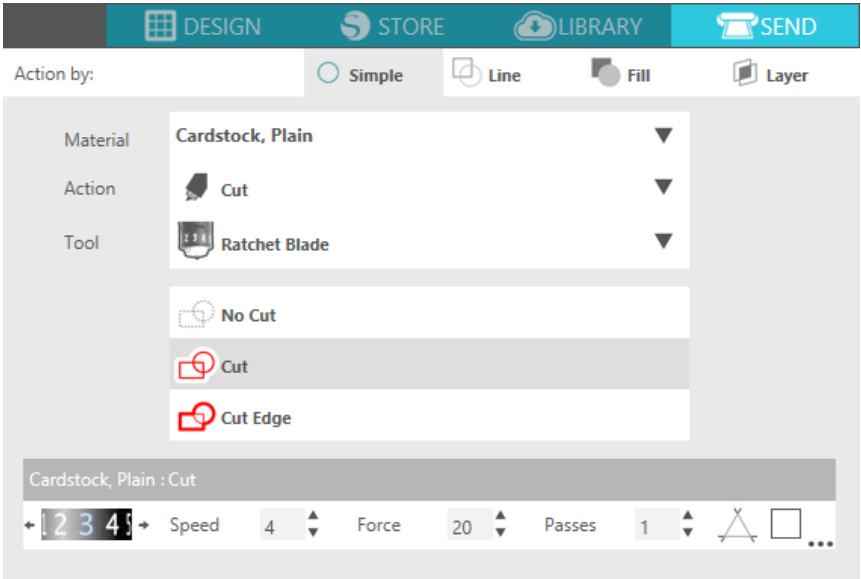

In this case, we have selected the “Cardstock, Plain.” If the material you are using isn’t there, click Add New Material Type at the bottom of the screen. You will have the ability to name the material and define the cut settings.

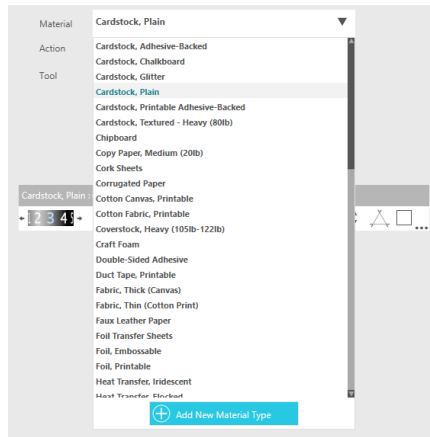

For more advanced settings, you can use the Line panel, the Fill panel, or the Layer panel. With the Line panel or the Fill panel, you can assign which task the Silhouette will do according to the image’s line color or fill color. If you have a design that has multiple layers, you can use the Layer panel to choose which layers to cut.

At the bottom of the send panel, there is an icon that looks like a graduation cap. Click on it to view brief tutorial steps if you would like a reminder of all of the things you must do before you make a cut. Before you make a cut, make sure you have done the following steps:

- ▶ Chose a material in the Material section.
- ▶ Adjusted any desired cut settings by using the Action tabs.
- ▶ Inserted your blade or tool into your machine and adjusted it according to the recommended settings in the Action panel.
- ▶ Loaded your material if it has its own backing or loaded your material placed on a cutting mat.

When you are ready, click Send. This will send your cut job to your Portrait.

# Bluetooth®

The Silhouette Portrait® is Bluetooth® compatible and allows wireless communication. The Silhouette Portrait® Bluetooth® Edition includes a preinstalled Bluetooth® adapter. For all other Portrait editions, Bluetooth® is enabled, but you will need to install a Bluetooth® adapter. The Bluetooth® resides in the bottom of the machine in a compartment accessible by a basic screwdriver.



Bluetooth® is off  
(or no Bluetooth® adapter present)



Bluetooth® is active  
but not connected



Bluetooth® is active  
and connected

To connect your Bluetooth® enabled Portrait 2, ensure that Bluetooth® is activated by pressing the Bluetooth® button on your Portrait. The LED light next to the Bluetooth® button should illuminate blue.

In Silhouette Studio®, go to the Send tab. Click on the Bluetooth® icon at the bottom of the panel and select "Add Bluetooth® machine." After a few seconds, the status of the Portrait will display as Ready in the Send panel, and the setup is complete. The LED light next to the Bluetooth® button should illuminate as purple.

# *Where to Find More Information*

## Complete Software Manual

View the complete, illustrated User's Manual within Silhouette Studio® by clicking Help -> User's Manual.

## Website

Visit the tutorials section of [www.silhouetteamerica.com](http://www.silhouetteamerica.com) for help with specific features and step-by-step instructions on how to cut different media types with the Silhouette Portrait®.

## Blog

Visit the official Silhouette blog at [blog.silhouetteamerica.com](http://blog.silhouetteamerica.com) for ideas of new projects you can create. Many blog posts contain step-by-step instructions for advanced uses of Silhouette products and software.

## Newsletter

Sign up for the Silhouette newsletter at [www.silhouetteamerica.com](http://www.silhouetteamerica.com) to receive product updates and special offers via email.

## Customer Service

If you have any further questions, feel free to contact customer service:

Silhouette America, Inc.  
[support@silhouetteamerica.com](mailto:support@silhouetteamerica.com)  
<https://www.silhouetteamerica.com/contact>