

**Add 10% to all prices  
in this price list**

2009 Price Guide

# glass top tables

---

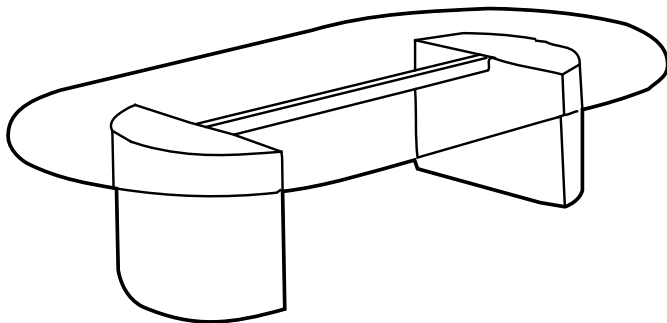
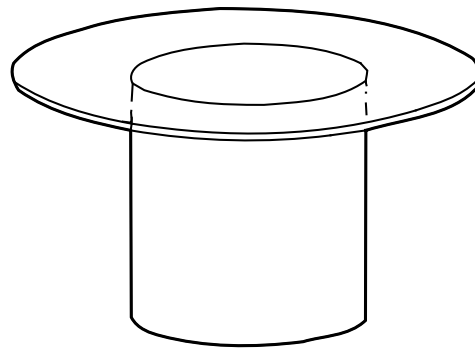
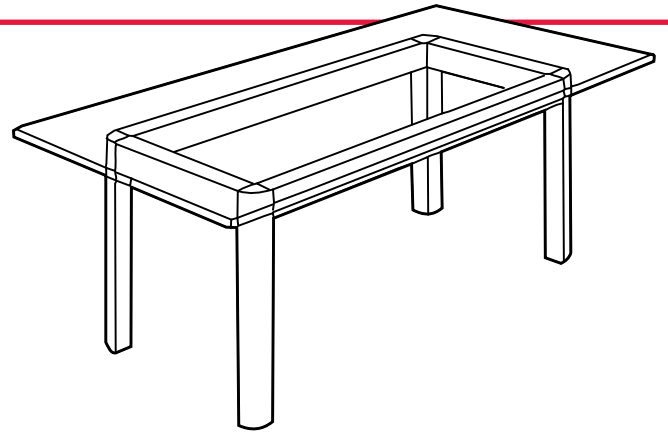

**arnoldkolax**

Arnold Kolax Furniture, Inc.

- Information for Ordering .....2
- Product Information .....3 – 4
- Condition of Sale .....4 – 5
- Furniture Quote Information .....6
- How to Specify .....7
- Glass Top Tables**
- Wood / Laminate Pedestal Bases .....8 – 9
- Wood / Laminate / Stone Bases .....10 – 11
- Dock Delivery Price List .....12
- Literature Request Form .....13

# arnoldkolax

Arnold Kolax Furniture, Inc.

**Manufacturer:** Arnold Kolax Furniture, Inc. • 609 Chancellor Avenue, Irvington, NJ 07111  
Tel 973-375-3344 • Fax 973-375-6024 • Toll Free 866-425-6529  
www.arnoldkolax.com • info@arnoldkolax.com

## General Information for Ordering:

---

- Point of Production:** Irvington, NJ (Essex County)
- Time of Delivery:** Approximately 8 weeks
- Expedited Delivery:** Some items in this catalog are available for expedited delivery. Call factory for information.
- Overnight and 2-day Delivery:** Not available.
- F.O.B. Point:** Irvington, New Jersey, Essex County
- Ordering Address:** Arnold Kolax Furniture, Inc., 609 Chancellor Avenue, Irvington, New Jersey 07111
- Payment Address:** Arnold Kolax Furniture, Inc., 609 Chancellor Avenue, Irvington, New Jersey 07111
- Terms and Conditions of Rental, Maintenance and Repair:** Call Factory
- Terms and Conditions of Installation:** Call Factory
- Terms and Conditions of Repair Parts:** Call Factory
- Service and Distribution Points:** Contact your local Arnold Kolax Furniture, Inc. representative for current listing of service and distribution points.
- List of Participating Dealers:** Contact your local Arnold Kolax Furniture, Inc. representative for current listing of authorized dealers in your area.
- Preventative Maintenance:** Contact factory for pamphlet.

## Product Information:

---

1. **Woods/  
Veneers:** All solid woods and veneers used on exterior surfaces are #A select grades. Plain sliced *American Walnut*, *White Oak*, *Maple*, and *Cherry*, applied in a “reverse slip match” fashion resulting in a balanced appearance, as well as slip match *Sapele* (Mahogany), are the standard veneers used. Anigre veneers are available at an upcharge. Every effort is made to match solid wood and veneer of like color and grain, however, since wood is a natural material, some variation in grain, color, and character may occur. This variation is not considered a defect.  
  
Arnold wood sample color chips are dated, and only chips dated with the current year should be used. If older samples are used, please send the sample used with the purchase order for proper color adjustment.
2. **About  
Woods:** Arnold Kolax Furniture would like to take this opportunity to point out to its customers several of the distinguishing characteristics that make wood such a unique material with beauty and charm:
  - No two trees are exactly alike, and as a result, natural variations in color and tone are to be expected.
  - Solid woods and veneers accept stain in varying degrees, thereby contributing to slight differences in shading.
  - Woods are highly susceptible to color changes from exposure to light, particularly from the ultraviolet rays. Cherry is extremely photo sensitive. It is recommended that the end user be instructed to avoid placing wood products in areas with prolonged exposure to direct sunlight. This will help to minimize, though not eliminate, color changes.
  - Properly maintained levels of humidity in the environment where the furniture is placed should also minimize instances of warping, checking, and cracking of veneers and solids. Fluctuations in humidity and temperature may cause panels and solid wood components to expand and contract, and may lead to panel warpage and finish checking or cracking. Prolonged exposure of furniture to dry heat during winter months should be avoided.

A minimum humidity level of 45% in climate controlled buildings is very important for the proper care of natural wood products.

**Note:** Due to the nature of Burl and Crotch veneers, the temperature and humidity of the environment into which the product is placed may cause changes to the face veneer. Arnold cannot be held responsible for checking and/or shrinkage that may occur over the course of time.
3. **Wood  
Finishes:** Arnold Kolax Furniture offers a substantial number of different stains on *White Oak*, *Walnut*, *Sapele* (Mahogany), *Cherry*, *Anigre* and *White Maple* solid woods and veneers. A “seven step” open pore finish is standard. It is a rich, lustrous, water and alcohol resistant, 40° satin sheen, multi-coat pre-catalized top coating applied over a “hand rubbed” wiping stain. Color consistency is maintained by constant comparisons to “control panels” at every step in the finishing process.
4. **Special  
Wood  
Finishes:** Arnold Kolax Furniture, Inc. provides its customers finish matching capability. Customer must submit a 3" x 3" sample of the finish to be matched.  
The amount of upcharge is based on the following criteria:
  - \$82.50 minimum on any special wood finish.
  - Color matching only of samples with open or closed pore finish: +15%
  - Color and texture match of closed pore finishes: + 25%
  - Closed pore finish (top surface only) on any Arnold standard wood stain: + 10%
  - Buffed/polished appearance: call factory.
  - Finish matching requiring bleaching will result in an additional charge. The factory reserves the right to make the final determination.
5. **Plastic  
Laminates:** Arnold Kolax Furniture offers both complete plastic laminate products and wood products with plastic laminate tops. In addition to the above, most products offered by Arnold Kolax Furniture are also available with laminate tops, at no additional charge, in any color or texture of your choice from Plonite, Nevamar, Formica, or Wilsonart.
6. **Natural  
Stones:** Marble and granite tops are available on selected Arnold Kolax Furniture products. They can be either inlaid or overlaid (no wood edge). Please refer to the individual product sections to determine which products are available with stone tops.  
  
Please note that not all granites are available on any given product; consult the introductory pages at the beginning of each section for availability.

**Product Information (cont'd.):**

<p><b>7. Finishes:</b></p>	<p><b>Wood Finish*</b></p> <p><i>Wood is a natural material and some variation in color grain and character may occur. This variation is not considered a defect.</i></p> <p><b>Walnut:</b>    #101 Royal Walnut        #105 Cappuccino Walnut                           #102 Cordovan Walnut    #106 Natural Walnut                           #104 Senator Walnut       #503 Ebonized Walnut</p> <p><b>Oak:</b>        #200 Natural Oak            #501 Ebonized Oak                           #201 Harvest Oak</p> <p><b>Mahogany:</b> #300 Mahogany            #303 Scarlet Mahogany                           #301 Cherry Mahogany</p> <p><b>Cherry:</b>    #400 Medium Cherry        #404 Red Cherry                           #401 Light Cherry           #406 Classic Cherry                           #402 Victorian Cherry      #408 English Cherry</p> <p><b>Maple:</b>     #700 Natural White Maple                           #701 Pearwood on Maple</p> <p><b>Anigre:</b>    #603 Light Anigre (available at an upcharge)</p> <p><b>Solid Color:</b> #900 White                #904 Earth                           #901 Black                    #905 Tangerine                           #902 Graphite                #906 Lime                           #903 Smoke Gray            #907 Misty Gray</p>	<p><b>Natural Stone***</b></p> <p><i>Marble and granite are natural materials and so some variations in pattern and color will exist within each slab, as well as from piece to piece.</i></p> <table border="0" style="width: 100%;"> <tr> <td style="vertical-align: top; width: 50%;"> <p><b>Marble:</b></p> <p>White Calacatta Gold (White)                  Jerusalem Gold Limestone (Gold)                  Light Emperador (Lt. Brown)                  Verde Oriental (Green)                  Rosso Levanto (Red)                  Dark Emperador (Dk. Brown)                  Botticino Semi-Classico (Beige)                  White Carrara (White)                  Crystal Salome (Gray/Burgundy)                  Negro Marquina (Black)                  Rosa Aurora (Rose/White)                  Spring Green (Green)</p> </td> <td style="vertical-align: top; width: 50%;"> <p><b>Granite:</b></p> <p>Dakota Mahogany (Red/Black)                  Ubatuba (Gold/Black)                  Blue Pearl (Black/Gray)                  Impala Black (Black/Gray)                  Black Galaxy (Black)                  Absolute Black (Black)                  Luna Pearl (Salt/Pepper)                  Rosa Porrina (Rose/Gray)</p> </td> </tr> </table>	<p><b>Marble:</b></p> <p>White Calacatta Gold (White)                  Jerusalem Gold Limestone (Gold)                  Light Emperador (Lt. Brown)                  Verde Oriental (Green)                  Rosso Levanto (Red)                  Dark Emperador (Dk. Brown)                  Botticino Semi-Classico (Beige)                  White Carrara (White)                  Crystal Salome (Gray/Burgundy)                  Negro Marquina (Black)                  Rosa Aurora (Rose/White)                  Spring Green (Green)</p>	<p><b>Granite:</b></p> <p>Dakota Mahogany (Red/Black)                  Ubatuba (Gold/Black)                  Blue Pearl (Black/Gray)                  Impala Black (Black/Gray)                  Black Galaxy (Black)                  Absolute Black (Black)                  Luna Pearl (Salt/Pepper)                  Rosa Porrina (Rose/Gray)</p>
<p><b>Marble:</b></p> <p>White Calacatta Gold (White)                  Jerusalem Gold Limestone (Gold)                  Light Emperador (Lt. Brown)                  Verde Oriental (Green)                  Rosso Levanto (Red)                  Dark Emperador (Dk. Brown)                  Botticino Semi-Classico (Beige)                  White Carrara (White)                  Crystal Salome (Gray/Burgundy)                  Negro Marquina (Black)                  Rosa Aurora (Rose/White)                  Spring Green (Green)</p>	<p><b>Granite:</b></p> <p>Dakota Mahogany (Red/Black)                  Ubatuba (Gold/Black)                  Blue Pearl (Black/Gray)                  Impala Black (Black/Gray)                  Black Galaxy (Black)                  Absolute Black (Black)                  Luna Pearl (Salt/Pepper)                  Rosa Porrina (Rose/Gray)</p>			

Please call factory for custom finish and/or stone availability. Available on coffee and end tables only.

When placing orders for products made by two or more Arnold Companies that are to be used in the same area, please indicate "finish together" on your purchase order, and verify our acknowledgement of this requirement.

- 8. **Special and Custom Items:** Arnold Kolax Furniture has the ability, through its flexible manufacturing policy, to produce custom library furniture, or modify any existing Arnold line to meet the user's requirements. Please submit your plans and specifications for a quotation. All sales on custom or specially modified items are final. A 50% deposit is required when the order is placed, whether or not credit is established with Arnold. These orders cannot be cancelled once the manufacturing process has started.
- 9. **Options/Accessories:** A variety of product options are available from Arnold Kolax Furniture including such value added items as refrigerators, computer support peripherals and a variety of Power, Data, and Voice grommets that allow the user to connect and conceal CRT and CPU hardware. The compatibility of individual options is noted on each page; a more detailed description of the option is at the back of the book.
- 10. **GSA** Arnold Kolax Furniture has been awarded several GSA (Government Services Administration) federal and state contracts. GSA price listed and state contract details and procedures are available on request and at our website.

**Condition of Sale:**

- 1. **Terms:** Net 30 days. All prices shown in this price list are list prices, FOB our factory Irvington, New Jersey. Prices are effective January 1, 2007 and are valid until superceded. This price list supercedes all previous Arnold Kolax Furniture price lists.  
  
**Ordering Information** — Order directly by mail, fax, telephone or email to Arnold Kolax Furniture as indicated on page 2 in this price list. Orders for merchandise from more than one Arnold Company may be sent to any one of the companies. Telephone orders must be confirmed by a purchase order. Duplicate orders received not marked "Confirmation" are the responsibility of the buyer.
- 2. **New Accounts:** Please include three satisfactory credit references, one bank reference, and a 50% deposit with your first order.
- 3. **Acknowledgements:** Upon credit approval, all orders will be acknowledged by Arnold Kolax Furniture. Acknowledgements indicate terms of sale, discount rate, buyer's representative, transportation company, approximate shipping date, merchandise ordered, freight cost if applicable, and our acknowledgement number. All prices are FOB factory, blanket wrapped, unless otherwise indicated. Please check the acknowledgement for accuracy, and call Arnold Kolax Furniture immediately in case of a question or discrepancy. Arnold Kolax Furniture will not be held responsible on orders placed on the phone without written confirmation.

**Condition of Sale (cont'd.):**

4. **Prices:** Prices are based on an order as written, and not necessarily on your inquiry or our original quotation. The prices as shown on the acknowledgment are final and will be invoiced on the date of shipment.
5. **Cancellation and/or Changes:** Orders are processed immediately upon receipt, and cancellations or changes can only be made with prior approval of Arnold Kolax Furniture. A cancellation charge of 10% will be incurred after a period of three working days. Cancellation of "Work in Progress" is subject to a 25% charge. Special orders, special finishes, "Quick Ship," and orders marked "Rush" cannot be cancelled. Cancellation of a standard unit after fabrication will incur a 50% charge.
6. **Shipping Delays:** Diligent effort will be made to ship orders for the date acknowledged. We cannot be held financially responsible for delays due to strikes, accidents, raw material shortages or other delays.
7. **Packing & Shipping:** Goods are carefully inspected and blanket wrapped or cartoned before being turned over to the transportation company.
8. **Damaged Material:** The goods are carefully inspected and in good condition when accepted by the carrier. If damage occurs, it is your responsibility to immediately notify the transportation company to make an inspection prior to discarding packaging material. If the packaging material is damaged, you must make this request upon receipt of the shipment. If the damage is concealed, you must make this request when the material is unpacked and save the packing materials.
9. **Manufacturing Defects:** Claims of a factory defect must be verified by a factory representative. Unauthorized deductions from our invoice will not be allowed.
10. **Generalities:** All Arnold Kolax Furniture products (if applicable) are shipped with heavy duty 1/4-20 tread adjustable nylon glides that permit perfect drawer and door alignment. A strip of wood (a skid strip) protecting the product during shipment must be removed before the glides can be adjusted to meet the contours of the floor. Multi-piece table tops are shipped with "level tights," that allow for perfectly flush alignment of tops.
11. **Product Changes:** Arnold Kolax Furniture reserves the right to make changes in design and construction or to discontinue products without prior notice.
12. **Warranty:** Arnold Kolax Furniture warrants to its initial customers that its products conform to specifications, drawings, samples, or other product descriptions furnished by Arnold Kolax Furniture, and are of good material and workmanship, free of manufacturing and factory defects, and will function properly under normal use and service for three years if installed by Arnold Kolax Furniture or an authorized Arnold dealer. However, natural variations in color and grain patterns occur in bent wood, solid wood, and veneers.
- The warranty set forth above does not apply to products modified, altered, or repaired by unauthorized personnel, or to products damaged during shipment or installation, or by accident, abuse, alteration, misuse, tampering, misapplication, negligence by others, improper repair or maintenance, fire and/or other casualty. This warranty does not apply to defects in components not manufactured by Arnold Kolax Furniture.
- It is expressly understood and agreed that the customer's sole and exclusive remedy for any and all losses or damages resulting from non-conforming goods, or from any other causes, shall be the repair or replacement of defective parts at the option of Arnold Kolax Furniture, and that Arnold Kolax Furniture shall not be liable for damages, for injury to persons or property, nor for replacement of the entire commercial unit, if repair or replacement of defective parts can reasonably render the unit conforming.
- SELLER MAKES NO OTHER WARRANTIES, EITHER EXPRESSED OR IMPLIED, AS TO ANY MATTER WHATSOEVER, AND ARNOLD KOLAX FURNITURE DISCLAIMS ANY WARRANTY OF MERCHANTABILITY OR FITNESS FOR A PARTICULAR USE OR PURPOSE.
- No officer, employee, or representative of Arnold Kolax Furniture has the authority to assume greater liability than that described above.

# Furniture Quote Information

Date: \_\_\_\_\_

When requesting a furniture quote, please provide Arnold Kolax Furniture the following information:

**General Information**

- Dealer Name \_\_\_\_\_
- Dealer Location \_\_\_\_\_
- Dealer Phone/Fax \_\_\_\_\_
- Project Name/Location \_\_\_\_\_

**Freight Information**

- Freight Address \_\_\_\_\_
- Dock Delivery/Inside Delivery (Freight Elevator) \_\_\_\_\_

**Product Information**

- Furniture Info \_\_\_\_\_
- Style # \_\_\_\_\_
- Color Finish \_\_\_\_\_
- Edge Detail \_\_\_\_\_
- Special Dimension Requirements \_\_\_\_\_
- Special Instructions \_\_\_\_\_

**Example:**  
**Dealer Name:** John Smith / Smith Interiors  
**Dealer Location:** 123 Main St., Anywhere, NY 10000  
**Phone/Fax/Email:** (p) 555-555-1234 (f) 555-555-9876  
**Project Name/Location:** Sunshine Library, Manhattan, New York  
**Freight Address:** Shipping to Farmingdale, NY 11735 Inside Delivery (Freight Elevator)  
**Furniture Info:** Round Top Cylinder Base & Racetrack Top Half Cylinder Bases  
**Style #:** GGTC-30-29 & GGRT-5430-22  
**Color Finish:** Standard Mahogany  
**Edge Detail:** Universal Edge

For assistance in preparing your quote request, please contact the office @ 973.375.3344

# How to Specify

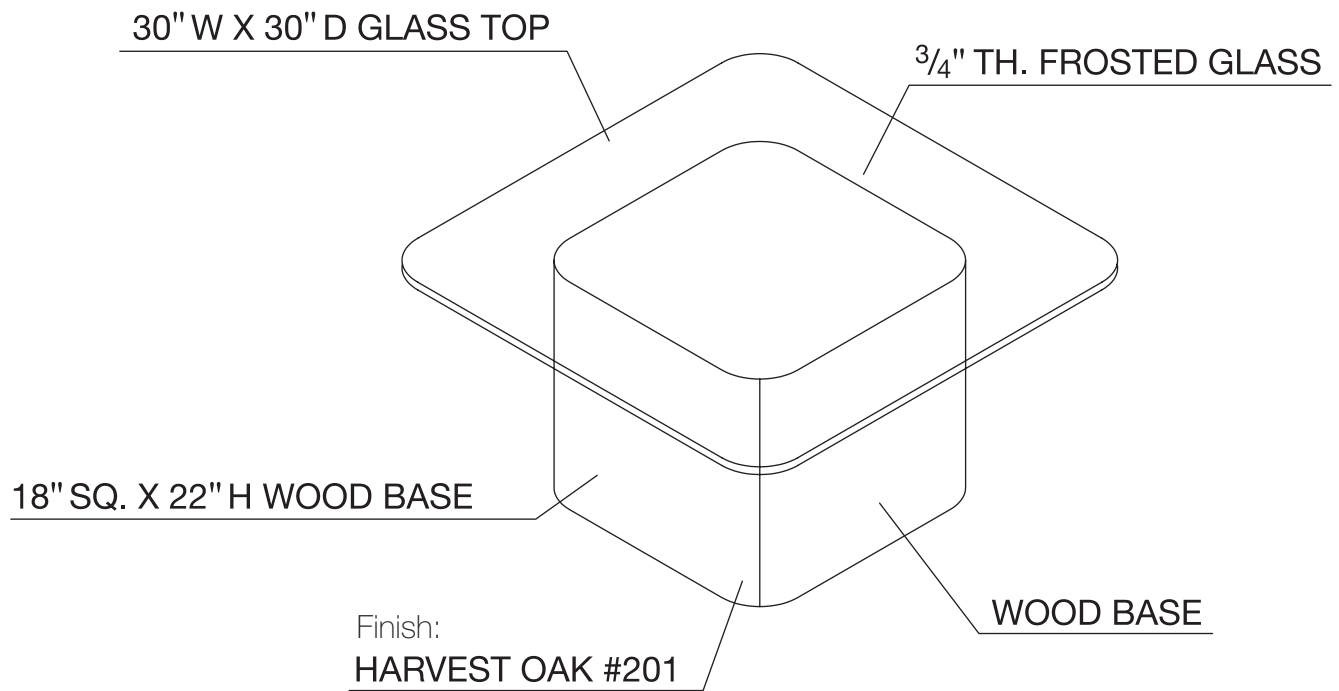



# Conference Tables

## WOOD / LAMINATE PEDESTAL BASES

Tops are .5" thick clear glass with polished edges

Style Number	Top (w x d)	OA Height	Wood Veneer	Standard Laminate	Ship Weight	Options
GGTC-30-29	30" dia.	29"	\$1182	\$1114	118	<b>3/4" thick clear glass:</b> 30-36" dia. + \$200. 42-48" dia. + \$300. 60" dia. + \$600. <b>1/2" thick smoked glass:</b> 30-36" dia. + \$100. 42-48" dia. + \$150. 60" dia. + \$300. <b>1/2" thick sandblasted glass:</b> 30-36" dia. + \$150. 42-48" dia. + \$200. 60" dia. + \$400. <b>Diamond pattern top:</b> + \$199. <b>Configured edge with reveal:</b> + \$399. <b>Contrasting configured edge with reveal:</b> + \$492. <b>Reveal only:</b> + \$176. <b>Recessed base:</b> + \$109.
GGTC-36-29	36" dia.	29"	1226	1158	120	
GGTC-42-29	42" dia.	29"	1455	1373	122	
GGTC-48-29	48" dia.	29"	1592	1511	128	
GGTC-60-29	60" dia.	29"	2950	2831	180	

### Round Top Cylinder Base

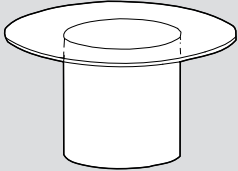

30-36" tops have 16" dia. bases;  
 42-48" tops have 18" dia. bases;  
 60" tops have 27" dia. bases.

All bases are weighted.

### Racetrack Top Half Cylinder Bases

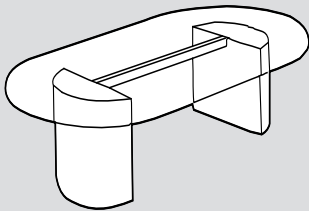

Half cylinders bases connected by chrome, brass or wood to match rail, please specify.

48" tops have 12" dia. bases;  
 54-60" tops have 16" bases;  
 72" tops have 18" dia. bases.

GGRT-4824-29	48 x 24"	29"	\$1823	\$1726	138	<b>3/4" thick clear glass:</b> 48" wide + \$200. 54-60" wide + \$300. 72" wide + \$400. <b>1/2" smoked glass:</b> 48" wide + \$100. 54-60" wide + \$150. 72" wide + \$200. <b>1/2" thick sandblasted glass:</b> 48" wide + \$150. 54-60" wide + \$200. 72" wide + \$300. <b>Configured edge with reveal:</b> 16"-18" dia. + \$599. <b>Contrasting config. edge with reveal:</b> 16-18" dia. + \$738. <b>Reveals only:</b> + \$264. <b>Recessed bases:</b> + \$164.
GGRT-5430-29	54 x 30"	29"	2076	2046	142	
GGRT-6030-29	60 x 30"	29"	2120	2080	149	
GGRT-7236-29	72 x 36"	29"	2539	2417	159	

# Conference Tables

## WOOD / LAMINATE PEDESTAL BASES

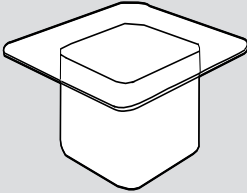
	Style Number	Top (w x d)	OA Height	Wood Veneer	Standard Laminate	Ship Weight	Options
<b>RC Square Top RC Cube Base</b>  	GGRC-2424-29	24 x 24"	29"	\$1414	\$1342	93	<b>3/4" thick clear glass:</b> 24-36" sq. + \$200. 42-48" sq. + \$250. <b>1/2" thick smoked glass:</b> 24-36" sq. + \$100. 42-48" sq. + \$150. <b>1/2" thick sandblasted glass:</b> 24-36" sq. + \$150. 42-48" sq. + \$200. <b>Configured edge with reveal:</b> 18" sq. + \$399. <b>Contrasting configure edge with reveal:</b> 18" sq. + \$596. <b>Reveal only:</b> + \$160. <b>Recessed base:</b> + \$216.
	GGRC-3030-29	30 x 30"	29"	1458	1386	96	
	GGRC-3636-29	36 x 36"	29"	1480	1408	99	
	GGRC-4242-29	42 x 42"	29"	1634	1562	102	
	GGRC-4848-29	48 x 48"	29"	1771	1700	105	
Tops and bases have 3" radius corners.  24" tops have 12" sq. base; 30-48" tops have 18" sq. base.							

**Bases:**

**Wood Veneers:** See pages 3 and 4 for veneers and finishes available.

**Standard Laminates** include any solid matte color or wood pattern from Formica, Nevamar, or Wilsonart.

**Contact Factory For:**

- Custom glass conference tables
- Custom metal bases
- Back painted glass

# Occasional Tables

## WOOD / LAMINATE / STONE BASES

Tops are .5" thick clear glass with polished edges

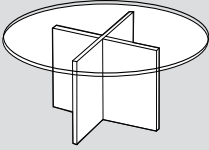
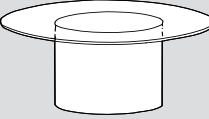
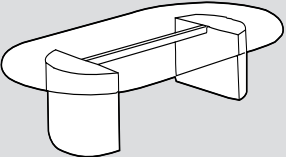
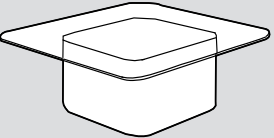
	Style Number	Top	OA Height	Marble	Granite	Ship Weight	Options
	GGST-30-16	30" dia.	16"	\$1532	\$1430	155	<b>3/4" thick clear glass:</b> 30-36" dia. + \$220. 42-48" dia. + \$330. <b>1/2" smoked glass:</b> 30-36" dia. + \$110. 42-48" dia. + \$165. <b>1/2" Sandblasted glass:</b> 30-36" dia. + \$165. 42-48" dia. + \$220.
	GGST-30-22	30" dia.	22"	1939	1780	190	
	GGST-36-16	36" dia.	16"	1621	1520	165	
	GGST-36-22	36" dia.	22"	2028	1869	200	
	GGST-42-16	42" dia.	16"	1722	1621	175	
	GGST-42-22	42" dia.	22"	2128	1971	210	
	GGST-48-16	48" dia.	16"	1833	1732	185	
	GGST-48-22	48" dia.	22"	2240	2082	220	
 <p>30-36" tops have 16" dia. bases; 42-48" tops have 18" dia. bases.</p>				<b>Wood Veneer</b>	<b>Standard Laminate</b>		
	GGTC-30-16	30" dia.	16"	\$834	\$779	90	<b>3/4" thick clear glass:</b> 30-36" dia. + \$220. 42-48" dia. + \$330. <b>1/2" smoked glass:</b> 30-36" dia. + \$110. 42-48" dia. + \$165. <b>1/2" sandblasted glass:</b> 30-36" dia. + \$165. 42-48" dia. + \$220. <b>Diamond pattern top:</b> + \$219. <b>Configured edge w/reveal:</b> + \$439. <b>Contrasting configured edge with reveal:</b> + \$542. <b>Reveal only:</b> + \$160. <b>Recessed base:</b> + \$99.
	GGTC-30-22	30" dia.	22"	891	831	93	
	GGTC-36-16	36" dia.	16"	923	868	92	
	GGTC-36-22	36" dia.	22"	981	820	95	
	GGTC-42-10	42" dia.	16"	1082	1018	94	
	GGTC-42-22	42" dia.	22"	1136	1073	97	
	GGTC-48-16	48" dia.	16"	1193	1129	98	
GGTC-48-22	48" dia.	22"	1247	1184	103		
 <p>Half cylinder bases connected by chrome, brass, or wood rail. Please specify. 48" tops have 12" dia. bases; 54-60" tops have 16" dia. bases; 72" tops have 18" dia. bases.</p>		<b>(w x d)</b>					
	GGRT-4824-16	48 x 24"	16"	\$1529	\$1458	130	<b>3/4" thick clear glass:</b> 48" wide + \$220. 54-60" wide + \$330. 72" wide + \$440. <b>1/2" smoked glass:</b> 48" wide + \$110. 54-60" wide + \$165. 72" wide + \$220. <b>1/2" sandblasted glass:</b> 48" dia. + \$165. 54-60" dia. + \$220. 72" dia. + \$330. <b>Configured edge w/reveal:</b> + \$659. <b>Contrasting configured edge with reveal:</b> + \$812.
	GGRT-4824-22	48 x 24"	22"	1539	1430	133	
	GGRT-5430-16	54 x 30"	16"	1758	1687	134	
	GGRT-5430-22	54 x 30"	22"	1855	1759	137	
	GGRT-6030-16	60 x 30"	16"	1813	1731	140	
	GGRT-6030-22	60 x 30"	22"	1899	1809	144	
	GGRT-7236-16	72 x 36"	16"	2138	2042	150	
GGRT-7236-22	72 x 36"	22"	2219	2125	154		
 <p>Tops and bases have 3" radius corners. 24" tops have 12" sq. base; 30-48" tops have 18" sq. base.</p>	GGRC-2424-16	24 x 24"	16"	\$989	\$953	85	<b>3/4" thick clear glass:</b> 24-36" sq. + \$220. 42-48" sq. + \$275. <b>1/2" smoked glass:</b> 24-36" sq. + \$110. 42-48" sq. + \$165. <b>1/2" sandblasted glass:</b> 24-36" sq. + \$165. 42-48" sq. + \$220. <b>Configured edge w/reveal:</b> + \$439. <b>Cont. conf. edge w/reveal:</b> + \$542. <b>Reveal only:</b> + \$160. <b>Recessed base:</b> + \$196.
	GGRC-2424-22	24 x 24"	22"	1067	1023	88	
	GGRC-3030-16	30 x 30"	16"	1055	1017	88	
	GGRC-3030-22	30 x 30"	22"	1131	1087	91	
	GGRC-3636-16	36 x 36"	16"	1120	1081	91	
	GGRC-3636-22	36 x 36"	22"	1195	1151	94	
	GGRC-4242-16	42 x 42"	16"	1208	1169	94	
	GGRC-4242-22	42 x 42"	22"	1283	1236	97	
GGRC-4848-16	48 x 48"	16"	1295	1256	97		
GGRC-4848-22	48 x 48"	22"	1370	1319	100		

# Occasional Tables

WOOD / LAMINATE / STONE BASES

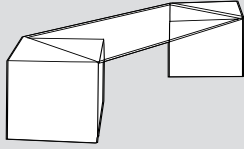
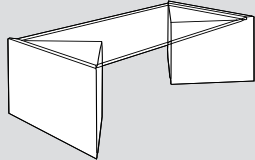
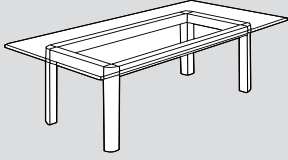
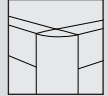
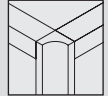
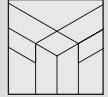
	Style Number	Top (w x d)	OA Height	Wood Veneer	Standard Laminate	Ship Weight	Options	
<b>Rectangular Top Cube Bases</b>  48" tables have 36" wide glass. 60" tables have 48" wide glass. Cube bases are 17 x 17".	GGTC-4824-15	48 x 24"	15"	\$1019	\$1010	114	<b>3/4" thick clear glass:</b> 36" wide + \$165. 48" wide + \$220. <b>1/2" smoked glass:</b> 36" wide + \$83. 48" wide + \$110. <b>1/2" sandblasted glass:</b> 36" wide + \$110. 48" wide + \$165. <b>Reveals only:</b> + \$416.	
	GGTC-4824-21	48 x 24"	21"	1098	1044	134		
	GGTC-6024-15	60 x 24"	15"	1188	1219	128		
	GGTC-6024-21	60 x 24"	21"	1264	1221	148		
<b>Rectangular Top Triangle Bases</b>  38" tables have 36" wide glass. 50" tables have 48" wide glass. Triangle bases are 17 x 17 x 24".	GGTC-3824-15	38 x 24"	15"	\$1133	\$1122	82		
	GGTC-3824-21	38 x 24"	21"	1319	1265	102		
	GGTC-5024-15	50 x 24"	15"	1410	1367	96		
	GGTC-5024-21	50 x 24"	21"	1534	1553	116		
<b>Rectangular Top Baron Base</b>  Specify edge detail B, C or D for base as suffix to style number. <div style="display: flex; flex-direction: column; gap: 10px;"> <div>  <p><b>Edge B</b> Convex Verticals</p> </div> <div>  <p><b>Edge C</b> Concave</p> </div> <div>  <p><b>Edge D</b> Square</p> </div> </div>				<b>Solid Wood</b>				<b>Optional shelf:</b> 18-24" sq. + \$157. 30-36" sq. + \$178. 42" sq. + \$219. 54-60 x 30"+ \$271.
	GGBT_-1818-16	18 x 18"	16"	\$1028		44		
	GGBT_-1818-22	18 x 18"	22"	1055		45		
	GGBT_-2418-16	24 x 18"	16"	1048		48		
	GGBT_-2418-22	24 x 18"	22"	1076		49		
	GGBT_-2424-16	24 x 24"	16"	1070		59		
	GGBT_-2424-22	24 x 24"	22"	1096		63		
	GGBT_-3030-16	30 x 30"	16"	1117		83		
	GGBT_-3030-22	30 x 30"	22"	1144		86		
	GGBT_-3618-16	36 x 18"	16"	1096		65		
	GGBT_-3618-22	36 x 18"	22"	1122		67		
	GGBT_-3636-16	36 x 36"	16"	1148		104		
	GGBT_-3636-22	36 x 36"	22"	1183		107		
	GGBT_-4242-16	42 x 42"	16"	1243		128		
	GGBT_-4242-22	42 x 42"	22"	1264		131		
	GGBT_-4824-16	48 x 24"	16"	1217		103		
	GGBT_-4824-22	48 x 24"	22"	1243		106		
	GGBT_-5430-16	54 x 30"	16"	1226		123		
	GGBT_-5430-22	54 x 30"	22"	1254		126		
	GGBT_-6030-16	60 x 30"	16"	1282		141		
GGBT_-6030-22	60 x 30"	22"	1333		144			

**Bases:**

**Wood Veneers:** see pages 3 and 4 for veneers and finishes available.

**Standard Laminates** include any solid matte color or wood pattern from Formica, Nevamar, or Wilsonart.

**Other Laminates** include gloss, grid, sparkle, or dimensional laminates and all other laminate brands.

**Chrome or brass** are chrome or brass laminates. **Gloss Colors** are available. Consult factory for pricing.

# Dock Delivery Price List

## *For Arnold Kolax Furniture*

**ORDERS OVER \$25,000 LIST CALL THE FACTORY**

**ZONE ONE**

NORTHERN NEW JERSEY,  
MANHATTAN, BRONX, QUEENS,  
STATEN ISLAND & BROOKLYN

**3.5% OF FURNITURE LIST PRICE  
IS THE NET FREIGHT COST  
MINIMUM \$125**

**ZONE TWO**

FAIRFIELD, CT.  
WESTCHESTER, ROCKLAND,  
NASSAU COUNTIES, NY,  
SUFFOLK COUNTY,  
SOUTHERN NEW JERSEY

**4% OF FURNITURE LIST PRICE  
IS THE NET FREIGHT COST  
MINIMUM \$175**

**ZONE THREE**

NEW HAVEN, HARTFORD, CT,  
PHILADELPHIA & PA EAST OF HARRISBURG

**5% OF FURNITURE LIST PRICE  
IS THE NET FREIGHT COST  
MINIMUM \$190**

**ZONE FOUR**

RHODE ISLAND,  
PA WEST OF HARRISBURG,  
UPSTATE NEW YORK, DELAWARE, MARYLAND  
WASHINGTON DC, BOSTON &  
MASSACHUSETTS

**5.5% OF FURNITURE LIST PRICE  
IS THE NET FREIGHT COST  
MINIMUM \$225**

**FOR DESTINATIONS NOT SHOWN  
OR FOR INSIDE DELIVERY AND INSTALLATIONS  
PLEASE CALL FACTORY**

Prices shown above represent non-union, straight time delivery.

Crating charges are included in the price.

Product may arrive blanket wrapped or crated.

It is the customers responsibility to make sure that furniture can fit in building and elevator.

Allow 6-8 days additional to acknowledged shipping date for delivery.

Upcharges will be assessed for the following:

- overtime delivery
- union requirements
- carry-up of furniture
- moving of existing furniture
- attempted delivery
- masonite coverage on floors
- disassembly of furniture for narrow doorways or elevators
- special insurance requirements
- over-sized desk (wider than 96")

*Due to the uncertainty of energy prices a fuel surcharge may be applicable. Please check our web site for up to date freight information.*



**Phone 973-375-3344**  
**Toll Free 866-425-6529**  
**Fax 973-375-6024**  
**[arnoldkolax.com](http://arnoldkolax.com)**

**arnoldkolax**

Arnold Kolax Furniture, Inc.

Arnold Kolax Furniture, Inc.  
609 Chancellor Avenue • Irvington, NJ 07111