



God Uses Daniel to Interpret the King's Dream

Daniel 2



LESSON GOAL

Students will be either warned or comforted by God's sovereign plan for human history.

LESSON OBJECTIVES

Students will be able to

- Summarize Daniel's life up to the beginning of Daniel 2.
- Explain what Nebuchadnezzar wanted his magicians to do.
- Describe how Daniel found out Nebuchadnezzar's dream.
- Tell what Nebuchadnezzar saw in his dream and what it meant.

KEY VERSE

"And in the days of these kings the God of heaven will set up a kingdom which shall never be destroyed; and the kingdom shall not be left to other people; it shall break in pieces and consume all these kingdoms, and it shall stand forever" (Daniel 2:44).

APPLICATION

- Trust that God controls human history.
- Repent before God's kingdom comes.
- Rejoice that God's kingdom is coming.

NEXT WEEK

God Protects Daniel's Friends
Read Daniel 3.

Symbol Key



Craft



Memory Verse



Object Lesson



Game



Visual Aid



Activity



Q & A



Work Sheet



2 Grade Level

Teacher Planning Sheet

PREPARE

Objectives/Truths to cover this week

- _____
- _____
- _____
- _____
- _____

Personal Application

As a result of my study in this passage, God wants me to

- _____
- _____
- _____

Three ways students need to apply this passage are

- _____
- _____
- _____

Materials Needed

POINT

Choose from various ideas to point students to the coming Bible lesson.

- _____
- _____

PROCLAIM

Choose from various ideas to proclaim the Bible lesson.

Presentation Ideas

- _____
- _____

Praise/Music Ideas

- _____
- _____
- _____

PRACTICE

Choose ideas to help review and apply today's lesson.

- _____
- _____

PREPARE WITH THE TRUTH

"Therefore you shall lay up these words of mine in your heart and in your soul....You shall teach them to your children" (Deuteronomy 11:18–19).

Please take time to prepare your mind and heart to accurately handle the truths of God's Word (2 Tim. 2:15). Read through the Bible background and study the truths contained in this lesson. Crucial background information is included here to aid you in understanding the Scripture.

Bible Background

Nebuchadnezzar Demands an Explanation (Daniel 2:1–13)

Daniel's first three years in Babylon had been intense. Because he was "good-looking, gifted in all wisdom, possessing knowledge and quick to understand" (Dan. 1:4), Daniel, along with Hananiah, Mishael, and Azariah, was chosen for three years of training in "the language and literature of the Chaldeans" (Dan. 1:4). While they were being trained for the king's service, these young men were given food and wine from the king's table. "But Daniel purposed in his heart that he would not defile himself" with the food (1:8), probably because the meat had come from unclean animals. Daniel chose to disobey the king rather than disobey God. God honored Daniel's obedience by giving him favor with the chief of the eunuchs. After 10 days of eating vegetables and drinking water, Daniel and his friends looked healthier than the men who were eating from the king's table (1:15). No longer required to eat the meat, Daniel and his friends were also blessed by God with "knowledge and skill in all literature and wisdom" (1:17). At the end of the training period, Nebuchadnezzar was more impressed by Daniel, Hananiah, Mishael, and Azariah than by the others who had been trained. The king chose these four men to serve before him (1:19).

Before this time of training had ended, Daniel, Hananiah, Mishael, and Azariah faced another crisis. King Nebuchadnezzar had commanded their execution! King Nebuchadnezzar had a disturbing dream that prevented his falling back asleep (Dan. 2:1). He called for "the magicians, the astrologers, the sorcerers, and the Chaldeans to tell the king his dreams" (2:2). The king wanted not only an interpretation of the dream, but also for the men to tell the dream to him (2:5). The king knew that if they could tell him the dream, then he could trust their interpretation of it (2:9). Showing how futile their magic was, the magicians and sorcerers protested the king's request. They complained that only a god could know the king's dream (2:10–11). Nebuchadnezzar became furious and commanded that all the wise men be destroyed (2:12). This death sentence included Daniel and his companions.

God Reveals the Explanation (Daniel 2:14–23)

Daniel never doubted God could reveal Nebuchadnezzar's dream. After finding out the reason for the death sentence and asking the king to grant them some more time, Daniel and his friends prayed for "mercies from the God of heaven concerning this secret, so that Daniel and his companions might not perish with the rest of the wise men of Babylon" (Dan. 2:18). When God revealed the dream and its meaning to Daniel, Daniel praised God (2:19). He praised Him for being the sovereign God who "changes the times and the seasons" and who "removes kings and raises up kings" (2:21). He also praised God for knowing what is

unknowable and revealing it to man (2:22). In verse 23, Daniel specifically thanked God for answering their prayer. God had glorified Himself by answering the request of His faithful servants.

Daniel Shares the Explanation (Daniel 2:24–45)

When he went to tell the king his dream, Daniel took no credit for himself. Daniel said, “The wise men, the astrologers, the magicians, and the soothsayers cannot declare to the king [his dream]....But there is a God in heaven who reveals secrets” (Dan. 2:27). The God who reveals secrets had given Nebuchadnezzar the initial dream (2:29) and then revealed the secret to Daniel (2:30). Daniel humbly made clear that it was not because he was wiser than anyone else that the dream and its meaning were revealed to him (2:30).

The dream consisted of two parts. The first involved a statue (Dan. 2:31–33), and the second involved a rock (2:34–35). The impressive statue was made from various materials: the head was gold, the arms and torso were silver, the belly and thighs were bronze, the legs were iron, and the feet were of iron and clay. The materials decreased in value from top to bottom. The rock was more impressive than the statue. The rock, which had a supernatural origin (having been “cut out without hands”; 2:34), smashed the clay and iron feet, leading to the disintegration of the entire statue. The rock “became a great mountain and filled the whole earth” (2:35).

Having told the king the dream, Daniel next explained what it meant (Dan. 2:36). Before revealing that Nebuchadnezzar was the head of gold, Daniel emphasized that the God of heaven had given to Nebuchadnezzar his “kingdom, power, strength, and glory” (2:37). Daniel explained that after the Babylonian kingdom, an inferior kingdom (represented by the silver) would arise (2:38). History reveals that this was the Medo-Persian kingdom led by Cyrus the Great. The bronze belly and thighs represented the third kingdom, Greece, which would rule over the civilized world (2:39). The fourth kingdom was represented by the iron legs. Like iron, this powerful kingdom “shatters everything” and “will break in pieces and crush all the others” (2:40). This fourth kingdom was Rome. The toes of clay and iron represented a future, still unrealized, manifestation of Rome. The toes were composed of clay and iron because the “kingdom shall be divided” (2:41). Although the kingdom will be as strong as iron, it will be as fragile as clay (2:42). This revived Roman empire will consist of 10 kingdoms (7:24), which will exist until “the God of heaven will set up a kingdom which shall never be destroyed” (2:44). At Christ’s second coming, the confederation of kings will be destroyed and Christ will reign forever (2:44). Having finished his interpretation of the dream, Daniel emphasized the certainty of the future fulfillment: “The great God has made known to the king what will come to pass after this. The dream is certain, and its interpretation is sure” (2:45).

Nebuchadnezzar Responds to the Explanation (Daniel 2:46–49)

Nebuchadnezzar was shocked by Daniel’s telling and explaining his dream. He responded by honoring Daniel by falling down before him. He also presented “an offering and incense” to Daniel, most likely indicating that he viewed him as the representative of God (Dan. 2:46). Nebuchadnezzar then verbally acknowledged the greatness of God. Only Daniel’s God had been able to reveal the mystery of Nebuchadnezzar’s dream (2:47). The king rewarded Daniel with many gifts and made him the ruler of the province of Babylon and administrator over the wise men (2:48). Nebuchadnezzar also granted Daniel’s request to give positions to Shadrach, Meshach, and Abed-Nego (2:49).

Conclusion

In Daniel 2, God's plan for human history is seen from Babylon to the return of Christ and His rule upon the earth. All human history is controlled by God. Nebuchadnezzar was awed by the dream and its meaning but did not change his heart in response to it. If men are lost, they should respond to the knowledge of God's future kingdom with repentance, lest they too are smashed at the return of Christ. But the saved can rejoice that God not only controls human history, but also is bringing the world to the triumphal return and reign of Christ. Until Christ returns, we must wait for His kingdom and trust Him to sustain us.

POINT TO THE TRUTH

"Give ear, O my people, to my law; incline your ears to the words of my mouth"
(Psalm 78:1).

This section includes questions to review last week's lesson and ideas to prepare students for this week's lesson. Choose from the following ideas to point to the truths of this lesson.



Review Questions

Use these questions to review and reinforce key truths.

Why did Nebuchadnezzar order that all the wise men in Babylon be killed?
They could not reveal his dream.

What did Daniel do when he heard that Nebuchadnezzar wanted to kill him?
He asked for more time because he believed that God would reveal the dream to him.

Did God reveal the dream to Daniel?
Yes. Daniel and his friends prayed that God would reveal the dream to Daniel. God answered their prayer, and Daniel was able to explain and interpret Nebuchadnezzar's dream.

What did Daniel tell Nebuchadnezzar before he interpreted the dream?
Daniel told the king that God had revealed the secret to him. He wanted to make sure that the king knew that God deserved the praise for what Daniel was able to do.

What can we learn about God from the meaning of Nebuchadnezzar's dream?
We can learn that God is in control of all of human history.



God Is Sovereign

Discuss with students what sovereignty is. Ask them what happens when a king asks for something from one of his servants. Does he get what he wants? Yes. He is sovereign over his kingdom. God is also sovereign, but far more sovereign than any earthly king. God is in control of all that happens in history and all that happens in each person's life from the moment he exists. God knows every event that will happen to every person. God also knows everyone who will trust Him as Savior. In what ways can you trust God's sovereignty over your life?



Hard to Explain

Bring to class some pictures of various scenes—people talking, people walking

dogs, etc. Ask the students what is going on in each scene. Also show them some pictures that are harder to interpret. Ask them whether they can figure out what is going on. Tell them that in today's lesson, King Nebuchadnezzar has a dream and needs someone to explain it. Only God knows the secret things, and so Daniel, a man of God, explains the dream to the king



Puzzling

Give the students a difficult puzzle to solve. You could jumble the letters of a word from the memory verse, or even the entire memory verse, and have the students unscramble it. Or you could give them a riddle to solve. Explain that in today's lesson, God gives King Nebuchadnezzar a difficult problem to solve. The king receives a message that he cannot understand. In fact, God gives only one man the ability to solve the king's riddle. Today we will find out who that man is.



Building the Statue

Materials: eight small boxes, poster board, crayons or markers, glue

Directions: Bring in eight small boxes (two sets of four—shoeboxes or any other kind of stackable boxes). On a piece of poster board, draw two statues similar the statue Nebuchadnezzar saw in his dream. (See the picture at the back of the lesson for a guide.) Cut out the statues, and then cut each one into four equal parts: head, arms and chest, waist and thighs, and legs and feet. The sections can be colored, if desired (head: gold, arms and chest: silver, waist and thighs: bronze, legs and feet: iron-colored). Glue each section to the side of a box. You should be able to stack the boxes to make two statues. During class, divide the students into teams, have the teams line up on one side of the room, and give each team a set of boxes. Tell the students that this will be a timed race. When you say "go," the first student from each team should take one box, run to the other side of the room, set the box down, and run back. Then the next student on his team can go. Each student should bring only one section at a time. The goal is to erect the statue. You (or an assistant) should note when a team's statue is complete and then have the students on that team bring back the boxes, one section at a time. When all the sections are back, the team can start building their statue again. The team that builds their statue the most times within the allotted time wins. (Note: you also could use one of the statues as a prop during the lesson.)



Signs from God

Bring in several symbols to show the students. Ask them what each one stands for. For example, a heart symbolizes love, and a wedding ring symbolizes marriage. Explain that a symbol is an object that stands for something else. Tell the students that, in the past, God sometimes taught people about the future by using symbols. An example the students may remember is Joseph's dream of the sheaves and stars (Gen. 37:1–11). Instruct the students to listen to today's lesson and try to note what symbol God used to teach Nebuchadnezzar about the future. Remember after the lesson to ask the students what the symbol was and what it meant.



I Spy

Play a game of "I Spy" with the students. (Choose an object in the room and have them try and guess what you have seen as you describe it.) King Nebuchadnezzar also saw something in a dream, and no one could tell him what it was. Do the students know what he saw?

PROCLAIM THE TRUTH

"Telling to the generation to come the praises of the LORD, and His strength and His wonderful works that He has done" (Psalm 78:4).

This section includes the Bible lesson, lesson questions, and praise and worship ideas. Song suggestions are included that you can use to proclaim your worship to God. Use the lesson questions to check the students' understanding. This section also includes various presentation ideas to use during the teaching time. Read the Bible passage several times before you read these pages. All teaching should be done directly from the Bible.

Bible Lesson

Reading of the Text

Read portions of Daniel 2:1–49.

Introduction

Have you ever had a bad dream and then could not go back to sleep? In today's story, King Nebuchadnezzar had a dream that bothered him so much that he could not fall back asleep. He called his wise men together to see if they could tell him his dream and what it meant. They were not able to tell him his dream, so he said that they all would be killed, including Daniel. Let's find out what happens to Daniel in today's lesson and how God uses this situation for His glory.



Leadoff Questions (LOQs)

LOQ: Why did the king call for the death of his magicians, including Daniel and his friends?

Answer: The king had a dream that bothered him and wanted the wise men to tell him what the dream was before telling him what it meant. The king wanted to see whether the wise men were truly able to know secret things.

LOQ: Could any of the king's wise men tell the king what his dream was about?

Answer: No, none of them could tell him about the dream. They were not men used by God, and only God knows everything, even the secret things.

LOQ: What did Daniel do when he heard the news of the death sentence?

Answer: Daniel asked the king for some time before killing all the wise men. Daniel and his friends did not doubt that God could reveal the king's dream. They prayed, asking God to have mercy and reveal the dream so that they would not die with the others.

LOQ: How did God answer Daniel, and what was Daniel's response?

Answer: God revealed the king's dream to Daniel. Daniel praised God for knowing the unknowable and revealing it. He praised God for glorifying Himself by answering the request of His faithful servant. He also praised God for being the sovereign God who "changes the times and the seasons" and who "removes kings and raises up kings" (2:21).

LOQ: What did Daniel tell the king?

Answer: Daniel did not take the credit for knowing the dream himself but said that it was only because the God of heaven revealed it. Daniel explained the two parts of the dream to the king. The first part that he explained was about the statue. After that, he explained about the rock that would smash the statue. After explaining the dream, Daniel explained what the dream meant.

LOQ: What did the king's dream mean?

Answer: Daniel said that God had given Nebuchadnezzar his kingdom, power, strength, and glory. He explained what the statue meant, saying that each of the levels represented a group that would come to power after Babylon.

LOQ: After Daniel interpreted the king's dream, what did the king do?

Answer: The king honored Daniel by giving him gifts, and he made him the ruler of the province of Babylon and over the wise men.

Summary

In today's lesson we see how God used a situation that looked impossible by turning it around and glorifying Himself. God used this situation to place His servant right where He wanted him. King Nebuchadnezzar had a dream one night that distressed him greatly. Because of this dream, he could not get back to sleep. So he called his wise men together and asked them to tell him what his dream was about and then what it meant. None of the wise men knew what the king's dream was about, so the king sentenced all the wise men to death. When Daniel heard the news, he asked the king for more time. The king granted his request. Then Daniel and his friends went to pray. Daniel asked that God would give them mercy about this dream so that they would not die with the wise men. God gave Daniel a vision about the king's dream and what it meant. Daniel explained the dream to the king, and this pleased the king very much. The king rewarded Daniel and gave him authority over Babylon and over the wise men. God turned around a situation that seemed hopeless so that He would be glorified.

Application

God knows everything, even the secret things that no one else knows. God knows the future and the past. When situations in our lives do not make sense, God knows how they will turn out. We can see that God has a plan for history and for each believer's life. The believer can be excited about what God has planned for him, but the unbeliever should be warned of the punishment that awaits him if he does not repent.

Presentation Ideas



A Beka Book Flash-A-Cards

Use appropriate A Beka Book Flash-A-Cards with the lesson.



Betty Lukens Flannelgraph

Use appropriate flannelgraph pieces with the lesson.



Five Crowns

Create five crowns of increasing sizes. They should fit inside one another. Several times throughout the lesson, show a larger crown that will cover up the preceding crown. The final crown will represent Christ's reign.



The Kingdoms

During the lesson, as you explain each kingdom that is represented by the statue, have different teachers come in dressed as kings. On entering, each king should explain what his particular section of the statue. The first could come in as Cyrus the Great and could briefly talk about the Medo-Persian kingdom, and so on.



Daniel Interprets the King's Dream

Use this activity to illustrate the fact that the interpretation of the king's dream was by God's power. During the teaching time, have one of the students, designated as King Nebuchadnezzar, go into another room to view a picture. The picture represents the dream that Nebuchadnezzar had. Next, ask the class to tell and interpret the king's "dream," which they will not be able to do since they have not seen the picture. Designate a student to be Daniel. Daniel should go into the other room and also see the picture. He can then return to the classroom and "interpret" the dream.

Praise and Worship

Create in Me a Clean Heart

He's Got the Whole World in His Hands

My God Is So Great

Rejoice in the Lord Always

This is My Father's World

Thou Art Worthy

Trust and Obey

PRACTICE THE TRUTH

"That they may set their hope in God, and not forget the works of God, but keep His commandments" (Psalm 78:7).

Choose ideas from this section to review and apply the truths of the Bible lesson.



Accordion Book: "Daniel Praises God"

Materials: copies of the "Daniel Praises God" craft pages on cardstock, scissors, glue, brads, double-sided tape, crayons

Directions: Give each student a copy of the craft pages, and instruct them to cut around the outside edge of each set of three pages (not cutting the squares apart). They should then put some glue on the small extra flap (to the left of the picture of the gift) and attach it to the back of the square that says, "He removes kings and raises up kings." This will create one long strip of six squares. Let the strips dry. Instruct the students to cut out the arm pieces on the second page. Show them how to push a brad through both dots, connecting the bicep and forearm, and then push the brad through the dot on the first square to connect the arm to the square. Students can make the arm "flex" to indicate God's strength. Next, they should cut out the clock and glue it to the second square; this represents how God can change the times and seasons. Third, have the students cut out the two crowns, leaving the rectangular strips attached. Model how to cut along the two

vertical lines in the third square, creating slits. (Younger students may need help.) Show the students how to fold the two rectangular strips behind the crown and stick them through the slits in the third square. Glue the two strips together, and allow them to dry. Meanwhile, put a piece of double-sided tape on the back of the second crown, and stick it on top of the first. Show the students how they can take the crown on and off to show that God has the power to remove kings. Then show the students how to slide the crown up and down along the slits, symbolizing how God can raise up a king. After all the glue has dried, have the students fold on the lines between each page, accordion style (one square back, the next square forward, and so on). Read the words of Daniel's prayer at the bottom of each square to review the key verse.



"God Reveals a Secret"

Materials: copies of the "God Reveals a Secret" craft pages; gold, silver, bronze, and black or gray glitter or crayons; scissors; glue

Directions: Give each student a copy of the craft pages. Have them cut around the box containing the idol. Using crayons or glitter, they should decorate each part of the idol with the appropriate color (head: gold; chest/arms: silver; waist/thighs: bronze; feet: black or gray). Then have them cut along the dark lines to form flaps, leaving a tab on the left side. They should glue the tab onto the template page and fold back the pieces along the dotted line. When they lift the flaps, they will be able to read what each part of Nebuchadnezzar's dream meant



The Message Revealed

Before class, write a simple message or draw a basic picture using lemon juice as "ink." The lemon juice will dry clear so that you cannot easily see the message. Ask for some volunteers to tell you what is written on the paper. The paper can then be heated, using a hair dryer, clothes iron, or the heat from an open light bulb. The lemon juice will discolor on the paper, thereby revealing the message. God gave Daniel the ability to see and interpret the king's dream even when no one else in the kingdom could.



"Daniel Interprets the King's Dream"

Use this work sheet to reinforce the key truths of today's lesson. The work sheet is located at the back of the lesson.



Journal Page: "Wisdom"

Give each student a copy of the journal page at the back of this lesson. The students can complete the page individually, in small groups, or at home.

Coloring Pages

Give each student a copy of the coloring pages at the back of the lesson. Students can color the pages in class or at home.



MEMORY VERSE

"Daniel answered and said: 'Blessed be the name of God forever and ever, for wisdom and might are His'" (Daniel 2:20).

Daniel Praises God

<p>●</p> <p>"Blessed be the name of God forever and ever, for wisdom and might are His.</p>	<p>And He changes the times and the seasons;</p>	<p>He removes kings and raises up kings;</p>
---	--	--

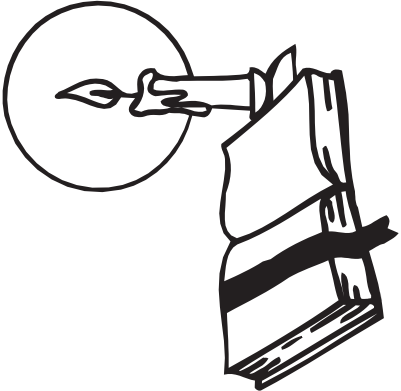
 <p>He gives wisdom to the wise and knowledge to those who have understanding.</p>	<p>He reveals deep and secret things; He knows what is in the darkness,</p>	 <p>And light dwells with Him" (Daniel 2:20-22).</p>
---	--	---

Daniel Praises God

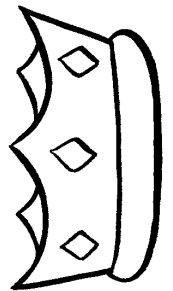
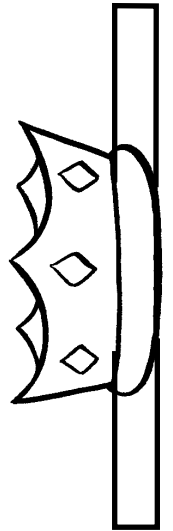
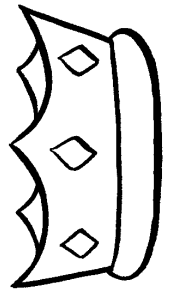
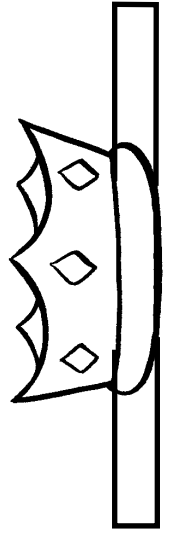
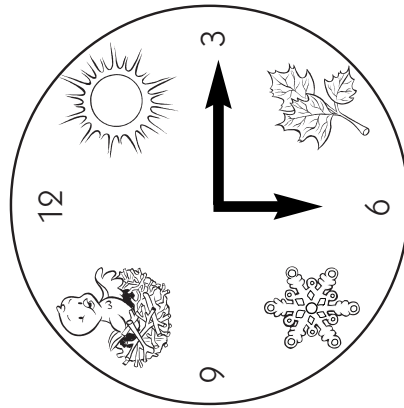
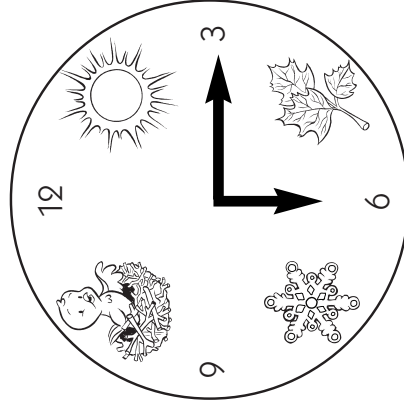
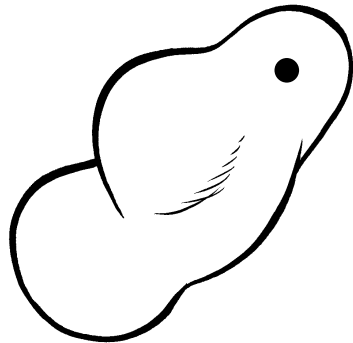
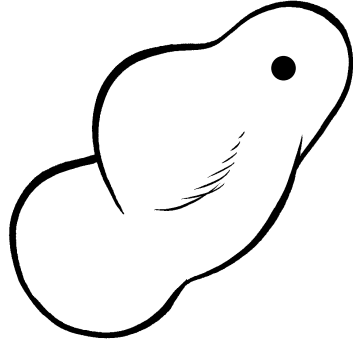

God Reveals a Secret

God helped Daniel to reveal and interpret King Nebuchadnezzar's dream in Daniel 2:14–45.

“You, O king, are a king of kings. For the God of heaven has given you a kingdom, power, strength, and glory; and wherever the children of men dwell, or the beasts of the field and the birds of the heaven, He has given them into your hand, and has made you ruler over them all—you are this head of gold” (Dan. 2:37–38).

“But after you shall arise another kingdom inferior to yours” (2:39a).

“then another, a third kingdom of bronze, which shall rule over all the earth” (2:39b).

“And the fourth kingdom shall be as strong as iron, inasmuch as iron breaks in pieces and shatters everything; and like iron that crushes, that kingdom will break in pieces and crush all the others” (2:40).

God Reveals a Secret

God helped Daniel to reveal and interpret King Nebuchadnezzar's dream in Daniel 2:14–45.

“You, O king, are a king of kings. For the God of heaven has given you a kingdom, power, strength, and glory; and wherever the children of men dwell, or the beasts of the field and the birds of the heaven, He has given them into your hand, and has made you ruler over them all—you are this head of gold” (Dan. 2:37–38).

“But after you shall arise another kingdom inferior to yours” (2:39a).

“then another, a third kingdom of bronze, which shall rule over all the earth” (2:39b).

“And the fourth kingdom shall be as strong as iron, inasmuch as iron breaks in pieces and shatters everything; and like iron that crushes, that kingdom will break in pieces and crush all the others” (2:40).

God Reveals a Secret

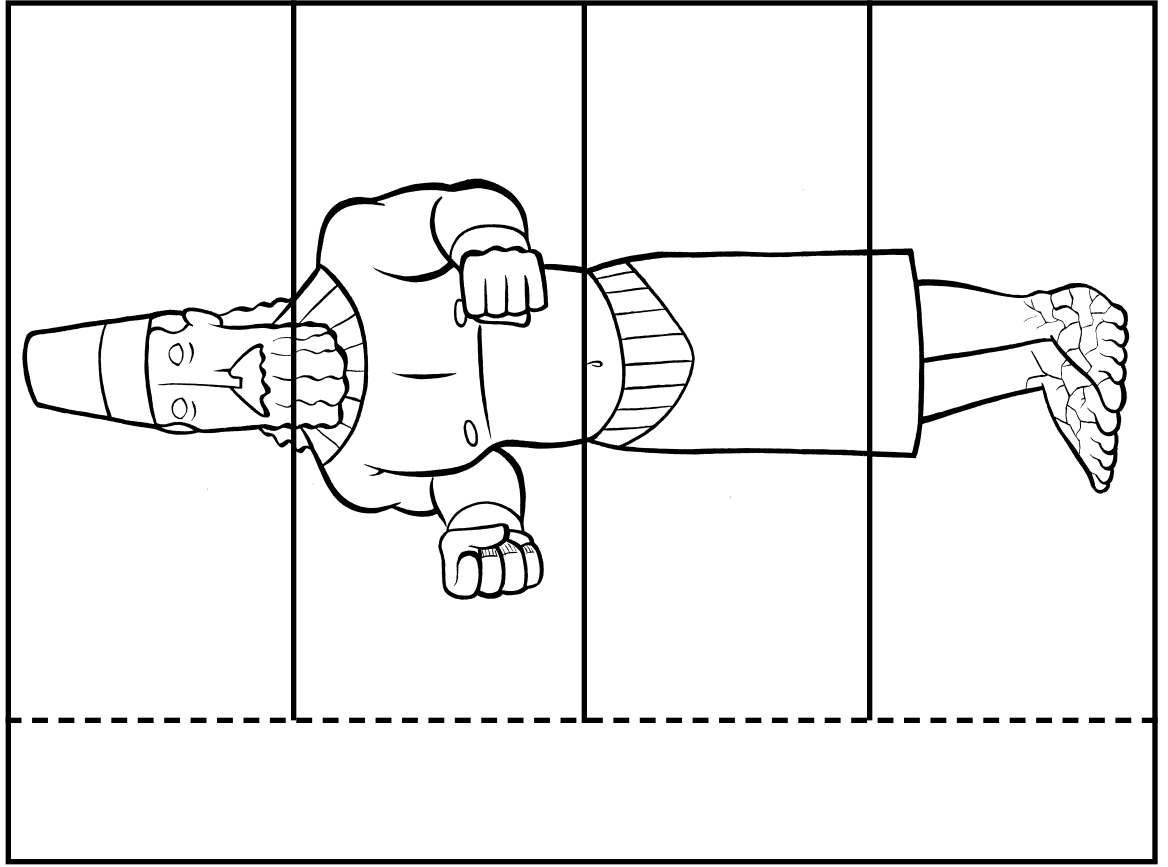
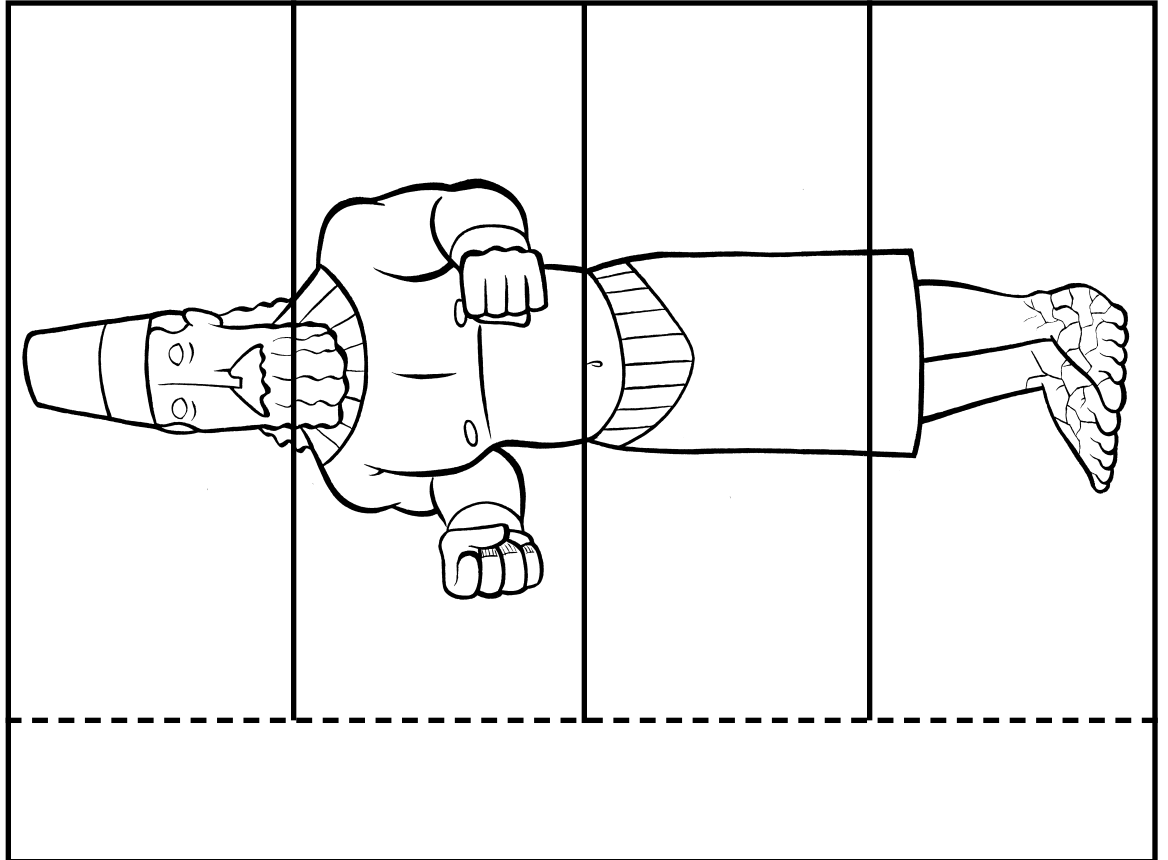

Daniel

Interprets
the **King's** Dream



Daniel 2

Name _____

1. Nebuchadnezzar wanted his magicians to _____ his dream.
2. Nebuchadnezzar ordered that the wise men of Babylon be _____ because they could not tell him his dream (2:12).
3. What did Daniel ask Nebuchadnezzar for? _____
more wine more time
wisdom more linen
4. Who revealed Nebuchadnezzar's dream to Daniel? _____
5. How did Daniel respond when God answered his prayer? _____
6. In Daniel 2:28, Daniel told Nebuchadnezzar that God can reveal _____.
7. After Daniel told Nebuchadnezzar his dream, Nebuchadnezzar said:
"Truly your God is the _____ of _____ " (2:47).

God Is in Control

“Daniel answered and said: ‘Blessed be the name of God for ever and ever, for wisdom and might are His. And He changes the times and the seasons; He removes kings and raises up kings; He gives wisdom to the wise and knowledge to those who have understanding. He reveals deep and secret things; He knows what is in the darkness, and light dwells with Him’” (Daniel 2:20–22).

Have you ever heard anyone say, “Who’s in charge here, anyway?” That question is usually asked when everything seems to be going wrong or is out of control.

Maybe you have had days when it seems like no one is in control and everything is out of control. But God is in control even when things seem to be going wrong.

When Daniel was taken captive to Babylon, God used him to interpret Nebuchadnezzar’s dream. Through Daniel’s interpretation, God showed that He controls all of human history.

Write out Daniel 2:44.

Does this encourage you? _____.

God Is in Control

“Daniel answered and said: ‘Blessed be the name of God for ever and ever, for wisdom and might are His. And He changes the times and the seasons; He removes kings and raises up kings; He gives wisdom to the wise and knowledge to those who have understanding. He reveals deep and secret things; He knows what is in the darkness, and light dwells with Him’” (Daniel 2:20–22).

Have you ever heard anyone say, “Who’s in charge here, anyway?” That question is usually asked when everything seems to be going wrong or is out of control.

Maybe you have had days when it seems like no one is in control and everything is out of control. But God is in control even when things seem to be going wrong.

When Daniel was taken captive to Babylon, God used him to interpret Nebuchadnezzar’s dream. Through Daniel’s interpretation, God showed that He controls all of human history.

Write out Daniel 2:44.

Does this encourage you? _____.

When Christ comes to set up His kingdom, it will be a happy day for those who have put their trust in Him, but He will bring judgment on those who refuse to repent (Rev. 19:11–21). Are you looking for Christ to come from heaven and set up His kingdom here on earth, or will it be a sad day for you because you have not repented?

What should you do?

You can ask Christ to forgive you, and you should talk to your parents or Sunday school teacher about this, too.

Christ's kingdom will be a wonderful place, and He wants you to be there with Him. In the space below, write about His forever kingdom. What will it be like to see Him and live in the perfect kingdom?

PRAYER

Blessed be the name of God forever and ever. Lord, you have wisdom and power, You know everything, and I can trust You. You change the times and the seasons; You remove kings and raise up kings; and someday You will set up Your kingdom. Thank You for making it possible for me to have forgiveness and be a part of Your kingdom.

When Christ comes to set up His kingdom, it will be a happy day for those who have put their trust in Him, but He will bring judgment on those who refuse to repent (Rev. 19:11–21). Are you looking for Christ to come from heaven and set up His kingdom here on earth, or will it be a sad day for you because you have not repented?

What should you do?

You can ask Christ to forgive you, and you should talk to your parents or Sunday school teacher about this, too.

Christ's kingdom will be a wonderful place, and He wants you to be there with Him. In the space below, write about His forever kingdom. What will it be like to see Him and live in the perfect kingdom?

PRAYER

Blessed be the name of God forever and ever. Lord, you have wisdom and power, You know everything, and I can trust You. You change the times and the seasons; You remove kings and raise up kings; and someday You will set up Your kingdom. Thank You for making it possible for me to have forgiveness and be a part of Your kingdom.



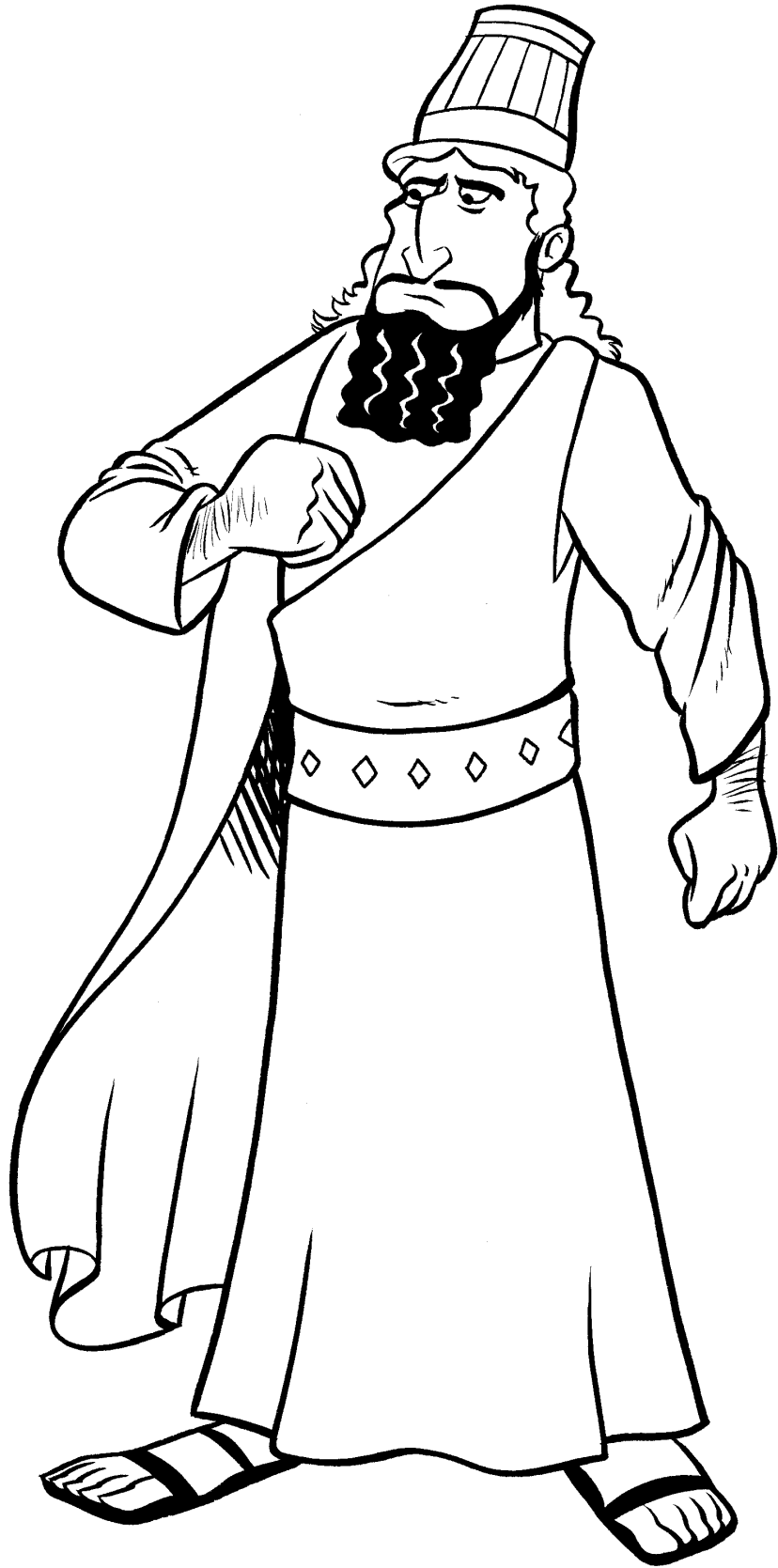

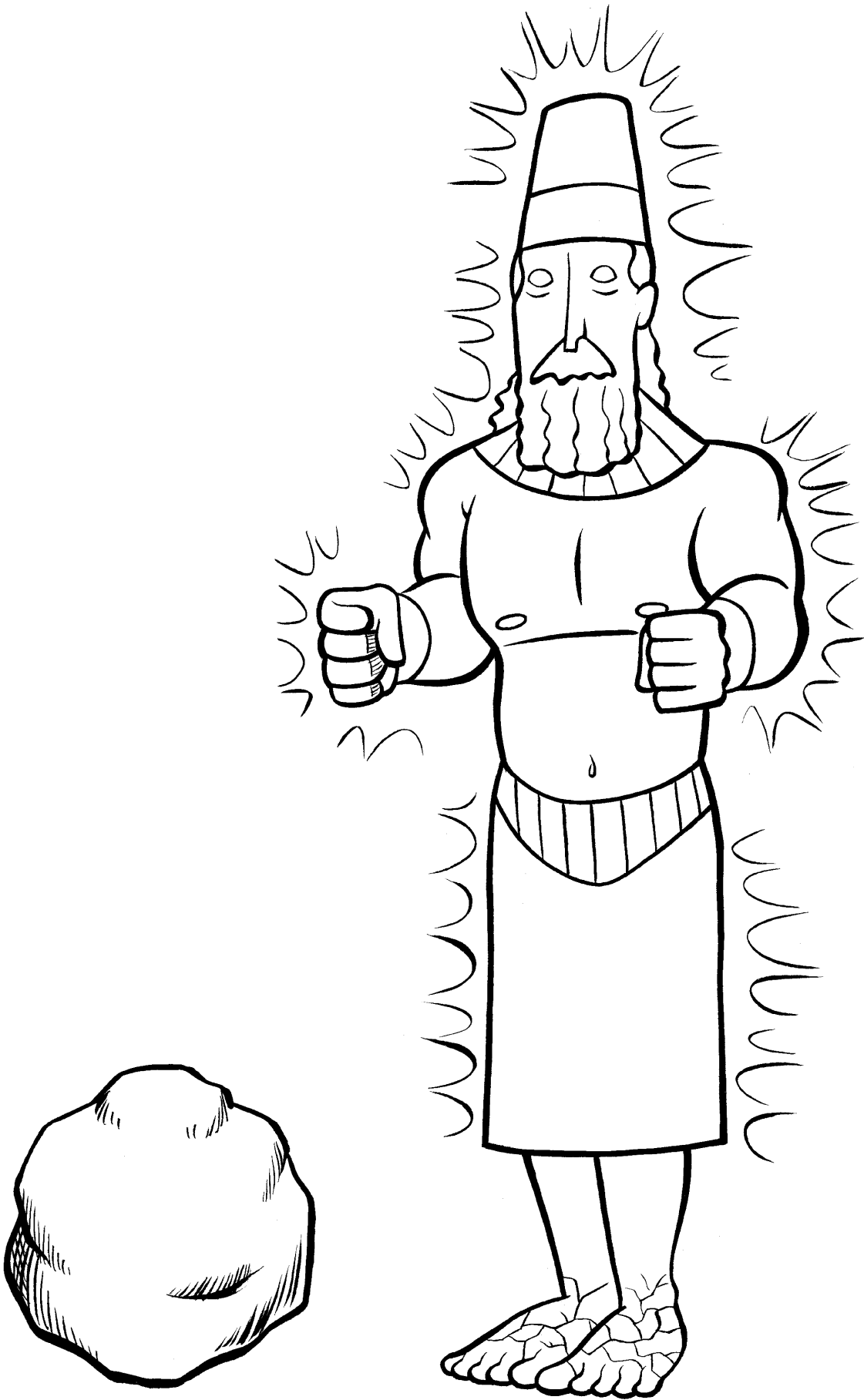



“You, O king, were watching; and behold, a great image! This great image, whose splendor was excellent, stood before you; and its form was awesome. This image’s head was of fine gold, its chest and arms of silver, its belly and thighs of bronze, its legs of iron, its feet partly of iron and partly of clay” (Daniel 2:31–33).



“Inasmuch as you saw that the stone was cut out of the mountain without hands, and that it broke in pieces the iron, the bronze, the clay, the silver, and the gold—the great God has made known to the king what will come to pass after this. The dream is certain, and its interpretation is sure” (Daniel 2:45).

