

griphoist®

manual hoists
use and maintenance

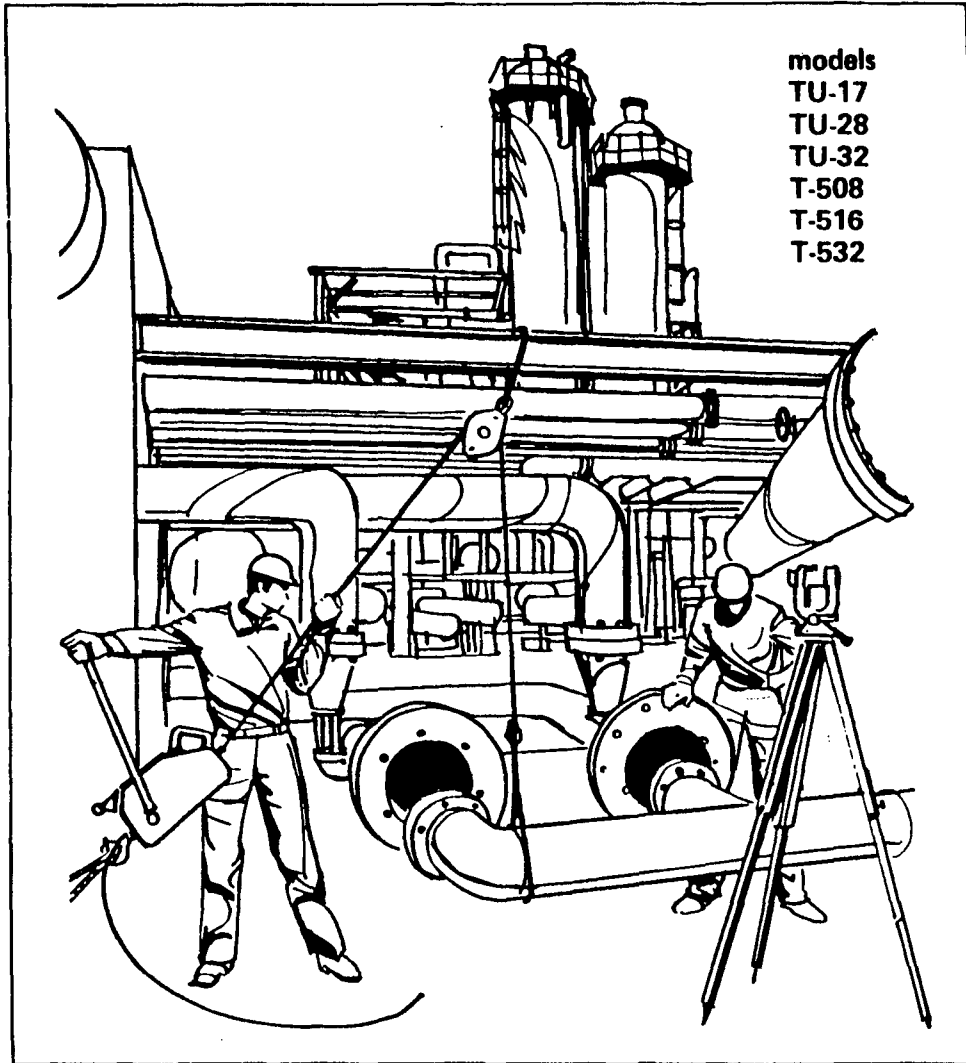

models
TU-17
TU-28
TU-32
T-508
T-516
T-532

Griphoist Inc.

Fig. 1

TU-8
TU-16

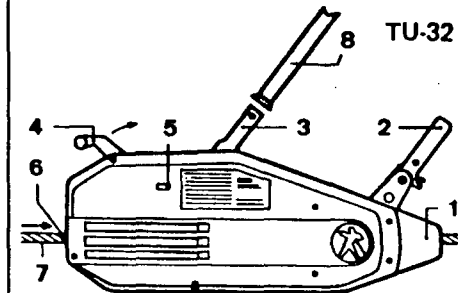
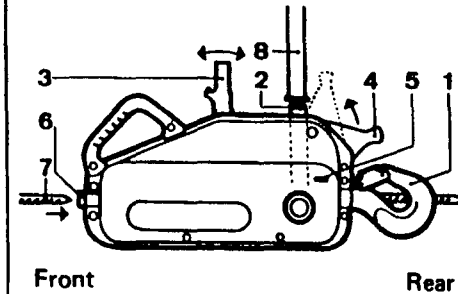

1. Anchor hook / pin
2. Power stroke lever
3. Reversing lever
4. Rope release lever
5. Lock bottom
6. Wire rope entry
7. Wire rope
8. Telescopic operating handle

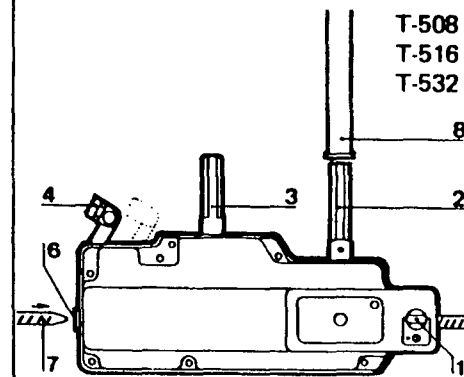

T-508
T-516
T-532

1. INTRODUCTION

This operating and maintenance booklet informs you about the functioning of the manual GRIPHOIST machines. A spare parts nomenclature for the specified model is also contained. Nomenclatures for the other models can be sent on request.

2. DESCRIPTION

2.1. Working principle

The principle of the GRIPHOIST units is based on a unique arrangement of two pairs of self-energizing grip jaws. Instead of the wire rope being reeled on a drum as it is in a conventional hoist, it is pulled through the GRIPHOIST in a straight line. The grip jaws are machined to a radius suitable for the wire rope. The surfaces of the jaws are smooth and grip the wire rope without damaging it.

The 2 jaw blocks are enclosed in a casing. They alternately grip the wire rope to pull it during lifting or retain it during lowering.

In operation the action of the grip jaws can be compared to two hands which alternately seize the wire rope and draw it. The two sets of jaws are locked by the pull of the wire rope. **The heavier the load – the stronger the grip.**

2.2. Principal operating components

(see opposite folder)

2.3. Technical specifications

Model		T-508	TU-17*	T-516	TU-28*	T-532	TU-32*
Material lifting capacity**	lbs	2,000	2,000	4,000	4,000	8,000	8,000
Manriding capacity**	lbs	—	1,500	—	3,000	—	6,000
Approx. speed per minute	fpm	7 - 9	7 - 9	6	7 - 8	6	5
Weight:							
hoist	lbs	14.25	18.5	30	41	51	59.5
operating handle	lbs	2.5	2.2	5	5.3	5	5.3
Overall dimensions	in.	16-1/2	20-3/4	20-7/8	26x13	24-7/16	27x13
		x9-7/8	x9-3/4	x12-7/16	x5-3/4	x14	x6-1/8
		x3-7/8	x4-1/2	x5		x5-1/8	
Length of operating handle	in.	22/28	22/28	25-5/8	31-1/2	25-5/8	31-1/2
				45-1/4	47-1/2	45-1/4	47-1/2
GRIPHOIST wire rope:							
standard length***	ft	30	30	60	60	30	30
diameter	in.	5/16	5/16	7/16	7/16	5/8	5/8
	mm	8.4	8.4	11.6	11.6	16.3	16.3
	ref.	C8	C8	C12	C12	C16	C16
breaking strength	lbs	10,000	10,000	20,000	20,000	40,000	40,000

* U.L. classified

** capacity calculated for materials hoisting. For manriding, conform to all safety regulations;

*** any odd lengths supplied on request. Unless specified otherwise, wire rope is fitted with its standard eye hook with latch at one end and welded point the other end.

A light weight metal reel, supplied with the wire rope, facilitates carrying and stowing.

As a rule GRIPHOIST units are not sold without their wire rope.

3. OPERATING INSTRUCTIONS

Remark: the drawings of the following parts can be found on the folder page 2.

3.1. Equipment required

For lifting, pulling or tightening a load with a GRIPHOIST machine, we recommend the following standard equipment:

- the appropriate GRIPHOIST unit with its telescopic lever,
- the GRIPHOIST wire rope with appropriate length,
- corresponding wire rope or chain slings for the anchoring of the hoist and to fix the load to the traction wire rope,
- pulley blocks when increasing the wire rope capacity by means of sheaves,
- oil to lubricate the inner mechanism and the wire rope when working.

3.2. Anchoring

Anchor the GRIPHOIST by its hook or anchor pin (1) with a sling or chain to any resistant fixed point. Make sure the sling, chain and anchorage are capable of supporting all imposed loads.

As GRIPHOIST machines work equally well in any position **horizontally, vertically or diagonally** – the operator may choose the most convenient anchoring point.

There are several ways of anchoring the machine:

PULLING (Fig. 2.1.)

For pulling operations the machine is generally anchored to a fixed point to where the load is to be taken to.

LIFTING (Fig. 2.2.)

When a reversing sheave is used, the machine can be anchored to any fixed point away from the load, this is the most commonly used method.

LIFTING (Fig. 2.3.)

Machine anchored above the load to be lifted.

LIFTING (Fig. 2.4.)

GRIPHOIST anchored directly to the load. In this case the wire rope remains static and the machine and load climb the wire rope.

Fig. 2

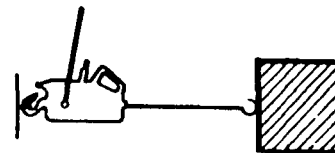

2.1.

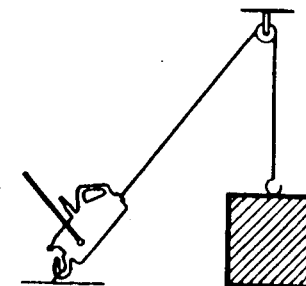

2.2.

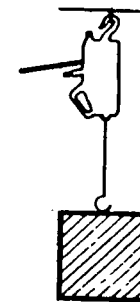

2.3.

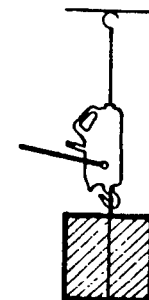

2.4.

When preparing the machine observe following recommendations:

- make sure that the load on the machine will not exceed the rated capacity of the hoist;
- anchor with an independent sling so that the unit is in line with the load in the most advantageous working position;
- ensure that there is nothing to obstruct the free movement of the power stroke lever (2), the reversing lever (3) and the rope release lever (4);
- ensure that the rope exit is clear of obstruction or the wire rope will be forced back into the machine;
- to provide the extra "safety" – in addition to the safety factor inherent in our GRIPHOIST machines – we recommend the use of our BLOCSTOP safety device for all works imperilling human lives and where additional safety measures are required by the ruling safety regulations. It is the duty of the hoist owner and operator to obtain all pertinent Federal, State and local regulations and to use the equipment in compliance with them.

Warning! The hooks for the machine (on TU-17 & TU-28 models, Fig. 3) and the wire rope hooks (Fig. 4) are fitted with a safety latch to retain loose slings or devices under slack conditions. This latch is not intended to be anti-fouling device, so caution should be used to prevent it from supporting any of the load. Periodic inspection of the latch must be made to make sure it is not defective or missing. If it is replace it prior to use.

DO NOT OPERATE MACHINE IF IT IS FUNCTIONING IMPROPERLY.

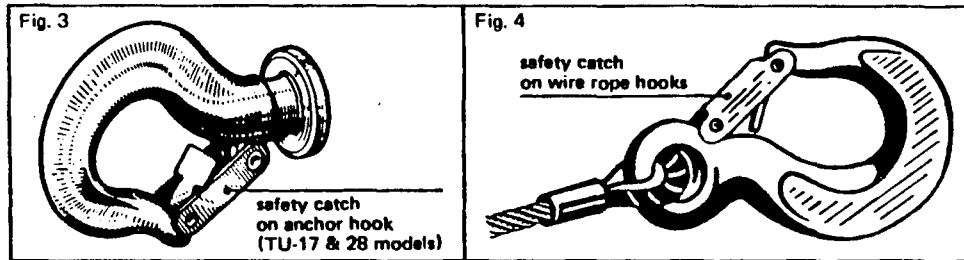

3.3. Inserting the wire rope

- uncoil the wire rope in a straight line;
- open both jaws by operating the rope release lever (4); see instruction plate fixed to the machine;
- insert wire rope at rope entry (6), push until it comes out at the opposite side and pull all slack wire rope through machine by hand;
- to close jaws on wire rope, let rope release lever (4) return to its initial position (see instruction plate).

3.4. Working with the machine

Place the telescopic operating handle (8) on lever (2) for lifting or pulling, or on lever (3) for slacken or lower. Lock it into position by twisting, so that the handle will not fall off. Moving the handle to-and-fro will cause the wire rope to be moved towards the machine. The handle can be used fully opened or closed depending on the operator and load.

When it is left in any position, it will remain stationary.

If the pulling is very hard, the work should be stopped and the wire rope reeved through a snatch block (see page 6).

Never use another object to replace the telescopic operating handle.

Never operate power stroke lever (2) and reversing lever (3) at the same time.

NEVER ATTEMPT TO MOTORIZED OR MECHANICALLY OPERATE A HOIST DESIGNED FOR MANUAL OPERATION.

3.5. Removing the wire rope

As the jaws are locked by the tension of the wire rope, the load must first be removed. Slacken the rope completely by lever (3). Open the jaws by opening rope release lever (4) – see instruction plate – and remove wire rope by hand.

3.6. Overload Protection Device

On all GRIPHOIST machines the power stroke lever (2) is connected to the crankshaft by means of one or – depending from model – more shear pin(s) (Fig. 5, 6 & 7).

The diameter and the composition of these shear pins have been predetermined to shear in case of overload, which can be of 50 to 100 %, depending on working conditions.

This protects the machine from more serious and costly damage. Although sheared pins prevent further pulling or lifting, reverse action is still possible using reversing lever (3) to remove the load.

Spare shear pins will be found in the hollow of the power stroke lever (models TU-17 & TU-28), resp. of the rope release lever (models TU-32, T-508, T-516 & T-532). Just remove cap of the lever.

Broken shear pins can be replaced in a few minutes. Stop or lower the load, leave machine under light tension to facilitate the operation.

3.6.1. Replacement of shear pin(s):

- GRIPHOIST TU-32 and all T-500 models:
remove shear pin by means of a pin extractor. Align the power stroke lever (2) and drive in the new shear pin.
- GRIPHOIST TU-17 and TU-28:
Use a gear puller to remove power stroke lever from crankshaft. When no gear available, it may be possible to remove the lever while machine is under tension, by using the telescopic operation handle – work back and forth to pull off power stroke lever. Remove broken pins, clear off the burr produced by shearing. Duly grease end of crankshaft, replace power stroke lever on crankshaft, and fix it by means of the new shear pins. Drive them in smoothly with a hammer, take care not to damage crankshaft.

The machine is again ready for use. Considering that the pin sheared because of overloading it is necessary to use one or several sheave blocks to increase the capacity of the machine (see 3.7., page 6), or reduce the load to finish work without further incident.

DO NOT USE THE SHEAR PIN(S) TO MEASURE THE MAXIMUM LOAD TO BE LIFTED. IT IS AN OVERLOAD PROTECTIVE DEVICE ONLY.

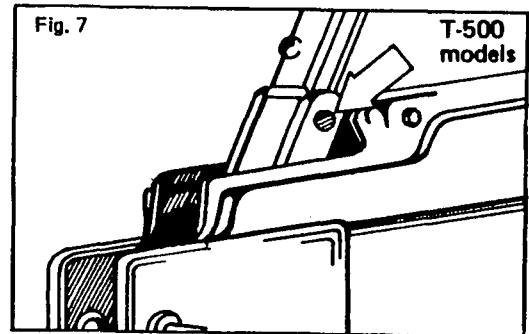
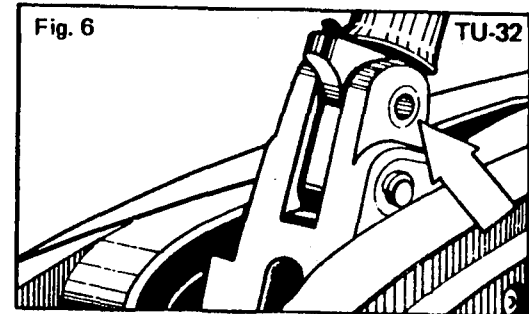
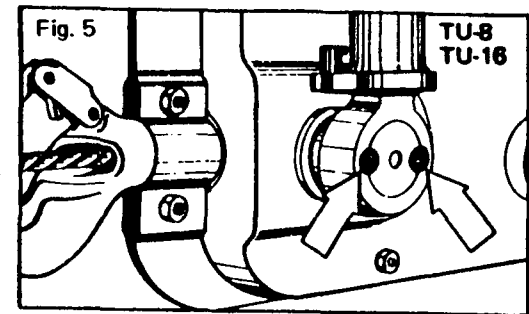

3.7. To increase the capacity of the GRIPHOIST

GRIPHOIST machines used in conjunction with sheave blocks will efficiently solve most of your pulling and lifting problems.

By using sheave blocks on the hauling rope, the nominal capacity of GRIPHOIST machines can be multiplied 2, 3 and even 4 times as shown in fig. 8.

As a rule it is not difficult to figure the number of line parts to be used for a given load. It is however important, especially when there is a greater number of line parts, to take into consideration the friction in the sheaves, which can increase on the hoist and the top anchoring hook of the block.

For a specific lifting or pulling problem tables below allow one to rapidly determine the sheave block combination, which is the most appropriate to solve it.

3.7.1. Sheave block combinations

	TU-17 T-508	TU-28 T-516	TU-32 T-532
2,000	1	1	1
4,000	2	1	1
6,000	3	2	1
8,000	4	2	1
12,000	—	3	2
16,000	—	4	2
24,000	—	—	3
max. load lbs	sheave block combination no. (see fig. 8)		

Fig. 8 - Sheave block combinations

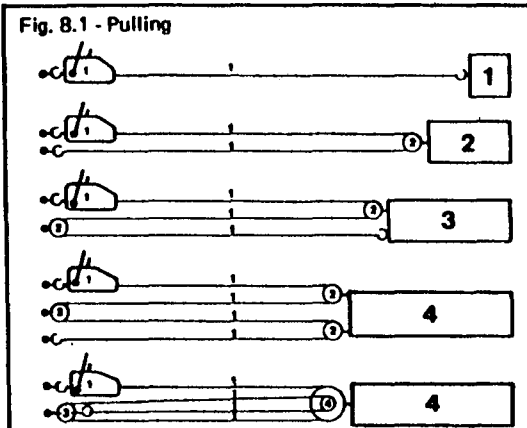

Fig. 8.2 - Lifting by means of reversing sheaves

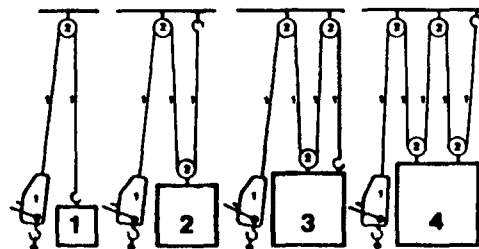

Fig. 8.3 - Lifting. Machine anchored above the load

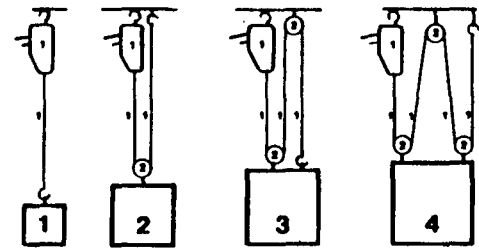
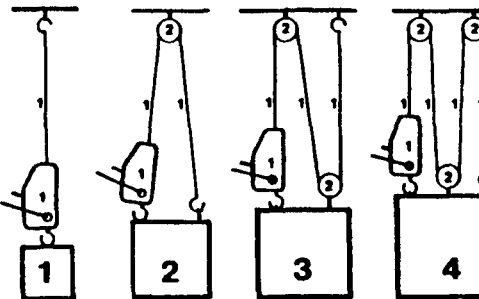

Fig. 8.4 - Lifting. Machine anchored to the load



3.8. GRIPHOIST Wire Rope

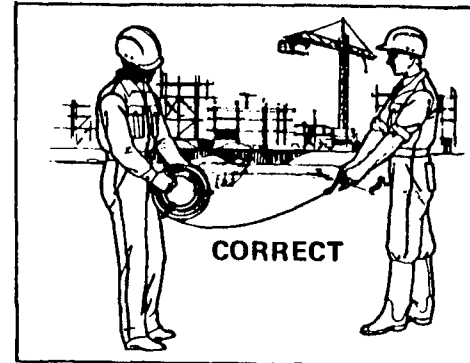

Fig. 9

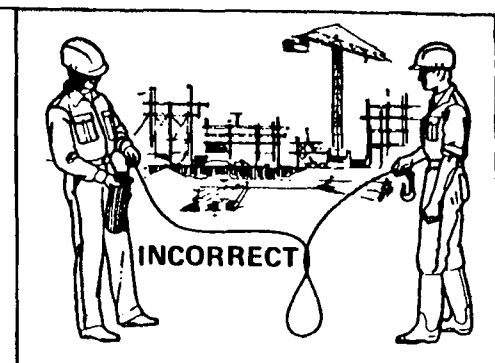
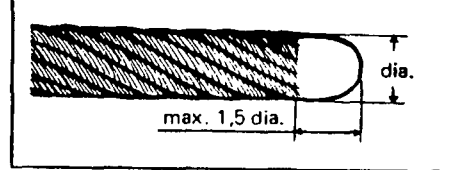

Fig. 10

The different GRIPHOIST wire ropes have been developed specially to meet the requirements of the machine. The rope tips should be welded round (Fig. 11).

Other wire ropes deform under pressure of the jaws, causing malfunction of the machines.

Fig. 11



For this reason use only the GRIPHOIST wire rope, which can alone ensure proper working of your machine.

- the wire rope should be reeled and unreeled in a straight line (Fig. 9) to prevent loops and kinks (Fig. 10). Kinked wire rope will not work in the GRIPHOIST machine. For this reason never use the rope as a sling; always use a separate wire rope or chain sling;
- be sure that the wire rope is wiped clean before inserting it into the machine. For longer life and better performance the wire rope should be oiled well from time to time;
- the wire rope outlet of the machine should not be obstructed. The rope must be able to pass freely to prevent it being forced back into the unit;
- never kink the wire rope by bending over sharp edges;
- never use wire rope that has been subject to damage such as fire, corrosive chemicals or atmosphere or exposed to electric current, etc. . .
- to avoid unlaying the strands, never allow a loaded rope to rotate.

CAUTION:

THE MANUFACTURER DECLINES ALL RESPONSIBILITY FOR MACHINES USED WITH A WIRE ROPE OTHER THAN GRIPHOIST WIRE ROPE.

I. MAINTENANCE AND LUBRICATION

I.1. GRIPHOIST Machine

Maintenance and lubrication are the best guarantees for the good working of GRIPHOIST machines. Conduct periodic visual inspections and make sure necessary lubrication and repairs are made.

Although the steel casing provides good protection, dust and dirt can penetrate into the mechanism through the top opening of the casing, as well as through the guide holes of the wire rope. The machine should therefore never be left lying about in mud and the wire rope should be cleaned before it is introduced into the machine.

I.1.1. General Maintenance Cleaning

Dip machine into a mineral spirits degreasing solution that will not attack nylon. Shake well to dislodge foreign matters and turn quickly upside down to remove them. To lubricate squirt lube oil through top opening into the internal mechanism in the direction of the jaws.

I.1.2. Very dirty machine

Considering that a certain number of precautions have to be taken for dismantling and reassembling, it is recommended to always take it to a repair shop agreed to by the manufacturer for overhaul of your GRIPHOIST machine.

I.1.3. Lubrication

For normal lubrication, squirt SAE 90 to 120 motor oil through the apertures in the casing. To allow lubricant to penetrate to all the parts of the mechanism, alternately operate power stroke lever and reversing lever.

An excess of lubrication will not cause the wire rope to slip. Lack of lubrication, is the greatest cause of malfunction, because it causes wear or jamming of bearings.

I.2. Wire Rope

Use only wire rope furnished by GRIPHOIST. Periodically clean and oil it with a rag impregnated with motor oil SAE 10 W 40.

Wire rope must be replaced, if any of the following conditions are noted:

- broken wires or strands,
- kinking, crushing, birdcaging, or any other distortion of the wire rope structure,
- excessive corrosion,
- heat damage, evident through discolored wires,
- reduction from nominal diameter of more than 10 %.

I.2.1. How to measure wire rope

The correct diameter of the wire rope is the diameter of a circumscribed circle, which will enclose all strands. It is the largest cross-sectional measurement as illustrated in Fig. 12. The measurement should be made carefully with calipers. The illustration shows also the correct and incorrect method of measuring the wire rope diameter.

REPLACEMENT WIRE ROPE MUST BE THE SAME SIZE, GRADE, AND CONSTRUCTION AS THE GRIPHOIST SPECIFIED WIRE ROPE FOR THE HOIST IN USE!

THE MANUFACTURER DECLINES ALL RESPONSIBILITY FOR MACHINES USED WITH OTHER NONSPECIFIED WIRE ROPE.

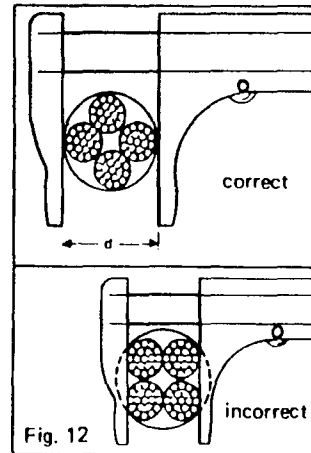

GRANDE IMP. DE TROYES - PRINTED IN FRANCE

GIVE TO SCAFFOLD ERECTOR & USER OR POST ON JOB

DEVELOPED FOR INDUSTRY BY
SCAFFOLD INDUSTRY ASSOCIATION, INC.
CODE OF SAFE PRACTICES
FOR
SUSPENDED POWERED SCAFFOLDS

It shall be the responsibility of all employees and users to read and comply with the following common sense rules which are designed to promote safety in the erection and use of suspended powered scaffolds. These rules do not purport to be all inclusive nor to supplant or replace other additional safety and precautionary measures to cover usual or unusual conditions. If these rules conflict in any way with any state, local or federal statute or regulation, said statute or regulation shall supersede these rules and it shall be the responsibility of each employee and user to comply therewith.

A. GENERAL RULES:

1. **POST THESE SAFETY RULES** at every job site in a conspicuous place and make certain that all persons who will erect, use, relocate, or dismantle suspended systems are fully aware of them and other governing codes.
2. **READ, UNDERSTAND AND FOLLOW THESE RULES** and manufacturers' instructions located in manuals supplied with and on plates posted on scaffolding equipment.
3. **CONSULT YOUR SUSPENDED POWER SCAFFOLD EQUIPMENT SUPPLIER** when in doubt.
4. **OPERATE SAFELY - NEVER TAKE CHANCES.**

B. EQUIPMENT:

1. Use only suspended scaffolding system and personal safety equipment designed for the specific job operation.
2. Use equipment only in manner specified by equipment manufacturers.
3. Never use equipment that does not function properly.
4. Clean and maintain equipment as specified by equipment manufacturer. Contact supplier for required service.
5. Never alter, remove or substitute components of a scaffold system.
6. Make sure that platforms have toeboards, rails and other enclosure items which meet governing requirements, and are properly installed and secured.

C. INSPECTION:

1. Inspect all suspension and operators' safety equipment, before installation, each day before use and after moving to new drop location, for damage and that it meets manufacturer's operational performance and safety standards.
2. Inspect wire rope each ascent and descent to insure that it has not been damaged.

D. INSTALLATION:

1. Safe rigging installation is your responsibility.
2. Roof irons, hooks, parapet clamps, outrigger beams, or other rope supporting devices shall be capable of carrying the maximum applied loads with a safety factor of not less than 4:1. The strength of the building or structure to which such equipment is to be attached or on which it will rest, must be verified by a competent person prior to installation.
3. Tiebacks having strength equivalent to the hoisting ropes shall be installed without slack at right angles to the building and be firmly secured to a structurally sound portion of the structure. This structure shall have the capability of supporting the maximum suspended load with a safety factor of not less than 4:1. In the event that the tieback cannot be installed at right angles to the structure face, two tiebacks, without slack, shall be attached to each rope supporting device to prevent movement in any direction.
4. When outrigger beams are used for rope support, the inner end shall be restrained against vertical movement so that the beam is capable of supporting safely the maximum applied rope load with a safety factor of not less than 4:1. If counter-weights are used for beam restraint, they shall be of a non-flowable material, shall carry a weight value and be securely fastened to the beam.

5. When using traction type hoisting machines make sure that the wire rope is long enough to reach from the highest point of support to the lowest point of building structure plus rigging reeving lengths as defined in the hoisting machine manufacturer's instructions.
6. When using drum wrapping hoisting machines make sure that at least four wraps remain on the drum at the lowest point of descent, and the end of the rope is securely attached to the drum.
7. On two point suspension scaffolds make sure that the stirrups are directly under the suspension points.

E. WIRE ROPE:

1. Use only the wire rope and fittings specified by the hoisting machine manufacturer.
2. Use the number of wire rope clamps and tighten clamps in accordance with hoisting machine manufacturer's instructions. Before commencing work operations, preload wire rope with maximum work load, then retighten clamps to manufacturer's torque specifications. Check clamp tightening daily.
3. Inspect wire rope for damage daily. Do not use kinked, bird-caged, corroded, undersize, or damaged wire rope.
4. Clean and lubricate wire rope in accordance with manufacturer's instructions.
5. Handle wire rope with care - coil and uncoil properly. Do not drop coiled or uncoiled wire rope on ground from any height.
6. Do not expose wire rope to fire, undue heat, corrosive atmosphere or chemicals, to passage of electrical currents.
7. When welding on suspended scaffolds protect the wire rope from the welding torch or electrode. Make sure the platform is grounded and stray electrical currents cannot pass thru the suspension rope to ground thru the upper rope support or by contact of the rope with building structure or the ground.

F. SAFETY:

1. Always use safety belts attached by shortest effective lanyards and rope grabbing device to lifeline rigged to a separate building support point capable of carrying loads defined in governing regulations.
2. When working or riding on suspended scaffolds maintain the lanyard attachment to the lifeline at the highest point compatible with work movement.
3. The weight of men, work materials and components mounted on the scaffold must not exceed the manufacturer's rated loads.
4. Two or more scaffolds must not be combined into one by lapping platforms on one stirrup.
5. Do not overload the support rope.

Scaffold Industry Association, Inc. 1977

Permission to reproduce may be obtained from: Scaffold Industry Association, Inc.
Reprinting of this document does not imply membership in the Scaffold Industry Association, Inc.

Form No. 01065

10-77-5001

P/855
008400915

 **GripHoist** Inc.

Main Office: 392 University Avenue - P.O. Box 707 - Westwood, MA 02090 (617) 329-5650
Branch Office: 331 Littlefield Avenue, S. San Francisco, CA 94080 (415) 563-4008