

# hanger

systems



Product Guide

**G** GRIPPLE®

# hanger systems



Sheffield Headquarters (UK)



Manufacturing Plant (UK)



Grippple Europe Office (France)



Grippple Limited has grown rapidly since it launched its original product in 1988. It has sold more than 230 million products to 75 countries worldwide, and now has premises in the UK, Europe and the USA.

It is an award winning company that continues to grow on the strength of its focus on innovation. The commitment to developing new products by its 'Ideas & Innovation' team has made Grippple a market leader.

Achieving high standards is paramount to Grippple, and with the entire range produced at its own manufacturing plant, quality control is guaranteed. This, combined with its strong global sales network and the assurance of millions of customers worldwide, means Grippple is well placed to meet your needs.

While its fencing and trellising products lead the agricultural and viticultural sectors, its pioneering invention of the Grippple Hanger system has also changed the face of the construction industry.

The unique Grippple Hanger has revolutionised installation techniques which can be installed both quickly and easily.

The product is used for suspending or bracing:

- mechanical & electrical services (M&E)
- heating, ventilation and air-conditioning services (HVAC)
- panels for cold rooms
- seismic bracing
- other suspended services

Grippple Hangers are used on major projects worldwide covering industrial buildings, distribution centres, schools, hospitals, warehouses and retail stores. In fact they can be found in some of the most prestigious projects around the world.

With its solution driven products, supported by its product knowledge and customer service, Grippple is well placed to continue leading the way in the agricultural, viticultural and construction markets.

## Contents

The Gripple Fastener	2	How to choose the right size and model	26
End Fixings summary	3	Manufacturer recommendations	27
Applications	4-5	Specials/tailor-made solutions	27
End Fixing product details	6-17	Certified fire safe solutions	28
Accessories	18-25	Instore display merchandisers	28



## Benefits of Gripple – Savings in time and money...

The whole essence of using Gripple to suspend fixed loads is to save you time and money. Gripple is a natural replacement for threaded rod or chain for a number of reasons:

- Fast to install (as much as 6 times)
- Versatile
- Simple to use
- Strong but lightweight
- Safe and aesthetically pleasing to the eye
- Ready to use kits with appropriate wire end fixings



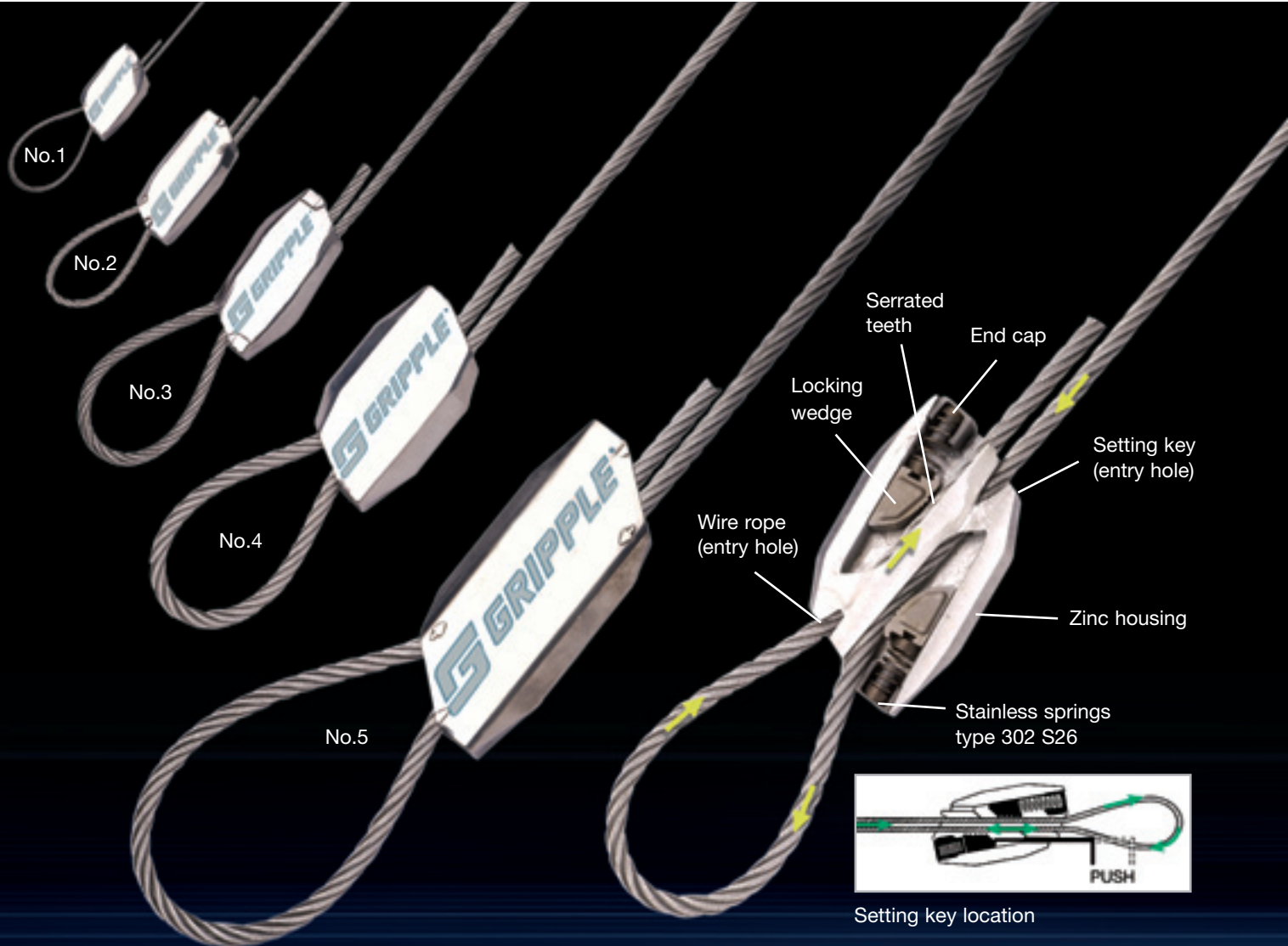

# The Gripple Fastener

The principal element of all Gripple Hanger assemblies is the 'Gripple' fastener, for securing the wire rope and adjusting the height of the service.

Available in 5 hanger sizes

- ready to use kits with a choice of 8 wire end fixings
- available in lengths 1m to 10m as standard – other lengths on request
- stainless hangers available in loop and stud end fixings only



## Gripple Hangers: Standard Product Range

Size	Weight Range	SWL (safe working load)
N°1	0 - 10 kg	10 kg
N°2	10 - 45 kg	45 kg
N°3	45 - 90 kg	90 kg
N°4	90 - 225 kg	225 kg
N°5	225 - 325 kg	325 kg

## Gripple Hangers: Stainless Product Range

Size	Weight Range	SWL (safe working load)
N°2	0 - 45 kg	45 kg
N°3	45 - 90 kg	90 kg



## End Fixings summary



(a)



### Loop (a)

(page 7)

For looping around purlins, beams, roof trusses and other accessible building features. Available in sizes No.1-No.5



(b)



### Stud (b)

(page 8)

For anchoring into concrete ceilings, metal decking and pressed metal brackets (with nuts). Supplied with drop in anchors or nuts as required. Available in M6 x 20mm in sizes No.1-No.3; M8 x 45mm in sizes No.2 and No.3; M10 x 50mm in size No.4



(c)

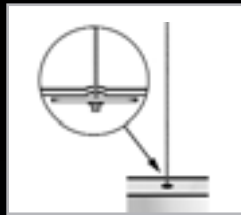

### Toggle (c)

(page 9)

For fastening through profile roof cladding, light fittings, luminaires and other cavities. Available in sizes No.1-No.3



(d)

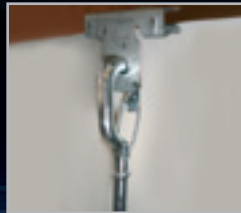

### Snap Hook (d)

(page 10)

Snap-on attachment for clips, brackets and light fittings. Available in sizes No.1-No.3

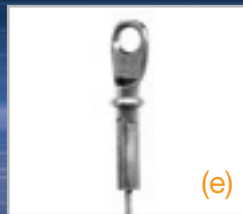

(e)



### Eyelet (e)

(page 11)

For fastening to brackets or fixtures using bolts. Available in sizes No.2 and No.3



(f)

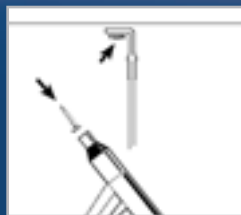

### 90° Eyelet (f)

(page 12)

For quick shot-firing into concrete, steel and wood using gas and powder actuated tools. Available in sizes No.1-No.3



(g)

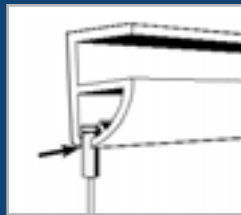

### End Stop (g)

(page 13)

Easy slide-on fixing into lighting channels and lighting track or other channel fixings. Available in sizes No.1-No.3



(h)



### Barrel (h)

(page 14)

For use in conjunction with the M6 T-bar twist clip for suspended ceilings or other fastenings with M6 male thread. Available in size No.2 only



## HVAC & Mechanical applications

- Spiral ducting
- Oval ducting
- Rectangular ducting
- Fan coil units
- Destratification fans
- Extraction ductwork
- Water pipes
- Drainage pipes
- Gas pipes
- Chill beams
- Ceiling panels
- Heating panels
- Radiant heaters





## Electrical applications

- Busbar
- Cable ladder
- Cable tray
- Cable basket
- Channel
- Trunking
- Light rafts
- Luminaires
- Secondary supports
- Safety lines
- High wattage lights
- Electrical cables
- CCTV cameras
- Sound systems

## Other applications

- Cold rooms
- Seismic bracing
- In-store signs & shopfitting
- Food factories\*
- Swimming pool environments\*
- Pest control
- Overhead catenary wires

*\* Stainless steel hangers are suitable for the food industry, swimming pool environments and chemical factories.*

# hanger

systems



## Fixings

Loop End Fixing	7
Stud End Fixing	8
Toggle End Fixing	9
Snap Hook End Fixing	10
Eyelet End Fixing	11
90° Eyelet End Fixing	12
End Stop Fixing	13
Barrel End Fixing	14
Y-Fit Fixing	15
Y-Fit Accessory	16
Catenary Kit – Lockable	17



# Loop End Fixing



## Applications

The loop end fixing is an ideal method for wrapping around:

- Purlins
- Beams
- Roof trusses
- Other accessible building features

## Product Advantages

- Quick choke knot installation
- No need for nuts, bolts, clamp fixing or other accessories
- Up to 6 times faster installation compared with threaded rod or chain

## Loop End Fixing Sizes

Size	Weight range
No.1	0 – 10kg
No.2*	10 – 45kg
No.3*	45 – 90kg
No.4	90 – 225kg
No.5	225 – 325kg

- The above sizes have a 5:1 safety factor.
- Available in lengths 1m to 10m as standard – other lengths on request.

\*Stainless steel loop hangers are available in sizes No.2 and No.3.

example Item order No.	prefix - size - length
	<b>HF - No.2 - 1m</b>

## Loop Specification

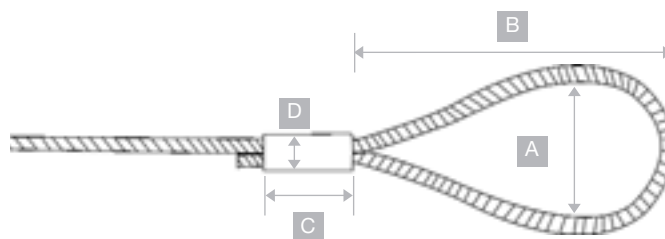

	A (Nominal) mm	B (Nominal) mm	C mm	D mm
No.1	30	60	10	6
No.2	30	60	13	8
No.3	26	60	15	12
No.4	46	85	24	16
No.5	46	90	28	20

## How to Use

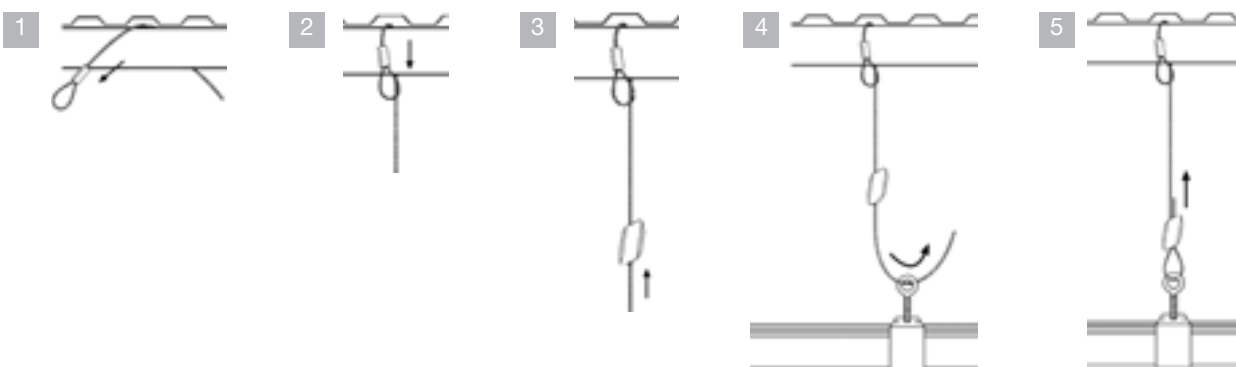

# Stud End Fixing



## Applications

The stud end fixing provides a quick method for installing services into:

- Concrete structures
- Metal decking structures
- Metal brackets using nuts

## Product Advantages

- Quick installation into concrete using drop-in anchors or nuts
- Drop-in-anchors or nuts supplied free as part of the kit
- Available in sizes M6, M8 and M10

## Stud End Fixing Sizes

Size	Weight range	Thread
No. 1	0 – 10kg	M6
No. 2*	10 – 45kg	M6 & M8
No. 3*	45 – 90kg	M6 & M8
No. 4	90 – 225kg	M10

- The above sizes have a 5:1 safety factor.
- Available in lengths 1m to 10m as standard – other lengths on request.

\*Stainless steel stud hangers are available in sizes No.2 and No.3 with M6 and M8 threads.

example	prefix - size - length
Item order No.	<b>HF-SG - No.2 - 1m</b>

## Stud Specification

All standard Gripple studs are manufactured from mild steel which is zinc coated for maximum anti-corrosion properties.

A mm	B mm	C mm
6	20	48
8	45	70
10	50	100

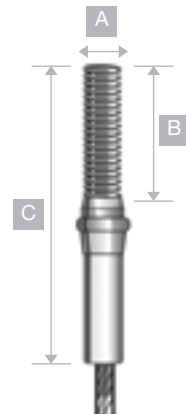

## How to Use

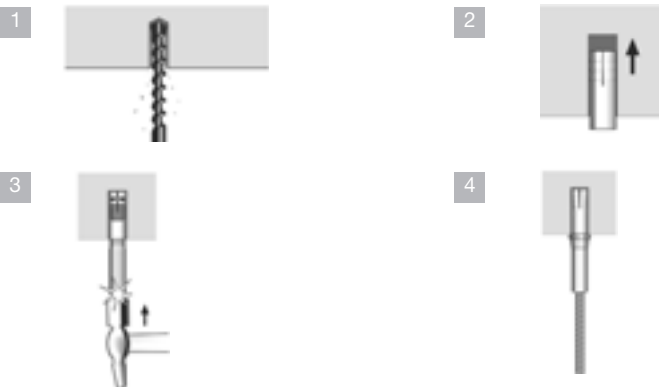

Wire Anchor  
(see page 19)

Alternative fixing arrangement using wire anchor.



# Toggle End Fixing



## Applications

The toggle anchor method, which uses a restraining plate and end stop, provides an ingeniously fast way of fixing into:

- Profile roof cladding
- Light fittings – (including secondary supports)
- Luminaires – (including secondary supports)
- Other pre-drilled structures

## Product Advantages

- Unique anchor method which uses a restraining plate and end stop
- Toggle end fixing is an integral part of the rope, requiring no additional accessories
- Each size is purpose designed to fit a specific hole diameter

## Toggle End Fixing Sizes

Size	Weight range	ø diameter
No.1	0 – 10kg	6mm
No.2	10 – 45kg	8mm
No.3	45 – 90kg	10mm

- The above sizes have a 5:1 safety factor.
- Available in lengths 1m to 10m as standard – other lengths on request.

example  
Item order No. **HF-TG - No.2 - 1m**

## End Stop Specification

Sizes	A mm	B mm	C mm
No.1	4.2	5.7	12
No.2	6.2	7.7	12
No.3	6.2	9.7	18

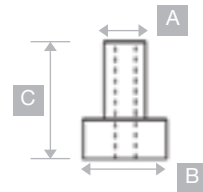

## Toggle Specification

Sizes	A mm	B mm
No.1	5.7	40
No.2	7.8	40
No.3	9.6	50



## How to Use

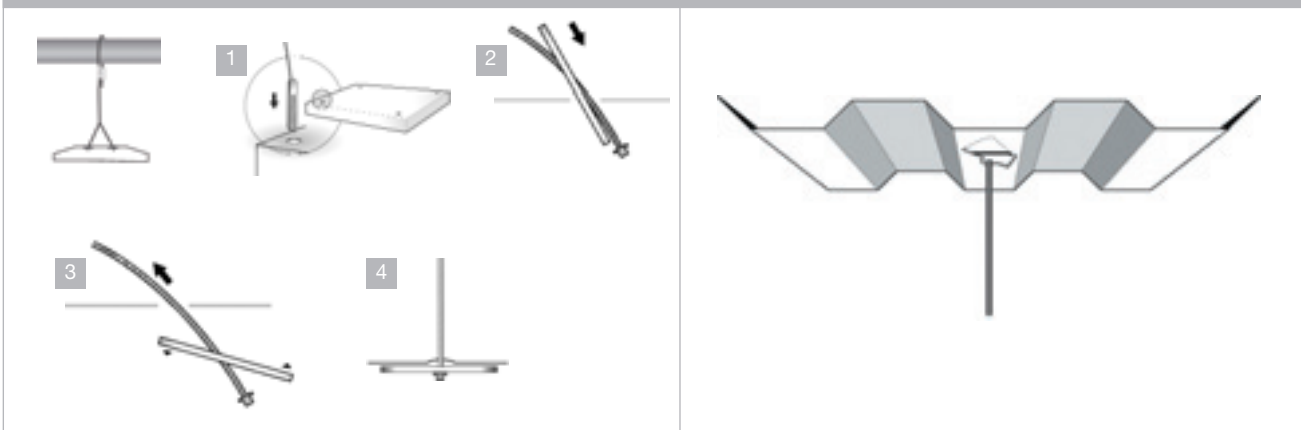



# Snap Hook End Fixing

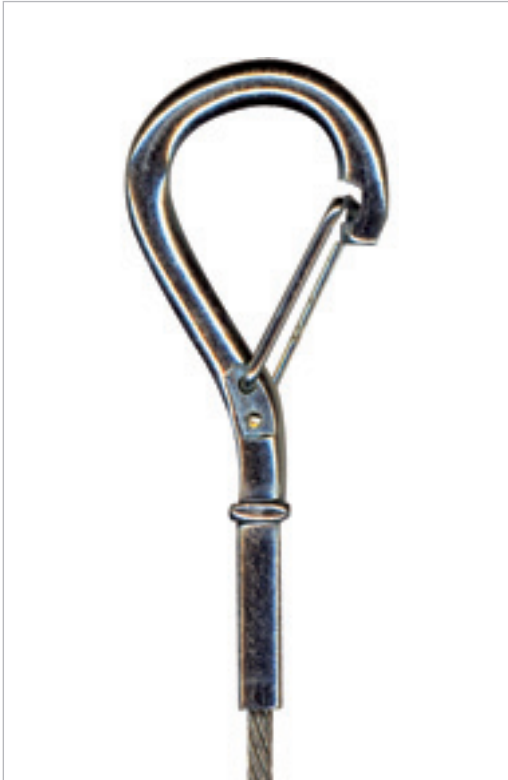

## Applications

The snap hook end fixing is a quick and ideal method for fixing to:

- Beam and purlin clips
- Any clip bracket with a 6mm hole
- Light fittings
- Luminaires
- Heater panels

## Product Advantages

- Easy initial snap-on attachment for securing the Gripple Hanger onto an existing structure
- Ideal for services that require maintenance
- Can be attached to any clip bracket with a 6mm hole
- Can be detached to allow loading of tray or basket with new cables

## Snap Hook End Fixing Sizes

Size	Weight range
No.1	0 – 10kg
No.2	10 – 45kg
No.3	45 – 90kg

- The above sizes have a 5:1 safety factor.
- Available in lengths 1m to 10m as standard – other lengths on request.

example	prefix - size - length
Item order No.	<b>HF-HKG - No.2 - 1m</b>

## Snap Hook Specification

All Gripple snap hook end fixings are zinc plated steel.

Size	A mm	B mm	C mm
No.1	6	16	75
No.2	6	16	75
No.3	6	16	75



## How to Use

1

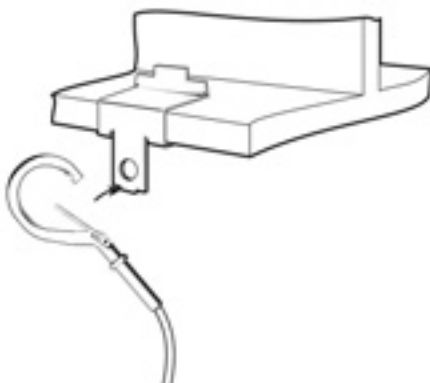

2



# Eyelet End Fixing



## Applications

Suitable for a variety of applications that require bolting to brackets or fixtures such as:

- Speakers or visual display
- Any M6 bolt that is fixed for M&E services
- Light fittings
- Supporting industrial curtain track or shelter and shade netting

## Product Advantages

- Easy attachment using nuts and bolts
- Fix using an M6 bolt

## Eyelet End Fixing Sizes

Size	Weight range
No.2	10 – 45kg
No.3	45 – 90kg

- The above sizes have a 5:1 safety factor.
- Available in lengths 1m to 10m as standard – other lengths on request.

example Item order No.	prefix - size - length
	<b>HF-EYE - No.2 - 1m</b>

## Eyelet Specification

The Grippler eyelet end fixing is made from zinc plated steel.

Size	A mm	B mm	C mm
No.2	6.5	10	45
No.3	6.5	10	45

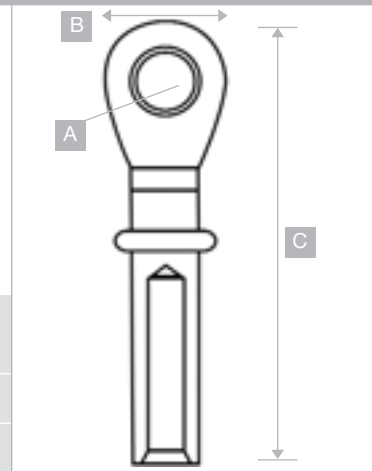

## How to Use

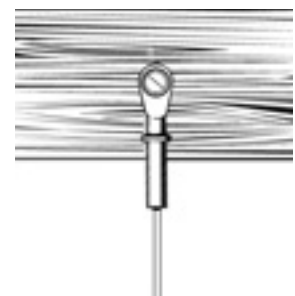
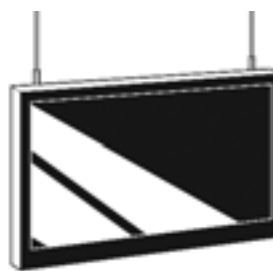
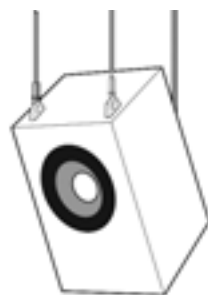

# 90° Eyelet End Fixing



## Applications

Purpose designed for fixing into concrete, steel and wood:

- Suitable for suspending HVAC and mechanical services
- Suitable for use with Gripple Trapeze No.3 on pre-fabricated module systems

## Product Advantages

- Designed for shot-firing into concrete, steel and wood using gas and powder actuated tools
- Replaces beam and purlin clips for steel beams
- Quick and safe, saving time on installation

## 90° Eyelet End Fixing Sizes

Size	Weight range
No.1	0 – 10kg
No.2	10 – 45kg
No.3	45 – 90kg

- The above sizes have a 5:1 safety factor.
- Available in lengths 1m to 10m as standard – other lengths on request.

example Item order No.	prefix	- size	- length
	<b>HF-SEYE90G</b>	<b>- No.2</b>	<b>- 1m</b>

## 90° Eyelet Specification

The 90° Gripple eyelet end fixing is made from zinc plated steel.

Size	A mm	B mm	C mm
No.1	7.3	22.5	40
No.2	7.3	22.5	40
No.3	7.3	22.5	40

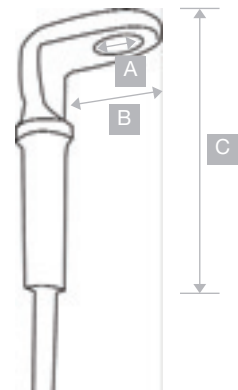

## How to Use

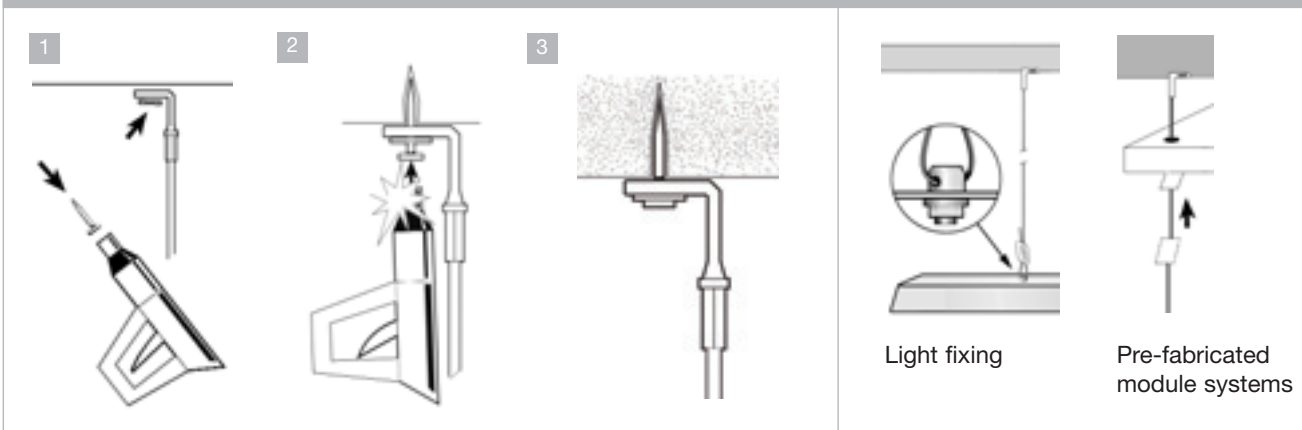



# End Stop Fixing



## Applications

The end stop fixing provides a quick and easy method for fixing to:

- Lighting channels and tracks
- Other channel fixings

## Product Advantages

- Easy slide-on attachment
- Quick and easy to install

## End Stop Fixing Sizes

Size	Weight range
No.1	0 – 10kg
No.2	10 – 45kg
No.3	45 – 90kg

- The above sizes have a 5:1 safety factor.
- Available in lengths 1m to 10m as standard – other lengths on request.

example Item order No.	prefix - size - length
	<b>HF-EG - No.2 - 1m</b>

## End Stop Specification

The Gripple end stop is a mild steel, zinc coated end stop, which is pressed onto the wire rope.

Size	A mm	B mm	C mm
No.1	4.2	5.7	12
No.2	6.2	7.7	12
No.3	6.2	9.7	18

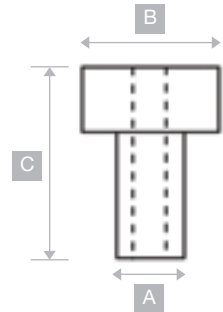

## How to Use



# Barrel End Fixing



## Applications

Designed to work with an M6 male thread, this M6 female threaded barrel unit is suitable for:

- Fixing signage and light fixtures to M6 T-bar twist clip on suspended ceilings. (See page 19)
- M6 bolts or screws

## Product Advantages

- Aesthetic finish provides a clean look
- Quick installation
- Screw onto M6 T-bar twist clip or M6 bolt
- Wire rope is an integral part of barrel fixing with an end stop

## Barrel End Fixing Sizes

Size	Weight range
No.2	10 – 45kg

- The above sizes have a 5:1 safety factor.
- Available in lengths 1m to 10m as standard – other lengths on request.

example Item order No.	prefix - size - length <b>HF-B6G - No.2 - 1m</b>
---------------------------	---

## Barrel Specification

The Gripple barrel end fixing is made from zinc plated steel.

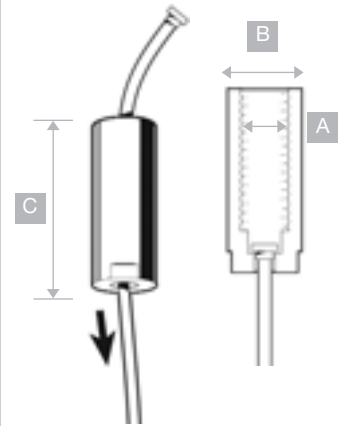

Size	A mm	B mm	C mm
No.2	6	12	30

## How to Use

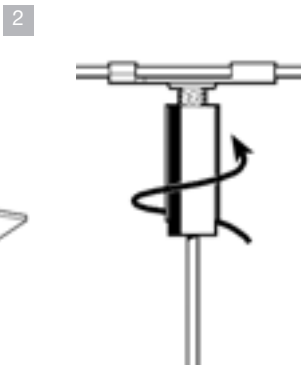
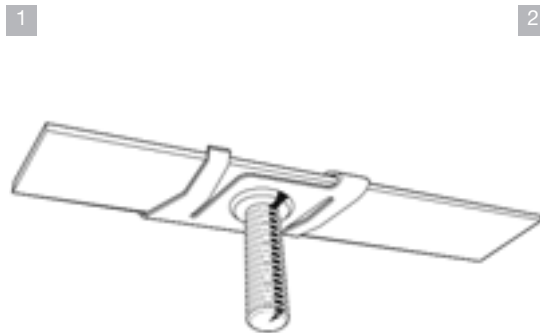

Alternative fixing arrangement.

# Y-Fit Fixing



## Applications

The Gripple Y-Fit is available in all standard Gripple end fixings and is suitable for:

- Containment – basket, ladder and tray
- Profile roof cladding
- Secondary or safety line support on light fittings, luminaires and other cavity uses
- Legs not to exceed 60°

## Product Advantages

- Single point suspension
- Allows two points to be suspended using one Gripple fastener
- Two legs provide stability improving the centre of gravity

## Y-Fit End Fixing Sizes

Size	Weight range
No.1	0 – 10kg
No.2*	10 – 45kg
No.3*	45 – 90kg



- The above sizes have a 5:1 safety factor.
- Product made to special order. Please consult your sales manager
- Dimensions A and B should be specified  
A – overall length  
B – leg length

\*Stainless options are available in loop and stud end fixings.

## Y-Fit End Fixing Specification

Choose from End Fixings below

<b>90° Eyelet end fixing No.1-No.3</b>	<b>Eyelet end fixing No.2-No.3</b>	<b>End stop fixing No.1-No.3</b>	<b>Barrel end fixing No.2</b>
<b>Karabiner end fixing No.1-No.3</b>	<b>Snap hook end fixing No.1-No.3</b>	<b>Stud (M6/M8) end fixing No.1-No.3</b>	<b>Toggle end fixing No.1-No.3</b>

## How to Use

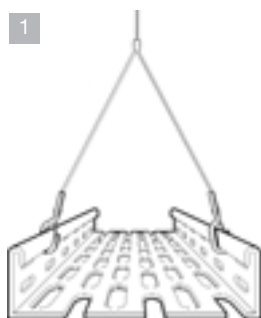

Y-Fit snap-on-hook on cable tray

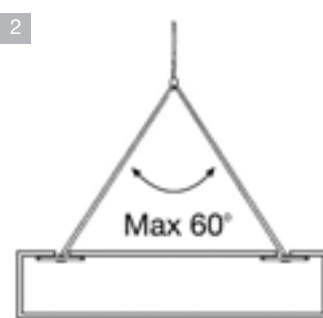

Y-Fit toggle on light fitting



Y-Fit loop on light fitting



Completed suspension



# Y-Fit Accessory



## Applications

The Gripple Y-Fit Accessory is available in all standard Gripple end fixings and is suitable for:

- Containment – basket, ladder and tray
- Profile roof cladding
- Secondary or safety line support on light fittings, luminaires and other cavity uses

## Product Advantages

- Easily adjusted at working level with standard Gripple Hangers making it suitable for long drops

## Y-Fit End Fixing Sizes

Size	Weight range
No.1	0 – 10kg
No.2*	10 – 45kg
No.3*	45 – 90kg

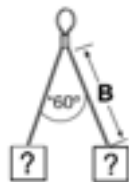

- The above sizes have a 5:1 safety factor.
- Dimension B (leg length) should be specified
- Product made to special order.
- Please consult your local Sales Manager.

\*Stainless options are available in loop and stud end fixings.

## Y-Fit End Fixing Specification

Choose from End Fixings below

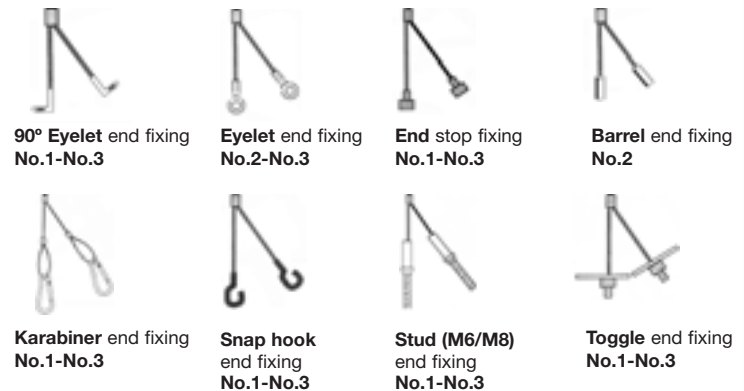

## How to Use

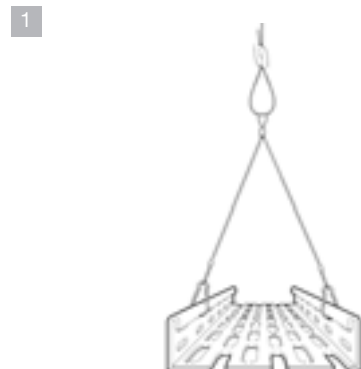

1. Y-Fit accessory on cable tray
2. Y-Fit accessory on light fitting

# Catenary Kit – Lockable



## Applications

- Designed for securing catenary wires between two fixed points
- Suitable for supporting a variety of M&E services

## Advantages

- Quick installation replacing turnbuckle and wire strainers
- Easy tensioning using Gripple Tensioning Tool (see page 25)

## Catenary Kit Sizes

Ø diameter	Length of wire rope	Max SWL
5mm x2	10m	80kg
5mm x2	15m	80kg
5mm x2	20m	80kg
6mm x2	10m	100kg
6mm x2	15m	100kg
6mm x2	20m	100kg

- The above sizes have a 5:1 safety factor
- Other lengths available on request
- To load the installation use the Gripple tensioning tool (see page 25)

example	prefix	-	pack size	-	length
Item order No.	<b>5mm-LOCK</b>	-	<b>2</b>	-	<b>10m - pack</b>

## How to Use

1



2



3



4

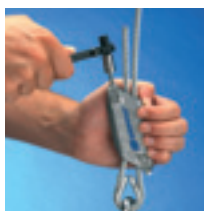

# hanger

systems

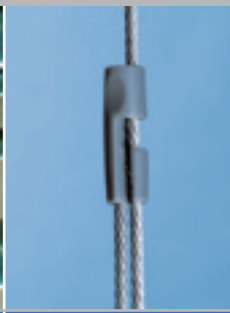
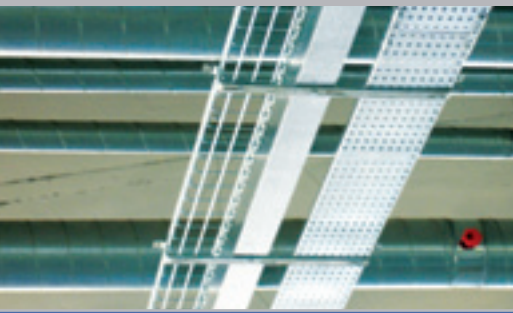

## Accessories

### Fixing Solutions

19-23

- Threaded Adaptor
- Wire Anchor
- Spring Clip
- T-Bar Twist Clip
- Beam & Purlin Clips
- Pigtail Anchor Bolts
- Drop-in Anchor
- Eyebolt – Steel or Concrete
- Link Hook
- Ceiling Clip
- Ceiling Clip for wood
- Eyelet Anchor

### Decorative Products

23-24

- Karabiners
- Decor Cover
- Corner Saddle
- Trapeze Fastener
- Ceiling Fixing Kit
- Twister

### Installation Tools

25

- Tensioning Tool
- Setting Key
- Protective Sleeve Tubing
- Sleeve Tube Cutter
- Setting Punch for Drop-in Anchor
- Wire Rope Cutter
- Workbelt

### Threaded Adaptor

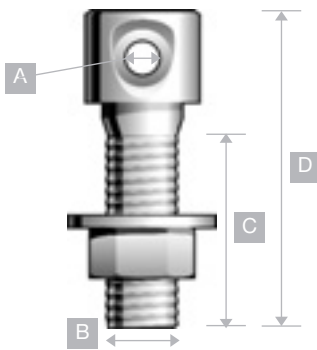

- Ideal for fixing to:
- Luminaires
  - Drop-in anchors
  - Cable tray
  - Hanging brackets
  - Other services with 6mm or 8mm hole
  - 5:1 safety factor

Product code	A mm	B mm	C mm	D mm	Max SWL
HF-ADAPTOR-UNIT-M6	3.5	6	20	27	90kg
HF-ADAPTOR-UNIT-M8	5.5	8	25	37	225kg

### Wire Anchor

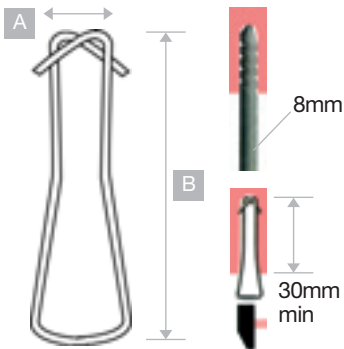

- Made from high tensile stainless steel
- The wire anchor is easily fixed into concrete
- Drill an 8mm diameter hole to a minimum depth of 30mm
- 3:1 safety factor

Product code	A mm	B mm	Max SWL
HF-WIRE ANCHOR	13.4	50	75kg

### Spring Clip

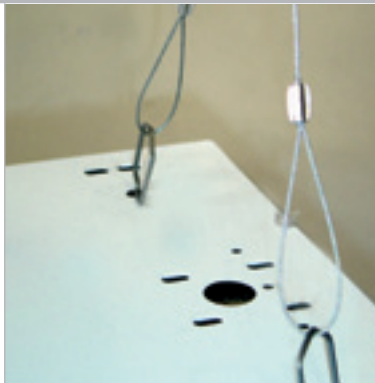
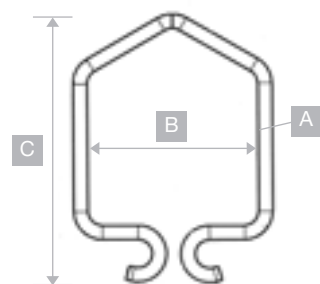

- Ideal for fixing to suspended services with 6mm-10mm holes
- Spring action prevents pullout
- 3:1 safety factor

Product code	A mm	B mm	C mm	Max SWL
HF-SPRING-CLIP	2	24	38	45kg

### T-Bar Twist Clip

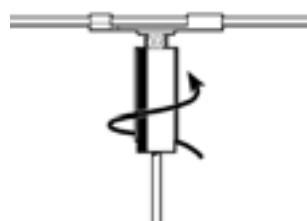
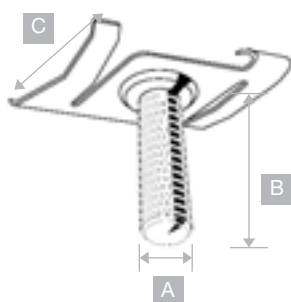

- M6 Twist clip for supporting fittings etc below the ceiling grid
- 3:1 safety factor

Product code	A mm	B mm	C mm	Max SWL
HF-TBAR-CLIP-M6	6	25	16	22kg

# Accessories – Fixing Solutions

## Beam & Purlin Clips



- Ideal for attaching Gripple Hangers, particularly when access or drilling restrictions are encountered.
- 3:1 safety factor

Beam Clip	Vertical Flange Clip	Purlin Clip	Z Purlin Clip	Tiger Clip		
<p>HF-GCB24 HF-GCB59 HF-GCB1016 HF-GCB1720</p>	<p>HF-GCVF15 HF-GCVF57</p>	<p>HF-GCP45</p>	<p>HF-GCPZ48</p>	<p>HF-TIGERCLIP-2-8 HF-TIGERCLIP-8-16</p>		
Product	Product code	A mm	B mm	C mm	D mm	Max SWL
<b>Beam Clip</b>						
2-4mm	HF-GCB24	6.5	2 - 4	29	29	72kg
5-9mm	HF-GCB59	6.5	5 - 9	38	32	90kg
10-16mm	HF-GCB1016	6.5	10 - 16	38	42	90kg
17-20mm	HF-GCB1720	6.5	17 - 20	38	48	90kg
<b>Vertical Flange Clip</b>						
1-5mm	HF-GCVF15	6.5	1 - 5	19	50	72kg
5-7mm	HF-GCVF57	6.5	5 - 7	19	50	72kg
<b>Purlin Clip</b>						
4-5mm	HF-GCP45	6.5	14	19	45	20kg
<b>Z Purlin Clip</b>						
4-8mm	HF-GCVZP48	6.5	2.5	15	64	45kg
<b>Tigerclip</b>						
2-8mm	HF-TIGERCLIP-2-8	6.5	2 - 8	30	-	120kg
8-16mm	HF-TIGERCLIP-8-16	6.5	8 - 16	38	-	120kg

## Pigtail Anchor Bolts

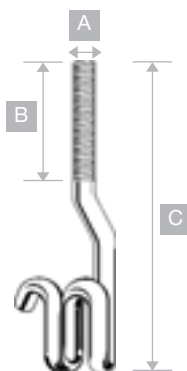

- Fast loop-on fixing for the Gripple loop end hanger
- 5:1 safety factor

Product code	A mm	B mm	C mm	Max SWL
HF-PIGTAIL-20MM-M6	6	20	106	90kg
HF-PIGTAIL-45MM-M6	6	45	118	90kg
HF-PIGTAIL-45MM-M8	8	45	118	150kg



### Drop-in Anchor

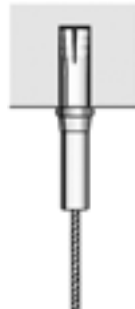
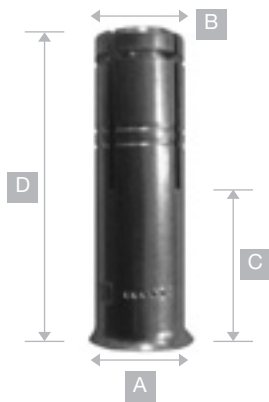

- Punch activated Grip L anchors for fixing into concrete and hollow core ceiling slabs
- All stud kits include free drop-in anchors
- A minimum of 25mm concrete is required
- ETA approved
- Accepts Gripple Pigtail anchor bolts
- 5:1 safety factor

Product code	A mm	B mm	C mm	D mm	Max SWL
HF-DROPIN-ANCHOR-M6	6	8	13	30	90kg
HF-DROPIN-ANCHOR-M8	8	10	13	30	90kg
HF-DROPIN-ANCHOR-M10	10	12	15	40	225kg

### Eyebolt – Steel or Concrete

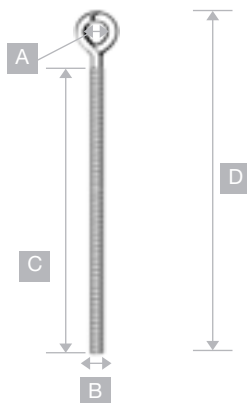

- Available in two sizes, M8 or M10, and each can be either full or part threaded
- Can be used with a nut or drop-in anchor
- 5:1 safety factor

Product Code	A mm	B mm	C mm	D mm	Max SWL
EYEBOLT-M8-200MM-98MM	15	8	98	230	325kg
EYEBOLT-M8-0.2M-F/THR	15	8	190	230	325kg
EYEBOLT-M10-200MM-98MM	15	10	98	230	325kg
EYEBOLT-M10-0.2M-F/THR	15	10	190	230	325kg

### Link Hook

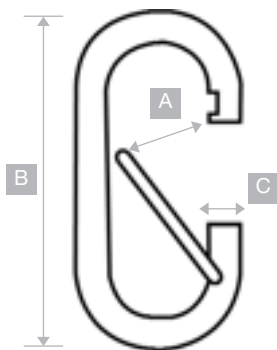

- Easily attached to any loop end hanger
- Ideal for fixing to cable trays
- 3:1 safety factor

Product Code	A mm	B mm	C mm	Max SWL
LINK-HOOK	20	62	6	90kg

# Accessories – Fixing Solutions

## Ceiling Clip

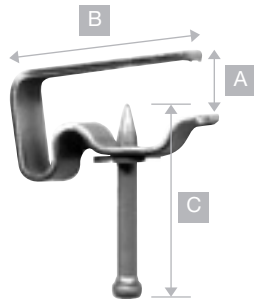

- Loop end fixing simply engages in the valley of the clip
- Available with plastic and metal washers for concrete and steel
- After firing, the nail completely entraps the Gripple loop fixing, but still allows pivotal movement of the wire rope
- Weight loadings are dependent on the type of concrete/steel.
- Always carry out a pull-test on site to determine the weight loadings

Product code	A mm	B mm	C mm	Max SWL
HF-CLIP-P19 (M19) Steel	15	32	19	90kg
HF-CLIP-P32 (M32) Concrete	15	32	32	90kg

## Ceiling Clip for wood

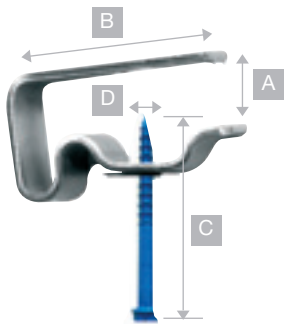

- Loop end fixing simply engages in the valley of the clip
- Drill a hole using a 5mm drill to a minimum depth of 25mm
- Fix the screw using an 8mm socket
- Also available: Drive thru® socket for attachment to drill (HF-socket-8mm)

Product code	A mm	B mm	C mm	D mm
HF-CLIP-W32	15	32	32	6

## Eyelet Anchor – Self Expanding

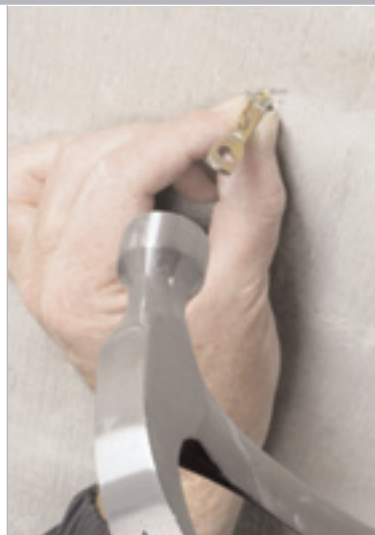
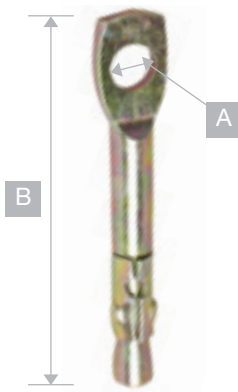

- Self-expanding eyelet anchor
- Drill 6mm hole to 43mm depth and hammer into concrete
- To set, tug with a claw hammer
- 3:1 safety factor

Product code	A mm	B mm	Max SWL
HF-CWH6	6.2	55	45kg

## Karabiners

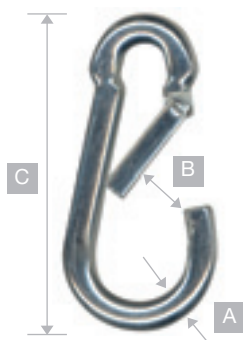

- For use with loop end hangers
- Also available in stainless steel
- 3:1 safety factor

Product code	A mm	B mm	C mm	Max SWL
HF-CARBINE HK 6/60	6	9	60	45kg
HF-CARBINE HK 6/60 SS	6	9	60	45kg
HF-CARBINE HK 8/80	8	9	80	90kg
HF-CARBINE HK 8/80 SS	8	9	80	90kg

## Decor Cover



- An aesthetic snap-fit plastic cover which protects the Gripple from the ingress of paint
- Available in two versions to fit sizes No.2 and No.3

Product code	A mm	B mm
HF-DECOR-COVER-NO2	41	60
HF-DECOR-COVER-NO3	41	60

## Corner Saddle

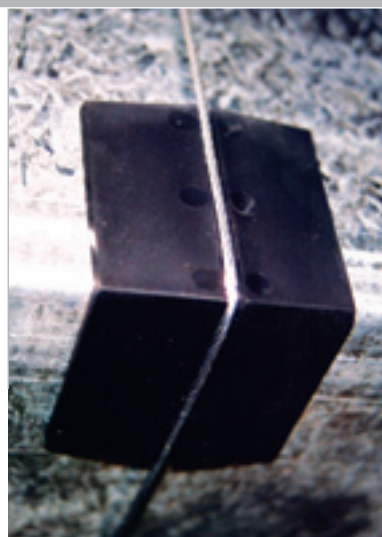
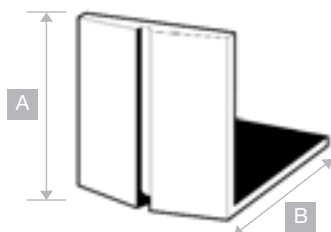

- A right-angled reinforcement moulding for positioning and supporting Gripple Hangers sizes No.1-No.3
- Designed for rectangular ductwork

Product code	A mm	B mm
HF-CORNER-SADDLE	50	50

## Accessories – Decorative Products

### Trapeze Fastener



- Purpose-made one-way Grippler for use on Grippler Hanger size No.3
- Load rated at 90kg
- Ideal for multi-tiered installations
- 5:1 safety factor

Product code

HF-TRAPEZE-NO3

### Ceiling Fixing Kit

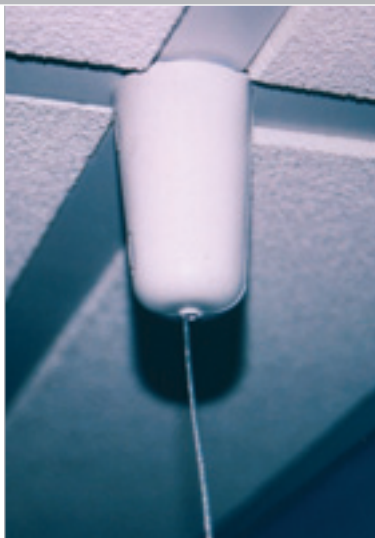
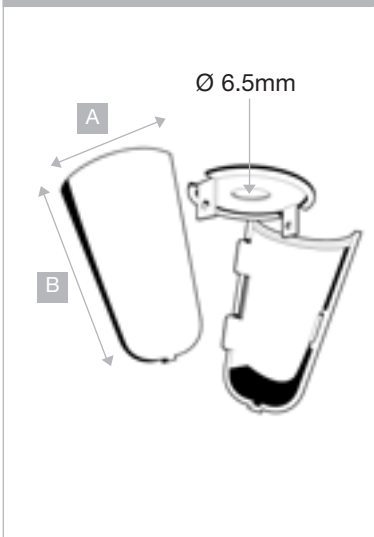

- A decorative ceiling fixing
- Ideal when suspending luminaires and lighting in offices, public buildings or retail premises
- 5:1 safety factor

Product code	A mm	B mm	Max SWL
HF-CEILING COVER	35	60	10kg

### Twister

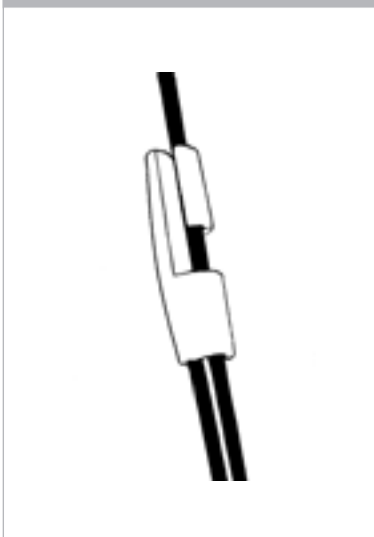

- New innovative system for securing tail wires
- Tough, safe, simple and tidy
- Suitable for use with sizes No.2 and No.3
- Can be fitted retrospectively

Product code

TWIST-100B

# Accessories – Installation Tools

## Tensioning Tool



- A purpose-made tool for quickly tensioning the wire rope
- Suitable for use on the higher rated hanger sizes No.4 and No.5
- Applies up to 400kg of load

Product code

TOOL-3-6MM-LOCK-1BX

## Setting Key



- Easy grip setting key for use with Gripple Kits
- Available in two sizes for No.1-No.3 and No.4-No.5

Product code

KEY-HF-LOGO-NO1/NO3

KEY-HF-LOGO-NO4/NO5

## Setting Punch for Drop-in Anchor



- Available in 3 sizes M6, M8 and M10 for use with Drop-in anchor

Product code

HF-SET-PUNCH-M6

HF-SET-PUNCH-M8

HF-SET-PUNCH-M10

## Protective Sleeve Tubing



- Protective black plastic sleeve tubing to further reduce risk of condensation
- Suitable for use with Gripple Hanger sizes No.2 and No.3

Product code

HF-SLEEVE-2MM (No.2)

HF-SLEEVE-3MM (No.3)

## Wire Rope Cutter

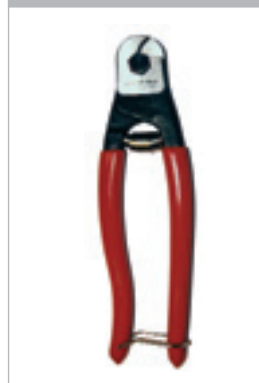

- A purpose-made tool for cutting wire rope
- Suitable for use on the Gripple range sizes No.1-No.4

Product code

CUTTER-GRIPPLE

## Sleeve Tube Cutter

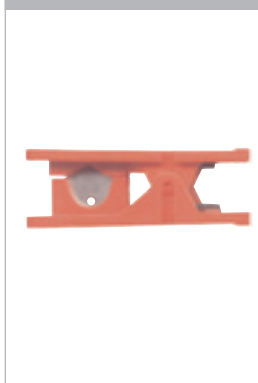

- For cutting the sleeve tubing to length
- Cuts both 2mm and 3mm tubing

Product code

CUTTER-HOSE

## Workbelt



- Professional workbelt
- Keeps tools and products handy

Product code

WORKBELT-CANVAS



# How to choose the right size and model

1. Choose the size where the object's weight falls within the product's working range. Examples of the calculation formula are detailed below.
2. Unless specified, each of our end fixings maintains the load ratings of the individual kits.
3. Each size has a specified safe working load rated at 5:1, and offers a working load range.
4. The load range should be observed; choosing a size that is lighter or heavier than necessary is counter-productive, both functionally and financially.
5. Remember to adjust your size choice, if the hanger is to be used at an angle other than vertical. The table below (effect on SWL of hanging objects at an angle) shows the effect a sideways load has on a vertical installation.
6. In areas of high humidity (a paper factory) and frequent wash down (a food processing factory), stainless steel kits should be considered for extended life performance.

## Calculation formula

A simple formula to determine the correct hanger size is:

### Weight per metre x distance between hangers

**Example 1:** 15kg load per metre  
 $15 \times 2 = 30\text{kg}$  → Distance between hangers is 2m  
 Plane: vertical  
**Size will be No.2**

**Example 2:** 60kg load per metre  
 $60 \times 2.5 = 150\text{kg}$  → Distance between hangers is 2.5m  
 Plane: vertical  
**Size will be No.4**

## Effect on SWL of hanging objects at an angle

The load rating for a Gripple Hanger is based on the suspension being hung vertically. If the wire rope is suspended at an angle, an additional sideways load is applied which reduces the load capacity of the suspension. The net effect is shown in the table below:

Maximum SWL (kg) at an angle from vertical

Gripple Hanger	0° vertical	15°	30°	45°	60°
No.1	10.0	9.6	8.6	7.0	5.0
No.2	45.0	43.2	38.7	31.5	22.5
No.3	90.0	86.4	77.4	63.0	45.0
No.4	225.0	217.3	194.8	159.1	112.5
No.5	325.0	313.9	281.4	229.8	162.5
Load %	100	96	86	70	50

# Manufacturer's recommendations

**Environment** – Standard Gripple Hangers may be used only in dry locations. Stainless steel Gripple Hangers may be used in certain indoor corrosive environments such as properly ventilated swimming pool arenas.

**Load** – Do not exceed the Safe Working Load (SWL) of any Gripple product.

**No lifting** – Do not use for lifting, such as in a crane or pulley situation.

**No movement** – Gripple Hangers are to be used to suspend static loads only. Do not use to suspend moving services, or services likely to be subject to movement.

**No joining** – Gripple Hangers must not be spliced together using a Gripple fastener, or any other joining device. A Gripple Hanger assembly must comprise one length of cable and one Gripple fastener only. If a longer length is needed, do not attempt to join two assemblies together.

**Limitations of use** – All Gripple Hangers, accessories and other Gripple products must only be used for suspending items recommended by the manufacturer.

**Painting** – If painting, ensure that a Gripple Décor Cover is applied to the Gripple fastener before painting to protect from the ingress of paint. Do not move the Gripple fastener on the cable after painting.

**Building codes** – Compliance with local codes, and where applicable national codes, is the buyer and/or installers responsibility.

**Lubricants** – Do not apply oil or any other lubricant to any part of the assembly

**Round duct/pipes** – When wrapping around duct or other round pipes, do not exceed an angle of 60 degrees between the top of the pipe and the Gripple.

**Not for re-use** – Gripple Hangers are designed for permanent installations, not for re-use.

**Y-Fit installation angle** – Legs on Y-fit hangers not to be installed at angles greater than 60 degrees.

*Failure to observe these usage instructions may result in product malfunction, resulting in property damage and bodily injury. At time of shipment Gripple products are warranted to conform to the manufacturer's published specifications and to be free from defects in material and workmanship. No other warranty, whether expressed or implied, including any warranty of merchantability or fitness for purpose, whether expressed or implied, shall exist in connection with the sale or use of any Gripple product.*

## General Guidelines for Swimming Pool Environments

- Please be aware of stress corrosion cracking (SCC) in swimming pool environments.
- In order to safeguard against SCC, please ensure at least two inspections are carried out each year of Safety critical components by a competent third party.
- Gripple cannot guarantee its products against SCC due to the high levels of inspection and maintenance required.

The above information is taken from the Health and Safety Executive (HSE) report published in 1995 relating to swimming pool environments.

# Specials/tailor-made solutions

We are specialists in solving our customers' problems by offering a number of tailor-made hanger solutions. We control all of our manufacturing at our award winning ISO 9001 factory, and can custom make virtually any type of wire end fixing, or offer a number of accessories which meet customers' needs. Please contact us to discuss specific requirements.

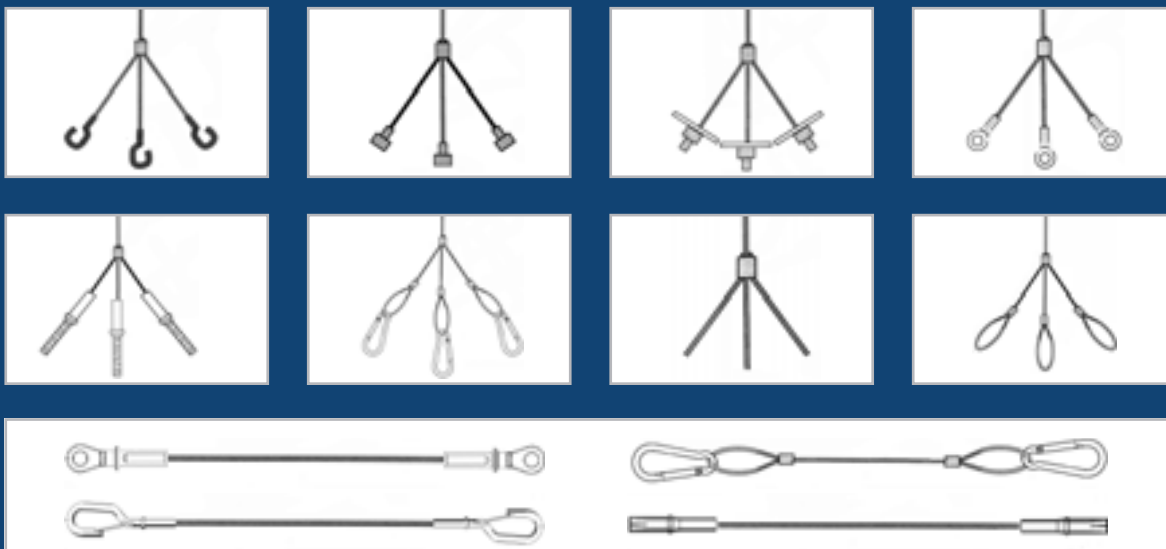

## Certified fire safe solutions

### Standard Range – Temperature tested

- Standard range of No.1-No.3 Gripple Hangers have been tested at 250° C
- The test was independently witnessed by Chiltern International Fire Ltd
- Maximum rating of 60 minutes applies to the 3 sizes

### Stainless Steel – Fire certified DIN Standard

- Stainless range of No.2 and No.3 Gripple Hangers have been tested to DIN 4102-2 “Fire Behaviour of Building Materials and Building Components”
- The test has been independently witnessed by Intertek Testing Services
- Maximum rating of 20kg for 30 minutes achieved for the No.2 Gripple Hanger
- Maximum rating of 60kg for 45 minutes achieved for the No.3 Gripple Hanger



## In-store display merchandisers



# hanger

systems



**For further details contact:**

Gripplé Ltd. (Headquarters)  
The Old West Gun Works  
Savile Street East  
Sheffield S4 7UQ  
England

Tel: +44 (0)114 275 2255  
Fax: +44 (0)114 275 1155  
Email: [info@gripplé.com](mailto:info@gripplé.com)

Gripplé Inc.  
1510 Hubbard Avenue  
Batavia  
Illinois 60510  
USA

Tel: + 1 630 406 0600  
Fax: + 1 630 406 0664  
Email: [info@gripplé.com](mailto:info@gripplé.com)

Gripplé Europe S.à.r.l  
1, rue du commerce  
BP 37  
F67211 Obernai Cedex  
France

Tel: +33 (0)3 88 95 44 95  
Fax: +33 (0)3 88 95 08 78  
Email: [info@gripplé.com](mailto:info@gripplé.com)

Gripplé GmbH  
Sophienstrasse 22  
D76530 Baden-Baden  
Germany

Tel: +49 (0)700 95 44 95 11  
Fax: +49 (0)700 95 08 78 11  
Email: [info@gripplé.com](mailto:info@gripplé.com)

[www.gripplé.com](http://www.gripplé.com)