

# **GSM/GPRS/GPS Portable Tracker User Manual**



## **Preface**

Thank you for purchasing the tracker. This manual shows how to operate the device smoothly and correctly. Make sure to read this manual carefully before using this product. Please note that specification and information are subject to changes without prior notice in this manual.

Any change will be integrated in the latest release. The manufacturer assumes no responsibility for any errors or omissions in this document.

# Contents

1	Summary .....	1
2	Applications .....	1
3	Hardware Description .....	1
4	Specifications .....	2
5	Quick charger .....	2
6	Start to use .....	2
6.1	Insert SIM card, turn on the device .....	2
6.2	Device status light .....	3
6.3	GPRS configuration for live real-time tracking .....	4
6.4	Mobile APP .....	5
6.5	BAANOOL IOT's Web Version .....	9
7	Function details .....	12
7.1	Changing password .....	12
7.2	Authorization .....	13
7.3	Single tracking .....	13
7.4	Continuous interval tracking .....	14
7.4.1	Limited times tracking at a time interval .....	14
7.4.2	Unlimited times tracking at a time interval .....	14
7.4.3	Unlimited times tracking at a distance interval .....	15
7.4.4	Smart tracking at both time and distance interval .....	15
7.4.5	Cancel interval tracking .....	15
7.5	Smart angle updating .....	15
7.6	GPS drift suppression .....	16
7.7	Exact street address .....	16
7.8	Location based service (LBS) / Cell-ID tracking .....	16
7.9	Auto answer .....	17
7.10	Forwarding incoming SMS messages .....	17
7.11	SIM Card Balance Enquiry .....	17
7.12	Configure times of alarm SMS .....	18
7.13	Alarms .....	18
7.13.1	Low battery alarm .....	18
7.13.2	Blind area alarm .....	18
7.13.3	Geo-fence .....	19
7.13.4	Movement alarm .....	19
7.13.5	Over speed alarm .....	20
7.13.6	Acceleration Sensor Alarm .....	20
7.14	Sleep .....	21
7.14.1	No sleep (Always online) .....	22
7.14.2	Sleep by shock .....	22

7.14.3	Sleep by time .....	22
7.14.4	Deep sleep by shock .....	22
7.14.5	Schedule report .....	23
7.14.6	Deep sleep by shock + Schedule report .....	23
7.15	Check Status .....	23
7.16	Check IMEI.....	24
7.17	Local time setting .....	24
7.18	Reset Hardware.....	24
7.19	Configure parameters by USB .....	24
7.20	GPRS configuration for live real-time tracking .....	25
7.21	Configure SMS monitoring center number .....	27
7.22	Configure heartbeat package interval .....	27
7.23	Initialization .....	28
8	Cautions.....	28
9	Troubleshooting .....	28

# 1 Summary

This product is based on the GSM / GPRS network and GPS satellite positioning system. It integrates anti-theft alarm, positioning, auto answer, first aid and tracking functions in a brand new product which can locate or monitor remote targets through SMS text messages or the Internet.

# 2 Applications

Mainly used in the positioning and tracking services of the moving objects.

# 3 Hardware Description

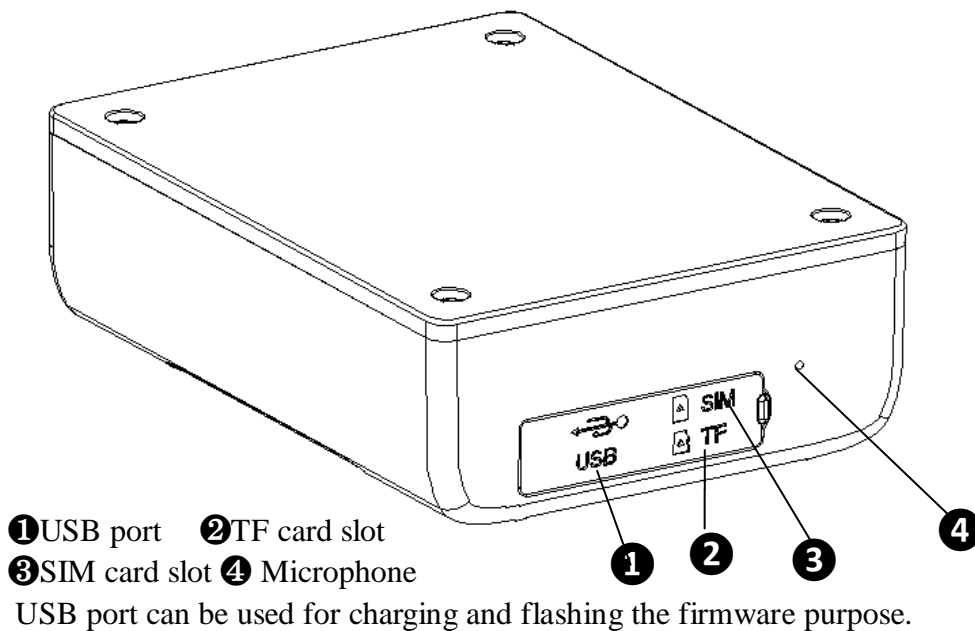

## 4 Specifications

Content	Parameters
DIM	85mm x 65mm x 27mm
Weight	188g
Network	GSM/GPRS
Band	850/900/1800/1900Mhz
GPS sensitivity	-165dBm
GPS accuracy	5m
GPS start time	Cold status 45s Warm status 35s Hot status 1s
Battery	Chargeable 3.7V 5000mAh Li-ion battery
Storage Temp	-40° C to +85° C
Operation Temp.	-20° C to +55° C
waterproof level	IP67

## 5 Quick charger

This device supports maximum 2A current quick charger.

Charger way: Connect the device to the AC adapter (Output voltage: 5V, current:  $\geq 2A$ ) with the original MICRO USB cable.



Warning: Please use the original USB cable to charge, if lost the original USB cable, the replacement USB cable is required to carry at least 2.5A.

Please use the manufacturer's original charger and battery; the charge time of the battery is about 7-9 hours.

Warning: Lithium batteries contain harmful chemical constituents and may explode, please do not slam, stab or put into the fire.

## 6 Start to use

### 6.1 Insert SIM card, turn on the device

Attention: Please be sure to open the voice call, caller display function and subscribe data plan, and PIN code is off, no call forwarding function. The recommended data plan package should be 30MB per month minimum.

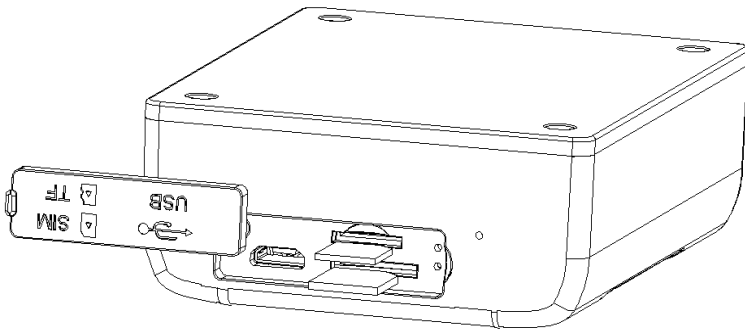

- ❶ Open the soft glue plug.
- ❷ Insert TF card as the picture shows.
- ❸ Insert SIM Card as the picture shows, and tracker will be turned on automatically.

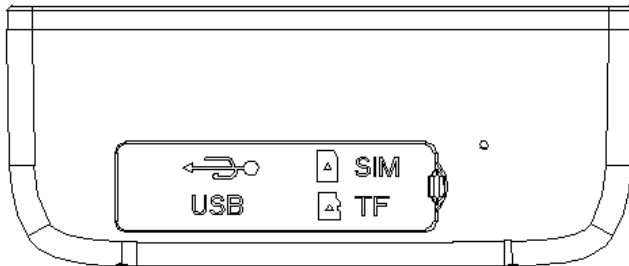

- ❹ Cover the soft glue plug

After turn on, please bring the device outdoors for the first time to wait for about 10- 40 seconds to search for GSM and GPS signals to start work normally.

## 6.2 Device status light

Light	Status	
Power light (Red)	Flash	Low battery
	On	Charging
	Off	Finished charging
GSM light (Green)	On	No GSM signal
	Flash 1 time each second	GSM mode
	Flash 2 times each second	GSM mode and fix to satellites
	Flash 3 times each second	GSM mode, perfect GPS signal
	Flash slowly 1 time each 3 seconds	GPRS mode
	Flash slowly 2 or 3 times each 3 seconds	GPRS mode, fix to satellites with perfect signals

## 6.3 GPRS configuration for live real-time tracking

Usually, the device can automatically recognize and select the APN, user name and password of GPRS settings. If the device cannot connect to the web platform, then you need to use the mobile phone text message to configure the settings according to following steps.

### 6.3.1 Configure APN setting

APN is an abbreviation for Access Point Name and changes depending on which mobile network you are using. For more information about your local APN, please check with your local wireless carrier.

SMS command: **APN+password+space+local APN**

Tracker response: **APN OK**

Example: **APN123456 CMNET**

Note: 123456 is the default password, please change password on APP or refers to 7.1. CMNET is the APN of China mobile.

### 6.3.2 Configure user name and password of GPRS

In the most countries, the user name and password of GPRS are not necessary; therefore, you can ignore this step if it is not necessary for your local network. For those countries requiring user name and password, please configure as following:

SMS command: **up+password+space+user+space+password**

Tracker response: **user, password ok!**

Example: **up123456 Jonnes 666666**

Note: 123456 means the password of the device, Jonnes means the user name of gprs, and 666666 means password of gprs, please configure it according to the user name and password of your local ones, you can check this information with your local wireless carrier.

## 6.4 Mobile APP

### 6.4.1 Scan the QR code to download APP



Google Play、App Store search “BAANOOL IoT” to download it.

### 6.4.2 Binding device

#### 6.4.2.1 Open BAANOOL IoT, register a new account and login.

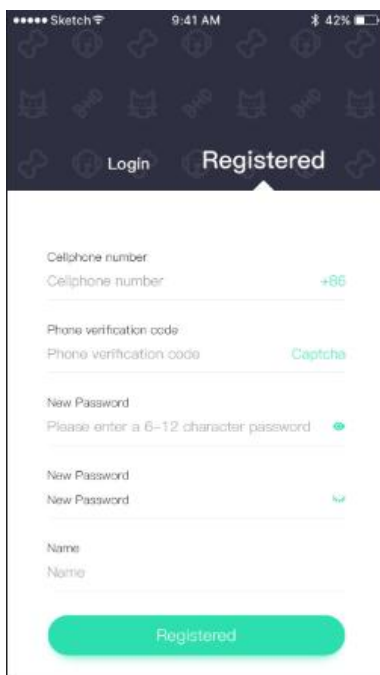
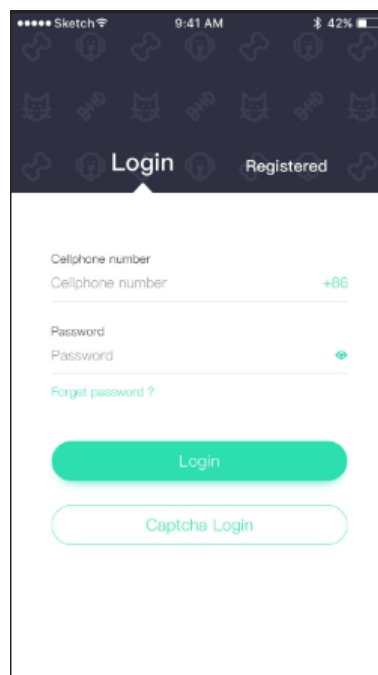
A screenshot of a mobile app registration screen. At the top, there are two tabs: "Login" and "Registered", with "Registered" being the active tab. The form contains several input fields: "Cellphone number" with a dropdown menu showing "+86"; "Phone verification code" with a dropdown menu showing "Captcha"; "New Password" with a prompt "Please enter a 6-12 character password" and a strength indicator; a second "New Password" field; and "Name" with a label "Name". A green "Registered" button is at the bottom.A screenshot of a mobile app login screen. At the top, there are two tabs: "Login" and "Registered", with "Login" being the active tab. The form contains two input fields: "Cellphone number" with a dropdown menu showing "+86" and "Password" with a strength indicator. A "Forgot password?" link is below the password field. There are two buttons: a green "Login" button and a white "Captcha Login" button.



### 6.4.2.2 Choose BAANOOL IoV to enter it.

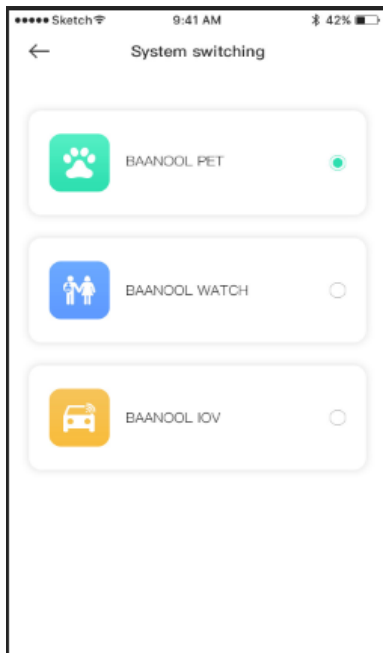

### 6.4.2.3 Click “Me”→ “Device Management”→ “Add”, scan the QR CODE on the device or enter the IMEI manually to bind the device

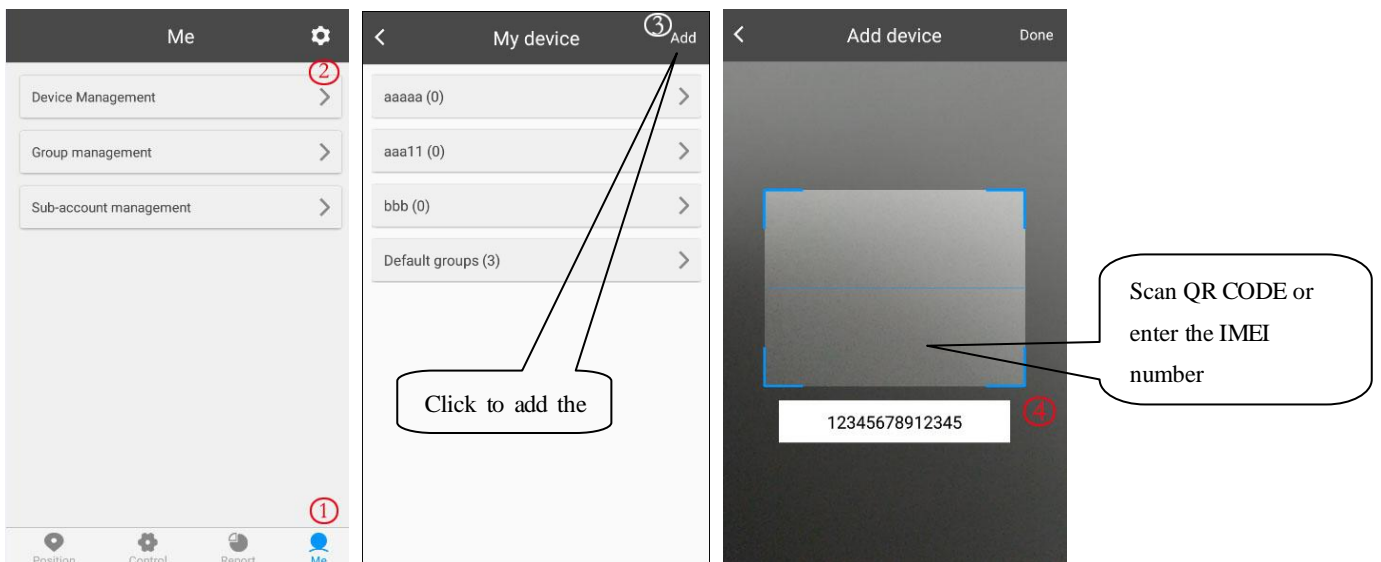

## 6.4.3 Position

1. Check the device: Click “Position” to enter the position page to see all the devices on the map, click the icon of the device to see the details including

latitude & longitude, speed, altitude, time, and alarm status, etc. and you can click “Navigate” to navigate you to that car.

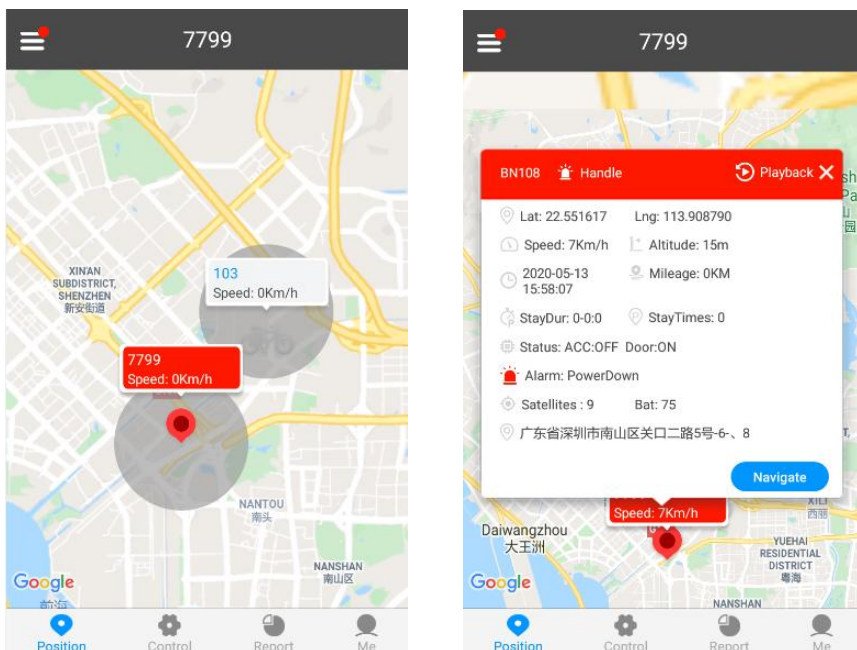

2. Select the device: Click “☰” at the upper left corner to select a device, Then its position, Geo-fence and trace (need to configure the “continuously track” settings of the “Control” page) will be showed on the map.

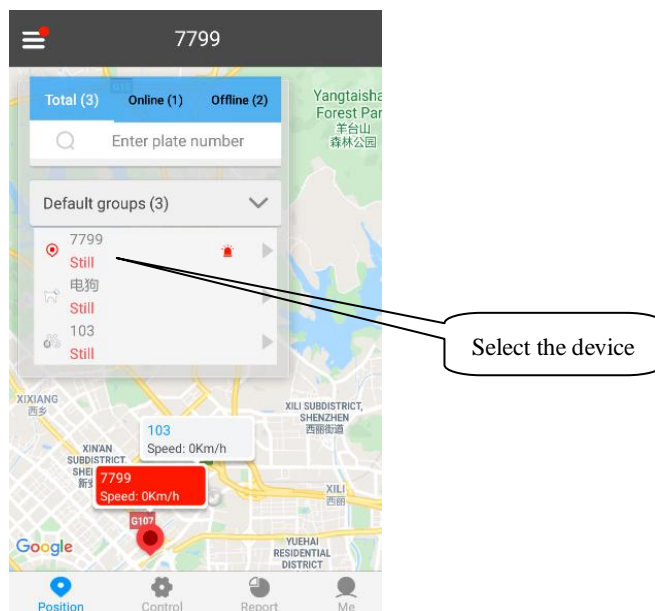

## 6.4.4 Control

After selected the device, then click “Control” to enter control page to use function of

single track, continuously track, Arm / Disarm and Geo-fence, etc.

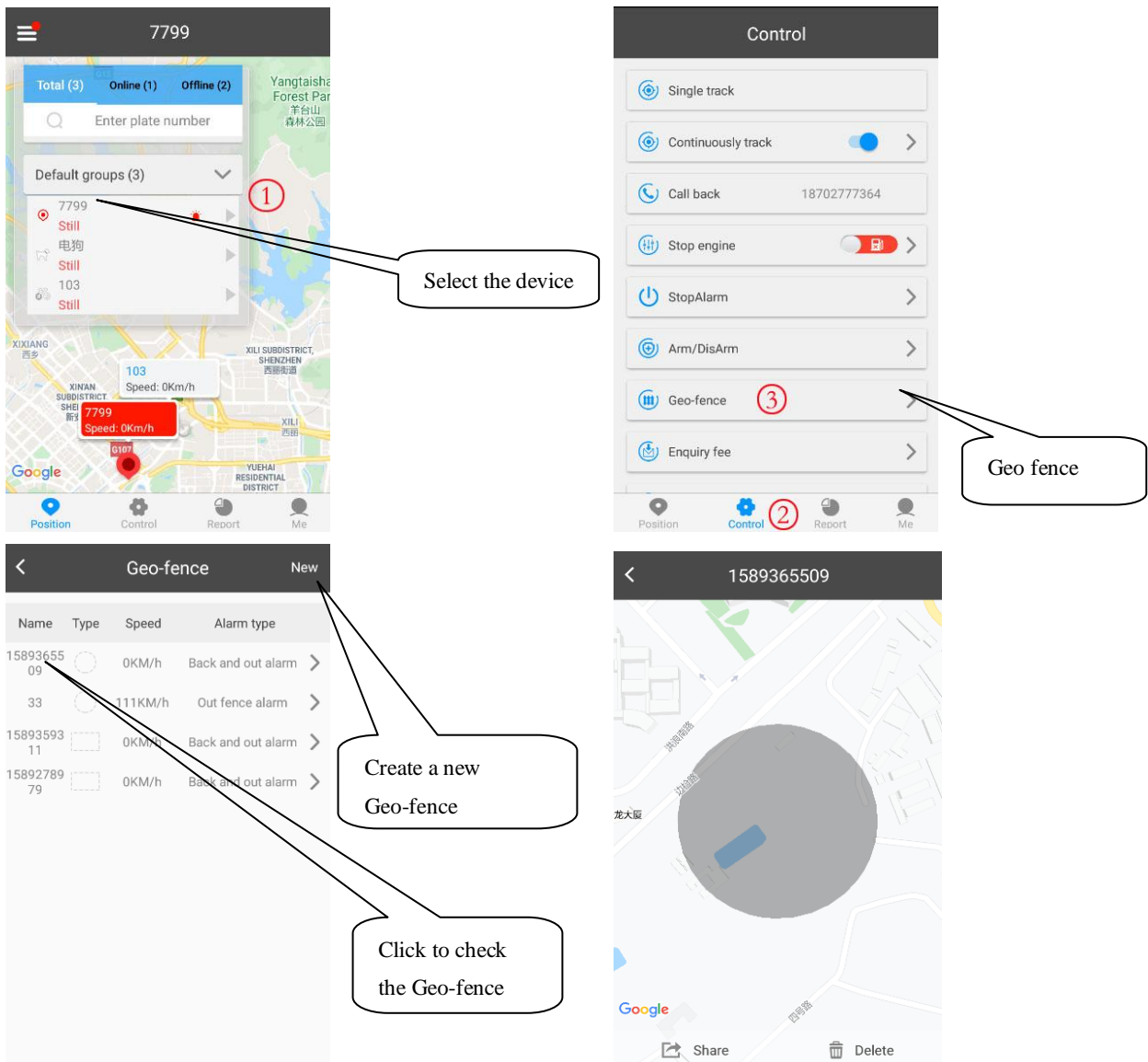

## 6.4.5 Device management

After selected the device, click “Me” to management page to add device, change device’s information, delete settings, group management and sub-account management.

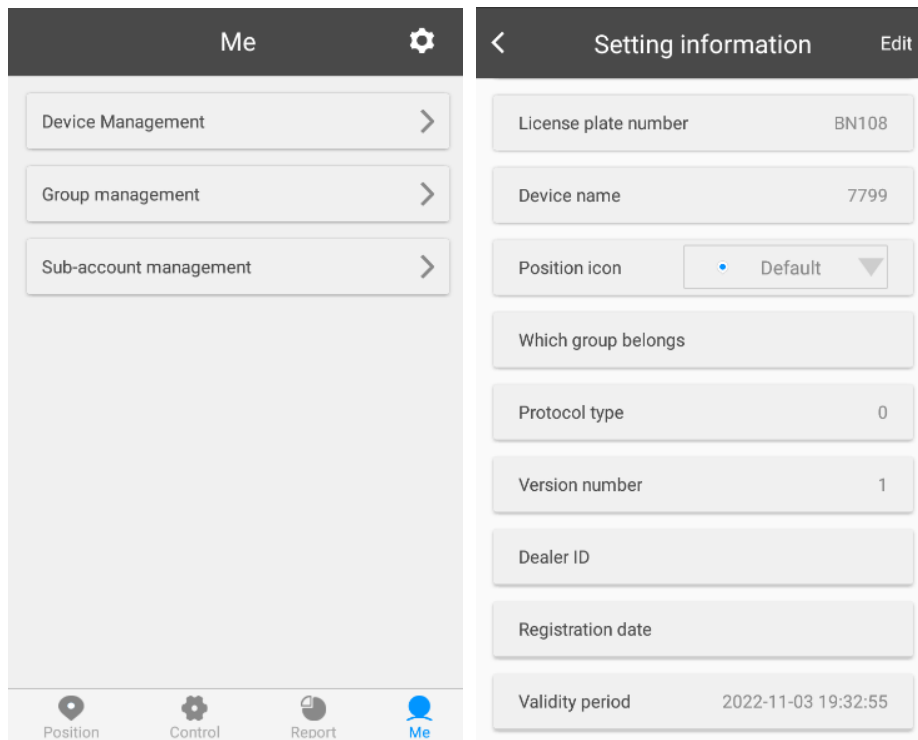

## 6.5 BAANOOL IOT's Web Version

Account name and password are the same on mobile App and web version

### 6.5.1 Register

Open <http://www.baanool.net> to register a new account.

**BAANOOL IOT**

English

account

password

[Forgot password?](#) [Register account](#)

**login**

Click to register

**BAANOOL IOT**

**Register account**

IMEI Please input IMEI number (required)

account number Please input account number (required)

password Please enter a new password(required)

password Please confirm the new password(required)

mobile number to retrieve the password

**Cancel** **Confirm**

Enter IMEI, account, password, mobile phone (For forget password purpose) to finish the registration.

## 6.5.2 Login

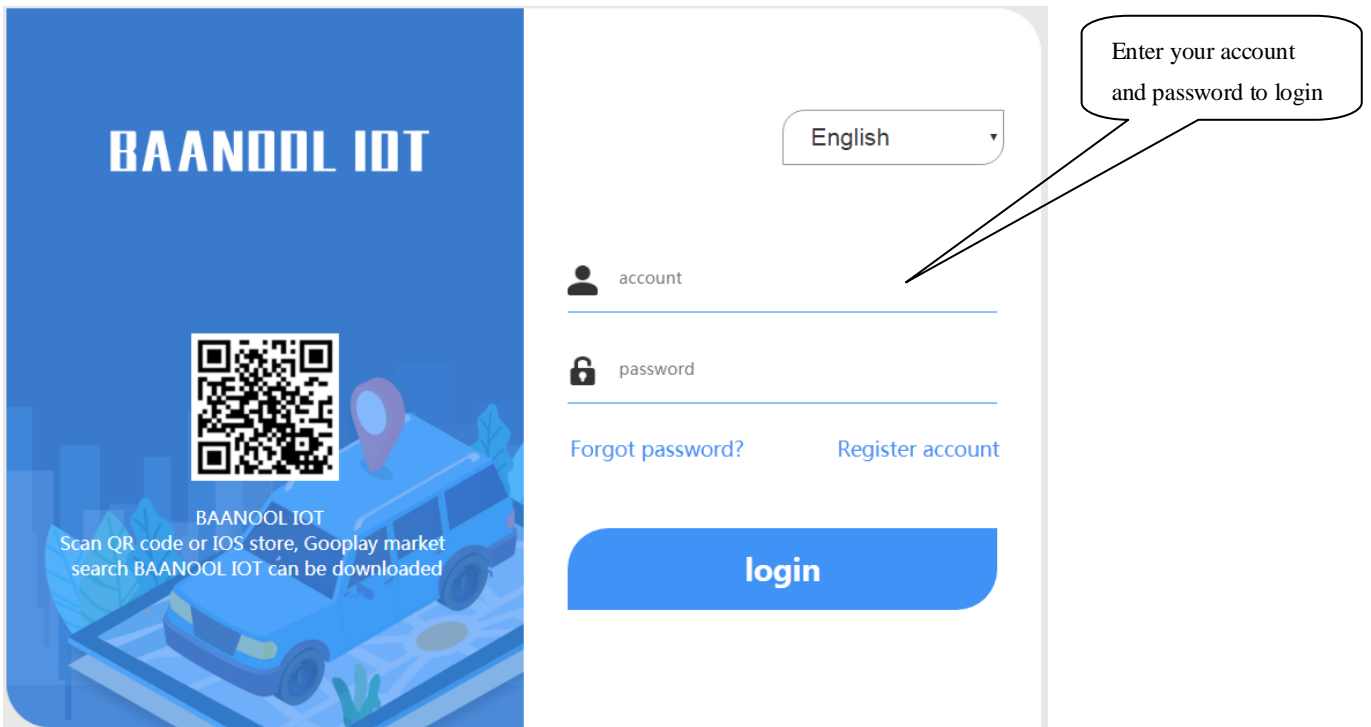

添加终端



Adding device information ×

Device IMEI\* :  Enter IMEI

Device name\* :  Device name

Phone :

Device group :

Car number :

position icon :  Choose an icon for device

Click to save it

**Please input the device name or IMEI** 🔍

All (1) Online (0) Offline (1)

+ Add Group  All  Inverse

**Default (1)**

<input type="checkbox"/>	<b>demo</b>	<a href="#">Rename</a>	<b>Offline &gt; 1D</b>
--------------------------	-------------	------------------------	------------------------

This device you just added is still offline

If the device is always offline (Grey color), please make sure the SIM card subscribes the GPRS service, and have credit to surf the Internet, you can put the SIM card in the phone to test if it can surf the Internet.

Besides, please also check if the configurations of APN, user name & password are correct, refers to section 7.20 for more information.

## 7 Function details

The configuration of following functions can be done on the App or web platform.

### 7.1 Changing password

SMS command: **password+old password+space+new password**

Tracker response: **password OK**

Example: **password123456 888888**

Be sure to keep the new password in mind, you have to flash the firmware to restore the initialized setting in case of losing the new password.

Attention: Make sure the new password is in 6 digits Arabic numbers, otherwise the tracker cannot recognize it.

When reading this user manual, you will notice that we have used "+" and "space" between some words;"+" between two words means they should be written together as one word and "space" between two words means you should leave one character space between two words.

## 7.2 Authorization

The authorized numbers are used to receive the various alerts, such as SOS, Geo-fence and movement alert, etc. Up to 5 numbers can be authorized. If you call the tracker 10 times in succession, the number will be authorized automatically as the first number and tracker response "add master ok". Alternatively, you can authorize your number in the following way:

### 7.2.1 Authorizing

SMS command: **admin+password+space+mobile phone number**

Tracker response: **admin ok**

Example: **admin123456 13322221111**

### 7.2.2 Deleting authorized number

SMS command: **noadmin+password+space+authorized number**

Tracker response: **noadmin ok**

Example: **noadmin123456 13322221111**

If you want to receive these kinds of notification alerts when the trackers moved to another country, you must put the country code before the phone number to authorize it in international format, If there is a "0" before your phone number, please remove the "0", for example, **admin123456 008613322221111**.

## 7.3 Single tracking

If there aren't any authorized numbers set-up, it will reply all calls with a location report; if there are authorized numbers set-up, then it will not respond when an unauthorized number calls it.

If you call it from authorized phone number, it will hang up and report a real-time



location as below:

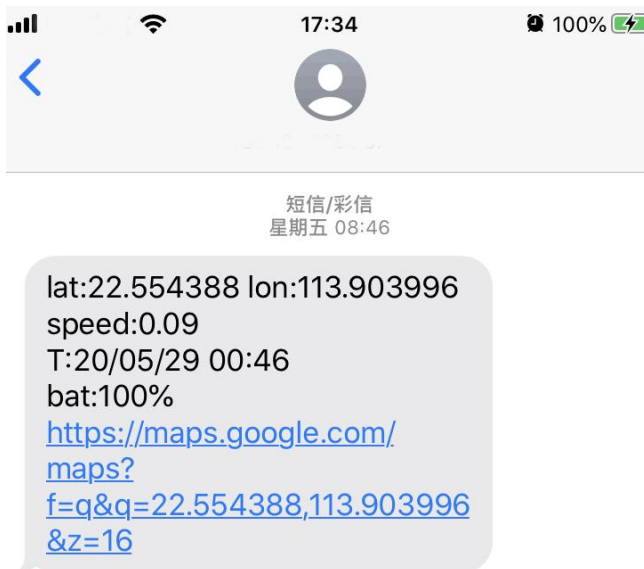

When it lost fix to satellites, the message will include the last known GPS position and a LAC code of the updated position as well.

## 7.4 Continuous interval tracking

### 7.4.1 Limited times tracking at a time interval

SMS command: **fix030s600s005n+password**

Tracker response: It will update positions at 30 seconds interval when moving and 600 seconds for 5 times when motionless.

Example: **fix030s600s005n123456**

Note:

The numbers in the command must be 3 digits and maximum times allowed are 255 times.

The interval unit in all fix command can be s (seconds), m (minutes) and h (hours)

### 7.4.2 Unlimited times tracking at a time interval

SMS command: **fix030s600s\*\*\*n+password**

Tracker response: It will update positions at 30 seconds interval when moving and 600 seconds continuously when motionless.

Example: **fix030s600s\*\*\*n123456**

Note: The time interval must be more than 10 seconds.

### 7.4.3 Unlimited times tracking at a distance interval

SMS command: **Distance+password+space+distance value**

Tracker response: **Distance ok**

Example: **Distance123456 0050**

Note: The distance unit is meter, and value must be 4 digits.

### 7.4.4 Smart tracking at both time and distance interval

SMS command: **fix030s600s\*\*\*n+password+space+distance value**

Tracker response: It will update a position at 600 seconds interval when motionless, and update a position at 30 seconds when moving, besides, it will also update a position when move 200 meters away.

Example: **fix030s600s\*\*\*n123456 0200**

### 7.4.5 Cancel interval tracking

SMS command: **nofix+password**

Tracker response: **nofix ok**

Example: **nofix123456**

## 7.5 Smart angle updating

It will update positions automatically to web platform when the vehicle changes driving direction over a pre set angle value to make its trace following the actual road and seem better on the map. This function is only available in GPRS mode.

SMS command: **angle+password+space+angle value**

Tracker response: **angle ok**

Example: **angle123456 030**

Note: The angle value must be 3 digits, and the default value is 30 degree.

## 7.6 GPS drift suppression

This function is deactivated by default.

SMS command to activate: **suppress+password**

Tracker response: **suppress drift ok**

Example: **suppress123456**

If you stop driving the vehicle, tracker will stop updating its position and keep sending the same latitude and longitude, and when start to driving, the latitude and longitude will update automatically again.

SMS command to deactivate: **nosuppress+password**

Tracker response: **nosuppress ok**

Example: **nosuppress123456**

## 7.7 Exact street address

You must set the APN of your local GSM network provider for the SIM card in the tracker before using this function, if your local GSM network provider requires user name and password for GPRS, Please set it up according to the section 7.20.

After APN has been set up, send "address+password" , it will reply in exact address including street name. For example: No.113, Guankou 2nd Rd, Nantou, Nanshan district, Shenzhen, Guangdong, china.

## 7.8 Location based service (LBS) / Cell-ID tracking

If the tracker cannot establish a solid GPS Fix, it will calculate its location using Cell-ID GSM locating, Location reports will include the GPS coordinates of the last known positions as well as a LAC code, You can send command "address+password" to the tracker to request exact address in SMS mode, tracker will automatically switch to tracking by LBS in GPRS mode. Accuracy of LBS depends on the distance to the nearest GSM Network Cell Tower or Base Station.

Note: This feature can be used normally in most areas according to the signal of GSM network. It may not be available in some areas.

## 7.9 Auto answer

Track is the default mode for position.

SMS command to switch to auto answer mode: **monitor+password**

Tracker response: **monitor ok!**

Example: **monitor123456**

Note: If there aren't any authorized numbers set-up, it will auto answer for all the incoming calls, if there are authorized numbers set-up, it will auto answer the incoming calls from authorized numbers and reject all other phone numbers.

SMS command to switch back to track mode: **tracker+password**

Tracker response: **tracker ok**

## 7.10 Forwarding incoming SMS messages

SMS command: **forward+password+space+third party phone number**

Tracker response: **forward ok**

Example: **foward123456 10086**

The carrier's number which used to sending notification messages is recommended to set up, tracker will forward the notification message to authorized numbers when carrier send message to remind you to top up your SIM card.

SMS command to cancel: **nofoward+password**

Tracker response: **no forward ok**

Example: **nofoward123456**

## 7.11 SIM Card Balance Enquiry

SMS command: **balance+password+space+phone number+space+code**

Tracker response: It will forward the code to the specified phone number and return the content from that number.

Example: **balance123456 10086 ye**

This function assumes that your GSM network provider has the option where you can check your SIM card's balance by sending a SMS message to a specified

number, which is 10086 in this example of China Mobile.

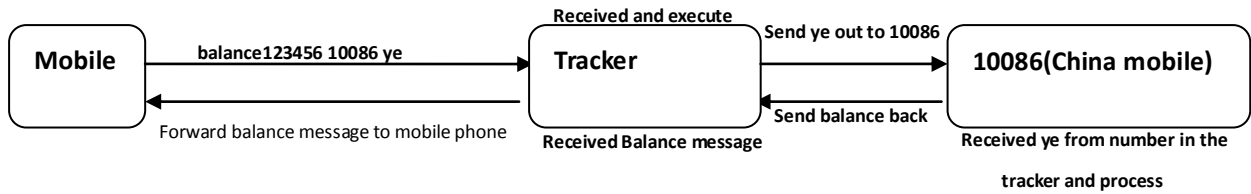

## 7.12 Configure times of alarm SMS

The times of the message of a continuous alarm can be configured. 3 times messages by default.

SMS command: **xtime+password+times value**

Tracker response: **xtime ok!**

Example: **xtime123456 005** (It means to send messages 5 times.)

Note: The times value must be 3 digits.

## 7.13 Alarms

### 7.13.1 Low battery alarm

This feature is activated by default, when the battery is low, tracker will send message “low battery + latitude & longitude” to authorized numbers for 2 times at 15 minutes interval.

Note: The times of this alert cannot be configured by the xtime command.

SMS command to deactivate: **lowbattery+password+space+off**

Tracker response: **lowbattery off ok**

Example: **lowbattery123456 off**

SMS command to activate: **lowbattery+password+space+on**

Tracker response: **lowbattery on ok**

Example: **lowbattery123456 on**

### 7.13.2 Blind area alarm

This feature is deactivated by default, tracker will send SMS notification “No

gps+latitude & longitude of the last know position.” to authorized numbers if lost fix to GPS satellites.

SMS command to activate: **gpssignal +password+space+on**

Tracker response: **gpssignal on ok**

Example: **gpssignal123456 on**

SMS command to deactivate: **gpssignal +password+space+off**

Tracker response: **gpssignal off ok**

Example: **gpssignal123456 off**

### 7.13.3 Geo-fence

The Geo-fence feature creates a virtual fence. When the tracker moves out of this virtual fence, SMS notification “stockade!+latitude & longitude” will be sent to the authorized numbers.

SMS command to activate: **stockade+password+space+latitude, longitude; latitude, longitude**

Tracker response: **stockade ok!**

Example: **stockade123456 22.554459, 113.903981; 22.553002, 113.909378**

SMS command to deactivate: **nostockade+password**

Example: **nostockade123456**

Note: The first latitude & longitude is coordinate of the top left corner of the Geo-fence, and the second latitude & longitude is the coordinate of the bottom right corner.

To configure the Geo-fence the tracker must fix to satellites and be stationery for about 3-10 minutes.

### 7.13.4 Movement alarm

The movement feature will create a circle area with a set radius (200 meters by default). When the tracker moves out of this area, SMS notification “move!+latitude & longitude” will be sent to the authorized numbers.

SMS command to activate: **move+password+space+radius value**

Tracker response: **move ok!**

Example: **move123456 0200**

SMS command to deactivate: **nomove+password**

Tracker response: **nomove ok**

Example: **nomove123456**

Note: The unit of the radius value is meter, and the value must be 4 digits and maximum 9999 meters.

To configure the movement alarm, the tracker must fix to satellites and be stationery for about 3-10 minutes.

### 7.13.5 Over speed alarm

The tracker can be configured to send an alert “speed+xxx!+latitude & longitude” to authorized numbers when a certain speed is exceeded. In SMS mode, tracker only sends one alert in 3 minutes, and siren beep for one second for each trigger.

SMS command to activate: **speed+password+space+speed value**

Tracker response: **speed ok!**

Example: **speed123456 080**

SMS command to deactivate: **nospeed+password**

Tracker response: **nospeed ok**

Example: **nospeed123456**

Note: The recommended speed should not be less than 30km/h. If the speed is set lower than this you may get a false alarm due to GPS inaccuracy.

### 7.13.6 Acceleration Sensor Alarm

There is a built-in three axis acceleration sensor in the tracker to detect the movement, tilt and shock. Tracker will send “Sensor alarm + latitude / longitude” to authorized numbers when detect vibration.

SMS command to activate: **shock+password**

Tracker response: **Shock is activated!**

Example: **shock123456**

SMS command to deactivate: **noshock+password**

Tracker response: **noshock ok!**

Example: **noshock123456**

### Sensor's sensitivity configuration

There are three different levels.

**First level:** Alarm will be triggered by slight vibration.

SMS command: **sensitivity+password+space+1 .**

Tracker response: **sensitivity ok**

Example: **sensitivity123456 1**

**Second level:** Alarm will be triggered by medium vibration.

SMS command: **sensitivity+password+space+2**

Tracker response: **sensitivity ok**

Example: **sensitivity123456 2**

**Third level:** Alarm will be triggered by severe vibration.

SMS command: **sensitivity+password+space+3**

Tracker response: **sensitivity ok**

Example: **sensitivity123456 3**

## 7.14 Sleep

Sleep Mode	Description	Standby Time
No sleep (Always online)	GPRS is always online	5000/31mA/24h=6.7 DAYS
Sleep by shock	GPRS will be offline if it is motionless, vibration can wake up the tracker	5000*0.9 (Battery self-loss) /1.9mA/24h=98.5 DAYS
Sleep by time	It works for 3 minutes for each trigger; GPRS will be online if any alarm has been triggered.	5000*0.9 (Battery self-loss) /1.9mA/24h=98.5 DAYS
Deep sleep by shock	GSM module shuts down when sleep; calling cannot be reached, vibration can wake it up.	5000*0.85 (Battery self-loss) /0.3mA/24h/365d=1.6 YEARS
Schedule	GSM module shuts down when sleep; calling cannot be reached, but it will wake by itself to report its position according to the scheduled time	5000*0.85 (Battery self-loss) /0.3mA/24h/365d=1.6 YEARS
Deep sleep by shock + schedule	GSM module shuts down when sleep; vibration can wake it up. It will wake up to update the position according to the schedule time.	5000*0.85 (Battery self-loss) /0.3mA/24h/365d=1.6 YEARS



### 7.14.1 No sleep (Always online)

SMS command: **sleep+password+space+off**

Tracker response: **sleep off ok**

Example: **sleep123456 off**

Tracker does not sleep, GSM and LED light work at all times. GPS module will be off intelligently according to the track interval when there is no need to update positions or when motionless.

### 7.14.2 Sleep by shock

SMS command: **sleep+password+space+shock**

Tracker response: **sleep shock ok**

Example: **sleep123456 shock**

Tracker will sleep if it doesn't detect vibration, GPS module and LED light will be off, vibration and any operation will wake it up.

### 7.14.3 Sleep by time

SMS command: **sleep+password+space+time**

Tracker response: **sleep time ok**

Example: **sleep123456 time**

If no operations in 3 minutes, tracker will sleep, GPS module and LED light will be off. Calling or SMS can wake up the tracker. GPS module will be off intelligently according to the track interval when there is no need to update positions or when motionless. Sleep by time is the default mode.

### 7.14.4 Deep sleep by shock

SMS command: **sleep+password+space+deep**

Tracker response: **sleep deep ok**

Example: **sleep123456 deep**

Tracker will sleep if it doesn't detect vibration, GSM, GPS module and LED light will be off, only vibration can wake it up. And tracker will send a message automatically after wake up.

## 7.14.5 Schedule report

SMS command: **schedule+password+space+1h**

Tracker response: **schedule ok!**

Example: **schedule123456 1h**

It will wake up every one hour, and automatically send location message after wake up. (m: minute; h: hour; d: day). The maximum interval value is 3 digits, and it cannot longer than 30 days. After this command, GPS & GSM module will be off; tracker runs in super lowest power consumption, calls or messages cannot wake it up. Triggered alarm can wake up the tracker to work normally, after alarm cancelled, tracker returns to schedule report mode.

SMS command to cancel: **noschedule+password**

Tracker response: **noschedule ok!**

Example: **noschedule123456**

## 7.14.6 Deep sleep by shock + Schedule report

SMS command: **sleep+password+space+schedule+space+12h**

Tracker response: **sleep schedule ok**

Example: **sleep123456 schedule 12h**

It will wake up and report every 12 hours, vibration can wake it up too, tracker will send a message after wake up.

## 7.15 Check Status

SMS command: **check+password**

Tracker response:

Bat: 100%

GPRS: ON/OFF

GPS: ON /NO GPS

GSM: 1-32 (The higher, the better)

APN: cmnet,user,password;

IP: 104.250.138.146:9000/DNS: 04.GPSTrackerXY.com:9000

Shock: ON/OFF

Example: **check123456**

## 7.16 Check IMEI

SMS command: **imei+password**

Tracker response: xxxxxxxxxxxxxxxxx (A 15 digits IMEI of your device)

Example: **imei123456**

## 7.17 Local time setting

Tracker works in the local time zone by default. If you find that the time zone is incorrect, you can configure the time zone.

SMS command: **time+space+zone+password+space+time zone value**

Tracker responds: **time ok**

Example: **time zone123456 8**

Note: 8 is the time zone of China, If your country time zone is minus, write the time zone value with a “-“ symbol, for example, time zone123456 -8.

## 7.18 Reset Hardware

This command will reboot the GSM and GPS modules of the tracker. Please note this will not restore factory settings.

SMS Command: **reset+password**

Tracker Response: **reset ok**

Example: **reset123456**

## 7.19 Configure parameters by USB

Using the USB cable supplied to connect the tracker to a computer and open the configuration file  `user_config.ini` with notepad, and then manually change the parameters and settings according to the tips.

Note: You must enter the correct password of the tracker in the old password field every time when changing the settings; otherwise, the changes won't be successful.

## 7.20 GPRS configuration for live real-time tracking

### 7.20.1 Configure APN, GPRS login user name and password

Usually, tracker can automatically recognize and select the APN and GPRS' user name and password without any configuration. If it cannot connect to the network,

Please configure it according to following steps.

#### 7.20.1.1 Configure APN setting

APN is an abbreviation for Access Point Name and changes depending on which mobile network you are using. For more information about your local APN, please check with your local wireless carrier.

SMS command: **APN+password+space+local APN**

Tracker response: **APN OK**

Example: **APN123456 CMNET**

Note: 123456 is tracker's default password, you can change the password on App or refers to section 7.1.

#### 7.20.1.2 Configure user name and password

In the most countries, the user name and password of GPRS are not necessary; therefore, you can ignore this step if it is not necessary for your local network. For those countries requiring user name and password, please configure as following:

SMS command: **up+password+space+user+space+password**

Tracker response: **user, password ok!**

Example: **up123456 Jonnes 666666**

Note: 123456 means the password of the device, Jonnes means the user name of gprs, and 666666 means password of gprs, please configure it according to the user name and password of your local ones, you can check this information with your local wireless carrier.

## 7.20.2 Configure domain name and port

Tracker connects to tracker.baanool.net:8090 by default. If you need to connect to another domain name, please configure it.

SMS command: **dns+password+space+DNS domain name+space+port**

Tracker response: **dns success!**

Example: **dns123456 04.GPSTrackerXY.com 9000**

Note: 123456 is tracker's password, 04.GPSTrackerXY.com is the DNS, 9000 is port.

If you want to configure IP instead of DNS, then please send SMS command:

“adminip+password+space+IP+space+port”

## 7.20.3 GPRS / SMS mode switch

The GPRS mode is the default one, if you need to switch, pls refers to the following instructions.

### 7.20.3.1 GPRS mode

SMS command: **GPRS+password**

Tracker response: **GPRS OK!** (It means it has been switched to GPRS mode.)

Example: **GPRS123456**

### TCP / UDP switch

TCP mode is the default one; you don't need to configure this step if the web platform works with TCP mode, but you need to configure it as following when you are using a platform which only works with UDP.

SMS command to switch to UDP mode: **GPRS+password,1,1**

SMS command to switch to TCP mode: **GPRS+password,0,0**

Tracker response: **GPRS OK!**

Example: **GPRS123456,0,0**

**GPRS123456,1,1**

### 7.20.3.2 SMS mode

Switch to SMS mode will disconnect the GPRS connection for live tracking.

SMS command: **SMS+password**

Tracker response: **SMS OK!** ( It means it has been switched to SMS mode.)

Example: **SMS123456**

## 7.21 Configure SMS monitoring center number

SMS command: **centernum+password+space+phone number**

Tracker response: **centernum ok**

Example: **centernum123456 13322221111**

After the SMS monitoring center number is set successfully, the "Continuous interval tracking" messages will be sent to this number. If the monitoring center number needs to receive the alarm notification message, please set this number as an authorized number too.

Cancel SMS monitoring center number

SMS command: **nocenternum+password**

Tracker response: **nocenternum ok**

Example: **nocenternum123456**

## 7.22 Configure heartbeat package interval

The default heartbeat interval to keep GPRS connection alive is 100 seconds; you can change it if necessary, but please be kindly informed that if the time interval is too long, it may cause GPRS disconnection.

SMS command: **heartbeat+password+space+time interval**

Tracker response: **heartbeat ok**

Example: **heartbeat123456 120**

Note: (123456 means tracker's password, 120 means the interval.

The minimum interval is 60 seconds, and tracker will continue to send heartbeat every 60 seconds if you configure it less than 60 seconds.

## 7.23 Initialization

If the tracker cannot work properly, you can send command to initialize it to return to default factory settings.

SMS command: **begin+password**

Tracker response: **begin ok**

Example: **begin123456**

## 8 Cautions

Please be sure to follow when using:

1. Keep the tracker used in a dry environment. The humid environment can easily damage internal circuits.
2. Please do not put it in a dusty environment.
3. Do not put the tracker in overheated or overcooled places.
4. Handle carefully. Don't vibrate or shake it violently.
5. Please clean with a dry cloth, do not use chemicals and detergents.
6. Please do not paint the device; this may lead to internal circuit failure.
7. Do not disassemble the device.

## 9 Troubleshooting

Faults	Solution
Fail to turn on	Please try again after charged the device.
No GSM signal	<ol style="list-style-type: none"><li>1. Check whether the SIM card is put in place</li><li>2. Whether the SIM card is a GSM network SIM card</li><li>3. Don't turn on the PIN code</li><li>4. Call forwarding cannot be opened.</li></ol>
No GPS signal	The device needs to be in an unobstructed position to ensure that it can receive GPS signals normally.

No response for SMS command	<ol style="list-style-type: none"> <li>1. No credit on SIM card.</li> <li>2. The format of the SMS command is incorrect.</li> </ol>
No response for a call	<ol style="list-style-type: none"> <li>1. Did you have set up the authorized phone number?</li> <li>2. If authorized number exists, did you make the call from an authorized phone number?</li> </ol>
No alarm notification message	<ol style="list-style-type: none"> <li>1. Authorized number has not been set up.</li> <li>2. The format of the phone number is incorrect.</li> </ol>