

GSM/GPRS/GPS Vehicle Tracker Model A/B User Manual

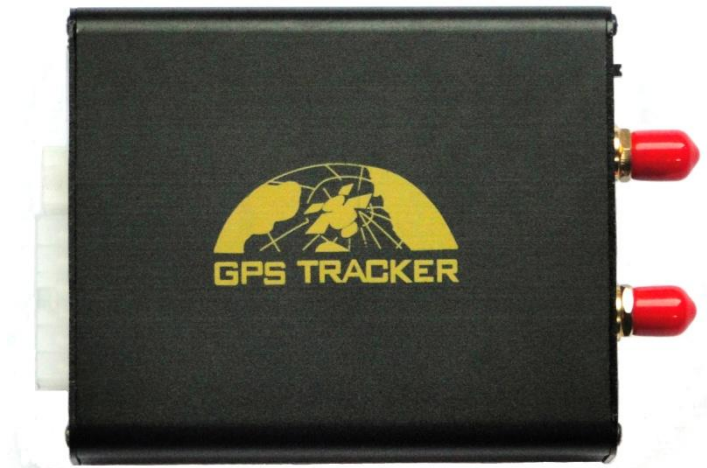

Preface

Thank you for purchasing the tracker. This manual shows how to operate the device smoothly and correctly. Make sure to read this manual carefully before using this product. Please note that specification and information are subject to changes without prior notice in this manual. Any change will be integrated in the latest release. The manufacturer assumes no responsibility for any errors or omissions in this document.

Contents

1. Function Introduction	4
2. Applications	5
3. Hardware Description	5
4. Accessories	5
5. Specifications	7
6. Operating Instructions	7
6.1. Terminal Installation	7
6.2 Installation wiring diagram	8
6.2.1 Main unit installation wiring diagram	8
6.2.2 Relay box (JD01) wiring diagram	9
6.2.3 Central locking system wiring diagram	9
6.3. SIM card installation	10
7. Function and Operation	10
7.1 Turn on device	10
7.2 GSM/GPS LED Indicator	10
7.3 Alarming LED indicator	10
7.4 Initialization	11
7.5 Change Password	11
7.6 Authorization	11
7.7 Modes switch “track”, “monitor”	11
7.8 Single Locating	12
7.9 Auto track continuously	12
7.10. Automatic update positions of vehicle turns	13
7.11. GPS drift suppression	13
7.12 Absolute street address by SMS	13
7.13 Location based service (LBS)	14
7.14 .View photos on cell phone	14
7.15 Data logging	14
7.15.1 Auto logging	14
7.15.2 Logging upon times	14
7.15.3 Multi-logging	15
7.15.4 Logging Clearance:	15
7.16 Data Load	15
7.17 .Forward the third parties’ message	15
7.18 Charges Inquiry	15
7.19. ACC working alarm	15
7.20. Remote Controller (Optional)	16
7.20.1. Program the Remote Controller	16
7.20.2. Setting for Button SOS/Remote Start Function	17
7.21. Switch between Electric and Vapor lock:	17
7.22. Silent Mode	17

7.23. ARM / LOCK (All the functions of Lock and Unlock must work with the optional relay box of central locking system)	17
7.23.1 ARM / LOCK BY SMS	17
7.23.2 ARM / LOCK by Remote controller	18
7.24. Disarm	18
7.24.1 Disarm by SMS	18
7.24.2 Disarm by Remote Controller	18
7.24.3 Alarm Pause	18
7.25 Find Vehicle via Remote Controller	18
7.26. Remote Boot Release	19
7.27. Alerts Function	19
7.27.1 SOS Emergency Alarm	19
7.27.2 Geo-fence	19
7.27.3. Multi-area management	20
7.27.4 Movement Alarm	20
7.27.5 Over Speed Alarm	21
7.27.6 Fuel Checking Alerts (Optional)	21
7.27.7 Temperature Checking Alerts (Optional)	21
7.27.8. Low battery alarm	22
7.27.9 Power off alarm	22
7.27.10. GPS Blind Spot Alert	22
7.27.11 Accident Alarm (Optional)	23
7.28. Alarms under Arm State	23
7.28.1 Door Open Alarm	23
7.28.2 Bonnet alerts	23
7.28.3 Footbrake Alarm	23
7.28.4 Acc Alarm	24
7.28.5 Shock Sensor Alarm (Option)	24
7.29 Auto Photograph (Option)	24
7.30 Alarms in GSM Blind Area	24
7.31 Trigger Memory	24
7.32 No GSM Alarm	25
7.33 Cut off oil and power system	25
7.34 Resume the Oil and Power System	25
7.35 Auto-arming	25
7.36 Door closing remind	25
7.37 Park warning	26
7.38 Automatic Central Locking System	26
7.39 Setup Appointment (Option)	26
7.39.1 Car Type Setting	26
7.39.2 Operations of MT Vehicle setup appointment	26
7.39.3 Appointment Fail	26
7.39.4 Cancel startup appointment	27
7.40 Start/turn off car remotely	27

7.41 Empty / Loaded	27
7.42 Check the Vehicle State	27
7.43 Reset by SMS	28
7.44 Sleep Mode	28
7.45 Check IMEI.....	28
7.46 Terminal (local) Time Setting	28
7.47 TCP/UDP switch	29
7.48 Configure parameters by USB	29
7.49 GPRS Setting	29
7.49.1 Configure APN.....	29
7.49.2 Configure GPRS User Name and password	30
7.49.3 Configure IP and Port	30
7.50. Less GPRS traffic	30
7.51. Modes Switch between “SMS” and “GPRS”	31
7.52 Set up monitor center number.....	31
7.53 Web platform and PC installation tracking software	31
8. Cautions	32
9. Faults & the Solutions	32

1. Function Introduction

1.1 This tracker is a new product based on the GSM / GPRS network and GPS satellite positioning system, which set multiple functions of security, monitoring surveillance, tracking and dispatch management in its entirety. It can track and monitor remote target by SMS or internet.

1.2 Features

- 1.2.1 GPS/LBS (location based service) double way tracking solution.
- 1.2.2 SMS/GPRS/Internet Network data transmission.
- 1.2.3 GPRS on-line and GPRS re-connected automatically if GPRS drops.
- 1.2.4 SMS / GPRS dual-mode switching
- 1.2.5 Configure by remote terminal.
- 1.2.6 Remote control vehicle
- 1.2.7 Central locking system
- 1.2.8 Voice monitor
- 1.2.9 Photo Snapshot automatically upon alarm trigger and view photo by cell phone or web server
- 1.2.10 Fuel level measurement, Oil leakage or theft alarm.
- 1.2.11 Temperature detection.
- 1.2.12 Support SD card to memorize positions.

2. Applications

Used widely for positioning and tracking vehicle and other moving objects.

3. Hardware Description

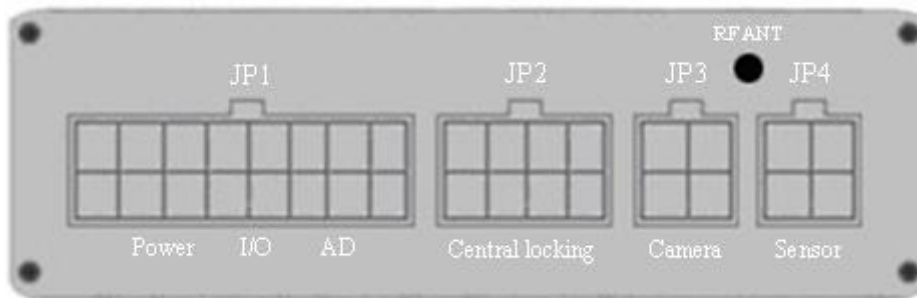

- (JP1) 16PIN harness port
- (JP2) 8PIN harness port
- (JP3) Camera port
- (JP4) 4PIN harness port





Internal
SIM2 slot

4. Accessories

No.	Picture	Name	Note
1		GPS Antenna	3 meters

2		GSM Antenna	2 meters
3		Microphone	1.5meters
4		Harness	16PIN
5		Harness	4PIN
6		Relay	12V/40A
7		Shock Sensor	Optional
8		Siren	Optional
9		Remote controller	Optional
10		Central locking relay box (JD01)	Optional
11		Camera	Optional

12		Temperature Sensor	Optional
13		Fuel Sensor	Optional

5. Specifications

Content	Specification
DIM	92*71*26mm
Weight	170g
Network	GSM/GPRS
Band	850/900/1800/1900Mhz
GPS Module	SIRF3 chip
GPS Sensitivity	-159dBm
GPS Accuracy	5m
GPS Start Time	Cold status 45s Warm status 35s Hot status 1s
Applicable vehicle power	12 V/24V
Backup Battery	Chargeable changeable 3.7V 500mAh Li-ion battery
Storage Temp	-40 °C to +85 °C
Operation Temp	-20 °C to +65 °C
Humidity	5%--95% non-condensing

6. Operating Instructions

6.1. Terminal Installation

6.1.1 Please ask the qualified engineers to install.

6.1.2 Do not install it in an environment which is over GSM &GPS performance and fix the antennas in a position with good signals.

6.1.3 Pay attention to make installation location preventing water and dust.

6.1.4 Find the harness and insert them into the corresponding holes of the products, and connect the wires with the original car circuit showing below

6.1.5 Knowing about the type of the door trigger is positive or negative. Please connect the green wire to the door control circuit if it is positive, and connect blue wire if it is negative.

6.1.6 Electric lock is set default central lock. If vehicle central lock is vapor lock, refer to 7.21. Switch between Electric and Vapor lock

6.1.7 Fuel sensor diagram instructions: Refer to the fuel sensor installation instructions.

6.1.8 Connect the GPS and GSM antenna to the right connector, and find an appropriate place to fix the antennas to make sure good reception.

6.2 Installation wiring diagram

6.2.1 Main unit installation wiring diagram

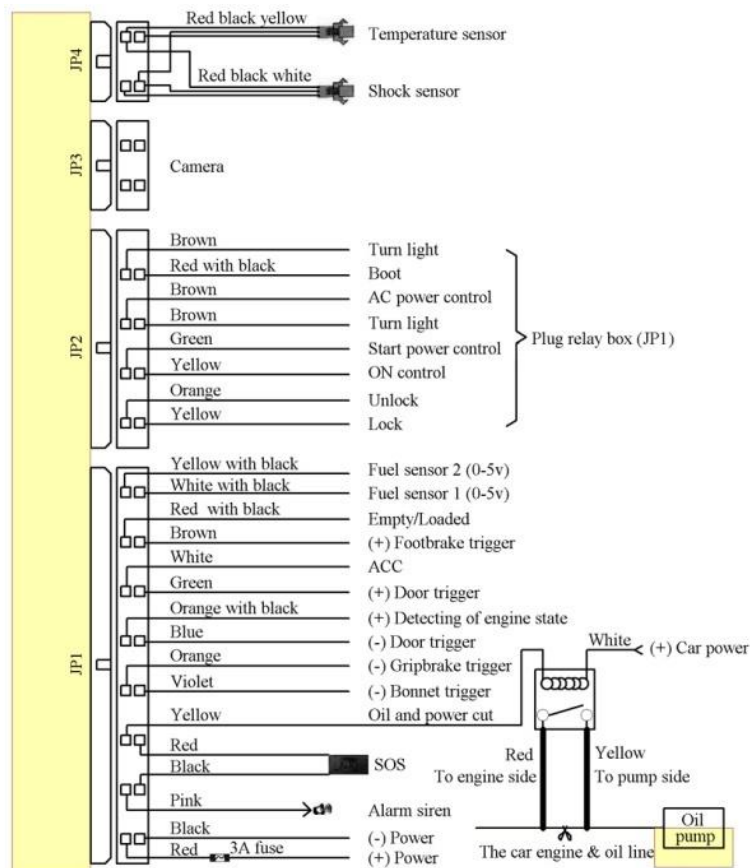

*Orange with black wire of JP1: Engine status detection, it is used to detect the engine started or not after automatically start command, this wire connects to the power wire

of fuel pump(for gasoline vehicle) or output wire of generator (for diesel vehicle), and it has 9V-14V voltage after engine started.

6.2.2 Relay box (JD01) wiring diagram

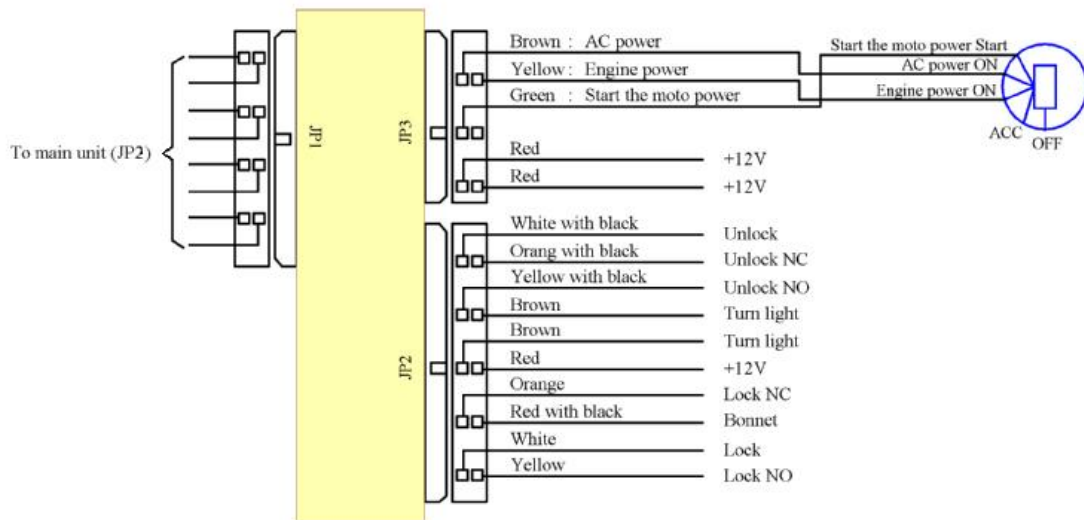

6.2.3 Central locking system wiring diagram

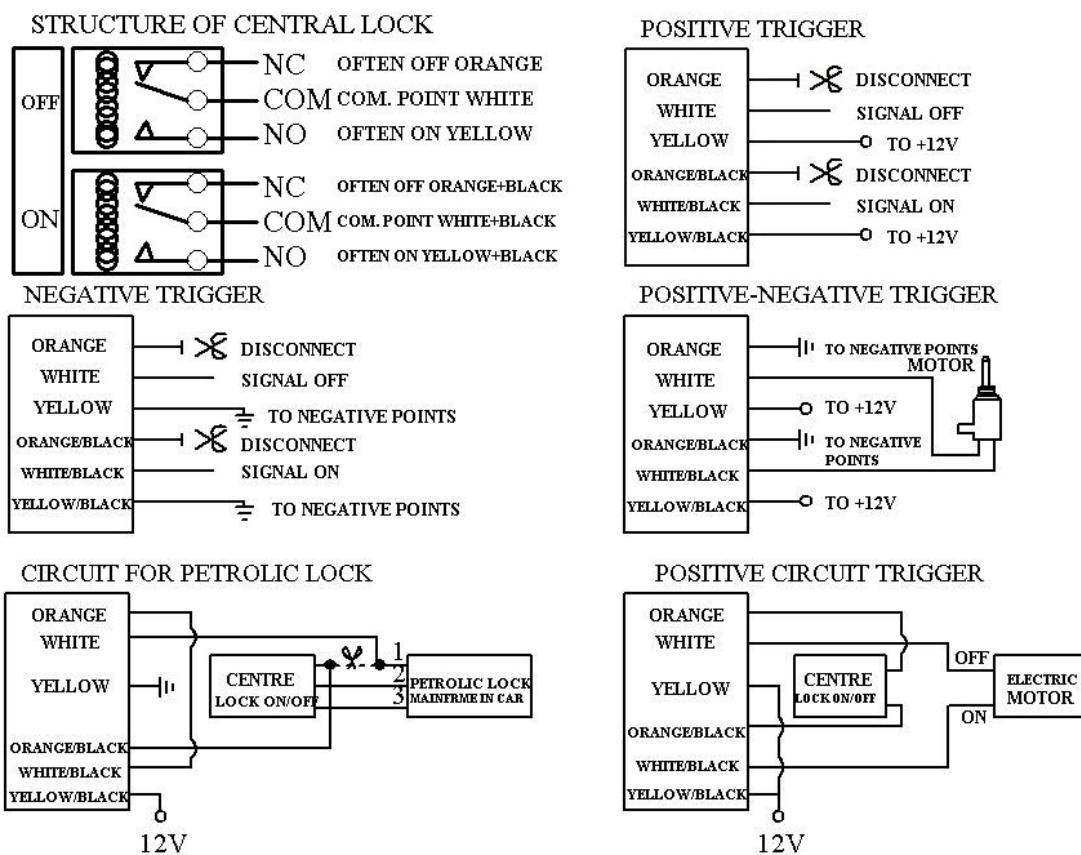

6.3. SIM card installation

6.3.1 Use a tweezers or a sharp thing to touch the SIM CARD popup switch, the SIM CARD slot will pop up, take out the SIM card slot to load the SIM card, and then put the SIM card slot back to its original position after confirm the SIM card in the right place.

6.3.2 Installing the second internal SIM card need open the case

6.3.3 Please make sure that the SIM card is GSM network and able to execute the function of incoming calls display, no calls can be diverted and the PIN code is locked. The SMS format must be TXT format, and can't recognize the PDU format.

6.3.4 If need to save historical positions or positions when GSM not available, please insert SD card to its slot

7. Function and Operation

7.1 Turn on device

7.1.1 Connect the positive and negative wire, red and black ones, with 12V or 24V car power system, wait for 1 minute after connecting power to wait tracker works normal, and then turn on the backup battery switch

7.2 GSM/GPS LED Indicator

LED color	Behavior	Descriptions
Red	NO	No GSM signal
Red	one time per second (fast)	GSM signal normal and work under GSM mode
Red	one time per 3 seconds (slow)	GPRS mode
Green	Quick flash	GPS signal normal
Green	OFF	No GPS signal
Red & Green	Flash three times alternately	Detect microSD card

7.3 Alarming LED indicator

State	LED Behavior
Non-armed state	flash once, stop for 3 seconds.....
Armed state	flash 2 times, stop for 1 second.....
After alarm being triggered	light for 2 seconds, stop for 2 seconds.....
Disarming after being triggered	light for 3 seconds.
After SOS being triggered	flash 3 times in 5 seconds.

7.4 Initialization

Send SMS “begin+password” to the unit, it will reply “begin OK” and initialize all the settings to default factory settings. (default password: 123456)

For example: Send SMS “begin123456”, it will reply “begin ok”. (No quotation marks “” when sending all the SMS)

7.5 Change Password

7.5.1 Send SMS “ password+old password+space+new password” to the unit to change the password.

For example: send SMS “password123456 888888” to the unit. If succeeded, “Password ok” will reply to your cell phone.

7.5.2 Keep the new password in mind, the machine will not work properly if lost the password.

7.5.3 Note: The new password must be 6 digits of the Arabic numerals, or the device will not recognize.

7.5.4 Please don't type “+” character in all commands, space means press the space keyboard on cell phone.

7.6 Authorization

There are 5 numbers to be allowed to authorize in the tracker at most.

7.6.1 Call and track the tracker device for 10 times from cell phone in success, it will make the cell phone number as the authorized number automatically, and reply “add master ok”.

7.6.2 Authorization: Send SMS “admin+password+space+cell phone number” to set up an authorized number, the other authorized numbers should be set by the first authorized number, if the number is successfully authorized, the unit will reply “admin ok” by SMS.

7.6.3 Delete authorization: Send SMS “ noadmin+password+space+authorized number” to delete the authorized number.

7.6.4 If you want to track the target via tracker device when it enters into another country, you must add the country code before the cell phone number, for example, send SMS “admin123456 008613322221111” to the device. Note: 13322221111 will be set up as the authorized number.

7.7 Modes switch “track”, “monitor”

7.7.1 The default mode is “track” (track mode).

7.7.2 Send SMS command "monitor+password" to tracker device, it will reply "monitor ok!" and switch to monitor mode, and then call the number in device to monitor the voice.

7.7.3 Send SMS command "tracker+password" to tracker device, It will reply "tracker ok" and restore to track mode.

7.8 Single Locating

7.8.1 Any number calls the tracker device, it will reply a SMS including the position of latitude and longitude if authorized number has not been set yet. If authorized number has been set successfully, the device won't reply SMS including the positioning of latitude and longitude when the unauthorized number dials it up.

7.8.2 Dialing the tracker device from the authorized number, it will hang up your calling and respond to a real-time latitude and longitude information as following:



Tracking location, when no GPS signal, the SMS includes the last valid latitude & longitude as well as the LAC code of current position, the LAC code can be input in the column of "manual track" menu of web platform to check location.

7.9 Auto track continuously

7.9.1 Track with limited times upon time interval:

Send SMS command "fix030s005n +password" to the tracker device, it will report the latitude & longitude at 30s intervals of 5 times. (s:second, m:minute, h:hour). This

command set must be in 3 digits and the maximum value is 255.

7.9.2 Track with unlimited times upon time interval:

Send SMS "fix030s***n+password" to the tracker device, it will reply the latitude & longitude continuously at interval of 30 seconds.

Note: the interval must not less than 20s.

7.9.3 Smart track upon time and distance interval:

7.9.3.1 Please set "track with unlimited times upon time interval" before this function, and send "distance+password+space+distance", tracker will reply "Distance ok", and then tracker will locate upon both the pre-set time and distance.

E.G: Send "distance123456 0050", it means distance is 50 meters; the number must be 4 digits Arabic numbers.

7.9.3.2 Set this function on web server: Set time interval first and then distance interval, tracker will locate upon the time and distance.

7.9.4 Cancel: Send SMS "nofix+password" to the tracker device to cancel the "auto track".

7.10. Automatic update positions of vehicle turns

7.10.1 The tracker will update the positions automatically to web server once the vehicle changing driving direction over pre set angle value to form a smooth trajectory consistent with the actual road, this function works only in GPRS mode.

7.10.2 Send "angle+password+space+angle" to tracker, it will reply " angle ok".

7.10.3 The angle must be 3 digits Arabic numbers, default angle value is 30 degree.

7.11. GPS drift suppression

7.11.1 This function is deactivated as default, send "suppress+password" to tracker, it will reply " suppress drift ok". The GPS data stop updating if vehicle is not driving (ACC is OFF) and latitude and longitude always keep same, and GPS data updates automatically when vehicle is moving.

7.11.2 Cancel: send "nosuppress+password" to tracker, it will reply " nosuppress ok ".

7.12 Absolute street address by SMS

7.12.1 You must set up the APN of your local GSM network for the SIM card in tracker first before using this function, if there is user name and password for GPRS login, Please refer to configure the APN, user name and password for GPRS login.

7.12.2 After configure the APN, send "address+password" to device, it will reply SMS including real street/address name. For example: No.8, Guankou 2nd Rd, Nantou, Nanshan district, Shenzhen, Guangdong, china.

7.13 Location based service (LBS)

When the tracker device doesn't received valid GPS signals, tracker will positioning by location based service(LBS), the messages includes the GPS coordinates of the last position in SMS mode, but the LAC in message is the current new position,you can also send command "address+password" to tracker to get the newest absolute address and GPS coordinates as well; tracker will automatically switch to track by location based service in GPRS mode, and actualized on the map of web server with LBS mark. And there may be some inaccuracy with actual location by LBS tracking; the bias depends on GSM reception.

Note: This feature can be used normally in most areas according to the signal of GSM network. It may not be available in some areas.

7.14 .View photos on cell phone

7.14.1 You must set up the APN of your local GSM network for the SIM card in tracker first before using this function, if there is user name and password for GPRS login, Please refer to configure the APN, user name and password for GPRS login.

7.14.2After APN configuration, send "photo+password" to device, it will take photos and send a link SMS to authorized cell phone. Click the link, then photo can be viewed on cell phone via Internet

7.15 Data logging

Logging Volume is depends on the capacity of the SD card inserted in the tracker device , the data in the SD card can viewed after copied to computers through card reader,

7.15.1 Auto logging

When the tracker device lost GSM signals or fall offline from GPRS, tracker will log the tracking position and alerts automatically in the SD card on the basis of the pre-set condition, when GSM signals get back, all the event alerts will be auto-sent to the authorized numbers or monitoring platform (server), but the logged tracking data should be loaded to the monitoring platform via SMS command.

7.15.2 Logging upon times

Send SMS: "save030s005n+password" to the tracker unit, it will reply "save ok", and will log the lat, long locations every 30 seconds for 5 times. (S: second, m: minute; h: hour).

7.15.3 Multi-logging

Send SMS: "save030s***n+password" to tracker device, it will reply "save ok".

7.15.4 Logging Clearance:

send SMS: "clear+password" to tracker device, it will reply "clear ok".

7.16 Data Load

7.16.1 Current date Load: Send SMS: "load+ password" to tracker device, it will reply: "load ok" if the device is working well under GPRS mode; if not, it will reply "load fail! Please check gprs" that means device does not work under GPRS mode.

7.16.2 Specified date Load: Send SMS: "load+ password+ space+ year month date" to tracker device, it will reply: "load ok" and load the tracking data to the monitoring platform upon the valid time you choose. For Example: send SMS: "load123456 20110425" to the tracker device, means to load the tracking data of 25th April 2011 to monitoring platform.

7.17 .Forward the third parties' message

7.17.1 Send SMS "forward+password+space+third parties phone number" from authorized phone number, tracker will reply "forward ok", and supports 1 third parties phone numbers at most.

For example, set the phone number of the service provider of the simcard in the tracker, when charge remind message coming in, tracker will forward it to authorized phone number.

7.17.2 Cancel: Send SMS command "noforward+password".

7.18 Charges Inquiry

Send SMS command "balance+password+space+carrier's phone number+space+code" to tracker, it will forward the code to carrier's phone number and return the balance message received from carrier's phone number.

7.19. ACC working alarm





7.19.1 This function is disabled as default. To active this functions, send

"ACC+password" to tracker, it will reply "ACC ok". And tracker will send "ACC on+latitude & longitude" to authorized numbers when detect ignition action, that means the vehicle has been started; and tracker will send "ACC off+latitude & longitude" to authorized numbers, that means ACC off.

7.19.2 Send "noACC+password" to disabled this function, tracker will reply "noACC ok".

7.19.3 This configuration can only enable and disable the alarm to authorized numbers; it will send to web server automatically in GPRS mode and can't be disabled.

7.20. Remote Controller (Optional)

Button	Function	Description
	Arm / lock	Press for 0.5 second, the siren will beep one time.
	Deterrence/car search	Press for 0.5 second when it is in arm state, siren will beep 10 seconds.
	Disarm / unlock	Press for 0.5 second, the siren will beep two times.
	Remote Boot Release	Press for 2 seconds, vehicle boot will be open.
	SOS/Remote start	Press for 3 seconds, device will send SOS alarm SMS message or remote start the car, it can be set by yourself.

7.20.1. Program the Remote Controller

Step on foot brake, short-press the SOS for 7 times, siren beeps 1 time, the turn light blink 1 time and enter to learning mode.

7.20.1.1 Short-press the button  of the first remote controller, the turn light blink 1 time and siren beeps 1 time means the first remote controller programming successfully.

7.20.1.2 Short-press the button  of the second remote controller, the turn light blink 2 times and siren beeps 1 times means the first remote controller programming successfully.

7.20.1.3 Release the foot brake, programming is saved and exits automatically.

7.20.2. Setting for Button SOS/Remote Start Function

7.20.2.1 Button  default function is SOS

7.20.2.2 Send SMS command “startkey+password+ start”to tracker, it will reply “startkey start ok!”,long-press  the remote start will be trigger.

7.20.2.3 Send SMS command “startkey+password+ sos”to tracker, it will reply “startkey start ok!”,long-press  the SOS will be trigger.

7.21. Switch between Electric and Vapor lock:

Send SMS command “locktype+password+space+1” to the tracker, it will reply“Vapor lock ok!”

Tracker device will switch to Vapor lock.

Send SMS command “locktype+password+space+0” to the tracker, it will reply“Electric lock ok!”

Tracker device will switch to electric lock.

7.22. Silent Mode

Send SMS “silent+password” to tracker device, it will reply “silent ok!” .It means tracker device enters into silent mode, no action from siren after alarm is triggered, but tracker will send alarm SMS to authorized numbers.

Quit silent mode Send SMS “loud+password” to tracker device.

7.23. ARM / LOCK (All the functions of Lock and Unlock must work with the optional relay box of central locking system)

7.23.1 ARM / LOCK BY SMS

Send “arm+password” to tracker, it will make the car enter ARM states and lock the door at the same time, and reply “Tracker is activated”.If the car is in ignition (ACC is at “ON” position), then the car can’t enter ARM state, but it will lock the door and reply “set up fail! pls turn off

ACC".If engine turned off, but door is open, then the car can't enter ARM state and reply "set up fail! pls close the door"

7.23.2 ARM / LOCK by Remote controller

In disarm states, short-press remote control button , the door of the vehicle will lock, it enter sound and light arm states, siren beeps one time, turn light blink one time, no SMS message.

If the car is in ignition (ACC is at "ON" position), then the car can't enter ARM state, but it will lock the door and siren keep silent.If door is not close, siren beeps 3 times with turn light blink.

7.24. Disarm

7.24.1 Disarm by SMS

Send SMS command "disarm+password" to the tracker device in the vehicle, It will reply "Tracker is deactivated" in both armed and disarmed state, and the SMS command will make the tracker device enter into disarmed state if the unit currently armed.

It won't alarm if the door is open and sensor is vibrated and the engine is started when deactivated this arm function.

7.24.2 Disarm by Remote Controller

In armed state, short-press button , the car enters into disarm state, siren will beep two times and turn light blink two times.

7.24.3 Alarm Pause

When alarm is triggered, press button , it will stop alarm and turn off the turn light, but the alarm system still in warning states, no action for lock/unlock the door.

7.25 Find Vehicle via Remote Controller

In armed state, short-press  button 1 time, siren will beep 10 seconds with turn light flashing,

press any button to stop.

7.26. Remote Boot Release

Long-press  button for 2 seconds in disarm state, vehicle boot will be open.

7.27. Alerts Function

7.27.1 SOS Emergency Alarm

7.27.1.1 SOS via Remote Controller

Press  button for 3 seconds; siren will not beep and turn light will not flash, the tracker device will send SMS “help me!+lat./long.” to all the authorized numbers at interval of 3 minutes. It will stop sending such a SMS when any authorized number reply SMS “help me!” to the tracker.

7.27.1.2 SOS via SOS Button

Long-press SOS button on the cables for 2 seconds, the device will send sms: “help me + lat/long” to every authorized no. without any action from siren or turn light. Alerts will stop after you reply sms: “help me!” to the device by any authorized no.

7.27.2 Geo-fence

Set up a geo-fence for the tracker device to restrict its movements within a district. The unit will send SMS to the authorized numbers when it goes out of this district. Set up: When the tracker stays immobile in a place for 3-10 minutes, the user can send SMS “stockade+password+space+latitude,longitude;latitude,longitude” to tracker to set the restricted district. In case of breach, it will send SMS “stockade!+latitude/longitude.” to the authorized numbers.

Note: The first latitude & longitude is coordinate of the top left corner of the Geo-fence, while the second latitude & longitude is the coordinate of the bottom right corner, it will alarm SMS in 3 minutes interval.

Cancel: Send SMS “nostockade+password” to deactivate this function.

7.27.3. Multi-area management

7.27.3.1 Set Area

Send SMS command

"area+password+space+latitude,longitude+space+areaname,distanceM" to tracker(distance unit: M for meter, K for kilometer), it will reply "area01 ok".

Example: Send "area123456 22.353648,113.543678 school,800M".

Note: 5 areas at most and the distance between two points can't be less than the total distance in the 2 commands, and different areas can't cover each other.

7.27.3.2 Delete areas

Send SMS command:"noarea+password+space+area name", tracker will reply:"noarea ok".

7.27.3.3 Rename and set distance

Send SMS command "rename+password+space+old name;new name,distanceM" to tracker, if name is not repeated and area doesn't cover others, it will reply "rename ok!" for successful configuration.

Example: Send"rename123456 area01;school,800M", it means the new area name is "school", and covers area of a radius of 800 meters.

7.27.3.4 Activate multi-area management

Send SMS command "area+password+space+on" to tracker, it will reply "Area on ok!", when tracker enter the pre set area, it will send SMS "area name+latitude & longitude" to all the authorized phone number, and send same SMS when goes out of the area.

7.27.3.5 Deactivate Multi-area management

Send SMS command "area+password+space+off" to tracker, it will reply"area off ok!"

7.27.4 Movement Alarm

7.27.4.1. Set up: when the unit stays immobile in a place for 3-10 minutes with GPS

signal reception, the user can send SMS“move+password+space+0200” to the tracker (Suppose area of a radius of 200 meters, it supports 4 digits at most. Unit: Meter). It will reply “move OK”. In case of such a movement (the default distance is 200m), it will send SMS “Move+ latitude & longitude” to the authorized numbers at interval of 3 minutes.

7.27.4.2 Cancel: Send SMS “nomove+password” to deactivate the movement alarm.

7.27.5 Over Speed Alarm

Set up: Send SMS “speed+password+space+080” to the unit (suppose the speed is 80km/h), and it will reply “speed OK!”. When the target moves exceeding 80km/h, the unit will send SMS “speed+080!+ latitude & longitude” to the authorized numbers.

Cancel: Send SMS “nospeed+password” to deactivate the overspeed alarm.

Remark: The recommended speed should be not less than 30km/h. For below that rate, it will be effected the accuracy by GPS signals drift etc.

7.27.6 Fuel Checking Alerts (Optional)

During driving process, when the Tracker Device detects the fuel decrease by 20% in 3 minutes, then it will send oil leak or theft alert “oil:XX%+Lat, Long” to authorized number in 3 minutes interval. Siren beeps 30 seconds continuously.

When Acc off and Car stop, the tracker device detects the fuel decrease 2% comparing with previous fuel when car stop, It will send oil leak or theft alert “oil: XX%+ Lat, Long” to authorized number in 3 minutes interval. Siren beeps 30 seconds continuously with turn light flashing.

Cancel fuel alarm: Send SMS command “nooil+password” to tracker.

7.27.7 Temperature Checking Alerts (Optional)

The available temperature range is from -050°C to $+125^{\circ}\text{C}$, the number should be 3 digits and temperature unit must be in upper case in SMS command

7.27.7.1 Temperature Alert Setting

Send SMS command “temperature+password+space+***C, ***C” to the tracker, it will reply “temperature ok”. When the temperature is beyond the limited range, the tracker will send SMS alarm to the authorized numbers in 3 minutes interval. For example: Send SMS “temperature123456 -020C,060C”, when the temperature is below -20°C or above 60°C , the tracker will send SMS alarm to the authorized numbers in 3 minutes interval. With siren beeps 30 seconds with turn light flashing.

7.27.7.2 Temperature Alerts Canceling;

Send SMS command “notemperature+password” to tracker, it will reply “notemperature OK”

7.27.7.3.Switch between Celsius and Fahrenheit

The default temperature unit is Celsius, in the sms command C = °C F= °F
You can switch from “C” to “F” by sending SMS command “temperature+password+space***F, ***F” to the device, it will reply “temperature ok”.

7.27.8. Low battery alarm

7.27.8.1 Send SMS “lowbattery+password+space+on”, it will send SMS “low battery+latitude/longitude” to authorized numbers 2 times in total **in 15 minutes interval** when voltage of battery is going to be about 3.55V.

7.27.1.2 This function activates as default, send SMS “lowbattery+password+space+off” to deactivate.

7.27.9 Power off alarm

7.27.9.1 Send “ extpower+password+space+on” to activate, it will send SMS “power alarm+latitude/longitude” to authorized numbers every 3 minutes when external power is cut off.

7.27.9.2 This function activates as default.

Cancel: Send SMS “ extpower+password+space+off” to deactivate it.

7.27.10. GPS Blind Spot Alert

7.27.10.1 This function deactivates as default, send SMS “gpssignal+password+space+on”, it will send alert SMS “no gps+last valid latitude/longitude before lost signal”

7.27.10.2 Send SMS “gpssignal+password+space+off” to deactivate.

7.27.11 Accident Alarm (Optional)

7.27.11.1 When tracker detects accident occurred (severe impact) during normal driving, it will send "Accident! + latitude & longitude " to all authorized phone numbers.

7.27.11.2 This function is active as default. To disable this functions, send "Accident+password+space+off" to tracker.

7.27.11.3. Send "Accident+password+space+on" to tracker, when need to active this function.

7.28. Alarms under Arm State

7.28.1 Door Open Alarm

When the door open during arm mode, the device will send sms "door alarm +lat/long" to Authorized no. in 3 minutes interval; Siren beeps 30 seconds continuously with turn light flashing.

Disarm the device to stop.

7.28.2 Bonnet alerts

When open bonnet during arm mode, the device will send "bonnet alarm+lat/long" to Authorized no. in 3 minutes interval; siren beeps 30 seconds continuously with turn light flashing.

Disarm the device to stop.

7.28.3 Footbrake Alarm

The Tracker will send SMS: "Footbrake alarm+lat/long" to the authorized numbers in 3 minutes interval when the Footbrake of the car stepped in arm status; the siren beeps 30 seconds with direction LED flashing, send commend: "disarm+password" to stop.

7.28.4 Acc Alarm

The tracker will send SMS “ACC alarm+lat/long” to the authorized numbers in 3 minutes interval when the engine of the car is turned on, that is the key is rotated to ACC.ON position to start the car in arm state; Siren will sound for 30 seconds, send disarm command “disarm+password” to stop it.

7.28.5 Shock Sensor Alarm (Option)

The tracker will send SMS “Sensor alarm+lat/long” to the authorized numbers in 3 minutes interval when the sensor is triggered in arm status; the siren beeps 5 seconds if shock sensor alarm is triggered one time in 15 seconds and beeps 30 seconds if it is triggered two times in 15 seconds, send disarm command “disarm+password” to stop it.

7.29 Auto Photograph (Option)

When the tracker terminal device detects DOOR/ ACC / SOS / alarm, the tracker device will be automatically ready for photo during sending the alarm and then shoot camera to upload the photo to the monitoring platform (web server).Meanwhile, the device will send link SMS to all authorized cell phone numbers, then photos can be viewed on cell phone .All photos will be automatically saved in the SD card, and viewed after copied to computers through card reader,

7.30 Alerts Resend

When vehicle enters GSM blind areas, the siren beep in Non quite mode if DOOR/SHOCK SENSOR/ACC, OIL alarms are triggered, and all these alarms will be stored and send to authorized numbers or web server after GSM signal recover.

7.31 Trigger Memory

When door of car is open, siren beep 1 time with direction indicator on for 3 seconds during disarm mode means the vehicle be trigged.

7.32 No GSM Alarm

When Vehicle enters GSM Blind area, the siren beeps in Non quite mode without sms sending if DOOR,SHOCK SENSOR/ACC alarms are triggered.

7.33 Cut off oil and power system

7.33.1 Send SMS command “stop+password” to the GPS, it will reply “Stop engine Succeed” and remain the immobile state until receiving the next SMS command to resuming the oil and power.

7.33.2 Stop Mode

7.33.2.1 Execute immediately: Send command “quickstop+password” to GPS, it will reply “quickstop OK”. Then it will stop the car immediately after “stop” command.

7.33.2.2 Execute depends on speed(Default mode): Send command “noquickstop+password” to tracker, It will reply “noquickstop OK”, Then the tracker won't stop the car immediately after “stop” command, instead, it will reply “it will be executed after speed less than 20KM/H”, and stop the car when the speed is less than 20KM/H.

7.34 Resume the Oil and Power System

Send “resume+password” to tracker, it will reply "Resume engine succeed", that means vehicle has resume the oil supply.

7.35 Auto-arming

After stop the car and close the door, within one minute, if no arm action, anti-theft system automatically close the door and enter into arm status.

This function is deactivated as default, send command: “auto arming+password” can set up this function, and turn off the function after command resent.



7.36 Door closing remind

Door closed improperly during arm mode, siren beeps 3 times with turn light flashing to remind

7.37 Park warning

When ACC is off and door is open, turn light will flash, informing cars behind. Press any button to stop it

7.38 Automatic Central Locking System

When Vehicle is on (step on footbrake and then turn on ACC), step on the footbrake to lock the door automatically, during driving process, press  Button to lock or press  button to unlock the door.

7.39 Setup Appointment (Option)

To auto start the manual transmission vehicle, the car should be started in advance when parking. Otherwise, the vehicle cannot be auto started.

7.39.1 Car Type Setting

Manual-transmission vehicles need be started in advance.

Send sms “Cartype+password+space+hand”, gps device will reply “cartype hand ok !” . Vehicle is manual transmission (MT) type.

Send sms “Cartype+password+space+auto”, gps device will reply “cartype auto ok!”, Vehicle is auto transmission (AT) type.

7.39.2 Operations of MT Vehicle setup appointment

- 1) When stop the car, push Gear lever into nature before the ignition is off
- 2) Pull up the handbrake, release the footbrake.
- 3). the vehicle will stay mobile state for 2 minutes, and then pull out the key to turn off the engine.
- 4). After turn off engine, open door and close door, Turn light flashes 2 times. Startup appointment succeeds.

7.39.3 Appointment Fail

- 1) Ignition turn off automatically in 2 minutes, appointment fail.

2)

The footbrake is in stepping while you take out the key, appointment fail.

7.39.4 Cancel startup appointment

- 1). Push footbrake and pull out key to stop engine .Startup appointment will be not activated.
- 2). Open car door or turn on engine can cancel startup appointment.
- 3). Send door open alert or ACC alert can cancel startup appointment.

7.40 Start/turn off car remotely

7.40.1 start/turn off car remotely by remote controller

Long press  button on remote controller, the car will start in 2 seconds.

Prerequisites are: The key is not placed “On”, MT vehicle startup appointment succeeds, AT vehicles are on P or N gear (the handbrake should be pulled up)

Results: The siren and turn light act one time if succeeds. The siren and turn light act 2 times if not succeed for 3 times. When it is in arm state, after start car remotely, it still remains arm state. Before loading, driver should switch vehicle to “disarm “state by turning key to “On “place (Attention: artificial ignition is forbidden. Footbrake should be pushed one time before driving). When the engine turns on for more than 10 minutes and key is not pushed to “On “place, engine will automatically turn off.

After starting remotely succeeds, long press , the car will turn off.

7.40.2 Start / turn off car remotely by sms

Send sms“carstart+password”, gps device replies “now start the car!” and starts the car remotely. Send “carstart+password” again to turn off car and “flameout ok!” will be replied.

7.41 Empty / Loaded

The Device will send message to monitor center when anybody get in/off the car.

7.42 Check the Vehicle State

Send SMS command “check+password” to the tracker device in the vehicle, It will reply the status of external power, battery, GPS reception, ACC, door, GSM reception, GPRS and oil consumption to the authorized numbers.

For example: Send SMS “check123456” to the tracker device in the vehicle, it will

reply following SMS after **executed** the command.

Power: ON/OFF Battery: 100%

Door:OFF ACC:ON

GPS:OK

GPRS:OFF line

GSM Signal:21 (1-32) the higher digit it shows; the stronger of GSM reception it receives.

Oil: 65.5% 65.7% Temperature: +32.0

7.43 Reset by SMS

Send SMS “reset+password” to tracker device to reset the GSM module and GPS module of the tracker device, it will reply “reset ok”.

7.44 Sleep Mode

7.44.1 The function is off as default, send sms commend:

“sleep+password+space+on” device will reply “sleep on ok”, when ACC is off, the GPS will enter sleep mode, any call, sms or alarm trigger will make it work.normal.

7.44.2 Off: send sms commend: “sleep+password+space+off” the tracker will reply: “sleep off ok”,

The tracker will be on and GSM and GPS LED indicator flash as normal.

7.45 Check IMEI

Send SMS command "imei+password" to the unit. E.g. Send SMS command "imei123456" to the tracker device, an IMEI number in 15 digits will reply to your cell phone.

7.46 Terminal (local) Time Setting

7.46.1 Send SMS command “time+space+zone+password+space+time” to the tracker unit, If succeed, It will reply “time OK”.

7.46.2 For example: In China Send SMS “time zone123456 8”, 8 is Chinese time zone, If your country time zone is minus (-8), send SMS “time zone123456 -8”.

7.47 TCP/UDP switch

Send command: "gprs+password,0,0" switch back to TCP mode, and TCP is the default mode.

Second command:"gprs+password,1,1" switch to UDP mode.

7.48 Configure parameters by USB

Copy the Serial debugging tool (SSCOM.EXE) to computer, connect the tracker with computer and open serial debugging tool with the USB cable (optional parts), then choose correct COM port, baud rate is 19200, send serial port command (Tick "send new " on SSCOM interface): \$SET GT PARA, tracker will return the sample format of the command, send appropriate commands according to the sample format of command. Tracker will return "ok" after succeeding in configuring to indicate successful configuration. For detailed operations, please check "COM PORT COMMAND USER MANUAL"

7.49 GPRS Setting

User must send SMS via cell phone to set up APN, IP and port before starting tracking by GPRS.

7.49.1 Configure APN

APN differs from country to country. For more information about your local APN, please inquire with your local GPRS network operator.

7.49.1.1 APN settings of the first SIM card: (External SIM card is the first SIM card)

Send SMS "APNONE+password+Space+your local APN" via a cell phone and if succeeded, the tracker will return the message "APN OK".

7.49.1.2 APN settings of the second SIM card: (Internal SIM card is the second SIM card)

Send SMS "APNTWO+password+Space+your local APN" via a cell phone

and if succeeded, the tracker will reply “APN OK”

7.50.1.3 E.g. Send SMS command “APNONE123456 CMNET”. If succeeded, tracker will reply “APN OK”

Notes: 123456 refer to password of tracker and CMNET is the APN of the china mobile.

7.49.2 Configure GPRS User Name and password

7.49.2.1 In most countries, the user name and password involving GPRS login are not compulsorily necessary, therefore, the entry can be skipped. For those countries requiring user name and password, please configure as following:

7.49.2.2 User name and password settings of the first SIM card

Send SMS “upone+password+space+user+space+password”If succeeded, tracker will reply “user,password ok! ”

7.49.2.3 User name and password settings of the second SIM card

Send SMS “uptwo+password+space+user+space+password”If succeeded, tracker will reply “user,password ok! ”

7.49.2.4 For instance, send SMS “upone123456 jonnes 666666” to the tracker, and if succeeded, tracker will reply “user, password OK”

Note: 123456 is tracker device password, jonnes is the user name for GPRS login, 666666 is the password for GPRS login.

7.49.3 Configure IP and Port

7.49.3.1. Send SMS as below via a cell phone:

adminip+password+Space+IPAddress+Space+Port Number. If succeeded, “adminip OK” is returned by the device in SMS.

749.3.2 E.g. Send SMS command “adminip123456 202.104.150.75 9000” to the tracker device, If succeeded, “adminip OK” is returned by the device in SMS.

(123456 is default password, 202.104.150.75 is IP, 9000 is port).

7.50. Less GPRS traffic

7.50.1 Tracker will change to less GPRS traffic mode after parking 5 minutes

(ACC is OFF), GPRS disconnect and connect again when alarm being triggered or vehicle starts driving.

7.50.2 Activate this function: Send "less gprs123456 on", tracker will reply "less gprs on ok".

7.50.3 Deactivate this function: Send "less gprs123456 off", tracker will reply "less gprs off ok".

Note: 123456 is the password of tracker, and replace it with the new if you have changed.

7.51. Modes Switch between “SMS” and “GPRS”

7.51.1 The default mode is “SMS”

7.51.2 Send SMS “GPRS+password” to the unit, and it will reply “GPRS ok!” it means tracker device has switched to “GPRS” mode.

7.51.3 Send SMS “SMS+password” to the unit, it will reply “SMS ok!” and restore to “SMS” mode. ◦

7.52 Set up monitor center number

7.52.1 Setup: send command “centernum+password+space+number” to tracker, it will reply “centernum ok”. After setup monitor center number, the messages of auto track by sms will be set to this center number, if all alarms need to be sent to this number too, then this center number must be setup as authorized number.

7.52.2 Cancel: Send “nocenternum+password” to tracker, it will reply “no center num ok”.

7.53 Web platform and PC installation tracking

software user manual

7.53.1 Web based platform www.gpstrackerxy.com. Configuration IP: 202.104.150.75 Port: 9000. Please check “software platform user manual” included in the CD for detailed operation information.

7.53.2 PC based installation tracking software user manual included in the CD in package.

8. Cautions

Please comply with the instructions to extend the unit life:

- 8.1. Keep the unit dry. Any liquid, i.e. rain, moisture, may destroy or damage the inside circuitry.
- 8.2. Don't use & store the unit in dusty places.
- 8.3. Don't put the unit in overheated or overcooled places.
- 8.4. Handle carefully. Don't vibrate or shake it violently.
- 8.5. Clear the unit with a piece of dry cloth. Don't clean in chemicals, detergent.
- 8.6. Don't paint the unit, this may cause some foreign materials left in between the parts.
- 8.7. Don't disassemble or refit the unit.
- 8.8. Please read the user manual carefully before installation and operation, learn something more about the voltage range. Otherwise, it won't work properly or destroy the product.
- 8.9. Web platform and PC installation tracking software user manual pls refer to the CD included in the Standard Package.

9. FAULTS & THE SOLUTIONS

Faults	Solution
Startup Fail	Please check out the power wiring in correct place.
No GSM Signal	Check GSM Antenna be correct connected and correct place to put, Check whether the SIM card in place. Make sure the SIM Card should be GSM , PIN code off and no call transfer. Check whether the voltage of the vehicle is normal.
No GPS Signal	Check GPS Antenna correct connected or not and GPS antennas should put to the place near the windows of vehicle, no covered by metal parts.
SMS reply fail	Password incorrect or wrong sms commands format
Hang up Fail or alarms fail to get	Authorized no. setting fail or no no authorized no set, Please initialize the unit and re-set up the authorized numbers.
Engine Stop Fail	Check the relay wire connection for engine cutting.
Central lock fail	Check if the external cable is connected well according to Wiring diagram
Remote Controller , Dial panel fail	Pls restart and reprogram after external power disconnect .

Siren Fail	Siren's voltage is DC12V/24V/1A. Siren can't be triggered if connect to negative trigger.
------------	---