



# **GUIDANCE FOR REINFORCEMENT & SPLICING OF CAGES**

09/04/2020

<b>1</b>	<b>INTRODUCTION</b>	<b>4</b>
<b>2</b>	<b>DESIGN OF LIFTING AND SPLICING BANDS</b>	<b>4</b>
<b>3</b>	<b>SPLICING OF REINFORCEMENT CAGES</b>	<b>4</b>
3.1	U-CLIPS (WIRE ROPE CLIPS / BULLDOG GRIPS)	5
3.1.1	<i>Introduction to the product</i>	5
3.1.2	<i>Design verification</i>	5
3.1.3	<i>Practical application</i>	6
3.2	ZIP SPLICE	6
3.2.1	<i>Introduction to the product</i>	6
3.2.2	<i>Design verification</i>	7
3.2.3	<i>Practical application</i>	7
3.3	QUICK SPLICE	9
3.3.1	<i>Introduction to the product</i>	9
3.3.2	<i>Design verification</i>	10
3.3.3	<i>Practical application</i>	11
3.4	SAFE SPLICE	12
3.4.1	<i>Introduction to the product</i>	12
3.4.2	<i>Design verification</i>	12
3.4.3	<i>Practical application</i>	13
3.5	SUPERLATCH	14
3.5.1	<i>Introduction to the product</i>	14
3.5.2	<i>Design verification</i>	15
3.5.3	<i>Practical application</i>	15
3.6	COUPLERS	17
3.6.1	<i>Introduction to the product</i>	17
3.6.2	<i>Design verification</i>	18
3.6.3	<i>Practical application</i>	18
3.7	FISH PLATES	19
3.7.1	<i>Introduction to the product</i>	19
3.8	DESIGN VERIFICATION	19
3.9	PRACTICAL APPLICATION	19
<b>4</b>	<b>RESERVATION TUBES INSIDE CAGES</b>	<b>21</b>
4.1	INTRODUCTION	21
4.2	RISKS	22
4.2.1	<i>Transportation</i>	22
4.2.2	<i>Lifting</i>	23
4.2.3	<i>Detailing</i>	23
4.2.4	<i>Water tightness</i>	27
4.2.5	<i>Common problems post construction</i>	27
4.3	TYPES OF RESERVATION TUBES	28
4.3.1	<i>Sonitec</i>	29
4.3.2	<i>Durvinil</i>	31
4.3.3	<i>Thick wall steel pipe</i>	32
4.3.4	<i>Square inclinometer tubing</i>	34
4.4	COUPLERS	35
4.4.1	<i>Push fit coupler</i>	36
4.4.2	<i>Union coupler</i>	37
4.4.3	<i>Teekay coupler</i>	37
4.4.4	<i>Supersonic connectors</i>	39

**TABLE OF FIGURES**

FIGURE 1: U-CLIP (WIRE ROPE/BULLDOG GRIP).....	5
FIGURE 2: ZIP SPLICE PRIOR TO ASSEMBLY .....	7
FIGURE 3: ZIP SPLICE AFTER ASSEMBLY .....	7
FIGURE 4: ZIP SPLICE CONNECTION DETAIL.....	8
FIGURE 5: ZIP SPLICE INSTRUCTIONS.....	8
FIGURE 6: CAGE SPLICE USING QUICK SPLICE SYSTEM.....	9
FIGURE 7: COMPONENT PARTS OF QUICK SPLICE .....	10
FIGURE 8: TESTING OF LINDAPTER CLAMP .....	10
FIGURE 9: QUICK SPLICE CLAMP .....	11
FIGURE 10: SAFE SPLICE SYSTEM.....	12
FIGURE 11: LAB TESTING APPARATUS FOR BOLT LOAD TEST .....	13
FIGURE 12: SAFE SPLICE CONNECTION ON PILE CAGE .....	14
FIGURE 13: VARIOUS SUPERLATCH SIZES .....	15
FIGURE 14: ENGAGED SUPERLATCH SYSTEM (RED) AND SPLICING BAND (BLUE) ON ROTARY CAGE .....	16
FIGURE 15: SUPERLATCH RELEASE TOOL.....	16
FIGURE 16: LENTON TYPE P13 COUPLER.....	17
FIGURE 17: ANCON TAPERED THREAD POSITIONAL COUPLER .....	17
FIGURE 18: USE OF POSITIONAL COUPLERS IN PILE CAGE.....	17
FIGURE 19: TORQUEING UP OF POSITIONAL COUPLERS IN MINI-PILE CAGE .....	18
FIGURE 20: FISH PLATE SYSTEM.....	19
FIGURE 21: SPLICING OF DIAPHRAGM WALL CAGES USING THE FISH PLATE SYSTEM.....	20
FIGURE 22: SPLICING OF SONIC TUBES WITH HANDS IN CAGE .....	21
FIGURE 23: TOP TUBE HAS SLID OUT DURING TRANSPORT OF THE CAGE.....	23
FIGURE 24: IMPACT BRACKET FOR SONIC TUBES.....	24
FIGURE 25: PHOTO OF IMPACT BRACKET .....	25
FIGURE 26: IMPACT BRACKET AND STOPPERS .....	25
FIGURE 27: CLOSE UP OF SLIDER/STOPPER AND LOCATOR BRACKET .....	26
FIGURE 28: STIRRUP OBSTRUCTING THE MOVEMENT OF THE SONIC POINT DUE TO PRESENCE OF TUBE JOINT .....	27
FIGURE 29: USE OF DENSO TAPE TO ENHANCE WATER TIGHTNESS OF JOINT .....	28
FIGURE 30: FILLING OF SONICE TUBES WITH WATER PRIOR TO CONCRETING.....	28
FIGURE 31: TYPICAL DETAILS FOR SONITEC TUBE.....	29
FIGURE 32: FIXING OF SONITEC TUBES USING ZIP WIRES.....	30
FIGURE 33: SECURING MECHANISM FOR LIGHT WEIGHT STEEL TUBES USING JUBLIEE CLIPS.....	30
FIGURE 34: SECURING MECHANISM FOR LIGHT WEIGHT STEEL TUBES USING TIE WIRE .....	31
FIGURE 35: DURVINIL SONIC LOGGING TUBES WITH SCREW JOINT.....	32
FIGURE 36: SCREW FIT SOCKETS .....	32
FIGURE 37: END CAPS.....	32
FIGURE 38: OPERATIVE TRYING TO ALIGN AND CONNECT SONIC TUBE USING UNION COUPLER .....	33
FIGURE 39: UNION COUPLERS CONNECTED WITHIN CAGE .....	34
FIGURE 40: SQUARE INCLINOMETER PIPE (LEFT SIDE – VIEW FROM THE TOP, RIGHT HAND SIDE – BOTTOM END).....	34
FIGURE 41: JOINT DETAIL FOR THICK WALL STEEL TUBE WITHIN ONE CAGE SECTION (DONE BY CAGE MANUFACTURER).....	35
FIGURE 42: PUSH FIT WITH A BOLTED RESTRAINT .....	36
FIGURE 43: UNION COUPLERS.....	37
FIGURE 44: TEEKAY COUPLER (BROCHURE).....	38
FIGURE 45: TEEKAY COUPLER CONNECTION FOR SONIC TUBE INSIDE CAGE.....	39
FIGURE 46: SUPERSONIC CONNECTOR .....	40

**TABLE OF TABLES**

TABLE 1: SAFE SPLICE BOLT CAPACITIES .....	12
TABLE 2: SUPERLATCH CAPACITIES.....	15

## 1 Introduction

Reinforcement cages are a key part of any piling operation. Often, these cages cannot be installed as a single piece and need to be spliced. The lifting and splicing of cages represents a high risk activity with the potential of causing harm.

Piling contractors and reinforcement suppliers are making great strides in developing innovative safe and simple to use cage splicing systems. These have in some situations eliminated the need for hands and arms to be inserted into the cage.

Originally cages would be manufactured on site with very little quality control in place. Today, prefab cages are far more common and the quality control aspects have vastly increased, which has also had an effect on the safety aspects of this operation.

The only splicing system originally available was tying wire, prior to bulldog clips becoming available. Over the past 15 years, safer and more reliable mechanical splicing mechanisms have been developed.

Lifting bands form one of the most safety critical parts of the cage, ensuring that the cage can be lifted safely. Splicing bands are also commonly used when splices are required. These are similar to lifting bands. Both band types form part of the temporary works of a reinforcement cage and should be designed and installed in accordance with the design of a competent person.

This report examines the processes and procedures used within the industry for the design and installation of lifting and splicing bands. It also lists the various options currently available on the market for the safe splicing of reinforcement cages for piling and diaphragm walls and discusses the design assumptions for each system, the key benefits but also the disadvantages. Apart from the splicing itself, this report also includes the risks involved during the splicing of reservation tubes and latest developments in this sector.

In order to improve safety for everyone even further, this report sets out to analyse trends and root causes and how the developments over the past 15 years have influenced the type of incidents and what further changes are required.

## 2 Design of lifting and splicing bands

Most cages produced by off-site cage suppliers are of a similar design in terms of lifting bands. Lifting bands are generally not specified by the piling contractor when cage details/shop drawings/pricing is requested. Lifting bands are generally sized using spreadsheets previously developed by a Chartered Structural Engineer. For complex cages, external consultants are often employed to carry out detailed calculations. All suppliers have their own Product Liability Insurance to specifically include this.

## 3 Splicing of reinforcement cages

Splicing of cages has the potential to cause significant injuries. Over the past two decades, various advances have been made to mechanically splice cages, but only recently have these advances also considered minimising the need for operatives to place their hands within the cage structure.

There are now various systems commonly available to minimise/eliminate the need for physical intervention. Some systems simply lock together as the two parts of the cage are positioned, others require some physical intervention.

Whilst improving the safety of operatives has to be the main focus, there are undeniably positive effects on the quality using a proprietary system for splicing cages. Ensuring that the systems are installed correctly so that the cages will fit together with minimal risk and effort is absolutely critical to the success of this strategy. Systems must be checked for alignment by the cage manufacturer prior to any deliverables arriving on-site.

This section will describe each of the systems available for both pile and diaphragm wall cages, detail the available design information on each system and comment on the quality checks that need to be carried out prior use on site.

It should be noted that the systems are listed in no particular order.

### 3.1 U-Clips (Wire Rope Clips / Bulldog Grips)

#### 3.1.1 Introduction to the product



Figure 1: U-clip (wire rope/bulldog grip)

Wire rope clips, or bulldog clips as their commonly known, are primarily designed for the termination of steel wire ropes, as stated in BS EN 13411-5:2003.

Although the U-Clips primary function isn't for the connection/splicing of reinforcement, the standards do state that *'other suitable uses include suspending static loads and single use lifting operations which have been assessed by a competent person considering appropriate safety factors'*.

#### 3.1.2 Design verification

In the absence of specific design verification data available for the use of U-Clips as a reinforcement connection accessory, U-Clips should only be used for this purpose if the specific product to be used has been *'assessed by a competent person considering appropriate safety factors'*.

It should also be considered that the orientation of the rebar itself may affect the effectiveness of the U-clip and thus the connection strength.

### 3.1.3 Practical application

U-Clips are used to connect main bars of upper and lower reinforcement sections over an open bore or panel. Typically, this will be with the U-bolt orientated toward the internal face of the pile or panel to allow the user to fit the bridge and collar nuts with ease. This process requires the user to place hands within the reinforcement splice zone to fit the U-bolt.

Hazards associated with this system are:

- Main lap bars of reinforcement section trapped off requiring levering towards the main bar to facilitate the connection which can result in trapped fingers between bars and/or cuts and bruises from bars springing loose.
- Incorrect type of U-Clip being used resulting in u-clips for larger diameters being used to connect small diameter bars resulting in the U-Clips slipping and the lower main lap bar becoming loose.
- Incorrect type of U-Clip being used resulting in the threaded lengths of the U-Clip contacting the internal face of the pile or panel restricting the installation of the reinforcement and potentially resulting in the failure of the U-Clip.
- Damage to cast iron bridge resulting in failure during installation if one of the collar nuts is overtightened compared to the other.
- Damage to thread of the U-Clip prior to or during installation resulting in the collar nut not being fully fastened.
- Loss of any of the 4 parts of the U-Clip during installation due to the fiddly nature of the components and the difficulty of installation using gloves.

## 3.2 Zip Splice

### 3.2.1 Introduction to the product

The zip splice comprises a length of 4.76mm diameter High Tensile wire Rope Strand, threaded through a modified Zip-Clip Locking device and fitted with a swaged termination ferrule to one end preventing the wire pulling through the locking device.

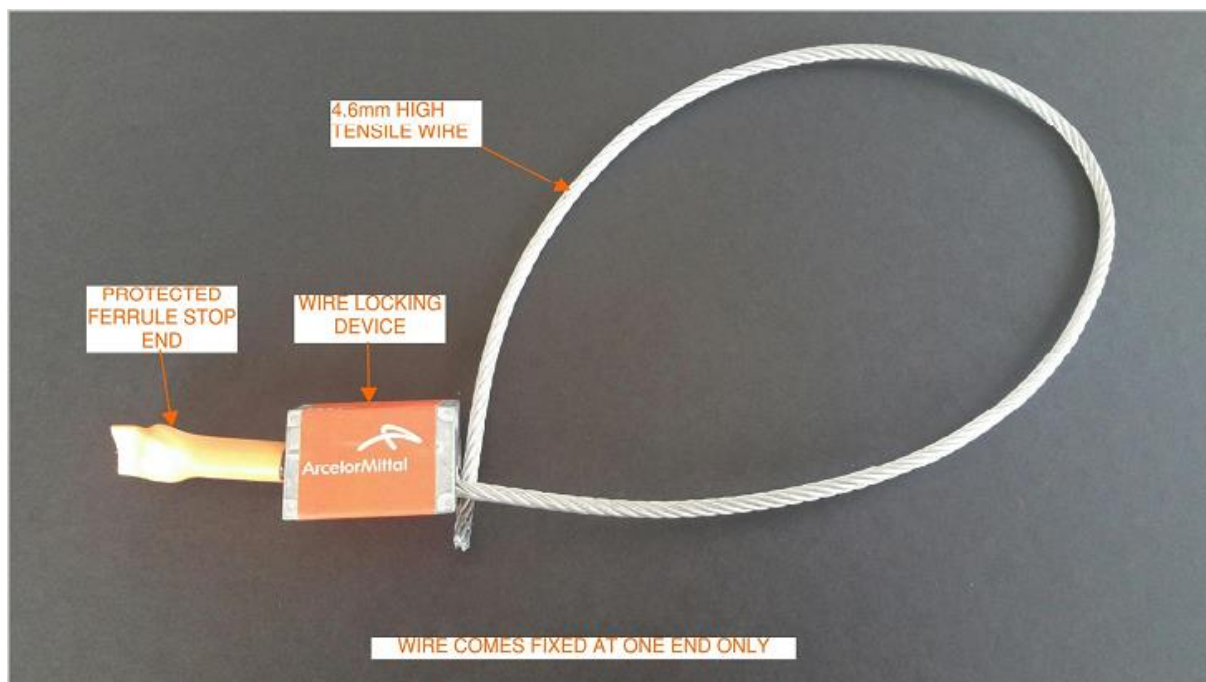

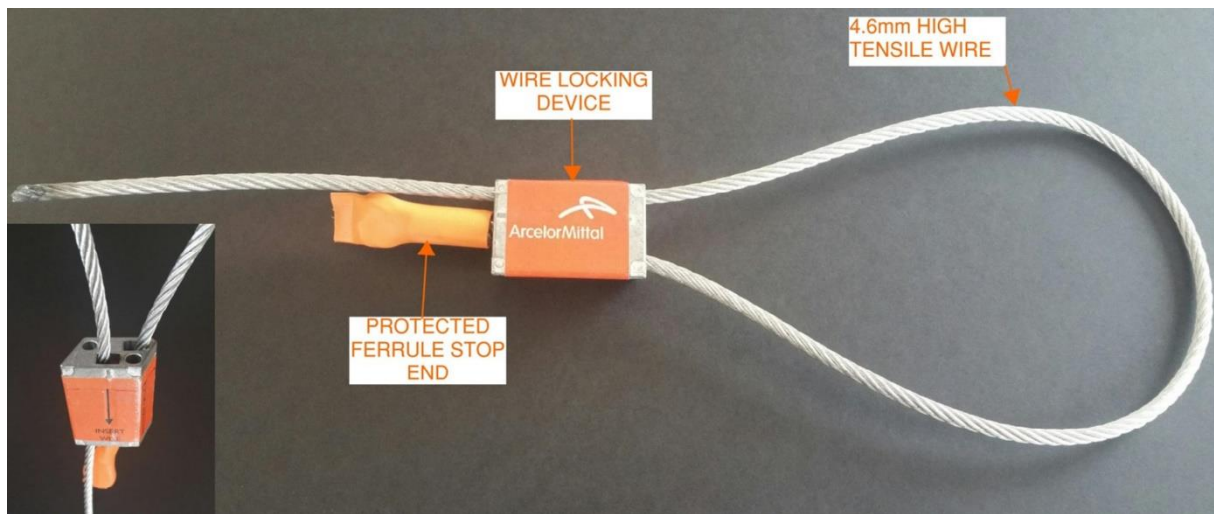

Figure 3: Zip Splice after assembly

The Zip-Splice is applied to the cage splicing bands in the manner of a cable tie with the free end being passed over and around the bands and fed through the appropriate locking slot in the Zip-Clip device. The free end of the strand is pulled hand tight until the locking device is snug under the lower splicing band. The mechanism of the locking device traps the wire rope strand and tightens further as the load is applied.

### 3.2.2 Design verification

The Zip Splice has been tested to proof loads in excess of 1700Kg and as such a SWL of 350 Kg per unit is recommended, providing a FOS of 4.85. The number of Zip Splices required per splice will be indicated on the fabrication drawings.

Where reinforcement is installed in multiple sections, the weight of the sections already installed must be taken into account when fitting clamps. It is recommended that the minimum number clamps is 3 to prevent racking of the splice zone.

### 3.2.3 Practical application

The Zip Splice connects the reinforcement sections together when fitted to prefabricated splicing bands which have been positioned and welded to predetermined locations on the upper and lower reinforcement sections. Typically, the lower connection band will have been fabricated deliberately smaller in overall diameter (by approx. 10mm) to provide a “clearance” that allows the reinforcement sections to fit easily together.

The capacity per connection is very limited making this application more suitable to lighter cages.



Figure 4: Zip Splice connection detail

Hazards associated with using this system are:

- The incorrect number of Zip Splices overloading them and potentially causing failure of the clamps installed.
- Requires operatives to follow installation instructions correctly and thread wire through correct hole.

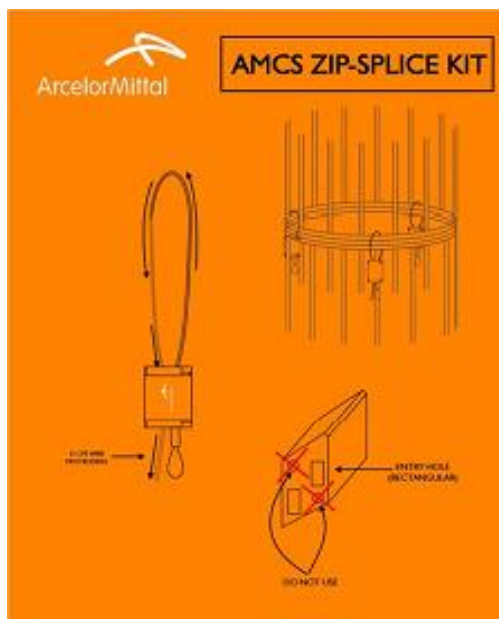

Figure 5: Zip Splice instructions



### 3.3 Quick Splice

#### 3.3.1 Introduction to the product

The Quick Splice is a simple and relatively fast reinforcement connection system which is used commonly within the piling industry. The system requires cranked fabrication of male cage segments to ensure accuracy of construction and fit. A series of clamping devices are required to connect the splice bands of the male and female sections. They are fitted on the outside of the cage.

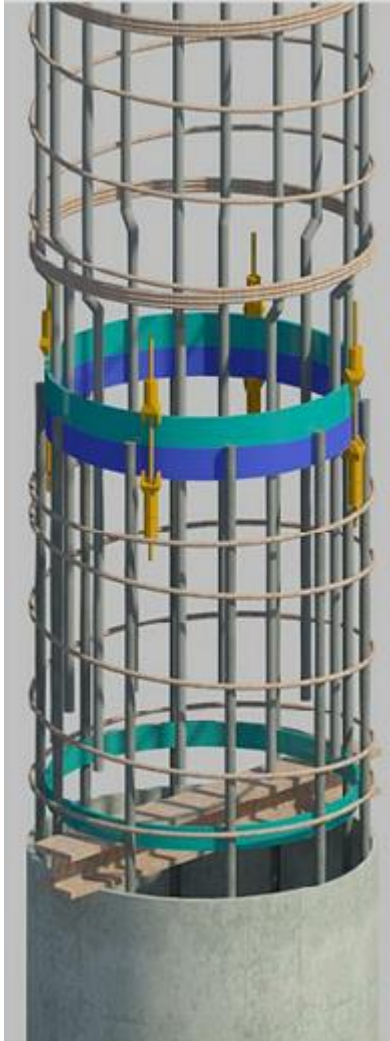

*Figure 6: Cage splice using Quick Splice system*

Figure 7 below shows the key components of Quick Splice.

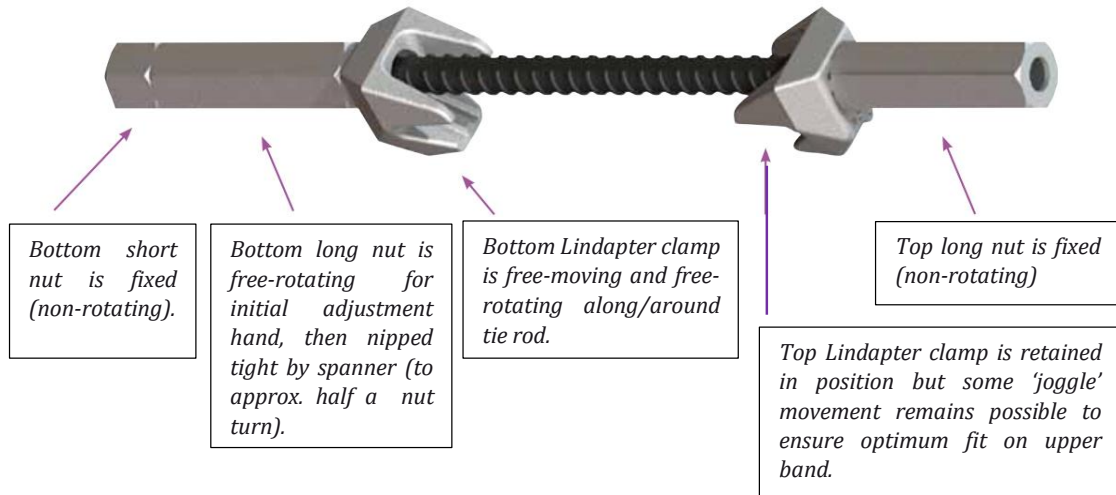

Figure 7: Component parts of Quick Splice

The simple design theoretically allows for the connection of prefabricated connection bands on the upper and lower reinforcement sections to be connected by the user without the need to place their hands within the splice zone.

### 3.3.2 Design verification

Clamp specifications have been supplied by the reinforcement suppliers which include for an overview of the clamps temporary works design. The number of clamps required per splice will be indicated on the fabrication drawings.

The clamps were tested in the laboratory using purpose built cage sections. The clamps were tightened to a low torque of 240Nm, simulating a hand tight setting easily achieved on site without the use of a torque wrench.



Figure 8: Testing of Lindapter clamp

The calculated capacities are as shown below:

- Quick-Splice Clamp 16: up to 12mm thickness, provides a SWL of 20KN (FOS of 4).
- Quick-Splice Clamp 20: 15-18mm in thickness, provides a SWL of 28KN (FOS of 4).

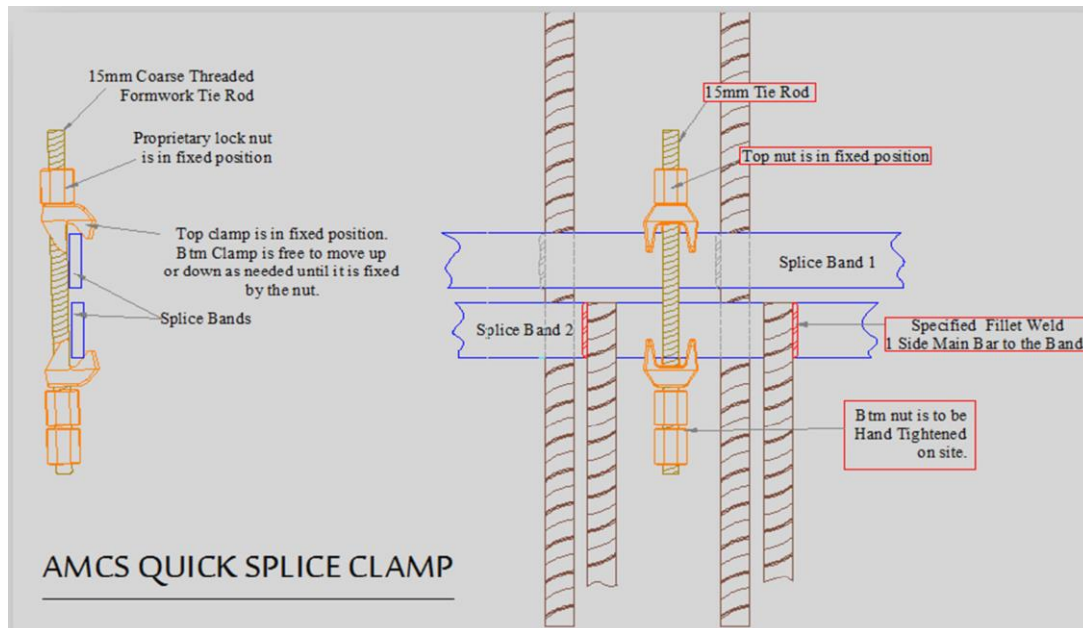

Figure 9: Quick Splice clamp

It is recommended that the minimum number of clamps fitted is three to prevent racking of the splice zone.

### 3.3.3 Practical application

The splice bands have to be located with a high degree of accuracy within the reinforcement cage. The position need to be such that the band on the outside of the male cage rests on the band fitted to the inside of the female cage.

Typically, the lower connection band will be fabricated deliberately smaller in overall diameter (by approx. 10mm) to provide a clearance that allows the reinforcement sections to fit easily together.

Hazards associated with using this system are:

- If the bands are installed at an angle or if one of the bands is significantly smaller than the other, the clamps could be subjected to eccentric loading, torsion and possibly failure.
- The reinforcement cage drawing must be available on site to check the number and size of clamps to be used.
- Use of incorrect number of clamps for the splice, overloading the installed clamps and causing failure.
- Installation of clamps can be made difficult by shear reinforcement if placed too closely to the splice bands.
- Where reinforcement sections are connected which don't have a lap (dummy cages) the sections can move out of alignment causing the clamps to fail.

### 3.4 Safe Splice

#### 3.4.1 Introduction to the product

Safe Splice was created to eliminate the need for use of bulldog grips in 2003. The Safe Splice system uses a wrench to drive bolts through a set of pre welded plates.

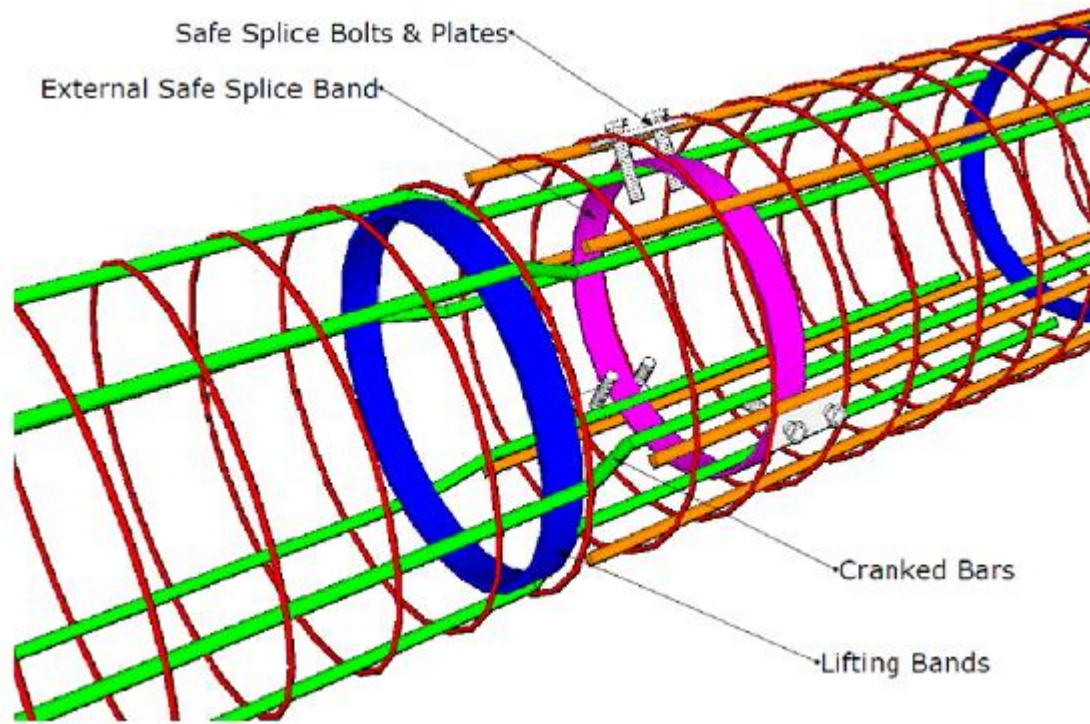

Figure 10: Safe splice system

Three brackets are normally fitted per splice band. Various SWL are available, making it suitable for a wide range of applications.

Table 1: Safe Splice bolt capacities

Bolt Size [mm]*	M16	M20	M24	M27	M30
Proof Test Strength Per Bolt [kN]	60	80	100	130	170
SWL per Bolt [kN]	20	25	33	43	56

\*Based on Grade 8.8 steel

#### 3.4.2 Design verification

A number of tests on the bolts were undertaken and averages were used for as shown in Table 1 (Proof Test Strength). The Safe Working Load was then derived by using a FOS of 3.0 for each bolt. The testing was undertaken in a laboratory using UKAS accredited equipment. The distance between the point of load application and the plate holding the bolt was between 10-25mm which is realistic.



*Figure 11: Lab testing apparatus for bolt load test*

### 3.4.3 Practical application

Bolts will need to be threaded by hand through the bracket, either side of the other splicing band and then tightened. No special torque setting is required as long as the bolts are hand tight.

Should cages have to be taken apart again, the process is simply reversed.



*Figure 12: Safe Splice connection on pile cage*

Hazards associated with using this system are:

- If the splicing bands have become deformed due to transport or storage issues, the load application point onto the bolt may be further away than the design.
- It is also possible that the splicing band could slip off the bolts. This in turn could overload the other bolts and lead to progressive failure of the splice.

### 3.5 Superlatch

#### 3.5.1 Introduction to the product

Superlatch is the most recent development of all proprietary splicing systems. It was first introduced to the market in 2015. It can be used for splicing rotary and CFA cages, as well as diaphragm wall cages. There are various safe working loads available, see below.



Figure 13: Various Superlatch sizes

Table 2: Superlatch capacities

<b>SUPERLATCH® Type</b>	<b>SWL per Shackle (Tonnes)</b>	<b>Compatible Rebar Sizes (mm)</b>	<b>Long Leg Length (mm)</b>	<b>Short Leg Length Radial Reach (mm)</b>
4	0.6	12 – 20	175	62
7	1.0	16 – 25	215	90
8	2.0	25 – 32	275	110
9	4.0	32 – 40	320	125
10	6.0	40 – 50	405	180
12	9.0	40 – 50	550	235

### 3.5.2 Design verification

Superlatch products are proof tested. The load at which no plastic deformation occurs is divided by a FOS of 2.0, which produces the safe working load SWL.

The latches are tested mid span, which can be considered worst case.

### 3.5.3 Practical application

The Superlatch system is installed in the prefabrication yard and comes as one unit with the cage to site. Setting out information is available for cage manufacturers.

The installation on site is 'spectacularly unspectacular'. The top cage is lifted onto the bottom cage and the self-weight of the cage will open the latch to engage with the splicing band of the other cage. The spring on the latch will ensure that the latch is closed once the splicing band is inside the latch. The cage can now be lifted up to remove the trapping band and lowered. No hands are required inside or near the cage during the splicing of cage sections.



*Figure 14: Engaged Superlatch system (red) and splicing band (blue) on rotary cage*

On occasions, it is necessary to take already spliced cages apart again. This can be done using the Superlatch release tool, see below.



*Figure 15: Superlatch release tool*

Hazards associated with using this system are:

- There are no hazards that have been identified as of yet.



### 3.6 Couplers

#### 3.6.1 Introduction to the product

The use of couplers is not uncommon in splicing of reinforcement cages, especially since the introduction of EC7, which does not allow the splicing of H50 bars in any other way. But couplers are also used to connect smaller diameter bar. Various types of couplers are available (by different manufacturers). Any couplers used as splicing mechanism must be a positional coupler with full tensile capacity as it is not possible to rotate the bars inside the cage to connect them to the couplers.

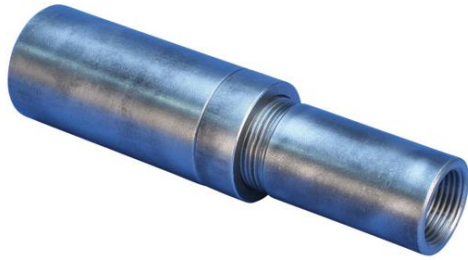

Figure 16: Lenton Type P13 coupler



Figure 17: Ancon tapered thread positional coupler



Figure 18: Use of positional couplers in pile cage

### 3.6.2 Design verification

All couplers used will be CARES approved. As such, they do not require any additional design verification. This type of coupler usually has a full tensile capacity.

### 3.6.3 Practical application

Cages to be spliced with positional couplers have to be made as an assembled piece to ensure that the connections fit together once taken apart. As best practice, the connecting bars should be sprayed up with the same colour coding so that they can be easily identified on site.

Even if the above guidance is followed, problems during the re-assembling of the cage over the hole can occur and are frequent issues delaying the installation of the reinforcement into the pile/panel.

Couplers can also only be used in the first layer of rebar as access to any other layers further to the inside of the pile/panel are not accessible with the torque wrench and thus cannot be tightened to the specified torque setting.

Hazards associated with using this system are:

- Positional couplers require to be torqued up to a specified setting to achieve full tensile strength. In practice, this can be time consuming and requires manual input (the bigger the bar size the more force is required).



*Figure 19: Torqueing up of positional couplers in mini-pile cage*

### 3.7 Fish plates

#### 3.7.1 Introduction to the product

Fish plates are only used to splice diaphragm wall cages, not circular pile cages and are probably one of the original splicing systems on the market.

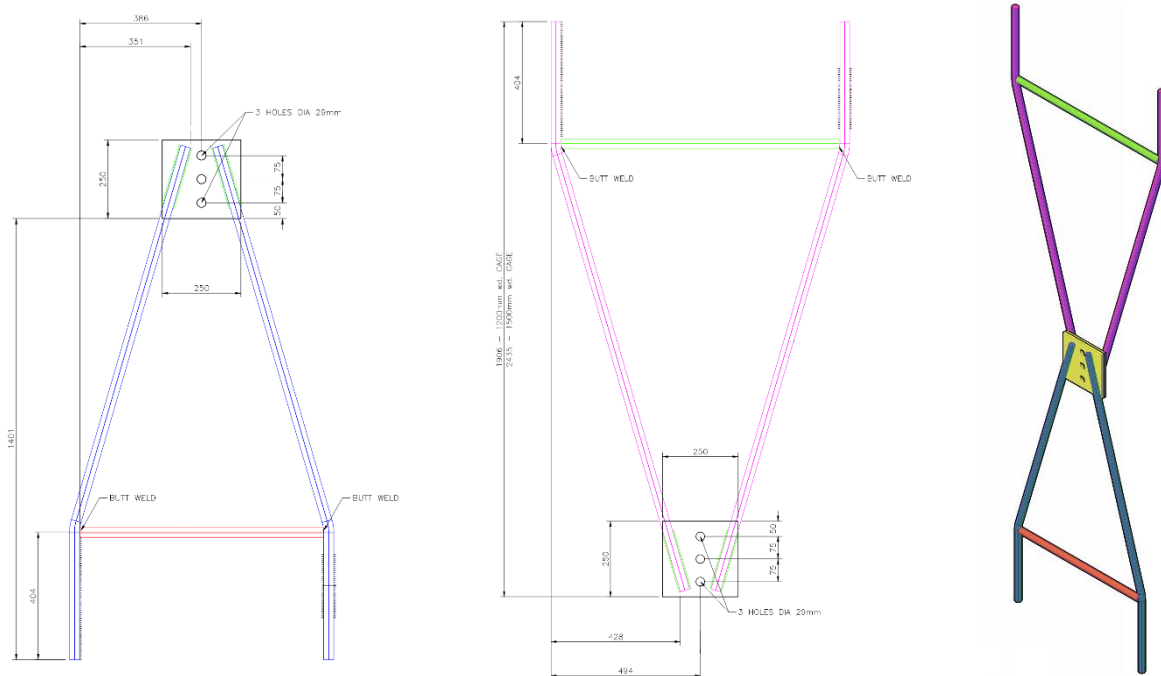

Figure 20: Fish plate system

Both the bottom and top cage are equipped with a plate. The two plates need to be aligned and one or more bolts need to be fixed through the plate and secured with a bolt. This system requires hands inside the cage under the suspended load in order to secure the bolt.

### 3.8 Design verification

The steel frame design which positions the plate and all corresponding welding should be designed and checked by a competent person. The sizing of the bolt(s) should be done in accordance with the relevant codes.

### 3.9 Practical application

In practice, the ease of installation depends on the quality of the fabrication of the diaphragm wall cage.

Hazards associated with using this system are:

- The major downside of this system is the need to have inside the cages and under the suspended loads, see Figure 21.

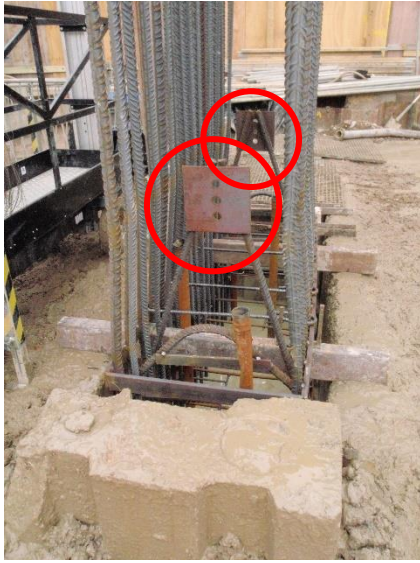

*Figure 21: Splicing of diaphragm wall cages using the fish plate system*

## 4 Reservation tubes inside cages

### 4.1 Introduction

The different methods of splicing reinforcement cages have been introduced in the previous section, however, one key component has not yet been discussed, the splicing of reservation tubes.

Reservation tubes, which include sonic logging, base grouting, extensometer and inclinometer tubes, can still present a major hazard to operatives on site. The reservation tubes sit inside the reinforcement cage which means hands and arms are often placed under suspended sections of cage and tube to align the tube, engage and complete the connections as can be seen in Figure 22.

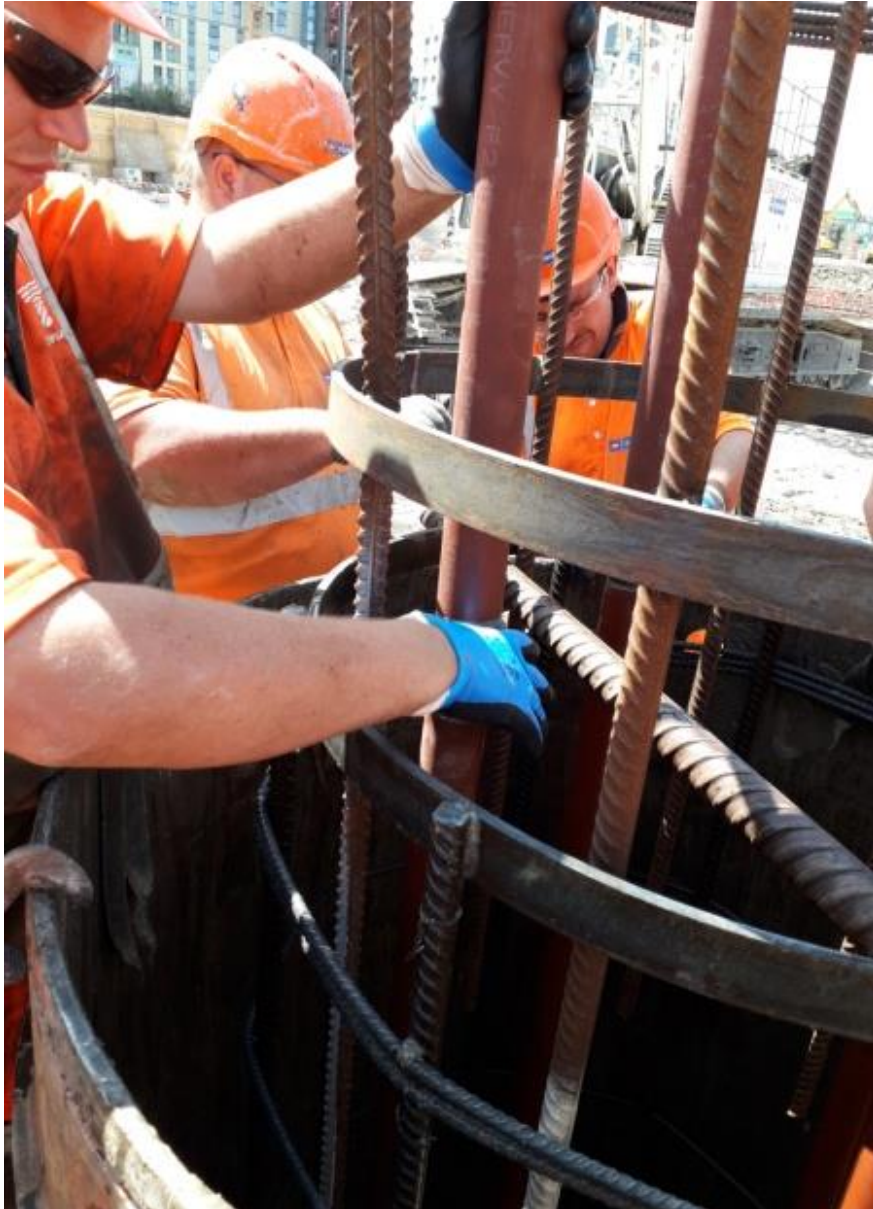

*Figure 22: Splicing of sonic tubes with hands in cage*

The FPS has recorded 41 serious incidents and high potential near misses with sonic tubes since 2010 alone. This number does not include observations and general near misses and is likely to increase as reporting processes are developed further.

Over the years, operatives have lost fingers and thumbs in the course of this operation. People have suffered hand and facial injuries when using elongated tools to tighten tube fittings whilst keeping their hands out of the cage.

Due to the unforgiving nature of this process this report aims to heighten awareness around the risks during the installation of reservation tubes and presents various systems currently on the market, discussing advantages and disadvantages of each product. It details best practice on site to minimise to the risk of injury.

Alternative methods to sonic logging and inclinometer tubes are available. These generally consist of fibre optics or thermal wires and eliminate a significant proportion of risk. However, it may not always be possible to replace sonic logging or inclinometer tubes for technical or economic reasons. No alternatives are currently available for base grouting tubes.

In line with the Construction, Design and Management Regulations (CDM 2015), the FPS encourages all Clients and Engineers to consider whether the use of reservation tubes is necessary or could potentially be replaced by other systems, such as fibre optics, which are inherently more expensive but provide a generally safer alternative. Base grouting tubes cannot be replaced by any other system currently. The designer of the pile should therefore weigh up the risks against the benefits and consider alternative design methods to ensure that the base capacity of the pile is achievable.

This chapter aims to educate the reader on the inherent risks associated with the splicing of reservation tubes and minimise the risk to operatives by assisting to plan and execute the operation in accordance with best practice.

## 4.2 Risks

### 4.2.1 Transportation

To enable the different sections of tube to be connected, they are allowed to slide up and down a given distance, with the exception of the bottom section, which is rigidly connected to the reinforcement cage.

Transporting cages with pre fitted but not rigidly connected reservation tubes raises additional risks, e.g. tubes have either slid out during transport or the non-structural welds of the support brackets have failed because of vibration. This has the potential of affecting non-site personnel, if any items became detached during transport on the public road. In addition, loose items within reinforcement cages present another risk for site operatives as they are difficult to spot.

The acceleration and deceleration of lorries introduces dynamic forces into the cages that are often not considered by temporary works designers.

There have been reported instances of tubes sliding out of the cages during transport, bending and cornering which is a hazard to the public.



*Figure 23: Top tube has slid out during transport of the cage*

#### 4.2.2 Lifting

The tube and restraint system has a different rigidity to the main reinforcement cage and can be subject to dynamic loadings during handling and installation. The horizontal to vertical lift can often cause the tube to slide and thus introduce unforeseen dynamic forces into the restraint system.

Prior to any cage being lifted into its vertical position, care must be taken to ensure that all tubes are fully pulled out and engaged onto their restraint stops.

It is also possible that the tubes may get caught on something and thus exerting forces that were previously unforeseen. If these forces are unforeseen, they are rarely designed for and can lead to the tubes or the restraint system itself failing and falling out of the cage, potentially at height.

#### 4.2.3 Detailing

Piling contractors and reinforcement fabricators have worked hard to mitigate the risks of reservation tubes sliding uncontrollably during transport, lifting and coupling processes. These temporary works consist of stirrup bars, bracket ties and impact blocks welded into cages to act as stops for sliding tubes.

The restraint systems themselves are often not subject to a detailed temporary works check and each supplier uses its own details. The support system is often not detailed specifically with the cage (unless requested) and as such relies on the experience of the steel fixer and welder to ensure that it is installed as intended. These systems are the primary control for the most common hazard that leads to injury and as such should be treated as a high risk, in the same category as lift bands and cage stability.

One example of good practice that has been trialled and tested is shown in Figure 24.

The system needs to allow the free movement of the tubes in a controlled manner. The presence of intermittent joints can cause the tubes to temporarily jam up, increasing the likelihood of an uncontrolled drop.

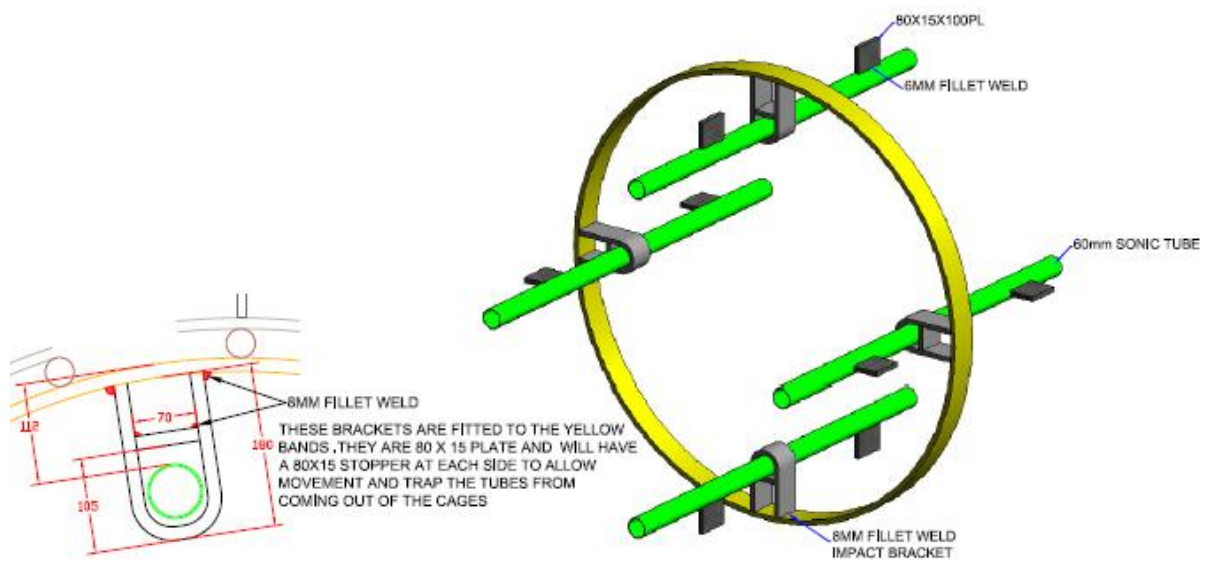

Figure 24: Impact bracket for sonic tubes





Figure 25: Photo of impact bracket



Figure 26: Impact bracket and stoppers



Locator bracket to guide sonic tube (not to hold it in case of fall)

Slider/stopper with weld in direction of travel

Figure 27: Close up of slider/stopper and locator bracket

Experience has also shown that the brackets often used to hold/guide the reservation tubes use welds that are orientated perpendicular to the direction the forces are applied, which puts them at greater risk of simply 'peeling off' when loaded.

As can be seen from the smaller detail on the left, the 8mm fillet weld on the bracket itself is aligned with the direction of travel on the tubes. As a result, the weld is utilised in the correct direction and can be designed appropriately.

Special attention should be paid to the positioning of the restraint stops and stirrups. Clearances should be checked to avoid tube joints catching on the restraint system, see Figure 28.



*Figure 28: Stirrup obstructing the movement of the sonic point due to presence of tube joint*

#### 4.2.4 Water tightness

All connections are required to be watertight. In order to guarantee a watertight connection, various systems are currently available on the market. Some of these require operatives to place their hands and arms within the cage, which should be eliminated if possible due to the risk discussed in the previous chapters.

#### 4.2.5 Common problems post construction

Apart from the risks encountered during the delivery of cages containing void former tubes and the installation, there are some common problems that occur post construction that can be minimised if certain activities are controlled.

1. Effect on sonic logging readings

Depending on the type of joint being used to connect the void formers, additional protective measures may be employed on site to eliminate water ingress. PTFE tape and 'Denso' tape have traditionally been used at the joints to enhance the water tightness. However, it should be noted that the use of such tapes may affect the readings during the sonic logging process.



Figure 29: Use of Denso tape to enhance water tightness of joint

2. All void former tubes should be filled with water prior to concreting. This is intended to equalise some of the fluid pressures (from support fluid or concrete/grout). Although in theory, the void former system should be able to withstand the imposed fluid pressures, it is best practice to offset them.



Figure 30: Filling of sonice tubes with water prior to concreting

3. Flushing of void former tubes after the concrete has reached its initial set. This action is intended to flush out any grout leakage that may have occurred into the void former tube. This should be seen as a preventative measure to avoid blocked tubes.
4. De-bonding of reservation tubes above cut off level  
It is important to ensure that all tubes are de-bonded above cut off level (where they are within the concrete length) to avoid them being damaged during the breaking down off piles.

#### 4.3 Types of reservation tubes

Reservation tubes come in various diameters and cross sections from small diameter extensometer tubing (in the order of 30mm ID), medium diameter sonic logging and base grouting tubes (in the order of 40-60mm ID) to large diameter inclinometer circular or square cross sections (in the order of 100-150mm ID).

# FEDERATION OF PILING SPECIALISTS

The diameter, pile length and associated pressures dictate the material that can be used, the wall thickness required and sometimes the jointing detail. The tube weight and material used then influences the temporary support details and fabrication (welding/bolting) options. Base grouting tubes can be exposed to extremely high grout pressures. This should be considered during selection process of the tubes themselves and the joint details.

The following section details the most commonly used types of tubes on the market (in no particular order).

## 4.3.1 Sonitec

Sonitec is the trade name for a lightweight thin walled (1.0 - 1.5mm) black steel tube with an enlarged bell mouth shape. The joint has a rubber gasket to provide a tight seal. Rubberised end caps are also provided. The tubes can be hung in the cage with steel zip ties connected to the tubes on pre fixed lungs, see Figure 32. The PUSH-FIT system connection has a water tightness up to 200m.

Any welding on tubes with this kind of wall thickness is problematic, even when using fully qualified welders. Due to the ultra-thin nature of this tube type, any welding is likely to cause holes within the tube itself leading to grout ingress during concreting.

The key advantage of this type of tube is that it can be easily manually handled and lifted on site.

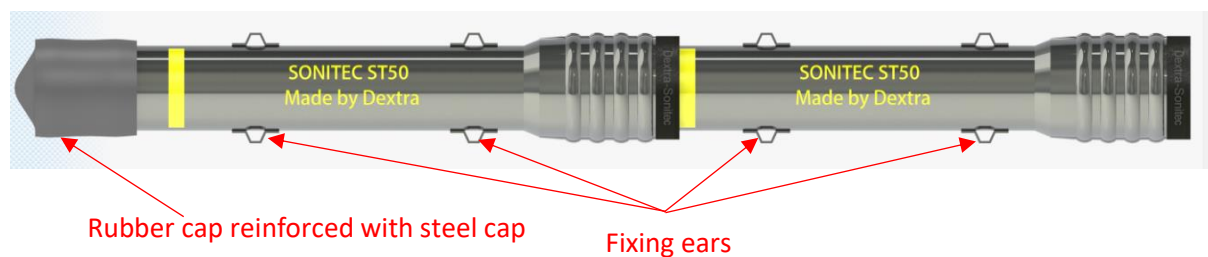

Figure 31: Typical details for Sonitec tube

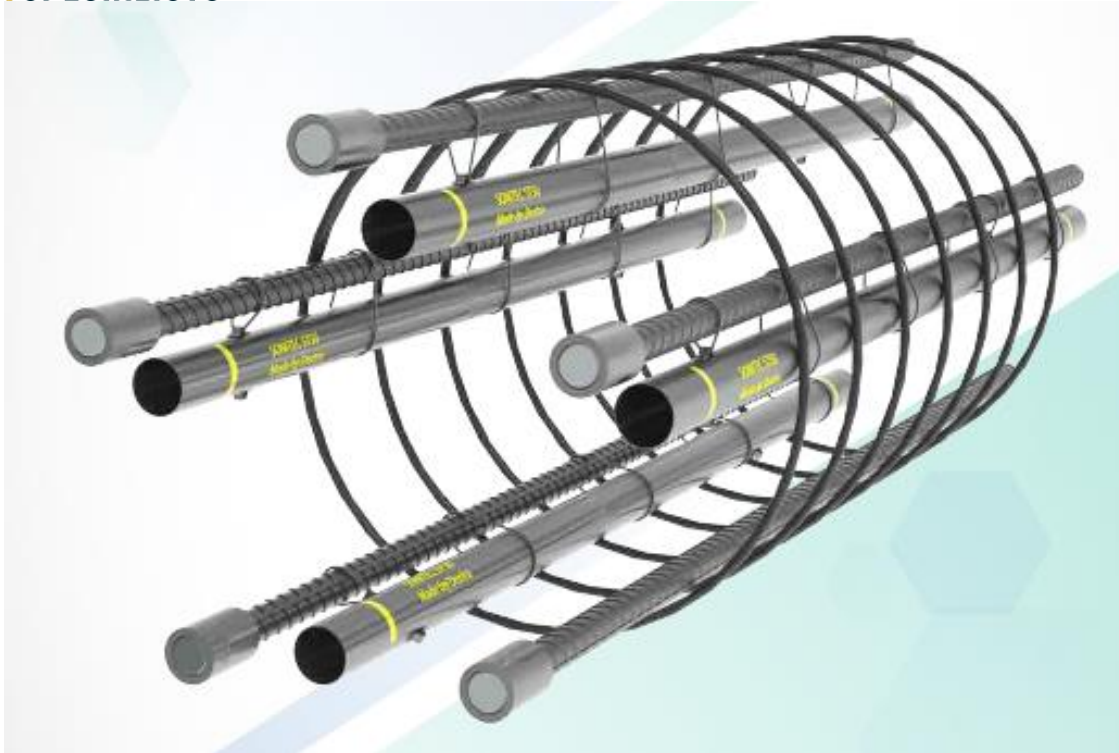

Figure 32: Fixing of Sonitec tubes using zip wires

Due to the problematic nature of welding on light weight tubes, alternative ways of securing them within the cage been developed consisting of tie wire and jubilee clips are often used which need to be accounted for during design.



Figure 33: Securing mechanism for light weight steel tubes using jubilee clips



*Figure 34: Securing mechanism for light weight steel tubes using tie wire*

#### 4.3.2 Durvinil

Durvinil is an alternative light weight PVC pipe with a screwed jointed connection. End caps and top caps are available. The tubes are very light weight and have worked well at shallow depths. The plastic tubes are connected to the steel cages with plastic zip ties which can be problematic in terms of sliding and proximity to the reinforcement bars.

According to the manufacturer, the tubes have a collapse pressure (**NOTE:** not water tightness rating) of up to 50bar (@20deg Celsius), but more commonly 30bar at standard sonic tube size.



*Figure 35: Durvinil sonic logging tubes with screw joint*

#### 4.3.3 Thick wall steel pipe

Thick wall steel pipes can be used with push fit connections but are commonly used with screw fittings (Figure 36) or union couplers (Figure 39). The pipes can be supplied pressure rated for base grouting and with wall thickness of 4-9mm. Due to the thicker wall thickness, the weight of the tubes increases and makes it difficult to handle on site, especially once the cage is vertical. Robust steel end caps can be provided and the tubes ends can be re threaded once cut to length.

The tubes are very suitable for welding and a tube restraint system can be easily accommodated. Steel end caps are used to terminate the tubes, Figure 37.

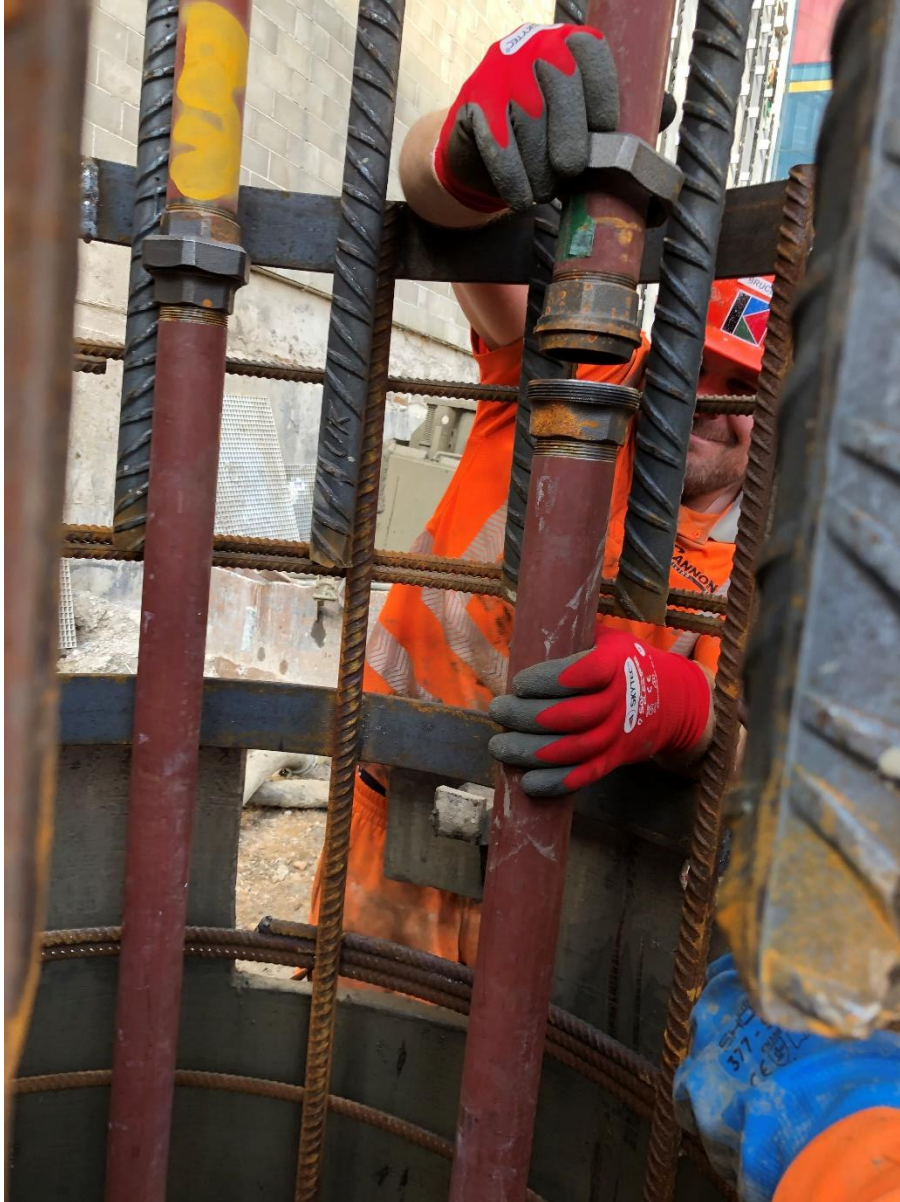

*Figure 36: Screw fit sockets*



*Figure 37: End Caps*





*Figure 38: Operative trying to align and connect sonic tube using union coupler*



Figure 39: Union couplers connected within cage

#### 4.3.4 Square inclinometer tubing

Apart from the circular cross-section pipes, square pipes are also used. These pipes work principally similarly to the thick walled steel pipes described in Section 4.3.3.

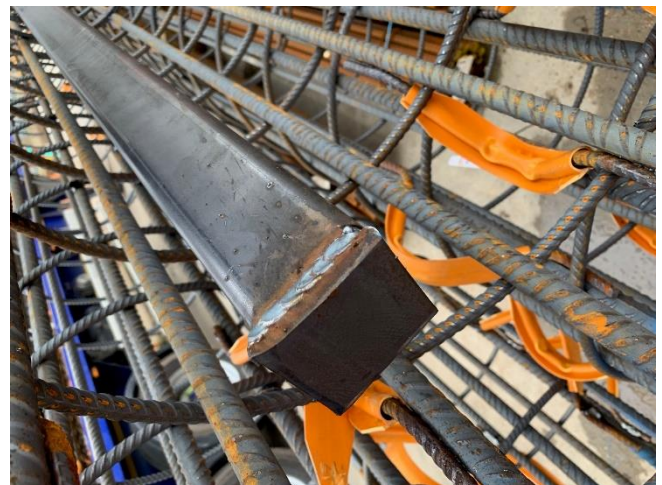

Figure 40: Square inclinometer pipe (left side – view from the top, right hand side – bottom end)

#### 4.4 Couplers

Reservation tubes are supplied in standard lengths and have to be cut to the size actually required which is governed by the pile and individual cage length. If the joint occurs within a cage section (Figure 41), the splice is usually performed by the cage manufacturer and does not create any problems on site.



*Figure 41: Joint detail for thick wall steel tube within one cage section (done by cage manufacturer)*

The connection of the various cage sections and thus tube sections is performed on site. Not only does this connection create potential problems from a quality point of view but it also imposed health and safety risks due to manual handling and potential entrapment issues.

Work is being undertaken to find and develop 'quick fit' or 'hands off' couplers for reservation tubes to minimise the risks to operatives and reduce the risk of leakage. Some of the traditional systems have already been introduced within the section on reservation tubes. For ease of reference, all known types are listed again below.

# FEDERATION OF PILING SPECIALISTS

1. Push fit (traditional)
2. Union couplers (traditional)
3. Srew fit sockets (traditional)
4. Teekay couplers (new)
5. Supersonic (new)

## 4.4.1 Push fit coupler

Need some help here please!



Figure 42: Push fit with a bolted restraint

#### 4.4.2 Union coupler

Union couplers have traditionally been used within the piling industry and are normally water tight when installed correctly. The difficulty on site however arises to align the reservation tubes in such a way that the union coupler fits effortlessly over the thread of the other pipe. Any cross threading will increase the risk of grout ingress into the pipe.



Figure 43: Union couplers

#### 4.4.3 Teekay coupler

Teekay couplers can be used on various diameter (or square) reservation tubes. As they were originally manufactured for the water industry, these coupling come with high pressure ratings (16bar). Incorporating grip rings at each end of the fitting, the Teekay Axilock offers high levels of security against water ingress by locking the pipes together under pressure. Each coupling is 100% rubber-lined, ensuring that high levels of corrosion resistance are maintained throughout the life of the coupling.

## FEDERATION OF PILING SPECIALISTS

The coupler has to be installed on site and tightened using Allan keys. Whilst long reach tools can be used to do this, the need for hands within the cage is not fully eliminated.

The high level of water tightness even when the tubes are not perfectly aligned means that the joint is unlikely to permit grout ingress into the tube during concreting due to it's double seal system (each side).



Figure 44: Teekay coupler (brochure)

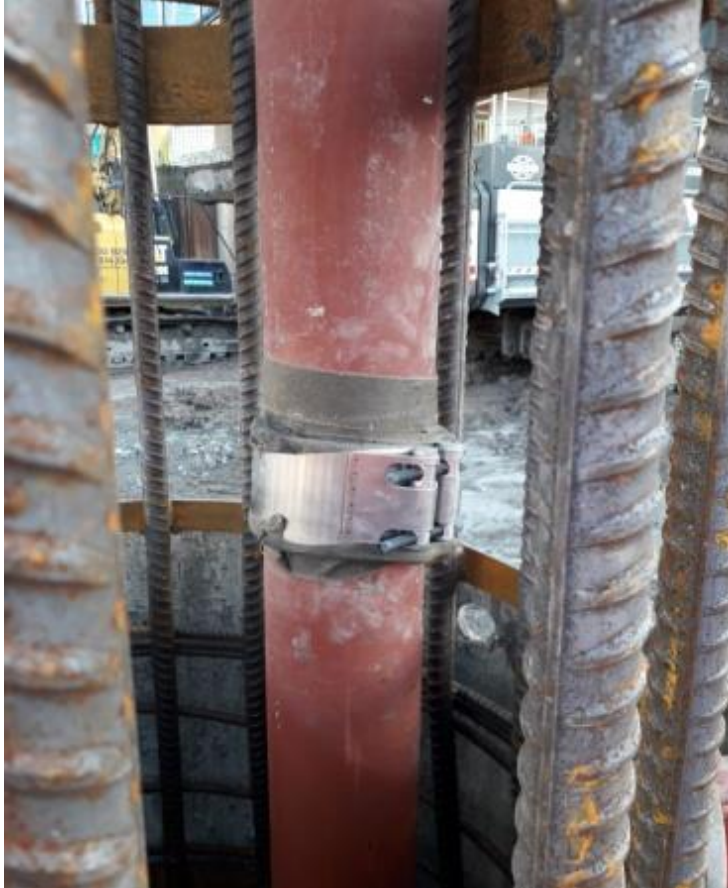

*Figure 45: Teekay coupler connection for sonic tube inside cage*

#### 4.4.4 Supersonic connectors

SUPERSONIC® connectors are used at cage splices to join the tubes, which act as void formers in both cross-hole, sonic-logging (CHSL) and inclinometer reservation (IRT) operations. Each connector has an internally threaded end for fitting to an externally threaded tube (prefab yard). The open ends of the connectors, each of which contains sealing 'O' rings, allow the plain tube ends from the cage above to be pushed in, thereby forming a grout-tight joint.

This is a rapid activity which reduces the need to insert tools, separate fasteners or operators' hands inside the cages. If necessary, the process can be reversed by detaching the rebar splicing system and simply pulling the cages apart on the service crane. This should not damage the seals which can be re-used when the splicing cycle is repeated.

Hydrostatic testing has demonstrated SUPERSONIC's ability to withstand external pressures in excess of 28 Atmospheres; equivalent to a 'head' of 123m of wet concrete.



*Figure 46: Supersonic connector*