

# GUIDANCE FOR TRANSPORTING NITRIC ACID IN TANKS



1998 Edition  
Issue 2014





# GUIDANCE FOR TRANSPORTING NITRIC ACID IN TANKS

## Contents

<b>1.</b>	<b>INTRODUCTION</b>	<b>4</b>
<b>2.</b>	<b>PROPERTIES AND CLASSIFICATION OF NITRIC ACID</b>	<b>5</b>
	2.1 General	5
	2.2 Chemical properties	5
	2.2.1 Acidic properties	5
	2.2.2 Oxidizing properties	5
	2.3 Physical properties	6
	2.4 Hazards and classification of nitric acid	7
<b>3.</b>	<b>DESIGN AND CONSTRUCTION OF TRANSPORT EQUIPMENT</b>	<b>10</b>
	3.1 Design and construction of railway tank wagons	10
	3.2 Design and construction of road tankers	12
	3.2.1 Bottom openings	12
	3.2.2 Materials	12
	3.2.3 Pumps	13
	3.3 Design and construction of tank containers	13
	3.4 Design and construction of inland waterway tank vessels	13
<b>4.</b>	<b>SAFETY AUDIT OF BULK HAULAGE CONTRACTORS AND BULK TANK OPERATORS</b>	<b>14</b>
	4.1 Suitability of the haulage contractor: Assessment and monitoring	14
	4.2 Safety audit of the haulage contractor	14
<b>5.</b>	<b>PRODUCT TRAINING FOR DRIVERS OF ROAD TANKERS AND TANK CONTAINER VEHICLES AND FOR THE SHIPOWNER'S PERSONNEL</b>	<b>15</b>
	5.1 General training requirements for road tanker drivers	15
	5.2 Specific requirements for nitric acid road tanker drivers	15
	5.3 Driver criteria for transporting nitric acid	16
	5.4 Requirements for shipowner's personnel on inland waterways	16
<b>6.</b>	<b>PROTECTIVE CLOTHING AND PERSONAL SAFETY EQUIPMENT</b>	<b>17</b>
<b>7.</b>	<b>LOADING AND UNLOADING OPERATIONS</b>	<b>18</b>
	7.1 Requirements for loading and unloading	18
	7.1.1 Equipment for the loading and unloading stations	18
	7.1.2 Working platform	18
	7.1.3 Filling arm	18

7.1.4	Loading area	18
7.2	Regulations for filling tanks	19
7.2.1	Checklists	19
7.2.2	Suitability of the tanks	19
7.2.4	Tightness of the tanks	24
7.2.5	Marking and labelling tanks	27
7.2.6	Further duties when filling tanks	27
7.3	Restriction of transport period for nitric acid above 99%	27
<b>8.</b>	<b>TRANSPORTING NITRIC ACID ON ROADS</b>	<b>30</b>
8.1	Responsibilities of the haulage contractor	30
8.2	Transport duration of nitric acid with a concentration above 99%	30
8.3	Safe parking of the vehicle	31
8.4	Bad weather conditions	31
8.5	Delays or accidents	31
<b>9.</b>	<b>TRANSPORTING NITRIC ACID BY RAIL</b>	<b>32</b>
9.1	Responsibilities of the railway administrations	32
9.2	Transport duration for nitric acid with a concentration above 99%	32
9.3	Confirmation of receipt by the customer for nitric acid with a concentration above 99%	32
9.4	Intervention in emergencies	33
9.5	Combined transport	33
<b>10.</b>	<b>TRANSPORTING NITRIC ACID ON INLAND WATERWAYS</b>	<b>34</b>
10.1	Responsibilities in the event of emergencies in transit	34
10.2	Intervention in emergencies	34
10.3	Protective clothing and safety equipment for the ship's crew	34
<b>11.</b>	<b>UNLOADING OPERATIONS</b>	<b>35</b>
11.1	Requirements for loading and unloading	35
11.2	Checklists	35
11.3	Inspections before emptying tanks	35
11.4	Maximum and minimum filling levels	35
11.5	Tightness of emptied tanks	36
11.6	Marking and labelling of empty tanks	36
11.7	Further duties when emptying tanks	36
<b>12.</b>	<b>SYSTEMS OF RECIPROCAL ASSISTANCE IN THE EVENT OF EMERGENCIES IN TRANSIT</b>	<b>37</b>

<b>ANNEXES</b>	<b>38</b>
<b>ANNEX 1</b>	<b>39</b>
<b>ANNEX 2</b>	<b>43</b>
<b>ANNEX 3</b>	<b>44</b>
<b>ANNEX 4</b>	<b>48</b>
<b>ANNEX 5</b>	<b>50</b>
<b>ANNEX 6</b>	<b>52</b>
<b>ANNEX 7</b>	<b>53</b>
<b>ANNEX 8</b>	<b>61</b>
<b>LIST OF ABBREVIATIONS</b>	<b>62</b>

1998 Edition

Issue 2014

© Fertilizers Europe 2014

**DISCLAIMER:**

This document has been produced for the benefit of the members of Fertilizers Europe. The information and guidance provided in this document is given in good faith. Fertilizers Europe, its members, consultants and staff accept no liability for any loss or damage arising from the use of this guidance. As regulations are up-dated from time to time, readers are advised to consult the up-to-date information.

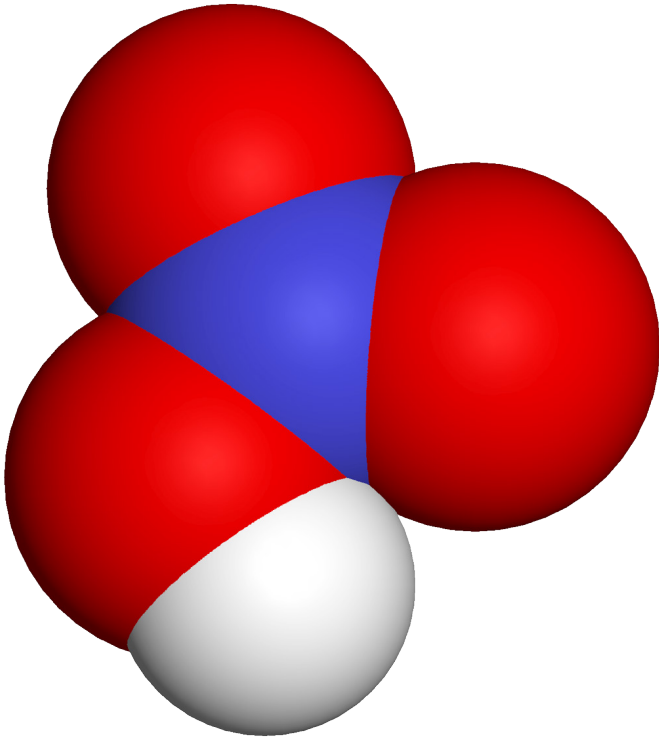

## 1. INTRODUCTION

This guidance for the transport of nitric acid have been drawn up by Fertilizers Europe, a sector group of CEFIC, with the help of expertise from members in order to ensure high safety standards in operations involving nitric acid transport. The guidance deal exclusively with the transport of nitric acid in tanks within Europe and do not deal with the transport of packaged product in small parcels or containers, or with transport on the high seas. However, it should be borne in mind that even though only transport is considered, nitric acid is subject to other European regulations amongst which are those concerning occupational health and safety and the packaging and labelling of dangerous substances.

Although nitric acid is classified as “dangerous” because of its particular chemical properties, it can be transported and handled safely provided the appropriate precautions are taken.

The transport of nitric acid is subject to stringent national and international rules which must be complied with by all those involved. This guidance go beyond the strict application of the existing rules and all those involved in the transport of nitric acid are recommended to adopt them. However, every user of this guidance has the responsibility to evaluate and apply them, giving due regard to all the specific circumstances in his particular situation. No part of this guidance should be applied or interpreted in such a way that it clashes with existing national and/or international laws. In all cases, legal regulations must always prevail over any part of this guidance.

## 2. PROPERTIES AND CLASSIFICATION OF NITRIC ACID

### 2.1 General

Nitric acid (CAS No 7697-37-2) is a chemical of major industrial importance. It is a very strong acid, a powerful oxidizing agent and has the ability to nitrate organic materials, thus making it essential for the production of numerous chemicals. Its main use however remains the production of ammonium nitrate in the fertilizer industry.

For the sake of simplicity, regulatory classification categories relate to the physical characteristics of the product but the requirements also take account of all the physical, chemical and toxicological properties of the product.

### 2.2 Chemical properties

Nitric acid is a strong, monobasic acid and a powerful oxidizing agent which also nitrates many organic compounds.

#### 2.2.1 Acidic properties

Being a typical acid, it reacts with alkalis, basic oxides and carbonates to form salts, the most important of which is ammonium nitrate. Due to its oxidizing nature, nitric acid does not (with some exceptions) liberate hydrogen on reaction with metals and the resulting salts are usually in the higher oxidized state. For this reason, heavy corrosion can be expected and should be guarded against by the appropriate use of corrosion resistant metals or alloys (see section 3).

Nitric acid is considered to be a strong acid since in dilute solutions it is practically totally ionised:



while as a base, nitric acid is extremely weak.

#### 2.2.2 Oxidizing properties

Being a powerful oxidizing agent (electron acceptor), nitric acid reacts violently with many organic materials and the reactions may be explosive. Any of the following reactions may occur depending on the acid concentration, temperature and the reducing agent involved:



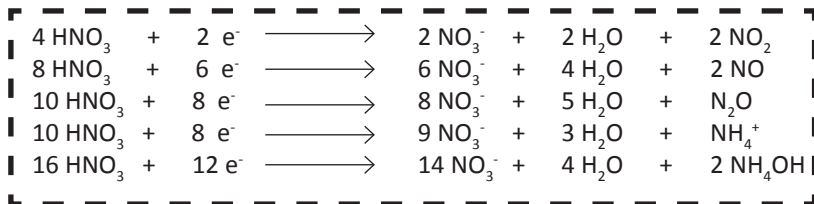

As a general rule, oxidizing reactions occur primarily with the concentrated acid, favouring the formation of nitrogen dioxide (NO<sub>2</sub>). The acidic properties tend to dominate with dilute acid, coupled with the preferential formation of nitrogen oxide (NO). However, the oxidative reaction in relation to other substances appears only with those having an oxidation potential below +0.96V.

Reaction takes place with all metals except the precious metal series and certain alloys. Although chromium, iron and aluminium readily dissolve in dilute nitric acid, the concentrated acid forms a metal oxide layer that protects (passivates) the metal from further oxidation. In general, reaction with metals from the electrochemical series below hydrogen tends to yield nitrogen dioxide and nitrogen oxide whereas those above hydrogen produce nitrogen, ammonia, hydroxylamine or nitrogen oxide.

Reaction with non-metallic elements, with the exception of nitrogen, oxygen, chlorine and bromine, usually oxidizes them to their highest oxidation states as acids.

## 2.3 Physical properties

Pure anhydrous nitric acid (100%) is a colourless liquid with a density of 1522 kg/m<sup>3</sup> which solidifies at -41.6°C to form white crystals and boils at 84.1°C. When boiling in light, even at room temperature, there is a partial decomposition with the formation of nitrogen dioxide following the reaction:



which means that anhydrous nitric acid should be stored below 0°C to avoid decomposition. The nitrogen dioxide remains dissolved in the nitric acid colouring it yellow, or red at higher temperatures. While the pure acid tends to give off white fumes when exposed to air, acid with dissolved nitrogen dioxide gives off reddish-brown vapours, leading to the common name "red fuming acid".

Nitric acid is miscible with water in all proportions and distillation gives an azeotrope with a concentration of 69.2% HNO<sub>3</sub> and a boiling temperature of 121.9°C at atmospheric pressure. Two solid hydrates are known; the monohydrate (HNO<sub>3</sub>·H<sub>2</sub>O)

and the trihydrate ( $\text{HNO}_3 \cdot 3\text{H}_2\text{O}$ ), (see also Annex 1).

Nitrogen oxides are soluble in nitric acid and this property influences more or less, all the physical characteristics depending on the concentration of the oxides. These mainly include the vapour pressure above the liquid and the boiling temperature, as well as the colour mentioned above.

Nitric acid is subject to thermal or light decomposition with increasing concentration and this may give rise to some non-negligible variations in the vapour pressure above the liquid because the nitrogen oxides produced dissolve partly or completely in the acid.

There is no clear definition of 'red fuming nitric acid' other than that given in 'Sax's Dangerous Properties of Industrial Materials'\* , where the product is said to contain more than 17%  $\text{NO}_2$  with a density of more than  $1480 \text{ kg/m}^3$ .

## 2.4 Hazards and classification of nitric acid

The table I summarises the transport classification, EU product classification, the behaviour of the different products in various circumstances and the health hazards.

The indications in the table are a summary and must be taken as initial indications which must be enhanced by the careful consideration of the relevant literature and regulatory texts. These indications are intended only as a broad framework and do not absolve the user from the obligation to explore every aspect in order to comply fully with all safety, health and environmental requirements. In addition, even though harmonisation has taken place in the European Union regarding transport, this harmonisation is not yet total and individual national regulations may still retain some requirements which must be followed at national level.

**TABLE I: HAZARDS AND CLASSIFICATION OF NITRIC ACID**

NITRIC ACID	Concentration < 70%	Concentration > 70%	Red Fuming
Behaviour in case of release and mixture with air	<ul style="list-style-type: none"> <li>Corrosive</li> <li>Non combustible</li> <li>May cause fogging</li> <li>Oxidizer</li> <li>May cause fire on contact with combustible substances</li> </ul>	<ul style="list-style-type: none"> <li>Corrosive</li> <li>Non-combustible</li> <li>May cause fogging</li> <li>Strong oxidizer</li> <li>May cause fire on contact with combustible substances</li> </ul>	<ul style="list-style-type: none"> <li>Very corrosive</li> <li>Non-combustible</li> <li>Emits highly toxic vapours when exposed to air</li> <li>Very strong oxidizer releases oxygen</li> <li>Contact with combustible substances leads to immediate ignition</li> </ul>
Behaviour in case of release and mixture with water	<ul style="list-style-type: none"> <li>Dissolves fully in water with evolution of heat</li> <li>forms corrosive mixtures</li> </ul>	<ul style="list-style-type: none"> <li>Dissolves fully in water with evolution of heat</li> <li>forms corrosive mixtures</li> </ul>	<ul style="list-style-type: none"> <li>Dissolves fully in water with evolution of heat</li> <li>forms corrosive mixtures</li> </ul>
Health Hazard	<ul style="list-style-type: none"> <li>Skin contact leads to severe burns</li> <li>Vapours can cause severe acid burns to eyes, respiratory tract and lungs</li> <li>Delayed pulmonary oedema can be expected after vapour inhalation</li> </ul>	<ul style="list-style-type: none"> <li>Skin contact leads to severe burns</li> <li>Vapours can cause severe acid burns to eyes, respiratory tract and lungs</li> <li>Delayed pulmonary oedema can be expected after vapour inhalation</li> </ul>	<ul style="list-style-type: none"> <li>Skin contact leads to severe burns</li> <li>Vapours can cause severe acid burns to eyes, respiratory tract and lungs</li> <li>Delayed pulmonary oedema should be expected after vapour inhalation</li> </ul>
Transport classification IMDG	<ul style="list-style-type: none"> <li>UN 2031</li> <li>Label Class 8</li> <li>Packaging group II and specific requirements</li> <li>Stowage category D</li> <li>Segregation as for class 5.1 but "separated from" classes 4.1, 5.1 and 7 if concentration &gt; 50% acid</li> </ul>	<ul style="list-style-type: none"> <li>UN 2031</li> <li>Label Class 8</li> <li>Packaging group I and specific requirements</li> <li>Stowage category D</li> <li>Segregation as for class 5.1 but "separated from" classes 4.1, 5.1 and 7</li> </ul>	<ul style="list-style-type: none"> <li>UN 2032</li> <li>Label Class 8</li> <li>Subsidiary risk labels 5.1 and 6.1</li> <li>Packaging group I and specific requirements</li> <li>Stowage category D</li> <li>Segregation as for class 5.1 but "separated from" classes 4.1, 5.1 and 7</li> </ul>

NITRIC ACID	Concentration < 70%	Concentration > 70%	Red Fuming
RID (Rail)	<ul style="list-style-type: none"> <li>• Marginal 801</li> <li>• Identification n° 2031</li> <li>• Class/let/group 8,2b)</li> <li>• Label 8</li> <li>• DI n° 80</li> </ul>	<ul style="list-style-type: none"> <li>• Marginal 801</li> <li>• Identification n° 2031</li> <li>• Class/let/group 8,2a)1</li> <li>• Label 8</li> <li>• DI n° 88</li> </ul>	<ul style="list-style-type: none"> <li>• Marginal 801</li> <li>• Identification n° 2032</li> <li>• Class/let/group 8,2a)2</li> <li>• Label 8+05+6.1</li> <li>• DI n° 856</li> </ul>
ADR (Road)	<ul style="list-style-type: none"> <li>• Marginal 2801</li> <li>• Identification n° 2031</li> <li>• Class/let/group 8,2b)</li> <li>• Label 8</li> <li>• DI n° 80</li> </ul>	<ul style="list-style-type: none"> <li>• Marginal 2801</li> <li>• Identification n° 2031</li> <li>• Class/let/group 8,2a)1</li> <li>• Label 8</li> <li>• DI n° 88</li> </ul>	<ul style="list-style-type: none"> <li>• Marginal 2801</li> <li>• Identification n° 2032</li> <li>• Class/let/group 8,2a)2</li> <li>• Label 8+05+6.1</li> <li>• DI n° 856</li> </ul>
Dangerous substances Directive 67/548/EEC	<ul style="list-style-type: none"> <li>• Label "Nitric acid X%" for <math>20 \leq X \leq 70\%</math></li> <li>• Symbol C</li> <li>• R sentences: 8-35</li> <li>• S sentences: 2-23-26-27</li> </ul>	<ul style="list-style-type: none"> <li>• Label "Nitric acid X%" for <math>X &gt; 70\%</math></li> <li>• Symbols O + C</li> <li>• R sentences: 8-35</li> <li>• S sentences: 23-26-36</li> </ul>	<ul style="list-style-type: none"> <li>• Label "Nitric acid X%"</li> <li>• Symbols O + C</li> <li>• R sentences: 8-35</li> <li>• S sentences: 23-26-36</li> </ul>

### 3. DESIGN AND CONSTRUCTION OF TRANSPORT EQUIPMENT

#### 3.1 Design and construction of railway tank wagons

Railway tank wagons for transporting nitric acid must meet the requirements of the following regulations with regard to their design and construction:

- Any national provisions or the regulations of the respective railway company for national transportation.
- Any international provisions, such as the International Regulations for the conveyance of Dangerous Goods by Rail (RID) for international transportation.

In addition, railway tank wagons for nitric acid should not have any openings or valves below the liquid level. A special risk assessment must be carried out if bottom valves are used.

The wall thickness of the tank must meet the requirements of the generally applicable rules for rail transport containers made of special steel or aluminium, in accordance with Annex XI of RID.

Railway tank wagons which are emptied from the top have filling and emptying equipment at the tank crown. They have no further connections located elsewhere in the outer surface, in the base or in the liquid phase of the filled tank. The filling and emptying device at the top includes the rising pipe (8), the pressure nozzle (10) and the filling nozzle (12), (see Figures 1 and 2)

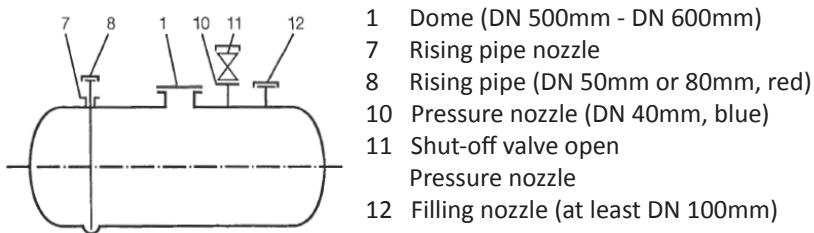

Fig.1 Diagram of a typical tank wagon emptied at the top



*Fig. 2 Tank wagon fittings at the top (red rising pipe, blue pressure nozzle). In this example the rising pipe is without a shut-off valve*

### **Rising pipe (8)**

The rising pipe, which is usually red, is used for emptying and is closed with a blind lid. A shut-off valve may also be fitted. The nominal bore of the rising pipe may be 50 mm or 80 mm. The rising pipe nozzle has a nominal bore of 100 mm or 125 mm.

**Warning! Never open the rising pipe first!**

### **Pressure nozzle (10)**

The pressure nozzle, which is usually blue, is used to apply compressed air to the tank for pressure relief during the leak detection test and for general aeration and venting of the tank. The nominal bore of the pressure nozzle should be at least 40 mm. The pressure nozzle must be fitted with a shut-off valve.

### **Filling nozzle (12)**

The tank wagon is generally loaded using the filling nozzle, which is normally grey. The nominal bore should be at least 100 mm. The filling nozzle must be able to be closed with a blind lid and may additionally be fitted with a shut-off valve.

## 3.2 Design and construction of road tankers

Road tankers for the transport of nitric acid must meet the requirements of the following regulations with regard to their design and construction:

- Any national regulations for national transportation
- Any international regulations such as the European Agreement on the international conveyance of dangerous goods by road (ADR) and/or the transport provisions for conveying dangerous goods by sea (IMDG) etc., for international transportation.

### 3.2.1 Bottom openings

Road tankers for transporting nitric acid with an acid content below 70% may have openings and valves below the level of the liquid. In this case, the haulier must demonstrate, prior to loading, that the tank material, the fittings and the seals meet the requirements for nitric acid duty (See Annex 2).

Road tankers with no openings and valves below the liquid level are preferred for transporting nitric acid with an acid content of 70% or more. However, there may be good reasons for using tanks with openings and valves below the liquid. For example, the consignee may use gravity for unloading. A special risk assessment must be carried out when a tank with openings and valves below the liquid level is used. In addition the following points must be followed:

- The haulier must check the maintenance of the valves on a regular basis and inform the producer of each check.
- The producer must check all closing devices for tightness. This applies in particular to the bottom and discharge valves.

### 3.2.2 Materials

Tanks to contain nitric acid below 70% concentration must be made of special steel which is resistant to nitric acid. Suitable materials include:

V2A     DIN/EN 1.4306 ≡ UNS S 30403 (AISI 304L),  
           DIN/EN 1.4541 ≡ UNS S 32100 (AISI 321)  
           DIN/EN 1.4550 ≡ UNS S 34700 (AISI 347)  
           DIN/EN 1.4465 ≡ UNS S 31050.

Antinite DIN/EN 1.4361 ≡ UNS S 30601 (recommended for concentrations above 85%).

**Warning! Materials DIN/EN 1.4301 or 1.4401 = UNS S 30400 or S 31600 (AISI 304 or 316) are not suitable for nitric acid tanks and should be avoided.**

All hoses carried must be made from a material which is resistant to nitric acid. Suitable materials include polytetrafluoroethylene (PTFE) and polypropylene (PP), subject to the application (e.g. acid strength, temperature, required service file). Hose

connections must also be compatible with nitric acid (e.g. stainless steels listed above).

Each road tanker must have written confirmation from the haulage company showing that the correct materials have been used for the tank and appendages, hoses, gaskets and bolts.

### **3.2.3 Pumps**

Pumps can be used for both loading and unloading nitric acid for transport. Standard chemical pumps made of the usual materials; (for example DIN/EN 1.4408  $\equiv$  UNS I 92900 (ASTM A 296 grade C78M) may be used for nitric acid with a concentration up to 70%. Magnetically coupled side-channel pumps made from Antinite, material DIN/EN 1.4361  $\equiv$  UNS S 30601 or compressed-air diaphragm pumps made of a PTFE/TFM composite are recommended for highly concentrated nitric acids above 70%.

## **3.3 Design and construction of tank containers**

Isotanks may be used for transporting nitric acid by road, rail, sea or inland waterways. They must meet the requirements of the appropriate national or international provisions for design and construction, depending on the specific type of transport to be used. Material compatibility must be ensured by means of a suitable coating. The suitability of the tank container must be verified by comparison with the certificates issued by the responsible authority, or be confirmed by the owner prior to loading.

In addition to the requirements above, tank containers without openings below the liquid level are recommended for nitric acid with a concentration above 70%.

## **3.4 Design and construction of inland waterway tank vessels**

Inland waterway tank vessels for transporting nitric acid on the Rhine or on German waterways are subject to the requirements and building regulations of the ADNR. In addition, the regulations of the Rhine Navigation Investigation Authority and the Rhine Navigation Police Authority must be complied with.

Waterway tank vessels conveying nitric acid must have been issued with an individual approval certificate. The approval certificate must confirm that the vessel has been examined and the construction and equipment are suitable for transporting nitric acid. The approval certificate is issued by the responsible authority of a Riparian State of the Rhine or of Belgium, based on an examination carried out by an expert nominated by the said authority. The responsible authority may waive a vessel examination if it is clear from the certificate of a recognised classification company that the construction and equipment comply with the regulations mentioned above.



## 4. SAFETY AUDIT OF BULK HAULAGE CONTRACTORS AND BULK TANK OPERATORS

### 4.1 Suitability of the haulage contractor: Assessment and monitoring

All nitric acid manufacturers use the services of haulage contractors to transport their products. It is extremely important for the chemical company to carry out checks to ensure that the appointed haulage company is competent and operates in accordance with relevant regulations and safety standards. Contractual agreements with haulage companies should stipulate explicitly that no transport is to be passed on to subcontractors without the prior written consent of the consignor.

In the case of combined types of transport, the last haulage company is not considered to be a subcontractor. The second company should likewise be audited by the nitric acid manufacturer, as described in the remainder of this section. The first haulage company should not change the second haulage company without the written consent of the consignor.

The road haulage contractor transporting nitric acid with a concentration above 70% should have the ISO 9000 certificate.

### 4.2 Safety audit of the haulage contractor

All consignors who consign a load of nitric acid should carry out safety audits of the bulk transport and bulk tank operations of their appointed haulage companies at least every two years. Every consignor can thus be assured of the suitability of the appointed haulage company and can ensure that the appropriate safety standards are complied with.

The safety audit does not replace or reduce the basic responsibility of the haulage company to ensure that their equipment complies with the appropriate safety regulations and standards and that it is kept in a properly maintained condition.

## 5. PRODUCT TRAINING FOR DRIVERS OF ROAD TANKERS AND TANK CONTAINER VEHICLES AND FOR THE SHIPOWNER'S PERSONNEL

### 5.1 General training requirements for road tanker drivers

National and international regulations on transporting dangerous goods (for example ADR) stipulate that all drivers of road tankers or transport units transporting dangerous goods in permanently connected tanks, or attached tanks with a total volume of more than 3000 litres, must prove that they have taken part in a special training course for the transportation of dangerous goods in tanks. The ADR certificate is proof of participation in such a special training course and of having passed the examination set by the competent authority.

### 5.2 Specific requirements for nitric acid road tanker drivers

The dangerous properties of nitric acid are the corrosive hazards, the oxidizing effect and the release of hazardous fumes. The consignor should train the vehicle drivers employed on the hazards associated with nitric acid. Drivers of vehicles carrying dangerous goods in fixed or demountable tanks, with a total capacity exceeding 1000 litres and drivers of vehicles carrying dangerous goods in tank-containers with an individual capacity exceeding 3000 litres on a transport unit, shall hold a certificate issued by the competent authority.

The vehicle drivers must be familiar with the particular hazards associated with nitric acid and, from this knowledge, understand the recommended relief and safety measures to be taken in an emergency. Annex 3 includes recommendations on the content and scope of the training courses for vehicle drivers and how they should be carried out.

Drivers of vehicles carrying dangerous goods in fixed or demountable tanks, exceeding 1000 litres and drivers of vehicles carrying dangerous goods in tank-containers with an individual capacity exceeding 3000 litres on a transport unit, shall hold a certificate issued by the competent authority. The purchaser of a consignment of nitric acid transported by road tanker or tank container vehicle must require that the haulier use only vehicle drivers who have received special training for the transportation of nitric acid. The haulier must ensure that such vehicle drivers repeat the training course every two years and that they carry their training certificate with them when transporting nitric acid.

### **5.3 Driver criteria for transporting nitric acid**

It is the duty of the nitric acid consignor to check the suitability of the vehicle driver. Vehicle drivers who do not have a valid ADR certificate or valid proof of participation in special training for the transportation of nitric acid must be rejected.

The nitric acid consignors listed in Annex 7 will recognise the certificates of special training issued by the other consignors on a reciprocal basis.

### **5.4 Requirements for shipowner's personnel on inland waterways**

At least one qualified (e.g. ADNR qualified) person must be on board. Any personnel who are involved in transporting nitric acid for the first time should receive instruction from experienced shipowner's personnel or by the consignor, prior to loading.

## 6. PROTECTIVE CLOTHING AND PERSONAL SAFETY EQUIPMENT

Technical and organisational methods should be taken which limit the direct handling of acid to that which is absolutely essential in order to protect employees handling nitric acid or highly concentrated nitric acid.

For example, product releases must be anticipated when transferring nitric acid (by ship, tank wagon or road tanker) or during work such as emptying or flushing hoses repair and reconstruction work, operating fittings and starting pumps.

The type and scope of protective clothing and personal safety equipment must be stipulated to correspond with the risk of possible release and depending on the concentration. Possible items of safety equipment are:

- full-body coverall (chemical coverall) or chemical protective suit
- sturdy shoes or acid-resistant boots
- closed protective glasses or visor with full mask
- helmet or helmet with neck guard
- acid-resistant protective gloves

The specific protective clothing and equipment to be used must be stipulated in substance-related and workplace-related company rules. For example, recommendations may be found in the safety data sheets.

Vehicle drivers who transport nitric acid by road must carry the protective equipment which is specified in the TREM card for road traffic, readily available in the vehicle. This also applies to the transport of empty tanks which last carried nitric acid and which have not yet been cleaned.

## 7. LOADING AND UNLOADING OPERATIONS

### 7.1 Requirements for loading and unloading

#### 7.1.1 Equipment for the loading and unloading stations

Take precautions to prevent the movement of the tanker during the loading and unloading operations.

Restrict entry to the loading area to that required to follow the work instructions.

#### 7.1.2 Working platform

The working platform of the loading station should have folding steps and the following equipment should be installed on the working platform:

- the filling arm or arms
- devices for leak detection testing (acid concentration >99%)
- flushing water connection
- drainage lines for residual acid
- tank wagon pressure vent connections
- safety equipment such as eye shower and emergency shower
- emergency switch to stop the loading operation

#### 7.1.3 Filling arm

The filling arm must be made from a suitable material (See Section 4.2.2) and the following equipment must be attached:

- a shut-off valve
- a connection to an extractor or gas displacement line
- a safeguard against overfilling
- a drip collector

#### 7.1.4 Loading area

The loading and unloading areas should be built in such a way that acid from leaks, spillage and overflow is collected and led to a safe place.

## 7.2 Regulations for filling tanks

### 7.2.1 Checklists

Tank loading should always be carried out and documented during the respective operation on the basis of checklists. Examples of checklists are shown in Appendix 4 and Appendix 5. Plant-related aspects should be added to the typical checklist.

The typical obligations in the checklists will be explained in the following sub-sections.

### 7.2.2 Suitability of the tanks *(See Checklist points 1,2, 4 – 7, appendix 4)*

Ensure that:

- The tank has been approved for nitric acid use:

The related approval of the tank for nitric acid use must be checked before a tank may be filled. Local procedures are required to ensure that such an approval exists.

In the case of rail tanks, check the date of the next tank inspection. The inspection date is written on the casing. Do not fill or transport a rail tank if the date of the next inspection has been passed.

Note: Empty tank wagons which have not been cleaned may be transported for the purpose of taking them for inspection, even if the inspection date has been passed.

- The tank is clean:

Tanks may only be filled with dangerous goods if they cannot produce a hazardous reaction with the residual content. Before loading, the cleaning agency should hand over an original cleanliness document stating that the tank has been cleaned using an appropriate method and is free of contaminants. Alternatively, there should be a statement that the previous product was identical and the tank is free of contamination.

- The tank equipment is suitable for nitric acid:

The hose material and the couplings used for unloading must not react with nitric acid (for example, bronze couplings are unsuitable).

- The tank and equipment are undamaged:

Do not use damaged tanks for transporting nitric acid. Check visually before filling to ensure that the tank is free from mechanical damage, such as dents or cracks. Do not fill the tank if any obvious defects are found at the loading point.

The tank equipment may also have defects in addition to mechanical damage to the tank. Pay special attention to the seals during filling. All the seals must be present, suitable and free of damage. Replace any missing, damaged or deficient seals.

Replace any missing items of equipment before transportation. This applies particularly to nuts, bolts and securing pins etc., in the case of tank wagons.

## Sealing materials

### Seals for railway tank wagons

There is a distinction to be made between so-called permanent seals and exchangeable seals.

#### Permanent seals

Permanent seals are used on flange connections which are not used in normal operations, such as those on:

- the dome
- the rising pipe nozzle
- the pressure nozzle below the shut-off valve.

Examples of suitable seals are:

- PTFE ceramic seals such as RIVAL PTFE
- Ceramic seals PA 1 - Profile, 3 mm thick (such as Kempchen factory)
- Seals made from EURO-GYLON Standard 3501 E.

Permanent seals usually remain in place until a leak occurs or an inspection shows the need for renewal.

Permanent seals should only be installed by workshops which are suitably equipped and which have the necessary experience, for example, special workshops for rail vehicles.

## Exchangeable seals

Install exchangeable seals directly on all sealing surfaces which are used in the normal operation of:

- the pressure nozzle
- the rising pipe
- the filling nozzle
- the respective shut-off valve, if present.

PTFE encased seals such as type Y with Klingersil C 8200,2 = 0.7 mm thick, are particularly suitable for tank wagons used for transporting nitric acids >70%. Tank wagons used for <70% nitric acids may be equipped with exchangeable seals made from EURO-GYLON, Gylon blue 3504, Standard 3501E.

Exchangeable seals should be used once only.

## Seals for road tankers

PTFE seals such as Gylon blue 3504 or Teflon are required throughout, particularly for the bottom valve, for the maximum safety during transport.

### 7.2.3 Maximum and minimum filling levels *(See Checklist Points 9 and 11, appendix 4)*

Regulations for dangerous goods stipulate maximum and minimum filling levels for liquids in tanks. These filling levels do not relate to the maximum permitted weight for road transport or the weight limits for specific routes in rail transport. On the contrary they relate to the expansion of the loaded product due to rising temperature. (The maximum permissible weight and the weight limits for the railway routes are checked during weighing).

Minimum filling levels exist only for tanks with a volume greater than 7500L and which have no internal baffles. The minimum filling level is generally 80% at a reference temperature of 15°C. **The minimum filling level does not apply to rail tank wagons.**

The maximum filling depends on:

- the type of tank
- cubic expansion coefficient for nitric acid
- filling temperature
- dangerous goods classification
- the means of transport.



Two reference values must be specified on the tank wagon:

- the container volume in m<sup>3</sup>
- the so-called “C-route”.

The net load defined by the “C-route” may only be used if this will not cause the tank wagon to be over-filled (observe filling levels!).

The maximum permissible filling quantity in tonnes is calculated from the container volume, the filling level and the density of the acid (loading temperature):

Maximum permissible filling quantity =  
filling level (%) x container volume (m<sup>3</sup>) x acid density (te/m<sup>3</sup>)

If this maximum filling quantity is less than the predetermined loading limit of the railway route (generally “C-route”), the tank wagon may only be loaded up to this filling quantity. If the loading limit of the route is lower, the wagon may only be loaded up to the loading limit of the route.

The following table gives the maximum filling level for various nitric acid concentrations and filling temperatures (land transport only).

**TABLE II : MAXIMUM FILLING LEVELS OF NITRIC ACID**

Temp. of HNO <sub>3</sub> during filling [°C]	50% HNO <sub>3</sub> Filling level [%]	60% HNO <sub>3</sub> Filling level [%]	70% HNO <sub>3</sub> Filling level [%]	80% HNO <sub>3</sub> Filling level [%]	99% HNO <sub>3</sub> Filling level [%]
0	89	90	90	89	89
10	90	91	91	90	90
15	91	91	91	91	91
20	91	92	92	91	91
25	92	92	92	92	92
30	92	93	93	92	92
50	95	95	95	95	95

**TABLE IIA : DENSITY OF NITRIC ACID**

	50% HNO <sub>3</sub> [g/cm <sup>3</sup> ]	60% HNO <sub>3</sub> [g/cm <sup>3</sup> ]	70% HNO <sub>3</sub> [g/cm <sup>3</sup> ]	80% HNO <sub>3</sub> [g/cm <sup>3</sup> ]	99% HNO <sub>3</sub> [g/cm <sup>3</sup> ]
Density at 15°C	1.314	1.374	1.419	1.460	1.514
Density at 50°C	1.264	1.328	1.369	1.404	1.457

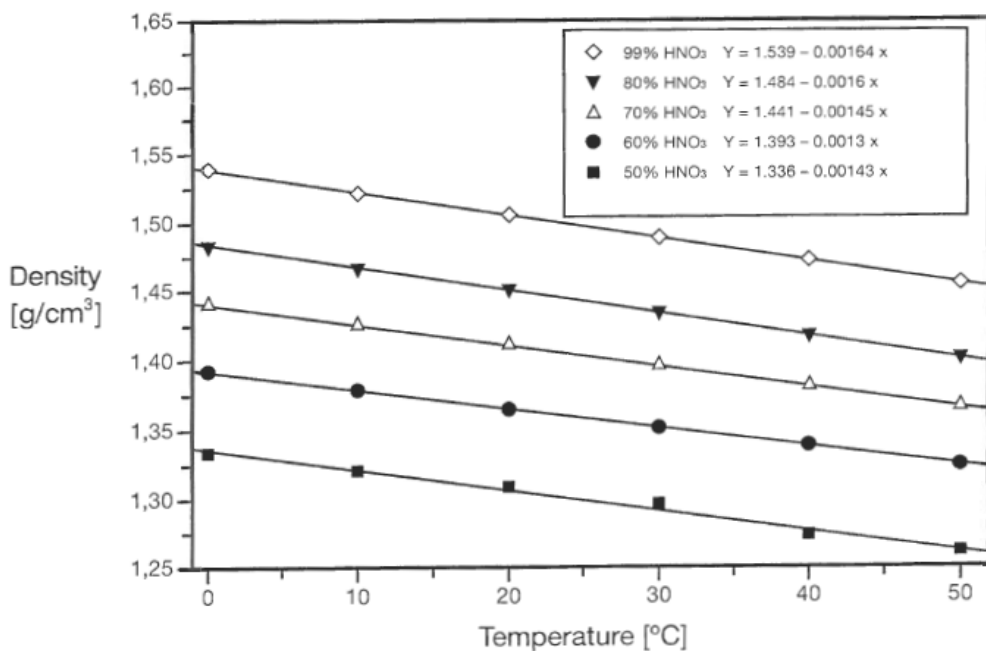

*Fig3 Density of nitric acids of different concentrations*

### 7.2.4 Tightness of the tanks

Close all the valves, openings and shut-off devices which are not needed for the filling operation, properly before filling. Take suitable measures (for example, extraction, gas displacement) during the loading of the tank with consignments of nitric acid to prevent the release of gases and vapours.

Check the tank and especially the rising pipe, for tightness during the filling operation.

Close all closure devices properly after filling so that none of the contents can leak out unnoticed. Close all openings and valves with protective caps and blind flanges wherever present. Replace missing nuts and bolts on all tank wagons, before transportation. Secure hand wheels or hand levers against unintentional opening.

Check all the closure devices including openings and valves not used during filling, for tightness. In particular, visually inspect the rising pipes, bottom and discharge valves for tightness.

Tanks containing nitric acid with a concentration above 99% must be inspected for tightness after filling or before transportation begins. After attaching the blind lids to the nozzles and fittings, apply compressed air at a pressure of at least 0.5 bar and at most 2 bar (preferably 1 bar). The apparatus for this purpose must be fitted with devices which permit the test pressure to be set, held and observed and which prevent the setting of any pressure above the permitted operating pressure (Figure 4).

Hold the test pressure for at least 15 minutes. Check all the flanges and fittings during this time. This can be done using a leak detector spray or ammonia gas (Figure 5). Ammonia gas is particularly suitable because it forms an ammonium nitrate mist which is easily visible with very small quantities of nitric acid vapours, thus detecting even the smallest leaks. Relieve the container to atmospheric pressure after the test. Extract and wash the pressure relief gas. If no leaks are detected, seal the pressure nozzle, after pressure relief and closure of the valve, with a blind lid with an exchangeable seal. If a leak is detected, relieve the container pressure as described, rectify the leak and carry out a second leak detection test.

There are various causes of leaks:

- missing seal
- incorrect seam
- defective seal
- bolts not tightened sufficiently
- damaged sealing surfaces

If the leak cannot be rectified for the reasons given above, empty the tank at the filling site, rinse and remove the cause of the leak.

**Warning! Do not send leaking tanks on transport journeys.**

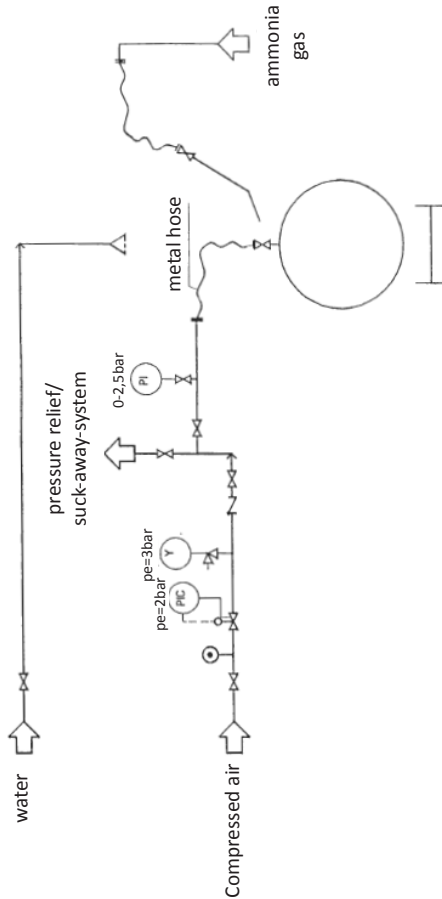

Fig 4 Apparatus for leak detection testing of tank wagons



*Fig 5 Demonstration of detection of a leak using a leak detector spray or ammonia; after pressure relief via the pressure nozzle, the blind lid is attached to the pressure nozzle.*

### **7.2.5 Marking and labelling tanks** *(See Checklist Points 13 to 17, appendix 4)*

Tanks should have outer seals at the discharge and other openings, for reasons of quality assurance. Attach product tags bearing the product name to the discharge openings. Comparison of the product name on the tag with the details given in the loading papers allows works security to check that the correct product has been loaded. In addition, the customer can check that it is the product he ordered before emptying the tank.

The responsibilities for marking transport units of tanks filled with nitric acid are given in Figures 7 and 8. The identification label must be checked by the responsible plant employee if a driver attaches an identification label for which the plant is responsible.

Remove old hazard labels and warning plates which do not refer to the product to be transported, before transportation. Subsequently, attach the proper identification as follows:

- Nitric acid up to 70%: Orange coloured plate 80/2031 Danger label 8 (Figure 7-9)
- Nitric acid above 70%: Orange coloured plate 88/2031 Danger label 8 (Figure 7-10)
- Red fuming nitric acid: Warning plate 856/2032 Hazard label 8 + 05 + 6.1.

### **7.2.6 Further duties when filling tanks** *(Appendix 4, Checklist Points 3 and 18)*

- Park the vehicles (tank wagons, tank containers, tank vehicles etc.) according to regulations and secure them against rolling away. Make tank wagons safe from collision and/or unintentional movement.
- Switch off the vehicle engine unless it is required to operate pumps or other devices for loading the vehicle.
- Ensure the connection elements to filling devices meet the same safety requirements as the means of transport. Ensure that the filling and emptying pipes not located permanently on the tank are empty after filling and during transport.
- Remove any contamination or hazardous residues of the contents adhering to the loaded tanks before transport.

## **7.3 Restriction of transport period for nitric acid above 99%**

The recommended restrictions for transport periods are described in Sections 8.2 and 9.2



Fig 6 Dangerous goods marking and labelling of a tank wagon containing nitric acid Class 8, 2b) RID (nitric acid other than non-red fuming and less than 70%)



Fig 7 Dangerous goods marking of a tank wagon containing nitric acid Class 8, 2a) 1 RID (nitric acid other than non-red fuming and greater than 70%)

Transport unit	Labelling with Danger labels (Size at least 25 * 25 cm)	Marking with orange warning plates	Marking with orange warning plates
Truck with tank containers (one chamber) -alternatively	On both longitudinal sides of the tank containers <sup>1) 2)</sup> On both longitudinal sides of the tank containers <sup>1) 2)</sup>	Front and rear of the truck	On both longitudinal sides of the tank containers Front and rear of the truck
Truck with tank containers (several chambers) -alternatively (if only one dangerous good is loaded)	On both longitudinal sides of each chamber containing a dangerous good <sup>1) 2)</sup> On both longitudinal sides of each chamber containing a dangerous good <sup>1) 2)</sup>	Front and rear of the truck	On both longitudinal sides of each chamber containing a dangerous good Front and rear of the truck
Tank vehicle with one chamber -alternatively -alternatively	On both longitudinal sides and at the rear On both longitudinal sides and at the rear On both longitudinal sides and at the rear	 Front and rear of the vehicle	Front and rear of the vehicle On both longitudinal sides of the tank On both longitudinal sides of the tank as well as front and rear of the vehicle
Tank vehicle with several chambers -alternatively (if only one dangerous good is loaded)	On both longitudinal sides of each chamber containing a dangerous good, all together at the rear On both longitudinal sides of each chamber containing a dangerous good and at the rear	Front and rear of the vehicle	On both longitudinal sides of each chamber containing a dangerous good Front and rear of the vehicle

- 1) For tank containers with a total volume of up to 3000 litres, the danger labels only need to have a side length of 10cm  
2) If the danger labels are not visible from the outside, they must be attached additionally to both longitudinal sides and to the rear of the vehicle 25x25cm

Figure 8 Marking for land transportation: Road (ADR)

Transport unit	Labelling with Danger labels	Marking with orange warning plates
Rail car with tank container (one chamber)	On both longitudinal sides of the tank container (size at least 25 * 25 cm)	On both longitudinal sides of the tank containers
Rail car with tank containers (several chambers)	On both longitudinal sides of each chamber containing a dangerous good (size at least 25 * 25 cm)	On both longitudinal sides of each chamber containing a dangerous good
Tank wagon (one chamber)	On both longitudinal sides of the tank wagon (size at least 15 * 15 cm) <b>NOT IN THE LABEL BOXES!!!</b>	On both longitudinal sides of the tank wagon

Figure 9 Marking for land transportation: Rail (RID)



## 8. TRANSPORTING NITRIC ACID ON ROADS

### 8.1 Responsibilities of the haulage contractor

The haulage contractor is responsible for the safe transportation of nitric acid on roads from the loading point to the delivery (unloading) point. The following aspects must be taken into account:

The haulage company must carefully select the transport route to be adhered to and pass this on to the client if requested. The haulage company is solely responsible for complying with regulations or restrictions with respect to bridges, tunnels and local roads. As is the case for all dangerous chemicals, the route should:

- preferably use freeways or similar multi-lane roads
- avoid densely populated areas wherever possible.

### 8.2 Transport duration of nitric acid with a concentration above 99%

Nitric acid is subject to a certain degree of self-decomposition, depending on the concentration and temperature. The general rule is: the higher the concentration or the temperature, the faster the decomposition rate. During decomposition nitrogen dioxide and dinitrogen tetroxide are formed in addition to water and oxygen and these are absorbed in the nitric acid. This leads to an orange-brown coloration and an increase in the dinitrogen tetroxide concentration. Nitric acid must therefore be transported from the manufacturer to the user within the shortest possible time, particularly in the summer months.

Close scheduling is recommended for the road transport of nitric acid with a concentration of 99% or more to ensure that the transport time from loading (pressurising) to unloading (depressurising) is no longer than 3 days. Further safety precautions must be taken if this cannot be guaranteed.

The customer must depressurise the tank in a safe manner if the tank is not unloaded immediately.

### 8.3 Safe parking of the vehicle

Drivers of vehicles carrying nitric acid must:

- ensure that the vehicle is under constant supervision or is parked in a safe place (secured against rolling), when it is not being driven
- pay special attention to selecting a safe parking area
- use a safe depot or factory premises outside residential areas whenever possible
- preferably park the vehicle on its own in the open air, in an area which is lit at night.

It is strongly recommended that recipients provide safe parking facilities for vehicles which arrive outside normal working hours.

### 8.4 Bad weather conditions

As applies to all dangerous chemicals, if nitric acid is being transported during bad weather (for example, icy roads, snow or poor visibility) the vehicle must stop at the nearest suitable parking area. The vehicle may only continue its journey when the weather has improved. In some European countries, this is obligatory for all hazardous substances.

### 8.5 Delays or accidents

Report all transport delays to the client as soon as possible, whether they are due to bad weather, breakdown or other reasons.

If an accident occurs during transport which means that the vehicle can no longer be driven or which results in a leak, follow the procedure for requesting emergency assistance in accordance with the TREM card. Report the details of the accident to the client without delay (see Annex 4).

## 9. TRANSPORTING NITRIC ACID BY RAIL

### 9.1 Responsibilities of the railway administrations

The railway administrations are responsible for the safe transport of nitric acid by rail from the siding track of the consignor to the siding track of the recipient.

Immediately report delays in transport (for example through disconnection from the train or transport-related intermediate stops) of tank wagons containing nitric acid with a concentration above 99%, lasting more than 24 hours.

### 9.2 Transport duration for nitric acid with a concentration above 99%

Nitric acid is subject to a certain degree of self-decomposition, depending on the concentration and temperature. The general rule is: the higher the concentration or the temperature, the faster the decomposition rate. During decomposition nitrogen dioxide and dinitrogen tetroxide are formed in addition to water and oxygen and they are absorbed in the nitric acid. This leads to an orange-brown coloration and an increase in the dinitrogen tetroxide concentration. Nitric acid must therefore be transported from the manufacturer to the user within the shortest time, particularly in the summer months.

Close scheduling is recommended for the rail transport of nitric acid with a concentration of 99% or more to ensure that the transport time from loading (pressurising) to unloading (depressurising) is no longer than 5 days. Further safety precautions must be taken if this cannot be guaranteed.

The customer must depressurise the tank in a safe manner if the tank is not unloaded immediately.

### 9.3 Confirmation of receipt by the customer for nitric acid with a concentration above 99%

To increase the safety in transit, the transit periods to the customer for tank wagons loaded with nitric acid above 99% concentration must be kept as short as possible. There must be suitable monitoring in order to guarantee this. The following procedure is recommended:

1. The loading company must report all departing tank wagons to the responsible railway department (e.g. freight clearance) immediately by fax.
2. The responsible railway department must request notification of the arrival of the tank wagon at the customer's premises and inform the loading company immediately by fax.
3. If the scheduled transit period has been exceeded, the loading company must immediately request information from the responsible railway department and discover the whereabouts of the tank wagon. In certain circumstances it may be necessary for the loading company to request this information directly from the customer. The responsible railway department must then be informed of the current situation.
4. All the measures listed in 1 - 3 above should be documented using suitable forms containing:
  - tank wagon no.
  - train no.
  - departure date from the loading company
  - recipient (customer)
  - location
  - date received by the customer.

#### **9.4 Intervention in emergencies** *(see Section 12)*

In the event of accidents during transit, the railway administrations should be informed of the contents of this guideline in order to pass on information to the incident teams handling nitric acid. The railway administrations should, in any case, make use of the reciprocal assistance system of the nitric acid consignors.

#### **9.5 Combined transport**

When combined road/rail/road transport is used and the driver or towing vehicle does not accompany the load during the rail transport, pay special attention to ensure that the road vehicle for the final leg of the transport is properly marked with the appropriate warning plates and carries the appropriate TREM card.

## 10. TRANSPORTING NITRIC ACID ON INLAND WATERWAYS

The transport of nitric acid in tank barges is subject to the Regulation on dangerous goods regulations on the river Rhine on Inland Waterways or the ADNRR.

### 10.1 Responsibilities in the event of emergencies in transit

The shipowner and the ship's captain are responsible for the safe transport. The ship's captain must notify the shipowner and the consignor immediately in the event of emergencies in transit which involve an escape of product (see Section 12).

### 10.2 Intervention in emergencies

See Section 12.

### 10.3 Protective clothing and safety equipment for the ship's crew

The ship's personnel assigned to the loading and unloading of highly concentrated nitric acid must wear full acid-resistant clothing. This also applies to the watchman during the hose watch. The remaining ship's personnel must keep their protective clothing outside the hazard area but ready for use in an emergency.

## 11. UNLOADING OPERATIONS

### 11.1 Requirements for loading and unloading

The unloading areas should be built in such a way that acid from leaks, spillage and overflow is collected and led to a safe place.

Restrict entry to the unloading area to that required to follow the work instructions. Take precautions to prevent the movement of the tanker during unloading operations.

**Warning! Never open the rising pipe first!**

### 11.2 Checklists

The emptying of tanks should be documented using checklists. The sample checklists in Annex 4 and 5 may be used after deleting the points which relate exclusively to loading. The sample checklists may need the addition of plant-related points.

The obligations specified in the checklists are described in the following sections.

### 11.3 Inspections before emptying tanks

Before emptying tanks ensure:

- the tank contains the desired product (in particular that it is the correct tank chamber to be emptied).
- emptying takes place using only materials, seals, equipment and protective linings which have no dangerous reactions with nitric acid, produce dangerous products or are substantially weakened by the dangerous products.

There is no need to check the suitability of the tank before emptying. However, it is necessary to check the suitability of the tank wagon again, in accordance with Section 7.2.2, prior to further transport, in the case of partial emptying of a tank chamber.

### 11.4 Maximum and minimum filling levels

The maximum and minimum filling levels do not apply to tanks which are virtually empty. In the case of partial emptying, due regard must be given to the filling levels of tanks stipulated in the Regulation on dangerous goods. The same conditions then apply as for filling (see minimum filling level, Section 7.2.3).

## 11.5 Tightness of emptied tanks

Empty tanks which have not been cleaned must be sealed as tightly as full tanks (see Section 7). The additional leak detection test for tanks containing nitric acid above 99% is no longer required for empty tanks.

Pay particular attention during emptying to:

- preventing the release of dangerous quantities of gases and vapours and taking the necessary action (e.g. gas displacement, extraction).
- closing the shut-off devices located nearest to the product first. This will prevent product from accumulating between the bottom valve and the discharge valve.
- relieving the pressure in the tank after pressurised emptying.
- clearing product in the tank pipes and hoses used for emptying before continuing the transport run.

## 11.6 Marking and labelling of empty tanks

Mark and label all empty tanks which have not been cleaned, in accordance with the provisions for full tanks (see Section 7.2.5).

Remove the danger labels and orange coloured plates from empty tanks which have been cleaned.

## 11.7 Further duties when emptying tanks

Park and secure the vehicles (tank wagons, tank containers, tank vehicles etc.) before emptying, according to regulations. Make tank wagons safe against collision and/or unintentional movement.

Switch off the engine of the vehicle if it is not required for operating pumps or other equipment for emptying the vehicle.

Ensure that connection elements to emptying devices comply with the same safety requirements as the means of transport. Ensure that the filling and emptying pipes not located permanently on the vehicle tank are empty after emptying the tank and during transit.

Remove any contamination or hazardous residues adhering to the outside of the empty tanks before transit.

## 12. SYSTEM OF RECIPROCAL ASSISTANCE IN THE EVENT OF EMERGENCIES IN TRANSIT

ICE (International Chemical Environment) is a cooperative programme between chemical companies to prevent chemical transport accidents and to respond effectively if and when they do occur. It was started in May 1990 by CEFIC (the European Chemical Industry Council).

Within this system the chemical industry offers three levels of assistance:

- Level 1: remote information and general advice by telephone or fax
- Level 2: presence of an expert who will provide advice after having carried out an assessment/inspection
- Level 3: equipment and personnel at the scene of an incident

When a transport incident happens, the Fire Brigade normally tries to contact the supplier of the goods if assistance is required. If this fails ICE offers the Authorities the possibility to contact other companies which have committed themselves to provide assistance for a range of products. In every country of the ICE-System a national centre may facilitate mutual assistance between companies, especially when incidents occur during international movements. Those national centres will look for assistance across country boundaries, by using English as the common language between national centres.

In 1997 thirteen national schemes already existed in Europe. Other countries are being progressively added and the ultimate aim is to cover the whole of Europe.



## APPENDICES

- 1. Physicochemical properties of nitric acid**
  - Density of aqueous nitric acid
  - Density of nitric acids of different concentrations
  - Vapour pressure in the physical equilibrium of nitric acid / nitrogen dioxide / water mixtures
- 2. List of sealant gaskets and other materials with which nitric acid is compatible or incompatible**
- 3. Training programme for drivers transporting nitric acid**
- 4. Typical checklist for filling tank containers and road tankers with nitric acid**
- 5. Typical checklist for filling tank wagons with nitric acid**
- 6. Measures to be taken in the event of transport accidents involving nitric acid**
- 7. Safety data sheets**
- 8. TREM cards (instructions in writing according to marginal 10385 ADR)**

## ANNEX 1

### Physicochemical properties of nitric acid

The following tables give the boiling temperature of aqueous  $\text{HNO}_3$  solutions and the composition of the vapour and liquid phase at atmospheric pressure.

Boiling temperature (°C)	$\text{HNO}_3$ content, % by weight		Boiling temperature (°C)	$\text{HNO}_3$ content, % by weight	
	In the liquid	In the vapour		In the liquid	In the vapour
100,0	0	0	120,05	68,4	68,4
104	18,5	1,25	116,1	76,8	90,4
107,8	31,8	5,06	113,4	79,1	93,7
111,8	42,5	13,4	110,8	81,0	95,3
114,8	50,4	25,6	96,1	90,0	99,2
117,5	57,3	40,0	88,4	94,0	99,9
119,9	67,6	67,0	83,4	100	100

As specified by S. Ellis.

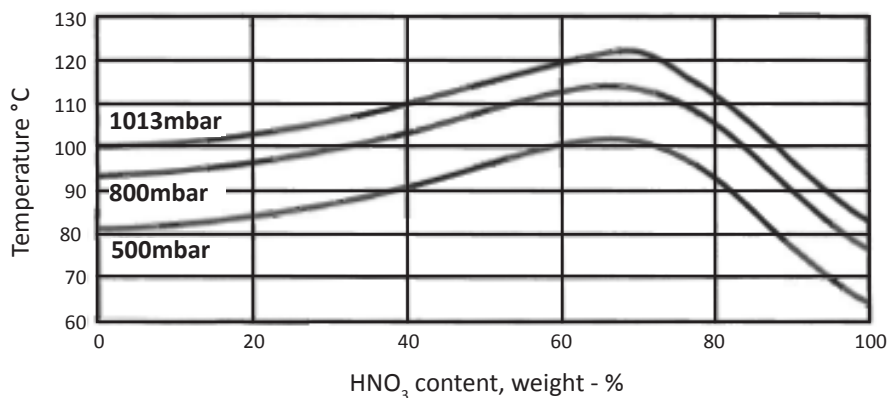

*Boiling temperatures of aqueous nitric acid solutions*

## Density of aqueous nitric acid

### Atmospheric pressure

Density	Content at 20°C (1)	% by weight at 15°C (2)	Density	Content at 20°C (1)	% by weight at 15°C (2)	Density	Content at 20°C (1)	% by weight at 15°C (2)
1,000	0,333	0,10	1,210	34,41	33,80	1,404		
1,005	1,255	1,00	1,215	35,16	34,53	1,405		66,37
1,010	2,164	1,90	1,220	35,93	35,26	1,410		67,47
1,015	3,073	2,80	1,225	36,70	36,01	1,415	70,00	68,60
1,020	3,982	3,70	1,230	37,48	36,76	1,420	68,10	69,77
1,025	4,883	4,60	1,235	38,25	37,51	1,425	69,23	70,95
1,030	5,784	5,50	1,240	39,02	38,27	1,430	70,39	72,14
1,035	6,661	6,38	1,245	39,80	39,03	1,4316	71,63	
1,040	7,530	7,26	1,250	40,58	39,80	1,435	72,86	73,35
1,045	8,398	8,13	1,255	41,36	40,56	1,4400	74,09	74,64
1,050	9,259	8,99	1,260	42,14	41,32	1,4450	80,00	75,94
1,055	10,12	9,84	1,265	42,92	42,08	1,450	75,35	77,24
1,060	10,97	10,67	1,270	43,70	42,85	1,455	76,71	78,56
1,065	11,81	11,50	1,275	44,48	43,62	1,460	78,07	79,94
1,070	12,65	12,32	1,280	45,27	44,39	1,465	79,43	81,83
1,075	13,48	13,14	1,285	46,06	45,16	1,470	80,88	82,86
1,080	14,31	13,94	1,290	46,85	45,93	1,475	82,39	84,41
1,085	15,13	14,73	1,295	47,63	46,70	1,480	83,91	86,01
1,090	15,95	15,52	1,300	48,42	47,47	1,485	85,50	87,66
1,095	16,76	16,31	1,305	49,21	48,24	1,490	87,29	89,46
1,100	17,58	17,10	1,310	50,00	49,05	1,495	89,07	91,56
1,105	18,39	17,88	1,315	50,85	49,88	1,500	91,13	94,04
1,110	19,19	18,66	1,320	51,71	50,69	1,501	93,49	94,55
1,115	20,00	19,44	1,325	52,56	51,51	1,502	95,46	95,03
1,120	20,79	20,22	1,330	53,41	52,34	1,503	96,73	95,50
1,125	21,59	20,99	1,3325		52,77	1,504	96,98	95,95
1,130	22,38	21,76	1,335	54,27	53,19	1,505	97,23	96,34
1,135	23,16	22,53	1,340	55,13	54,04	1,506	97,49	96,72
1,140	23,94	23,30	1,345	56,04	54,90	1,507	97,74	97,08
1,145	24,71	24,07	1,350	56,95	55,76	1,508	97,99	97,45
1,150	25,48	24,83	1,355	57,87	56,63	1,509	98,25	97,79
1,155	26,24	25,99	1,360	58,78	57,54	1,510	98,50	98,05
1,160	27,00	26,35	1,365	59,69	58,45	1,511	98,76	98,27
1,165	27,76	27,11	1,370	60,67	59,36	1,512	99,01	98,40
1,170	28,51	27,87	1,375	61,69	60,27	1,513	99,26	98,68
1,175	29,25	28,62	1,380	62,70	61,24	1,514	99,52	98,85
1,180	30,00	29,37	1,3833		61,89	1,515	99,70	99,02
1,185	30,74	30,12	1,385	63,72	62,21	1,516	100,00	99,16
1,190	31,47	30,87	1,390	67,74	63,20	1,5170		99,29
1,195	32,21	31,60	1,395	65,84	64,22	1,518		99,41
1,200	32,94	32,34	1,3979	70,00		1,519		99,52
1,205	33,68	33,07	1,400	66,97	65,27	1,520		99,62

(1) Küster Thiel (2) Batrakow

### Density of nitric acids of different concentrations

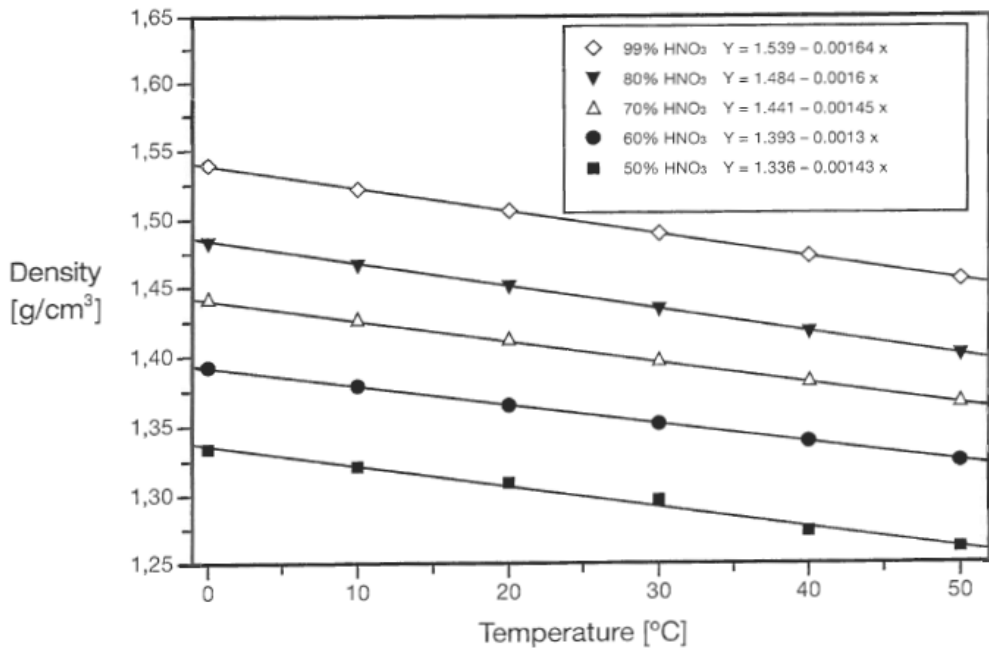

## Vapour pressure in the physical equilibrium of nitric acid/nitrogen dioxide/water mixtures

H <sub>2</sub> O	N <sub>2</sub> O <sub>4</sub>	86% HNO <sub>3</sub>		
		21°C	30°C	54°C
Vapour pressure in mbar				
13%	1%	77	152	325
12%	2%	88	196	454
11%	3%	101	232	530
10%	4%	109	254	585
9%	5%	116	270	633

H <sub>2</sub> O	N <sub>2</sub> O <sub>4</sub>	86% HNO <sub>3</sub>		
		21°C	30°C	54°C
Vapour pressure in mbar				
7%	1%	81	160	349
6%	2%	83	192	440
5%	3%	92	212	489
4%	4%	97	225	521
3%	5%	101	236	549

H <sub>2</sub> O	N <sub>2</sub> O <sub>4</sub>	86% HNO <sub>3</sub>		
		21°C	30°C	54°C
Vapour pressure in mbar				
11%	1%	79	155	333
12%	2%	87	194	449
9%	3%	98	225	516
8%	4%	105	244	563
7%	5%	111	259	605

H <sub>2</sub> O	N <sub>2</sub> O <sub>4</sub>	86% HNO <sub>3</sub>		
		21°C	30°C	54°C
Vapour pressure in mbar				
5%	1%	83	163	356
4%	2%	81	190	435
3%	3%	89	206	476
2%	4%	94	216	500
1%	5%	97	225	520

H <sub>2</sub> O	N <sub>2</sub> O <sub>4</sub>	86% HNO <sub>3</sub>		
		21°C	30°C	54°C
Vapour pressure in mbar				
9%	1%	80	158	341
8%	2%	85	193	444
7%	3%	94	219	503
6%	4%	101	235	542
5%	5%	106	248	576

H <sub>2</sub> O	N <sub>2</sub> O <sub>4</sub>	86% HNO <sub>3</sub>		
		21°C	30°C	54°C
Vapour pressure in mbar				
3%	1%	84	165	364
2%	2%	79	188	430
1%	3%	85	200	463
0%	4%	90	207	478

## ANNEX 2

### List of sealants gaskets and other materials with which nitric acid is compatible or incompatible

#### Materials

Material No.	Material Specification	Usage temp °C	Nitric-acid concentration %			Remarks
			>50<70%	>70<99%	>99%	
3.0255	Al 99,5	-30 +40	Unsuitable	>90%	Suitable	Pipes, app., tanklining
3.0285	Al 99,8	-30 +40	Unsuitable	>90%	Suitable	Pipe, app.
1.4361	X1CrNiSi1815 Antinit	-30 +90	Suitable	Suitable	Suitable	Pipes, app., tanks, fittings
1.4541	X6CrNiTi1810	Ambient	Suitable	<85%	Unsuitable	Pipes, app., tanks, fittings
1.4465	X1CrNiMoN25 252	Up to 70	Suitable	<85%	Unsuitable	Pipes, app., tanks, fittings
9.4306	GX3CrNiSiN2 013	Ambient	Suitable	Suitable	Suitable	Pumps
	Titanium	Up to 70	Suitable	<85%	Unsuitable	Special purposes
	Steel with PTFE	Ambient	Suitable	Suitable	Suitable	Pipes, fittings

#### Appropriate gaskets

HNO <sub>3</sub> concentration	Sealants name	Supplier	Usage temp.	Usage pressure
3->99%	PTFE-Ceramic blue	IDT, Kempchen	-10 up to +80°C	Max 6,0 bar
3->99%	PTFE-braid	Goretex	-10 up to +80°C	Max 6,0 bar
3->99%	Flexoform S	Merkel	-10 up to +80°C	Max 6,0 bar
3->99%	PTFE with 40% glasspowder	Kempchen	-10 up to +80°C	57,0 bar
3->99%	Gaylon Standard	Garlock	-20 up to +80°C	6,0 bar

## ANNEX 3

### Training programme for drivers transporting nitric acid

This training programme covers the specific hazards which may result from handling nitric acid.

The training course should be held by employees with practical experience of tank filling.

Drivers should receive sufficient information concerning:

- hazards for man and the environment
- protective measures and rules of conduct
- conduct in the event of a hazard
- first aid

### 1. Hazards for man and the environment

Nitric acid :

- is classified as
  - a dangerous good
  - a hazardous substance
  - a substance which pollutes water
- causes severe acid burns
- causes deep tissue destruction on contact with skin
- burns lead to wounds which are slow to heal. Acid burns covering large areas of skin may be fatal
- vapours and mist have an irritant effect on the eyes and the respiratory system
- develops very toxic nitrogen oxides when it acts on various metals and organic substances. Symptoms of toxicity may be delayed by several hours.

Take every precaution to prevent nitric acid escaping during loading, transport and unloading.

No unauthorised modifications should be made to design-approved tanks and their filling and emptying devices. Use only spare parts and seals made of Teflon (PTFE) conforming to the design approval.

All the hoses carried for unloading the product, including the hose couplings, must be made from a material which is resistant to nitric acid. Check the filling and emptying devices (dome lid, bottom valve, outlets etc.) for leak-proof closure after the tank has been filled.

## 2. Protective measures and rules of conduct

The vehicle driver must put on the prescribed protective clothing and equipment before driving up to the tank filling point.

Filling the road tanker is usually carried out by personnel appointed by the nitric acid consignor. If the driver is involved in the loading work, he must observe the consignor's safety instructions.

## 3. Conduct in the event of a hazard

### 3.1 At the road tanker filling point

The vehicle driver must leave the hazard zone immediately in the event of a hazard in the area of the filling point. In so doing, he must follow the instructions given by the filling personnel.

### 3.2 During transport

Following an accident, the vehicle driver must follow the instructions given on the tremcard. He must therefore be familiar with the contents of the tremcard before beginning the journey.

Notify the consignor of the nitric acid after alerting the local fire service and police (see Annex 4). Inform the fire service and police of the possibility of calling in ICE for assistance.

The vehicle driver must do everything possible to avert the danger while awaiting the arrival of the fire service and police and must take care not to endanger himself.

**CAUTION.** In the event of nitrous gas developing, detectable by the reddish brown colour:

- take note of the wind direction
- do not breathe in the gas
- do not pass through or remain in the gas cloud.

### 3.3 At the unloading point

The vehicle driver must put on the prescribed protective clothing and be satisfied that the unloading point is suitable for nitric acid.

Empty the unloading hoses completely.



## 4. First aid

Immediately wash any parts of the body affected using large amounts of water.

Rinse out the eyes under running water while holding the lids open. Continue until an ambulance arrives.

Remove contaminated clothing immediately.

Use the emergency shower at the loading or unloading station.

Take all affected persons to a doctor by ambulance as quickly as possible.

**WARNING. Inform the doctor immediately if there is reason to believe that nitrous gases have been inhaled.**

Nitrous gases (reddish-brown vapours, also known as nitrogen oxides) are extremely hazardous to health. Their effects on the human body may become evident after a delayed reaction time long after exposure (up to 24 hours). Anyone who has inhaled such gases must receive immediate medical attention, even if he or she is not showing any effects.

## 5. Proper disposal of spilled nitric acid which may have unintentionally escaped

The operating personnel at the facility are responsible for the disposal of nitric acid which has leaked at the loading or unloading point.

The vehicle driver must draw the attention of the operating personnel to any leaks they may not have noticed.

Call the fire service to dispose of any leaks which occur during transport.

Nitric acid pollutes water. Prevent nitric acid from entering surface or ground waters.

## 6. Some common questions on handling nitric acid:

- *What should be done in the event of skin contact with nitric acid?*

Wash the affected parts of the body with large amounts of water immediately. Soap may also help.

- *What will be the effects if nitric acid is not washed off the skin immediately?*

Nitric acid will cause severe acid burns and there will be deep destruction of tissue if it is allowed to act on the skin.

- *Why is it so important to prevent nitric acid reacting with wood or metals?*

Toxic nitrogen oxides (nitrous gases) will develop.

- *What should be done in the event of nitrous gases being inhaled?*

Take all affected persons to a doctor immediately. Transport affected persons lying down in an ambulance.

- *How should our eyes be protected from acid splashes?*

Wear safety goggles during all work in which nitric acid may escape.

- *What is the purpose of the emergency shower?*

A person hit by a flood of nitric acid must be washed immediately with large amounts of water in the emergency shower. Diluting the acid promptly and as thoroughly as possible prevents or reduces its harmful effects.

- *How should major leaks of nitric acid be handled?*

The fire service must be called to all major leaks of nitric acid.

- *How can small quantities of nitric acid be disposed of?*

Dilute small quantities of nitric acid with large quantities of water.

- *What is the minimum requirement for protective clothing and personal safety equipment to be worn when working with nitric acid?*

- Safety goggles
- Long, acid-resistant gloves
- Acid-resistant shoes

should be worn and all clothing securely done up when working with nitric acid.

## ANNEX 4

### Typical checklist for filling tank containers and road tankers with nitric acid

#### Warning! Never open a rising pipe first!

- Do not fill vehicles labelled 'Only for foodstuffs' or with similar labels!
- Instruct driving personnel to wear the protective clothing and personal safety equipment stipulated for the loading point or during filling!
- Instruct the driver, if he assists with the filling operation, on how to operate the filling devices!

General information:

Status:

Date:.....

Order number:	Vehicle licence plate:	
Product loaded: ...% nitric acid	Trailer licence plate:	
Quantity loaded (observe max. weight)	Tank container No:	
Operation details:		

### Measures and checks

#### I. Before filling

1. Are the Order No., product and quantity identical in the bill of lading and the filling order (or telephone advice)?	
2. Do the licence plates of the vehicle and, if appropriate, the TC number agree with the details given in the loading papers?	
3. Has the tare weight been measured?	
4. Has the original cleaning certificate or pre-product certificate been received and checked?	
5. Are the tank and the filling emptying devices (filling nozzle, dome lid, discharge openings and hose) clean, in particular for a change of product? Visual inspection	
6. Is the tank undamaged and is it suitable with respect to the equipment for receiving the nitric acid? Visual check.	
7. Do the seals on the filling openings meet the material requirements for nitric acid and are they free from mechanical damage? Visual check.	
8. Are the bottom and drainage valves tightly sealed?	

9a. Is the maximum permissible loading quantity stipulated in accordance with ADR=....% (concentration-dependent value)?	
9b. Is the minimum filling quantity maintained in accordance with ADR=80% in tank compartments of more than 7500 litres without flood walls?	

## II. During filling

10. Are the discharge and bottom valves tightly sealed ?	
11. Are the maximum permissible weight and filling limits maintained in accordance with ADR (Point 9)?	

## III. After filling

12. Are <u>all</u> the closure devices (dome lid, pressure nozzle, rising pipe, bottom valve, discharge openings etc.) properly closed and where appropriate, are protective caps or blind flanges fitted?	
13. Have the seals on the dome lid, filling nozzle and discharge openings been applied and noted in the loading papers?	
14. Have weather-proof product tags been fixed to the discharge openings?	
15. Have all old danger labels, orange warning plates (with numbers) and product labels which do not relate to the product being conveyed been removed?	
16. For tank containers: Have all stickers (danger labels, orange warning plates (film sheets) dangerous goods labels etc.) <u>attached to the loading papers</u> been checked for completeness and applied to the tank?	
17. Has the driver: a. attached the orange warning plates properly to the front and rear of the vehicle for conveying tank containers? or  b. attached the orange warning plates and hazard labels properly to the road tanker?	
18. Is any product sticking to the outside of the vehicle or tank or has this been completely removed?	

Checks carried out and confirmed by: .....  
(Signature of inspector appointed by the plant)

.....  
(Name in block capitals)

## ANNEX 5

### Typical checklist for filling tank wagons with nitric acid

#### Warning! Never open a rising pipe first!

- Do not fill vehicles labelled 'Only for foodstuffs' or with similar labels!
- Instruct driving personnel to wear the protective clothing and personal safety equipment stipulated for the loading point or during filling!
- Instruct the driver, if he assists with the filling operation, on how to operate the filling devices!

General information:

Status:

Date:.....

Order No.	Wagon No.
Product loaded: ...% nitric acid	Quantity loaded (Note load limit on the address board)
Operating details:	

### Measures and checks

#### I Before filling

1. Is this the correct tank wagon to be filled? (Order No., Tank wagon No.)	
2. Is the wagon to be filled approved for nitric acid (details of the product loaded on the address plate)? Are the correct product and collection address displayed on the drop boards, if present and are these boards secured against folding over?	
3. Is the wagon properly secured against collision and/or unintentional movements?	
4. Has the deadline for the next tank inspection been passed?	
5. Are the tank and the filling and emptying devices (including fittings) clean, particularly if there is a change of product? (Visual inspection)	
6. Is the tank undamaged and suitable for receiving nitric acid, with particular regard to the equipment (insulation, rising pipe etc.)? (Visual check)	
7. Do the seals on the filling openings meet the requirements for nitric acid and are they free from mechanical damage?	
8. Are the fittings which are not used for filling closed?	

9. Is the maximum filling level stipulated in accordance with RID=.....%? (Note: this value depends on the concentration)	
--	--

## II During filling

10. Are the fittings (rising pipe) tight? (Visual check)	
11. Does the predetermined loading quantity exceed the loading limit and the filling level in accordance with RID (Point 9)?	

## III After filling

12. Are <b>all</b> the closure devices (dome lid, pressure nozzle, rising pipe etc.) properly closed (all seals inserted, all nuts and bolts present and tightened, fittings -hand wheel, hand lever etc.- secured) and protective caps or blind flanges attached (particularly on the discharge openings)?  Nitric acid with a concentration above 99%: Has a leak detection been carried out?	
13. Have the seals on the dome lid, filling nozzle and discharge openings been fitted?	
14. Have weather-proof tags been attached to the discharge openings?	
15. Have all old danger labels, orange warning plates and product labels which do not relate to the product being conveyed, been removed?	
16. Have the described orange identification plates with the numbers ...../....., been mounted properly on both sides of the wagon, or the existing identification, been checked?	
17. Have the prescribed danger labels No ...../...../..... been mounted properly on both sides of the wagon, or have the existing hazard labels been checked?	
18. Is there any product sticking to the outside of the tank wagon or has this been completely removed?	

Checks carried out and confirmed by: .....  
(Signature of inspector appointed by the plant)

.....  
(Name in block capitals)

## ANNEX 6

### Measures to be taken in the event of transport accidents involving nitric acid

Telephone information (24-hour) to the respective consignor



Give the following important information:

- Your name
- Precise product designation
- Licence plate of your vehicle or the tank wagon number
- Your haulage company or railway management
- The name of the location
- The position of your vehicle or the tank wagon
- Contact telephone number
- Status of the vehicle or tank wagon (full or empty)
- The position and quantity of any leaks
- Any other damage
- Is the vehicle parked normally on the road or is the tank wagon standing on the tracks? If not, has it in any way slid off or been overturned?
- Has there been a release of nitrogen oxides?
- Have the police and fire service been notified?

## ANNEX 7

### Safety data sheets

From: Fertilizers Europe Guidance For The Compilation of Safety Data Sheets For Fertilizer Materials (1996)

## Nitric Acid (20 - <70% HNO<sub>3</sub>)

### 1. IDENTIFICATION OF THE PRODUCT AND THE COMPANY

#### 1.1 Identification of the Product

Designation	-
Trade name	
Commonly used synonyms	
CAS Number	7697-37-2
EINECS Number	231-714-2
EINECS Name	Nitric Acid
Molecular formula	HNO <sub>3</sub>

#### 1.2 Company

Address	Telephone No.
	Telefax No.
	Telex No.

#### 1.3 Emergency calls

Company <i>and/or</i>	Telephone No.
Official Advisory Body	Telephone No.

### 2. COMPOSITION/INFORMATION ON INGREDIENTS

#### 2.1 Nature of ingredients and concentration

Hazardous ingredient HNO<sub>3</sub>. Commonly 60-70% HNO<sub>3</sub>, rest essentially water; same safety regulations apply for concentrations from 20 to <70%.



## 2.2 Classification

Corrosive according to EEC Classification.

## 3. HAZARDS IDENTIFICATION

### 3.1 Human health

Nitric acid is corrosive and can cause severe burns to all parts of the body. Its vapours are corrosive to the respiratory tract and may cause pulmonary oedema which could prove fatal.

#### *Skin Contact*

- Liquid splashes may produce severe burns to skin.
- Nitric acid is highly corrosive to all parts of the body.

#### *Eye Contact*

- Liquid splashes may produce severe burns to skin and may cause serious damage to eyes.

#### *Ingestion*

- Will immediately cause corrosion of and damage to the gastro-intestinal tract.

#### *Inhalation*

- Fumes are corrosive to the respiratory tract and will cause severe coughing, sore throat and laboured breathing. Fluid build up on the lung (pulmonary oedema) may occur up to 48 hours after exposure and could prove fatal.

#### *Long term effects*

- Acute effects predominate and their severity is such that significant repeated or prolonged exposure is unlikely.
- Repeated exposure to high levels produces adverse effects on lung and teeth.

### 3.2 Environment

Nitric acid is harmful to aquatic life.

### 3.3 Other

Not classed as oxidizing agent. Can display oxidizing properties and react with combustible materials. May react violently with reducing agents, metals and a number of other substances. (See Section 10.)

Decomposition products include nitrogen oxides and hydrogen.

## 4. FIRST-AID MEASURES

### 4.1 Product

Speed is essential. Immediately remove contaminated clothing. Obtain medical attention immediately.

#### *Skin Contact*

- Drench with water, remove contaminated clothing and wash or shower the affected skin with plenty of water.
- Obtain immediate medical attention.

#### *Eye Contact*

- Immediately irrigate the eyes with eyewash solution or clean water for at least 10 minutes.
- Continue irrigation until medical attention can be obtained.
- Hold eyelids open during flushing.

#### *Ingestion*

- Do not induce vomiting.
- If the person is conscious, wash out mouth with water and give 2 or 3 glasses of water or milk to drink.
- Obtain immediate medical attention and transport the patient to hospital.

#### *Inhalation*

- Move the injured person to fresh air at once.
- Keep the patient warm and at rest.
- Administer oxygen if competent person is available.
- Perform artificial respiration, if breathing has stopped or shows sign of failing.
- Obtain immediate medical attention.

#### *Further medical advice*

Following exposure the patient should be kept under medical review for at least 48 hours as delayed pulmonary Oedema may develop.

## 5. FIRE-FIGHTING MEASURES

### 5.1 Suitable extinguishing media

- Foam, water and dry powder.
- Use a water spray to cool Fire-exposed containers and structures.

### 5.2 Specific hazards if the product is involved in a Fire

- Not combustible, but having oxidizing properties it may react with many combustible materials causing Fires and releasing toxic fumes (nitrogen oxides).
- May explode on contact with a powerful reducing agent.
- Reacts with most common metals to liberate hydrogen which can form explosive mixtures with air.
- Toxic fumes (oxides of nitrogen) may be given off.

### 5.3 Special protective equipment

- Wear self-contained breathing apparatus and full protective clothing.

### 5.4 Further information

Collect large amounts of contaminated extinguishing water separately, do not allow to reach sewerage or effluent systems.

## 6. ACCIDENTAL RELEASE MEASURES

### 6.1 Personal precautions

- Put on protective equipment before entering danger area. (See Section 8.)
- Ventilate area of spill or leak to disperse vapours.

### 6.2 Environmental precautions

- Take care to avoid the contamination of watercourses and drains.
- Inform appropriate authority in case of accidental contamination of watercourses.

### 6.3 Methods for cleaning

- Swill away small spillage with copious quantities of water.
- Waste water must be disposed of correctly. Before discharging sewage into treatment plants, neutralisation is generally required.
- Contain large spillage with sand or earth as necessary.
- Do not use organic compounds, sawdust etc
- Neutralise cautiously with soda ash and/or lime and recover for disposal.

- Pump large amounts into containers .
- Containers should preferably be of: stainless steel 1.4541 (DIN 17440) or plastic: (PVC, possibly polyethylene).
- Do not use: carbon steel, rubberised steel, polypropylene. Seek advice from the manufacturer if in doubt.

## 7. HANDLING AND STORAGE

### 7.1 Handling

- Wear eye and hand protection when handling small quantities.
- Provide adequate ventilation in view of insidious action of the fumes.
- When diluting, always add acid to water not water to acid.
- Wear full protective equipment where there is a risk of leaks or splashes.

### 7.2 Storage

- Store in cool, well ventilated area, away from potential sources of heat and direct sunlight.
- Keep away from combustible materials, reducing agents, strong bases.
- Protect containers from corrosion and physical damages.
- Containers should preferably be of stainless steel, 1.4541 (DIN 17440). Seek advice from the manufacturer if in doubt.

## 8. EXPOSURE CONTROL / PERSONAL PROTECTION

### 8.1 Occupational exposure limits

- ACGIH recommended values (1995-96):
- TLV/TWA : 2 ppm = 5.2mg/m<sup>3</sup>
- TLV-STEL: 4 ppm = 10mg/m<sup>3</sup>

### 8.2 Precautionary and engineering measures

- Local exhaust ventilation.
- Provide safety showers and eye washing facility at any location where skin or eye contact can occur.

### 8.3 Personal Protection

- Wear suitable breathing apparatus if exposure levels exceed the recommended limits.
- Wear PVC gloves, rubber boots, PVC suit.
- Use chemical safety goggles or full face shield.

## 9. PHYSICAL AND CHEMICAL PROPERTIES

Appearance	Colourless to yellow liquid.
Odour	Acrid.
pH (no dilution)	<1.
Freezing point	-17°C (20%); - 22°C (60%).
Boiling point	103.4°C (20%); 120.4°C (60%).
Flammability limits in air	None
Vapour pressure	0.77kPa at 20°C (60%)
Vapour density (air = 1)	2 approx
Solubility in water	Miscible in all proportions
Density at 20°C (g/cm <sup>3</sup> )	1.1150 (20%); 1.3667 (60%)

## 10. STABILITY AND REACTIVITY

### 10.1 Stability

The product is stable under normal conditions of storage and handling.

### 10.2 Conditions to avoid

High temperatures.

### 10.3 Materials to avoid

Contact with combustible materials, reducing agents, alkalies, metallic powders, hydrogen sulphide, alcohols, chlorates and carbides, carbon steel, monel, copper, and several other metals and alloys.

### 10.4 Hazardous reactions/decomposition products

- Contact with combustible material may cause fire. May assist combustion.
- May react violently with reducing agents, strong bases, organic materials, chlorides and finally divided metals.
- Reaction with most common metals liberates hydrogen and toxic oxides of nitrogen.
- Exothermic reaction with water.
- Corrosive gases/vapours.

## 11. TOXICOLOGICAL INFORMATION

### 11.1 General

- Nitric acid is highly corrosive to all parts of the body.

### 11.2 Toxicity Data

#### *Skin Contact*

- Pain, severe burns and brownish or yellow stains.
- Prolonged and repeated exposures to diluted solution may cause irritation, redness, drying and cracking of the skin.

#### *Eye Contact*

- Immediate pain, severe burns, permanent corneal damage which may result in blindness.

#### *Inhalation*

- Mists and vapours may cause irritation of nose, throat and respiratory tract, transient cough and broncho-constriction.
- Severe over-exposure may result in lung collapse and pulmonary Œdema which can be fatal.
- Prolonged or repeated exposure to mists or vapours of nitric acid may result in impaired lung function and possible discolouration and erosion of teeth.

#### *Ingestion*

- Pain, severe burning in the mouth, throat and damage to gastro-intestinal tract.

### 11.3 Other Data

No adverse effect has been evaluated by IARC as regards carcinogenicity.

## 12. ECOLOGICAL INFORMATION

### 12.1 Mobility

Soluble in water. High mobility in soil.

### 12.2 Persistence/Degradability

There is evidence of slow degradation in soil and water.

### 12.3 Bio-accumulation

The product has low potential of bio-accumulation.

### 12.4 Ecotoxicity

- Discharge into the environment to be avoided.
- Nitric acid is harmful to aquatic life even in low concentrations due to its acid nature.
- Neutralisation is generally required prior to discharge.
- TLM (96 hours) 10-100ppm
- Can cause damage to vegetation.
- Inhibition of degradation activity in activated sludge is not to be anticipated during correct introduction of low concentrations.

## 13. DISPOSAL CONSIDERATIONS

### 13.1 General

Nitric acid should be disposed of in accordance with local or national legislation.

## 14. TRANSPORT INFORMATION

### 14.1 UN classification

Class 8, Corrosive Substances, UN No 2031

### 14.2 Details

ADR/RID: Class 8, Item: 2j(b), Label 8, Packaging Group II

IMDG: Class 8, Label 8, Packaging Group II

## 15. REGULATORY INFORMATION

### 15.1 EEC Directives

Classification and labelling according to Directive 67/548/EEC

Classification:	Corrosive
Hazard symbol:	C, Representation of acid action.
Risk Phrase:	R35: Causes severe burns
Safety Phrases:	S2: Keep out of reach of children. S23: Do not breathe vapour. S26: In case of contact with eyes, rinse immediately with plenty of water and seek medical advice. S36: Wear suitable protective clothing S45: In case of accident or if you feel unwell, seek medical advice immediately (show the label where possible).

### 15.2 National laws

## 16. OTHER INFORMATION

The information in this Safety Data Sheet is given in good faith and belief in its accuracy based on our knowledge of the substance/preparation concerned at the date of publication. It does not imply the acceptance of any legal liability or responsibility whatsoever by the Company for the consequences of its use or misuse in any particular circumstances.

Date of issue: .....

Date of revision: .....



## ANNEX 8

### **TREM cards (instructions in writing according to marginal 10385 ADR)**

Suitable TREM cards in accordance with valid regulations (Marginal Number 10385 ADR) must accompany loads transported by road. Accompanying Accident Information Sheets TREM cards for rail transport are only required for products for which the railway company does not keep suitable Accident Information Sheets.

## LIST OF ABBREVIATIONS

ACGIH	American Conference of Governmental Industrial Hygienists
ADNR	Accord européen pour le transport de marchandises Dangereuses sur Route
ADR	Accord européen pour le transport de marchandises Dangereuses sur Route
ASTM	American Society for Testing and Materials
CAS	Chemical Abstracts Service
CEPIC	European Chemical Industry Council
DIN	Deutsche Industrie Norm/European Norm
EEC	European Economic Community
EINECS	European Inventory of Existing Commercial Chemical Substances
EN	European Norm (Standard)
IARC	International Agency for Research in Cancer
ICE	International Chemical Environment
IMDG	International Maritime Dangerous Goods Code
ISO	International Standards Organisation
PE	Polyethylene
PP	Polypropylene
PTFE	Polytetrafluorethylene
RID	Réglement International pour le transport de marchandises Dangereuses par chemin de fer
STEL	Short Term Exposure Limit
TFM	Tetrafluorethylene modified
TLM	Medium Toxicity Level
TLV	Threshold Limit Value
TREM	Transport Emergency (card)
TWA	Time Weighed Average (8 hours)
UNS	Unified Numbering System



Product Stewardship is defined as “the management of the safety, health and environmental aspects of a product throughout its lifecycle in an ethically responsible way”. It is Responsible Care as applied to products. In our application of Product Stewardship we cover the total value chain, but also address additional issues such as Best Practices that are not necessarily just dealing with the product characteristics.

For the fertilizer industry, Product Stewardship is ensuring that fertilizers and their raw materials, additives and intermediate products are processed and manufactured, handled, stored, distributed and used in a safe way with regard to health, occupational and public safety, environment, and security. This includes supplying plant nutrients which satisfy society’s requirements for the safe production of food and animal feed.

The Product Stewardship Program of Fertilizers Europe provides:

- a guidance on how to establish a Product Stewardship Program on a Company level
- agreeing with Fertilizers Europe standards on the production, distribution, storage and use of fertilizers
- reference to EU legislation, industry practices and best available techniques

The scope is limited to EU legislation and does not cover any specific National Requirements.

The Product Stewardship Program covers mineral fertilizers, their raw materials and intermediate products.

[www.productstewardship.eu](http://www.productstewardship.eu)



**product stewardship**  
**fertilizers**



Avenue E. van Nieuwenhuysse 4/6

B-1160, Brussels, Belgium

Tel: +32 2 675 3550

Fax: +32 2 675 3961

main@fertilizerseurope.com

**[www.productstewardship.eu](http://www.productstewardship.eu)**  
**[www.fertilizerseurope.com](http://www.fertilizerseurope.com)**

[twitter.com/FertilizersEuro](https://twitter.com/FertilizersEuro)



[www.youtube.com/fertilizerseurope](https://www.youtube.com/fertilizerseurope)



[www.facebook.com/fertilizerseuropepage](https://www.facebook.com/fertilizerseuropepage)



Group Fertilizers Europe

