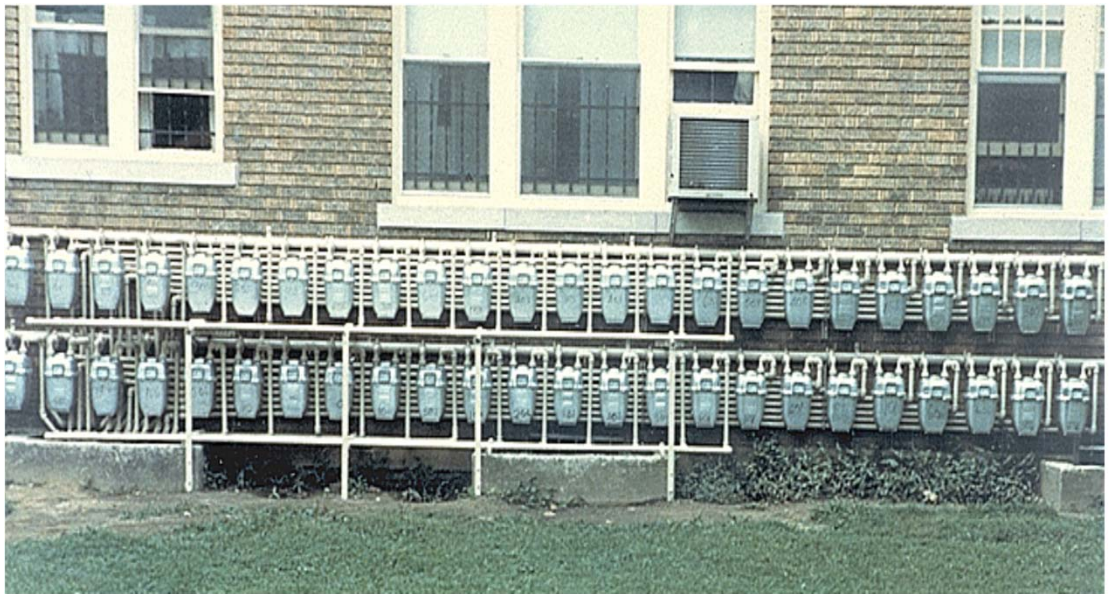


# Guidance Manual for Operators of Small Natural Gas Systems



**January 2017**



US Department of Transportation  
**Pipeline and Hazardous Materials Safety Administration**  
Office of Pipeline Safety

## TO THE READER

---

The U.S. Department of Transportation's (DOT) Pipeline and Hazardous Materials Safety Administration (PHMSA) promotes the safe transportation of natural gas by pipeline. This guidance manual for operators of small natural gas systems is part of our commitment to pipeline safety. This manual was developed to provide an overview of pipeline compliance responsibilities under the federal pipeline safety regulations. It is designed for the non-technically trained person who operates a master meter system, a small municipal system, or small independent system.

The Federal Government recognizes that many of the safety regulations are written in technical language that addresses generic requirements for both large and small natural gas systems. This manual attempts to simplify the technical language of the regulations.

For certain critical regulations, this manual provides details of methods of operation and selection of materials that will satisfy the pipeline safety regulations. However, this is often only one of several allowable options. This manual provides a set of examples that operators of small natural gas systems can use to meet the minimum requirements of the pipeline safety regulations.

For example, requirements for pressure testing vary throughout the pipeline safety regulations. The test pressure used in this manual is usually 100 pounds per square inch to provide clarity and consistency to small operators unfamiliar with the intricacies of natural gas pipeline operations. The operator is referred to 49 CFR Part 192 for additional details and other options for reaching and maintaining compliance.

Our aim is to provide basic information to operators of small natural gas distribution and master meter systems to ensure compliance with the federal gas pipeline safety regulations. It is hoped that this document will assist operators in achieving and maintaining a safe and efficient natural gas system. The result will enhance public safety – the essential goal of the Office of Pipeline Safety.

Alan K. Mayberry  
*Associate Administrator for Pipeline Safety*

## ACKNOWLEDGEMENTS

---

This guidance manual was revised by the APGA Security and Integrity Foundation (SIF) under a cooperative agreement with the U.S. DOT. The manual relies on sources representing the best opinion on the subject at the time of publication. It should not, however, be assumed that all acceptable safety measures and procedures are mentioned in this manual. The reader is referred to the Code of Federal Regulations (49 CFR Parts 190-199 and Part 40) for the complete pipeline safety requirements.

PHMSA gratefully acknowledges the contributions of the many individuals and organizations who contributed their time and expertise to this manual. Most especially, it is a product of close cooperation with the National Association of Pipeline Safety Representatives (NAPSR).

The advisory group involved in the revision of this manual included:

John Erickson, APGA SIF, Project Manager

Glynn Blanton, Pipeline and Hazardous Materials Safety Administration (PHMSA)

David E. Bull, ViaData

Bill DeFoor, Municipal Gas Authority of Georgia

William Donley, Payne Environmental Services

David Hraha, Iowa Association of Municipal Utilities

Chet Kokoszka, New Hampshire Public Utilities Commission

Don Ledversis, Rhode Island Public Utilities Commission

Gerry Lee, APGA SIF

L Lognion, Heath Consultants

Joe Molloy, Colorado Department of Regulatory Agencies

Roy Montemarano, Heath Consultants

G. C. Morris, Vermont Department of Public Service

Jerry Palo, California Public Utilities Commission

Rod Parcel, Iowa Association of Municipal Utilities

Rudy Parcel, Iowa Association of Municipal Utilities

Judy Ramsey, Alabama Public Service Commission

Terry Roach, Carrollton Utilities, KY

Mike Sasser, Defuniak Springs Natural Gas, FL

Phil Sher, Phil Sher Associates

Matt Smith, Illinois Commerce Commission

Michael Smith, New Mexico Public Regulation Commission

Nathan Solem, South Dakota Public Utilities Commission

Larry Sorensen, Iowa Utilities Board

Kevin Speicher, New York Department of Public Service

Kan Wai Tong, California Public Utilities Commission

The revision and publication of this manual is an example of constructive partnership among government, the pipeline industry and industry and professional organizations.

Sponsor Approval:

Alan K. Mayberry  
PHMSA Associate Administrator for Pipeline Safety

This document may be reprinted without permission from PHMSA.

Any comments, suggestions or revisions should be sent to the Director, PHMSA Inspector Training & Qualifications, (PHP-70) 3700 S. MacArthur Boulevard, Suite B, Oklahoma City, OK 73179.



GUIDANCE MANUAL  
FOR  
OPERATORS OF SMALL NATURAL GAS SYSTEMS

TABLE OF CONTENTS

---

To The Reader	
Acknowledgements	
<b>CHAPTER I: INTRODUCTION AND OVERVIEW</b>	
Introduction	I-1
Overview	I-2
<b>CHAPTER II: REGULATORS AND RELIEF DEVICES</b>	
BASIC CONCEPTS	II-1
Pressure	II-1
Pressure and Force	II-4
Flow and Throttling	II-5
PRESSURE REGULATION	II-5
SOME BASIC NAMES AND TERMS	II-8
OVERPRESSURE PROTECTION	II-11
Pressure Relief	II-13
Monitor Regulating	II-14
Automatic Shutoff	II-16
INSPECTION AND TESTING OF REGULATING AND RELIEF DEVICES	II-18
<b>CHAPTER III: CORROSION CONTROL</b>	
FEDERAL REQUIREMENTS	III-1
Procedures and Qualifications	III-1
Techniques for Compliance	III-1
Corrosion Control Requirements for Pipelines Installed After July 31, 1971	III-2
Corrosion Control Requirements for Pipelines Installed Before August 1, 1971	III-2
Coating Requirements	III-3
Examination of Exposed Pipe	III-3
Criteria for Cathodic Protection	III-4
Monitoring	III-4
Electrical Isolation	III-4
Test Points	III-4
Internal Corrosion Inspection	III-5
Atmospheric Corrosion	III-5
Remedial Measures	III-5
Graphitization of Cast Iron	III-5
Records	III-5

FUNDAMENTALS OF CORROSION	III-6
PRINCIPLES AND PRACTICES OF CATHODIC PROTECTION	III-7
Types of Cathodic Protection	III-14
Criteria for Cathodic Protection	III-18
Coatings	III-19
COMMON CAUSES OF CORROSION IN GAS PIPING SYSTEMS	III-21
<b>CHAPTER IV: LEAK DETECTION AND ODORIZATION</b>	
LEAK DETECTION	IV-1
Methods Of Detecting A Leak	IV-2
Description Of Leak Detection Equipment	IV-4
RECOMMENDED METHOD FOR SURFACE GAS DETECTION SURVEY	IV-9
Records	IV-10
Follow-Up Inspection	IV-10
ODORIZATION	IV-11
Types Of Odorants	IV-11
Monitoring Techniques	IV-11
Odorization Equipment	IV-13
<b>CHAPTER V: UNACCOUNTED FOR GAS</b>	
Unmetered Gas	V-1
Gas Measurement Issues	V-2
Significance of UAF	V-4
<b>CHAPTER VI: REPAIRS AND NEW CONSTRUCTION</b>	
Planning Ahead	VI-1
Excavation	VI-2
Emergency Excavation	VI-2
Precautions to Avoid Damage	VI-2
Reporting Damage	VI-3
Mandatory Participation in One-Call Centers	VI-3
PIPE INSTALLATION, REPAIR, AND REPLACEMENT	VI-3
Metallic Pipe Installation	VI-4
Plastic Pipe Installation	VI-5
Repair Methods: Plastic and Metal	VI-19
MATERIALS AND EQUIPMENT FOR USE IN NATURAL GAS SYSTEMS	VI-22
Pipe	VI-22
Valves	VI-25
Flanges and Flange Accessories	VI-25
Regulators and Overpressure Protection Equipment	VI-25
WELDING REQUIREMENTS	VI-27
COMMON CONSTRUCTION PRACTICES	VI-31
Plastic Pipe installation concerns – Brittle like Fractures	VI-42

## **CHAPTER VII: SERVICE LINES, CUSTOMER METERS AND REGULATOR SETS**

Customer Meters and Regulators: Location	VII-1
Customer Meters and Regulators: Protection from Damage	VII-3
Customer Meters Installations: Operating Pressure	VII-3
Service Lines: Location of Valves	VII-3
Excess Flow Valves	VII-4
Service Line Location	VII-5
Common Problems at Service Riser and House Regulators	VII-9
Discontinuing Service to a Customer	VII-9

## **CHAPTER VIII: PLANS AND REPORTS REQUIRED BY THE FEDERAL GOVERNMENT**

PLANS REQUIRED BY THE FEDERAL GOVERNMENT	VIII-1
Operations and Maintenance Plans	VIII-2
Emergency Plans	VIII-9
Public Awareness	VIII-15
Distribution Integrity Management	VIII-21
Operator Qualification	VIII-21
Anti-Drug And Alcohol Misuse Prevention Plans	VIII-21
Control Room Management Plan	VIII-21
REPORTS REQUIRED BY THE FEDERAL GOVERNMENT	VIII-22
Incident Reports	VIII-22
Annual Reports	VIII-23
Mechanical Fitting Failure Report	VIII-23
Safety-Related Condition Reports	VIII-23

## **CHAPTER IX: INTEGRITY MANAGEMENT**

DISTRIBUTION INTEGRITY MANAGEMENT	IX-1
Know Your System	IX-2
Identify Threats	IX-2
Evaluate and Rank Risk	IX-3
Implement Risk Reduction Measures	IX-4
Measure Performance, Monitor Results and Evaluate Effectiveness	IX-5
Periodically Assess the Effectiveness of the Program	IX-6
Report Results	IX-6
Recordkeeping	IX-6
DIMP Resources	IX-7
TRANSMISSION INTEGRITY MANAGEMENT	IX-8
Potential Impact Circle	IX-8
High Consequence Areas	IX-9
Integrity Management Plan and Program	IX-10
Baseline Assessment	IX-11
Remedial Action	IX-12

**APPENDIX A: GLOSSARY AND ACRONYMS**  
**APPENDIX B: SAMPLE FORMS**  
**APPENDIX C: STATE PIPELINE SAFETY AGENCIES**

## CHAPTER I: INTRODUCTION AND OVERVIEW

---

This chapter contains a simplified description of the pipeline safety requirements. The complete text can be found in 49 CFR Part 192.

---

### INTRODUCTION

---

Public Law 104-304 requires the U.S. Department of Transportation (DOT) to develop and enforce minimum safety regulations for the transportation of gases by pipeline. The safety regulations became effective in 1970, and are published in Title 49 of the Code of Federal Regulations (CFR), Parts 190, 191, 192, and 199. The Office of Pipeline Safety of DOT's Pipeline and Hazardous Materials Safety Administration (PHMSA) is charged with their enforcement.

The gas pipeline safety regulations apply to natural gas systems and operators of natural gas master meter systems. The pipeline safety regulations require operators of natural gas systems to: deliver gas safely and reliably to customers; provide training and written instruction for employees; establish written procedures to minimize the hazards resulting from natural gas pipeline emergencies; and, keep records of inspection and testing based on suggested forms found in Appendix B.

Additionally, operators of all natural gas systems, **except master meter systems**, must test employees in safety-sensitive positions for prohibited drugs and alcohol and provide an employee assistance program. The requirements for drug and alcohol testing of pipeline employees are found in 49 CFR Part 199, which incorporates the overall OPS drug testing requirements found in 49 CFR Part 40.

Natural gas operators who do not comply with the safety regulations may be subject to civil penalties, compliance orders, or both. If safety problems are severe, a "Corrective Action Order" may be issued by OPS. This could result in the shutdown of the system.

State agencies may enforce pipeline safety regulations under certification by OPS. The state agency is allowed to adopt additional or more stringent safety regulations for intrastate pipeline transportation as long as such regulations are compatible with the federal minimum regulations. If a state agency is not certified, however, the DOT retains jurisdiction over intrastate pipeline systems.

Operators should check with the pipeline safety agency in their state (Appendix C) to determine:

- Whether a state agency has safety jurisdiction;
- Whether the state agency has pipeline safety requirements that exceed the federal regulations;
- The inspection and enforcement procedures of the state agency.

---

## OVERVIEW

---

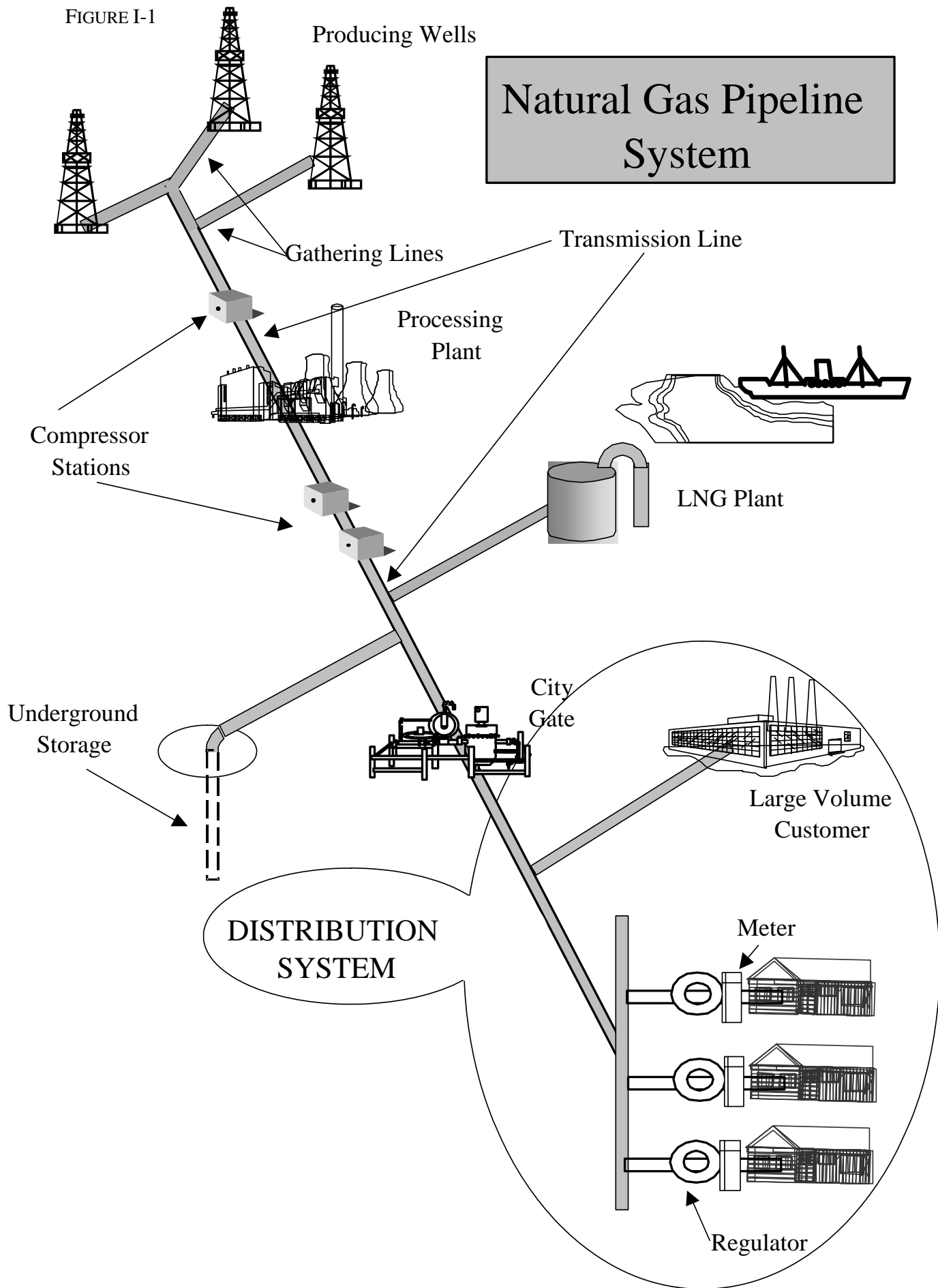
The natural gas pipeline industry consists of transmission and distribution systems. These pipeline systems can be simple or complicated, however, all gas pipeline companies are held to the same safety standards.

FIGURE I-1 represents one of the many possible configurations of natural gas transmission and distribution systems. The natural gas:

- Flows from the producing wells into gathering line(s).
- Through gathering lines and compressors or compressor stations.
- After the compressor(s), through transmission lines.
- To a processing plant where the heavier hydrocarbons, such as propane, butane, ethane or natural gasoline, which are initially components of the gas stream, are removed.
- Through the transmission line and additional compressors.
- From the compressors to underground storage or a liquefied natural gas (LNG) plant (where natural gas is liquefied by reducing its temperature to - 260 °F), or directly to a city gate station or master meter system.

FIGURE I-2 is an example of a distribution system that consists of mains and services operating at different pressures, which are controlled by regulators. Often, industrial customers receive gas service through high-pressure distribution mains. The small commercial and the residential gas systems can be fed from either low- or high-pressure distribution systems.

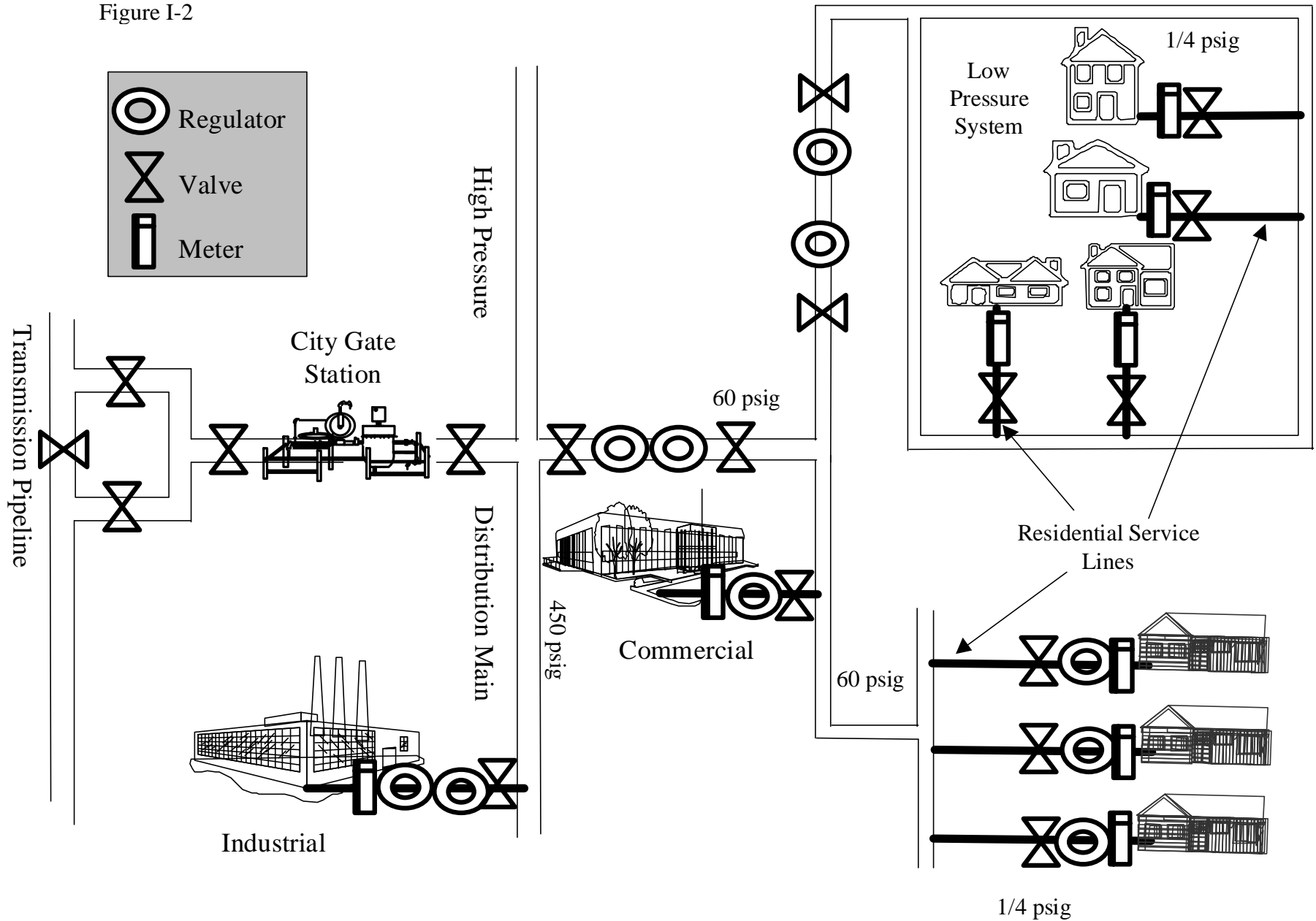
FIGURE I-1





# Natural Gas Distribution System

Figure I-2



## CHAPTER II: REGULATORS AND RELIEF DEVICES

---

This chapter contains a simplified description of the pipeline safety requirements. The complete text can be found in 49 CFR Part 192.

### BASIC CONCEPTS

---

In understanding the equipment used to regulate the pressure of natural gas, it is helpful to be familiar with some fundamental physical units and concepts. Four are particularly important. Taken in pairs they are:

PRESSURE and FORCE  
FLOW and THROTTLING

---

### PRESSURE

---

In the natural gas business, the commonly used pressure units are:

psi = pounds per square inch  
in. w.c = inches water column

These units are sometimes referred to as “pounds” and “inches.”

It is important to remember that "pounds" and "inches" are the short form of expressing pressure units. There really is no such thing as a pound of pressure or an inch of pressure. They are incomplete terms. Pressure is defined as force per unit area. “Pounds” expresses only the "force" portion of that definition. The unit of "area" is missing. Thus, the complete terminology should be "pounds per square inch."

When gas is under pressure, it exerts a force against each unit of exposed area. For example, gas at a pressure of 10 psi pushes with a force of 10 pounds against each square inch of surface exposed to the gas.

There are some other forms to note as follows:

psia = pounds per square inch absolute  
psig = pounds per square inch gauge

The relationship between the two is simple:

$psia = psig + \text{atmospheric pressure}$

Absolute pressure (psia) uses a perfect vacuum as the zero point. A perfect vacuum is 0 psia.

Gauge pressure (psig) uses the actual atmospheric pressure as the zero point. In Miami, sea level atmospheric pressure is 14.7 psia. Thus, 0 psig is 14.7 psia in Miami. In Denver (5,280 feet elevation), atmospheric pressure is 12.1 psia. And 0 psig for Denver is 12.1 psia.

Most references to pressure in natural gas distribution applications are gauge pressure (psig).

Inches of water column are often used to express the pressure at which gas is delivered to residential customers. A container of water 27.71 inches tall would exert a pressure of 1 pound per square inch at the bottom of the container. To properly operate, household gas appliances typically need gas at a pressure between about 5 inches w.c. and 13 inches w.c. (about 1/5 to 1/2 psig -- pressure limits will vary by appliance). This is known as "utilization pressure."

Pressure measurement in inches is often done with an instrument called a manometer. See Figure II-1.

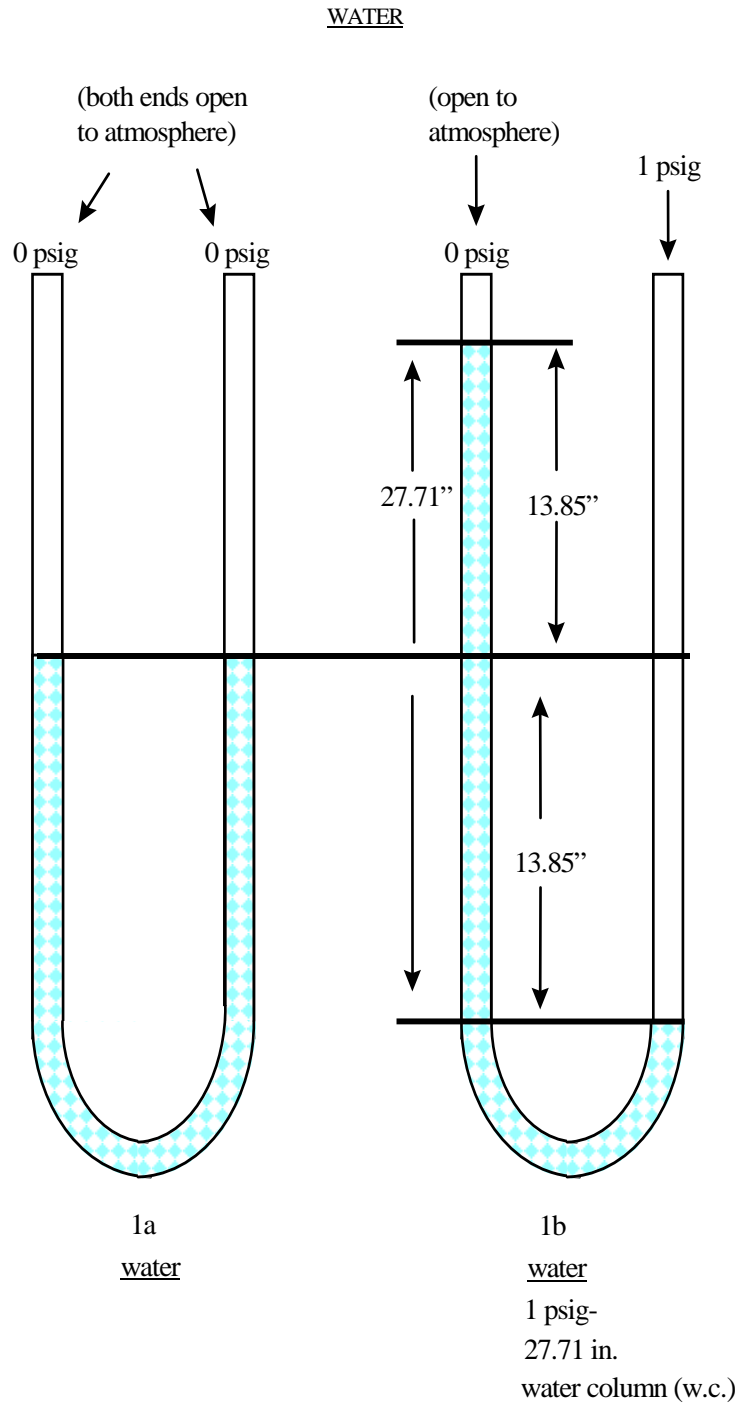
The important relationships to remember are these:

For inches water column:  $1 \text{ psig} = 2.71 \text{ in. w.c.}$

Note the physical limitations to pressure measurement with the manometer. The highest pressure that could be measured with a "U" type manometer 5-feet high would be only a little over 2 psig (56 in. w.c.). However, note also that it offers a very precise way of measuring low pressures.

When expressing pressure in inches, it is necessary to identify the liquid. To put it another way, there really is no such thing as an inch of pressure. Instead, it is inches of a particular liquid, in the gas business generally water or mercury. Thus, the correct expression is inches water column (in. w.c. or in. H<sub>2</sub>O). Figure II-1 illustrates how to read a manometer.

Figure II-1 U Tube Manometer



---

## PRESSURE AND FORCE

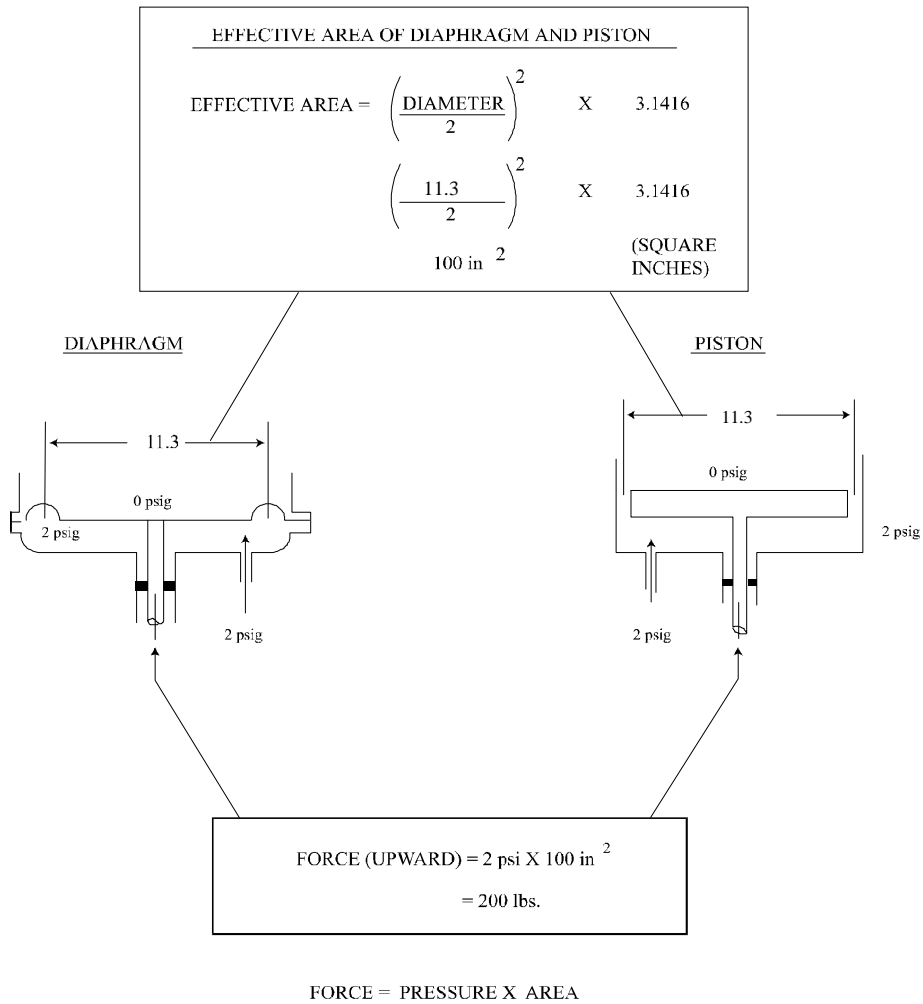
---

Force is simply a push or a pull. It is measured in pounds.

Note that pounds of pressure is incomplete (it should be pounds per square inch) whereas pounds of force is complete. Thus, it would be "x" pounds of pushing force or pulling force.

Figure II-2 shows the relationship between pressure and force. Note that pressure creates a force. Also, note how much force (200 pounds) can be created with only a small amount of pressure (2 psig.) It is all a matter of diaphragm area or piston area over which the pressure is acting. A diaphragm is simply a low friction, tightly sealed, short stroke piston (just the thing for use in regulators).

Figure II-2 Relationship Between Pressure and Force



---

## FLOW AND THROTTLING

---

To throttle the flow of a fluid is to allow only a certain amount to flow and to hold back the remainder. A faucet (a valve) is a good example of a throttling device. How much water is wanted determines how far the faucet is opened. Depending on how far it is opened, it allows only a certain amount of water to flow and holds the rest back.

Throttling is a basic function in a regulator (see next section for a discussion of regulators). The part that throttles gas is a valve. It allows only a certain amount of gas to flow and holds the rest back.

Not all valves can be used for throttling. Some valves (like many gate valves) are designed to be either wide open or fully closed. If used in an intermediate position (one-third open, half-open, three-fourths open, etc.), they become unstable (e.g. the valve may chatter, rattle, hammer, etc.). They are unsatisfactory for throttling gas flow, but may be suitable for uses where the valve is either fully open or fully shut.

---

## PRESSURE REGULATION

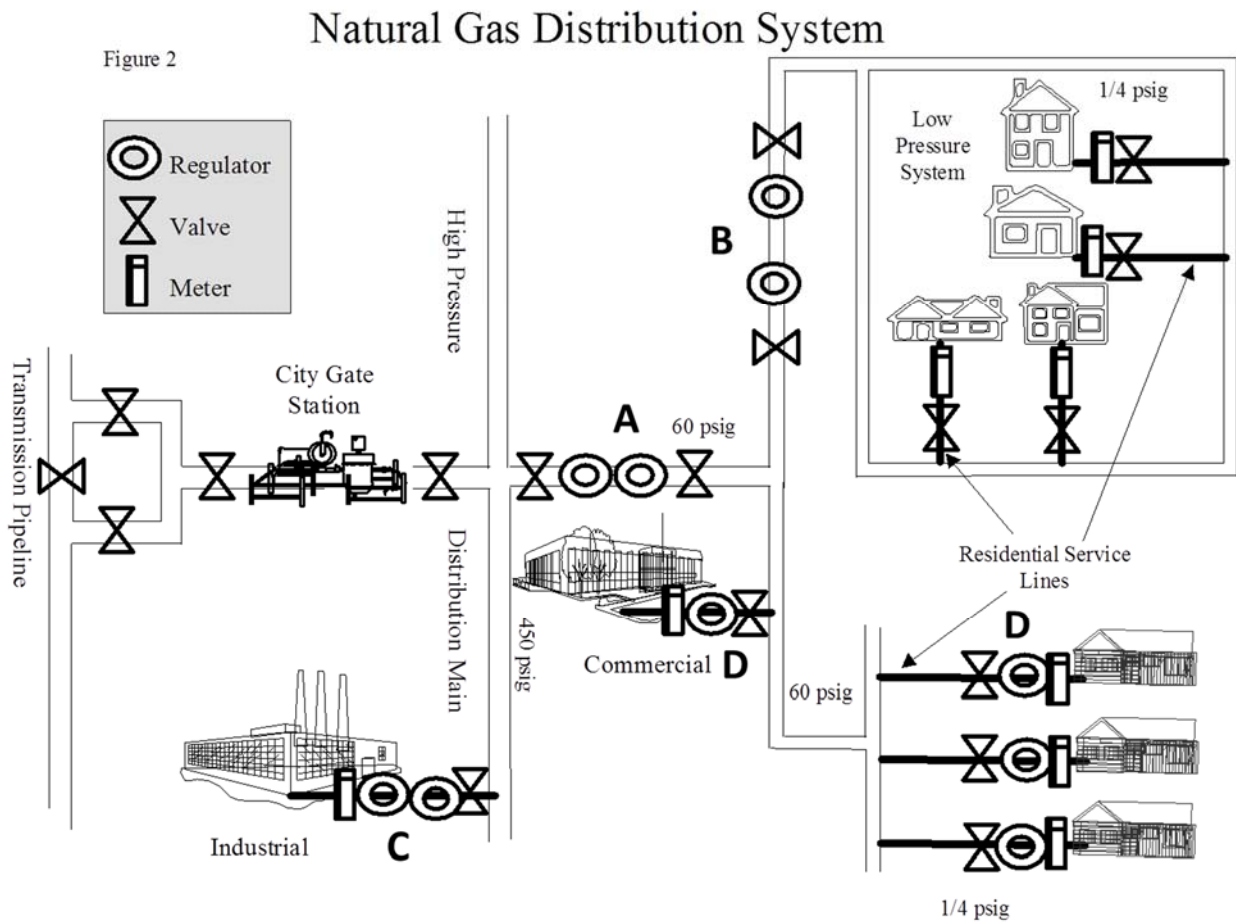
---

The pressure of gas in gas piping is controlled by devices called “regulators.” Regulators are installed wherever parts of the distribution system operating at different pressures are connected. For example, Figure II-3 shows pressure regulators in the following locations:

1. On the gas main between the 450 psig piping and the 60 psig piping (Labelled “A”),
2. On the gas main between the 60 psig piping and the low pressure (1/4 psig) piping (Labelled “B”),
3. At the connection of the 450 psig piping to the industrial customer (Labelled “C”),
4. At the connection of the 60 psig piping to the commercial and residential customers (Labelled “D”).

Note that a regulator is not required for those residential customers connected to the low pressure system. Because the pressure in the low pressure piping system is at 1/4 psig utilization pressure, it requires no further pressure reduction before entering the customer’s house piping. Pressure regulators are required for customers connected to the 450 psig and 60 psig piping systems to prevent high pressure gas from damaging the customer’s piping and gas-burning equipment that may not be designed to withstand such pressure.

Figure II-3 Natural Gas Distribution System



A regulator consists of a valve, a valve actuator and a pressure sensing element. The valve controls how much gas passes through the regulator. The actuator provides the force to open and close the valve. The pressure sensing element causes the actuator to open or close the valve to let through just enough gas to maintain the proper pressure in the downstream piping.

How regulators work to automatically open and close when needed can be illustrated by looking at one of the homes connected to the 60 psig system in the bottom right of Figure II-3. When the furnace kicks on inside one of the homes, gas flows into the appliance from the house piping. This causes the pressure in the house piping to drop below its normal pressure of 1/4 psig. The regulator at the meter to the house (called a “service regulator”) senses the drop in house piping pressure and opens just enough to allow more gas to flow from the 60 psig piping into the house piping to bring the house piping pressure back up to 1/4 psig. That in turn causes the pressure in the 60 psig system to drop below 60 psig. This pressure drop is sensed by the “district” regulator separating the 60 psig system from the 450 psig system (Labelled “A” in Figure II-3). That regulator will respond by opening wider to allow more gas to flow from the 450 psig system into the 60 psig system to bring the pressure back up to 60 psig. This in turn causes the pressure in the 450 psig system to drop below 450 psig, which is sensed by the regulator at the city gate station that will open wider to let more gas flow and bring the pressure in the 450 psig system back up to 450 psig.



When the thermostat in the home shuts off the furnace, the pressure in the house piping goes up slightly and the entire process reverses -- each of these pressure regulators automatically closes slightly to maintain the proper pressure in the piping downstream of each regulator.

Each of these regulators will be continually, automatically adjusting gas flow to match the changing gas demand.

A valve used as a regulator must be mechanically stable at any position, from wide open to as small a flow as possible. In addition, it must change the flow smoothly as it is opened or closed. The most widely used valve for regulators is the single-port, unbalanced, globe valve. It is economical in construction yet provides good throttling. In addition, it has a smooth stroke, little friction, and good shut-off (lock-up) characteristics.

Figure II-4A Single Port Spring Regulator

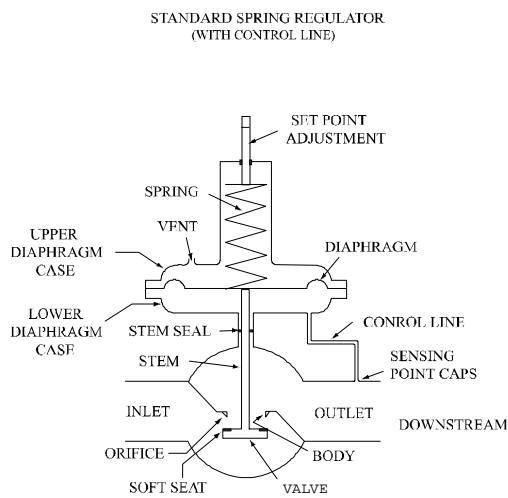


Figure II-4B Single Port Spring Regulator

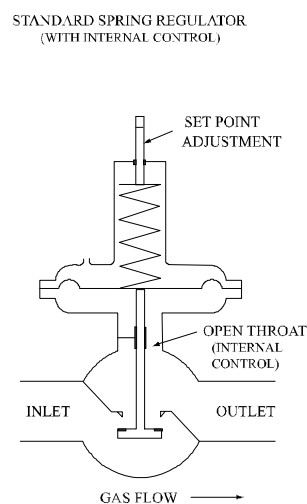
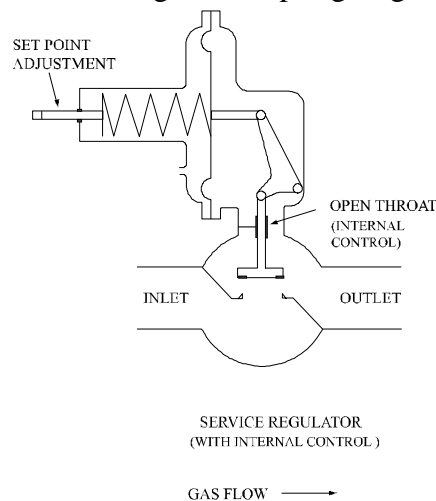


Figure II-4C Single Port Spring Regulator



There are two types of regulators used in gas distribution, self-operated and pilot-operated. Figure II-4 shows a simple section of a standard, self-operated, spring regulators. The various

parts are labeled. For most master meter operators this will be the only type of regulator in the system. Service regulators are this type of regulator. Referring to Figure II-4, the following is a simple explanation of how it works.

1. Spring compression works to open the valve.

The rule is: The PRIMARY VALVE OPENING FORCE in a spring regulator comes from the spring (usually, spring compression).

2. The diaphragm works to close the valve.

The rule is: The PRIMARY VALVE CLOSING FORCE in a spring regulator comes from gas pressure pushing against the diaphragm.

3. An increase in outlet pressure puts more force on the diaphragm which closes the valve. Conversely, a decrease in outlet pressure opens the valve.
4. Set point (the outlet pressure a regulator is adjusted to deliver) is determined by spring compression. Turning the set point adjustment clockwise compresses the spring which increases the set point pressure, and vice versa.

---

### SOME BASIC NAMES AND TERMS

---

Referring to Figure II-4, the inlet is the opening through which gas enters a regulator. The pressure of the entering gas is usually called the inlet pressure, although it could also be called the upstream or supply pressure.

The outlet is the opening by which gas leaves a regulator. The pressure of the exiting gas is usually called outlet pressure, although it could also be called downstream pressure.

In general, the more the inlet pressure exceeds the outlet pressure, the greater the amount of gas that can flow through the regulator and the greater the capacity of the regulator. The difference between inlet and outlet pressures is sometimes called the differential across the regulator.

Piping on the inlet side is upstream and piping on the outlet side is downstream. As stated previously, a regulator takes higher pressure gas from the supply and reduces it to the pressure required by the load. To do this, something is needed on the regulator to adjust it for the specific pressure required. This adjustment is called the set point adjustment and on most of today's regulators it is a screw-type device of some kind, usually a simple adjustment screw. Set point is the pressure a regulator is adjusted to deliver. It is the pressure required by the load and, in general, is the same as the outlet pressure.

Note the control line referred to in Figure II-4A. It is also called a sensing line, impulse line, equalizing line or static line. The control line and the sensing point are vital parts of a regulator

installation. They must be carefully planned and correctly installed if the regulator is to operate satisfactorily and safely. Improperly installing a sensing or control line can cause the regulator to not respond as required.

Many regulators, particularly smaller ones, do not have the external control line shown in Figure II-4A. Instead, it is internal as represented by Figure II-4B. Called internal control, it is inside some form of open throat construction or venturi tube. However, whether located internally or externally, every regulator has a control line or the equivalent.

Control lines must be adequately protected against breakage. If they are broken, there is no gas pressure on the diaphragm causing the regulator to open wide. This could result in the low-pressure system being subjected to the full upstream line. This can lead to a catastrophic situation where the downstream piping is over pressured causing possible failures.

While often appearing insignificant, the vent is important to a regulator. Regulators breathe. As the internals move in the work of controlling pressure, a regulator will inhale or exhale through the vent. Therefore, the vent must be adequately protected from obstructions such as dirt, insects, ice, etc. If an obstructed vent prevents a regulator from breathing, the diaphragm will not work properly. If the vent becomes completely obstructed, then the regulator can either shut the gas off to a customer or increase the pressure to upstream pressure causing possible failures.

In the event that the regulator fails open; the higher pressure gas dissipates thru the vent.

Also, water can get inside a regulator through an improperly positioned and unprotected vent. Water inside a regulator can cause problems. Therefore, vents must be positioned and protected to keep the water out. This is particularly important on outdoor installations. If a regulator is installed where water may enter the vent, then most regulator vent outlets are equipped with threads. This allows piping to be attached to the vent and redirected so that water may not enter the vent. (It is important to remember that a vent screen must be reattached in this instance)

The last item is the stop valve (Figure II-5). A simple installation (such as at a house) usually has only one. A more complex installation such as a regulator station would have several stop valves (inlet stop valve, outlet stop valve, control line valve, bypass valve, and perhaps others).

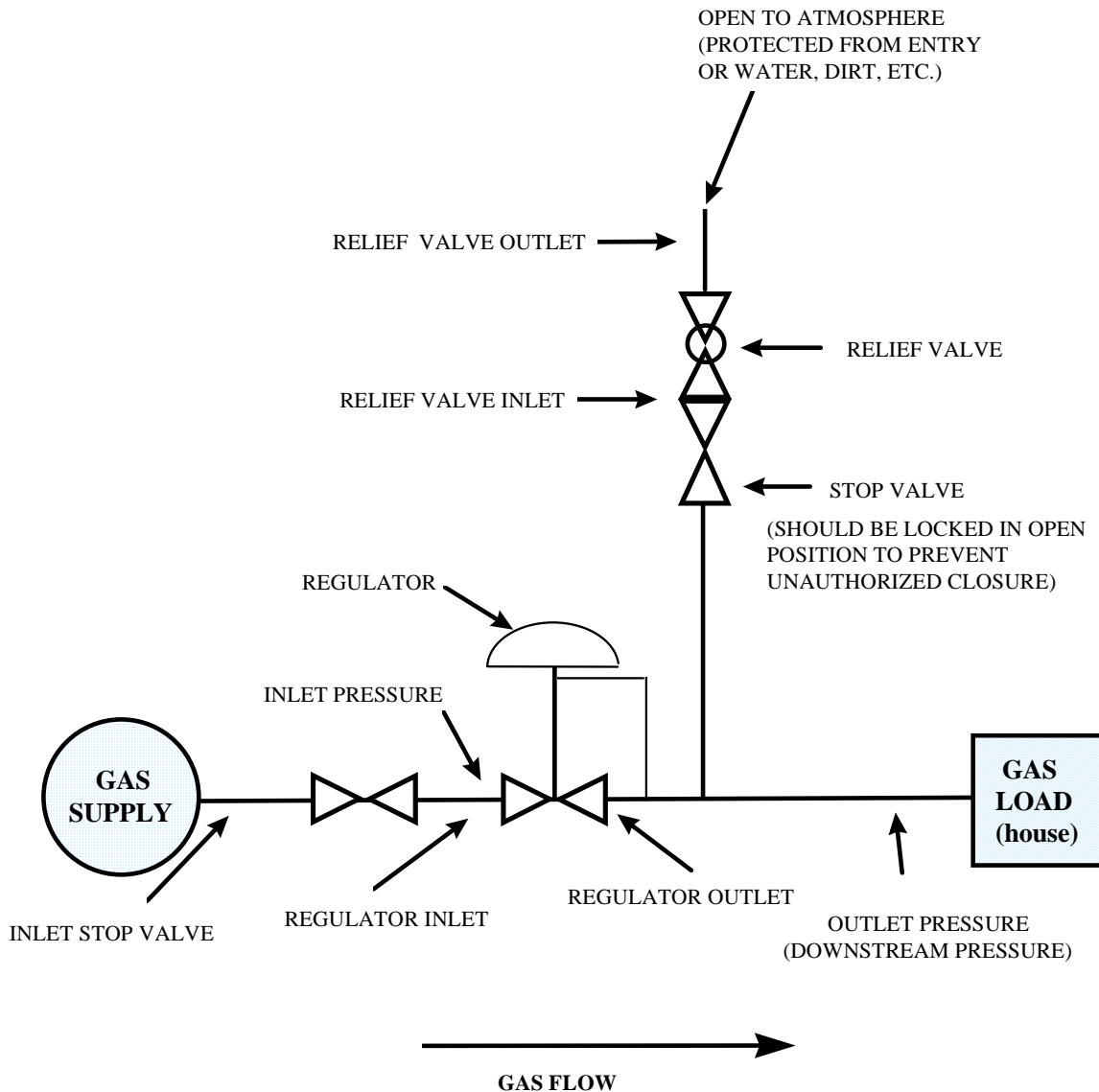
The most important of all is the inlet stop valve. The inlet stop valve should be used with extra care, particularly when being opened. Do not open it until everything is correct and safe. Then open it slowly. Allow the inlet gas to enter slowly, and the pressure to build up slowly. (Opening a valve too quickly has the possibility of damaging the regulator).

Stop valves make it possible to put a regulator into service or take it out of service. They make it possible to isolate a regulator for testing and servicing. Correct opening and closing sequences should be adequately understood (these are often specified in gas company standards and procedures). Understanding usage in case of an emergency is also important.

Pilot type regulators are used at city gate stations or for large industrial customers. These regulators are more complicated than self-activating regulators. A pilot is a device between the sensing element and the diaphragm that multiplies a small change in downstream pressure into a large change in pressure applied to the regulator diaphragm. These types of regulators will not be discussed in this manual. A consultant should be used to select the correct type and size regulator for most applications except for house regulators.

In most cases operators of small natural gas systems need to rely on a consultant for major repair work on regulator station. The operations and maintenance plan must name the person who is responsible for determining when a regulator needs to be serviced. The operations and maintenance plan should also list the consultant(s) who is capable of working on regulator stations.

Figure II-5 Regulator and Relief Valve



## OVERPRESSURE PROTECTION

---

Pressure regulators are very reliable devices, but sometimes pressure regulators malfunction. A pressure regulator can malfunction by closing when it should be open, resulting in customers downstream of the regulator not getting natural gas, which is not good, but generally will not damage the downstream gas piping or customer appliances. A regulator malfunction that opens the valve, however, can damage downstream piping and customer appliances that are not designed to handle the higher pressure. For this reason, regulations require that gate stations and district regulators must have overpressure protection.

There are three basic methods of providing overpressure protection:

- Pressure Relief,
- Monitor Regulating,
- Automatic Shutoff.

Pressure relief is simply dumping excess gas safely into the atmosphere. The excess gas is that which would cause pressure to exceed the safety limit. The relief valve is the most widely used piece of equipment in this category. However, liquid seals and rupture discs may also be used.

There are two basic kinds of relief valves – self-operated and pilot operated. The spring type relief valve is the most widely used. The pilot operated type is also frequently used, and it offers more precise operation. The pilot operated type is more frequently used as pressures become higher and capacities greater.

Monitor regulating involves a second, standby regulator. The standby regulator takes over in the event the primary regulator fails, preventing pressure from exceeding the safety limit.

The most widely used form of monitoring is operator-monitor system. It is also called passive monitoring. It consists of two regulators in series, one of which is operating to control pressure while the other is a standby. The standby unit is normally further open than necessary, usually wide open. It takes that position because it is adjusted to a slightly higher set point than the operating regulator. If an operating regulator failure causes outlet pressure to rise, the monitor takes over and holds pressure at its set point. This system does not require a relief valve.

Automatic shutoff involves a valve that normally remains in the wide open position and allows the gas to flow freely. It is located in series with the regulator, either upstream or downstream, depending on whether it uses a control line or internal control.

If a regulator failure results in a rising outlet pressure, the shutoff closes automatically when pressure reaches its set point. It protects by shutting off the gas and remains closed until manually opened and reset.

In general, there are three things to consider in choosing overpressure protection systems:

1. Continuity of service – does the user, the load, continue to be supplied with gas?
2. Containment – is gas released into the atmosphere or does it remain contained within the gas system?
3. Alerting – is there provision for notification or warning that an emergency has occurred and that the overpressure protection equipment has gone into operation?

The following is a comparison of the three basic overpressure protection methods (based on the foregoing three considerations):

#### Pressure Relief

- Continuity of Service. In general, pressure relief valves do not interrupt gas service. They protect, while allowing gas to flow at a safe pressure. Customers continue to receive gas.
- Containment. Relief valves do not contain the gas. They protect by dumping the excess gas into the atmosphere.
- Alerting. Relief valves are usually good in this respect. For one thing they are noisy, particularly at full or near full blow. In addition, because the gas is odorized, the smell usually attracts attention. Another indication of overpressure is the rise in outlet pressure above normal, but this is probably the least effective notification.

#### Monitor regulating

- Continuity of Service. Monitoring does not interrupt service. Like the relief valve, the monitor protects while allowing gas to continue to flow.
- Containment. Monitoring contains the gas. It prevents the gas from blowing into the atmosphere. It keeps it inside the piping.
- Alerting. This is probably the main disadvantage of monitoring. Generally speaking, the only warning or notification is the rise in outlet pressure to monitor set point.

#### Automatic Shutoff

- Continuity of Service. Automatic shutoff stops the flow of gas. It protects because it interrupts gas service by shutting off the gas.
- Containment. Automatic shutoff contains the gas. Like monitoring, it does not allow gas to blow into the atmosphere. It contains the gas within the piping.
- Alerting. In general, shutting the gas off results in good notification. Usually it is quickly noticed. However, there could be situations where it is not detected immediately and the intervening lack of gas has undesirable or even serious results.

The next sections cover the three basic methods of overpressure protection in more detail.

---

## PRESSURE RELIEF

---

Figure II-5 shows a typical relief valve installation. The purpose of the relief valve is to prevent outlet pressure from rising to an unsafe level when there is a regulator failure.

In general, regulator failure would result in either too much or too little pressure downstream. The failure would leave the regulator in what could be called a "failed-open" condition (regulator too far open, even fully open – too much gas flow) or a "failed-closed" condition (regulator too far closed, even fully closed – not enough gas flow). A relief valve is only useful in a "failed-open" regulator condition – too much gas flow, resulting in downstream pressure above normal. Relief valves do nothing for a "failed-closed" regulator condition – too little gas.

A relief valve protects by discharging the excess gas into the atmosphere. As long as a regulator operates correctly and downstream pressure is normal, a relief valve remains closed. If the regulator fails and allows too much gas to flow (a "failed-open" condition for the regulator), downstream pressure will increase. The relief valve will remain closed until pressure reaches its set point. At that point it will begin opening and will continue to do so as the pressure continues to rise. It will open far enough to discharge all of the excess gas into the atmosphere. When it reaches that point, there will be no further rise in the downstream pressure and, if the relief valve and its installation are correctly sized, the pressure downstream will not be high enough to be unsafe.

Keep in mind that the relief valve does not discharge all of the gas into the atmosphere. It only discharges the excess. There is still a normal flow for the load. Customers continue to get gas.

### **Relief Valve Sizing**

Sizing is vitally important. This applies not only to the relief valve itself, but also to the piping of the entire installation. A relief valve must be big enough to handle the maximum emergency. When properly installed and maintained, relief valves are very dependable. The question is not so much whether it will work, but rather whether it is large enough to provide full protection during a maximum emergency. When a relief valve is in full operation, it can discharge an enormous volume of gas into the atmosphere. For that reason, they cannot be used everywhere. This must be carefully considered when a relief valve installation is being planned and engineered. The vital questions are these: What happens to the gas after it leaves the relief valve? Will it disperse harmlessly? Or, could it create another emergency? This matter is addressed in 49 CFR §192.199(e).

Figure II-5 shows a stop valve just below the relief valve. This stop valve is required to allow the relief valve to be isolated for maintenance and testing. There can be serious consequences, however, if the stop valve is closed during normal operation because this would prevent the relief valve from relieving overpressure in the event of a regulator malfunction. Closure could be an innocent act or it could be malicious. Nonetheless, certain cautions are essential. Only authorized



personnel may close or open the stop valve. It must be adequately protected against unauthorized closure. Most important, it should be locked in an open position.

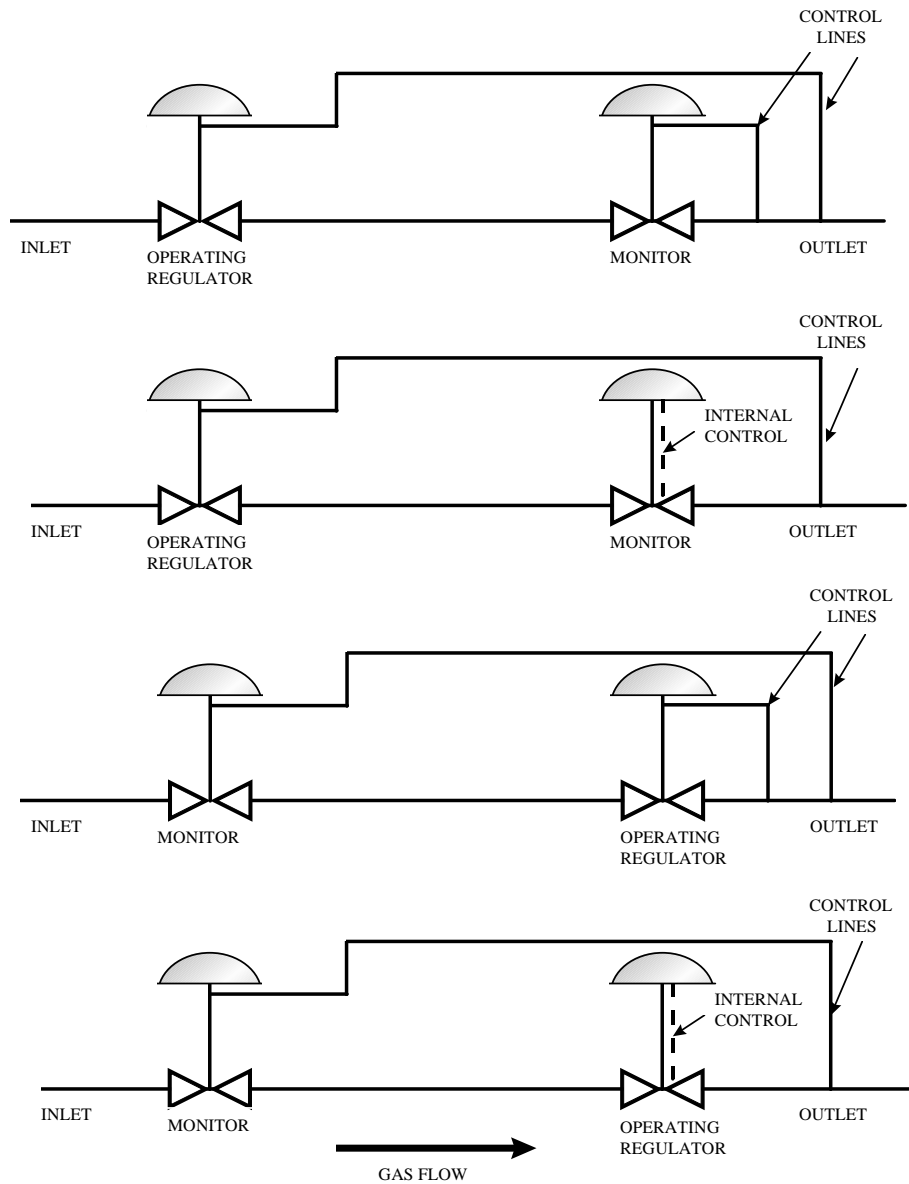
---

## MONITOR REGULATING

---

This section deals with the most widely used form of monitoring, standby or passive monitoring. Figure II-6 shows standby monitoring in four basic arrangements using regulators with control lines and with internal control.

Figure II-6 Standby Monitoring



Note the following:

- Either the upstream or the downstream regulator can be the monitor.
- The downstream regulator can have either a control line or internal control.
- The upstream regulator must have a control line.

Standby monitoring is sometimes confused with two-stage or double-cut regulation. The big difference is in the control line for the upstream regulator. In standby monitoring, the control line for the upstream regulator goes all the way downstream. It does not connect between the regulators as in two-stage regulation. To repeat, the control line for the upstream regulator in standby monitoring goes on beyond the downstream regulator to a point somewhere in the outlet piping. That is the reason the upstream regulator in standby monitoring must have a control line, whereas in two-stage regulation the upstream as well as the downstream regulator can have either a control line or internal control.

Two-stage regulation can be used as a form of monitoring provided the following conditions are met:

1. The system downstream of the second stage regulator (including the regulator) must have an MAOP equal to or greater than the outlet pressure of the first stage regulator.
2. The second stage regulator must be rated for an inlet pressure as high as the maximum inlet pressure to the first stage regulator, and the diaphragm case of the first stage regulator must be able to safely withstand this maximum inlet pressure.

The set point for the operating regulator is the normal outlet pressure, that is, the pressure normally required for the load.

The set point for the monitor is higher. Because it is higher, the monitor is further open than the operating regulator (usually the monitor is wide open) and allows the gas to flow normally.

If the operating regulator "fails-open" the outlet pressure will rise. When the outlet pressure reaches the set point of the monitor, the monitor will become the operating regulator and will hold outlet pressure at its set point.

The monitor set point, of course, must not exceed the Maximum Allowable Operating Pressure (MAOP) of the downstream piping system. The difference between the set points of the monitor and the operating regulator is not critical. However, the two should not be so close as to cause the monitor to interfere with the operating regulator. Other than this, monitor set point is largely determined by the requirements of the installation and applicable practices and standards.

---

## AUTOMATIC SHUTOFF

---

In an automatic shutoff installation, a special valve is used to shut off the gas completely if pressure reaches a preset level. During normal operation the valve remains fully open and allows gas to flow freely.

If a regulator failure ("failed-open") or another factor causes outlet pressure to rise, the automatic shutoff valve closes when pressure reaches its set point.

The normal outlet pressure is the regulator's set point. The set point of the automatic shutoff valve will, of course, be higher. How much higher must be decided when planning and engineering the installation. It must not exceed the MAOP (the maximum safe limit) of the downstream piping.

Automatic shutoff valves close automatically, but must be manually reset. This has the advantage of preventing an emergency from passing unnoticed.

Shutting the gas off at times of emergency is imperative. However, in the natural gas business, continuity of service is also important. This is probably why automatic shutoff has found only limited use in the gas industry. Pressure relief and monitoring are preferred because they offer full protection while allowing a safe flow of gas to continue.

Automatic shutoff valves are available with control line or with internal control. Both are shown in Figure II-7.

### **Control Line**

Because an automatic shutoff valve with a control line is located upstream of the regulator, the foregoing hazards from exposure to inlet pressure are eliminated. The entire regulator, as well as everything downstream, is isolated from exposure to inlet pressure.

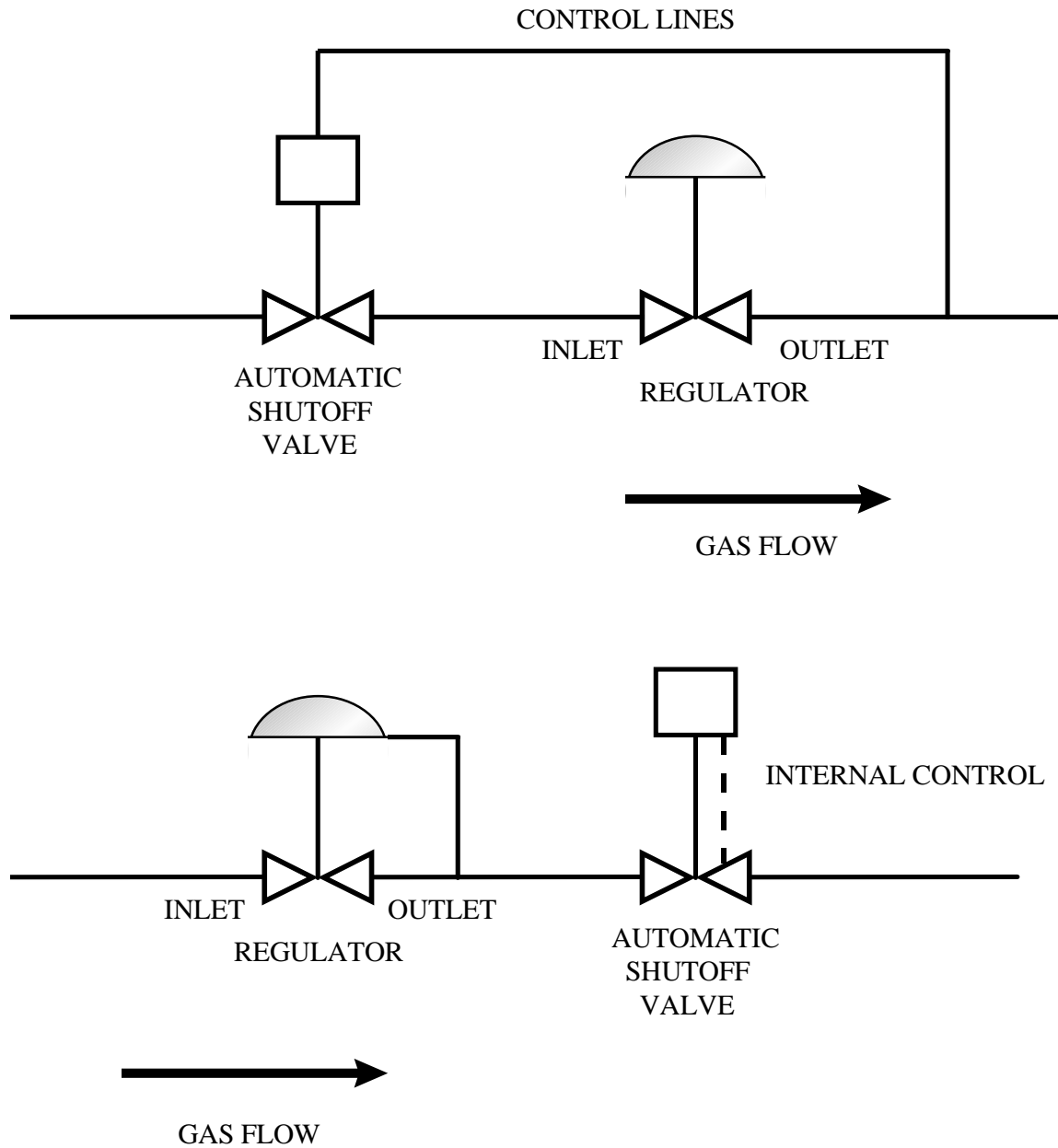
Care should be used in installing the control line. It should be strong, and be protected and routed to minimize any possibility of breakage. If broken, the automatic shutoff valve becomes inoperative. If an emergency occurs, it will not close, as it should.

Some automatic shutoff valves are available with a temperature option. They close not only from excess pressure, but also excess temperature. If properly located, they can help in case of fire. Automatic shutoff is also available for closure in case of under pressurization (a "failed-closed" regulator failure).

Relief valves, monitors, and automatic shutoff valves are all effective, dependable devices for protection against the hazard of excess pressure. However, to be sure of this protection, they must be correctly engineered, installed, and maintained. They must be used in conformance with

manufacturer's ratings and recommendations. Whenever any doubts or questions arise, it is always a good idea to ask the manufacturer.

Figure II-7 Automatic Shutoff Valve Installations



**Internal Control**

This offers a simpler installation because there is no control line. However, due to its internal control, it must be located downstream of the regulator. Therefore, upon closure, everything upstream of the shutoff valve will be pressured to full inlet pressure.

This means that if the regulator has internal control, its main diaphragm will be exposed to full inlet pressure. This could result in severe damage, even to the extent of a burst regulator. The same applies to a regulator with a control line if the control line is connected (the sensing point) between the regulator and the automatic shutoff valve. If an automatic shutoff valve with internal control is used, everything between it and the regulator, including the regulator itself, must be carefully checked for exposure to full maximum inlet pressure.

Moreover, if the piping for the regulator is larger than the inlet piping, an internal control type automatic shutoff valve will need to be a larger size than one with a control line.

## INSPECTION AND TESTING OF REGULATING AND RELIEF DEVICES

Regulating stations and relief devices must be inspected at least once each calendar year, not exceeding 15 months between inspections, to determine that they are:

- Protected from damage from outside forces (cars, trucks, falling objects, etc.);
- In good mechanical condition;
- Adequate in capacity and reliability of operation;
- Set to function at the correct pressure;
- Properly installed and protected from vehicular traffic, dirt, liquids, icing, and other conditions that might prevent proper operation.

A record of this annual inspection must be kept. Sample forms are in Appendix B (Forms 6 and 7). The operator must inspect visually, perform an operation check (stroke and lock up), and check the set pressure of the relief device and regulator. Problems may include:

- Low distribution system pressure;
- Unsatisfactory operating and maintenance history;
- Dirty or wet gas supply;
- Inoperative safety devices.

The operator may need technical help to solve these problems, especially if regulator disassembly or station redesign is necessary. DO NOT DISASSEMBLE REGULATORS WITHOUT THOROUGH TRAINING BY THE REGULATOR MANUFACTURER OR AN INDEPENDENT CONSULTANT.

The operator should always keep and use the manufacturers' manuals, diagrams and maintenance procedures for each type of regulator used in the system.

Inspections should address the following:

- Capacity must be verified by in place testing or verification of relief sizing calculations. If the relief device has insufficient capacity, the operator must replace it.
- Relief capacity must be checked for each separately controlled section of the natural gas system. The operator must ensure that the MAOP will not be exceeded at any point

downstream of the regulator station if the worst condition occurred - that is, if the regulator fails when fully opened. Most small systems have only one MAOP for all piping in the distribution system.

See 49 CFR §192.739 and §192.743 for further information.

To comply with this requirement, many operators of small systems have a consultant analyze their gas system and make the required relief valve capacity calculations. If the analysis proves that the relief valve has adequate capacity, the operator must keep a copy of this calculation on file. If there have been no changes to upstream regulators, such as different pressure, orifice, or type of regulator and no major reduction in load assumed in the calculation, the calculation of capacity need only be reviewed (and initialed) on an annual basis. If a change is made, the new relief valve capacity calculations must be made and kept on file. It is a good idea to keep this capacity calculation with the annual inspection record. Sample forms are in APPENDIX B (FORM 7).

## CHAPTER III: CORROSION CONTROL

---

### FEDERAL REQUIREMENTS

---

This chapter contains a simplified description of the corrosion control requirements contained in the pipeline safety regulations. The complete text of the corrosion control requirements can be found in 49 CFR Part 192.

NOTE: This chapter begins with a review of federal requirements. Readers with little or no experience in corrosion or cathodic protection may find it helpful to read the “Fundamentals of Corrosion” and “Principles and Practices of Cathodic Protection” sections of this Chapter before reading this section on federal requirements. In addition, an internet search for keyword “corrosion” will find several websites that discuss the basics of corrosion and corrosion control.

### PROCEDURES AND QUALIFICATIONS

---

Operators must establish procedures to implement and maintain a corrosion control program for their piping system. These procedures should include design, installation, operation and maintenance of a cathodic protection system. A person qualified in pipeline corrosion control methods must carry out these procedures.

### TECHNIQUES FOR COMPLIANCE

---

If the operator chooses to use a corrosion consultant, it is important to utilize one who is experienced with natural gas piping and the requirements of 49 CFR Part 192. The following is a list of sources where operators of small natural gas systems can find qualified personnel to develop and carry out a corrosion control program:

- There are many consultants and experts who specialize in cathodic protection. Many advertise in gas trade journals. A keyword search using an internet search engine may also provide references.
- Another source, especially for master meter operators, is an experienced corrosion engineer or technician working for a local gas utility company. Such experts may be able to implement cathodic protection for small operators, or refer them to local qualified corrosion control personnel.
- Operators of small municipal systems can contact the transmission company that supplies their gas. A municipal corrosion engineer or technician may be able to supply information as to where to find local qualified corrosion control personnel.
- Operators of small natural gas systems may encourage their respective trade associations (such as state and local mobile home associations or municipal associations) to gather and maintain records of available corrosion consultants or contractors who are qualified in their specific region.



- The local chapter of “NACE International” (National Association of Corrosion Engineers) may be able to provide useful information.
- Operators who are unsure of a consultant’s qualification in corrosion control should request references from the consultant and contact gas pipeline operators who have hired the consultant in the past. Ask if the consultant is NACE-certified or equivalent.

---

### CORROSION CONTROL REQUIREMENTS FOR PIPELINES INSTALLED AFTER JULY 31, 1971

---

All buried metallic pipe installed after July 31, 1971, must be properly coated and have a cathodic protection system designed to protect the pipe in its entirety.

Newly constructed metallic pipelines must be coated before installation and must have a cathodic protection system. While the regulations require that cathodic protection system be installed and placed in operation in its entirety within one year after construction of the pipeline, it is recommended that it be installed and operating as soon as possible. However, if the operator can demonstrate by tests, investigation, or experience in the area of application, including, as a minimum, soil resistivity measurements and tests for corrosion accelerating bacteria, that a corrosive environment does not exist, a very rare situation, no cathodic protection is required. OPS recommends that all operators of small natural gas systems coat and cathodically protect all new metallic pipe. It is extremely difficult and costly to prove that a noncorrosive environment exists.

Cathodic protection requirements do not apply to electrically isolated, metal alloy fittings in plastic pipelines if the metal alloy used for the fitting provides corrosion control and if corrosion pitting will not cause leakage.

---

### CORROSION CONTROL REQUIREMENTS FOR PIPELINES INSTALLED BEFORE AUGUST 1, 1971

---

Metallic pipelines installed before August 1, 1971, (bare pipe or coated pipe), must be cathodically protected in areas that are determined to be experiencing active corrosion. All underground natural gas distribution systems, including underground piping related to regulating and measuring stations, must be cathodically protected in areas of active corrosion.

The operator must determine areas of active corrosion by (a) electrical survey, (b) where electrical survey is impractical, by the study of corrosion and leak history records, or (c) by leak detection surveys. Active corrosion means continuing corrosion, which, unless controlled, could result in a condition that is detrimental to public safety.

As a guideline for operators when determining corrosion to be detrimental to public safety (active corrosion), OPS recommends the following:

- For master meter operators and small municipal gas systems, all continuing corrosion occurring on metallic pipes (other than cast iron or ductile iron pipes) should be considered active and pipes should be cathodically protected, repaired, or replaced.

- OPS recommends that operators of small gas systems and their consultants use the following guidelines in determining where it is impractical to do electrical surveys to find areas of active corrosion where:
  1. The pipeline is covered by concrete or paving and is more than 2 feet from the edge of a paved street or within wall to wall pavement areas.
  2. The pipelines in a common trench with other metallic structures.
  3. Stray earth gradient currents exist (due to telluric currents, iron ore deposits, a.c. induction, and other sources).
  4. There is lack of electrical continuity of the gas facility.
  5. Pavement and congestion prevents ready access to the soil around the pipe.
  6. Facilities are not electrically isolated, are often in direct contact with other metallic structures or in indirect contact.
  7. Current may be shielded by nearby objects close to the pipeline.
  8. Current can be picked up by nearby conducting elements such as casings, parallel or crossing lines, scrap metal, or other foreign objects.
  9. Insufficient history and details of facilities exist.
  10. There is extremely dry soil.
  11. There are adjacent underground facilities.

In areas where electrical surveys cannot be used to determine corrosion, the operator should perform leakage surveys on a more frequent basis. Although the regulations require the survey at least every 3 years, OPS recommends that these surveys be run at least once a year.

Electrical surveys to find active corrosion must be performed by a person qualified in pipeline corrosion control methods.

---

### COATING REQUIREMENTS

---

All metallic pipe installed below ground, as a new or replacement pipeline system, should be coated in its entirety (APPENDIX B, FORM 1). Types of coatings and handling practices are discussed later in this chapter. For aboveground metallic pipe, see “Atmospheric Corrosion” below.

---

### EXAMINATION OF EXPOSED PIPE

---

Whenever buried pipe is exposed or dug up, the operator is required to examine the exposed portion of the pipe for evidence of corrosion on bare pipe or for deterioration of the coating on coated pipe. A record of this examination must be maintained. If the coating has deteriorated or the bare pipe has evidence of corrosion, remedial action must be taken. The excavation must be widened to expose more pipe to determine if that pipe also requires remedial action. The operator must continue to expose pipe until pipe not requiring remedial action is uncovered. (APPENDIX B, FORM 1).

---

## CRITERIA FOR CATHODIC PROTECTION

---

Operators must meet one of five criteria listed in Appendix D of 49 CFR Part 192, to comply with the pipeline safety regulations for cathodic protection. This is discussed later in this chapter.

---

## MONITORING

---

A piping system that is under cathodic protection must be monitored. Tests for effectiveness of cathodic protection must be performed at least once every year, not to exceed 15 months between tests. Records of this monitoring must be maintained (APPENDIX B, FORM 14).

Short, separately protected service lines or short, protected mains (not over 100 feet in length) may be surveyed on a sampling basis. At least 10 percent of these short sections and services must be checked each year so that all short sections in the system are tested in a 10-year period. Examples of short, separately protected pipe in a small natural gas system would be:

- Steel service lines connected to, but electrically isolated from, cast iron mains.
- Steel service risers that have cathodic protection provided by an anode attached to a riser that is installed on plastic service lines.

OPS recommends, if a small number of isolated protection sections of pipeline exist in the system, that the operator include all sections in the annual survey. If there are a considerable number, they can be sampled at a rate of 10% per year, but this 10% sample must be distributed all over the system.

When using rectifiers to provide cathodic protection, each rectifier must be inspected six times every year to ensure that the rectifier(s) is properly operating. The interval between inspections must not exceed 2½ months. Records of these inspections must be maintained (APPENDIX B, FORM 15).

Operators must take prompt action to correct any deficiencies indicated by the monitoring.

---

## ELECTRICAL ISOLATION

---

Pipelines must be electrically isolated from other underground metallic structures (unless electrically interconnected and cathodically protected as a single unit). For illustrations of where meter sets are commonly electrically insulated, see FIGURES 8, 13 and 14 in this chapter.

---

## TEST POINTS

---

Each pipeline under cathodic protection must have sufficient test points for electrical measurement to determine the adequacy of cathodic protection. Test points should be shown on a cathodic protection system map. Some typical test point locations include the following.

- (a) Meter risers,
- (b) Pipe casing installations,
- (c) Foreign metallic structure crossings,

- (d) Insulating joints,
- (e) Road crossings.

---

### INTERNAL CORROSION INSPECTION

---

Whenever a section of pipe is removed from the system, the internal surface must be inspected for evidence of corrosion. Remedial steps must be taken if internal corrosion is found. Adjacent pipe must be inspected to determine the extent of internal corrosion. Records of these inspections must be maintained (APPENDIX B, FORM 1).

---

### ATMOSPHERIC CORROSION

---

Newly installed aboveground pipelines must be cleaned and coated or jacketed with a material suitable to prevent atmospheric corrosion. Aboveground pipe, including meters, regulators and measuring stations, must be inspected for atmospheric corrosion at least once every three years, not to exceed 39 months between inspections. Remedial action must be taken if atmospheric corrosion is found. Records of these inspections must be maintained (APPENDIX B, FORM 13).

---

### REMEDIAL MEASURES

---

All steel pipe used to replace an existing pipe must be coated and cathodically protected. Each segment of pipe that is repaired because of corrosion leaks must be cathodically protected. The new segment should be insulated from any of the existing pipe that will not also be cathodically-protected.

---

### GRAPHITIZATION OF CAST IRON

---

Cast iron is an alloy of iron and carbon (graphite). Graphitization is the process by which the iron in cast iron pipe corrodes, leaving a brittle sponge-like structure of graphite flakes. There may be no appearance of damage, but the affected area of the pipe becomes brittle. For example, a completely graphitized buried cast iron pipe may hold gas under pressure but will fracture under a minor impact, such as being hit by a workman's shovel.

Each segment of cast iron or ductile iron pipe with graphitization (to a degree where a fracture or any leakage might result) must be replaced with steel or plastic and may not be replaced with cast, wrought, or ductile iron. Among other factors, pipeline age and material are significant risk indicators. Pipelines constructed of cast and wrought iron, as well as bare steel, are among those pipelines that pose the highest-risk to safety and should be considered for replacement.

---

### RECORDS

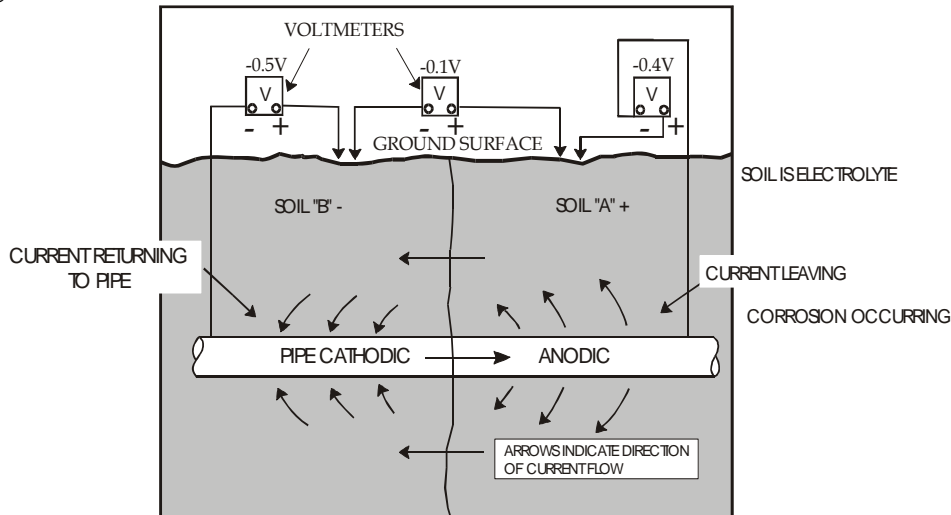
---

Operators must maintain records or maps of their cathodic protection system. Records of all tests, surveys, or inspections required by the pipeline safety code must be maintained. See APPENDIX B for samples of records/forms.

## FUNDAMENTALS OF CORROSION

Corrosion is the deterioration of metal pipe caused by a reaction between the metallic pipe and its surroundings. As a result, the pipe deteriorates and may eventually leak. In order for corrosion to occur there must be four parts: An electrolyte, anode, cathode, and a metallic return path. A metal will corrode at the point where current leaves the anode (see FIGURE III-1). NOTE: Some soils may create an environment that enhances corrosion.

Figure III-1: Corrosion Cell



A corrosion cell may be described as follows:

- Electrical current flows through the soil (electrolyte) from the anode to the cathode. It returns to the anode through the return circuit (the pipe).
- Corrosion occurs wherever current leaves the metal (pipe, fitting, etc.) and enters the soil. The area where current leaves the pipe is said to be anodic. Corrosion, therefore, occurs in the anodic area.
- Current returns to the pipe at the cathode. No corrosion occurs here. The cathode is protected against corrosion.
- The flow of current is caused by a potential (voltage) difference between the anode and the cathode.

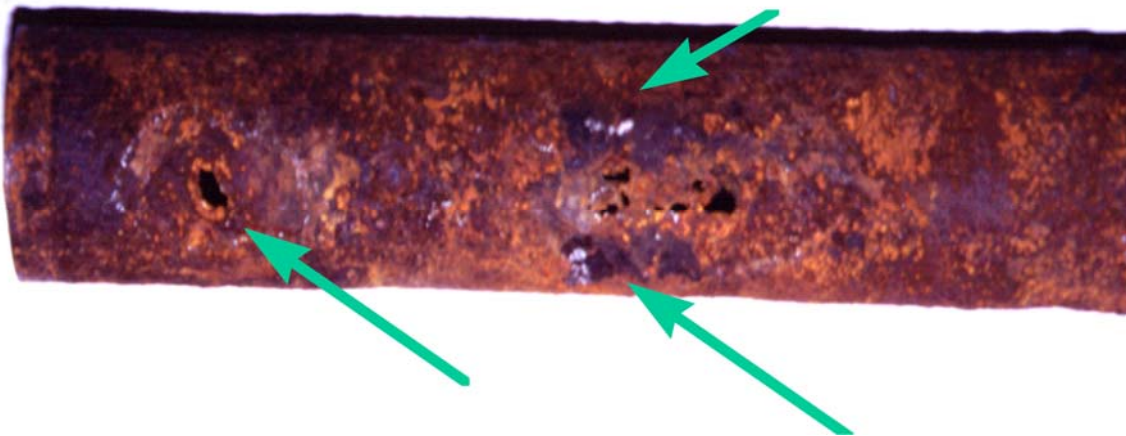
## PRINCIPLES AND PRACTICES OF CATHODIC PROTECTION

---

This section gives operators with little or no experience in cathodic protection a review of the general principles and practices of cathodic protection. Common causes of corrosion, types of pipe coatings, and criteria for cathodic protection are among the topics. A checklist of steps which an operator of a small natural gas system may use to determine the need for cathodic protection is included. Basic definitions and illustrations are used to clarify the subject. This section does not go into great depth. Therefore, reading this section alone will not qualify an operator to design and implement cathodic protection systems or programs.

Although corrosion cannot be totally eliminated, it can be substantially reduced with cathodic protection (see FIGURE III-2).

Figure III-2 Bare Pipe - not under cathodic protection

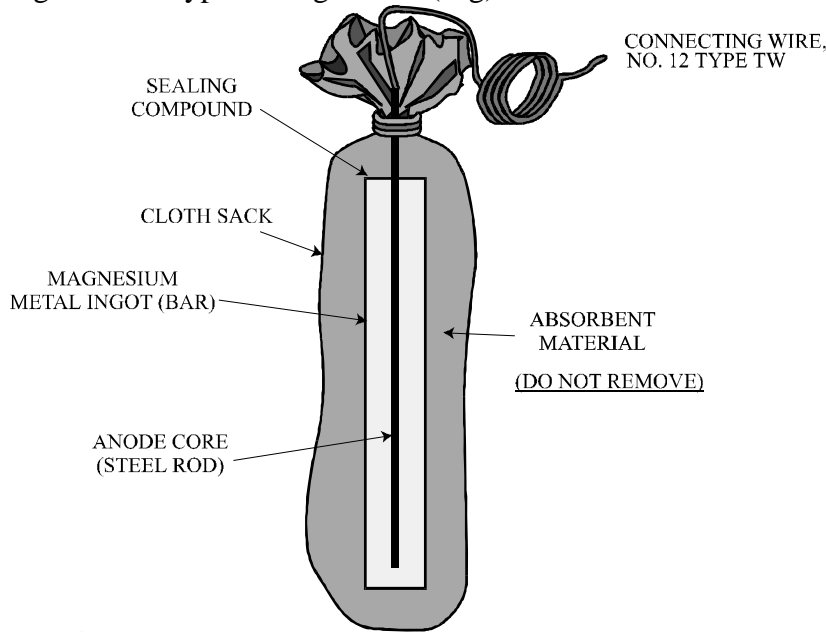


An example of bare steel pipe installed for gas service. Note that deep corrosion pits have formed. Operators should never install bare steel pipe underground. For both new and replacement pipe operators should use either polyethylene pipe manufactured according to ASTM standard D2513 or steel pipe that is coated and cathodically protected.

**Cathodic protection** is a process that protects an underground metallic pipe against corrosion. An electrical current is impressed onto the pipe by means of a sacrificial anode or a rectifier. Corrosion will be reduced where sufficient current flows onto the pipe.

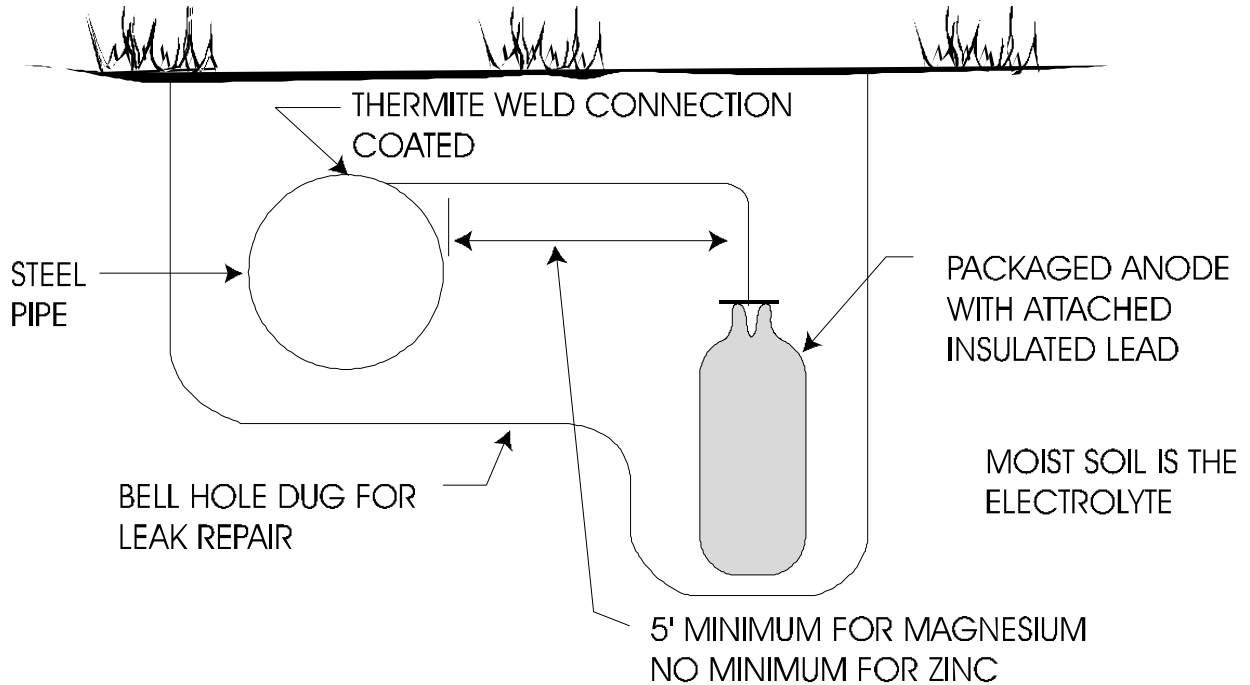
**Anode (sacrificial)** is an assembly consisting of a bag usually containing a magnesium or zinc ingot and other chemicals, which is connected by wire to an underground metal piping system. It functions as a battery that impresses a direct current on the piping system to retard corrosion (see FIGURE III-3).

Figure III-3 Typical Magnesium (Mg) Anode



**Sacrificial protection** means the reduction of corrosion of a metal (usually steel in a gas system) in an electrolyte (soil) by galvanically coupling the metal (steel) to a more anodic metal (magnesium or zinc) (see FIGURE III-4). The magnesium or zinc will sacrifice itself (corrode) to retard corrosion in steel the pipe.

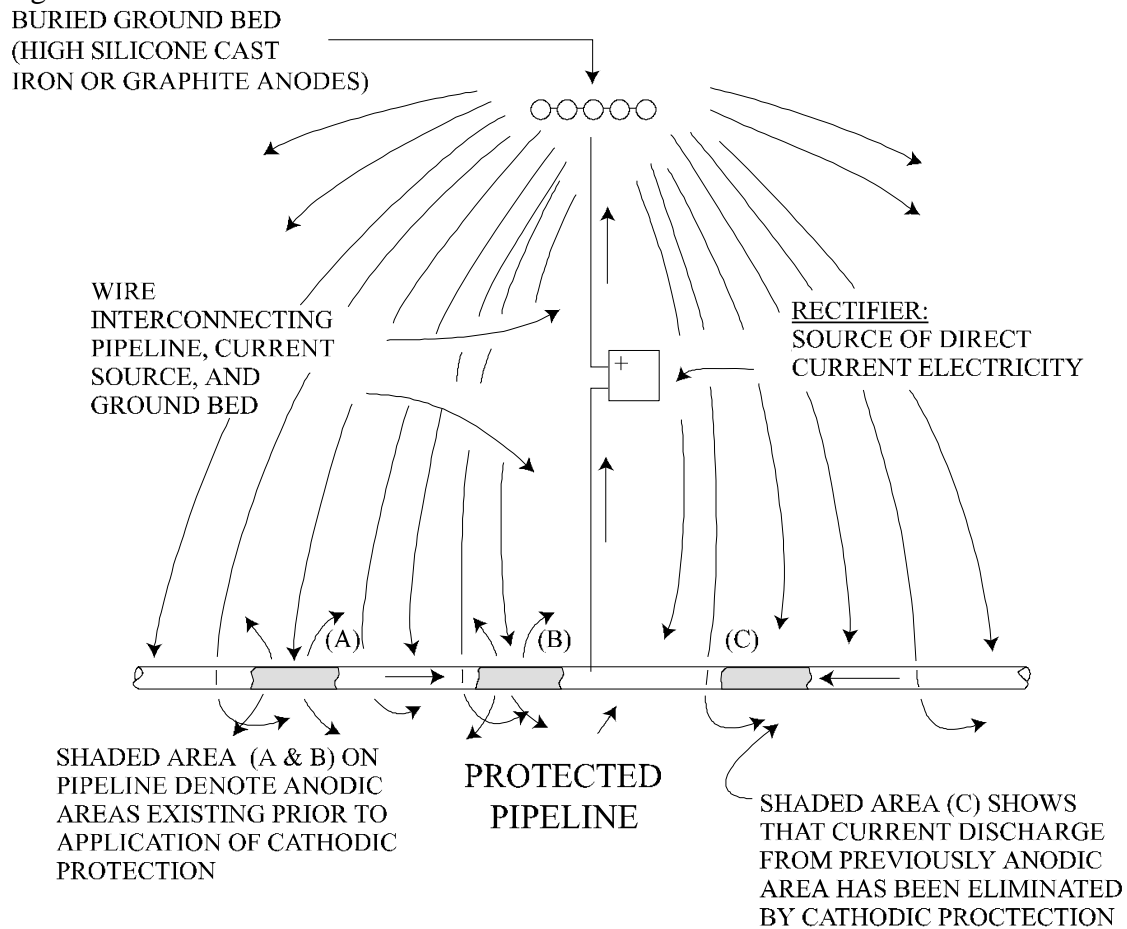
Figure III-4



Zinc and magnesium are more anodic than steel. Therefore, they will corrode to provide cathodic protection for steel pipe.

**Rectifier** is an electrical device that changes alternating current (a.c.) into direct current (d.c.). This current is then impressed on an underground metallic piping system to protect it against corrosion (see FIGURE III-5).

Figure III-5

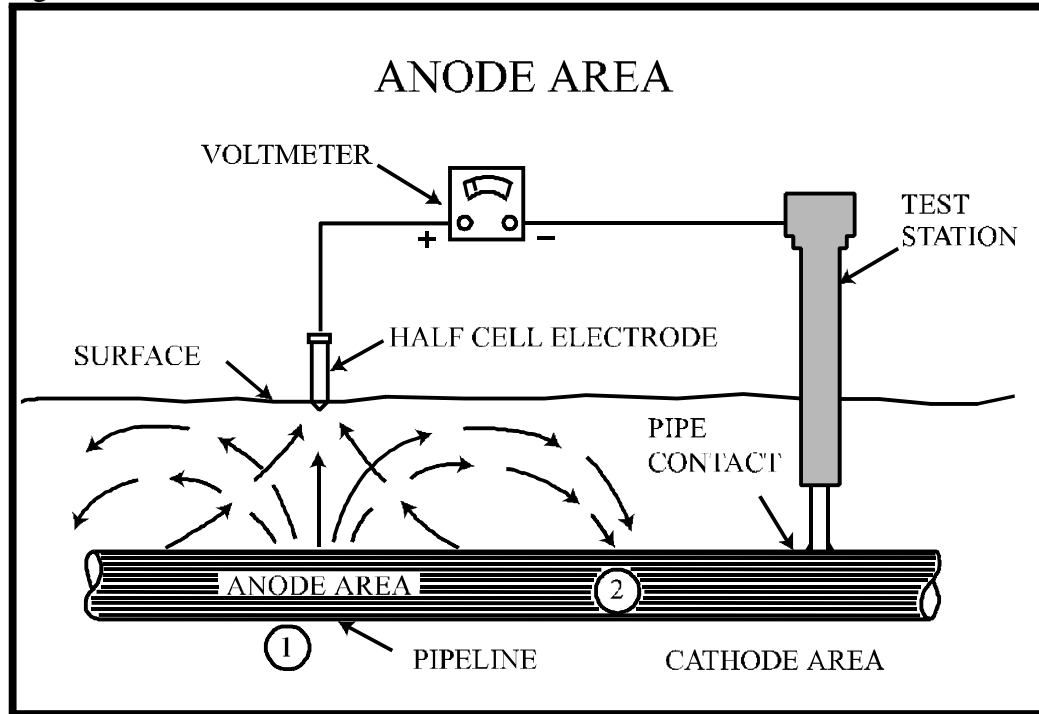


This illustrates how cathodic protection can be achieved by use of a rectifier. Make certain the negative terminal of the rectifier is connected to the pipe. **NOTE:** If the reverse occurs (positive terminal to pipe), the pipe will corrode much faster.



**Potential** means the difference in voltage between two points of measurement (see FIGURE III-6).

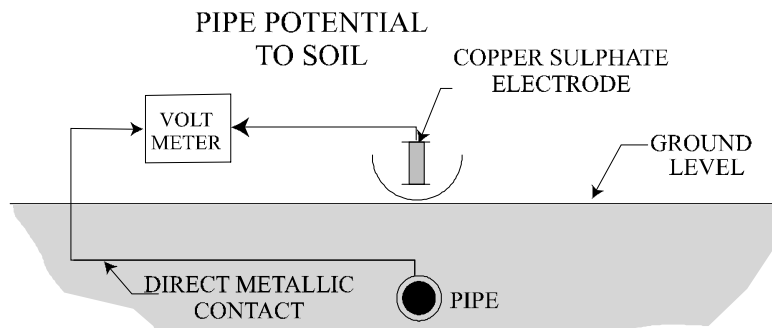
Figure III-6



The voltage potential in this example is the difference between points 1 and 2. Therefore, the current flow is from the anodic area (1) of the pipe to the cathodic area (2). The half-cell is an electrode made up of copper immersed in copper-copper sulfate ( $\text{Cu-CuSO}_4$ ).

**Pipe-to-soil potential** is the potential difference (voltage reading) between a buried metallic structure (piping system) and the soil surface. The difference is measured with a half-cell reference electrode (see definition of reference electrode that follows) in contact with the soil (see FIGURE III-7).

Figure III-7

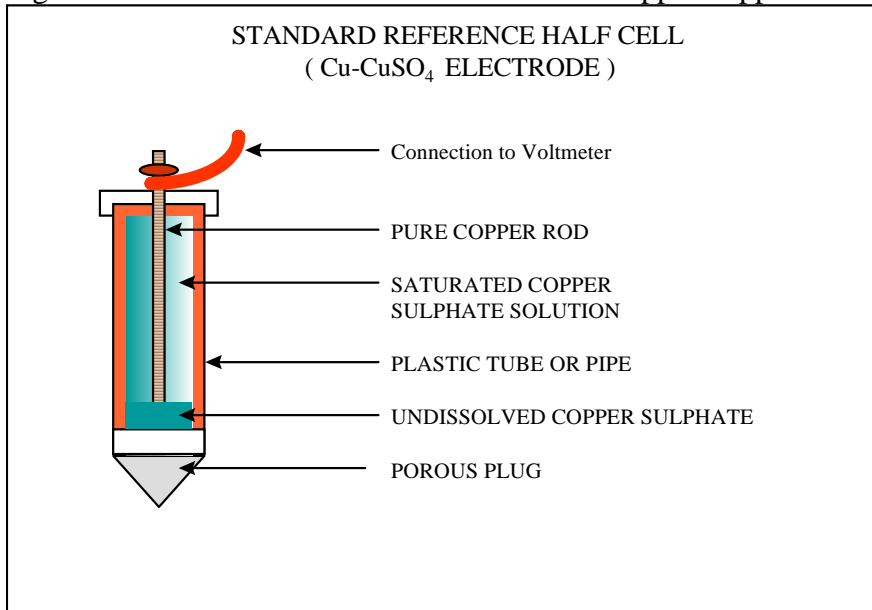


1. INVESTIGATE CORROSIVE CONDITIONS.
2. EVALUATE THE EXTENT OF CATHODIC PROTECTION

If the voltmeter reads at least  $-0.85$  volt, the operator can usually consider that the steel pipe has cathodic protection. **NOTE:** Be sure to take into consideration the voltage (IR).

**Reference electrode (commonly called a half-cell)** is a device which usually has copper immersed in a copper sulfate solution. The open circuit potential is constant under similar conditions of measurement (see FIGURE III-8).

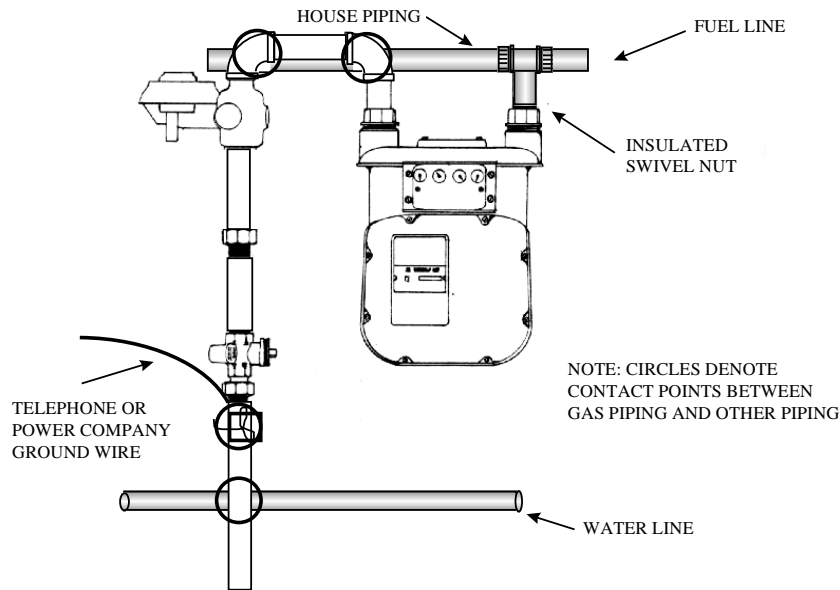
Figure III-8 Reference Electrode – A saturated copper-copper sulfate half-cell.



(Caution Copper-Copper Sulfate is Poisonous)

**Short or corrosion fault** means an unintended contact between a cathodically protected section of a piping system and other metallic structures (water pipes, buried tanks, or unprotected section of a gas piping system) (see FIGURE III-9). Shorts can divert cathodic protection current off of the gas piping and onto these other metallic structures, which can result in inadequate cathodic protection on the gas pipe and premature wearing out of sacrificial anodes.

Figure III-9 Typical Meter Installation Accidental Contacts  
(Meter Insulator Shorted Out by House Piping, etc.)



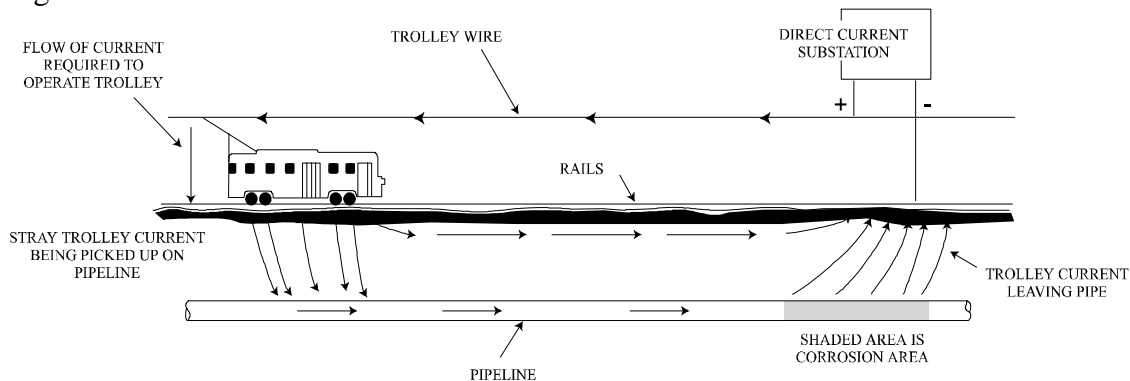
Unshaded piping shows operator's piping from service entry to meter insulator at location shown on sketch above. Shaded areas show house piping, electrical cables, etc.

The circled locations are typical points where the Operators piping (unshaded) can come in contact with house piping. This causes shorting out or "bypassing" of the meter insulator.

The only way to clear these contacts permanently is to move the piping that is in contact. (The use of wedges, etc., to separate the piping is not acceptable). If the aboveground piping cannot be moved, install a new insulator between the accidental contact and the service entry.

**Stray current** means current flowing through paths other than the intended circuit (see FIGURE III-10). If your pipe-to-soil readings fluctuate, stray current may be present.

Figure III-10




This drawing illustrates an example of stray d.c. current getting onto a pipeline from an outside source. This can cause severe corrosion in the area where the current eventually leaves the pipe. Expert help is needed to correct this type of problem.

**Stray current corrosion** means metal destruction or deterioration caused primarily by stray d.c. affecting the pipeline.

**Galvanic series** is a list of metals and alloys arranged according to their relative potentials in a given environment (see Table 1).

**Galvanic corrosion** occurs when any two of the metals in TABLE 1 (next page) are connected in an electrolyte (soil). Galvanic corrosion is caused by the different potentials of the two metals.

Table 1: Galvanic Series

METAL	POTENTIAL (VOLTS)		
Commercially pure magnesium	-1.75	<div style="display: flex; align-items: center; justify-content: center;"> <span style="margin-right: 10px;">Anodic</span>  </div>	
Magnesium alloy (6% Al, 3% Zn, 0.15% Mn)	-1.6		
Zinc	-1.1		
Aluminum alloy (5% zinc)	-1.05		
Commercially pure aluminum	-0.8		
Mild steel (clean and shiny)	-0.5 to -0.8		
Mild steel (rusty)	-0.2 to -0.5		
Cast iron (not graphitized)	-0.5		
Lead	-0.5		
Mild steel in concrete	-0.2		
Copper, brass, bronze	-0.2		
High silicon cast iron	-0.2		
Mill scale on steel	-0.2		
Carbon, graphite, coke	+0.3		Cathodic

\* Typical potential in natural soils and water, measured with respect to a copper-copper sulfate reference electrode.

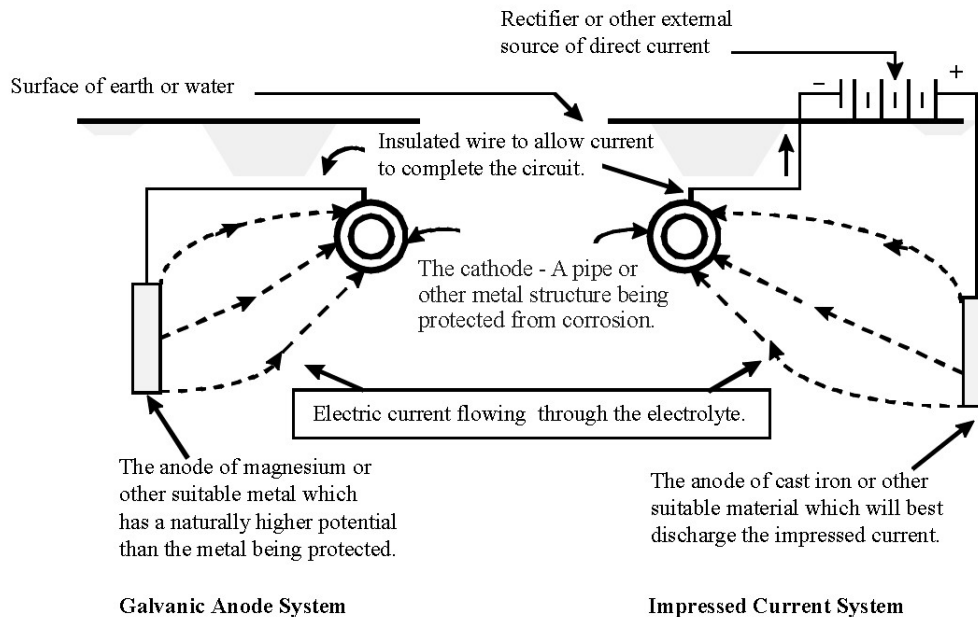
When electrically connected in an electrolyte, any metal in the table will be anodic (corrode relative to) to any metal below it. That is, the more anodic metal sacrifices itself to protect the metal (pipe) lower in the table.)

## TYPES OF CATHODIC PROTECTION

There are two basic methods of cathodic protection: the galvanic (sacrificial) anode system and the impressed current (rectifier) system.

The preferred method of cathodic protection, when its application is reasonable, is an impressed current system. In other cases, galvanic anodes are used to provide cathodic protection on gas distribution systems. (see FIGURE III-11).

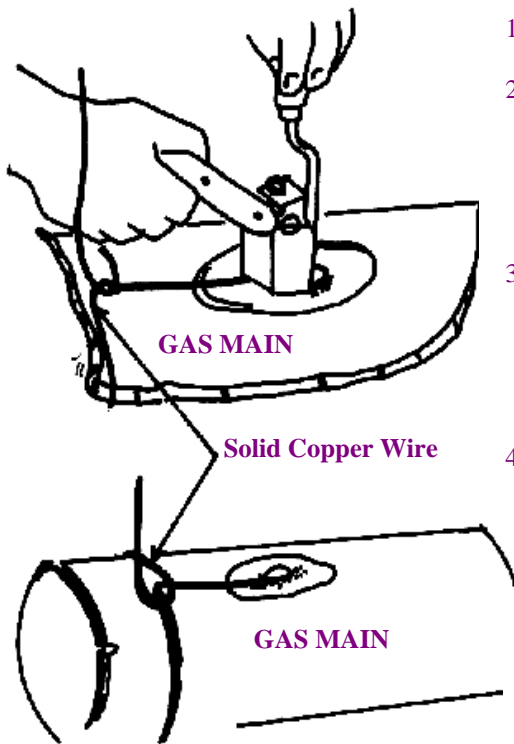
Figure III-11



Any current that leaves the pipeline causes corrosion. In general, corrosion control is obtained as follows:

Galvanic Anode System. Anodes are "sized" to meet current requirements of the resistivity of the environment (soil). The surface area of the buried steel and estimated anode life determines the size and number of anodes required. Anodes are made of materials such as magnesium (Mg), zinc (Zn), or aluminum (Al). They are usually installed near the pipe and connected to the pipe with an insulated wire. They are sacrificed (corroded) instead of the pipe (see FIGURES III-4, III-11, AND III-12).

Figure III-12 Typical Procedure For Installing A Magnesium Anode By The Thermo-Weld Process



1. Loop wire as shown to avoid strain on bond.
2. Insert conductor in mold-do not push end of conductor past center of tap hole. Drop metal disc over tap hole. Remove all starting power from cartridge by tapping the inverted cartridge on lip of mold.
3. Close cover, hold mold steady. Ignite starting power with flint gun as shown. When powder fires, remove gun immediately. Hold mold steady for 10 seconds. Remove slag from weld.
4. See the manufacturer's recommendation before proceeding.

After welding, all exposed pipe should be well coated and wrapped.

Impressed Current Systems. Anodes are connected to a direct current source, such as a rectifier or generator. The principle is the same except that the anodes are made of materials such as graphite, high silicon cast iron, lead-silver alloy, platinum, or scrap steel and the cathodic protection voltage and current is provided by the rectifier or generator rather than the difference in potential between the pipe and the anode.

### INITIAL STEPS IN DETERMINING THE NEED TO CATHODICALLY PROTECT A SMALL GAS DISTRIBUTION SYSTEM

1. Determine type(s) of pipe in system: bare steel, coated steel, cast iron, plastic, galvanized steel, ductile iron, or other.
2. Determine the date the gas system was installed (steel pipe installed after July 1, 1971, must be cathodically protected in its entirety).  
Who installed pipe? By contacting the contractor and other operators who had pipe installed by same contractor, operators may be able to obtain valuable information, such as:
  - Type of pipe in ground.
  - If pipe is electrically isolated.
  - If gas pipe is in common trench with other utilities.
3. Pipe location - map/drawing. Locate old construction drawings or current system maps. Even if drawings are available, a metallic pipe locator should be used.
4. Before the corrosion consultant arrives, it is a good idea to make sure that customer meters are electrically insulated. If system has no meter, check to see if gas pipe is electrically insulated from house or mobile home pipe (see Figure III-13).

5. Contact a corrosion consultant or consulting firm that is experienced in gas pipelines and the requirements of 49 CFR Part 192. Try to complete steps 1 through 4 before contracting a consultant.
6. Use of Consultant -- A sample method, which may be used by a consultant to determine cathodic protection needs, is provided below:
  - An initial pipe-to-soil reading will be taken to determine whether the system is under cathodic protection.
  - If the system is not under cathodic protection, the consultant should clear underground shorts or any missed meter shorts (see below for a discussion of testing insulation).
  - After the shorts are cleared, another pipe-to-soil test should be taken. If the system is not under cathodic protection, a current requirement test should be run to determine how much electrical current is needed to protect the system.
  - Additional tests, such as a soil resistivity test, bar hole examination, and other electrical tests, may be needed. The types of tests needed will vary for each gas system.Remember to retain copies of all tests run by the corrosion consultant.
7. Cathodic Protection Design -- The experienced corrosion consultant, will design a cathodic protection system based on the results of testing, that best suits the gas piping system.

Figure III-13: Places where a meter installation may be electrically isolated.

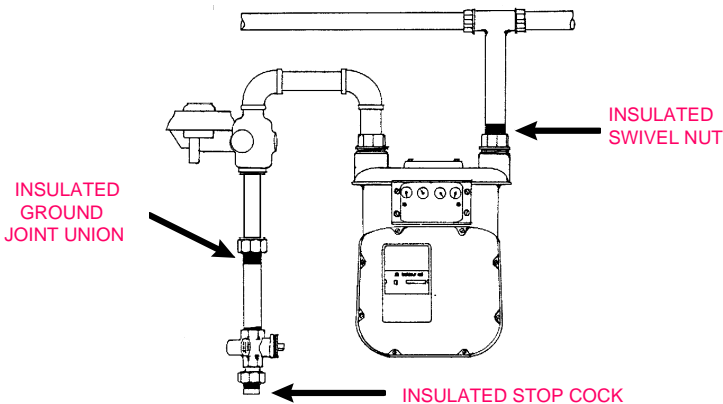


Figure III-14

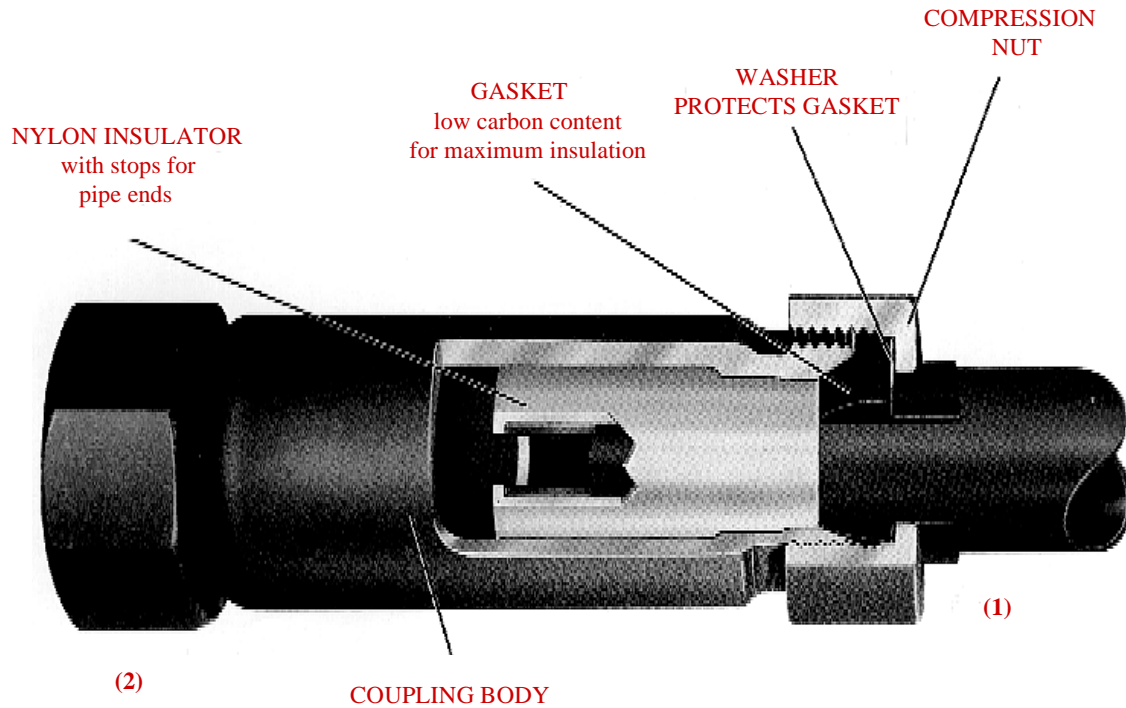
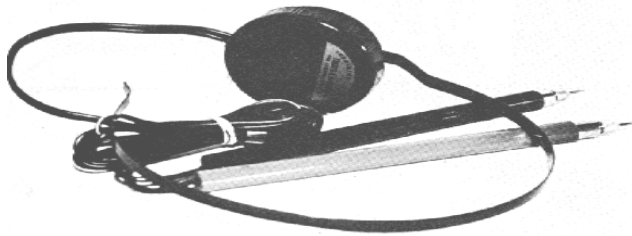


Illustration of an insulated compression coupling used on meter sets to protect against corrosion. Pipe connection by this union will be electrically insulated between the piping located on side one (1) and the piping located on side two (2).

Figure III-15: Insulation Tester



This insulation tester consists of a magnetic transducer mounted in a single earphone headset with connecting needlepoint contact probes. It is a "go" or "no go" type tester which operates from low voltage current present on all underground piping systems, thus eliminating the necessity of outside power sources or costly instrumentation and complex connections. By placing the test probes on the metallic surface on either side of the insulator a distinct audible tone will be heard if the insulator is performing properly. The absence of an audible tone indicates a faulty insulator. Insulator effectiveness can be determined quickly using this simple, easy-to-operate tester.



---

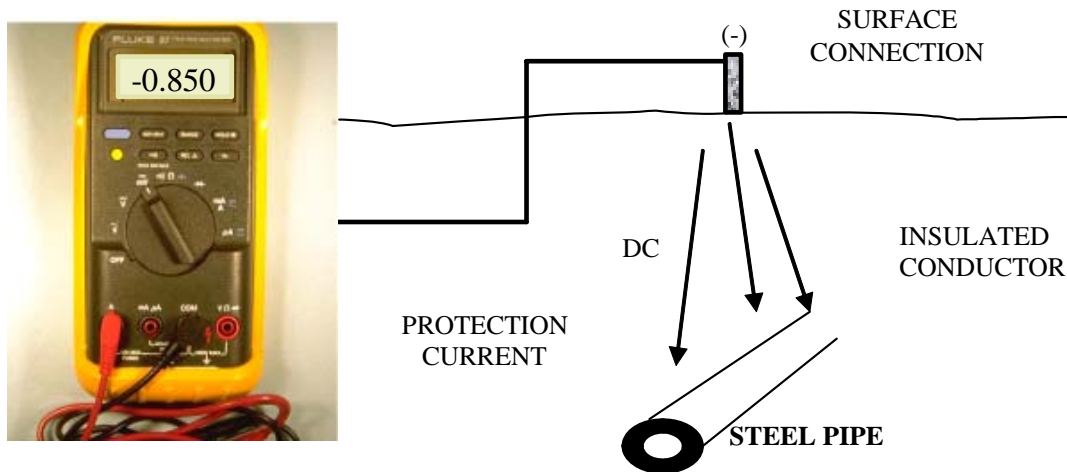
## CRITERIA FOR CATHODIC PROTECTION

---

There are five criteria listed in Appendix D of Part 192, to qualify a pipeline as being cathodically protected. Operators can meet the requirements of any one of the five to be in compliance with the pipeline safety regulations. Most systems will be designed to Criterion 1.

Criterion 1: With the protective current applied, a voltage of at least -0.85 volt measured between the pipeline and a saturated copper-copper sulfate half-cell. This measurement is called the pipe-to-soil potential reading (see FIGURE III-16). IR drop must be considered.

Figure III-16 Pipe-to-Soil Potential Reading.



This is a pipe-to-soil voltage meter with reference cell attached. This is a simple meter to use and is excellent for simple "go-no-go" type monitoring of a cathodic protection system. If meter reaches at least -0.85 volt or more negatively, the operator knows that the 850 mv criteria is met at that location. If not, remedial action must be taken promptly. **NOTE:** Be sure to take into consideration the IR drop.

IR drop is a phenomenon that occurs when trying to check or conduct test to determine if the pipeline is being cathodically protected. When a reading is taken, the readings may appear to show that the pipeline is cathodically protected, but in actuality, the pipeline might not be protected. Each operator must take IR drop into account to ensure that the pipeline is really being protected.

To consider IR drop:

- For pipeline systems protected by a rectifier, the current is turned off while taking a reading and the “off” reading is considered to be the correct reading.
- For pipeline systems protected by magnesium anodes your corrosion consultant can determine how best to consider IR drop.

---

## COATINGS

---

Coatings are used to electrically insulate the pipe from the electrolyte (soil), preventing the electrical flow that causes corrosion. Prior to July 1, 1971, metallic pipe could be installed without a coating. Any steel pipe installed since then must be coated. There are many different types of coating on the market. The better the coating application, the less electrical current is needed to cathodically protect the pipe.

---

## MILL COATED PIPE

---

When purchasing steel pipe for underground gas services, operators should purchase mill coated pipe (i.e., pipe coated during manufacturing process). Some examples of mill coatings are:

- Extruded polyethylene or polypropylene plastic coatings,
- Coal tar coatings,
- Enamels,
- Mastics,
- Epoxy.

A qualified (corrosion) person can help select the best coating for a natural gas system. A local natural gas utility may be able to give master meter operators the name and location of nearby suppliers of mill coated gas pipe. When purchasing steel pipe, remember to verify that the pipe was manufactured according to one of the specifications listed in Chapter VI of this manual. This can be verified by a bill of lading or by the markings on mill coated pipe.

## PATCHING

---

Special tape materials designed for pipe coating are available. Tape material is a good choice for external repair of mill coated pipe. Tape material is also a good coating for both welded and mechanical joints made in the field.

Some tapes in use today are:

- Polyethylene (PE) and Polyvinyl chloride (PVC) tapes with self-adhesive backing applied to a primed pipe surface,
- Plastic films with butyl rubber backing applied to a primed surface,
- Plastic films with various bituminous backings.

Consult a pipe supplier before purchasing tapes. Tapes must be compatible with the mill coating on the pipe. Household tape, masking tape, duct tape and other general purpose tapes are not suitable for pipe coating repairs.

## COATING APPLICATION PROCEDURES

---

When repairing and installing metal pipe, be sure to coat bare pipes, fittings, etc. It is absolutely essential that the instructions supplied by the manufacturer of the coating be followed precisely. Corrosion may occur if the instructions are not followed.

Some general guidelines for installation of pipe coatings:

- Properly clean pipe surface (remove soil, oil, grease, and any moisture),
- Use careful priming techniques (avoid moisture, follow manufacturer's recommendations),
- Properly apply the coating materials (be sure pipe surface is dry - follow manufacturer's recommendations). Make sure soil or other foreign material does not get under coating during installation,
- Only backfill with material that is free of objects such as rocks or debris capable of damaging the coating. Severe coating damage can be caused by careless backfilling when rocks and debris strike and break the coating.

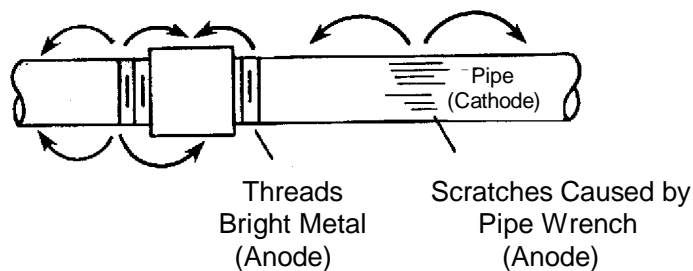
## COMMON CAUSES OF CORROSION IN GAS PIPING SYSTEMS

Figure III-17 Shorted Meter Set.



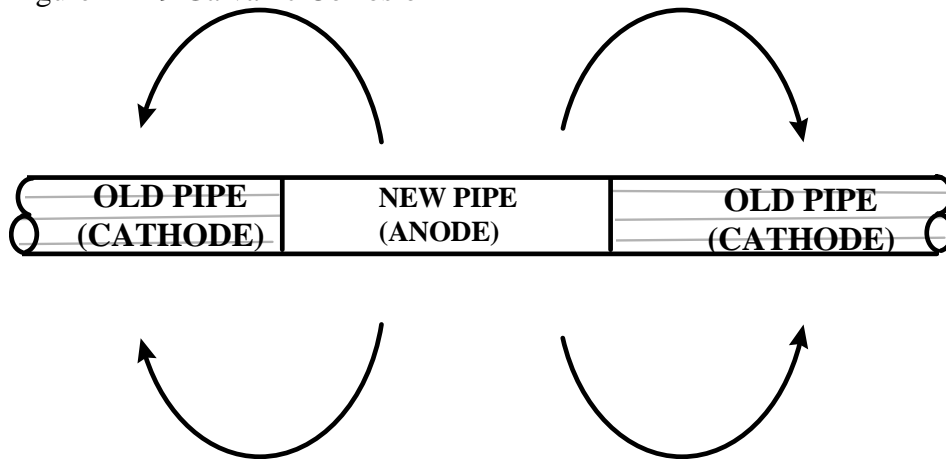
An example of a galvanic corrosion cell. The tenants of this building have "shorted" out this meter by storing metallic objects on the meter set. Never allow customers or tenants to store material on or near a meter installation. Also, do not allow clotheslines, fences, tools or other items to hang on meter installations as they may cause damage to the pipeline.

Figure III-18 Corrosion Caused by Dissimilar Surface Conditions.



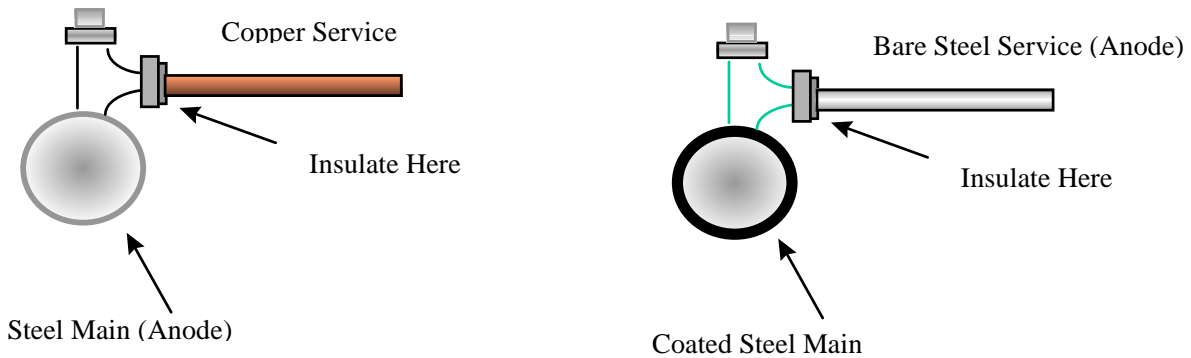
This pipe will corrode at the threads or where it is scratched. Remember to repair all cuts or scratches in the coating before burying the pipe. Always coat and/or wrap pipe at all threaded or weld connections before burying pipe.

Figure III-19 Galvanic Corrosion



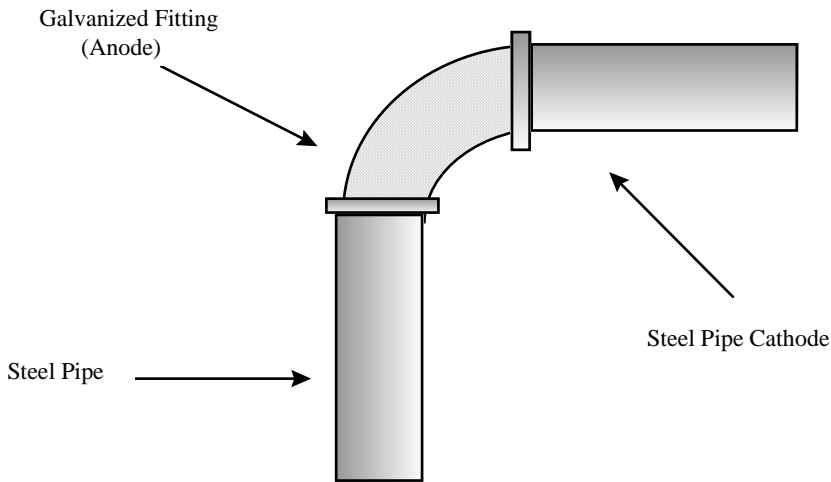
Remember, all new steel pipe must be coated and cathodically protected. The new pipe can either be electrically isolated from old pipe, or both the new and old pipe must be cathodically protected as a unit.

Figure III-20 Galvanic Corrosion Caused by Dissimilar Metals.



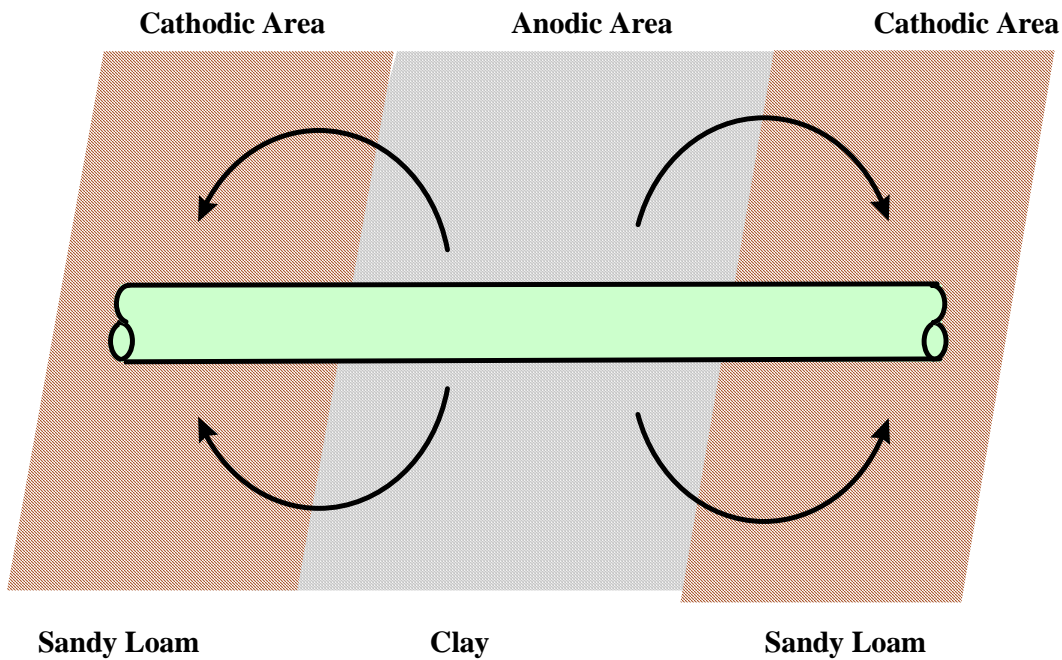
Steel is above copper in the galvanic series in TABLE 1 of this chapter. Therefore, steel will be anodic to the copper service. That means the steel pipe will corrode. The copper service should be electrically isolated from the steel main. Remember, steel and cast iron or ductile iron should be electrically isolated rather than tied in directly. Also, coated steel pipe should be electrically isolated from bare steel pipe.

Figure III-21 Galvanic Corrosion



The galvanized elbow will act as an anode to steel and will corrode. Do not install galvanized pipe or fittings in system, if possible.

Figure III-22 Galvanic Corrosion



A corrosion cell can be set up when pipe is in contact with dissimilar soils. This problem can be avoided by the installation of a well-coated pipe under cathodic protection.



Figure III-23 Poor Construction Practice



Figure III-23 shows an example of a main which was buried without a coating or wrapping at the service connection. This corrosion problem could have been avoided by properly coating and cathodically protecting the pipe.

Figure III-24 Atmospheric Corrosion



Atmospheric corrosion at a meter riser, as shown above, can be prevented by either jacketing the exposed pipe or by keeping it properly painted. Corrosion is usually more severe at the point where the pipe comes out of the ground. Similar corrosion can occur anywhere pipe comes aboveground, such as regulator or metering stations.



## CHAPTER IV: LEAK DETECTION AND ODORIZATION

---

### LEAK DETECTION

---

This chapter contains a simplified description of the leakage survey requirements contained in the pipeline safety regulations. The complete text can be found at 49 CFR Part 49 §192.723 Distribution Systems: Leakage Surveys.

The purpose of leak detection is to find and fix leaks on gas piping that are or could become hazardous to persons or property.

The operator should develop an effective leak management program has the following basic elements.

**L**ocate the leaks in the distribution system;

**E**valuate the actual or potential hazards associated with these leaks;

**A**ct appropriately to mitigate these hazards;

**K**eeep records; and

**S**elf-assess to determine if additional actions are necessary to keep people and property safe.

When investigating gas leaks and determining the classification ask, “WHERE?”

**W**here is the gas? (Use a detector to confirm gas is present);

**H**ow much is there? (Take readings on the CGI);

**E**xtent of the spread? (Determine the migration pattern);

**R**elation to other structures? (Is gas detected in or near buildings or in manholes?);

**E**valuate/evacuate? (Classify the leak and take appropriate action).

---

## METHODS OF DETECTING A LEAK

---

1. Odor. Odor is a common and effective indication of a leak. Odorant is added to natural gas so that a person with a normal sense of smell can smell it at concentrations well below the flammable range.

**A report of gas odor should be investigated immediately using leak detection instruments (see item #8).** The primary purpose of the gas odor is to provide a warning to people who do not have gas detection instruments. Odor or the lack of an odor is not totally reliable as an indicator of the presence or absence of gas leaks. The odor of gas may be reduced as the odorized gas passes through certain types of soil. It may also be modified by passing through soil and into a sewer system containing vapors or fumes from other combustibles as well as the sewer odor itself. Gas odors inside buildings may be masked by other odors in the area, or other odors could be mistaken for the odor of natural gas, therefore, odor is not always totally reliable as an indicator of the presence or absence of gas leaks. For this reason all gas leak reports should be investigated using a leak detection instrument such as a Combustible Gas Indicator (CGI) or a Flame Ionization Detector (FI).

2. Vegetation. Underground gas leaks can kill grass or shrubs by drying out the plant roots. While all dead grass or shrubbery is not due to gas leaks, it indicates where a leak might exist (see Figure IV-1). A vegetation survey by itself is not an acceptable method of complying with the pipeline safety regulations (see 49 CFR §192.723), which require that leak surveys be conducted with leak detection instruments.

Figure IV-1: Dead Grass Indicating a Possible Gas Leak



3. Insects (flies, roaches, spiders). Insects migrate to points or areas of leakage due to microbial breakdown of some components of gas. Some insects like the smell of the gas odorant. Heavy insect activity, particularly near the riser, the gas meter, or the regulator can sometimes indicate a gas leak. Leak detection fluid or leak detection instruments should be used to determine if there is a leak.
4. Fungus-like Growth. Such growth in valve boxes, manholes, etc., may indicate gas leakage. These fungi grow best where there is a lack of oxygen, such as in a gas leak area. The color of the growth is generally white or grayish-white similar to a coating of frost. All such indications should be investigated with a leak detection instrument. Personnel should never enter manholes or other confined spaces without first testing oxygen levels and gas concentrations.
5. Sound. Listen for leaks. A hissing sound at a bad connection, a fractured pipe, or a corrosion pit is the usual indication of a gas leak. Leak detection fluid or leak detection instruments can be used to find the leak
6. Meter Readings and Gas Bills. An unexpectedly high gas bill could indicate possible gas leaks. There are other factors besides leaks that could cause unexpectedly high bills. Cold weather increases gas used for space heating. To rule out temperature as the cause, the high bill should be compared to gas bills for months with similar temperatures. Utility bills often list the “degree-days” for the billing period. Degree-days is a measure of how cold temperatures were during the billing period. Find a recent gas bill with similar degree-days to the high bill. If the high bill is significantly higher than prior bills for similar periods it may indicate leakage on the system. The master meter operator should also consider whether significantly higher occupancy rates, the installation of additional gas burning equipment (converting electric water heaters to natural gas, for example) or other factors can explain the difference. If excess consumption cannot be explained by weather or other factors the system should be leak surveyed using gas detection instruments.

Most master meter operators do not have meters for each customer, but those that do should compare the total consumption registered on the customer meters and that registered on the master each month. For best results the individual customer meters should be read on the same days as the master meter to allow an accurate comparison of gas volumes.

If the master meter reading is greater than the total of all of the customer meter readings, then a leak may exist in the distribution piping, however this could also be due to gas theft or malfunctioning customer meters

For a utility, an unexpected increase in the amount of natural gas purchased from the transmission company for a given month, as compared to past gas consumption for recent months with similar degree-days, may indicate a leak in the system. The operator is cautioned that changes in load factors and weather must be considered when using this method. The operator should be sure to compare similar time periods, as a change in the meter reading cycle will affect this process. Dividing the gas purchased by the number of days in the billing cycle

will give an average per day consumption, which would be more accurate to use in comparing bills. Low load periods such as the summer months would provide the best data.

Operators should also calculate unaccounted for gas (UAF) (see Chapter 5) at least annually. An unexplained increase in the amount of UAF could indicate a leak in the system.

7. Leak Detection Fluid (Soap Solutions). Leak detection fluid can be used to pinpoint the location of a leak on an exposed pipe, on the riser, or on the meter. The fluid is brushed or sprayed on and the location of bubbling indicates leakage. When excavating underground piping to investigate a suspected leak location, the pipe should be brushed clean and completely exposed top, sides and bottom. Many leaks are found on the bottom of the pipe. A mirror may be used to observe the underside of the pipe. NOTE: It is recommended that a leak detection fluid specifically designed for pipelines be used.
8. Leak Detection Instruments. These are sophisticated instruments that require regular care, maintenance, and calibration, and should be used by trained personnel. Instruments commonly used by the gas industry for surveying and pinpointing leaks are:
  - Semi-Conductor or Solid-State Sensor Instruments,
  - Combustible Gas Indicators,
  - Flame Ionization Detector,
  - Infrared (IR) – Optical-based Detectors,
  - Laser-based Detectors.

---

## DESCRIPTION OF LEAK DETECTION EQUIPMENT

---

Various types of leak detection equipment exist, each intended for use in particular situation.

Semi-conductor instruments (Figure IV-2) are not generally used for leak surveys of underground piping. These leak detectors use a specially designed electronic sensor to detect the presence of gases in the atmosphere. As air moves into the sensor housing, if gas is present it causes an electrical imbalance in the sensor.

Semi-conductor instruments are most often used for inspecting exposed piping and appliances to pinpoint leaks on those facilities. Placing the detector on or near the pipe, move it slowly along all exposed piping in the area. As the tick rate increased the sensor is detecting higher concentrations of gas. Confirm the presence of a leak on the pipe or fittings using leak detection fluid.

Combustible gas indicator (CGI) Figure IV-3 shows two combustible gas indicators. A CGI consists of a digital/analog meter, a probe and sampling pump. The pump brings a sample into the instrument. OPS recommends that operators use a two-scale meter (LEL and percent gas). The meter on the instrument indicates the percentage of the lower explosive limit (LEL) scale, or the percentage of flammable gas in air (percent gas scale). These instruments must be calibrated for use on a natural gas system.

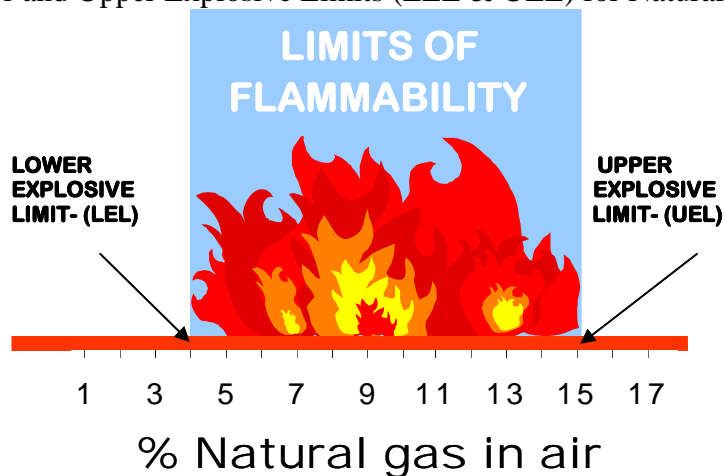
Figure IV-2: Semi-conductor leak detectors Photos courtesy of Heath Consultants, Inc.



Figure IV-3: Combustible Gas Indicators. Photos courtesy of Heath Consultants, Inc.



Figure IV-4: Lower and Upper Explosive Limits (LEL & UEL) for Natural Gas



Typical natural gas is flammable in 4 to 15 percent natural gas in air mixture. In a confined space, a flammable mixture can be explosive.

The CGI is not suitable for aboveground surveys. The CGI was designed primarily for use inside buildings, testing the atmosphere in the soil for confirmation of a leak on a buried pipeline and checking for flammable atmospheres in trenches and confined spaces. Its two main applications for outside surveys are termed "available openings" and "barholes." A barhole is a small diameter hole made in the ground in the vicinity of gas piping to extract a sample of the ground atmosphere for analysis. NOTE: Use extra caution when barholing in the area of plastic pipe. A CGI is not suitable for an aboveground survey.

The CGI instruments are also useful in building surveys and in areas within a building, such as heater closets, and other confined areas. A semi-conductor or solid-state sensor instrument can also be used in these locations, however, these types of instruments do not give readings in percent of gas or percent of LE and, therefore, cannot determine if a hazard exists. A CGI should always be used first when entering a building to determine if flammable gas is present. The CGI must first be "zeroed" (the meter adjusted to display a zero reading when there is no natural gas) in a gas-free atmosphere, e.g., outdoors in clean air away from any possible gas leak. If "zeroed" with a gas-air mixture, the CGI may give false readings of no gas when in fact there is gas present in the air. Since natural gas is lighter than air, check at the top of the doorway first. Once it is determined the atmosphere is non-hazardous (no LEL or percent gas readings) the semi-conductor or solid-state sensor instrument can then be used to inspect the piping for small leaks that would not register on a CGI. Confirm leak indications with leak detection fluid.

One person can operate the CGI. It is effective at locating leaks and minimal training is necessary to use the instrument. A CGI costs substantially less than FI, IR or Laser based detectors.

The Flame Ionization detector uses a hydrogen fuel to power a small flame in a detector cell. A pump or venturi system is used to pass continuous air samples through the detector cell. If the air contains hydrocarbons such as natural gas they will be burned or ionized in the hydrogen flame. Gas concentrations from one part per million (PPM) to 10,000 PPM (10,000 ppm = 1% gas in air)



are displayed on a dial or digital readout. They are also equipped with audible alarms to alert the operator when flammable gas is detected.

Infrared (IR) Optical-based Detectors (portable or vehicle mounted). IR detectors can be used for both mobile and walking surveys, and have a sensitivity to detect down to 1 ppm.

The unit functions by using an infrared optical gas detection system. It is designed to be selective to detecting methane only, and will not false alarm on other hydrocarbon gases.

One advantage IR detectors have over the FI is the decrease in false positives leaks (gasoline, chemical, etc.). That is, FI instruments are non-selective hydrocarbon detectors, whereas IR instruments are selective to methane only, plus the portable IR / Laser detectors are classified Intrinsic Safe (IS).

IR - Optical Methane Detectors (OMD) (vehicle mounted, mobile survey.) The Optical Methane Detector is designed to increase measurement speed and accuracy when performing mobile inspections of buried natural gas distribution, transmission, and gathering pipelines. Containing no moving parts, the OMD can be front mounted on a vehicle and calibrated by the driver or technician from inside the vehicle. OMD uses infrared technology, eliminating potential hazards such as explosive calibration gases. The OMD can detect leak indications in concentrations of less than 1 part per million (ppm) at 10,000 measurements per second. Data can be sent to a data logger or translated to a ground positioning satellite (GPS) system.

Figure IV-5: Optical Mobile Methane Detector



Laser detectors (portable, vehicle mounted, airborne). Laser detectors can detect leaks up to one hundred feet away. Using laser technology, remote detection allows the user to safely survey areas that may be difficult to reach, such as busy roadways, yards with large dogs, locked gates, pipe suspended under a bridge and other hard to access places.

Leak survey can be done more rapidly with the last four instruments than with a CGI. The FI, IR, and laser units can be carried by hand for a walking survey or and all can be mounted on a vehicle for a mobile survey. They allow the operator to quickly identify those areas with a suspected gas leak. Any leak indications should be confirmed using a combustible gas indicator.

If a leak is found, the migration pattern of the gas should be determined. If an immediate hazard is determined to exist, the hazard potential should be eliminated and the leak repaired immediately. Appendix 11 of the Gas Piping Technology Committee's "Guide for Gas Transmission and Distribution Piping Systems" (published by the American Gas Association), contains detailed information on leak classification and action criteria. Leak pinpointing involves using a CGI to measure gas concentrations in barholes in the area of the leak indication. Gas concentrations are usually highest in barholes nearest to the leak.

Leak survey technicians must be trained and qualified in the operation of the leak detection equipment the technician will use to perform the required leak surveys. Additional training is required on leak survey procedures, leak classification, recognition of hazards and pinpointing. All gas personnel should also receive training on abnormal operating conditions (AOC's) (see the Operator Qualification Guide for Small Distribution Systems for a description of AOCs and operator qualification requirements). Operators may choose to hire a leak survey consultant to conduct inspections. The consultants should be trained in the process and procedures that the operator would use and, if working for a utility, must also in a drug and alcohol-testing program.

Figure IV-6: Checking a Gas Meter For Leaks With a Hand-Carried Infrared Optical Instrument.





---

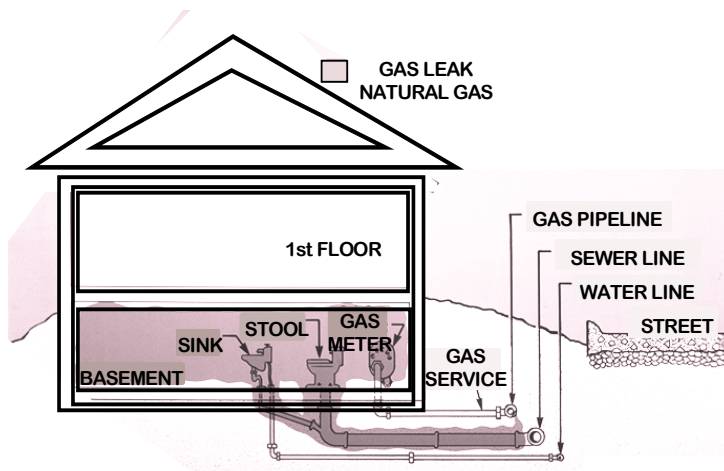
## RECOMMENDED METHOD FOR SURFACE GAS DETECTION SURVEY

---

The ability of the gas to vent at the ground surface is critical for the success of a surface survey with an FI, Optical IR or Laser unit. Tests of barholes with a CGI can detect gas that is migrating underground and not venting to the surface. A continuous sampling of the atmosphere above buried mains and services should be made at ground level as close to the ground as permitted by the gas detector design, since once leaking gas vents at the surface it will quickly disperse to the atmosphere. Where the gas piping is under pavement, measurements should also be taken at curb line(s), available ground surface openings (such as manholes, catch basins, sewer, power, telephone duct openings, fire and traffic signal boxes, or cracks in the pavement or sidewalk), and other places where the venting of gas from an underground leak might vent to the atmosphere. For exposed piping, sampling with a CGI, FI or semi-conductor or solid-state sensor instrument should be conducted as close to the piping as possible. Sampling with optical and laser detectors can detect leaks from a distance and users should follow manufacturer's guidance about detection accuracy and distance from the pipe.

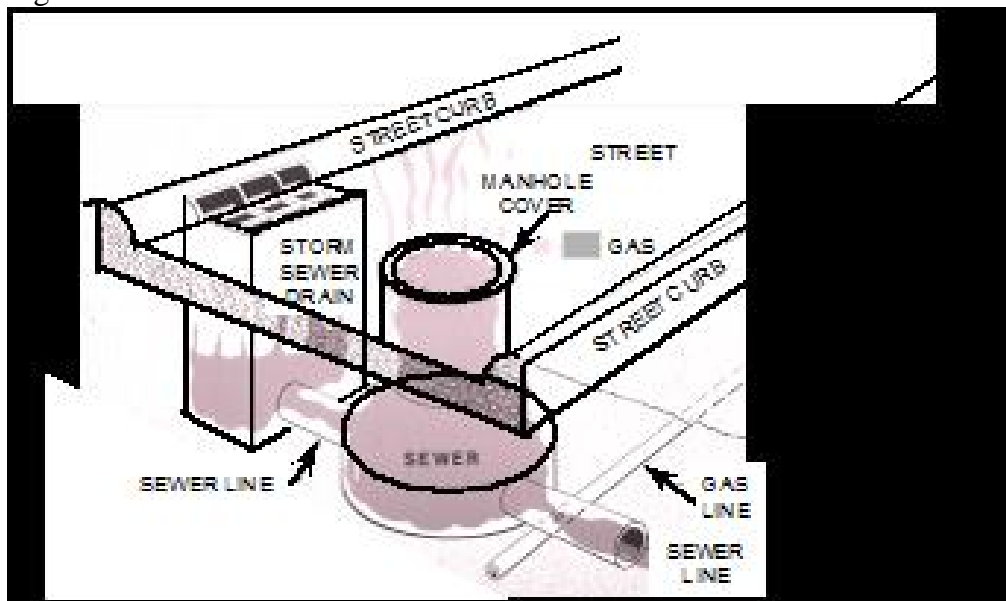
If the ground surface is wet or frozen the gas may be restricted from venting. In windy conditions gas may be rapidly diluted below detection levels. One method to determine if conditions are appropriate for leak survey is to re-survey a known small leak on the system. If it can be detected at normal walking or driving speeds, the survey can continue.

Figure IV-7



This figure show leaking gas following the sewer line into the home, after leaking at the service tee. Natural gas can migrate in this manner.

Figure IV-8



This is an example of how a gas leak can get into a sewer system. This is why it is essential when conducting a leakage survey to check all available openings, including manholes, sewers, vaults, etc. Any indication of gas in a confined space or in a building should be considered a hazardous situation. Persons should be removed from the area, and ignition sources eliminated. Once this is done, the leak investigation should begin, and the leak repaired when found. The facilities affected should be monitored, and the gas migration pattern determined. Gas should be vented from the soil and structure before allowing persons to return to the area.

---

## RECORDS

---

Operators must keep records of all leakage surveys, leaks found, and actions taken, such as leak repairs or monitoring. This includes records of leak reports received from customers or tenants. A sample form for the recording of these leak reports is in Appendix B, Forms 2 and 3.

---

## FOLLOW-UP INSPECTION

---

When a leak has been repaired, the adequacy of leak repairs should be checked before backfilling. Check barholes in the area around the leak with a CGI. If there is residual gas in the ground a follow-up inspection should be made as soon as practical after allowing the gas in the soil to vent and dissipate. For hazardous leaks OPS suggests that a follow-up inspection be performed within 24 to 48 hours, but in no case later than 1 month following the repair. In the case of other leak repairs, qualified personnel should determine the need for a follow-up inspection. If no gas is detected in the soil during follow-up inspections, no further action is required. If gas is detected in the soil, additional follow-up inspections should be conducted until gas levels in the soil are both 1) diminishing and 2) below the lower explosive limit (4%).

---

## ODORIZATION

---

This chapter provides information for natural gas system operators who odorize their own gas or rely on the gas supplier to provide gas that is already odorized.

Most natural gas is odorless and colorless. Gas from landfills and some gas from local production may contain natural odorants, but for most natural gas special chemicals called “odorants” are added to give natural gas a distinctive sulfur-like odor to help people identify gas leaks. All gas in a distribution lines must contain a natural odorant or be odorized so that at a concentration in air of one-fifth of the lower explosive limit (approximately 0.8% - 1.0% gas in air), the gas is readily detectable by a person with a normal sense of smell [§192.625(a)].

Pipeline safety regulations require operators to ensure that natural gas in distribution systems is odorized continuously and consistently without wide variation. Odorizing gas is recognized as the primary means of providing a warning device for the public, therefore it is critical that employees understand its importance and how to properly test for adequate odor. Odorant tests and operation and maintenance of odorizing equipment must be performed by persons qualified to perform these tasks (see the Operator Qualification Guide for Small Distribution Systems).

Even if a utility or master meter receives gas that is already odorized from its supplier, the utility or master meter operator is still responsible to ensure that that natural gas in its piping is odorized continuously and consistently without wide variation.

---

## TYPES OF ODORANTS

---

Most odorants used in the United States are mercaptans or mercaptan/sulfide blends, both of which contain tertiary butyl mercaptans as their main component. The only other odorant in wide use is cyclic sulfide (Thiophane), which is mainly used in gas systems containing natural odorants. It is also used in farm tap odorizers.

The human sense of smell can detect mercaptans at a concentration of only 1 part per billion (ppb).

---

## MONITORING TECHNIQUES

---

Operators should periodically conduct an odor test on the gas in the system to determine if it is properly odorized. Utilities must use an odor testing instrument for these tests. The best time would be when there is a low usage of gas by customers. In lieu of this testing, master meter operators should obtain and keep a written statement from their gas supplier that the gas it receives is properly odorized and periodically conduct "sniff" tests as described below. Operators should check with their respective states to see whether they have additional requirements.

A “sniff” test is when one or more observers smell gas from an open valve, or unlit gas burner. A record indicating that testers were able to smell gas must be kept on file, including the name of the person(s) conducting the test, date, and location of the test.

At least once a month operators should perform a sniff test at locations as far from the odorizer, or, if gas is received already odorized, from the gas receipt point, as possible. Odor can be absorbed by the pipe, so if odor levels are readily detectable at the furthest point from the odor source, it is likely odor levels are readily detectable throughout the system. A sniff test should also be conducted whenever a repair to the system or leak check is performed.

### **Odor Concentration Meters**

There are several different types of instruments that will meet this requirement. One such instrument, shown in Figure IV-9, is the odor concentration meter. Odor concentration meters are specifically designed to determine the lowest concentration at which a gas odor can be detected (see Figure IV-9). The unit is actually a measuring device that indicates the percent of gas by volume in a sample when an odor is detected. Be sure to read the manufacturer’s instructions before conducting odor tests. Follow the manufacturer’s recommendations for maintenance and recalibration of the equipment.

Figure IV-9: Odor Testing Instrument.



Figure IV-10: Conducting a Sniff Test Using an Odor Testing Instrument.



---

## ODORIZATION EQUIPMENT

---

The following are some illustrations and brief discussions of odorization equipment used by operators of small natural gas systems.

---

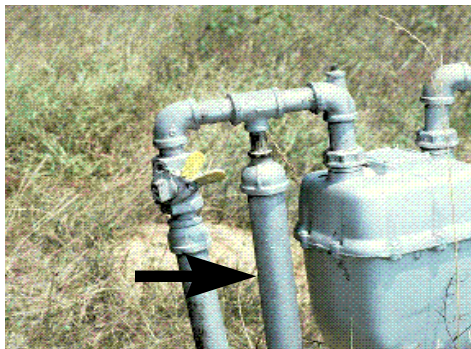
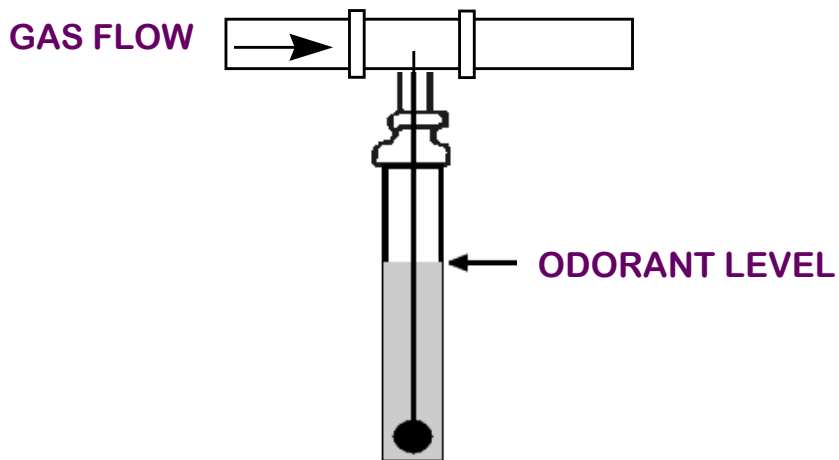
### WICK-TYPE ODORIZERS

---

Wick type odorization equipment odorizes the gas by having natural gas flow across a wick saturated with odorant. These are generally used for individually odorized lines such as farm taps.

Figure IV-11

#### SINGLE-UNIT WICK ODORIZER

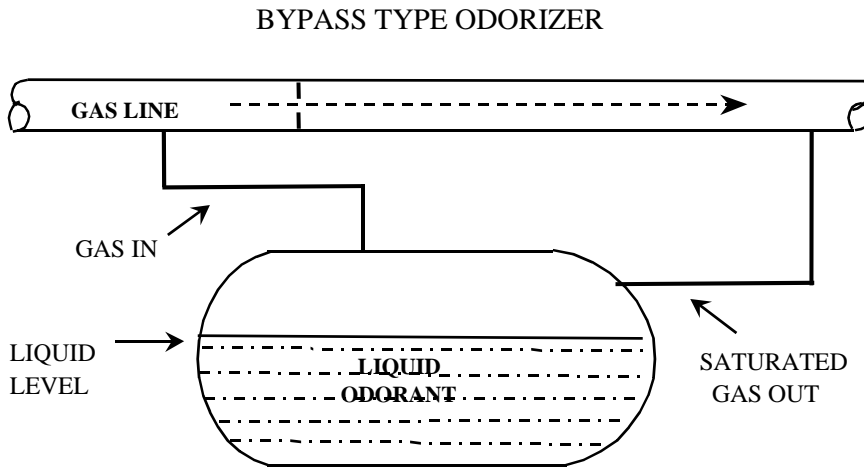


NOTE: Pitot tube version eliminates wick and lessens summer (low flow) problems with odorization process.

Wick-type odorization equipment may need seasonal adjustments. Valves that regulate the amount of gas diverted into the odorizer need to be adjusted between seasons of high flow and low flow of gas (winter vs. summer.) Based on the equipment manufacturer's recommendation, operational instructions for specific systems can be developed. These instructions should be included in the operations and maintenance plan.

### BYPASS-TYPE ODORIZER

Figure IV-12



In a bypass-type odorizer a portion of the main gas stream is diverted, by an orifice plate or partially closed valve in the line, through a tank provided with baffles or wicking. The odorant-saturated portion of the bypass gas is then returned to the main stream. Generally used for low, more uniform flows.

## INJECTION TYPE ODORIZER

---

This system injects odorant directly into the gas stream using a pump system. The unit is microprocessor controlled, using information from a flow measurement device to determine the injection frequency of odorant. This will vary with the gas flow to maintain a consistent odorant injection rate. These odorizers are capable of operating across a wide range of flow conditions. They are best suited for distribution systems.

Figure IV-13: Injection-Type Odorizer



## EQUIPMENT SELECTION CONSIDERATIONS

---

Selection of the appropriate odorant and odorizing equipment may require professional advice. Operators should consult with an odorant and/or equipment supplier who can help guide odorant selection. These persons can evaluate an operator's unique pipeline situation and advise on the best odorant and the best equipment. Operators are encouraged to consult with more than one of these organizations to obtain the best odorant and equipment that will ensure that the proper odorant level is maintained.



## CHAPTER V: UNACCOUNTED FOR GAS

---

Unaccounted-for gas (UAF) is the difference between the measured amount of gas entering the system and the measured amount of gas leaving the system. “Measured” typically means it is based on meter readings. Most master meter operators do not measure gas delivered to individual customers, therefore the following discussion of UAF is primarily for small utilities, but will also be useful to operators that do meter gas to each customer.

Many people equate UAF with leaks; however, there is much more to UAF than just leaks. Leakage is only one of a number of factors contributing to UAF. If an operator can eliminate or estimate the magnitude of the non-leak components of its UAF, UAF can be minimized and serve as a better tool for identifying changes in UAF that may indicate leakage.

The causes of unaccounted-for gas can be grouped into two categories: gas leaving the system without going through a meter and issues related to gas measurement.

### UNMETERED GAS

---

Gas leaving the system without going through a meter will result in UAF unless the operator is able to accurately estimate how much unmetered gas is leaving the system. Estimates may reduce, but never completely eliminate, some of the following UAF factors from unmetered gas.

Leaks: New gas piping must be tested and leak-free before being placed into service, but leaks may develop later if gas piping is corroded, punctured by excavation equipment or otherwise damaged. How much gas is lost depends on the operating pressure of the pipe, the size of the hole or line break and how long the leak goes unrepaired. Corrosion leaks will increase gradually with time if not located and repaired. It is difficult to estimate the amount of gas lost through leaks, therefore it is difficult to estimate what fraction of UAF actually represents leaks. There are engineering methods to estimate gas lost from line ruptures or punctures based on line pressure, the size of the hole and duration of the leak. These are beyond the scope of this document but may be found through an internet search or from an engineering consultant.

Intentional releases: Some normal operations and maintenance activities result in the intentional release of gas. For example, if a damaged section of pipe needs to be cut out and replaced, that pipe segment must first be emptied of gas before the replacement can be safely performed, a process known as “purging.” While this gas is not measured, the amount released can be estimated using the following equations:

$$Loss = V \times (P + 14.7) \div 14.7$$

Where:

Loss = Lost gas in cubic feet

V = Volume of the pipe being purged, in cubic feet, and



P = Operating pressure of the pipe at the time of purging, in pounds per square inch, gauge

Pipe volume can be calculated using the following equation:

$$V = L \times D^2 \div 183$$

Where:

V = Volume of the pipe being purged, in cubic feet

L = Length of the pipe being purged, in feet, and

D = Inside diameter of the pipe being purged, in inches

Note: If the pipe segment being purged includes pipe of more than one diameter, calculate the volume separately for each pipe diameter, then add the results together to get the total volume.

Some gas is also released when new or replaced pipe is placed back in service. Air in the line must be removed and replaced by gas. This is typically done by using gas pressure to push the air out of the line. Some gas will be lost in the process.

Unmetered system use: Some utilities may not measure gas used by the utility itself. Many utilities operate gas-fired line heaters at regulator stations to reheat gas that has been cooled due to the pressure drop across the regulator. Some utilities may not measure gas used for space and water heating in utility-owned buildings. Unmetered utility gas use is not leaked gas, but it would show up as UAF. An operator desiring to better understand its UAF could install meters to measure its own gas use or estimate this usage.

Gas theft: Some customers have been known to illegally bypass the utility's meter to steal gas. Stolen gas is not recorded by the meter and will increase UAF. UAF due to gas theft is not leaked gas, however.

Gas theft is a hazardous condition that warrants investigation. Many operators train meter readers and other field workers to look for signs of gas theft. Utilities may also look for unusual decreases in a customer's gas usage as an indicator of possible gas theft. Gas theft, (and non-functioning meters, or dead meters) will normally show up in the monthly billing, so always be on the lookout for unexplained reductions in gas usage. Gas theft that is detected can be estimated from gas bills when the customer was not stealing gas. Gas theft that is not detected cannot be estimated.

## GAS MEASUREMENT ISSUES

---

Meter accuracy: Gas meters are very good, but not perfectly accurate. American National Standards Institute (ANSI) B109, the US standard for residential-type, diaphragm gas meters, calls for new meters to be accurate within 1% (2% after accelerated life tests). At the very low flows such as for a pilot light the allowable accuracy is 10%. UAF due to meter accuracy is not leaked gas.

UAF due to meter accuracy can be minimized by meter replacement programs in which meters are replaced on a fixed schedule or based on a statistical sampling and testing of meters. To determine the overall accuracy of the meters, take a random sample of meters of all ages and test them. By averaging the accuracy of the sample meters, the overall accuracy of the meters in the entire distribution system can be estimated. Taking the average of the meters brought in during a regular changeout will only indicate the accuracy of the meters that have been installed for a long period. If the overall accuracy is poor, it may indicate that the changeout period should be shortened to improve accuracy.

Meter reading cycles: To provide the most accurate comparison, the meters for gas received and gas delivered must be read at the same time. For most gas utilities this is not possible. Customer meters are typically read on a monthly cycle, e.g. if there are 20 workdays in a month the utility may read 5% of customer meters each workday. As a result gas bills for the month of January will include some meters that were read on January 2<sup>nd</sup>, measuring gas consumed primarily in December. When customer gas consumption is totaled at the end of the month, about half the measurement period will be for the previous month. The gas received by the utility, on the other hand, will only include gas actually received during January. If January was colder than December there would be more gas burned for space heating in January, so the utility's gas purchases would exceed the sum of its January customer bills resulting in a positive UAF for the month.

In addition, changes in meter reading cycles can result in changes in UAF. The effects of meter reading cycles on UAF will be more pronounced when the time period is short, such as monthly UAF calculations. The impact of meter reading cycles can be minimized by calculating annual UAF from July to July because daily gas consumption is less variable in warm weather months when the space heating load is lowest. Otherwise, the impact of meter reading cycles can be minimized by calculating UAF for the most recent 12-month period. UAF due to meter reading cycles is not leaked gas.

Temperature effects: Gas temperature can affect measurement accuracy. Gas volume shrinks when it gets cold (put a balloon full of air in your freezer and see what happens!). The colder it gets, the more gas molecules fit into one cubic foot of space. Pressure has a similar effect – at higher pressures more gas molecules will fit into one cubic foot of space. The natural gas industry has adopted 60 °F and 14.73 pounds per square inch absolute (approximately atmospheric pressure at sea level) as the standard conditions for gas measurement. This is known as a “standard cubic foot.”

The gas flowing through most gas meters is usually not at standard temperature or pressure, but if the temperature and pressure of the gas are known, measured gas volumes can be corrected to standard conditions. Where large quantities of gas are delivered, such as at the “gate stations” where utilities receive gas from pipeline suppliers, measured volumes are usually corrected for both gas pressure and gas temperature. This is not true for most customer meters, however.

For every 5°F gas is above or below 60°F, the gas volume will change by about 1 percent. This may not sound like much, but if the average winter temperature for a 3-month period is 30°F, and gas cools to 30 °F by the time it reaches the meter, 6 percent unaccounted-for gas would result for this period. In reality the gas likely will not cool down all the way to 30 °F – most gas piping is underground, so while moving through underground gas piping the temperature of the gas will be closer to the temperature of the soil than the ambient air. Similarly, if during the summer the gas warmed to 90 °F before it passed through the meter a negative 6 percent UAF would result. Gas utilities sell the majority of their gas during the cold winter months so the negative UAF during the hot summer months will usually not offset the positive UAF during the winter months. The actual gas temperature as it passes through customer meters can be estimated but can only be corrected by the use of temperature compensated meters. Some operators adjust their UAF calculations based on estimated gas temperatures. UAF due to temperature effects is not leaked gas.

Pressure effects: How does metering pressure affect UAF? To safely operate, household gas appliances typically require gas at a pressure between about 5 inches water column (w.c.) and 13 inches w.c., therefore gas is reduced to this pressure before going through the meter. Every 4-inch w.c. that gas pressure is higher than this UAF will increase by about 1 percent, so if gas is actually at 11 inches w.c. and the meter is calibrated for 7 inches w.c., approximately 1 percent unaccounted-for gas would result. Pressure compensated indexes are not normally used for domestic house meters, however, they may be used for large commercial and industrial meters. If a pressure compensated index is used, care must be taken to ensure that the meter pressure is the same as the index pressure. The pressure compensated index will only correct for a constant pressure. UAF due to pressure effects is not leaked gas.

---

## SIGNIFICANCE OF UAF

---

Gas leaks are a serious concern; however, the other non-leak factors may make it difficult to determine if UAF is the result of leaks. By taking a positive approach, the majority of the causes of high UAF can be determined and corrected.

An operator seeking to reduce UAF should consider:

- If UAF is mainly due to leaks, there will be a higher percentage of unaccounted-for gas during the summer months. The percentage due to leaks may be slightly higher in the winter if the gas system pressure is raised, but it will not normally be very noticeable. Gas loss due to pressure differences will, if the pressure at the meter is the same in the summer and winter, show the same percentage of unaccounted-for gas throughout the entire year.
- UAF due to temperature effects will show a higher percentage during the cold months.

In summary, if the percent of unaccounted-for gas is higher during the summer months, look for leaks. If UAF increases during the winter months, measurement errors due to temperature effects are probably the cause.

Significant and/or unexpected changes in UAF should be investigated. While weather, meter error and meter cycles will have short term effects on UAF, if UAF is increasing from year to year it could be an indication that the system is developing more leaks.

## CHAPTER VI: REPAIRS AND NEW CONSTRUCTION

---

This chapter is designed to help the operators of small natural gas systems meet the construction and repair requirements set by the pipeline safety regulations. It outlines construction, pipe handling, and pressure testing requirements for installation of safe natural gas systems. It explains the procedures to qualify a person to make a pipe joint. It gives directions for locating "qualified persons" to do construction and repair work on a gas system. Remember, it is always the operator's responsibility to ensure that a contractor follows all requirements.

Manufacturers must design and test pipe, valves, fittings, and other gas system components to mandatory industry specifications. The specifications are incorporated by reference into 49 CFR Part 192, the gas pipeline safety regulations. Components meeting the requirements are qualified for gas service and marked with the "approved" markings. In addition, manufacturers usually develop procedures for joining their products and joining other materials to their products. Manufacturers' manuals and procedures for installation and operation must be incorporated in the operator's operations and maintenance manual.

### PLANNING AHEAD

---

It is essential that a natural gas operator know the types of material and various components of its gas piping system. A piping system consists of pipes, valves, fittings, regulators, relief devices, and meters. The operator must select components for the system that meet all applicable standards and that comply with the pipeline safety regulations. For example, to develop a cathodic protection program, it is necessary to know the type of metal piping in the system.

Records of the type and location of system components are critical for planning purposes. Operators who are uncertain of the type of material in their gas piping system must identify the materials. This may be done in one of the following ways:

- Contact previous owners of the system.
- Contact the contractor who installed and/or maintained the system.
- Check state, city or county permits.
- Carefully expose the pipe to determine the type of materials and components. Plastic pipe will be marked with a "print line" that identifies the manufacturer, the type of plastic and other information. This information should be recorded and stored with other construction records. The American Gas Association provides information on plastic pipe on its website at [www.aga.org/Kc/OperationsEngineering/ppdc/](http://www.aga.org/Kc/OperationsEngineering/ppdc/).

Operators unfamiliar with the types of material must rely on a qualified person to identify the components. These investigations may require the operator to engage a consultant if in-house expertise is lacking.

---

## EXCAVATION

---

Excavation means any operation in which earth is moved or removed by means of any tool, equipment or explosives and includes activities such as augering, backfilling, boring, ditching, drilling, grading, plowing-in, pulling-in, ripping, scraping, trenching and tunneling.

Prior to any excavation, the excavator must serve notice of intent to excavate to the One-Call Center serving the area in which the proposed excavation will occur. Dialing 811 will connect to the appropriate One-Call Center. Notice must be given to the local One-Call Center in accordance with state regulations in advance of excavation. This requirement may vary from 24-72 hours. The excavator must wait the required time before beginning any excavations.

State damage prevention laws and regulations will specify a “tolerance zone,” typically 2 feet on either side of the facility locate markings, inside of which the excavator must carefully hand dig. Power equipment may not be used within the tolerance zone.

Additional information on safe excavation practices can be obtained from the Common Ground Alliance at [www.commongroundalliance.com](http://www.commongroundalliance.com).

---

## EMERGENCY EXCAVATION

---

An emergency excavation is an excavation which is performed to eliminate an imminent damage to life, health, or property. State damage prevention laws should be consulted to determine notification requirements for emergency excavation.

---

## PRECAUTIONS TO AVOID DAMAGE

---

Each person responsible for an excavation or demolition operation must:

- Plan the excavation to avoid damage to underground facilities in and near the construction area.
- Notify the One-Call Center of intent to excavate as far in advance as required by local state regulations.
- Maintain a safe clearance between the underground facilities and the cutting edge of any mechanized equipment, taking into account the known limit of control of the cutting edge to avoid damage to facilities. Do not use mechanized equipment within the tolerance zone.

- Provide support for underground facilities in and near the construction area during excavation and backfilling operations to protect the facility.
- Dig test pits to determine the actual location of gas facilities if these facilities or utilities are to be exposed or crossed.

---

### REPORTING DAMAGE

---

Each person responsible for excavation operations which results in damage to an underground facility must, immediately upon discovery of that damage, notify the owner of the facility of the location and nature of the damage. The facility owner shall have reasonable time to accomplish necessary repairs before the excavation or backfilling in the immediate area of damage is continued.

Each person responsible for an excavation operation that damages an underground facility and permits the escape of any flammable or toxic gas shall, immediately upon discovery of that damage, notify 911 and the facility owner. Check state damage prevention laws for additional notification requirements. Then take any actions necessary to protect persons and property and to minimize the hazards until arrival of the facility owner's personnel or police and fire departments.

---

### MANDATORY PARTICIPATION IN ONE-CALL CENTERS

---

It is in the public interest to promote the protection of citizens, workers, and property in the vicinity of underground facilities. Also, it is in the public interest to promote the health and well-being of the community by preventing the interruption of essential services that may result from damage to underground facilities. Utility operators must be members of a qualified One-Call system if one exists in the area. It is recommended that master meter operators also become members of and participate in the One-Call Center.

---

### PIPE INSTALLATION, REPAIR, AND REPLACEMENT

---

Gas service lines must be installed with at least 12 inches of cover in private property and at least 18 inches of cover in streets and roads. Gas mains must have at least 24 inches of cover.

Qualified personnel must conduct installation of gas pipes. Local gas utilities and local gas associations may be able to recommend qualified persons/contractors who have the necessary background for gas pipe installation. Contractor work must be supervised carefully. The following sections list the minimum requirements for pipe joining and construction activities.

---

## METALLIC PIPE INSTALLATION

---

The following conditions must be met when installing metallic pipe.

- Make each joint in accordance with written procedures that have been proven by test or experience to produce strong, gas-tight joints.
- Obtain and follow the manufacturer's recommendations for each specific fitting used. See FIGURE VI-2 for examples of manufacturer's instructions for a mechanical coupling. Include the manufacturer's procedures in the operations and maintenance manual.
- All steel pipe must have an external protective coating meeting the requirements of §192.461.
- Coat or wrap steel pipe at all welded and mechanical joints.
- Handle pipe without damaging the outside coating. If the coating is damaged, accelerated corrosion can occur in that area. If the coating is damaged, the damaged area must be recoated with a protective coating meeting the requirements of §192.461, before the pipe is installed.
- Pressure test new pipe for leaks before backfilling per the requirements of Subpart J of 49 CFR Part 192. Mains and services to be operated at 60 psig or less must be tested to 100 psig. This test pressure must be maintained for at least 1 hour. When performing maintenance, short sections of pipe may be pre-tested prior to installation. When using pre-tested pipe, joints between pretested pipe and existing pipe must be tested at operating pressure, and it is recommended to use a leak testing fluid ("soap solution") to ensure no leakage.
- Support the pipe along its length with proper backfill. Make certain that backfill material does not contain any large or sharp rocks, broken glass, or other objects that could scrape the coating or dent the pipe.
- Cathodically protect steel pipes.
- Electrically insulate dissimilar metals (see CHAPTER III for illustrations).

If welding steel is necessary in a pipeline, review the pipeline safety regulations in Subpart E of 49 CFR Part 192. Remember: welding must be performed in accordance with established written welding procedures that have been qualified and tested to produce sound ductile welds, and must be performed by welders who are qualified for that welding procedure. Some states have special welding certification programs.

Welding of steel pipe is difficult. Both the procedures and the personnel must be qualified for the type of weld performed. If welding is done on a gas system, qualified welders can be referred by:

- The local gas utility;
- Local gas associations;
- Consultants.



---

## PLASTIC PIPE INSTALLATION

---

Plastic pipe is commonly used for distribution mains and services by the gas industry. Polyethylene (PE) pipe is recommended as the most suitable plastic pipe for natural gas piping. Acceptable PE plastic pipe is manufactured according to standard American Society for Testing Materials (ASTM) D2513 and is marked with that number. Regardless of whether the operator or a contractor installs PE plastic pipe, the operator is responsible to ensure that all PE pipe installed on the system is manufactured according to the version of ASTM D2513 currently referenced in 49 CFR Part 192 (see §192.7 for the correct edition of this standard).

Currently, there is no polyvinyl chloride (PVC) being made for gas use. Only PVC that is marked with ASTM D2513 can be used in a gas system.

Plastic pipe must be installed below ground level with two exceptions. Plastic pipe may be installed temporarily above ground for up to two years if protected from physical damage. Plastic pipe may also be installed permanently on bridges if protected from physical damage and can resist exposure to ultraviolet light and high and low temperatures. See 49 CFR §§192.321(g) and (f).

---

## WRITTEN JOINING PROCEDURES

---

The operator must include written joining procedures in its operations and maintenance manual. Each joint must be made in accordance with written procedures that have been proven by test or experience to produce strong gas-tight joints. Plastic pipe joining procedures can be obtained from the pipe manufacturer. Do not purchase a pipe if the manufacturer or supplier does not certify qualified joining procedures for the pipe. In addition, the operator must verify that the contractor follows written joining procedures that meet the manufacturers' recommended joining procedures for each type of pipe and fitting used.

---

## QUALIFICATION OF PLASTIC PIPE JOINERS

---

No person may make a plastic pipe joint unless that person has been qualified under the applicable joining procedure by making a specimen joint that passes inspection and test. The specimen joint used to qualify the joiner must be visually examined during and after joining and found to have the same appearance as a joint or photograph of a joint that is acceptable under the procedure. In the case of heat fusion, the specimen must be cut into at least three longitudinal straps, each of which is:

- Visually examined and found not to contain voids or discontinuities on the cut surfaces of the joint area;
- Deformed by bending, torque, or impact, and if failure occurs, it must not initiate in the joint area.

Per § 192.285(c), a person must be re-qualified under an applicable procedure once each calendar year at intervals not exceeding 15 months, or after any production joint is found unacceptable by testing under §192.513

A person that is qualified by appropriate training or experience to evaluate the acceptability of the joint must inspect each joint installed in a gas piping system. This inspection may be performed by the person installing the joint if so qualified.

The use of band clamps are not an acceptable method to join PE and is not allowed in 49 CFR Part 192.

Figure VI-1



Figure VI-2  
 An Example of a Manufacturer's Instruction for a Mechanical Coupling.

**1** Cut the PE piping so that the end is square.



**2** Wipe with a clean dry cloth. Inspect the last several inches of PE piping for damage. If any, cut again to remove damaged area.



**3** Use the Elster Perfection chamfering tool for a proper O.D. chamfer. This chamfer permits the PE piping to be completely stabbed without affecting the internal seals.



**4** Use a soft felt tip pen, crayon or grease pencil to mark the stab depth as indicated on your Permasert package instructions. The stab depth is the approximate distance from the edge of the fusion bead to the end of the fitting body.



**5** Stab the PE piping into the Permasert fitting so that the stab depth mark is visible.



- Within 1/8" of moisture seal on 1/2" CTS and 1" CTS sizes
- Within 1/4" on all other sizes through 1-1/4" CTS
- Approximately 3/8" on 1-1/4" IPS and 2" IPS sizes

The PE piping must bottom out in the fitting. Pressure test the joint in accordance with your standard procedures. The reference mark can move outward up to an additional 3/8" during pressure testing.

[www.elster-perfection.com](http://www.elster-perfection.com)



Figure VI-3

Example of a Manufacturer's Procedure for Installing a Specific Coupling.

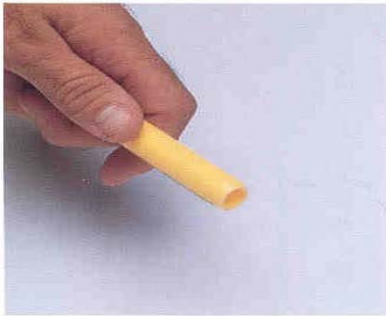
### ASSEMBLY INSTRUCTIONS



**1** Check the pipe being used to be certain of correct pipe size. Cut pipe ends square.



**4** Holding the end of the pipe against the collar on the fitting, mark pipe at the entrance of the fitting (this stab length is 1 7/8").



**2** Chamfer end of pipe using a chamfering tool.



**5** Stab pipe completely into fitting so that the mark on the pipe is flush or less from the fitting entrance.



**3** Clean pipe thoroughly to assure there is no dirt, grease or oil in assembly area. Also, assembly area must be free of severe scratches.

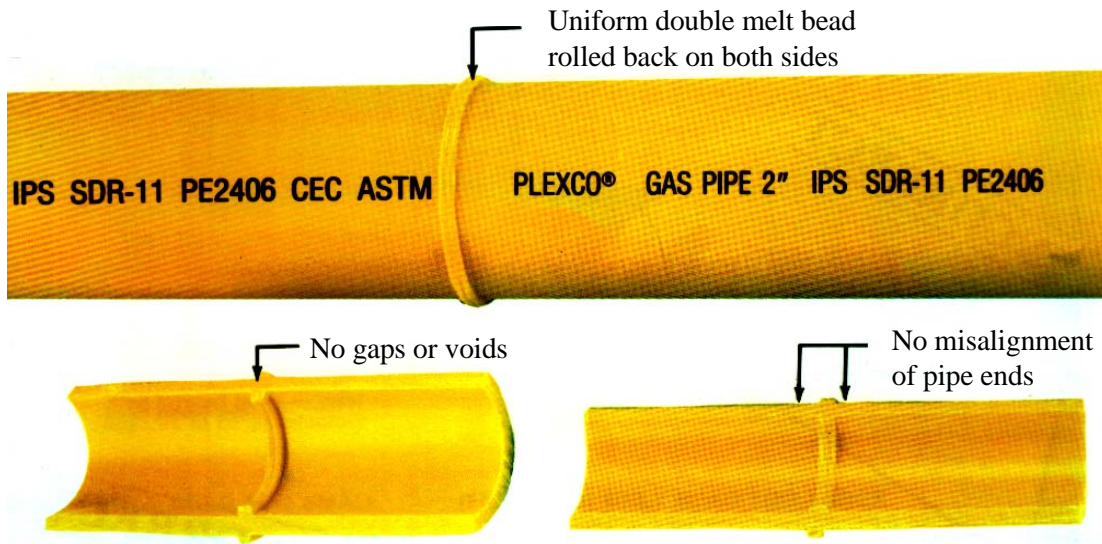
**6** Repeat steps 1 thru 5 for the other end of coupling to complete the joint.

**7** Pressure test the joint before putting it into service.



Figure VI-4: Butt Fusion and Saddle Fusion Joints.

**BUTT FUSION JOINT**



**SADDLE FUSION JOINT**

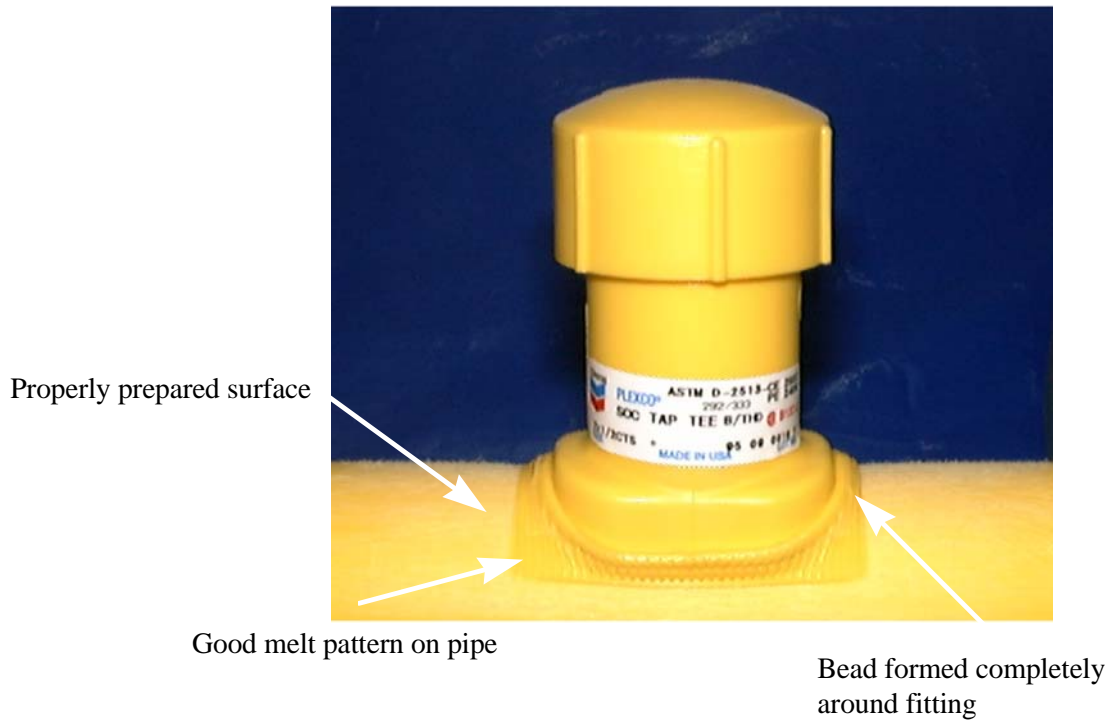
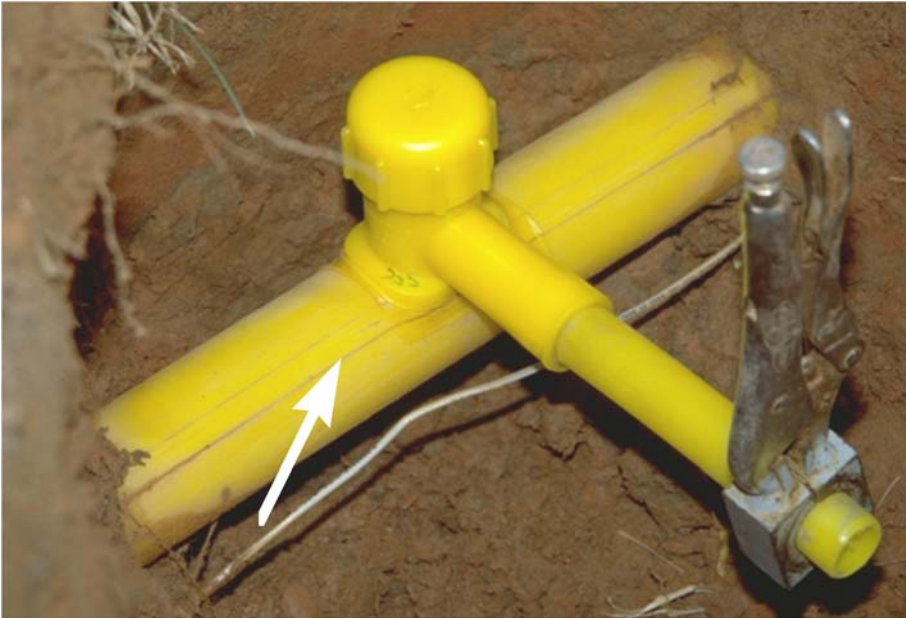




Figure VI-7: Saddle Service Tee

An example of a saddle service tee joint made with PE pipe listed in ASTM D2513.



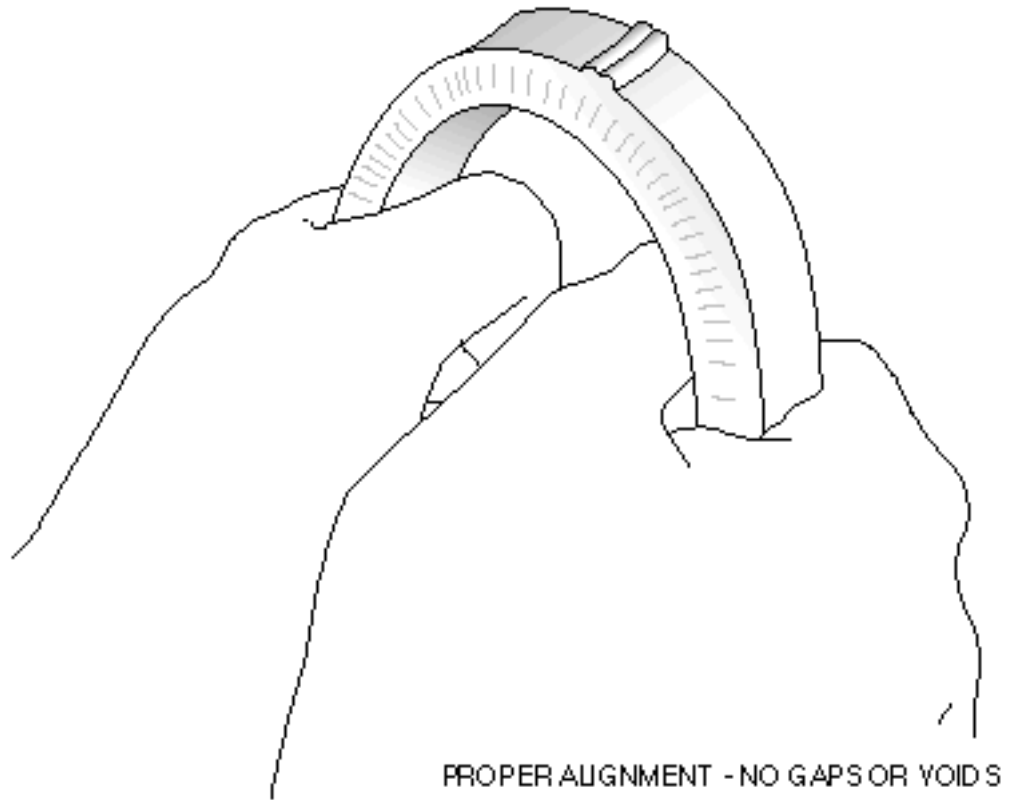
Note : Plastic pipe may also be joined using electrofusion fittings designed and manufactured in accordance with ASTM Specification F-1055.

Figure VI-8

---

BUTT FUSION OF PIPE: ACCEPTABLE APPEARANCE

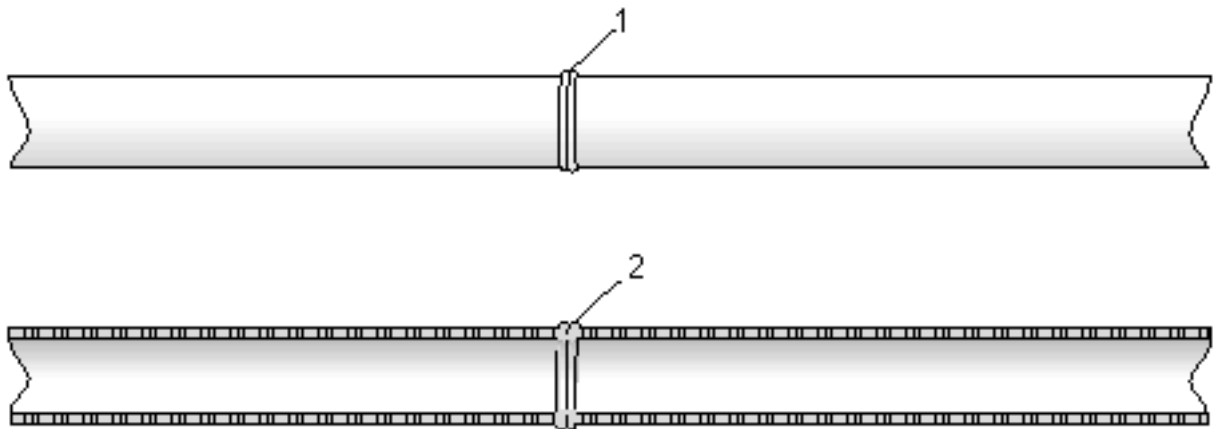
---



---

BUTT FUSION OF TUBING: ACCEPTABLE APPEARANCE

---



1. PROPER DOUBLE ROLL BACK BEAD
2. PROPER MELT, PRESSURE AND ALIGNMENT

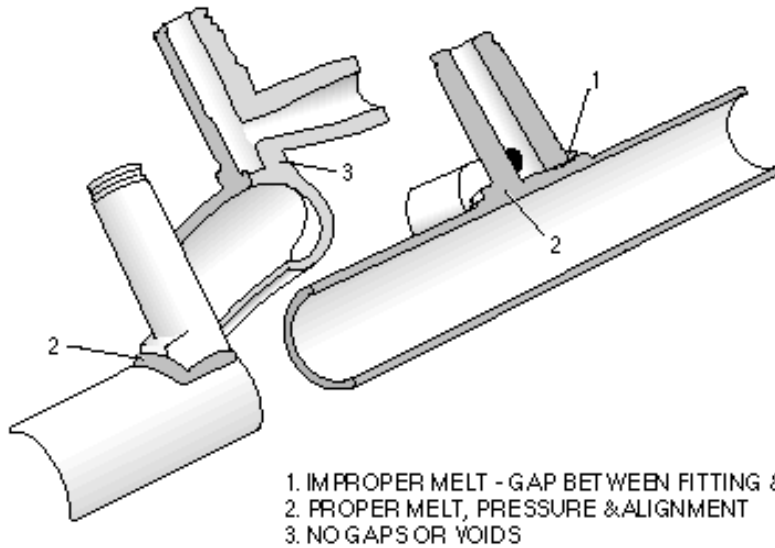


Figure VI-9

---

SIDEWALL FUSION: ACCEPTABLE APPEARANCE

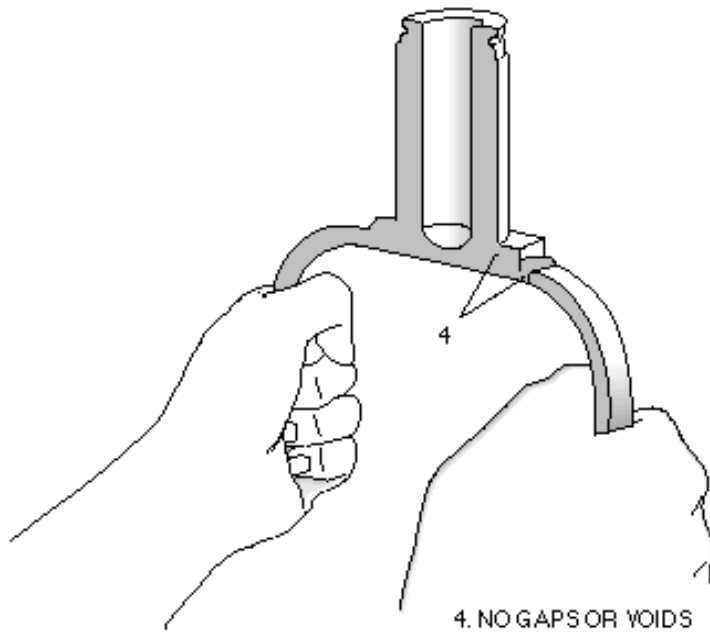
---



---

SIDEWALL FUSION: ACCEPTABLE APPEARANCE

---



The general guidelines to follow when installing plastic pipe are listed below:

1. Install plastic pipe manufactured under the ASTM D2513 specification. The pipe must have ASTM D2513 marked on it.

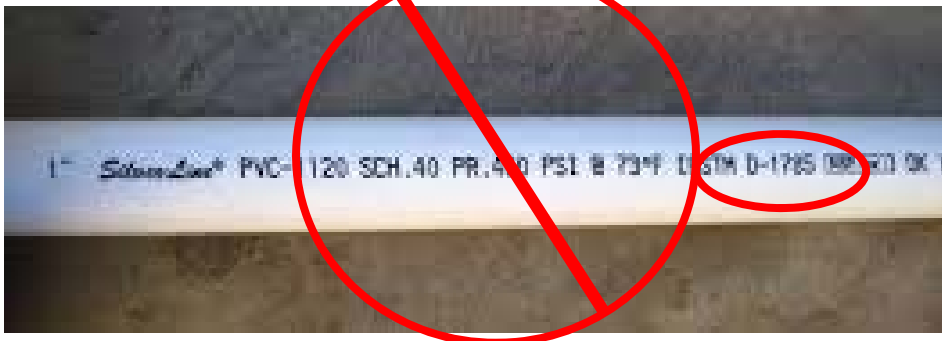
Figure VI-10



This is a properly marked PE pipe. ASTM D2513 is clearly marked on the pipe. If ASTM D2513 is not marked on a pipe, do not purchase it.

Figure VI-11

This is an example of PVC pipe not qualified for gas piping. It was manufactured according to ASTM D1785. The pipe is qualified for use with the distribution of pressurized liquids only, not gas piping. Remember to look for the ASTM D2513 marking on the pipe.



2. Make each joint in accordance with written procedures that have been proven by test to produce strong gas-tight joints. The manufacturer of the pipe or fitting should supply the operator with the procedures for each product in the manufacturer's manual. When installing the pipe, make certain that these procedures are followed. A qualified person must make all joints.
3. Install properly designed valves in a manner that will protect the plastic material. Protect the pipe from excessive twisting, shearing, or cutting loads when the valve is operated. Protect from any secondary stresses that might be induced through the valve or its enclosure. Valve boxes should be independently supported from the plastic main or service line.

4. Prevent pullout and joint separation. Plastic pipe must be installed in such a manner that expansion and contraction of the pipe will not cause pullout or separation of the joint. Operators unfamiliar with plastic pipe should have a qualified person perform all joining procedures.
  
5. When inserting plastic pipe in a metal pipe, make allowance for thermal expansion and contraction. Make an allowance at lateral and end connections on inserted plastic pipes, particularly those over 50 feet in length. End connections must be designed to prevent pullout caused by thermal contraction. Fittings must be able to restrain a force equal to or greater than the strength of the pipe. To minimize the stress caused by thermal contraction, pipes inserted in the summer should be allowed to cool to ground temperature before tie-ins are made. Inserted pipes, especially those pulled in, should be relaxed, mechanically compressed, or cooled to avoid initial tensile stress. Operators unfamiliar with proper insertion techniques must have a qualified person develop the procedures. The edges of the metal pipe where the plastic is inserted should be smoothed by filing or have a protective bushing or covering to avoid scratching or otherwise damaging the plastic pipe as it is inserted. The open end of the plastic pipe should be closed to prevent debris from entering the pipe.

Figure VI-12



6. Repair or replace imperfections or damages before placing the pipe in service.
7. Install all plastic mains and service lines below ground level. Where the pipe is installed in a vault or other below-grade enclosure, it must be completely encased in gas-tight metal pipe with fittings that are protected from corrosion. Plastic pipe installation must minimize shear and other stresses. Plastic mains and service lines that are not encased must have an electrically conductive wire or other means of locating the pipe. Plastic lines must not be used to support external loads.

Figure VI-13

The following is an example of an illegal installation which does not meet federal safety standards. This is a picture of plastic pipe installed aboveground. Remember: **BURY PLASTIC PIPE!**





Figure VI-14

These are other examples of improper installations. Note that a trench and bell hole was dug but the operator never buried the pipe. Keep in mind that plastic pipe loses some of its strength when exposed to sunlight for a long period of time.

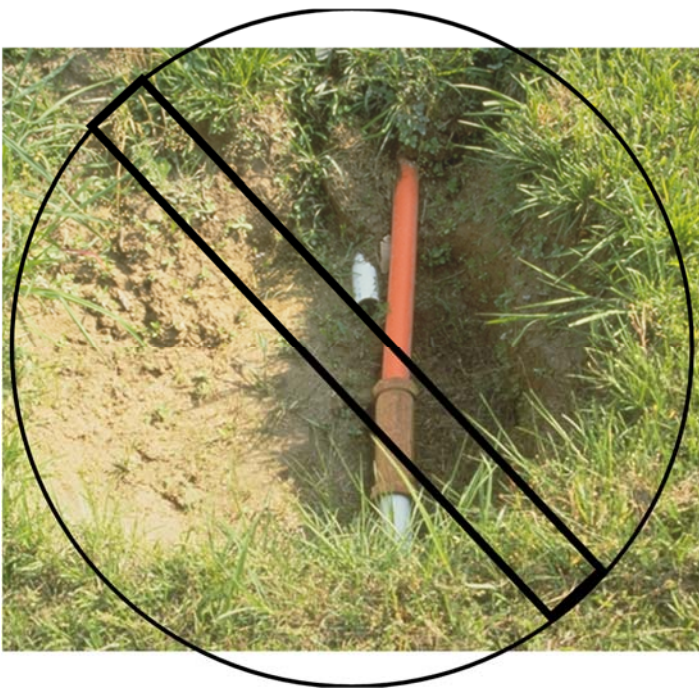
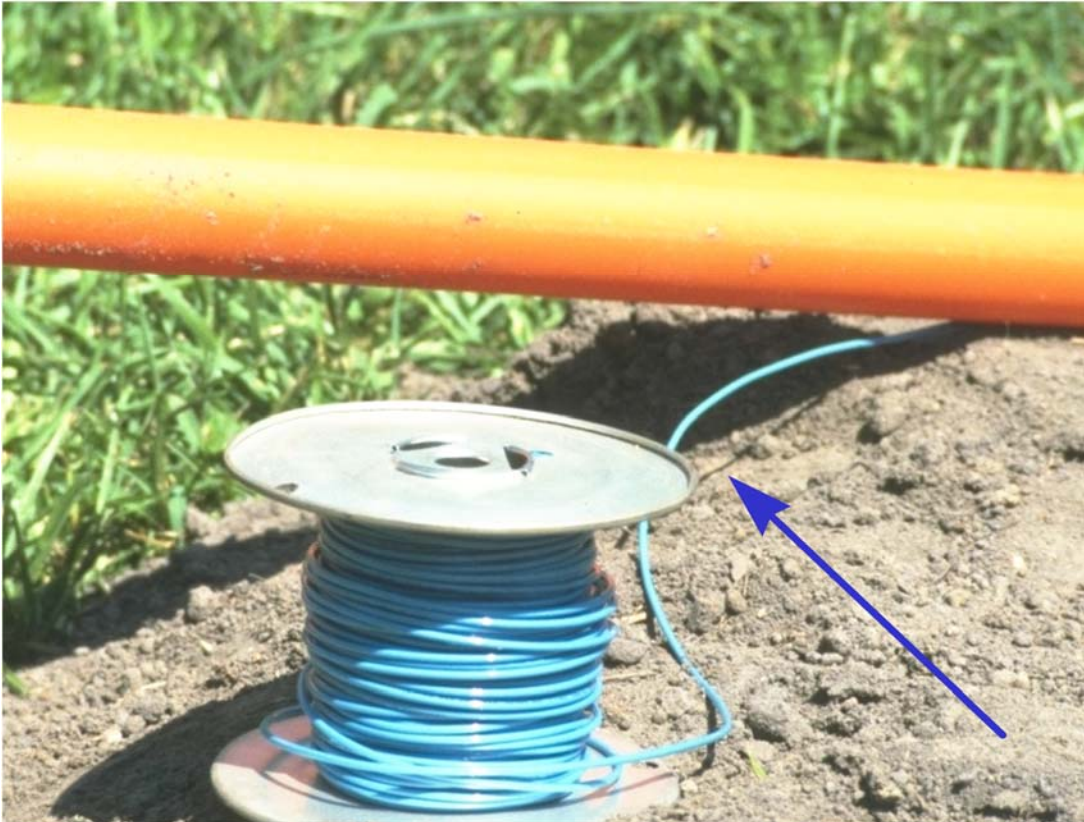


Figure VI-15

Below is an example of tracer wire used to help locate buried plastic pipe. Pipe locators can detect metal but not plastic. Therefore, tracer wire or metallic backed warning/locating tape must be buried along with the plastic pipe. A pipe locator can then detect the buried metallic tracer wire or tape and by doing so, mark the location of the plastic pipe. The wire or tape must be buried along with the plastic pipe with a 6" separation between the tracer wire and the pipe to guard against lightning damage (see §192.32).



7. Test installed plastic pipe to 100 psig for at least 1 hour.
8. Ensure that plastic pipe is continually supported along its entire length by properly tamped and compacted soil. To prevent any shear or other stress concentrations use external stiffeners at connections to main, valves, meter risers, and other places where compression fittings might be used.
9. In laying of plastic pipe, ensure adequate slack (snaking) in the pipe to prevent pullout due to thermal contraction.
10. Inspect pipe and fittings for damage prior to backfilling. If the pipe has a scratch or cut that exceeds 10% of the wall thickness, it must be replaced.

11. Lay plastic pipe and backfill with material that does not contain any large or sharp rocks, broken glass, or other objects that could cut or puncture the pipe. Where such conditions exist, suitable bedding (sand) and backfill must be provided.
12. Take special care to prevent coal tar type coatings or petroleum base tape from contacting the plastic pipe. It can cause plastic pipe to deteriorate.
13. Static electricity can ignite a flammable gas-air atmosphere. When working with plastic pipe (installing or squeezing off) of any kind where there is (or there may be) the possibility of a flammable gas-air atmosphere, take the following precautions:
  - a. Use a grounded wet tape conductor wound around, or laid in contact with, the entire section of the exposed piping.
  - b. If gas is already present, wet the pipe starting from the ground end with a very dilute water and detergent solution. Apply tape immediately and leave it in place.
  - c. Wet the tape occasionally with water. Where temperatures are below freezing (0°C/32°F) add glycol to the water to maintain tape flexibility. Ground the tape with a metal pin driven into the ground.
  - d. Do not vent gas using an ungrounded plastic pipe or tubing. Even with grounded metal piping, venting gas with high scale or dust content could generate an electric charge in the gas resulting in an arc from the dusty gas cloud back to the pipe which could ignite the gas. Vent gas only at a downwind location remote from people or flammable material.
14. NOTE: Dissipating the static charge buildup with wet rags, a bare copper wire, or other similar techniques may not be as effective as the above procedure. In all cases, use appropriate safety equipment such as flame resistant and static free clothing, breathing apparatus, etc.
15. Ensure that adequate and appropriate maps and records are retained after system installation.

---

#### REPAIR METHODS: PLASTIC AND METAL

---

Replacement of gas lines and repair of leaks are highly specialized and potentially hazardous operations. Pipeline repairs must be performed by individuals qualified or under the direction of a qualified individual(s) as required by CFR 49 §192.805- Qualification of pipeline personnel (see the Operator Qualification Guide for Small Distribution Systems for information on operator qualification).

Leaks in service lines or mains may be repaired by cutting out a short length of pipe containing the leak and replacing it with a new, pretested segment of pipe. Mechanical couplings are commonly used for this purpose (see FIGURE VI-2). Remember that written procedures must be followed for each joint. The procedures can be obtained from the manufacturer of the mechanical coupling. If the operator intends to make the repair with a mechanical coupling, the written procedures must be incorporated into the operations and maintenance plan.

Small leaks in steel service lines or mains, such as those resulting from corrosion pitting, must be repaired with an appropriate leak clamp applied directly over the leak. All bare metal pipe and fittings installed below ground must be properly coated and cathodically protected before backfilling.

If several leaks are found and extensive corrosion has taken place, the most effective solution is to replace the entire length of deteriorated pipe. Normal installation practices must be followed. They include priming and wrapping of all bare metallic piping and fittings, proper grading of lines to the main, cathodic protection, etc.

Leaking metal pipe can often be replaced by inserting PE pipe manufactured according to ASTM D2513 in the existing line and making the appropriate connections at both ends. Again, operators are cautioned that allowance for thermal expansion and contraction must be made at lateral and end connections. Operators unfamiliar with insertion techniques, including proper anchoring and offset connections, should have a qualified contractor perform this work. Some PE pipe manufacturers provide procedures for installation of their products by insertion.

One source of failures in plastic pipe is breaks associated with the transitions between plastic and metal pipes at mechanical fittings. The primary source of the problem is inadequate support of the plastic pipe. It is critical to firmly compact soil under plastic pipe to provide proper support. In practice, however, it is laborious, time consuming, and difficult to achieve adequate compaction under such joints. Further, as the soil settles, stress may build and the insert sleeve will cut through the pipe. For example, an insert sleeve must be used in the plastic pipe to provide proper resistance to the clamping pressure of mechanical fittings. This internal tubular sleeve must extend beyond the end of the mechanical fitting. If the pipe is not properly supported at that point, the end of the insert sleeve may shear off the plastic pipe. This source of failure in plastic pipe can be reduced or eliminated by using a properly designed outer sleeve to prevent stress concentrations at the point where the plastic pipe leaves the mechanical fitting.

The most prevalent cause of breaks or leaks in plastic pipe is "third-party" damage, usually by an excavator breaking or cutting the pipe. Plastic pipe is more vulnerable to such breaks than steel pipe. The lower strength of plastic pipe, however, is not necessarily a disadvantage. For example, if digging equipment hooks and pulls a steel pipe it may not break, but may be pulled loose from a connection at some distance from



the digging. The resulting leaks could go undetected for a period of time and may result in a serious incident. Although there is no assurance that the plastic pipe will not also pull out, it is more likely to break at the point of digging, where the break can be detected and repaired. After a leak has been repaired with a coupling or a clamp, a soap-bubble test must be conducted to ensure the leak is repaired.

After a third-party damage is repaired on any type of gas piping, the adjacent pipe (main or service line) should be leak surveyed for a sufficient distance to determine if additional leaks were created by the movement of the damaged pipe.

**ALL SOURCES OF IGNITION SHOULD BE KEPT AWAY FROM THE LEAK REPAIR AREA. OPEN FLAMES SHOULD NEVER BE USED TO DETECT A GAS LEAK OR TO TEST THE ADEQUACY OF A REPAIR JOB.**

## MATERIALS AND EQUIPMENT QUALIFIED FOR USE IN NATURAL GAS SYSTEMS

---

The pipeline safety regulations list many different materials that are qualified for gas service. The materials and specifications listed in this manual are those most commonly used in natural gas distribution systems. Not all qualified materials or specifications are included in this section. The operator of a small natural gas system is referred to 49 CFR Part 192 for further information.

It is important for an operator to know the material of construction and operating pressure of an existing gas pipeline system. The operator must develop, or have a consultant develop, a list of qualified materials for construction and repair of the system. Installation procedures must be included for each type of material used in the system. This can be accomplished by including or referencing manufacturers' "gas product installation manuals" in the operations and maintenance (O&M) manual.

When purchasing material for use in a natural gas pipeline system, it is important to check the marking on the material. The marking on the material will help identify whether the material is qualified for gas service. A natural gas pipeline system consists of both pipe and fittings therefore, an operator must select materials that are compatible with each other. This chapter will cover the most common specifications and standards used by manufacturers for pipes, valves, flanges, regulators, and other equipment commonly used in natural gas distribution systems.

---

### PIPE

---

Steel and plastic pipe specifications applicable to operators of small natural gas systems are listed below. Appendix B, Section I in 49 CFR Part 192 lists the current pipe specifications allowed by the regulations. Operators must also review §192.3 for the current versions of these specifications incorporated by the regulations.

- API 5L - Steel pipe
- ASTM A53 - Steel pipe
- ASTM D2513 - Thermoplastic pipe and tubing

It is recommended that threaded pipe not be installed underground.

When purchasing PE plastic pipe, the pipe must be marked ASTM D2513. Check Part 192 regulations to verify the proper version of ASTM 2513. Plastic pipe with this marking is the only PE pipe suitable for gas service.

Plastic pipe and tubing should be protected at all times from damage by crushing, piercing and extended exposure to direct sunlight. As a rule of thumb, never store plastic pipe outdoors for more than six months. It should be placed inside or covered to protect it from exposure to direct sunlight. It is a good idea to obtain the manufacturer's

recommendation on how long the pipe can be exposed to sunlight before it loses physical strength (see 49 CFR §192.321 for more information).

In recent years, the vast majority of natural gas companies and operators of natural gas system have been installing ASTM D2513, PE pipe. Some of the reasons PE pipe is being installed are flexibility, good joining characteristics, durability, ease of installation, and cost. The PE type designations most often used are PE 2406, and PE 3408 (see FIGURE VI-16).

Figure VI-16

Below is a picture of 4-inch SDR 11 PE pipe manufactured according to ASTM D2513. When using plastic pipe in the underground piping system, make sure it has ASTM D2513 stamped on it.



An anodeless riser is a transition fitting that permits plastic service lines to be brought above ground in compliance with 49 CFR §192.375. The regulations require plastic services to be installed below ground level, except that it may terminate above ground, outside of buildings, if the plastic pipe is protected from deterioration and damage and it is not used to support external loads. Anodeless risers are readily available from various manufacturers and suppliers and are either fully fabricated from the manufacturer, or are field-fabricated by the installer, as is the case with service head adapter risers. Typically, the external protective casing is pre-bent, epoxy coated or galvanized, schedule 40 steel pipe. The plastic gas piping (inside the casing) must extend to an aboveground point for the riser to qualify as anodeless, otherwise the riser casing is a buried steel gas pipe and must be cathodically protected as required by Subpart I of 49 CFR Part 192.

In most cases there is a grade level or “do not bury” marking on the anodeless riser to indicate the proper depth to the installer. The outlet typically is provided with tapered pipe threads, or in the case of commercial or industrial risers, a bolted flange for attachment to the meter valve. The PE piping inlet, called the “pigtail,” is connected to the service line either by heat fusion or with a mechanical coupling already attached to the pigtail for additional installation convenience.

Examples of anodeless service risers. There are many different manufacturers of anodeless risers. The primary advantage of an anodeless riser is that it does not have to be cathodically protected because the outside steel casing is not the gas carrier. The plastic inside the steel casing is the gas carrier. When purchasing anodeless risers, make sure that

they meet all DOT requirements. When installing steel risers connected to plastic pipe by a transition fitting underground, make sure that the steel riser is coated and cathodically protected.

Figure VI-17: Anodeless risers



Most PE pipe manufacturers subscribe to the "Standard Dimension Ratio" (SDR) method of rating pressure piping. The SDR is the ratio of pipe diameter to wall thickness. An SDR 11 means the outside diameter (O.D.) of the pipe is eleven times the thickness of the wall.

For high SDR ratios the pipe wall is thin in comparison to the pipe O.D. For low SDR ratios the wall is thick in comparison to the pipe O.D. Given two pipes of the same O.D., the pipe with the lower SDR will be stronger than the one with the higher SDR. High SDR pipe has a low-pressure rating; low SDR pipe has a high-pressure rating. The operator should check the manufacturer's specific pressure rating for each specific pipe. Do not use pipe with SDR values greater than 11.

PE pipe must be joined by either the heat fusion method (butt, socket, or electrofusion) or by a mechanical coupling. Each joining procedure and each person making joints must be qualified.

For information about local suppliers of plastic gas pipe, contact the local gas utility or search the internet. Be sure to say that the pipe is for natural gas use and must meet ASTM D2513 standards.

---

## VALVES

---

A valve may not be used under operating conditions that exceed the applicable pressure-temperature rating. The valve will be stamped with the maximum working pressure rating (psig). Never install a valve in a system in which the MAOP exceeds the valve's rating. The maximum working ratings are applicable at temperatures from -20°F to 100°F. Metal valves will often be stamped with the symbols "WOG." This means that they are suitable for service for water, oil, or gas. Sometimes just the letter "G" (for gas) appears. The valves must be rated for at least 100 psig or the MAOP of the system if greater than 100 psig.

The manufacturer's name or trademark must be included on a valve. Operators must maintain manufacturers' manuals, which include installation, operation, and maintenance procedures, for each type valve in the gas system. These manuals and procedures should be incorporated or referenced in the O&M manual.

Plastic valves purchased for gas service must comply with the appropriate industry standard. The valves must be compatible with the plastic pipe used in the natural gas system. It is important that operators buy plastic valves only from suppliers who are knowledgeable about natural gas piping. Supplier information can be obtained from trade journals, local gas associations (state or regional), local gas utilities or on the internet.

---

## FLANGES AND FLANGE ACCESSORIES

---

Each flange or flange accessory must meet the minimum requirements found in 49 CFR §192.147. Operators must verify that metal flanges purchased for their system meet these requirements. This can be done by checking the markings on the flange. The markings are similar to those on the valves.

---

## REGULATORS AND OVERPRESSURE PROTECTION EQUIPMENT

---

CHAPTER II discusses basic concepts on pressure regulation, regulators, and relief devices. There are many different manufacturers and models of gas regulators and overpressure equipment (relief valves) for use in gas pipeline systems.

Regulators and overpressure protection equipment must be sized to ensure that overpressure or low-pressure conditions do not occur in the gas system. Manufacturers of gas regulators and relief valves have manuals that contain formulas and charts for each of their models or types of equipment. These formulas and charts are necessary to properly size regulators and relief valves. A qualified person must install the equipment. Operators who do not have a technical background should rely on a consultant or the equipment manufacturer representative to size the equipment.

It is important to obtain the manufacturer's operation and maintenance instructions for each type of regulator and relief valve used in the gas pipeline system. The instructions must be incorporated into the O&M manual.

## WELDING REQUIREMENTS

---

Welding must be performed in accordance with written welding procedures qualified to produce acceptable welds. For typical pipeline welding, standard American Petroleum Institute (API) 1104 is relied on most often. The welding procedures should include:

1. Records of the complete results of the procedural qualification test
2. Procedural specification
  - a. Identifying the process,
  - b. Identifying the materials,
  - c. Identifying the wall thickness groups,
  - d. Identifying the pipe diameter groups,
  - e. Showing a joint design sketch,
  - f. Designating filler metal and number of beads,
  - g. Designating electrical characteristics,
  - h. Designating flame characteristics,
  - i. Designating positions or roll welding,
  - j. Designating direction of welding,
  - k. Designating maximum time lapse between passes,
  - l. Designating type of line-up clamp and removal criteria,
  - m. Designating type of cleaning tool used,
  - n. Specifying preheat and post heat practices,
  - o. Designating composition of gas and range of flow rate,
  - p. Designating type and size of shielding flux,
  - q. Designating range of speed of travel for each pass;
3. Essential variables - Most changes in procedural specifications require requalification of the welding procedure. (Refer to API 1104, paragraph 2.4.);
4. Welding and testing of test joint:
  - a. Preparation of specimen,
  - b. Destructive tests - butt welds,
    - i. Tensile strength test,
    - ii. Nick break test,
    - iii. Root and face bend test,
    - iv. Side bend test,
  - c. Destructive test - fillet welds (break in weld as specified);
5. Welders who are qualified for the welding procedure to be used must perform welding.
  - a. The welder shall be qualified under one of the applicable requirements specified:
    - i. Transmission pipelines
      - (1) API 1104, Section 6, or
      - (2) ASME Boiler and Pressure Vessel Code, Section IX;
    - ii. Distribution pipeline
      - (1) API 1104, Section 6;
      - (2) ASME Boiler and Pressure Vessel Code, Section IX, or

- (3) 49 CFR Part 192, Appendix C, Section I (not acceptable for service line to main connection welding);
    - iii. Service line to main connections
      - (1) API 1104, Section 6,
      - (2) ASME Boiler and Pressure Vessel Code, Section IX, or
      - (3) 49 CFR Part 192, Appendix C, Sections I and II;
  - b. Welder qualification under API 1104, Section 6;
    - i. Perform qualification test as specified in the written welding procedure in the presence of the company's representative;
    - ii. Essential variables (certain changes require re-qualification)
      - (1) For single qualification refer to API 1104, paragraph 6.2; or
      - (2) For multiple qualification refer to API 1104, paragraph 6.3;
    - iii. Welding and testing of test joint:
      - (1) Preparation of specimen(s),
      - (2) Visual examination,
      - (3) Destructive test - butt welds,  
Determine if all or part of these tests are required:
        - (a) Tensile strength test (*optional*),
        - (b) Nick break test,
        - (c) Root and face bend test,
        - (d) Side bend test;
      - (4) Destructive tests - fillet welds: Break in weld as specified;
      - (5) Visual inspection;
- NOTE:** Nondestructive radiographic inspection of butt welds only can be done in lieu of (iii)(3) above. This is the operator's option. The standards of acceptability for radiographic inspection are specified in API 1104, paragraph 6.6.
- iv. Keep the following records:
      - (1) Detailed test results for each welder,
      - (2) List of qualified welders and the procedures(s) for which they are qualified;
  - c. Welder qualification under 49 CFR Part 192, Appendix C, Section I:
    - i. Perform qualification test on pipe 12 inches or less in diameter,
    - ii. Use position welding,
    - iii. Preparation must conform to written welding procedure,
    - iv. Destructive test. - root bend test (4 coupons),
    - v. Visually inspect,
    - vi. Keep the following records:
      - (1) Detailed test results for each welder,
      - (2) List of qualified welders under this procedure;
  - d. Welder qualification under of 49 CFR Part 192, Appendix C, Sections I and II:



- i. Perform c. above,
    - ii. Weld service line connection fitting to a pipe typical of the main using similar position as one would in actual production welding,
    - iii. Destructive test - break, or attempt to break, the fitting off the run pipe,
    - iv. Keep the following records:
      - (1) Detailed test results for each welder,
      - (2) List of qualified welders under this procedure;
  - e. Remain qualified under API 1104, Section 6 or ASME Boiler and Pressure Vessel Code, Section IX, if within the preceding six months, welder has welded with the particular welding process (either test or production welding is acceptable), and welder has made a weld and had it tested satisfactorily either destructively or nondestructively (refer to 2b(3) for required procedure.);
  - f. Remain qualified under either 49 CFR Part 192, Appendix C, Section I or II, if
    - i. Within the preceding 7½ months but at least twice each year, welder has had one production weld cut out, tested, and found acceptable in accordance with the initial qualification test; or,
 

**NOTE:** Welders who work only on service lines 2 inches or smaller in diameter may be tested in each 6-month period under 49 CFR Part 192, Section III, Appendix C in lieu of f (1) above, but at the same intervals;
    - ii. Within the preceding 15 months, but at least once each year, welder has requalified under 49 CFR Part 192 Appendix C
6. Production welding
- a. Use a welder qualified in a qualified welding procedure;
  - b. The following items should be considered:
    - i. Weather protection - 49 CFR §192.231,
    - ii. Preparation - 49 CFR §192.235,
    - iii. Visual Inspection - 49 CFR §192.241,
    - iv. Nondestructive Testing (under specified conditions) - 49 CFR §192.243. Must meet standards of acceptability in API 1104, Section 9;
  - c. Miter joint restrictions
    - i. The use of miter joints is restricted as follows:
      - (1) If MAOP produces a hoop stress of 30 percent or more Specified Minimum Yield Stress (SMYS), the joint cannot deflect the pipe more than 3 degrees,
      - (2) If MAOP produces a hoop stress of more than 10 percent SMYS but less than 30 percent, the joint cannot deflect the pipe more than 12.5 degrees and must have at least one pipe diameter separation from another miter joint,

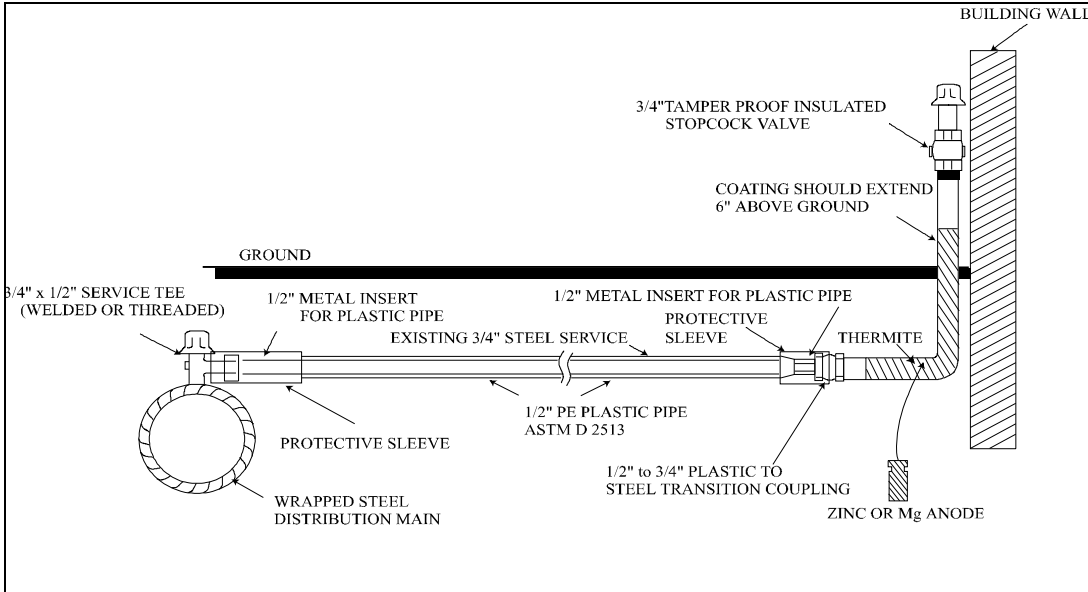
- (3) If MAOP produces a hoop stress of 10 percent of SMYS or less, the joint cannot deflect the pipe more than 90 degrees;
- d. Repair or removal of defect requirements is as follows:
  - i. Remove or repair all welds that fail to pass the nondestructive test requirements (standards of acceptability in API 1104, Section 9, Section 12, and Appendix A),
  - ii. Remove all welds that contain cracks that are more than 8 percent of the weld length,
  - iii. Repairs must have the defect removed down to clean metal and the segment to be repaired must be preheated if conditions exist which would adversely affect the quality of the weld repair. Inspect the repaired weld,
  - iv. Repair of a crack, or any defect in a previously repaired area, must be in accordance with written weld repair procedures that have been qualified under API 1104.

## COMMON CONSTRUCTION PRACTICES

The following (Figures VI-18 and VI-19) illustrate a steel to plastic pipe connection using a mechanical coupling. There are other sizes of connections. Refer to specific manufacturer's instructions for the proper couplings and coupling procedures.

Figure VI-18

Below is an example of a 1/2" plastic pipe inserted into a 3/4" existing service line (for illustration purposes only).



Elevation

### ALTERNATE SERVICE CONNECTION

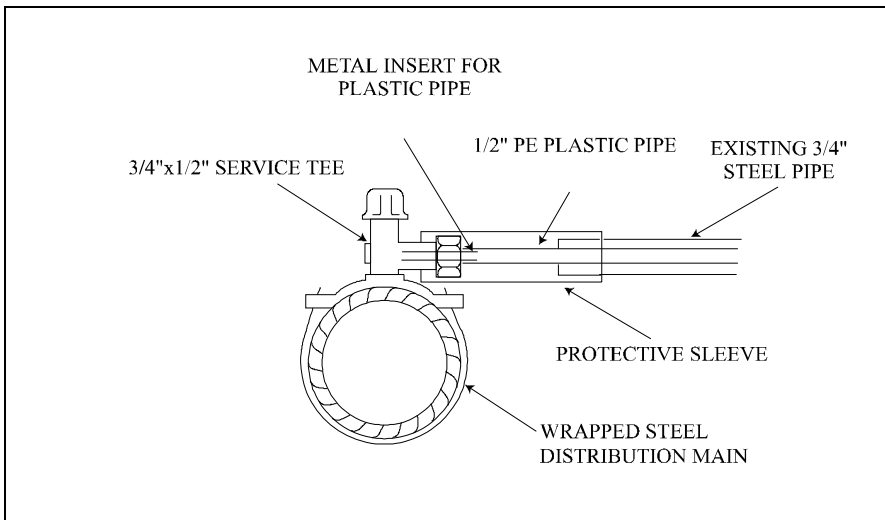
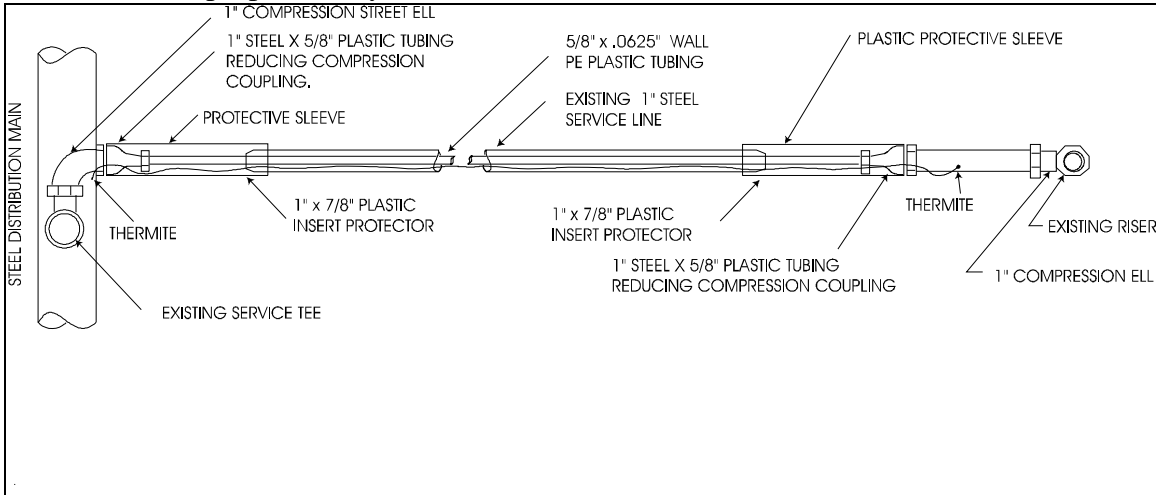


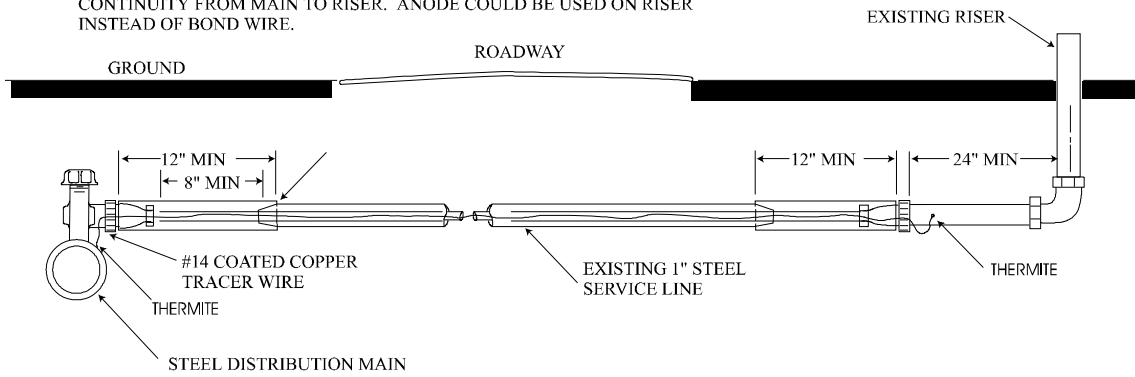
Figure VI-19

Below is an example of a 5/8" PE plastic tubing inserted into an existing 1" metallic line (for illustration purposes only).



Plan

\*\* BOND WIRE CARRIED INSIDE STEEL PIPE, OUTSIDE OF PLASTIC TUBING, FROM CADWELD TO CADWELD. THIS PROVIDES ELECTRICAL CONTINUITY FROM MAIN TO RISER. ANODE COULD BE USED ON RISER INSTEAD OF BOND WIRE.



Elevation

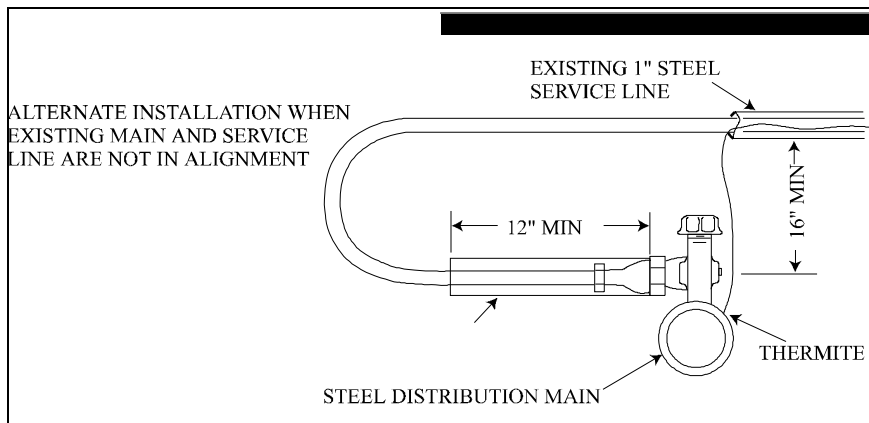


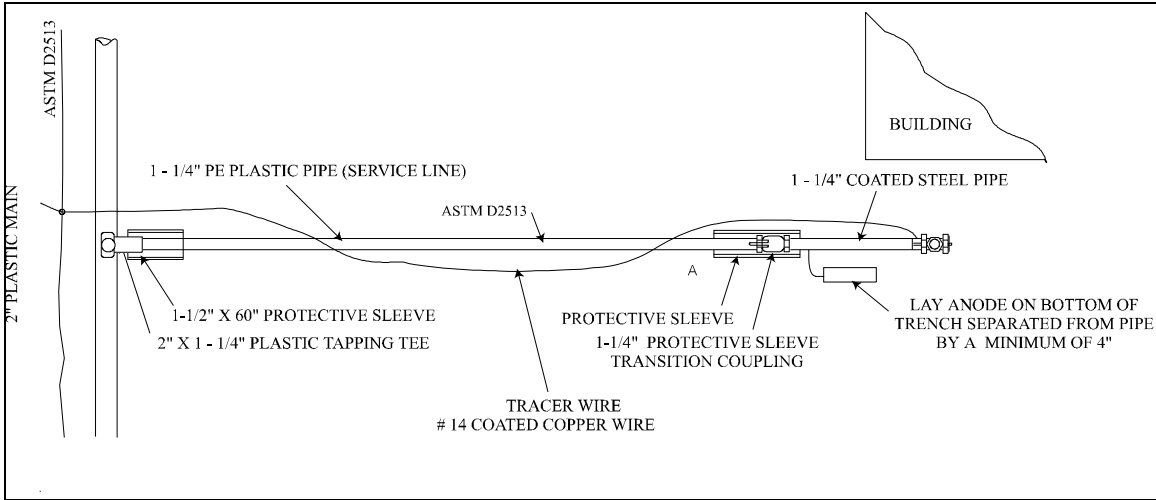
Figure VI-20

Below is an example of a 1/2" plastic pipe inserted into an electrofusion coupling which is electrofused onto a 2" electrofusion saddle fitting.

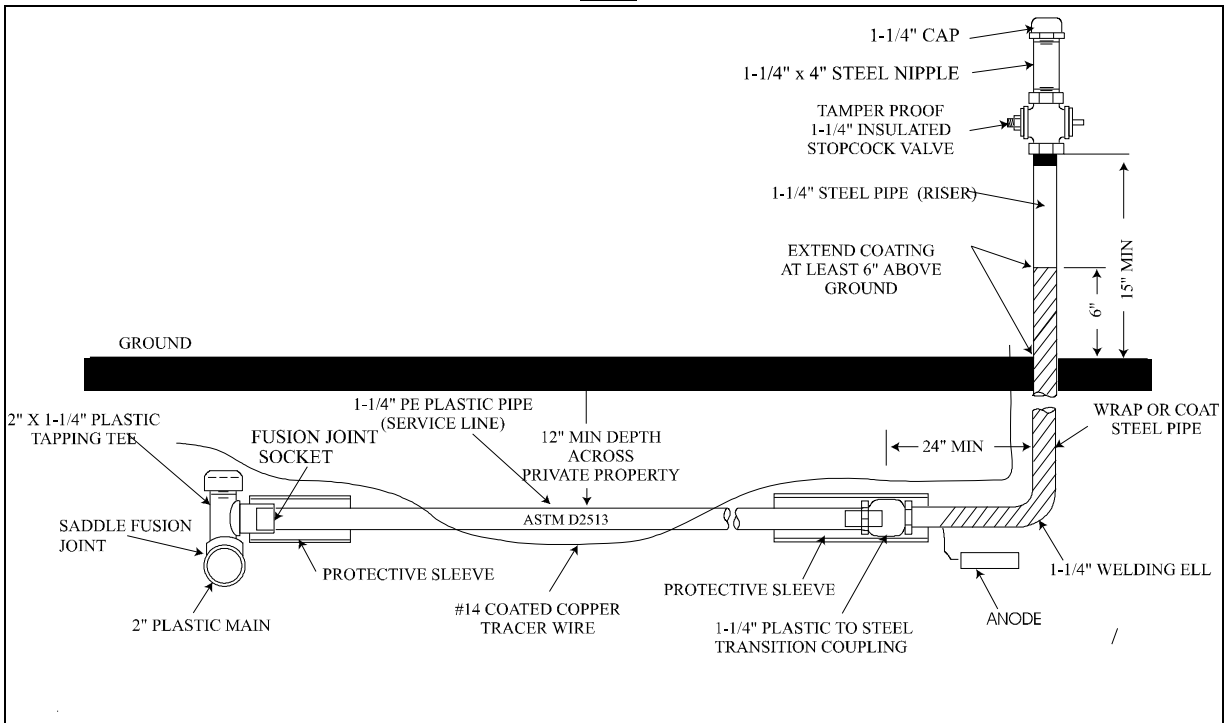


Figure VI-18A

An example of a 1 1/4" plastic service line from a 2" PE plastic main (for illustration purposes only).



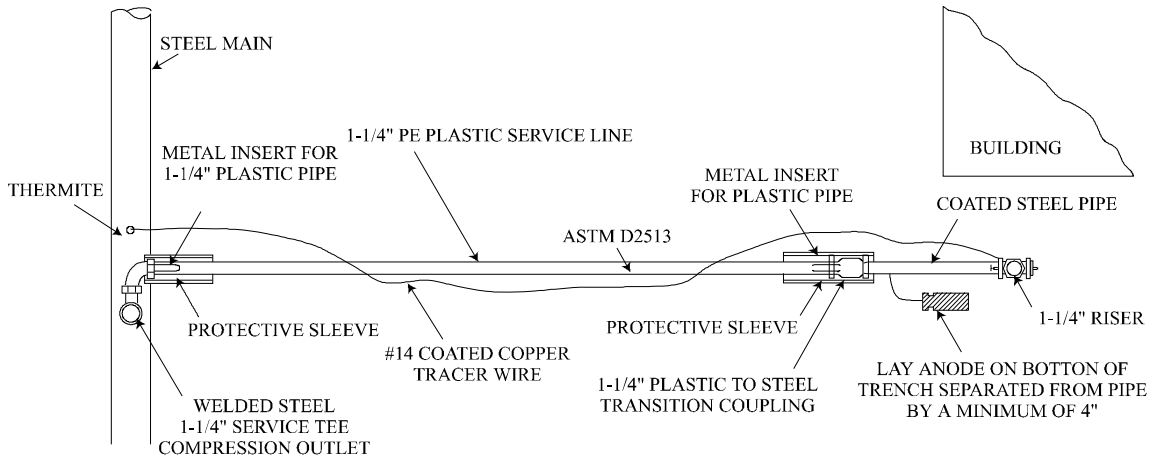
Plan



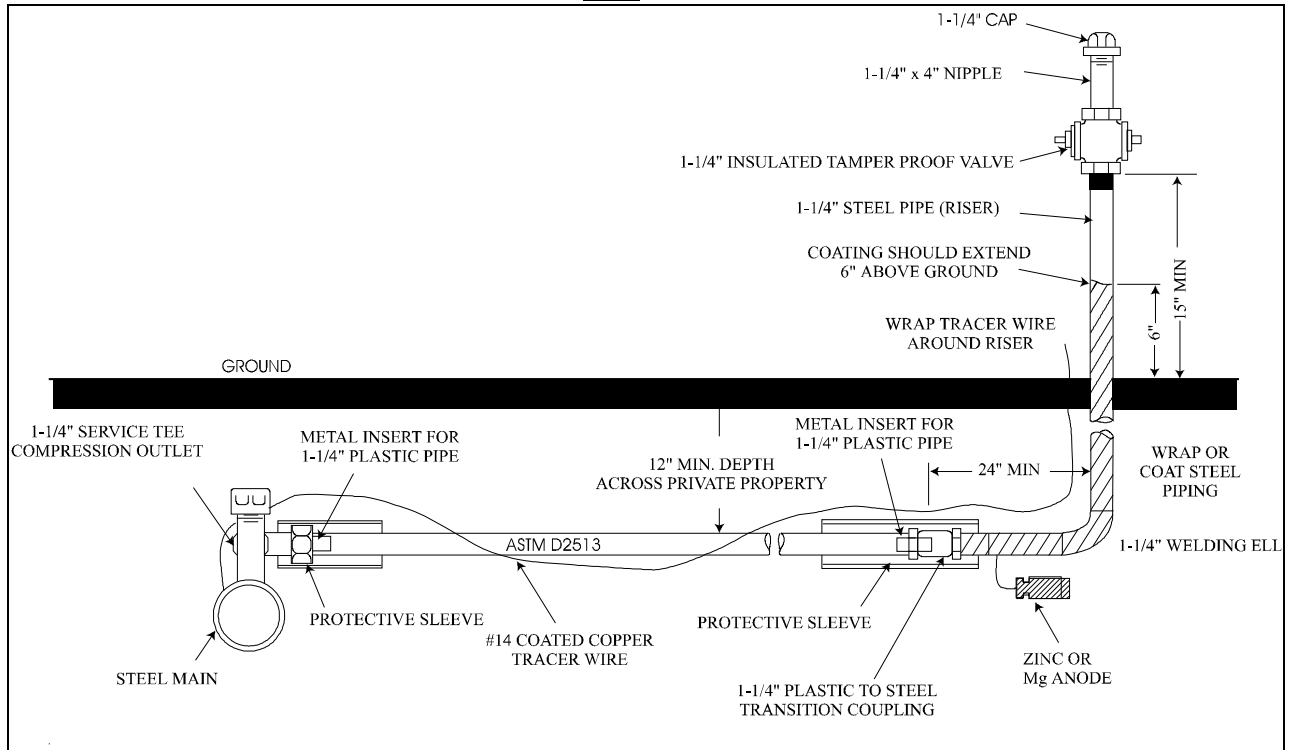
Elevation

Figure VI-21

An example of a 1 1/4" PE plastic service line from a steel main (for illustration purposes only).



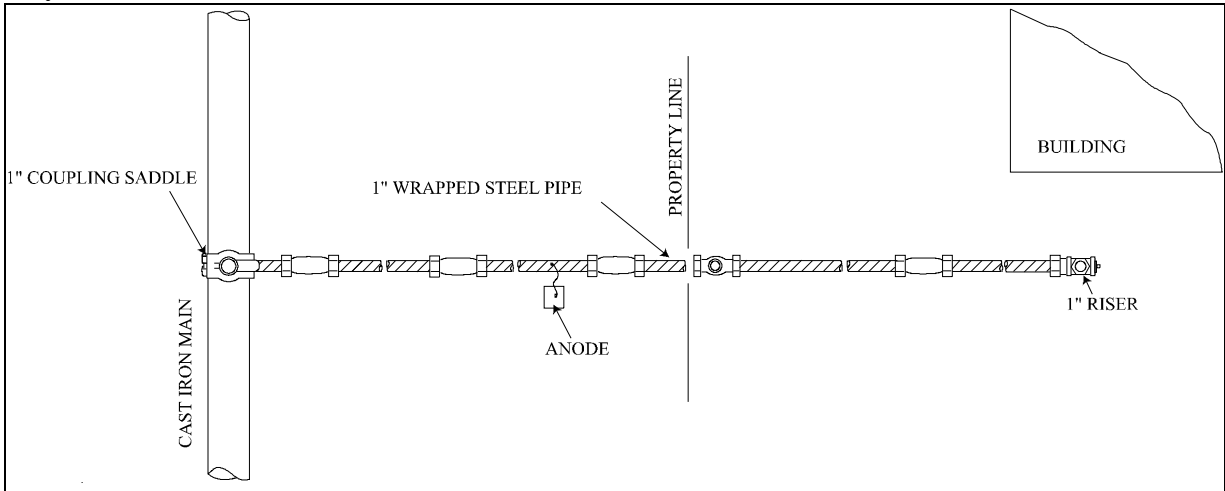
Plan



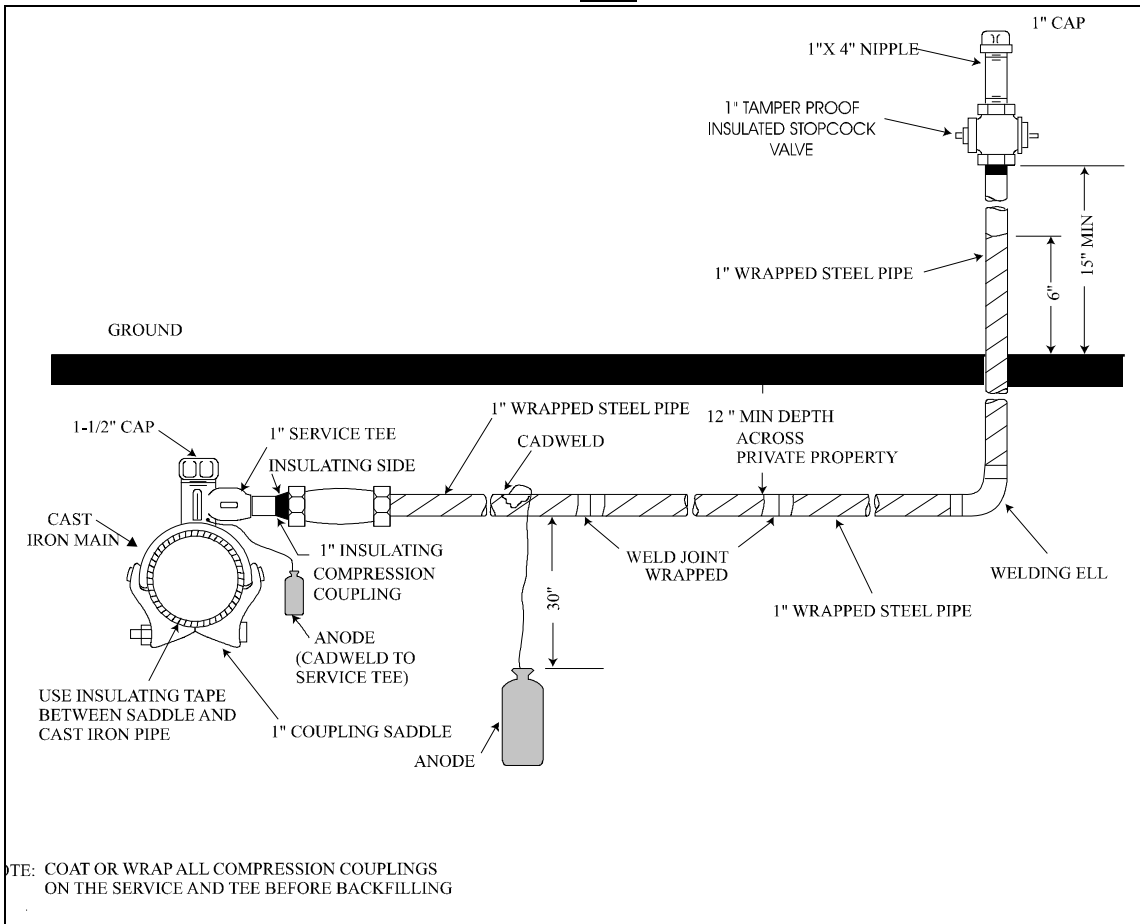
Elevation

Figure VI-22

An example of non-welded 1" service line from a cast iron main (for illustration purposes only).



Plan

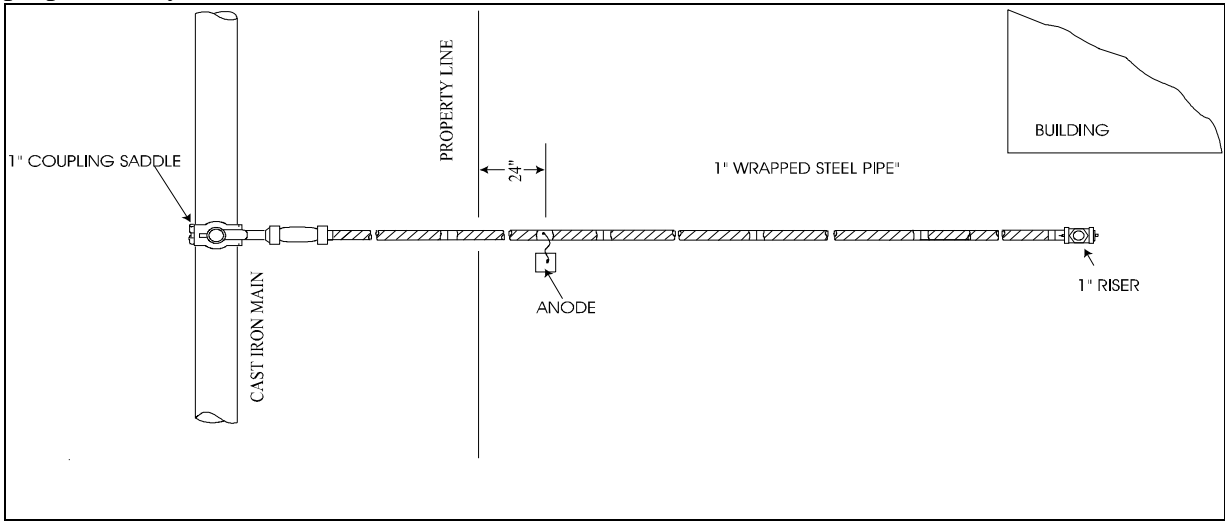


Elevation

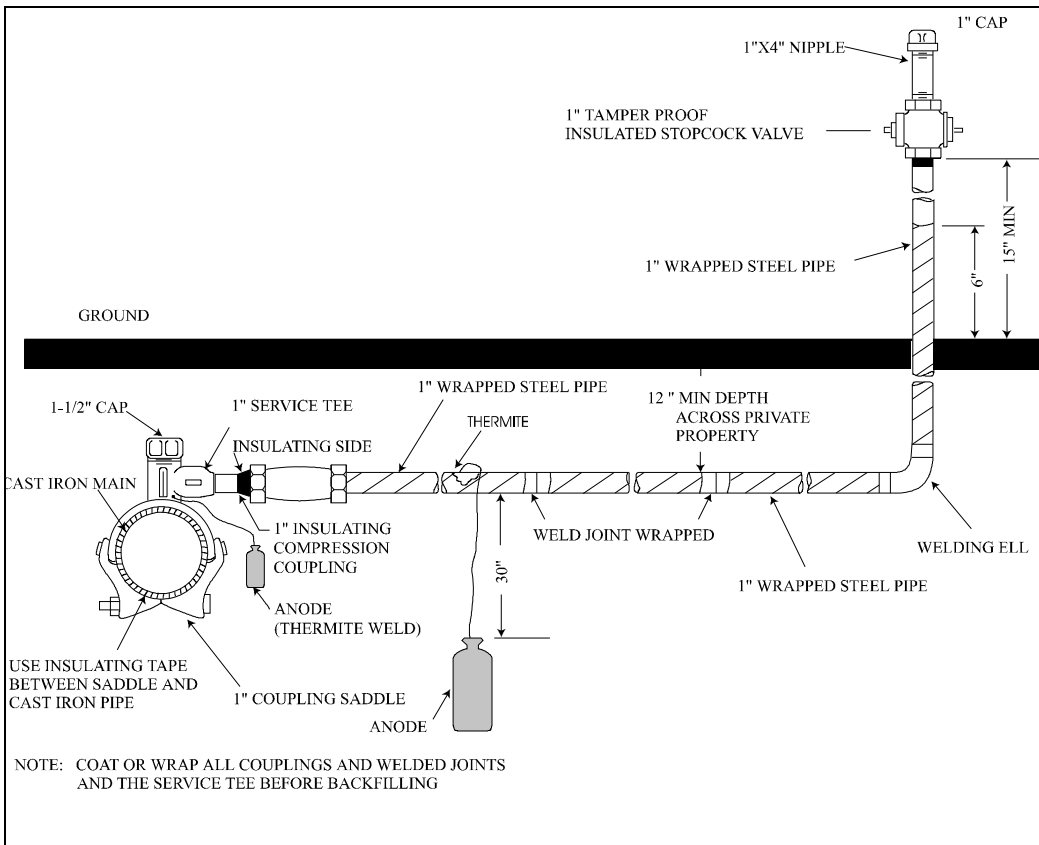


Figure VI-23

An example of a welded 1" steel service line from a cast iron main (for illustration purposes only).



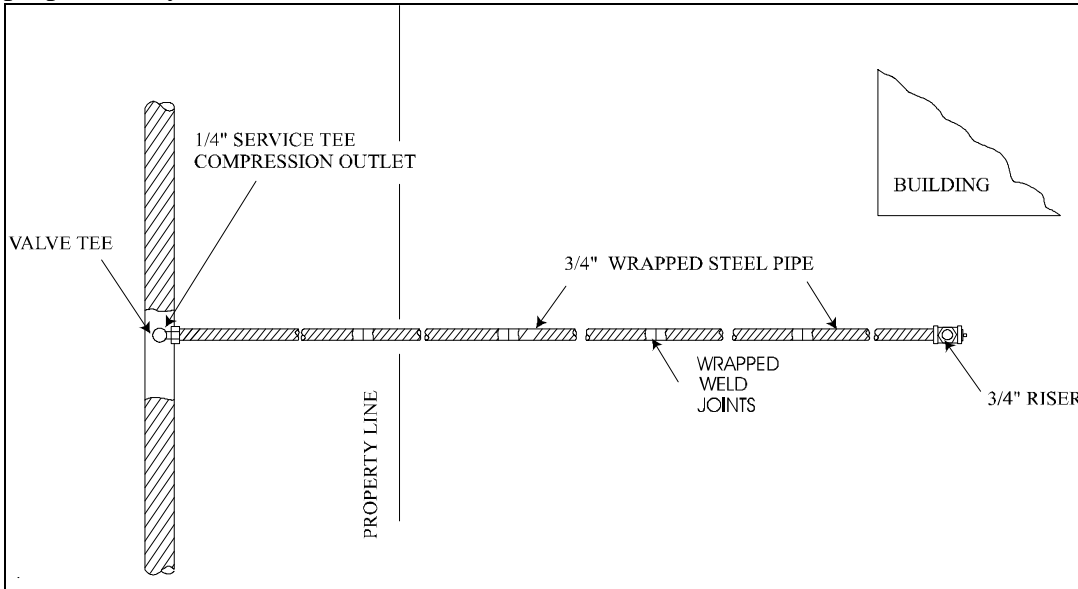
Plan



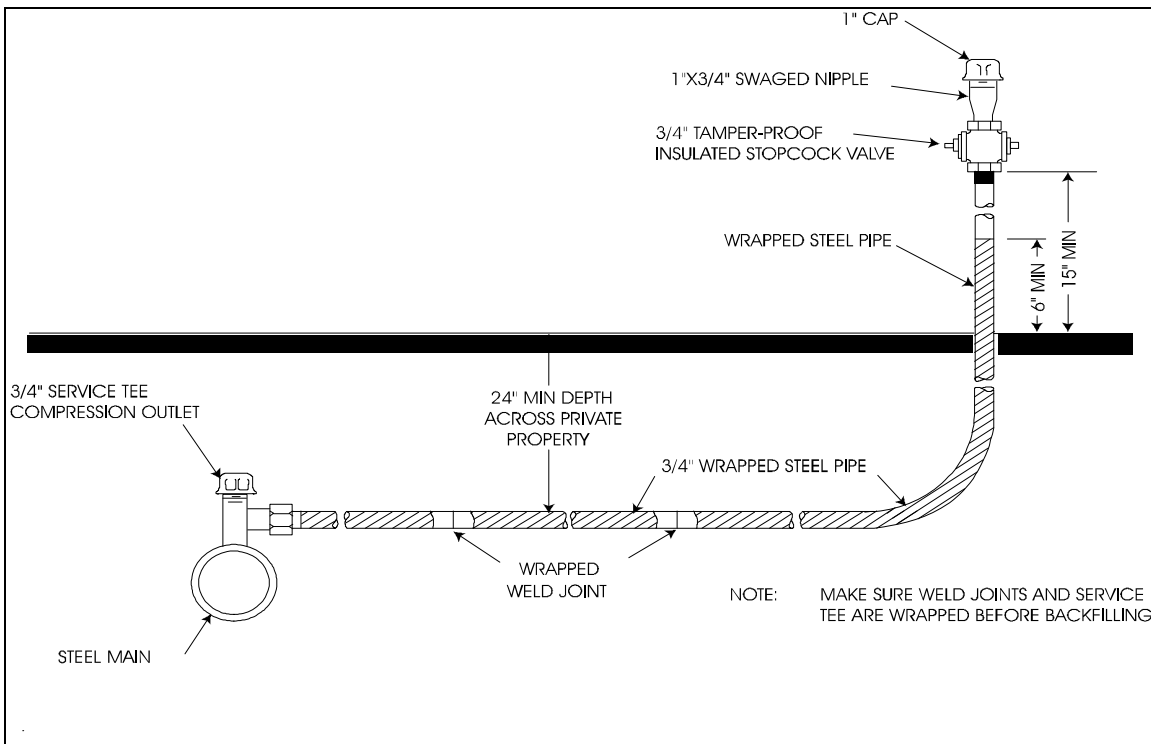
Elevation

Figure VI-24

Below is an example of a welded 3/4" service line from a steel main (for illustration purposes only).



Plan



Elevation

The following two pages (FIGURES VI-25A AND 25B) illustrate a steel-to-plastic connection using a coupling. There are other sizes of connections. Refer to specific manufacturer's instructions for the proper couplings and coupling procedures.

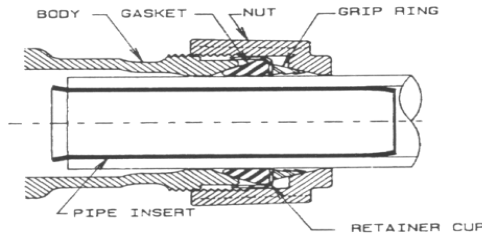
Figure VI-25a

# DRESSER®

## INSTALLATION INSTRUCTIONS

### Style 90 "Universal" Couplings & Fittings

For P.E. to P.E., P.E. to Steel & Steel to Steel  
(For use on polyethylene pipe listed in ASTM D2513)



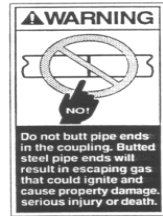
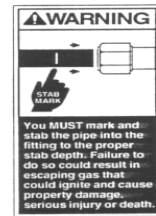
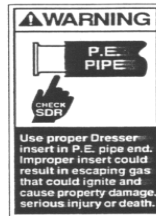
1. Clean steel pipe ends to bare metal removing oil, dirt, loose scale, and rust. Polyethylene pipe must be free of dirt, longitudinal scratches, grooves & burrs for a distance of 4" when using 5" long bodies or fittings & 7" on 10" long bodies.
2. On all P. E. pipe ends, the recommended Dresser insert stiffener must be installed. Before inserting in pipe end, each insert should be checked to ensure that the SDR indicated on the branding corresponds to the SDR of the pipe being used.
3. Remove plastic identification plug from nut, then loosen nut (DO NOT DISASSEMBLE) and check inside of the fitting to assure gasket and grip ring are loose and free of dirt or foreign matter.

4. Apply soap-water to the gaskets, only when installing on steel pipe (ethylene glycol may be added in freezing weather).
5. Mark each pipe 2" from pipe end. Stab the pipe end(s) into the fitting or coupling until the mark on the pipe is even with the edge of the nut or inside the nut.

*CAUTION: A minimum of 1/2" is required between the pipe ends or pipe end and pipe stop in fitting when connecting steel pipe(s).*

6. Tighten nut(s) independently while holding the body from rotating with a 100 lb. minimum pull on the recommended wrench size.

Nominal Pipe Size (I.D.)	Wrench Size
3/4"	14"
1"	18"
1-1/4"	18"
1-1/2"	24"
2"	24"



#### Product Rating For Couplings With Same Pipe Diameter On Both Ends (For Reducing Sizes, The Rating For The Smallest Diameter Applies)

Pipe Size		Max. Sealing Pressure (See Note 2)	Max. Steel Pipe Pullout Resistance	Polyethylene Pipe Pullout Resistance Up To The Max. Wall Listed In Table Meets Or Exceeds The Requirements Specified In D.O.T. 192.283(b) (See Note 1)	
				Type 2306	Type 3406/3408
Nom.	O.D.				
3/4"	1.050	150 P.S.I.	1300 lbs.	SDR 11	Sch. 40
1"	1.315	150 P.S.I.	2100 lbs.	SDR 11	SDR 9.3
1-1/4"	1.660	150 P.S.I.	3200 lbs.	SDR 10	SDR 9.3
1-1/2"	1.900	150 P.S.I.	3700 lbs.	---	SDR 11
2"	2.375	150 P.S.I.	6600 lbs.	SDR 9.3	SDR 9.3

NOTE 1 - Pullout resistance is based on using Dresser reinforcing pipe inserts.  
NOTE 2 - Unless noted on body.

**DMD DRESSER** DMD DIVISION, DRESSER INDUSTRIES, INC.  
41 FISHER AVENUE  
BRADFORD, PENNSYLVANIA 16701

# DRESSER®

## INSTALLATION INSTRUCTIONS

### “175” Meter/Curb Valve with Shield Nut 88 Ends for use on Polyethylene Tubing

**Tubing sizes 5/8" O.D., 1-1/8" O.D. and 1-3/8" O.D.  
with wall thickness from .062 through .101.**

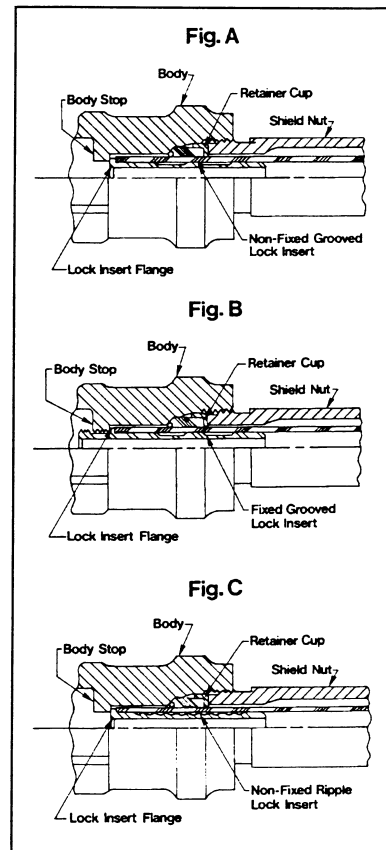
**DO NOT LUBRICATE GASKETS!**

1. Remove all burrs from end of tubing both I.D. and O.D.. Pipe surface must be clean and free of linear scratches or gouges that might impair the performance of the gasket seal.
2. Non-fixed grooved insert, Fig. A, 5/8", 1-1/8" and 1-3/8" sizes. Install insert in tubing making sure tubing contacts insert flange. Stab tubing into body to body stop. Tighten shield nut to iron bound (shoulder on shield nut must contact valve body).
3. Fixed grooved insert, Fig. B, 5/8", 1-1/8" and 1-3/8" sizes. Insert must be thread to body stop. Stab tubing with properly prepared end until tubing contacts flange on insert (see table for stab depth). Tighten shield nut as outlined under Step #2.
4. Non-fixed ripple insert, Fig. C, 7/8" size only. Install insert in tubing making sure tubing contacts the insert flange. Stab tubing into body to body stop. Tighten the shield nut. Recommended torque 75 lb. using 14" pipe wrench.

**Note:** Use only those parts furnished by Dresser.

Tubing O.D.	Stab Depth*	
	Max.	Min.
5/8"	4-1/4"	4-1/8"
7/8"	4-3/8"	4-1/2"
1-1/8"	4-1/2"	4-3/8"
1-3/8"	5-1/16"	4-7/8"

*\*Stab depth is the distance tubing should be inserted from end of shield nut to body stop with shield nut loose but in contact with retainer cup.*



**WARNING**

Use proper Dresser insert in P.E. pipe end. Improper insert could result in escaping gas that could ignite and cause property damage, serious injury or death.



**DMD DIVISION, DRESSER INDUSTRIES, INC.**  
41 FISHER AVENUE  
BRADFORD, PENNSYLVANIA 16701

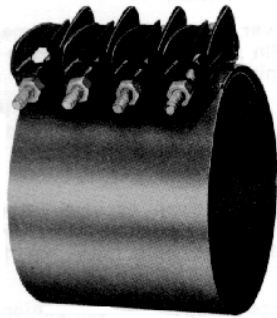
Figure VI-26 Repair Clamps

These are simple repair clamps that are useful in repairing small underground corrosion leaks.

# DRESSER

## GAS PRODUCT INSTALLATION MANUAL

### Style 130 Repair Clamp

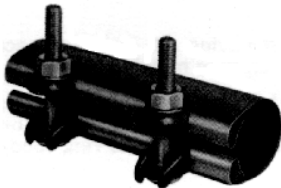


SAMPLE

1. DO NOT CUT GASKET -- IT IS CORRECT LENGTH AND WIDTH.
2. Clean pipe thoroughly where gasket is to seat. Smooth any rough spots.
3. Lubricate pipe with soap-water to help gasket slide into correct position.
4. Open the clamp and place it around the pipe, making sure the spanner at split of clamp is located under the band. Do remove the bolts, since bolt heads drop into the slots in lugs without being removed.
5. Hook bolts into slots and finger-tighten. Gasket ends should butt together-- NOT overlap.
6. Locate the joint in the gasket away from holes being repaired.
7. Center the clamp over the leak and tighten the bolts to 50 ft. lbs. torque.

**Note:** When pipe movement out of the clamp might occur, proper anchorage of the pipe must be provided.

### Style 118 HANDIBAND<sup>®</sup> Repair Clamp



1. Clean pipe thoroughly where gasket is to seat.
2. Lubricate gasket and clean area of pipe with soap-water (ethylene glycol should be added in freezing weather).
3. Place clamp around pipe with gasket centered over leak. Hook bolt head in slotted lug and tighten the nut.

---

## PLASTIC PIPE INSTALLATION CONCERNS – BRITTLE LIKE FRACTURES

---

Figures VI-16 through VI-19 illustrates plastic service line connections to gas mains. There have been accidents due to the failure of the plastic pipe in certain types of installations. These installations are associated with older PE pipe (1960s through early 1980s), which may be vulnerable to fractures and brittle-like cracking. The key areas of concern are where the pipe may not be properly supported in a transition area, which may cause excessive bending of the pipe.

The transition area is where the plastic pipe is connected to a fitting, valve, or riser. As the earth settles, inadequately supported plastic pipe may be subjected to high bending stresses and possible failure. Figures VI-16 through VI-19 show the use of protective sleeves in the transition areas. Protective sleeves, along with attention to adequate backfill and support, can help to avoid excessive stresses. The design of a protective sleeve depends on type of soil, size of pipe, composition of the backfill, and size of the access trench or bell hole. It is imperative that pipeline operators review and follow the specific sleeving and support instructions provided by the pipe manufacturer.

Excessive bending of pipe in non-transition areas can also result in excessive stresses that can lead to plastic pipe failure. If the pipe is installed with very tight bends, the pipe wall can be stressed beyond manufacturer's recommendations. This can result in brittle-like fracture of the pipe wall. Every manufacturer has a recommended maximum bending radius for each type and size of pipe. The maximum bending radius is increased for pipe spans that contain a fusion or mechanical joint. It is imperative that the installation of plastic pipe does not exceed the maximum bending limits for each type of pipe.

Backfill material should consist of sand or native soil containing no sharp rocks or other foreign objects. Backfill material containing sharp rocks can damage the pipe and cause accidents. Proper backfill and support are essential to the installation and safe, long-term performance of plastic pipe.

## CHAPTER VII: SERVICE LINES, CUSTOMER METERS AND REGULATOR SETS

---

Before locating service lines, customer meters and regulators, three points must be considered: accessibility, protection of meter sets from damage, and protection of people from release of gas at the meter set.

### CUSTOMER METERS AND REGULATORS: LOCATION

---

Install meters and service regulators in a readily accessible location. Protect the meters and regulators from corrosion and other damage. Whenever possible, locate the meter set away from vehicular traffic. If a meter set must be located where a vehicle could damage the meter set, a suitable barricade must be installed. Always ensure that the meter sets are properly supported. Install meters outside if possible (see Figure VII-1). Additional protection for outside meters may be necessary where ice or snow falling from roofs may damage the meter or block the regulator vent.

Figure VII-1: Outside Gas Meter with Vehicular Damage Protection



Figure VII-2

This meter may be readily accessible, but is neither protected from outside damage nor properly supported. Meters should not be installed touching the ground as shown below.



Service regulators installed inside a building must be placed as close as practical to the point where the service line enters the building. The regulator must be vented to the outside where gas can escape freely into the atmosphere (see Figure VII-6). A vent screen should be installed in the end of the vent piping to prevent insects, spiders, etc. from entering the vent pipe.

Meters installed inside a building must be located in a ventilated place. A meter must be more than 3 feet from any source of ignition or any source of heat that might damage the meter.

It is best to locate the upstream regulator (in a series) outside the building. However, the operator may locate regulators in a separate metering or regulating building.



## CUSTOMER METERS AND REGULATORS: PROTECTION FROM DAMAGE

Protection from vacuum or backpressure. If customer equipment might create either a vacuum or a backpressure, protection devices must be installed on the gas system.

Service regulator vents and relief vents. The outside terminal of each service regulator vent and relief vent must be:

- Rain, snow, ice and insect resistant;
- Located where gas from the vent can escape freely into the atmosphere (vent it 3 feet or more away from any opening into the building);
- Protected from water damage in areas where flooding or ice accumulation may occur (put it where it will not be underwater in a flood or subject to ice accumulation) or damaged by falling ice or snow.

The meters and regulators must be installed to minimize stresses on connecting piping. Each pit or vault in a road, driveway, or parking area that houses a customer's meter or regulator must be able to support the vehicle traffic that could use that road, driveway, or parking area.

## CUSTOMER METERS INSTALLATIONS: OPERATING PRESSURE

A meter may not be used at a pressure that is more than 67 percent of the manufacturer's shell test pressure ( $0.67 \times$  shell test pressure).

The operator must ensure that each newly installed meter has been tested to a minimum of 10 psig.

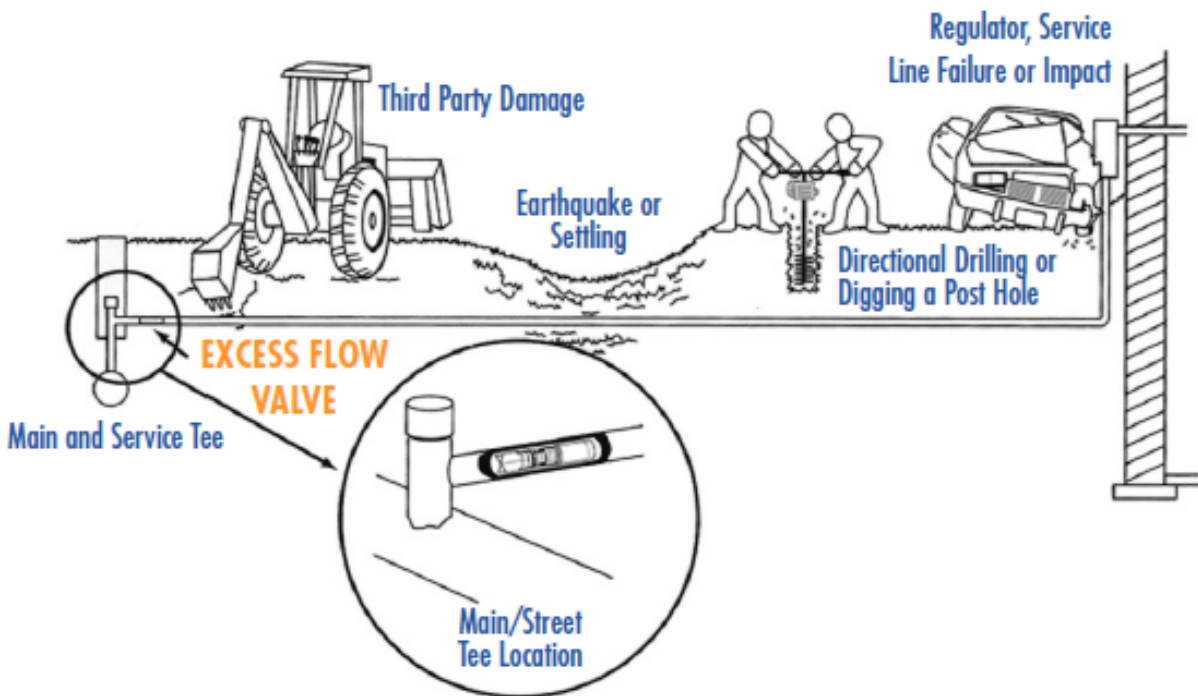
## SERVICE LINES: LOCATION OF VALVES

- Relation to regulator or meter. Each service line valve must be installed upstream of the regulator. If there is no regulator, install the valve upstream of the meter (see FIGURES VII-4 through VII-6).
- Outside valves. Each service line must have a shut-off valve in a readily accessible location outside of the building (see FIGURE VII-2).
- Underground valves. Each underground service line valve must be located in a covered, durable curb box or standpipe that allows ready operation of the valve. **The box or standpipe must not put stress on the service line** (see FIGURES VII-3 and VII-4).

## EXCESS FLOW VALVES

An Excess Flow Valve (EFV) is a device installed in a service line that automatically closes if the flow through the service line exceeds a preset amount. The purpose of an EFV is to shut off gas flow if the service line is ruptured thereby reducing the risk of fire damage and injury.

Figure VII-3: Typical EFV installation.



Courtesy of GasBreaker, Inc.

For maximum benefit, EFVs should be installed as close to the main as possible.

Federal regulations (§192.383) require that all new and replaced single and branched service lines to single family residences include an EFV if the service line operates over 10 psig unless there is a history of problems with liquids or debris in the lines that might interfere with the operation of an EFV. EFVs are also required to be installed on multifamily residences, and small commercial entities consuming gas volumes not exceeding 1,000 Standard Cubic Feet per Hour.

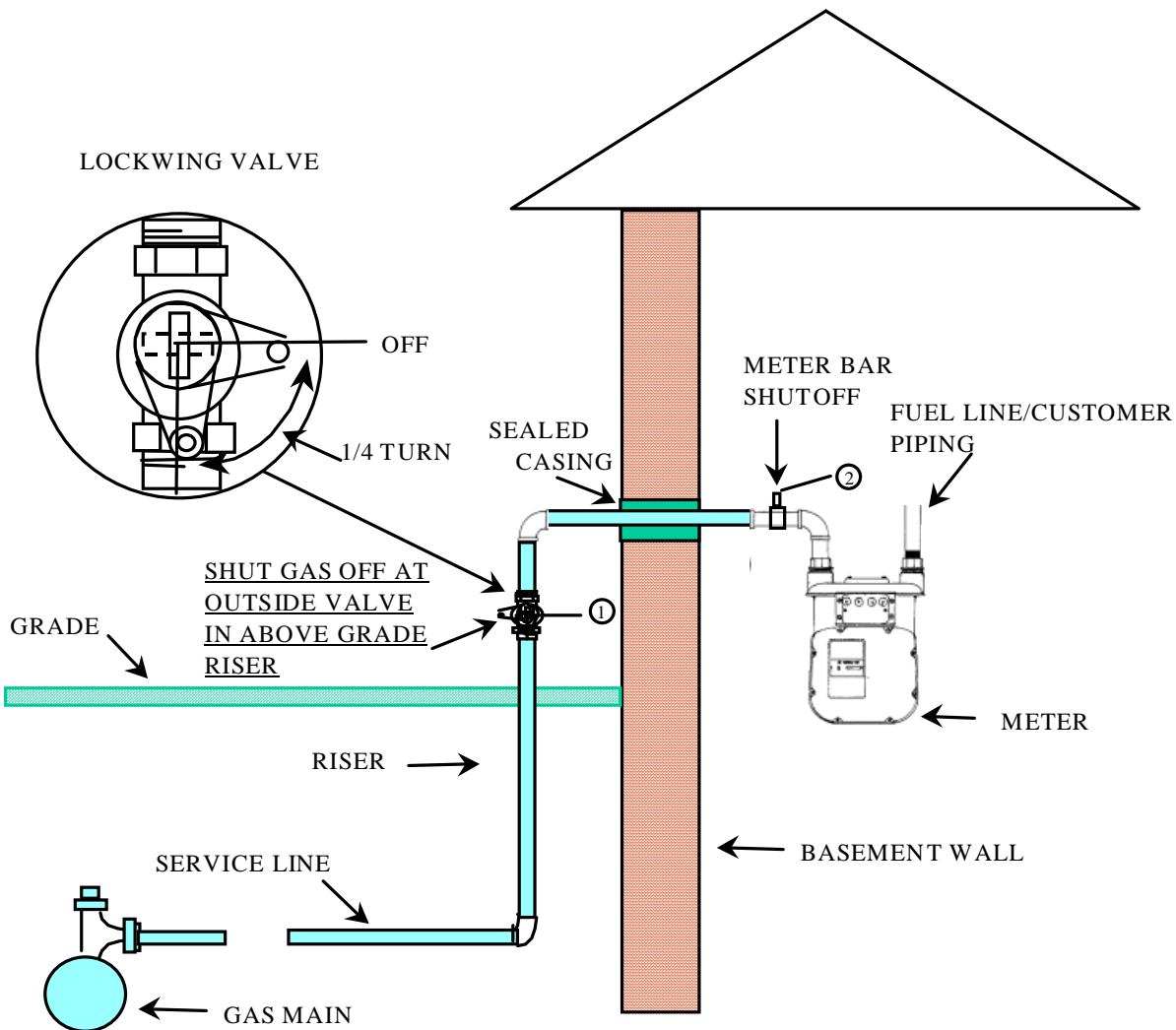
Selecting the proper size EFV is critical. Sizing requires knowing the maximum gas demand of all the appliances connected to the service line. For branched or multi-family residential service lines the maximum gas load for all the residential units connected to the service must be known. Each EFV is set to close at a specific flow rate. If the EFV's closure flow rate is less than the flow rate necessary to operate all the gas-burning equipment connected to the service line, the EFV may close under non-emergency conditions. If the EFV's closure flow rate is too high, the EFV may not close even if the service line is ruptured. In selecting an EFV the potential for the

customer to add additional gas-burning equipment should also be considered. EFV manufacturers can provide guidance for selecting the proper EFV.

## SERVICE LINE LOCATION

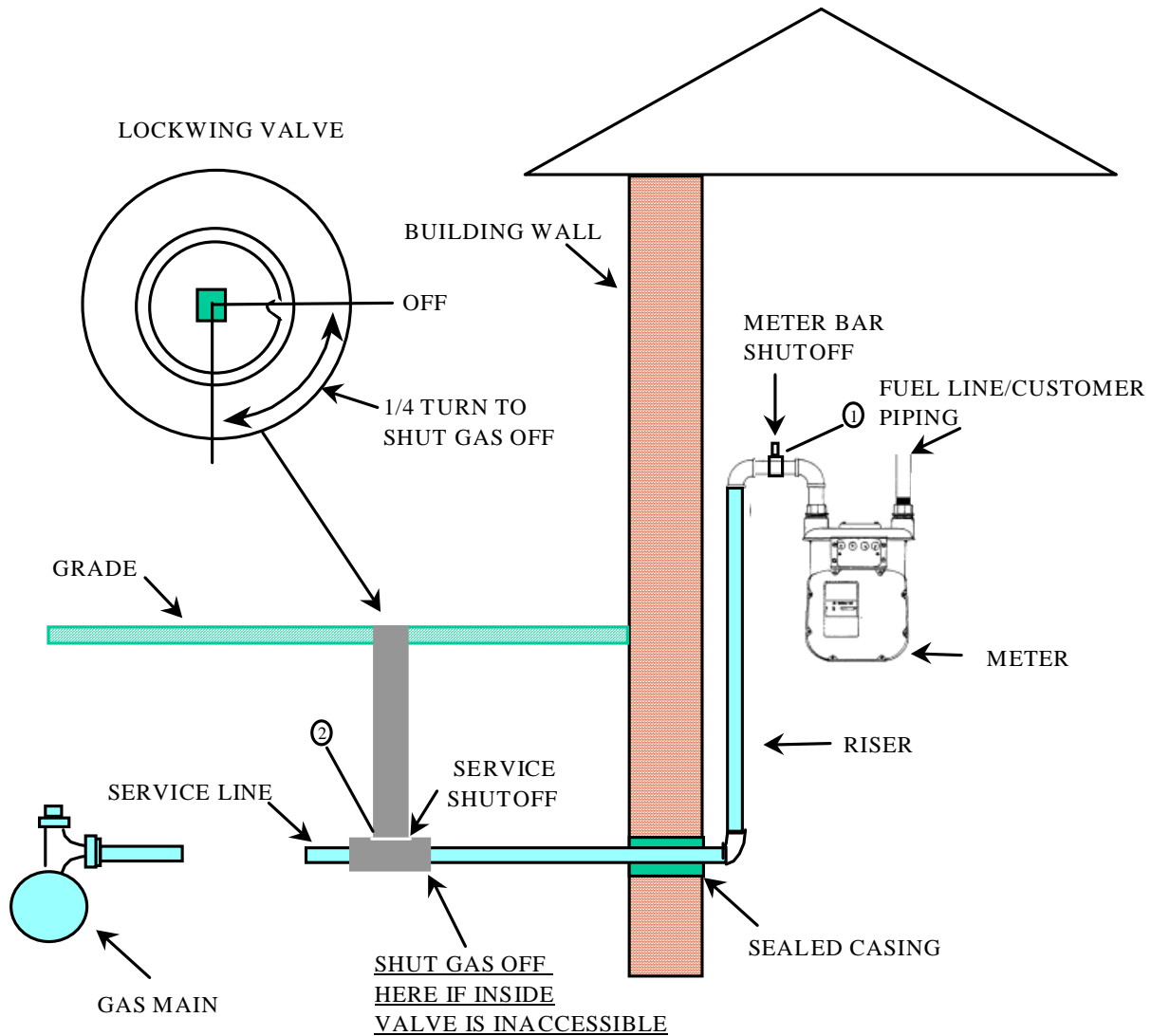
Services should not be installed under buildings or mobile homes. If a service is installed under a building, it must be encased in a gas-tight conduit. This conduit must vent to the outside at a point where gas would not be a hazard and must terminate aboveground in a rain, snow, ice and insect resistant fitting.

Figure VII-4



This is a typical low-pressure service (pressure in main and service are essentially the same as customer utilization pressure). Note that this service can be shut off at either (1) or (2) as shown on drawing. This service would be in compliance with 49 CFR §192.365. The valve at either points (1) or (2) must be designed so that it can be locked in a closed position. Depending on the type of valve, more than a quarter turn may be required to shut off gas.

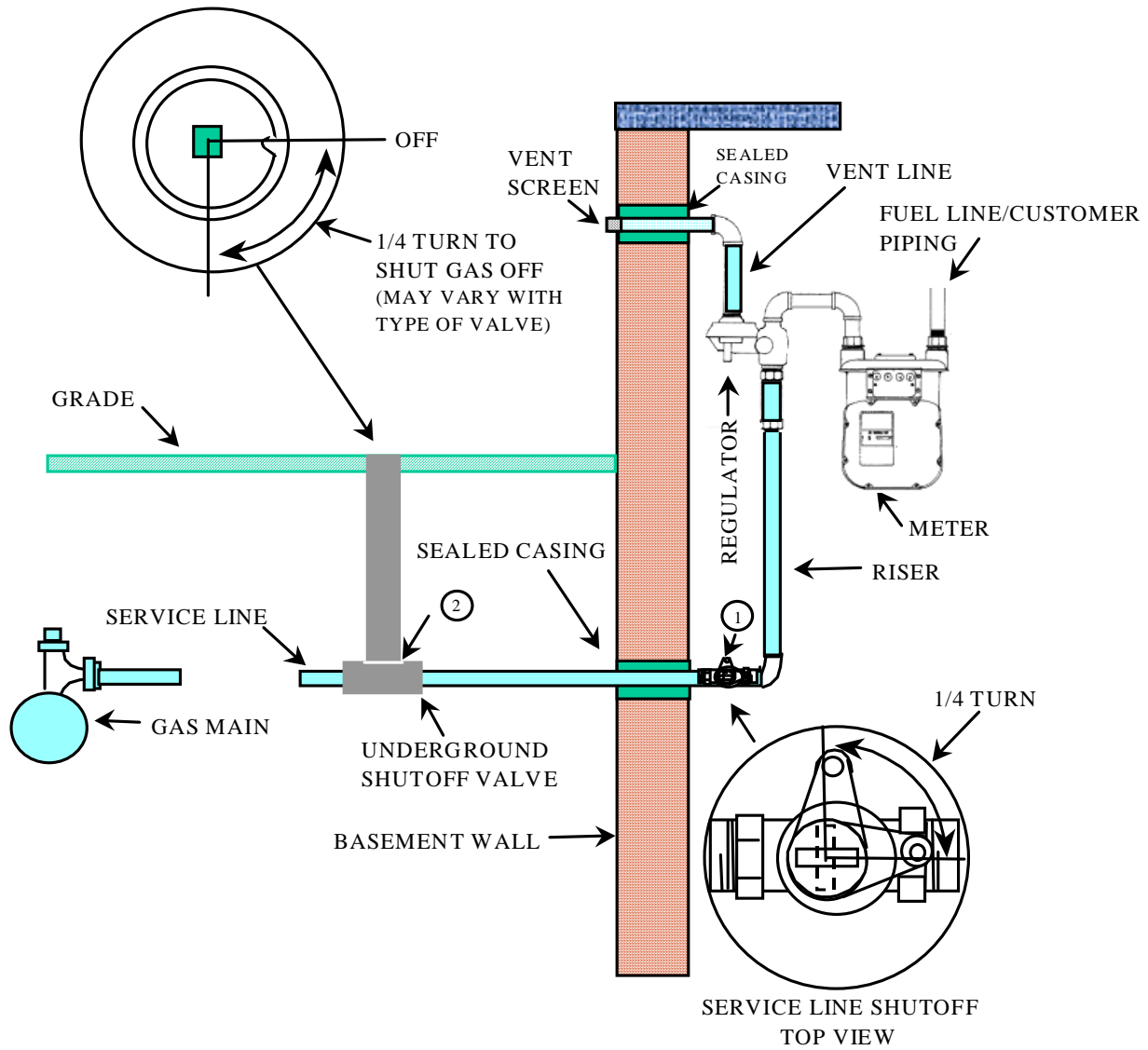
Figure VII-5



Note that this service can be shut-off at either points (1) or (2). The valve at point (1) must be designed so that it can be locked in a closed position. The valve at point (2) is installed in a valve box. Depending on the type of valve, more than a quarter turn may be required to shut off gas.

Figure VII-6

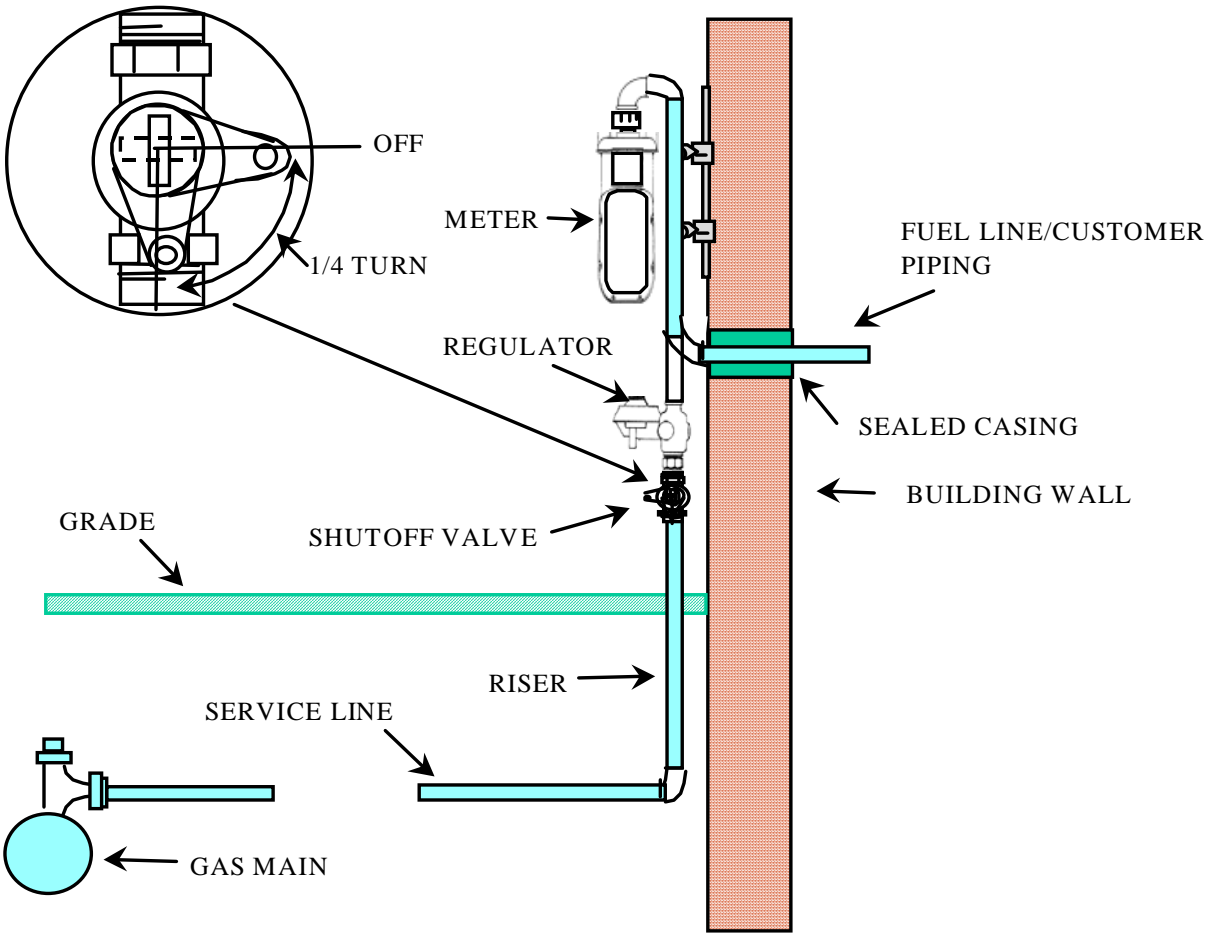
OUTSIDE SHUTOFF VALVE EXTENSION  
TOP VIEW



The service can be shut off at either point (1) or (2). Note that the shutoff valve at point (1) is installed before the regulator. The valve at point (1) must be designed so that it can be locked in a closed position. Depending on the type of valve, more than a quarter turn may be required to shut off gas.

Figure VII-7

SERVICE LINE SHUTOFF  
TOP VIEW



Note that the shutoff valve is before the regulator and meter. This valve must be designed so that it can be locked in the closed position. Depending on the type of valve, more than a quarter turn may be required to shut off gas. The aboveground portion of the riser must be metal unless an anodeless riser is used (see description of anodeless risers in Chapter VI).

---

## COMMON PROBLEMS AT SERVICE RISER AND HOUSE REGULATORS

---

- Regulator vandalism or damage. This can be very hazardous. If the regulator fails to function for any reason, high-pressure gas may enter the appliances. Tall flames at the burner or escape of gas could cause a fire or explosion.
- Obstructed vents. The vent on the regulator should be free of any obstructions. A wire screen installed at the vent should prevent the accumulation of dirt, the intentional insertion of foreign objects by children, or the build up of insect nests (e.g., wasp nests). If the screen is removed, a new one must be inserted in its place. A non-functioning vent could cause regulator failure and present a serious fire hazard. The vent should be away from windows and air intakes and protected from the elements. Vent should be installed so that water or snow cannot enter the vent terminus.
- Tenants move out. The valve on the meter riser should be equipped with a locking device to be controlled by authorized personnel only. When tenants move out, the gas must be shut off and the valve locked until new tenants move in. The locking device on the shutoff valve also allows the repair of appliances without the gas being accidentally turned on.
- Riser misuse. The tenants or customers should not be allowed to use the riser and its components for other purposes. Never use the riser as an anchor for laundry lines, plant supports, or bicycle racks (see CHAPTER III, FIGURE 17).
- Corrosion. Check for corrosion on the service riser at ground level (at the ground/air interface) (see CHAPTER III, FIGURE 24).

---

## DISCONTINUING SERVICE TO A CUSTOMER

---

When service to a customer is discontinued, one of the following must be done:

1. The valve must be closed to prevent the flow of natural gas to the customer. This valve must be secured with a lock or some other device to prevent opening of the valve by unauthorized persons. There are numerous locking devices designed for this purpose (see FIGURES VII-4 and VII-5).
2. A mechanical device or fitting that will prevent the flow of gas must be installed in the service line or in the meter assembly.
3. The customer's piping must be physically disconnected from the gas supply and sealed at both ends (see FIGURE VII-6).



FIGURE VII-4: Service line valve which has been locked to prevent the opening of the valve by unauthorized people.

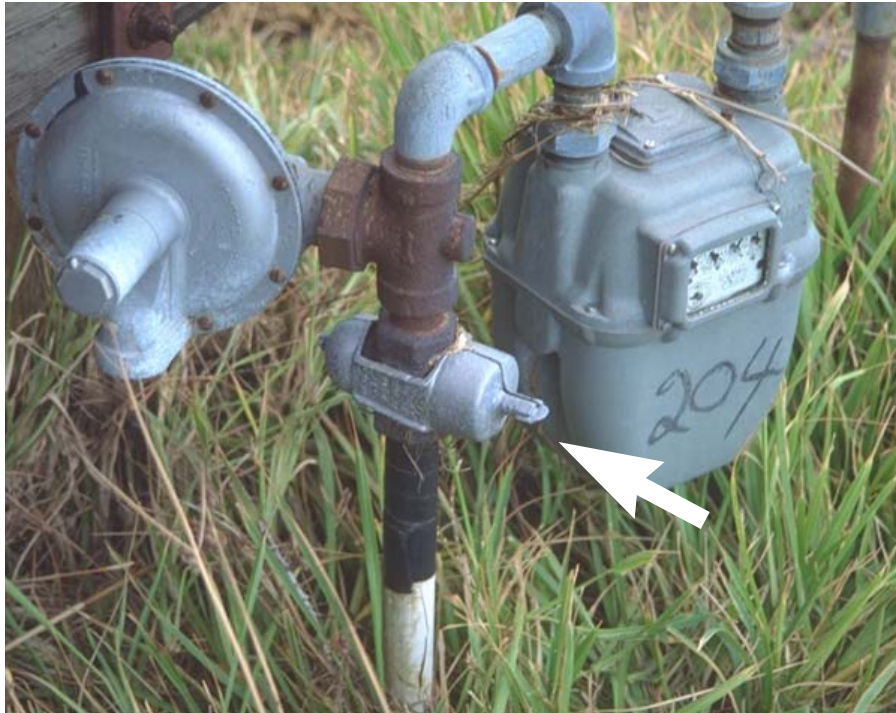


FIGURE VII-5: Example of a service that has been shut off (note position of meter valve) but not locked to prevent opening. This DOES NOT meet the pipeline safety regulations.

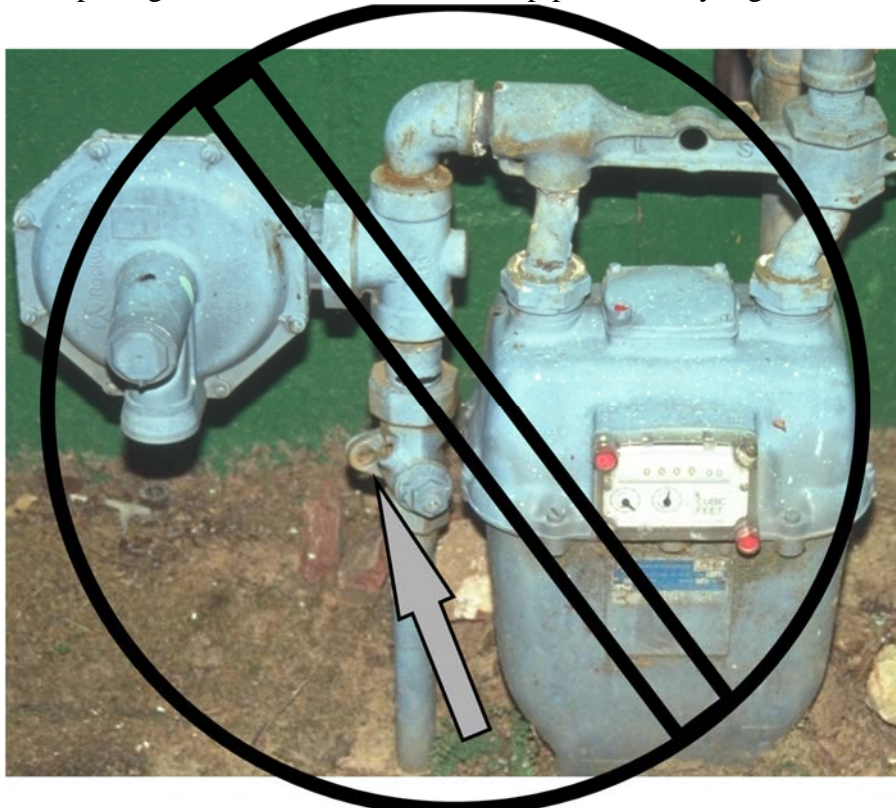
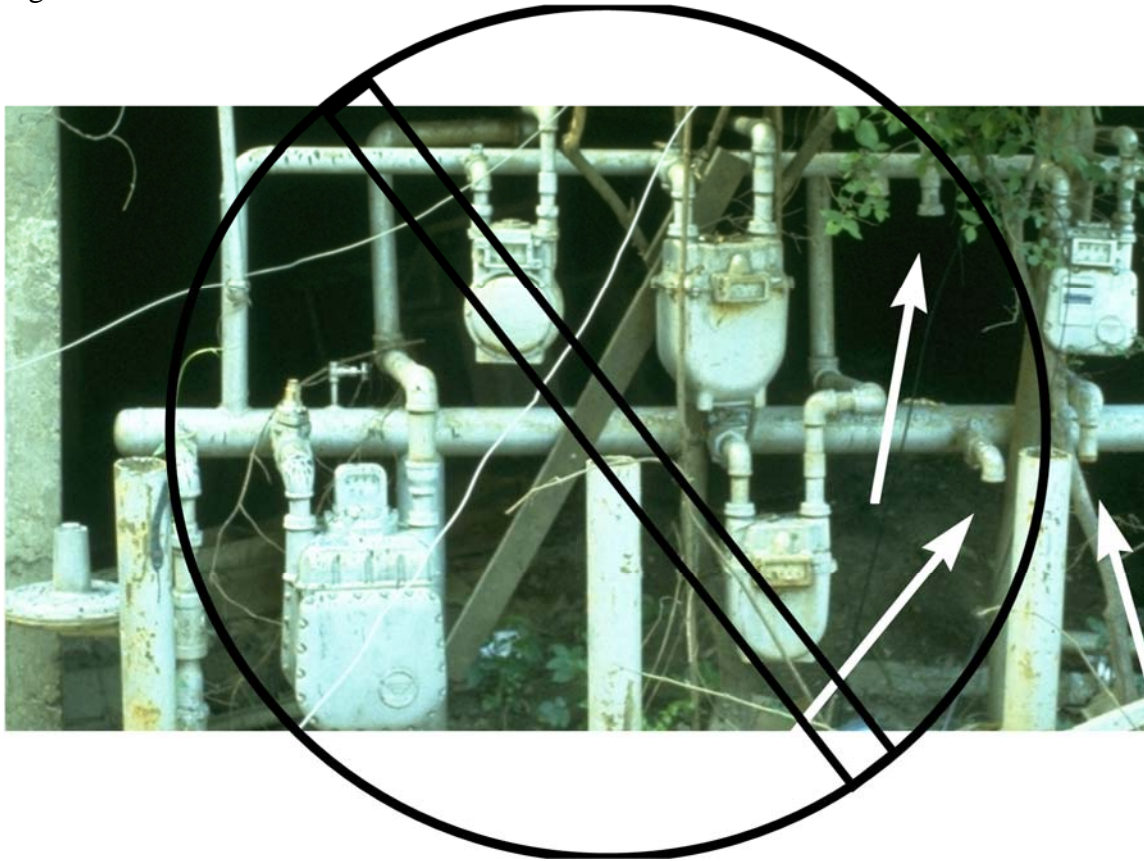




FIGURE VII-6: Example of service meters that were removed but the shutoff valve of each was not locked, and the pipes were not plugged. This is A VIOLATION of the pipeline safety regulations.



## CHAPTER VIII: PLANS AND REPORTS REQUIRED BY THE FEDERAL GOVERNMENT

---

### PLANS REQUIRED BY THE FEDERAL GOVERNMENT

---

All operators of natural gas systems are required to maintain a number of plans for safe operation of the system. The following table summarizes the basic requirements for these plans.

Plan	Operator types covered Transmission (T) Distribution (D) Master Meter (MM)	Code Section Requiring Plan	Update Frequency
Operations & Maintenance	MM , D & T	192.605	Annual
Emergency Plan	MM , D & T	192.615	Annual
Public Awareness	MM , D & T	192.616	Annual recommended
Transmission Integrity Management	T	192.907	As needed
Distribution Integrity Management	MM & D	192.1005	At least once every 5 years
Anti-drug Plan	D & T	199.101	As needed
Alcohol Misuse Prevention Plan	D & T	199.202	As needed
Operator Qualification Plan	MM , D & T	192 Subpart N	As needed
Control Room Management Plan	D & T	192.631	As needed

---

## OPERATIONS AND MAINTENANCE PLANS

---

An operations and maintenance (O&M) plan is required of all natural gas operators by the pipeline safety regulations. The O&M plan must be written and followed to help the operator comply with the pipeline safety regulations (see 49 CFR §192.603 for further information). Most operators comply with this requirement by developing and maintaining a manual that incorporates both plans. The manual must be kept at locations where O&M activities are conducted. This manual fulfills the requirements of 49 CFR §192.605.

This section outlines the procedures that must be addressed in the O&M plan. For master meter operators, the first 22 of these procedures (lettered A-V) must usually be addressed in the O&M plan. Five additional procedures (lettered W-AA) may apply to some operators of small natural gas systems, but most likely will apply only to larger or more complex systems such as those operated by a small municipality.

Some items addressed in this section may not be relevant to every natural gas system. **However, a procedure required by the pipeline safety regulations must be included in the plan.** Some of the key items that pipeline safety inspectors will look for during an audit are:

- Completeness of the O&M procedures;
- Omission or deficiency of an applicable portion of the plan;
- Not having a plan readily available for review;
- Not providing for an annual update and review of the procedures in the plan;
- Not having a plan at all.

O&M plans must contain the following components (as applicable):

- A. Determination of Class Location(s). The operator must determine the Class location for each part of its system. More stringent safety requirements may apply in some locations (see 49 CFR §192.5 for further information). Many small operators address this requirement by treating the entire system as if it falls in the highest (and most stringent) reasonable Class location, which is Class 3.
- B. Customer notification. If the operator does not maintain customer-owned service lines, the operator must have written procedures for notifying each customer once in writing of a customer owned service line that the company does not maintain or monitor for corrosion if the customer owned pipe is metallic, does not conduct leak surveys, and if an unsafe condition is found, the company will shut off the flow of gas, advising the customer of the need to repair the unsafe condition. (see 49 CFR §192.16)

- C. Public Awareness. See discussion of public awareness plans on page VIII-15.
- D. Investigation of Failures. The operator must have procedures for analyzing accidents and failures to determine the cause(s) of the failure in order to minimize the probability of a recurrence (see 49 CFR §192.617 for further information).
- E. Maximum Allowable Operating Pressure (MAOP). This is the maximum pressure at which each segment of a natural gas system may operate. The operator establishes MAOP. If the pipeline is tested to 100 psig as recommended in this guidance manual, the MAOP of the system will be 60 psig (see 49 CFR §192.619, .621, and .623 for further information). An alternate MAOP determination can be made under 49 CFR §192.620 provided: 1) the pipeline segment is in a Class 1,2 or 3 location, 2) the pipeline segment is constructed of steel pipe meeting the additional design requirements in 192.112, 3.
- F. Tapping and/or Purging of Pipelines. If tapping and/or purging are performed on the pipeline system, any procedure that is utilized must be in the O&M plan. Necessary information includes type of equipment, qualified personnel, technique, and the applicable procedures for performing the operation (see 49 CFR §192.627 and §192.629 for further information).
- G. Odorization  
Master Meter Operators. The plan must contain a provision for the measurement of the odor of natural gas. A periodic “sniff test” is sufficient if the natural gas company that supplies the gas provides proof of odorization. At least quarterly the operator should ask tenants, especially heavy smokers, the elderly and others who may have impaired sense of smell, to smell the gas at an open valve or gas oven burner at various locations in the system. If they cannot detect an odor, the gas supplier should be notified. Make sure to keep records of these tests, including dates, names, and locations. Sample forms are in Appendix B (Form 11) (see 49 CFR §192.625 for further information).

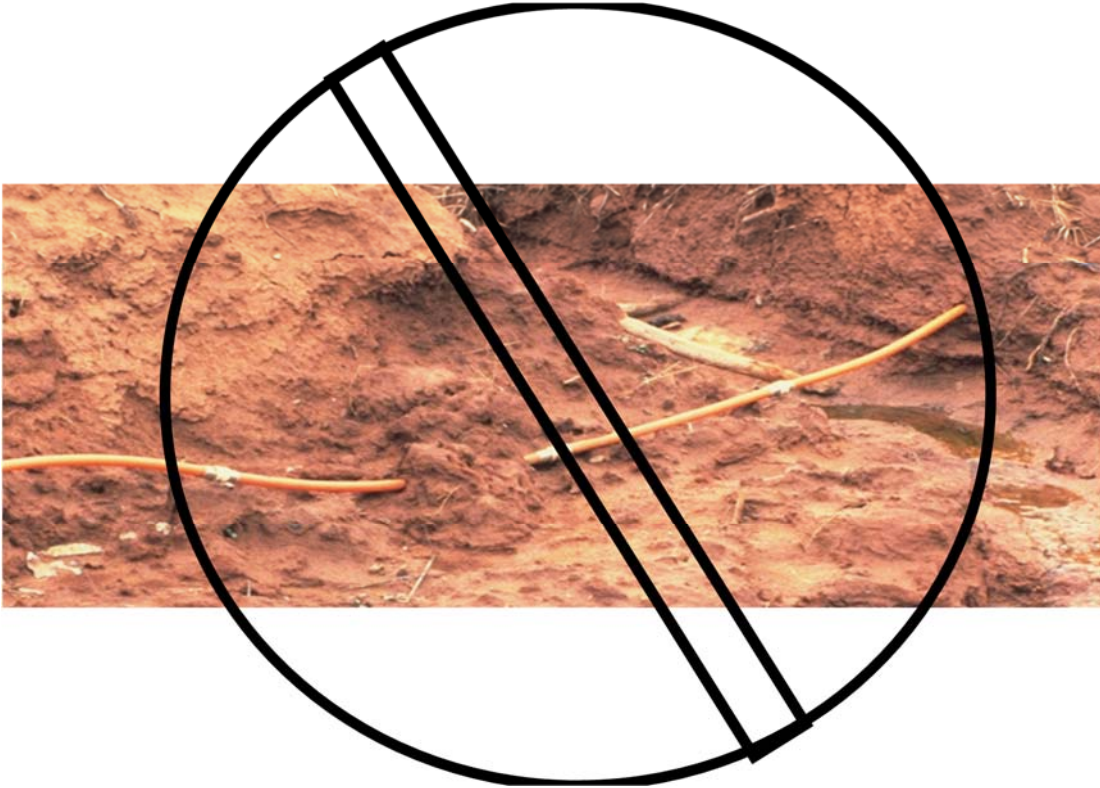
Other than Master Meter Operators. Operators must ensure that there is enough odorant in the gas to provide a distinct odor when natural gas is present in air at a concentration of one-fifth of the lower explosive limit. The lower explosive limit for natural gas occurs at approximately 4 percent natural gas in air by volume; therefore, odorant must be detectable at approximately 0.8 percent gas in air by volume. (see Chapter IV and 49 CFR §192.625 for further information).

- H. Patrolling. Operators must include in the plan provisions for patrolling mains located in places or on structures where anticipated physical movement or external loading (e.g., weight and traffic) could cause failure or leakage. These places include bridges, waterways, landslide areas, areas susceptible to earth subsidence (cave ins), or areas of construction activity.

Patrolling of these mains must be conducted at least four times each year in business districts and twice a year outside business districts (Appendix B, Form 4).add intervals Patrolling can

be done by walking along the pipeline and observing factors affecting safe operation (see 49 CFR §192.721 for further information).

Figure VIII-1: Example of a washout area found by patrol.



I. Leakage Surveys. A leakage survey with leak detector equipment (FI, Optical IR, Laser or CGI) must be conducted in business districts at intervals not exceeding 15 months, but at least once each calendar year and outside business districts as frequently as necessary, but at least once every 5 calendar years at intervals not exceeding 63 months (see Chapter IV for more information on leakage surveys).

J. Line Markers. The O&M plan must specify guidelines for placing pipeline markers. The following are the federal requirements:

Buried Distribution Pipelines. A line marker must be placed and maintained as close as possible over each buried distribution main at each crossing of a highway, street, or railroad. A line marker must also be placed wherever necessary to identify the location of the main to reduce the possibility of damage or interference. Line markers are not required for buried mains in Class 3 or 4 locations where the pipeline system operator participates in a damage prevention program (such as "One-Call" or "call before you dig" system) or for transmission lines where placement would be impractical.

Pipelines Aboveground. Line markers must be placed and maintained along each section of pipeline that is located above ground in an area accessible to the public. A typical example is an unsecured pressure regulating station.

Markers. The following must be written legibly on a background of sharply contrasting color on each line marker:

1. The word "Warning," "Caution," or "Danger" followed by the words "Gas (or name of gas transported) Pipeline." Letters must be at least one inch high with an approximate stroke of one-quarter inch.
2. The name of the operator and the telephone number (including area code) where the operator can be reached at all times (see FIGURE VIII-2).

Figure VIII-2: Pipeline marker that meets the federal requirements



K. Testing for Reinstating a Service Line. The plan must contain a provision for testing each disconnected service line from a main before placing it back into service. For small distribution and master meter operators testing at 100 psig is suggested. See 49 CFR §192.511 and §192.725 for further information.

L. Abandonment of Facilities. The plan must include provisions for shutdown, abandonment, or inactivation of facilities. (see 49 CFR §192.727 for further information).

Records should be kept on all abandoned facilities including location, date, and method of discontinuing service.

M. Key Valve Maintenance. Key valves, or critical valves, are the valves needed to shut down the system, or part of the system, in case of an emergency. For most master meter systems,

this may involve only one or two valves. Key valves must be checked at intervals not exceeding 15 months but least once each calendar year to ensure that they are operable. Procedures for key valve inspections and maintenance of records must be included in the plan. Sample forms are in APPENDIX B (FORMS 8 and 9) (see 49 CFR §192.747 for further information).

- N. Accidental Ignition of Gas. The plan must include provisions to prevent the accidental ignition of gas. Gas alone is not explosive, but when mixed with air in a 4 to 15 percent concentration it can ignite. Every precaution should be taken to prevent unintentional ignition of natural gas and each potential source of ignition must be removed when venting a hazardous amount of natural gas. A fire extinguisher must be available and ready for immediate use (see 49 CFR §192.751 for further information).
- O. Corrosion Protection. Provisions should be made in the O&M plan for corrosion protection if the system contains metal pipe. These requirements are discussed in more detail in CHAPTER III (see 49 CFR §§192 Subpart I for further information).
- P. Construction and Leak Repair. The O&M plan must contain procedures for leak repair. The operator must also have construction standards, which may be referenced in the O&M. CHAPTER VI of this manual gives some basic procedures and concepts.
- Q. Construction Records, Maps and Operating History. The operator must have and follow procedures in the plan to make construction records, maps and operating history of the natural gas system readily available to operating personnel.
- R. Distribution Line Valves. The O&M plan should contain procedures for high pressure distribution system having valves spaced so as to reduce the time to shut down a section of main in an emergency. Each regulator station controlling the flow or pressure of a gas distribution system must have a valve installed on the inlet piping at a distance from the regulator station sufficient to permit the operation of the valve during an emergency that might preclude access to the station. Valves on the outlet of the regulator station may be useful in preventing backflow in the event of an emergency (see 49 CFR §192.181 for further information).
- S. Gathering of Data Needed for Reporting Incidents. The plan must include procedures to compile information on pipeline incidents and safety-related conditions. These procedures need to ensure accurate and timely reporting. This information must be readily available (see 49 CFR Part 191 for further information).
- T. Starting Up and Shutting Down any Part of the Pipeline. The plan must include step-by-step actions for startup and shut down of the pipeline system. This will ensure that the MAOP is not exceeded on any portion of the pipeline system (see 49 CFR §192.605 for further information).



- U. Excess Flow Valve (EFV) Installation. The plan must include procedures for installation of an EFV on any new or replaced service line serving single family residence that operate continuously throughout the year at a pressure not less than 10 psig gauge (see 49 CFR§192.383 for further information).
- V. Test Requirements. The O&M plan must contain leak-test and strength-test requirements for pipelines. No person may operate a new segment of pipeline, or return to service a segment of pipeline that has been relocated or replaced until the pipeline has been tested in accordance with §192.619 (see 49 CFR §192.503, §192.505, §192.507, §192.509, §192.511, and §192.513 for further information for determining which section(s) will apply to your pipeline).

**NOTE:** THE FOLLOWING SECTIONS WILL NOT USUALLY APPLY TO MASTER METER OPERATORS.

- W. Upgrading. The O&M plan must contain upgrading procedures only if upgrading is contemplated. If a system requires upgrading, contact the state regulatory agency or the OPS regional office for detailed instructions (see 49 CFR §§192.551-192.557 for further information).
- X. Inspection of Regulating Stations. If regulating stations are a part of the system, the plan must include provisions for their inspection and testing. Many master meter systems will not have a regulating station. This section does not apply if a master meter operator does not lower the gas pressure from the local gas utility delivery pressure other than at customer service regulators (see Chapter II and 49 CFR §192.739 and §192.743 for further information).
- Y. Testing of Relief Devices at Regulating Stations. At a minimum, the O&M must include procedures for the inspection of relief devices. Relief devices should be inspected at intervals not exceeding 15 months, but at least once each calendar year (see Chapter II and 49 CFR §192.739 and §192.743 for further information).
- Z. Cast Iron Pipe. If a system contains any cast iron piping, the O&M plans must address the unique safety issues of cast iron pipe. Each cast iron caulked bell-and-spigot joint that is subject to pressures of 25 psig or more must be sealed with either a mechanical leak clamp or device which:
  - Does not reduce flexibility of the joint;
  - Permanently bonds (either chemically, mechanically, or both) with the bell and spigot, metal surfaces, or adjacent pipe metal surfaces;
  - Seals and bonds in a manner that meets the strength, environmental, and chemical compatibility requirements of 49 CFR §192.53(a)(b) and §192.143.



Each cast iron caulked bell or spigot joint that is subject to a pressure of less than 25 psig, must be sealed by a means other than caulking if it is exposed for any reason (see 49 CFR §192.753).

If an operator has knowledge that the support for a segment of a buried cast iron pipeline has been disturbed, that segment of the pipeline must be protected as necessary. Examples of disturbances are:

- Vibrations from heavy construction equipment, trains, trucks, buses, or blasting;
- Impact forces by vehicles;
- Earth movement;
- Excavations near the pipeline;
- Other known or foreseeable outside forces that may have or could subject that segment of the pipeline to bending stresses.

Operators of cast iron pipe located in earthquake-prone areas should consider replacing the pipe as soon as practical. Experience has shown that cast iron is prone to failure from severe earth movement (see 49 CFR §192.755 for further information).

- AA. Transmission Line Valves. The O&M plan should contain procedures for block valve spacing for class 1, 2, 3 and 4. See 49 CFR Part 192.179 for further information.
- AB. Damage Prevention. The O&M plan must contain written procedures to carry out to minimize damage to the pipeline from excavation activities. Operators must be a member of a qualified one call system (see 49 CFR §192.614).
- AC. Safety-Related Conditions. The O&M plan must enable personnel who perform operation and maintenance activities to recognize conditions that may be safety-related conditions (see page 23 for discussion of safety-related conditions).

---

## EMERGENCY PLANS

---

This section provides general information on developing an emergency plan (see 49 CFR §192.615 for further information).

Each operator is required to keep a written plan of procedures to cope with gas emergencies. The emergency plan should contain the following information:

- Emergency notification list,
  - Key valve locations,
  - Description and location of emergency equipment,
  - How to respond to gas leak reports and interruptions of gas service,
  - Check list for use in emergency situations,
  - Reporting requirements (telephone reports),
  - How to restore gas service after an outage,
  - Accident investigation procedures,
  - Education and training plan.
- A. Emergency Notification List. The telephone numbers of the operator, fire department, gas company (for a master meter) and any other entity whose service may be necessary in an emergency must be readily accessible. For master meter operators, a copy of this list should be posted in a public area. It is recommended that the direct lines to emergency services such as the fire department are included in addition to the general emergency number (i.e., 911). These numbers must be kept up-to-date.
- B. Key Valve Locations. A readily-available record of the gas pipeline indicating the location of key valves must be included in the emergency plan.
- C. Description and Location of Emergency Equipment. Emergency equipment must be available. A description of this equipment and its location should be included in the plan.
- D. Responding to Gas Leak Reports and Interruption of Gas Service. The operator must have written procedures to be followed in response to gas leaks reported by customers. It is the responsibility of the operator of the natural gas distribution system to ensure that all employees who respond to and investigate reports of gas leaks and odors are properly qualified.
1. The employee receiving a report of a gas leak must get as much of the information as possible to fill out the leak report (APPENDIX B, FORM 2). Use common sense: saving human life is the first priority, then property.

2. All reports of leaks on customer premises get priority. LEAKS INSIDE A BUILDING GET TOP PRIORITY.
3. After determining that a leak exists inside a building, remind the customer of the following:
  - Do not turn on or off any electrical switches.
  - Do not ring door bells or use telephones.
  - Do not light matches, cigarettes, etc.
  - Do not start automobiles or other engines.
  - Do extinguish all open flames.
  - Do evacuate building to a safe distance (about a block).
  - Do ask the people evacuated to notify the operator of their new location.
4. Dispatch necessary personnel to the location of the reported leak, including local emergency responders, such as the fire department and police.
5. Duties of first company employee on the scene:

TAKE EVERY CORRECTIVE ACTION NECESSARY TO PROTECT LIFE AND PROPERTY FROM DANGER (IN THAT ORDER.) IT IS THE RESPONSIBILITY OF THE PERSON IN CHARGE TO:

- Report to the Incident Commander, if incident command has been established.
  - Set up communications,
  - Coordinate the on-scene emergency response operation,
  - Make decisions concerning emergency valves, isolating areas, and use of emergency equipment,
  - Implement the checklist for emergency situations.
6. Minimum operator response actions for leaks on buried pipelines:
    - Assess danger to occupants of nearby buildings, to the public and to property,
    - Extinguish all open flames,
    - If necessary, notify fire, police, or other emergency agencies - master meter operators should also notify the gas company,
    - Block street and stop traffic,
    - Notify supervisor or other responsible persons,
    - Leak survey next to foundation of building including the use barholes,
    - Check neighboring buildings for gas.

- Check sewer and conduit systems for migrating gas
- Implement checklist for emergency situations.
- Repair leak.
- Return occupants to buildings only when positively sure it is safe.

7. Minimum operator response actions for leaks inside a building:

- Make sure leak detector is turned on and zeroed before entering the building,
- Evaluate immediately to determine concentration of gas and if a hazard exists,
- If a hazardous atmosphere exists inside the building immediately evacuate everyone including operator personnel. Do not operate electrical switches,
- Do not use telephone,
- Shut off gas meter valve if it can be done safely,
- Perform a barhole leak test of the area especially around foundation - check water meter box and other openings,
- If ground and house are gas free, turn on meter valve. Observe the meter -- is meter hand turning normally or spinning? If spinning, immediately turn off the meter valve,
- Check all gas piping and appliances for leaks,
- Conduct soap test,
- Implement checklist for emergency situations,
- Repair leak,
- If leak cannot be repaired, notify customer. Turn off meter, lock it and tag it.

8. Gas burning inside a building:

- Call fire department,
- Master meter operators should also call local natural gas utility,
- If fire is at an appliance, shut gas off at appliance valve if possible to do so safely,
- If not possible to shut gas off at appliance valve, shut gas off at meter or stop valve.

E. Checklist for a Major Emergency

- \_\_\_\_\_ 1. Has fire department been called?
- \_\_\_\_\_ 2. Have persons been evacuated and area blockaded?
- \_\_\_\_\_ 3. Has police/sheriff department been notified?
- \_\_\_\_\_ 4. Has repair crew been notified?
- \_\_\_\_\_ 5. Has company call list been executed?
- \_\_\_\_\_ 6. Has communication been established with operator personnel and emergency responders?
- \_\_\_\_\_ 7. Has outside help been requested?
- \_\_\_\_\_ 8. Have ambulances been called?
- \_\_\_\_\_ 9. Has leak been shut off or brought under control?
- \_\_\_\_\_ 10. Has local emergency management agency been notified?
- \_\_\_\_\_ 11. Have emergency valves or proper valves to shut down or reroute gas been identified and located?
- \_\_\_\_\_ 12. If an area has been cut off from a supply of gas, has the individual service of each customer been cut off?
- \_\_\_\_\_ 13. Is the situation under control and has the possibility of recurrence been eliminated?
- \_\_\_\_\_ 14. Has surrounding area, including buildings adjacent to and across streets, been surveyed/probed for the possibility of further leakage?
- \_\_\_\_\_ 14a If there is damage, has a check been made for secondary damage?
- \_\_\_\_\_ 15. Has proper tag been put on meter?
- \_\_\_\_\_ 16. Has telephonic report to the state been made?
- \_\_\_\_\_ 17. Has telephone report to OPS been made?
- \_\_\_\_\_ 18. Has radio/television station been given instructions (if necessary)?

Date: \_\_\_\_\_

F. Reporting Requirements (Immediate Report). In case of an incident, a telephone report must be made within one hour to the National Response Center (1-800-424-8802) or in Washington, D.C. (267-2675) or electronically at [http:// www.nrc.uscg](http://www.nrc.uscg).

An incident is an event involving release of gas from a pipeline that results in:

1. Death or injury requiring in-patient hospitalization; or
2. Estimated property damage of \$50,000 or more, including loss to the operator and others, or both, but excluding cost of gas lost;
3. Unintentional estimated gas loss of three million cubic feet or more
4. Or an event that is significant in the judgment of the operator, even though it does not meet the requirements above.

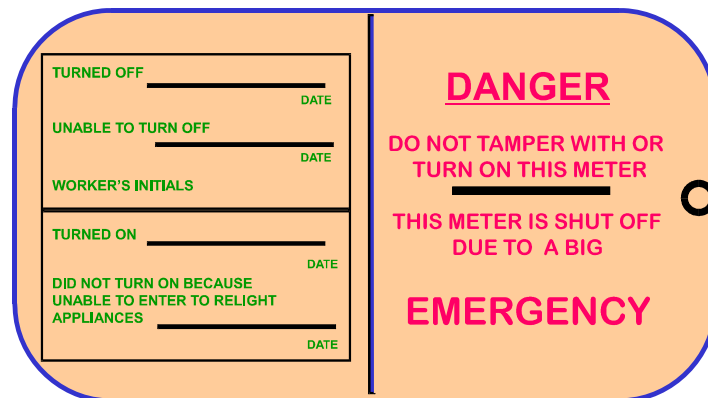
G. Restoration of Gas Service After an Outage. Qualified persons must follow proper procedures to safely restore gas service after an outage. These procedures must include details of appliance relighting procedures.

Gas service must be restored on a building-to-building basis throughout the affected area. First, service to each customer must be turned off, either at the meter or at street service valves. If street service valves cannot be located, the gas flow can be shut off by squeeze-off, stoppering, etc.

In restoring service to an affected area all gas piping and meters must be purged and appliances relit. Never turn on gas at the meter unless access is available to ALL appliances on the customer piping. In the event that a customer is not present, shut off and lock the shut off valve and leave a notification in an obvious location requesting the customer to call the natural gas company to arrange for restoration of service (see Figure VIII-3 for an example of cards).

The person in charge is to coordinate this operation and be responsible for it. A complete record of the incident, with drawings, etc., must be kept on file.

Figure VIII-3



H. Investigation Procedures. Each operator must establish procedures for investigating incidents and failures (see §192.617). Incident and failure investigation should not be limited only to those incidents meeting the above criteria. Investigations of failures of valves, regulators, relief valves, equipment used in operating the gas system and other components should be conducted to determine if there is a recurring pattern with the particular component. This information will also be used in evaluating threats and risks in the operator's Distribution Integrity Management Plan (DIMP). Procedures should include:

- Evaluating the situation,
- Protecting life and property,
- Securing the area,
- Conducting a leak survey,
- Conducting pressure tests of piping,
- Conducting meter and regulator checks,
- Questioning persons on the scene,
- Examining burn and debris patterns,
- Testing odorization level,
- Recording meter reading,
- Recording weather conditions,
- Selecting samples of the failed facility or equipment for laboratory examination for the purpose of determining the causes of the failure and minimizing the possibility of recurrence.

I. Education and Training. Operating personnel must be trained to ensure understanding of and competency in emergency procedures.

Employees must be trained in emergency procedures, including:

1. Updates of emergency plan,
2. Review of responsibilities in an emergency,
3. Review of locations and use of emergency equipment.,
4. Properties of natural gas,
5. Review the locations and use of:
  - System maps,
  - Main records,
  - Service records,
  - Valve records,
  - Regulator station schematics.

6. Review of hypothetical emergency situations to reinforce the step-by-step actions to be taken in emergency situations, including how to contact public officials, firefighters, police, gas company, etc.,
7. Recordkeeping requirements,
8. Incident Notification (PHMSA/ (OPS, state agency, etc.) (see page VIII-22).

---

## PUBLIC AWARENESS

---

Each utility operator must have a continuing education awareness program that enables customers, the public, emergency response groups, public officials and persons engaged in excavation activities, to recognize the hazards of natural gas and respond to an emergency situation. This program must be compliant with both the requirements of §192.616 and the incorporated API Recommended Practice 1162.

The operator's program must specifically include provisions to educate the public, appropriate government organizations, and persons engaged in excavation related activities on:

- (1) Use of a One-Call notification system prior to excavation and other damage prevention activities;
- (2) Possible hazards associated with unintended releases from a gas pipeline facility;
- (3) Physical indications that such a release may have occurred;
- (4) Steps that should be taken for public safety in the event of a gas pipeline release; and
- (5) Procedures for reporting such an event.

The program must include activities to advise affected municipalities, school districts, businesses, and residents of pipeline facility locations.

The program and the media used must be as comprehensive as necessary to reach all areas in which the operator transports gas. The program must include:

- Objectives;
- Management support;
- Program administration
- Stakeholder audiences;
- Message types;
- Message content, including (for customers):
  - Pipeline purpose and reliability,



- Damage prevention awareness,
- Leak recognition and response,
- How to get additional information;
- Message delivery frequencies;
- Delivery methods;
- Supplemental program enhancements;
- Program implementation;
- Program Evaluation;
- Continuous improvement.

For more information, refer to API RP 1162, available from the American Petroleum Institute (API).

Master meter operators have less stringent requirements than those for other gas system operators. Master meters must have a written procedure to provide customers with public awareness information two times each year. This information must include:

- A description of the purpose and reliability of the pipeline;
- An overview of the hazards of the pipeline and prevention measures used;
- Information about damage prevention;
- How to recognize and respond to a leak; and
- How to get additional information.

There are many excellent pamphlets published by state and regional gas associations and by the American Gas Association and the American Public Gas Association on the properties of gas and emergency information.

This information may be conveyed to the public by a number of means:

- Radio and television,
- Newspapers,
- Newsletters,
- Meetings,
- Bill stuffers,
- Mailings,
- Handouts,
- Bulletin board,

The program must be conducted in English and in other languages commonly understood by a significant number and concentration of the non-English speaking population in the operator's area. For examples of information that can be sent to the public, see Figures VIII-4, VIII-5, and VIII-6.

At least once every 4 years the operator must measure the effectiveness of its public awareness program with each stakeholder group. This is typically done by conducting a survey of a statistical sample of each stakeholder group.

The operator must maintain records of the public awareness program (see 49 CFR §192.616 and API RP 1162 for further information).

Figure VIII-4

# Identify the smell!



**If you ever smell  
gas, call your Local  
Gas Company promptly!**

Natural gas is odorless in its natural state. We add this disagreeable smell to let you know if any gas is escaping.

Gas leakage may occur from faulty appliances, loose connections, service lines inside or outside your home, or from gas mains. Leaks can be dangerous and should be dealt with promptly by experts.

**IF YOU EVER SMELL GAS -- even if you do not use it in your home -- take these precautions promptly:**

1. Call your local Gas Company.
2. If odor is very strong and you are indoors, go outside.
3. Do not turn any electrical switches on or off.
4. Do not light matches, smoke or create any other source of combustion.

However slim the chances of danger, it doesn't pay to needless risks. At the first sniff of gas, play it safe. Call us!

Figure VIII-5

## HOW CAN YOU PREVENT GAS EMERGENCIES

- ① Keep all appliances cleaned, properly vented and serviced regularly.
- ② Make sure everyone in your family knows how to operate gas appliances and shut-off valves.
- ③ Don't use an open gas oven for heating your home or drying clothes.
- ④ Don't use or store gasoline, aerosols or other products with flammable vapors near gas appliances.
- ⑤ Whenever changing your furnace filter be sure to replace the compartment door.
- ⑥ Never cover fresh air vents that supply air to your gas appliances.
- ⑦ Have all gas line alterations and appliance repairs performed by a professional.
- ⑧ Before digging in your yard, be sure you know the location of underground gas lines. Call your local One Call Center.
- ⑨ Write your fire and police department phone numbers and our emergency service number in the front of your phone book.

ANYTIME YOU SUSPECT A GAS LEAK OR GAS EMERGENCY CALL YOUR LOCAL GAS COMPANY. THEY'RE EXPERTS AT THEIR JOB, AND RESPOND TO EMERGENCY CALLS.

FIGURE VIII-6

## WHAT IS NATURAL GAS?

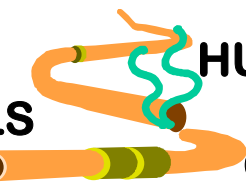
Natural gas is a non-toxic, colorless fuel, about one-third lighter than air. Gas burns, but only when mixed with air in the right proportion and ignited by a spark or flame. In its purified state, gas has no smell. For your protection, the Gas Company adds a harmless, distinctive odor so you can detect and report the slightest gas leak.

## HOW SAFE IS NATURAL GAS?

Natural gas has an excellent safety record, but like other forms of energy, it requires a certain amount of caution. Gas emergencies are rare, but they can happen:

- \* Whenever gas leaks from a pipe or pipe fitting, there is a possibility of fire or explosion.
- \* If leaking gas accumulates in a confined space, it can displace air and cause suffocation.
- \* If a gas appliance is not working properly, incomplete combustion can produce carbon monoxide and other toxic gases.
- \* A pilot light or gas burner can ignite combustible materials and flammable vapors, such as gasoline, paint thinner or aerosols.

**KNOW WHAT GAS SMELLS LIKE!** **¡SEPA A QUE HUELE EL GAS!**

An illustration of a gas pipe with a leak. The pipe is orange and has a green valve. A green wavy line representing gas is leaking from the pipe, and a small flame is visible at the leak point.

**If you ever smell gas, call your Local Gas Company promptly.**

**Si huele a gas alguna vez, llame inmediatamente a la Compañía Local de Gas al.**



**Local Gas**

---

## DISTRIBUTION INTEGRITY MANAGEMENT

---

All operators must have written Distribution Integrity Management Programs (DIMP) Plans. DIMP plans include assessing threats to the system, ranking relative risks of the threats, implementing additional actions to mitigate risks and measuring performance to ensure the additional actions are effective (see Chapter IX for guidance on DIMP).

---

## OPERATOR QUALIFICATION

---

All operators must have written Operator Qualification (OQ) plans. OQ plans describe how the operator will ensure that individuals performing safety-sensitive tasks have the necessary knowledge, skills and abilities to perform those tasks and recognize and react to any abnormal operating conditions they may encounter. See the Operator Qualification Guide for Small Distribution Systems for information on OQ programs.

---

## ANTI-DRUG AND ALCOHOL MISUSE PREVENTION PLANS

---

Operators other than master meter operators must develop, maintain, and follow an anti-drug and an alcohol misuse prevention plan including testing for prohibited drugs and alcohol. The anti-drug and alcohol misuse prevention plan must meet all the requirements of 49 CFR Parts 199 and 40.

The drug and alcohol testing regulations are applicable to persons, including contractors, who perform safety sensitive operating, maintenance or emergency-response functions covered by the DOT pipeline safety regulations in 49 CFR Parts 192, 193 or 195. Operators are required to conduct drug and alcohol testing in accordance with these regulations. Drug testing under Part 199 is to be conducted prior to employment, after an accident, randomly, upon reasonable cause and upon the return to duty of an employee who fails or refuses a drug test. Alcohol testing under Part 199 is to be conducted upon reasonable suspicion, upon the return to duty of an employee who fails or refuses an alcohol test.

The APGA SIF offers anti-drug and alcohol misuse plans than can be adapted to an operator's needs.

---

## CONTROL ROOM MANAGEMENT PLAN

---

Any operator of a pipeline facility with a controller working in a control room who monitors and controls all or part of a pipeline facility through a SCADA system must have a control room management (CRM) plan. For distribution systems with fewer than 250,000 customers the plan must address controller fatigue, compliance validation and compliance and deviations.

## REPORTS REQUIRED BY THE FEDERAL GOVERNMENT

---

The federal government requires that every gas operator make a telephonic or electronic report of any "incident." **Except, for master-meter operators**, operators must also report by fax or mail "safety-related conditions" and file an annual report. This chapter briefly describes each of these reports. REMEMBER to check with your state agency for any additional state reporting requirements.

Each report, except a safety-related condition report described below must be submitted electronically to the Pipeline and Hazardous Materials Safety Administration at <http://opsweb.phmsa.dot.gov> unless an alternative reporting method is authorized. If electronic reporting imposes an undue burden and hardship, an operator may submit a written request for an alternative reporting method to the Information Resources Manager, Office of Pipeline Safety, Pipeline and Hazardous Materials Safety Administration, PHP-20, 1200 New Jersey Avenue, SE, Washington DC 20590. The request must describe the undue burden and hardship.

In addition, states may require operators to copy the state on reports to PHMSA and may have additional reporting requirements over and above the requirements described below.

---

### INCIDENT REPORTS

---

An incident is an event involving release of gas from a pipeline that results in one or any combination of the following:

1. Death;
2. Injury requiring in-patient hospitalization;
3. Estimated property damage of \$50,000 or more, including damage to the property of the operator and others, or both, but excluding cost of gas lost;
4. Unintentional estimated gas loss of three million cubic feet or more; or
5. Is significant in the judgment of the operator, even though it does not meet any of the above four criteria.

Check with your state agency -- states may have additional criteria for what is a reportable incident.

**Reporting Requirements.** In case of an incident, a telephonic report must be made within one hour after discovery to the National Response Center (1-800-424-8802) or in Washington, D.C. (267-2675) or electronically at [http:// www.nrc.uscg](http://www.nrc.uscg).

The telephone report of an incident should include:

- Identity of reporting operator;
- Name and phone number of individual reporting the incident;

- Location of the incident (city, county, state, and street address);
- Time of the incident (date and hour);
- Number of fatalities and personal injuries, if any;
- Type and extent of property damage;
- Description of the incident.

## **REMEMBER, WHEN IN DOUBT, REPORT!**

See 49 CFR §191.5 for further information.

Except for master meter operators, an electronic incident report must be filed within 30 days to the Pipeline and Hazardous Materials Safety Administration at <http://opsweb.phmsa.dot.gov> unless an alternative reporting method is authorized. The incident report includes detailed information about the cause, effects and other characteristics of the incident. Incident report forms and instructions can be found at <http://www.phmsa.dot.gov/pipeline> (see 49 CFR §191.9 for further information).

---

### ANNUAL REPORTS

---

With the exception of master meter operators, each operator of a distribution system must submit an annual report for that system. This report must be submitted on DOT Form RSPA F7100.1-1. This report must be submitted each year, not later than March 15, for the preceding calendar year.

---

### MECHANICAL FITTING FAILURE REPORT

---

Each operator of a distribution pipeline system must submit a report on each mechanical fitting failure, excluding any failure that results only in a nonhazardous leak, using PHMSA Form F-7100.1-2. This does not apply to master meter operators.

See Form 3a for information about what must be included in a mechanical fitting failure report.

---

### SAFETY-RELATED CONDITION REPORTS

---

OPS requires operators of natural gas pipelines to report certain safety-related conditions. This does not apply to master meter operators.

A written report must be filed within 5 working days after the operator first determines that a "safety-related condition" exists, but not later than 10 working days after the day the operator discovers the condition. An operator must submit concurrently to the applicable State agency.



Each operator is also required to update its O&M plan to enable personnel who perform operation and maintenance activities to recognize conditions that may be safety-related conditions.

Typical safety-related conditions that need to be reported by operators of small natural gas systems include:

- Unintended movement or abnormal loading of pipeline facilities by environmental causes such as earthquakes, landslides, or floods, that impairs the serviceability of a pipeline;
- Any malfunction or operating error that causes the pressure of a pipeline to rise above its MAOP plus the pressure build-up allowed for operation of pressure limiting or control devices;
- A leak that constitutes an emergency and is not repaired within 5 days of determination;
- A safety-related condition that could lead to imminent hazards and cause the operator to make a 20 percent or more reduction in operating pressure.

The above is only a summary. Refer to 49 CFR §191.23(a) for a complete listing of all safety-related conditions that must be reported.

Safety-related conditions that do not require a report include:

- Conditions on a customer-owned service line;
- Conditions resulting in an incident, as defined in 49 CFR §191.3 (however this requires an incident report);
- Condition on a pipeline more than 220 yards from any building or outdoor place of assembly, unless it is within the right-of-way of an active railroad, paved road, or highway;
- Conditions that are corrected before the report filing deadline, except for certain corrosion related conditions.

See 49 CFR §191.23(b) for further information.

## CHAPTER IX: INTEGRITY MANAGEMENT

### DISTRIBUTION INTEGRITY MANAGEMENT

---

This chapter contains a simplified description of the distribution integrity management requirements contained in the Pipeline Safety Regulations. The complete text of the regulation can be found in 49 CFR Part 192, Subpart P.

“Integrity” means that the pipe and other components of the distribution system are in a sound and reliable condition. A sound and reliable distribution system can safely deliver natural gas at the pressures at which the distribution system is operated.

For most circumstances, the design, construction, inspection and maintenance requirements described in Chapters 1-8 of this Guide are sufficient to ensure the integrity of distribution systems. For some operators, however, there may be factors that result in a higher risk to public safety than anticipated by the regulations. Also some older pipes may have been installed under different standards or have issues that developed over time. The goal of integrity management is to identify those areas of the distribution system that pose the highest relative risk to public safety and apply additional safeguards over and above the inspection and maintenance requirements of the regulations to those areas.

“Risk” is a combination of two factors: The likelihood that a gas pipe or component will fail and the consequences that would occur if the pipe or component were to fail. For example, a sewer line construction project near gas lines would increase the likelihood that excavation damage to the gas lines may occur. For example, if the piping is located next to a school building, the consequences of a failure would potentially be more serious than if the same damage occurred on piping in a remote area.

All operators of natural gas distribution systems are required to develop and implement an integrity management (IM) program and a written integrity management plan. The written integrity management plan must include the following elements:

1. Know your system,
2. Identify threats,
3. Evaluate and rank risk,
4. Identify and implement risk reduction measures,
5. Measure performance, monitor results and evaluate effectiveness,
6. Periodically assess the effectiveness of the program,
7. Report results (no reporting is required for master meter operators), and
8. Maintain records.

---

## KNOW YOUR SYSTEM

---

The operator must demonstrate knowledge of its pipeline, which, to the extent known, should include the approximate location and material of its pipeline and all other distribution facilities. Knowledge of the system includes the results of inspection and maintenance activities such as corrosion inspections, leakage surveys, exposed pipe inspections and other inspections described elsewhere in this Guide. Knowledge also includes the knowledge and experience of the individuals who inspect and maintain the system on a daily basis.

If there is additional information needed to properly assess one or more threats to the integrity of the system, the written plan must include a plan for gaining knowledge over time through normal construction, operations or maintenance activities conducted on the pipeline. For instance, if the operator does not know what type of material is present in the system, the plan might state that whenever the buried pipe can be visually inspected (because of excavation to repair the gas system or excavation unrelated to the gas system that exposes the pipe, etc.) the operator will record the information printed on the pipe and update the integrity management plan, if necessary.

---

## IDENTIFY THREATS

---

A “threat” is something that can cause distribution pipe or components to fail. An operator must consider reasonably available information to identify existing and potential threats. An existing threat is a threat that the operator knows has occurred on the system. For example, if corrosion leaks have occurred or the pipe has been damaged by excavation, then corrosion or excavation damage are existing threats. Potential threats, on the other hand, may not have ever occurred on the system, but could potentially occur sometime in the future. For example, bare steel pipe that is not cathodically protected poses a potential for corrosion to occur so corrosion would be a potential threat. OPS has issued advisory bulletins about certain types of plastic pipe that are susceptible to brittle cracking. If an operator knows or is unsure that some of this pipe exists in the system, even if brittle failures have not occurred it remains a potential threat.

Sources of data for threat assessment include, but are not limited to, the knowledge of the system described above, incident and leak history, corrosion control records, continuing surveillance records, patrolling records, maintenance history, and excavation damage experience. Operators should also consider information available from external sources such as the OPS advisory bulletins. The operator’s DIMP plan must assess the following threats:

1. Corrosion,
2. Natural forces,
3. Excavation damage,
4. Other outside force damage,
5. Material, weld or joint failure (including compression coupling),
6. Equipment failure,
7. Incorrect operation, and
8. Other threats not included in the above seven specific threats.

---

## EVALUATE AND RANK RISK

---

### EVALUATING RISK

---

An operator must evaluate the risks associated with its distribution pipelines. In this evaluation, the operator must determine the relative importance of each threat and estimate and rank the risks posed to the pipeline system. This evaluation must consider each applicable current and potential threat, the likelihood of failure associated with each threat and the potential consequences of such a failure.

For each of the eight listed threats there are factors that affect the likelihood of failure due to that threat. For example, some of the factors that would increase the likelihood of corrosion occurring include:

- Pipe Material. Plastic does not corrode, but pipe made of steel or other metal can corrode,
- Coating and Cathodic-Protection. Coated, cathodically-protected steel pipe is less likely to corrode than bare, unprotected steel pipe,
- Cathodic Protection Levels. If cathodic-protection levels fall below criteria the pipe is more likely to corrode (see Chapter 2),
- Corrosive Soils. Steel pipe buried in soils with high moisture and salt content are more likely to corrode than the same pipe in dry, non-corrosive soils,
- Electrical Currents. Electrical currents in the ground can increase the likelihood of corrosion on distribution pipes.

Some factors that would affect the consequences of a failure include:

- Pipe Diameter. The greater the pipe diameter, the more gas will be released if it were to fail,
- Pressure. The higher the operating pressure of the pipe the more gas will be released if it were to fail,
- Population Density. The consequence of a failure of a pipe located near occupied buildings will be potentially greater than failure of a pipe located far from buildings and people. Potential consequences are even greater if the buildings are schools, hospitals, nursing homes, etc., that normally hold many people and/or would be difficult to evacuate.
- Business Districts. Underground leaks in areas with wall-to-wall paving are more likely to migrate into nearby buildings than leaks not under pavement.

In developing the DIMP plan, the operator should document factors that were considered in assessing both the likelihood and consequence of failure for each of the 8 threats. Documentation should include the source of information used in the evaluation. For example, operators should review the results of cathodic-protection monitoring when evaluating the threat of corrosion. The written plan should identify where the cathodic-protection monitoring records are kept.

In evaluating risk, an operator will usually find that the likelihood and/or consequence of a failure due to any of the 8 threats are different for different parts of the system. For example, if a system is part steel and part plastic, the plastic pipe has zero risk of corrosion. Even the steel pipe may have varying risk if some steel pipe is coated and cathodically-protected and other portions are not. In cases where the relative risk for any threat is higher on some portion of the system than the rest of the system, the operator should subdivide the system into regions with similar characteristics and for which similar actions likely would be effective in reducing risk.

---

## RISK RANKING

---

After the likelihood and consequences of failure due to each of the 8 threats has been evaluated for every inch of the operator's distribution system, the operator must determine which threats to which sections of the system pose the greatest relative risk to public safety. There are several methods to perform this risk ranking.

One method is to assign a numeric score to each of the factors that were used to evaluate the likelihood and consequence of a failure. For example, bare, unprotected steel pipe could be assigned a score of 6, while coated, cathodically-protected pipe would get a score of 2. Pipe that has experienced corrosion leaks might get an additional 5 points, whereas pipe on which no corrosion leaks have occurred would get no additional points. Pipe located over 100 feet from any building would get 1 additional point while pipe located within 20 feet of a school might get 10 additional points. The factors considered and the scores assigned to each factor should be recorded in the written DIMP plan.

Another method is to rely on the judgment of "subject matter experts" (SMEs) to assess the likelihood and consequences of each threat. SME's could be outside consultants or could be the individuals responsible for the day-to-day inspection and maintenance of the distribution system or a combination of both. The rationale for the SME's ranking of each threat should be recorded in the written DIMP plan.

After the relative risk of all threats to all sections of the system have been evaluated, the operator should review the list of relative risks and make sure that he/she agrees with the rankings. If they believe that one or more of the threats to any section of system is ranked too high or too low, the operator should adjust the relative risk rank accordingly. The reasons why any threat is adjusted higher or lower should be recorded in the written plan.

---

## IMPLEMENT RISK REDUCTION MEASURES

---

After the operator is confident that the relative risk of the entire system for all 8 threats has been correctly evaluated and ranked, the operator should consider if one or more of the threats poses such a high relative risk that additional risk reduction measures need to be taken. Risk reduction measures can include additional inspections, additional maintenance, and more, up to and including replacement of the high relative risk piping or components.

The additional risk reduction measure must be appropriate for the threat that it is intended to address. For example, replacing bare steel pipe with plastic pipe will reduce the risk of corrosion but would not be expected to be effective at reducing excavation damage. Conversely, improving map accuracy and increasing the outreach to excavators might reduce the risk of excavation damage, but have no impact on threats such as corrosion, natural forces or material, weld or joint failures.

The written DIMP plan should clearly state what additional risk reduction measures will be implemented, the threat that each measure is meant to address and the portion of the operator's distribution system to which it will be applied. The written plan should also include an implementation plan stating how each risk reduction measure will be accomplished, how long it will take, who is responsible to see that it is accomplished and other pertinent information.

---

### MEASURE PERFORMANCE, MONITOR RESULTS AND EVALUATE EFFECTIVENESS

---

The operator must develop and monitor performance measures to evaluate the effectiveness of its IM program. An operator must consider the results of its performance monitoring in periodically re-evaluating the threats and risks.

Except for master meter operators, these performance measures must include the following:

1. Number of hazardous leaks either eliminated or repaired;
2. Number of excavation damages;
3. Number of excavation tickets (receipt of information by the underground facility operator from the notification center);
4. Total number of leaks either eliminated or repaired, categorized by cause;
5. Number of hazardous leaks either eliminated or repaired, categorized by material; and
6. Any additional measures the operator determines are needed to evaluate the effectiveness of the operator's IM program in controlling each identified threat. Where the operator has taken additional risk reduction measures the operator should also identify a performance measure that will be tracked to determine if the additional action is effective at reducing the risk. For example, if additional risk reduction measures will be taken to reduce the risk of corrosion on the operator's bare steel piping, one performance measure might be to track the number of leaks caused by corrosion on that portion of the system.

Master meter operators need only track the number of leaks eliminated or repaired by cause.

For each performance measure the operator must establish a baseline to which future performance will be compared to measure the effectiveness of the DIMP program. If a performance measure is something for which the operator has existing data, the baseline could be the prior year's results or the average of the past several years. If the performance measure is not something the operator has previously been collecting, the baseline might be the first year's or the average of the first few years' data. The baseline for each performance measure must be documented in the written DIMP plan.

---

## PERIODICALLY ASSESS THE EFFECTIVENESS OF THE PROGRAM

---

The operator must determine the appropriate period for conducting IM program evaluations based on the complexity of its pipeline and changes in factors affecting the risk of failure. An operator must re-evaluate its entire program at least every five years or more frequently if the operator has reason to believe that factors have changed that might significantly affect the outcome of the risk evaluation and ranking process. This could include discovery that the system contains one of the plastic materials identified by OPS as high risk for brittle failure or a significant increase in the rate of corrosion leaks or excavation damages. It could also be triggered by completion of a risk reduction program, such as elimination of all bare steel pipe or plastic pipe prone to brittle cracking.

The operator must consider the results of the performance monitoring in these evaluations. If performance measures indicate the level of risk is being reduced by the risk reduction measures established in the written DIMP plan the operator need not modify the plan. If the performance measures indicate no reduction in risk then the operator should consider taking different or additional risk reduction measures. If the results of the new risk evaluation indicate the relative risk is now acceptably low the operator can consider whether to discontinue a risk reduction measure.

---

## REPORT RESULTS

---

There are no reporting requirements under the DIMP Rule for master meter operators. Operators must annually report the first four performance measures listed above under MEASURE PERFORMANCE, MONITOR RESULTS AND EVALUATE EFFECTIVENESS.

Operators must also report information about each failure of a mechanical fitting. This information must include, at a minimum, location of the failure in the system, nominal pipe size, material type, nature of failure including any contribution of local pipeline environment, mechanical fitting manufacturer, lot number and date of manufacture, and other information that can be found in markings on the failed mechanical fitting. An operator also must report this information to the state pipeline safety authority if a state exercises jurisdiction over the operator's pipeline. These data will be submitted along with the operator's distribution annual report or can be submitted as each failure occurs (see discussion in Chapter VIII and Form 3a).

---

## RECORDKEEPING

---

Operators must maintain records demonstrating compliance with the requirements of this subpart for at least 10 years. The records must include copies of superseded IM plans.

A master meter operator must maintain, for a period of at least 10 years, the following records:

1. The current written IM plan plus all superseded IM plans;
2. Documents supporting threat identification; and

3. Documents showing the location and material of all piping and appurtenances that are installed after the effective date of the operator's IM program and, to the extent known, the location and material of all pipe and appurtenances that were existing on the effective date of the operator's program.

---

## DIMP RESOURCES

---

Several template plan outlines are available to small operators to help write a DIM plan. They include SHRIMP from the APGA Security and Integrity Foundation (SIF), Gas Piping Technology Committee (GPTC) guidance, Midwest Energy Association model and the Southern Gas Association/Northeast Gas Association model. See also the PHMSA DIMP website at: <http://primis.phmsa.dot.gov/dimp/index.htm>. Small operators under the jurisdiction of a state pipeline safety agency should consult that agency to determine what resources and assistance may be available to them.

### SHRIMP - Simple Handy Risk-based Integrity Management Plan

A Distribution Integrity Management Programs (DIMP) plan development tool (SHRIMP) developed by the APGA Security and Integrity Foundation (SIF) and funded by PHMSA through a cooperative agreement. All questions pertaining to SHRIMP should be directed to the APGA SIF at [www.apgasif.org](http://www.apgasif.org).

### Distribution Integrity Management: Guidance for Master Meter and Small Liquefied Petroleum Gas Pipeline Operators

This document provides guidance to help master meter operators and small LPG operators (i.e., those serving fewer than 100 customers from a single source) implement the requirements of subpart P of Part 192. Operators of larger distribution pipelines should refer to the GPTC guidelines.

### GPTC Guide Material Appendix G-192-8 Distribution Management Integrity Program

The GPTC Guide material provides guidance to operators for developing a distribution integrity management program and compliance with proposed Federal Regulations §§192.1005, 192.1007 and 192.1015 on DIMP. It provides operators with practices that may be considered as they develop and maintain a DIMP specific to their gas distribution systems. AGA serves as the secretariat to the Accredited Standards Committee (ASC) Z380, Gas Piping Technology Committee. The GPTC develops and publishes ANSI Z380.1, Guide for Gas Transmission and Distribution Piping Systems. The DIMP guidelines may be purchased separately from the entire Guide. More information can be found at:

<http://www.aga.org/membercenter/gotocommitteepages/GPTC/Pages/default.aspx>.



## Industry Associations

Associations host education and training programs which operators may find of assistance in complying with the DIMP regulation.

- [American Gas Association \(AGA\)](#)
- [American Public Gas Association \(APGA\)](#)
- [Midwest Energy Association \(MEA\)](#)
- [National Propane Gas Association \(NPGA\)](#)
- [Northeast Gas Association \(NGA\)](#)
- [Southern Gas Association \(SGA\)](#)
- Western Energy Institute (WEI)

---

## TRANSMISSION INTEGRITY MANAGEMENT

---

The Transmission Integrity Management Rule specifies how transmission pipeline operators must identify, prioritize, assess, evaluate, repair and validate the integrity of gas transmission pipelines that could, in the event of a leak or failure, affect High Consequence Areas (HCAs) within the United States. HCAs include certain populated and occupied areas. The primary objectives for the Gas Transmission IM Program are to:

- Accelerate and improve the quality of integrity assessments conducted on pipelines in areas with the highest potential for adverse consequences (HCAs),
- Promote a more rigorous, integrated, and systematic management of pipeline integrity and risk by operators,
- Strengthen government's role in the oversight of pipeline operator integrity plans and programs,
- Increase the public's confidence in the safe operation of the nation's pipeline network, and
- Provides enhanced protection for defined HCAs.

Transmission IM may be complex or simple depending on the nature of the operation. In complex situations the operator should use knowledgeable and experienced individuals to develop the IM program.

---

## POTENTIAL IMPACT CIRCLE

---

The term potential impact circle is used in the Transmission IM Rule. Potential impact circle is a circle of radius equal to the potential impact radius (PIR). PIR means the radius of a circle within which the potential failure of a pipeline could have significant impact on people or property. PIR is determined by the formula  $r = 0.69 * (\text{square root of } (p * d^2))$ , where 'r' is the radius of a circular area in feet surrounding the point of failure, 'p' is the maximum allowable operating pressure (MAOP) in the pipeline segment in pounds per square inch and 'd' is the nominal diameter of the pipeline in inches.

---

## HIGH CONSEQUENCE AREAS

---

Operators may identify HCAs using either of two methods:

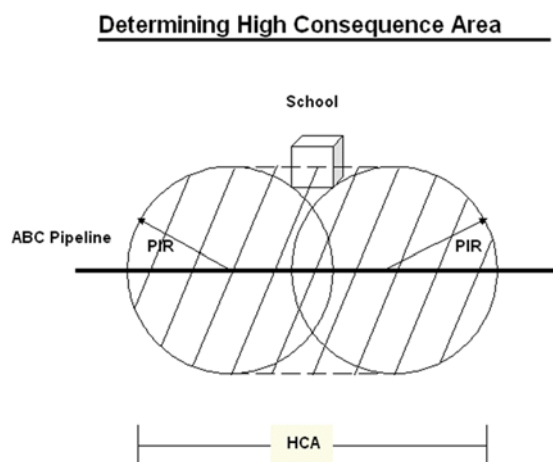
Method 1: A pipeline segment is located in a high consequence area if any of the following apply:

- A Class 3 location under §192.5, or
- A Class 4 location under §192.5, or
- Any area outside a Class 3 or Class 4 location where the potential impact radius is greater than 660 feet (200 meters), and the area within a potential impact circle contains 20 or more buildings intended for human occupancy; or
- The area within a potential impact circle containing an identified site.

Method 2: A pipeline segment is located in a HCA if any of the following apply:

- The area within a potential impact circle contains 20 or more buildings intended for human occupancy, or
- The area within a potential impact circle contains an identified site.
- The terms "potential impact radius," "potential impact circle," and "identified site" are defined in the Transmission IM Rule.
- When using potential impact circles, the length of the HCA extends axially along both directions of the pipe to the edge of the potential impact circles that define the boundaries of the HCA (i.e., the boundary of the HCA is defined by the circumference of the potential impact circle, not its center point).

Figure IX-1: Determining HCAs



---

## INTEGRITY MANAGEMENT PLAN AND PROGRAM

---

Gas transmission pipeline operators must develop a written IM plan that includes:

1. Identification of all covered segments
2. A baseline assessment plan to assure the integrity of all covered segments,
3. A framework that contains all required elements of the IM program,
4. A process to assure continual improvement to the program,
5. Provisions to implement industry standards invoked by reference,
6. A process to document (and notify OPS as required) any changes to its program.

A gas transmission pipeline operator's IM Program must include all of the following program elements:

1. Identification of all HCAs,
2. Baseline assessment plan,
3. Identification of threats to each covered segment, including by the use of data integration and risk assessment,
4. A direct assessment plan, if applicable,
5. Provisions for remediating conditions found during integrity assessments,
6. A process for continual evaluation and assessment,
7. A confirmatory direct assessment plan, if applicable,
8. A process to identify and implement additional preventive and mitigative measures,
9. A performance plan including the use of specific performance measures,
10. Recordkeeping provisions,
11. Management of change process,
12. Quality assurance process,
13. Communication plan,
14. Procedures for providing to regulatory agencies copies of the risk analysis or IM program,
15. Procedures to ensure that integrity assessments are conducted to minimize environmental and safety risks,
16. A process to identify and assess newly identified HCAs.

Operators may deviate from certain timeframe requirements related to reassessment intervals and certain time frame requirements related to remediation, if it demonstrates exceptional performance of its IM program, by meeting or exceeding the performance-based requirements of ASME B31.8S.

An operator's IM program must document minimum qualification requirements for the following:

- Supervisory personnel,
- Persons that carry out integrity assessments and evaluate assessment results,
- Persons responsible for additional preventive and mitigative actions.

An operator must identify and evaluate all potential threats to the covered segment. The operator must collect and integrate data from the entire pipeline that could be relevant to the covered segment and conduct a risk assessment in accordance with ASME/ANSI B31.8S. If an operator identified any of the following threats, it must take specific actions to address the threats:

- Third-party Damage. Operators must use data integration from the assessment of other threats to identify potential third-party damage and take additional preventive and mitigative action,
- Cyclic Fatigue. Operators must use cyclic fatigue analysis to prioritize baseline assessments and reassessments,
- Manufacturing and Construction Defects. Operators must prioritize a segment containing manufacturing or construction defects as a high risk segments unless it shows by analysis that the defect is stable and that the risk of failure is low,
- ERW Pipe. Covered segments containing low frequency electric resistance welded pipe or lap welded pipe must be prioritized as a high risk segment for the baseline assessment or reassessment, and assessed using technologies proven to be capable of assessing seam integrity and of detecting seam corrosion anomalies,
- Corrosion. If corrosion is identified, all similar pipeline segments (both covered and non-covered) with similar coating and environmental characteristics must be evaluated and remediated, as necessary.

---

## BASELINE ASSESSMENT

---

The baseline assessment plan must:

- Identify potential threats to each covered segment,
- Identify methods to assess integrity based on the threats identified for each covered segment (acceptable methods include internal inspection, pressure testing, direct assessment, or other technology that the operator demonstrates provides an equivalent level of understanding of line integrity),
- Identify a schedule for completing the assessments including the risk factors used in determining schedule priorities,
- If applicable, include a direct assessment plan, appropriate for the threats identified for the covered segments,
- Include a procedure for ensuring that the baseline assessments are conducted in a manner that minimizes environmental and safety risks.

Operators must complete the baseline assessment of 50% of its covered segments, beginning with the highest risk segments, by December 17, 2007, and 100% of its covered segments by December 17, 2012. An operator may use assessments completed before December 17, 2002, as a baseline assessment if the prior assessment meets the requirements of Subpart O and anomalies have been remediated in accordance with Subpart O. In this case, however, a reassessment must be completed by December 17, 2009.

Newly identified HCAs must be incorporated into the operator's baseline assessment plan within one year from the time the new area is identified. A baseline assessment must be completed within 10 years from the date the new HCA was identified.

Direct assessment may be used for the following threats:

- External Corrosion (Must comply with NACE RP0502-2002),
- Internal Corrosion (Must comply with ASME/ANSI B31.8S),
- Stress Corrosion Cracking (Must comply with ASME/ANSI B31.8S).

---

## REMEDIAL ACTION

---

The Transmission IM Rule requires that certain defects be remediated within prescribed time limits. For immediate conditions, a pressure reduction must be implemented until the condition is repaired.

- Immediate Conditions:
  - Remaining strength is less than or equal to 1.1 x MAOP,
  - A dent with any indication of metal loss, cracking, or a stress riser,
  - An anomaly judged to require immediate action.
- One Year Conditions:
  - Dent > 6% (>0.50" for pipe diameter less than NPS 12) between 8:00 and 4:00 (upper 2/3 of pipe),
  - Dent > 2% (>0.25" for pipe diameter less than NPS 12) that affects curvature at a girth weld or a longitudinal seam weld,
- Monitored Conditions (remediation not required):
  - Dent > 6% (>0.50" for pipe diameter less than NPS 12) between 4:00 and 8:00 (lower third of pipe),
  - Dent > 6% (>0.50" for pipe diameter less than NPS 12) between 8:00 and 4:00 (upper 2/3 of pipe) and engineering analysis demonstrates that critical strain levels are not exceeded,
  - Dent > 2% (>0.25" for pipe diameter less than NPS 12) that affects curvature at a girth weld or a longitudinal seam weld and engineering analysis demonstrates that critical strain levels are not exceeded.

Operators must conduct risk assessments to identify additional preventive and mitigative measures to protect HCAs and enhance public safety, including:

- Installing automatic shut-off valves or remote control valves,
- Installing computerized monitoring and leak detection systems,
- Replacing segments with heavier wall pipe,
- Additional training,
- Conducting drills with local emergency responders,
- Implementing additional inspection and maintenance programs,
- Enhancements to damage prevention programs.

## APPENDIX A: GLOSSARY AND ACRONYMS

---

---

### GLOSSARY

---

To understand this manual, operators of small natural gas systems need to know the meaning of some commonly used terms. The terms are defined below for the purpose of this guidance manual. The reader is referred to 49 CFR Parts 191 and 192 for additional definitions.

**49 CFR.** Title 49 of the Code of Federal Regulations (CFR). This document contains the actual safety regulations that must be complied with by the natural gas operator. Parts 190, 191, 192, and 199 of 49 CFR contain the federal pipeline safety regulations relevant to operators of natural gas pipeline systems.

**Abandoned.** Permanently removed from service.

**Abnormal Operating Condition.** A condition identified by the operator that may indicate a malfunction of a component or deviation from normal operations that may:

- (a) Indicate a condition exceeding design limits; or
- (b) Result in a hazard(s) to persons, property, or the environment.

**Annually.** At intervals not exceeding 15 months, but at least once each calendar year.

**Atmospheric Pressure.** The pressure of the weight of air on the earth's surface. The average atmospheric pressure at sea level for scientific purposes has been defined as 14.696 pounds per square inch absolute (psia).

**Barhole.** When searching for leaks, a small hole made near gas piping to extract air from the ground (see Methods of Detecting a Leak in Chapter IV).

**Cathodic Protection (CP).** a procedure by which underground metallic pipe is protected against deterioration (rusting and pitting). Basic theory, concepts, and practical considerations for cathodic protection are contained in Chapter III.

**Customer Meter.** A device that measures the volume of gas transferred from an operator to the consumer.

**Deactivation (Inactivation).** The process of making a pipeline/service inactive.

**Distribution Integrity Management Programs (DIMP).** A program developed and implemented by the operator to identify threats to distribution pipeline integrity, rank the relative risk of each threat, take additional action over and above regulatory minimum requirements

where justified by the degree of risk and to track performance measures to determine if the additional actions are effectively reducing those risks.

**Distribution Line.** A pipeline other than a gathering or transmission line.

**Downstream.** At any given point on a pipeline, any point located on the opposite side of that point in the direction from which the gas is flowing is downstream.

**Emergency Plan.** A written procedures for responding to emergencies on the pipeline system.

**Evaluation** - A process to determine that an individual possesses the necessary knowledge, skills and abilities to perform a covered task and recognize and react to AOCs through written tests oral exams, observation while performing the task on the job or in a classroom or simulated setting, or any other documented method.

**Excess Flow Valve.** A device installed in a service line to restrict or shut off the gas flow through the service line if the flow exceeds a predetermined limit.

**Fitting.** A metallic or plastic component used in joining lengths of pipe into various piping systems. The term includes: couplings, ells, tees, crosses, reducers, unions, caps, and plugs.

**Operator.** A corporation, government entity (municipality, county, utility district, etc.) or an individual that operates a natural gas utility or a housing project, apartment complex, condominium, or mobile home park served by a master meter. The operator is ultimately responsible for complying with the pipeline safety regulations.

**High-pressure Distribution System.** A distribution system in which the gas pressure in the main is higher than the pressure provided to the customer; therefore, a pressure regulator is required on each service to control pressure to the customer.

**Inactive Pipeline.** A pipeline that is being maintained according to §192 requirements but is not presently being used to transport gas.

**Incident.** An event that involves a release of gas from a pipeline that results in a death, or personal injury necessitating in-patient hospitalization; estimated property damage of \$50,000 or more, including loss to the operator and others, or both, but excluding cost of gas lost; and/or unintentional estimated gas loss of three million cubic feet or more; or that is significant in the judgment of the operator (Check with your local state authorities for possible additional requirements, see APPENDIX B).

**Knowledge, Skills & Abilities.** An appropriate combination of information, craftsmanship, and proficiency that allows an individual to perform covered tasks in a competent manner.

**Low-pressure Distribution System.** A distribution system in which the gas pressure in the main is substantially the same as the pressure provided to the customer; normally a pressure regulator is not required on individual service lines.

**Main.** A natural gas distribution pipeline that serves as a common source of supply for more than one service line.

**Master Meter System.** A natural gas pipeline system for distributing natural gas for resale within, but not limited to, a distinct area, such as a mobile home park, housing project, or apartment complex, where the operator purchases metered gas from an outside source. The natural gas distribution pipeline system supplies the ultimate consumer who either purchases the gas directly through a meter or by other means such as by rent.

**Maximum Allowable Operating Pressure (MAOP).** The maximum pressure at which a pipeline may be operated in compliance with the gas pipeline safety regulations. It is established by design, past operating history, pressure testing, and pressure ratings of components.

**Municipality.** A city, county, or any other political subdivision of a state.

**Natural Gas.** A non-toxic, colorless fuel, about one-third lighter than air. Natural gas burns only when mixed with air in certain proportions and ignited by a source of ignition (spark or flame) (Figure IV-4). Natural gas in its natural state may not have an odor.

**Operating and Maintenance (O&M) Plan.** Written procedures for operations and maintenance on natural gas pipeline systems.

**Overpressure Protection Equipment.** Equipment installed to protect and prevent pressure in a system from exceeding the maximum allowable operating pressure (MAOP).

**Pipeline.** All facilities through which gas moves in transportation. This includes pipes, valves, and other items attached to the pipe, meter stations, regulator stations, delivery stations, holders, and fabricated assemblies.

**Pipeline Facilities.** New and existing pipeline, rights-of-way (ROWs), and any equipment, facility, or building used in the transportation of gas or in the treatment of gas during the course of transportation.

**Pressure Regulating/Relief Station.** A device to automatically reduce and control the gas pressure in a pipeline downstream from a higher pressure source of natural gas. It includes any enclosures, relief devices, ventilating equipment, and any piping and auxiliary equipment, such as valves, regulators, control instruments, or control lines.

**Pretested Pipe.** Pipe that has been pressure tested by the operator before the pipe is transported to the job site.



**Service Line.** A natural gas distribution line that transports gas from a common source of supply to a customer's meter, or to the connection to a customer's piping if the piping is farther downstream or if there is no meter.

**Service Regulator.** A device designed to reduce and limit the gas pressure provided to a customer.

**Service Regulator Vent.** An opening on a service regulator that protects against over pressurization of house piping by releasing gas. Service regulator vents and relief vents must terminate outdoors.

**Service Riser.** The section of a service line which extends out of the ground and is often near the wall of a building. This usually includes a shut-off valve.

**Shut-off Valve.** A valve used to stop the flow of gas. The valve may be located upstream of the service regulator or below ground at the property line or where the service line connects to the main.

**Upstream.** At any given point on a pipeline, any point located on the same side of that point in the direction from which the gas is flowing is upstream.

## COMMONLY ABBREVIATED ORGANIZATION/ACRONYMS

---

**AGA**. American Gas Association.

**ANSI**. American National Standards Institute.

**APGA**. American Public Gas Association.

**APGA SIF**. APGA Security and Integrity Foundation

**API**. American Petroleum Institute.

**ASME**. American Society of Mechanical Engineers.

**ASTM**. American Society for Testing and Materials.

**CGA**. Common Ground Alliance

**CFR**. Code of Federal Regulations

**CGI**. Combustible Gas Indicator. A type of leak detection equipment

**DIMP**. Distribution Integrity Management Program

**DIRT**. Damage Information Reporting Tool, a program of the Common Ground Alliance

**DOT**. U.S. Department of Transportation.

**FI**. Flame Ionization Unit. a type of leak detection equipment

**GPTC**. Gas Piping Technology Committee.

**INGAA**. Interstate Natural Gas Association of America.

**LEL**. Lower Explosive Limit

**MAOP**. Maximum Allowable Operating Pressure

**MEA**. Midwest Energy Association.

**MSS**. Manufacturers Standardization Society of the Valve and Fittings Industry.

**NACE**. NACE International (formerly known as the National Association of Corrosion Engineers).

**NAPSR**. National Association Pipeline Safety Representatives

**NFPA**. National Fire Protection Association.

**NRC**. National Response Center

**NTSB**. National Transportation Safety Board

**NGA**. Northeast Gas Association

**O & M**. Operations and Maintenance

**OPS**. Office of Pipeline Safety, the pipeline safety division of the DOT's Pipeline and Hazardous Materials Safety Administration (PHMSA). Prior to 2003 OPS was housed in DOT's Research and Special Programs Administration (RSPA).

**OQ**. Operator Qualification

**PAP**. Public Awareness Program

**PE**. Polyethylene plastic

**PHMSA** -- Pipeline and Hazardous Materials Safety Administration. A major subdivision of the DOT, it includes the Office of Pipeline Safety. Prior to 2003, OPS was housed in DOT's Research and Special Programs Administration (RSPA).

**psi**. pounds per square inch

**psia**. pounds per square inch absolute (psig + atmospheric pressure)

**psig**. pounds per square inch gauge

**RSPA.** DOT's Research and Special Programs Administration. RSPA housed the Office of Pipeline Safety prior to the creation of PHMSA in 2003. RSPA no longer exists, but this acronym may appear in any rule, advisory bulletin or other OPS action that occurred prior to PHMSA's creation. Even earlier documents may reference the Materials Transportation Bureau (MTB), RSPA's predecessor.

**SGA.** Southern Gas Association.

**TQ.** PHMSA's Inspector Training and Qualifications Division. TQ provides training to educate Federal and State pipeline safety inspectors in pipeline safety compliance requirements, inspection techniques, and enforcement procedures. Formerly known as the Pipeline Safety Division of the Transportation Safety Institute (TSI).

**WEI.** Western Energy Institute

## Appendix B: Forms

Form 1: Report of Main and Service Line Inspection

Form 2: Gas Leak and Repair Report

Form 3: Gas Distribution Inspection and Leakage Repair

Form 3a: Mechanical Fitting Failure Report

Form 4: Patrolling of Pipeline System

Form 5: Inspection Report for Most Master Meter Systems

Form 6: Regulator Inspection Report

Form 7: Relief Valve Inspection Report

Form 8: Valve Locations

Form 9: Valve Inspection Report

Form 10: Monthly Odorant Use Report

Form 11a: Odorization Check Report – Odor Concentration Test

Form 11b: Odorization Check Report – Odor Concentration Test

Form 12: Telephonic Report of Odor

Form 12a: Daily Odor Call Log

Form 13: Atmospheric Corrosion Control Inspection

Form 14: Cathodic Protection Worksheet

Form 15: Corrosion Control – Rectifier Inspection

Form 16: Pipeline Test Report

General Maintenance Schedule

# REPORT OF MAIN AND SERVICE LINE INSPECTION

Form 1

**OPERATOR:** \_\_\_\_\_

This form is to be completed each time a transmission or distribution main or service line is uncovered for inspection or any other reason, such as making service connections, main extensions, replacements, etc.

**DATE:** \_\_\_\_\_

**1. Location:** \_\_\_\_\_

**2. Name of Inspector:** \_\_\_\_\_

**3. Designation of Line:** Transmission \_\_\_\_\_ Main \_\_\_\_\_ Service \_\_\_\_\_

**4. Line Size:** \_\_\_\_\_ Inches \_\_\_\_\_

**5. Maximum Operating Pressure:** \_\_\_\_\_

**6. Pipe Material:** \_\_\_\_\_

**7. Pipe to Soil Potential:** \_\_\_\_\_

**8. Coating: Type** \_\_\_\_\_

**9. Coating Condition:** Good  Poor  Uncoated

**10. External Pipe Condition:** Smooth  Pitted  Depth of Pits \_\_\_\_\_

**11. Internal Pipe Condition\*:** Smooth  Pitted  Depth of Pits \_\_\_\_\_

**12. Other Structures in the Area Endangering Pipeline:** \_\_\_\_\_

**13. Condition of Right-of-Way:** \_\_\_\_\_

**14. Corrective Measures Taken if Needed:** \_\_\_\_\_

**15. Anodes Installed: How many?** \_\_\_\_\_ **Size** \_\_\_\_\_ **Location** \_\_\_\_\_

**16. Soil: Kind:** Sand  Clay  Loam  Cinders  Refuse

**Packing:** Loose  Medium  Hard

**Moisture Content:** Dry  Damp  Wet

\*Cross through this section if the pipe is not open to allow internal inspection

# GAS LEAK AND REPAIR REPORT

Form 2

**OPERATOR:** \_\_\_\_\_

**Receipt of Report:**

**Date:** \_\_\_\_\_ **Time:** \_\_\_\_\_ a.m.  p.m.

**Location of Leak:** \_\_\_\_\_  
(address, intersection, etc.)

**Reported by:** \_\_\_\_\_  
(Name) (Address)

**Description of Leak:** \_\_\_\_\_  
(inside/outside)

**Leak Detected by:** \_\_\_\_\_

**Leak Reported by:** \_\_\_\_\_

**Report Received by:** \_\_\_\_\_

**Dispatched**

**Date:** \_\_\_\_\_ **Time:** \_\_\_\_\_ a.m.  p.m.

**Investigation Assigned to:** \_\_\_\_\_  
(Name)

**Assigned as Immediate Action Required? Yes**  **No**

**Investigation**

**Date:** \_\_\_\_\_ **Time:** \_\_\_\_\_ a.m.  p.m.

**Investigation by:** \_\_\_\_\_ **Leak Found? Yes**  **No**

**CGI Used? Yes**  **Leak Grade: 1**  **2**  **3**  **No**

**Location of Leak:** \_\_\_\_\_

**Cause of Leak:** \_\_\_\_\_

**Condition Made Safe: Date:** \_\_\_\_\_ **Time:** \_\_\_\_\_ a.m.  p.m.

**Repair Report**

**Length of Pipe Exposed:** \_\_\_\_\_ feet

**Leak at: Threads**  **Coupling**  **Weld (give type)** \_\_\_\_\_ **Valve**  **Other** \_\_\_\_\_

**Pipe: Size:** \_\_\_\_\_ inches/Steel  Plastic  Cast Iron  Other ( ) Depth ( )

**Coating: Enamel**  **Wrapped**  **Galvanized**  **Other** ( )

**Condition: Excellent**  **Good**  **Fair**  **Poor**

**Soil Conditions: Sand**  **Clay**  **Loam**  **Other (describe)** \_\_\_\_\_

**Moisture: Dry** \_\_\_\_\_ **Damp** \_\_\_\_\_ **Wet** \_\_\_\_\_

**Repairs Made:** \_\_\_\_\_

**Repair Coating Type: Mastic**  **Hot Applied Tape**  **Other (describe)** \_\_\_\_\_

**Anodes Installed: How many?** \_\_\_\_\_ **Anode Weight** \_\_\_\_\_ lbs **Depth Installed** \_\_\_\_\_

**Repairs Made by:** \_\_\_\_\_ **Date** \_\_\_\_\_

(Name)

**Foreman:** \_\_\_\_\_ **Supervisor:** \_\_\_\_\_

(Signature) (Signature)

**Posted by:** \_\_\_\_\_ **Date:** \_\_\_\_\_

# GAS DISTRIBUTION INSPECTION AND LEAKAGE REPAIR

Form 3

**OPERATOR:** \_\_\_\_\_  
**ADDRESS:** \_\_\_\_\_  
 \_\_\_\_\_  
 \_\_\_\_\_

**Grade of Leak Case**  
**Grade I**       
**Grade II**      
**Grade III**   

**SKETCH SHOWING LEAKS LOCATED**

**METER SET**

	Meter No. _____ (if inspected)
--	-----------------------------------

**LEAK DATA**

Detected By		Collecting		Probable Source		C.G.I. Test
FI Unit	<input type="checkbox"/>	In Building	<input type="checkbox"/>	Mainline	<input type="checkbox"/>	Gas Percent (%)
IR/Laser	<input type="checkbox"/>	Near Building	<input type="checkbox"/>	Service Line	<input type="checkbox"/>	L.E.L.
Visual/Vegetation	<input type="checkbox"/>	In Manhole	<input type="checkbox"/>	Service Tap	<input type="checkbox"/>	P.P.M.
CGI	<input type="checkbox"/>	In Soil	<input type="checkbox"/>	Valve	<input type="checkbox"/>	Negative
Odor	<input type="checkbox"/>	In Air	<input type="checkbox"/>	Meter Set	<input type="checkbox"/>	
Bar Hole	<input type="checkbox"/>	Other	<input type="checkbox"/>	Tee	<input type="checkbox"/>	

Surface		Leak Cause		Leak Cause	
Lawn	<input type="checkbox"/>	Corrosion, External	<input type="checkbox"/>	Natural Forces	<input type="checkbox"/>
Soil	<input type="checkbox"/>	Corrosion, Atmospheric	<input type="checkbox"/>	Material, Weld or Joint Failure	<input type="checkbox"/>
Paved	<input type="checkbox"/>	Corrosion, Internal	<input type="checkbox"/>	Equipment Malfunction	<input type="checkbox"/>
Other	<input type="checkbox"/>	Excavation	<input type="checkbox"/>	Inappropriate Operations	<input type="checkbox"/>
		Other Outside Force	<input type="checkbox"/>	Other	<input type="checkbox"/>

Component	Explanation	Part of System		Pipe Type	Size	Year Installed
Pipe		Main	<input type="checkbox"/>	Steel		
Valve		Service	<input type="checkbox"/>	Cast Iron		
Fitting		Meter Set	<input type="checkbox"/>	Plastic		
Drip		Customer Piping	<input type="checkbox"/>	Other		
Drip Connection		Other	<input type="checkbox"/>			
Regulator						
Other						

Pipe Condition:    Good:          Fair:          Poor:   

Coating Condition:    Good:          Fair:          Poor:   

Date Repaired: \_\_\_\_\_ Date Rechecked: \_\_\_\_\_

Remarks: \_\_\_\_\_

Inspection/Repair performed by: \_\_\_\_\_

# MECHANICAL FITTING FAILURE REPORT

Form 3A

- 1) Location of Failed Fitting (Address, etc.): \_\_\_\_\_
- 2) Date of Failure: \_\_\_\_\_
- 3) Specify the Mechanical Fitting Involved:  Stab  Nut Follower  Bolted  Other Compression Type Fitting \_\_\_\_\_
- 4) Specify the Type of Mechanical Fitting:  Service or Main Tee  Tapping Tee  Transition Fitting  Coupling  Riser  
 Adapter  Valve  Sleeve  End Cap  Other \_\_\_\_\_
- 5) Leak Location:  Aboveground or  Belowground;  
 Inside or  Outside;  
 Main-to-Main or  Main-to-Service or  Service-to-Service or  Meter Set
- 6) Year Installed: \_\_\_\_\_
- 7) Year Manufactured: \_\_\_\_\_
- 8) If Neither Year Installed or Year Manufactured is Known, Provide Decade Installed: \_\_\_\_\_
- 9) Manufacturer: \_\_\_\_\_
- 10) Part or Model Number: \_\_\_\_\_
- 11) Lot Number: \_\_\_\_\_
- 12) Other Attributes: \_\_\_\_\_
- 13) Fitting Material:  Steel  Plastic  Combination Plastic and Steel  Brass  Unknown  Other \_\_\_\_\_
- 14) Specify the two materials connected to the failed mechanical fitting:
- a) First Pipe  
Nominal Size:  1/4"  1/2"  3/4"  1"  1-1/4"  1-1/2"  1-3/4"  2"  3"  4"  6"  8" or larger  
Unit:  IPS or  CTS or  NPS
- Material:  Steel  Cast/Wrought Iron  Ductile Iron  Copper  Plastic  Unknown  Other \_\_\_\_\_  
❖ If Plastic ⇒ Specify:  Polyethylene (PE)  Polyvinyl Chloride (PVC)  Cross-linked Polyethylene (PEX)  
 Polybutylene (PB)  Polypropylene (PP)  Acrylonitrile Butadiene Styrene (ABS)  Polyamide (PA)  
 Cellulose Acetate Butyrate (CAB)  Other ⇒ Specify: \_\_\_\_\_
- b) Second Pipe  
Nominal Size:  1/4"  1/2"  3/4"  1"  1-1/4"  1-1/2"  1-3/4"  2"  3"  4"  6"  8" or larger  
Unit:  IPS or  CTS or  NPS
- Material:  Steel  Cast/Wrought Iron  Ductile Iron  Copper  Plastic  Unknown  Other \_\_\_\_\_  
❖ If Plastic ⇒ Specify:  Polyethylene (PE)  Polyvinyl Chloride (PVC)  Cross-linked Polyethylene (PEX)  
 Polybutylene (PB)  Polypropylene (PP)  Acrylonitrile Butadiene Styrene (ABS)  Polyamide (PA)  
 Cellulose Acetate Butyrate (CAB)  Other ⇒ Specify: \_\_\_\_\_
- 15) Apparent Cause of Failure:  
 Corrosion  
 Natural Forces Was there thermal expansion/contraction?  Yes or  No  
 Excavation Damage Time excavation damage occurred?  At time of leak discovery or  Previous to leak discovery  
 Other Outside Force Damage  
 Material or Welds/Fusions Was the leak due to  Construction/Installation Defect or  Material Defect or  Design Defect  
 Equipment  
 Incorrect Operation  
 Other Explain: \_\_\_\_\_
- 16) How did the leak occur?  Leaked Through Seal or  Leaked Through Body or  Pulled Out
- 17) Was this a hazardous leak requiring reporting?  Yes or  No

Form completed by (name): \_\_\_\_\_



**PATROLLING OF PIPELINE SYSTEM**

**Form 4**

**OPERATOR:** \_\_\_\_\_

**Period Covered: Began** \_\_\_\_\_ **Ended** \_\_\_\_\_

**Areas Covered:** \_\_\_\_\_

**Map References:** \_\_\_\_\_

**Leakage Indications Discovered (describe locations and indications, such as a condition of vegetation):**

**Describe any unusual conditions at highway and railroad crossings:** \_\_\_\_\_

**Other Factors noted which could affect present or future safety or operations of the gas system:**

**Follow-up (repairs, maintenance or test resulting from this inspection):** \_\_\_\_\_

**Comments:** \_\_\_\_\_

**Number of Persons in Patrol Party:** \_\_\_\_\_

**Signature of person in charge of patrol party:** \_\_\_\_\_

**Date:** \_\_\_\_\_

**INSPECTION REPORT FOR MOST MASTER METER SYSTEMS**

Form 5

**OPERATOR:** \_\_\_\_\_

**Name of Building:** \_\_\_\_\_ **Town:** \_\_\_\_\_

**Location:** \_\_\_\_\_

**Inspector(s):** \_\_\_\_\_

**Check List**

1. **Supply Main: Average pressure:** \_\_\_\_\_ **Location:** \_\_\_\_\_

**Method of Leak Test:** \_\_\_\_\_

**Results:** \_\_\_\_\_

2. **Service Line: Size:** \_\_\_\_\_ **Location:** \_\_\_\_\_

**Method of Leak Test:** \_\_\_\_\_

**Results:**

Entrance Above  Below  Ground?

Is Meter Stop Accessible and in Good Working Order? Yes  No

3. **Meter: Make:** \_\_\_\_\_ **Size:** \_\_\_\_\_ **Number:** \_\_\_\_\_

**Location:** \_\_\_\_\_

**Case and Fittings Tested for Leaks?** \_\_\_\_\_

**Method of Leak Test:** \_\_\_\_\_

**Results:**

4. **Regulators: Make:** \_\_\_\_\_ **Size:** \_\_\_\_\_ **Number:** \_\_\_\_\_

**Delivery Pressure:** \_\_\_\_\_ **Vented Properly to Outside? Yes**  **No**

**Relief Valve: Make:** \_\_\_\_\_ **Size:** \_\_\_\_\_

**Were Regulator and Fittings Tested for Leaks? Yes**  **No**

**Results:**

**Was there Indication of Leakage on Meter with Appliances off? Yes**  **No**

**Signed:** \_\_\_\_\_ **Date:** \_\_\_\_\_

**REGULATOR INSPECTION REPORT**

Form 6

**OPERATOR:** \_\_\_\_\_

**Location:** \_\_\_\_\_

**Regulator Information**

**Make:** \_\_\_\_\_ **Type:** \_\_\_\_\_

**Size:** \_\_\_\_\_ **Orifice Size:** \_\_\_\_\_

**Pressure Rating: Inlet:** \_\_\_\_\_ **Outlet:** \_\_\_\_\_

**M.A.O.P. of Downstream Piping:** \_\_\_\_\_

**Operating Pressure: Inlet:** \_\_\_\_\_ **Outlet:** \_\_\_\_\_

**Lock Up Pressure:** \_\_\_\_\_

**Monitoring Regulator or Relief Setting:** \_\_\_\_\_

**Was the Regulator Stroked (to fully open)?** Yes  \_\_\_\_\_ No  \_\_\_\_\_

**General Condition of the Station:**

**Atmospheric Corrosion:** Yes  \_\_\_\_\_ No  \_\_\_\_\_

**Support Piping Rigid:** Yes  \_\_\_\_\_ No  \_\_\_\_\_

**Station Guards:** Yes  \_\_\_\_\_ No  \_\_\_\_\_

**Area Clean of Weeds and Grass:** Yes  \_\_\_\_\_ No  \_\_\_\_\_

**Capacity at Inlet and Outlet pressure:** \_\_\_\_\_

**Corrections Made:** \_\_\_\_\_

**Remarks:** \_\_\_\_\_

**Inspector:** \_\_\_\_\_

**Signature:** \_\_\_\_\_ **Date:** \_\_\_\_\_

**RELIEF VALVE INSPECTION REPORT**

Form 7

**OPERATOR:** \_\_\_\_\_

**Location:** \_\_\_\_\_

**Relief Valve Information**

**Make:** \_\_\_\_\_ **Type:** \_\_\_\_\_

**Size:** \_\_\_\_\_ **Orifice Size:** \_\_\_\_\_

**Type of Loadings:**  
**Spring:**  **Pilot:**  **Other:** \_\_\_\_\_  
**Range:** \_\_\_\_\_

**Pressure Setting:** \_\_\_\_\_

**Connecting Pipe Size:** \_\_\_\_\_

**Vent Stack Size:** \_\_\_\_\_

**Capacity:** \_\_\_\_\_

**General Condition of:**  
**Relief Valve:** \_\_\_\_\_  
**Recording Gauge:** \_\_\_\_\_  
**Support Piping:** \_\_\_\_\_  
**General Area:** \_\_\_\_\_

**Repairs Required:** \_\_\_\_\_

**Repairs Made:** \_\_\_\_\_

**Remarks:** \_\_\_\_\_

**Inspector:** \_\_\_\_\_

**Signature:** \_\_\_\_\_ **Date:** \_\_\_\_\_



**VALVE INSPECTION REPORT**

**Form 9**

**OPERATOR:** \_\_\_\_\_

\*\*\*\*\*

<b>Valve Number</b>	<b>Location (Form 8)</b>	<b>Date Inspected</b>	<b>Inspected By</b>

\*\*\*\*\*

<b>Valve Number</b>	<b>Location (Form 8)</b>	<b>Date Inspected</b>	<b>Inspected By</b>

\*\*\*\*\*

<b>Valve Number</b>	<b>Location (Form 8)</b>	<b>Date Inspected</b>	<b>Inspected By</b>

\*\*\*\*\*

<b>Valve Number</b>	<b>Location (Form 8)</b>	<b>Date Inspected</b>	<b>Inspected By</b>

**MONTHLY ODORANT USE REPORT**

Form 10

**OPERATOR:** \_\_\_\_\_

**Odorizer Location:** \_\_\_\_\_

**Date of Last inspection:** \_\_\_\_\_ **Today's date** \_\_\_\_\_

**Odorizer Information**

**Make:** \_\_\_\_\_ **Type:** \_\_\_\_\_

**Tank Capacity:** \_\_\_\_\_ **gal. or lb.**

**Brand Name of Odorant Used:** \_\_\_\_\_

**Odorant Usage:**

1. **Odorant in tank at last inspection:** \_\_\_\_\_

2. **Odorant Added Since Last Inspection:** \_\_\_\_\_

3. **Total Odorant to Account for (Items 1 + 2):** \_\_\_\_\_

4. **Odorant in Tank Today:** \_\_\_\_\_

5. **Odorant Used During this Period (Items 3 – 4):** \_\_\_\_\_

6. **Gas Delivery this Period:** \_\_\_\_\_ **mmcf**

7. **Rate of Odorization in lbs. or gal./mmcf:**

<u>Odorant Used in lbs./gal</u>	<u>(Item 5)</u>	lbs. or gals./mmcf
	=	
Gas Delivery in mmcf	(Item 6)	

[Note: mmcf = million cubic foot]

**Superintendent/Inspector:** \_\_\_\_\_

**Signature:** \_\_\_\_\_ **Date:** \_\_\_\_\_

**ODORIZATION CHECK REPORT**  
**ODOR CONCENTRATION TEST**

Form 11A

**OPERATOR:** \_\_\_\_\_

See Chapter IV, Odor Test Procedure.

**ODOR CONCENTRATION METER TEST REPORT.**

---

**Location:** \_\_\_\_\_  
**Date:** \_\_\_\_\_  
**Test conducted by:** \_\_\_\_\_  
**Instrument Manufacturer:** \_\_\_\_\_  
**Serial Number:** \_\_\_\_\_  
**Date of last calibration:** \_\_\_\_\_

---

**ODOR CONCENTRATION METER TEST RESULTS**

---

<b>Threshold Detection Level</b>	% gas-in-air
<b>Readily Detectable Level</b> (must be 1/5 of the LEL or less)	% gas-in-air

---



**ODORIZATION CHECK REPORT**  
**ODOR CONCENTRATION TEST**

Form 11B

**OPERATOR:** \_\_\_\_\_

**MASTER METER SNIFF TEST REPORT**

Master meter operators may comply with the requirements of §192.625 by obtaining an annual written confirmation from their gas supplier that the gas is appropriately odorized in accordance with the regulation. The master meter operator must also conduct sniff tests at the extremities of the system to confirm a gas odor.

**Location:** \_\_\_\_\_

**Date:** \_\_\_\_\_

<b>Odor Strength:</b>	<input type="checkbox"/> *	<b>Not Detectable*</b>
	<input type="checkbox"/> *	<b>Barely Detectable*</b>
	<input type="checkbox"/>	<b>Readily Detectable</b>
	<input type="checkbox"/>	<b>Strong</b>

**Test conducted by:** \_\_\_\_\_

**Witnessed by:** \_\_\_\_\_

**\*If the odor is not detectable or barely detectable you should notify your gas supplier immediately!**

**TELEPHONIC REPORT OF ODOR**

Form 12

**OPERATOR:** \_\_\_\_\_

**Customer Information**

**Time Call Received:** \_\_\_\_\_ a.m.  p.m.  **Date:** \_\_\_\_\_

**Name of Caller:** \_\_\_\_\_ **Caller's Phone Number:** \_\_\_\_\_

**Name of Customer if not Caller:** \_\_\_\_\_

**Address of Odor:** \_\_\_\_\_  
\_\_\_\_\_  
\_\_\_\_\_

**Nature of Complaint:** Odor (  )      Blowing Gas (  )      Dead Vegetation (  )

Other (describe): \_\_\_\_\_

**Is the gas odor or sound inside the residence?**      Yes       No

**If so, where is it located? (at the water heater, at the heating system, at the stove, in the hall, in the kitchen, etc.):** \_\_\_\_\_  
\_\_\_\_\_

**Is the gas odor or sound outside the residence?**      Yes       No

**If so, where is it located? (at the meter, near the street, at the house, in the ditch, at the pool, at the gas grill, etc.):** \_\_\_\_\_  
\_\_\_\_\_

**How long have you been smelling or hearing the gas?** \_\_\_\_\_

**Will someone be home for us to check the leak?**      Yes       No

**Leak Response Information**

**Time Dispatched Investigator:** \_\_\_\_\_ a.m.  p.m.  **Date:** \_\_\_\_\_

**Name of Investigator:** \_\_\_\_\_

**Time of Investigator Arrival at Scene of Leak:** \_\_\_\_\_ a.m.  p.m.

**Action Taken:** \_\_\_\_\_  
\_\_\_\_\_  
\_\_\_\_\_

**Time of Investigator Completion at Scene of Leak:** \_\_\_\_\_ a.m.  p.m.

**Additional Follow-up (if needed):**      Yes       No

**If so, what type of follow-up:** \_\_\_\_\_  
\_\_\_\_\_  
\_\_\_\_\_

**Additional Remarks:** \_\_\_\_\_  
\_\_\_\_\_  
\_\_\_\_\_

**Signature of Investigator:** \_\_\_\_\_

**Signature of Supervisor:** \_\_\_\_\_

## DAILY ODOR CALL LOG

Form 12A

**OPERATOR**

**Location:**

:

**Date:**

No.	Time Received	Caller's Name Phone Number	Code	Address of Reported Odor	Time Dispatched	Time Arrived	Tech & No.	Action Taken	Time Compl.	Superv. Initials
1	<input type="checkbox"/> a.m. <input type="checkbox"/> p.m.				<input type="checkbox"/> a.m. <input type="checkbox"/> p.m.	<input type="checkbox"/> a.m. <input type="checkbox"/> p.m.			<input type="checkbox"/> a.m. <input type="checkbox"/> p.m.	
2	<input type="checkbox"/> a.m. <input type="checkbox"/> p.m.				<input type="checkbox"/> a.m. <input type="checkbox"/> p.m.	<input type="checkbox"/> a.m. <input type="checkbox"/> p.m.			<input type="checkbox"/> a.m. <input type="checkbox"/> p.m.	
3	<input type="checkbox"/> a.m. <input type="checkbox"/> p.m.				<input type="checkbox"/> a.m. <input type="checkbox"/> p.m.	<input type="checkbox"/> a.m. <input type="checkbox"/> p.m.			<input type="checkbox"/> a.m. <input type="checkbox"/> p.m.	
4	<input type="checkbox"/> a.m. <input type="checkbox"/> p.m.				<input type="checkbox"/> a.m. <input type="checkbox"/> p.m.	<input type="checkbox"/> a.m. <input type="checkbox"/> p.m.			<input type="checkbox"/> a.m. <input type="checkbox"/> p.m.	
5	<input type="checkbox"/> a.m. <input type="checkbox"/> p.m.				<input type="checkbox"/> a.m. <input type="checkbox"/> p.m.	<input type="checkbox"/> a.m. <input type="checkbox"/> p.m.			<input type="checkbox"/> a.m. <input type="checkbox"/> p.m.	
6	<input type="checkbox"/> a.m. <input type="checkbox"/> p.m.				<input type="checkbox"/> a.m. <input type="checkbox"/> p.m.	<input type="checkbox"/> a.m. <input type="checkbox"/> p.m.			<input type="checkbox"/> a.m. <input type="checkbox"/> p.m.	
7	<input type="checkbox"/> a.m. <input type="checkbox"/> p.m.				<input type="checkbox"/> a.m. <input type="checkbox"/> p.m.	<input type="checkbox"/> a.m. <input type="checkbox"/> p.m.			<input type="checkbox"/> a.m. <input type="checkbox"/> p.m.	
8	<input type="checkbox"/> a.m. <input type="checkbox"/> p.m.				<input type="checkbox"/> a.m. <input type="checkbox"/> p.m.	<input type="checkbox"/> a.m. <input type="checkbox"/> p.m.			<input type="checkbox"/> a.m. <input type="checkbox"/> p.m.	
9	<input type="checkbox"/> a.m. <input type="checkbox"/> p.m.				<input type="checkbox"/> a.m. <input type="checkbox"/> p.m.	<input type="checkbox"/> a.m. <input type="checkbox"/> p.m.			<input type="checkbox"/> a.m. <input type="checkbox"/> p.m.	
10	<input type="checkbox"/> a.m. <input type="checkbox"/> p.m.				<input type="checkbox"/> a.m. <input type="checkbox"/> p.m.	<input type="checkbox"/> a.m. <input type="checkbox"/> p.m.			<input type="checkbox"/> a.m. <input type="checkbox"/> p.m.	







**PIPELINE TEST REPORT**

Form 16

**OPERATOR:** \_\_\_\_\_

**Testing Company:** \_\_\_\_\_

**This form must be completed for each section of newly installed section of pipe or service line and on each service line that is disconnected from the main for any reason.**

**Test Data**

**Type of Pipe:** \_\_\_\_\_

**Size of Pipe:** \_\_\_\_\_ inches      **Length of Line:** \_\_\_\_\_

**Location of Line:** \_\_\_\_\_

\_\_\_\_\_  
\_\_\_\_\_

**Tested with:** Nitrogen ()    Air ()    Natural Gas ()    Water ()  
**Other (describe):** \_\_\_\_\_

**Time Started:** \_\_\_\_\_ a.m.  p.m.       **Time Ended:** \_\_\_\_\_ a.m.  p.m.

**Test Pressure Start:** \_\_\_\_\_ psig

**Test Pressure Stop:** \_\_\_\_\_ psig

**Line Loss:** Yes       No       **Amount Loss:** \_\_\_\_\_ mcf

**Reason for Line Loss:** \_\_\_\_\_

\_\_\_\_\_  
\_\_\_\_\_

**Corrective Measures Taken:** \_\_\_\_\_

\_\_\_\_\_  
\_\_\_\_\_

**Remarks:** \_\_\_\_\_

\_\_\_\_\_  
\_\_\_\_\_

**Operator Representative:** \_\_\_\_\_

**Signature:** \_\_\_\_\_      **Date:** \_\_\_\_\_

## GENERAL MAINTENANCE SCHEDULE

			Jan.	Feb.	Mar.	Apr.	May	Jun.	Jul.	Aug.	Sep.	Oct.	Nov.	Dec.
1	Patrol Pipeline Systems	192.705 192.721												
2	Patrol River Crossings, Railroad and Highway Crossings	192.705 192.721												
3	Gas Leak Detection Surveys	192.723												
	Downtown and Other Business Areas	192.723												
	Distribution Mains and Services	192.723												
4	Pressure Regulating Stations	192.739												
5	Regulator Stations and Recording of Pressures	192.741												
6	Pressure Relief Valves	192.743												
7	Valve Maintenance on Distribution Lines	192.747												
8	Odorization of Gas	192.625												
9	Corrosion Control – External	192.465												
10	Corrosion Control – Atmospheric	192.481												
11	Corrosion Control – Examination	192.459	Examine and record observations anytime buried piping is exposed.											
12	Corrosion Control – Rectifiers	192.465												
13	Testing of Piping	192.501 to 192.571	Test and record new pipe installations or connections per these code sections.											

**NOTE:** Certain components of this maintenance schedule may not be applicable to some smaller “Master Meter Operators.” Shade in the month you intend to perform the maintenance and post in a prominent location as a reminder.



# APPENDIX C

## FEDERAL AND STATE REGULATORY AGENCIES

The most current list of state pipeline safety agencies can be found at <http://www.napsr.org/state-program-managers>.

U.S Department of Transportation  
Pipeline and Hazardous Materials Safety Administration  
East Building, 2nd Floor  
Mail Stop: E24-455  
1200 New Jersey Ave., SE  
Washington, DC 20590  
202-366-4595  
202-366-4566 (Fax)

### **U.S DOT/PHMSA/OPS Regional Offices:**

Eastern Region Office  
820 Bear Tavern Road, Suite 103  
West Trenton, NJ 08628  
609-989-2171  
609-882-1209 (Fax)

Southwest Region Office  
8701 S. Gessner Road, Suite 1110  
Houston, TX 77074  
713-272-2859  
713-272-2831 (Fax)

Southern Region Office  
233 Peachtree Street NE, Suite 600  
Atlanta, Georgia 30303  
404-832-1147  
404-832-1169 (Fax)

Western Region Office  
12300 W. Dakota Ave  
Suite 110  
Lakewood, CO 80228  
720-963-3160  
720-963-3161 (Fax)

Central Region Office  
901 Locust Street, Suite 462  
Kansas City, MO 64106  
816-329-3800  
816-329-3831 (Fax)