

VERSION

1.0

THE ULTIMATE GUIDE TO THE PERFECT BASS SETUP



Everything You
Ever Wanted
to Know About
the Perfect Bass Setup

The Secret to Keeping Your Instrument
In Perfect Condition at All Times

BY JERZY DROZD

WWW.JERZYDROZDBASSES.COM

Update History

Version 1.0 / Dec. 17, 2009 – Publication of the first version

Your Comments on this Guide

Please visit our Forum at this link to leave your comments:

<http://www.jerzydrozdbasses.com/forum/viewforum.php?f=19>

You can also send them to us directly at:

info@jerzydrozdbasses.com

THE ULTIMATE GUIDE TO THE PERFECT BASS SETUP

**Everything You Ever Wanted to Know
About the Perfect Bass Setup**

**The Secret to Keeping Your Instrument
In Perfect Condition at All Times**

by Jerzy Drozd

CONTENT

Important Information: 6

Introduction

Waiver 9

Safety: 9

Chapter 1

Preparing Your Instrument

Before You Begin 11

Choosing a Place to Work 11

Tools 12

Getting the Instrument Ready 13

Cleaning the Fingerboard 13

Cleaning the Bridge 14

Cleaning the Electronics 15

Chapter 2

Adjusting the Instrument

Changing the Strings 17

Pre-Adjustment of the Bridge - Height 18

Neck Adjustment 22

The Neck Adjustment Process 29

Bridge – Setting the Intonation 31

The Intonation Setting Process 32

Adjusting the Height and Angle of the Pickups 36

The Adjustment Schedule 39

Chapter 3

Instruments with a Double Truss-Rod

Instruments with a Double Truss-Rod 41

Parallel Truss-Rod System (A+A) 41

Diagonal Double Truss-Rod System (A+B) 42

Appendix A

Standard Tuning Table 47

Tuning Table for ERB Basses 48

Cut-Out Templates for Curvature Adjustment 49

Standard Formats A and B 49

Cut-Out Templates for Curvature Adjustment 52

ERB Formats A and B 52

Appendix B

More Educational Products

From Jerzy Drozd

The Alchemy of Sound - The Book 58

Bass Design Fundamentals - Video Course 60

Important Information:

This book is for free distribution. You may copy it and distribute it or include it with other products at no charge, as long as the full, unaltered text appears and it is provided in either pdf or printed format.

You are allowed to publish excerpts from this book only if you include the following links: www.jerzydrozdbasses.com and www.electric-bass-secrets.com.

Unless another source is indicated, all text and images appearing in this work are protected under the author's copyright.

The author of this book has no commercial affiliation or contract with any of the registered trademarks (® or ™) used as examples for purposes of demonstrating the various processes and setups.

These trademarks include: Fender®, Jazz Bass™, Tobias®, Rickenbacker® and MusicMan®, among others.

A Few Words about Future Updates to this Book

This Guide should be considered as a work in progress and as such, it will be continuously updated. If you have downloaded it directly from our webpage, www.jerzydrozdbasses.com, as a subscriber to our mailing list, we will notify you by e-mail any time we make an update.

If you have received this book as an enclosure with another product or through a third party, we recommend that you subscribe to our mailing list and Newsletter as soon as possible in order to keep informed of any future updates.

You can subscribe right now by clicking on the following link:

<http://www.jerzydrozdbasses.com/subscripcion-newsletter-en.html>

If you have any further information on a topic related to electric bass setup that isn't included here, you can address these concerns or questions to our Forum at this link:

<http://www.jerzydrozdbasses.com/forum/viewforum.php?f=19>

In this way, we can continue to update this book, adding any topics of interest that haven't yet been addressed in **future editions** in order to make this manual as complete as possible, covering every type and style of electric bass currently available on the market.

This is the first edition of this Guide. If you find any errors, please let us know so that we can correct them in future editions. You can contact me directly at: info@jerzydrozdbasses.com.

Introduction

In my honest opinion, every bass player should know how to set up his or her own instrument. Even though some bass players know how to do it, most turn to a professional to do it for them.

So, you might ask, "Why should I learn how to set up my bass if a professional guitar maker (or luthier) can do it for me?"

In time, you will probably discover more reasons, but for now, I will give you two:

First: because if you learn to do it yourself, you will save a lot of money, time and travel.

Second: the setup will be much more customized according to your personal playing style.

The process itself is relatively simple, but it requires a lot of experience before you will be able to do it optimally. I'm not going to lie to you: you won't learn how to do it overnight, but each time you make adjustments to your bass, you will do it better than the time before and one day, you will reach a point where you can set up your own instrument in terms of your personal criteria and needs better than any professional ever could.

As far as I know, there is no other definitive, simple and precise guide available on the market about how to set up an electric bass.

This Guide was written especially for you and for those bass players who would like to learn this process, but don't know where to begin.

Even though it has been written with the electric bass in mind, it can also be used for setting up electric guitars or other similar instruments because the procedures are exactly the same.

Read it, then read it again and make it an indispensable part of your instrument maintenance toolkit.

This is why I have written this book, as my gift to you.



Jerzy Drozd

Waiver

This Guide is for educational purposes only. The author will not be held responsible in any way for damage of any kind, whether personal or material, resulting from the incorrect use or interpretation of the contents of this book.

The user of this guide will be solely responsible in the event of any such damage.

In order to avoid any unnecessary losses, read the instructions and warranties before handling any musical instrument, so that you will be sure use it according to the manufacturer's recommendations and within the terms of the manufacturer's guarantee.

Safety:

Any adjustment that involves tightening the strings or screws or applying any force in general carries certain risks. Be sure to follow all safety regulations and if available, use protective eyewear and gloves to protect your eyes and hands from any possible harm.

Chapter 1

Preparing Your Instrument

Before You Begin

Keep in mind that manipulating the truss-rod or other elements of your bass is prohibited while your instrument is still under warranty. If this is the case, I recommend that you take your instrument to a professional luthier. If you are a complete novice, I also recommend that you practice first on an inexpensive instrument before trying these procedures on your own instrument.

If something goes wrong with an instrument you aren't using anyway, your mistake won't cause any problems and you will learn from it. Remember that trial and error is the best way to learn, as long as you learn from your mistakes so that you won't repeat them.

Choosing a Place to Work

You should choose a place that has enough room to give you unobstructed access to your instrument. The best option would be a table that is large enough to fit the whole instrument.

Place a blanket or towel underneath your instrument to avoid scratching it

Tip #1

During the winter, abrupt temperature changes, both outdoors and indoors, may cause the neck of some instruments to move more than it normally would.

This is why you should allow the instrument time to adjust to room temperature before making adjustments to it during this time of the year. This may take a couple of hours. Remove the instrument from its case and place it in a location away from any direct heat sources.

Tools

Before you begin, you should have all of the necessary tools ready:

1. Standard or Phillips screwdrivers, depending on the make of your instrument, in order to remove the truss-rod plate if your bass has one or to unscrew the battery plate if your bass has active pickups
2. A battery or batteries, if your bass has active pickups; you will normally need a 9v battery or two of them in the case of an 18v bass
3. A set of gauges to adjust the height of the strings; if you don't have one, you can improvise with a credit card
4. A new set of strings
5. Allen wrenches, if you need to adjust the bridge
6. OPTIONAL: A battery tester
7. A brush and cloth or better yet, a chamois
8. Spirit of turpentine for cleaning the fingerboard
9. Templates for determining the curvature of the fingerboard; if they aren't available, **you will find some cut-out templates at the end of this book [here](#)** along with specific instructions on how to use them correctly
10. Small wire cutters to cut the strings

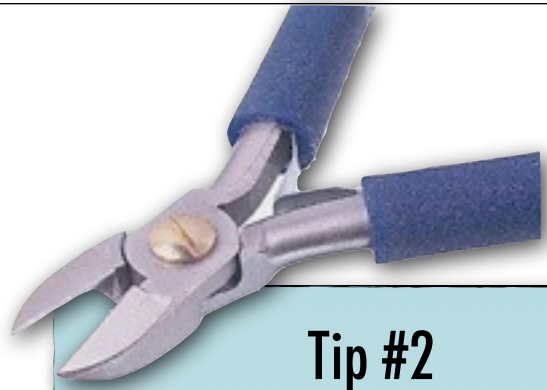
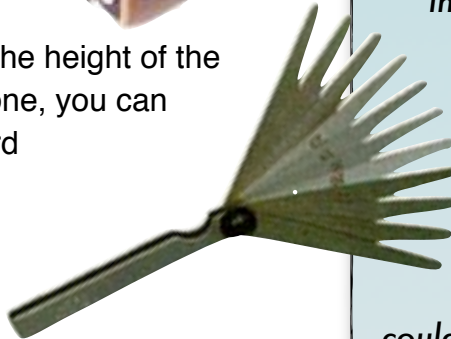

Tip #2

If your instrument needs a thorough cleaning, it will be necessary to remove all of the strings in order to access every part of it.

Remember that routine adjustments that don't involve

a thorough cleaning won't require removing the strings and in fact, it is highly recommended not to remove them. This could cause the neck to become dislocated, due to the tension of the strings not compensating for the tension of the truss-rod, and as a result, it will take even longer to return the instrument to its correct alignment.

Remember:

During routine maintenance, you should change the strings one by one.

Getting the Instrument Ready

If a lot of time has passed since the instrument has been adjusted, it would be a good idea to give your bass a good cleaning.

For this, you will need a brush, a piece of flannel or a chamois, a cleaning product for finished surfaces or one that is made especially for guitars and, last of all, walnut or teak oil and spirit of turpentine.

1. Remove the strings
2. If you are going to make adjustments after cleaning, it won't be necessary to loosen the truss-rod.
3. If you are planning on leaving the instrument without strings for more than 7-8 days after cleaning it, it will be helpful to loosen the truss-rod so that the neck won't warp, which can be very difficult to correct later on.

Tip #3

If you are going to make adjustments after cleaning, it won't be necessary to loosen the truss-rod in the neck.

If you are planning on leaving the instrument without strings for more than 7-8 days after cleaning it, it will be helpful to loosen the truss-rod so that the neck won't warp, which can be very difficult to correct.

Remember:
Loosen the truss-rod if you are planning on leaving the instrument without strings for more than 7-8 days.

Cleaning the Fingerboard

If you haven't cleaned the fingerboard up until now or if a lot of time has passed since you last cleaned it, you should take advantage of this opportunity to clean and polish the wood.

Maple Fingerboards:

If the fingerboard is made from maple and is varnished like the rest of the instrument, you should use the same cleaning product as you use on the whole instrument. In this case, it should be a product for finished wood surfaces. You should gently rub the surface of the fingerboard between the frets with a cloth and a small amount of cleaning solution. This should only take a few minutes.

Rosewood, Ebony or Brazilian Ironwood Fingerboards

As a rule, these woods are treated with an oil-based finish to prevent them from drying out.

In this case, to clean the accumulated grime, we will use spirit of turpentine.

Spirit of turpentine is a suitable product for cleaning wood and, unlike mineral solvents, will not cause it to dry out.

You should moisten a clean, dry cloth with a little bit of solvent and then gently rub the surface of the fingerboard until it is completely clean.

Let the fingerboard dry for about 10 minutes and then apply walnut or teak oil to the surface, rubbing lightly. Let the oil soak in for about 5 minutes and then remove any excess with a clean, dry cloth or paper towel. The wood will usually expel any excess oil, so you should clean it several times at 5-minute intervals.

Cleaning the Bridge

Basically, we will want to rid the bridge of any small particles and debris that have

Tip #4

Spirit of turpentine is the essential oil of turpentine. Turpentine is the resinous sap from certain types of pine trees (originally from the terebinth tree). When turpentine is distilled, two products are obtained: the volatile, liquid essence, which is spirit of turpentine, and a solid resin, called rosin.

You can use spirit of turpentine to clean ALL parts of the instrument that are made from untreated wood or wood with an oil-based finish.

Remember:

Never use other solvents, such as nitro solvent, alcohol or acetone in place of spirit of turpentine.

accumulated between the moving parts. A brush is very good for this purpose.

Afterwards, we will want to lubricate all of the moving pieces, such as the pins and the saddles that make direct contact with them. In general, bridges are made up of a number of metal pieces, which usually have a chrome finish. This finish doesn't require any special maintenance, so to clean it, we will use a chamois. Wooden bridges should be cleaned the same way as the fingerboards, according to the type of finish.

Cleaning the Electronics

Maintenance of the electronic components mostly consists of cleaning and lubricating the volume and tone controls. An aerosol spray designed for cleaning electronic circuits should be used for this. The most common type is "2-26 Electro" from CRC Industries, which you can find at the following link <http://www.crcindustries.com/ei/>. This cleaning spray prevents the controls from wearing out prematurely. Depending on the country you live in, you should be able to find a similar product.

http://www.crcindustries.com/ei/content/prod_detail.aspx?PN=82005&S=Y



Chapter 2

Adjusting the Instrument

Changing the Strings

Before adjusting the instrument, you should change the strings. This is very important because, as the strings age, their properties change and the adjustment won't be correct.

Also, if you decide to change the strings later on, all of the adjustments you have done previously will no longer work and you will have to adjust the instrument again. If you don't have any new strings, I would advise you to hold off on making the adjustments until you do.

You should only make adjustments to the instrument if the strings have been on it for less than a week and if they have been on for less than 4-5 days, it's even better.

With new strings, you assure good intonation and each time you change them, the instrument will already be correctly adjusted.

Remember that it isn't necessary to take the strings off all at once. It is preferable to change them one at a time and it doesn't matter if you start with the highest one or the lowest one.

1. Once you have removed the old string, place the new one across the bridge.
2. Stretch it using the hand furthest away from the tuning head where it will be connected.
3. Cut the string with wire cutters 3-4 inches above the tuning head.
4. Normally, all current tuning heads, whether "Gotoh" or "Schaller," have a hole running through the center. Thread the string through the hole about ½" to 1" and then begin to wind the string clockwise with your fingers.
5. You can use the tuning head to help you wind up all of the remaining string until it begins to tighten.
6. Then, tighten it to the correct tension for that string with the aid of a tuner.
7. Repeat this process with the remaining strings.
8. The number of times you will have to turn the string around the axis of the tuning head will vary depending on the gauge of the string. The lower strings, such as the B and E

strings, should require 2 or no more than 3 turns. The A and D strings should require 3 or no more than 4 turns and the remaining high strings should require 4 or no more than 5 turns, except for the very thin, unbraided strings, which will need approximately 6 to 8 turns.

9. Once you have put on all of the strings, retune each one of them to the correct pitch (see the tuning table [here](#)).

Pre-Adjustment of the Bridge - Height

Before adjusting the neck, we have to adjust the approximate height of the strings over the bridge. If we don't do it at this point, the neck adjustment won't be correct because if the strings are too close to the bridge or too far away, this will lead to an incorrect estimate of the true position of the neck.

Bridge Curvature Templates

To adjust the height of the strings, you should use a curvature template. If you don't have one, you can use the ones included in this Guide. These templates will help you adjust the bridge to the curvature of the fingerboard. In this way, the strings will be at the correct distance from it. A bass rarely has a flat fingerboard, although a few more modern instruments do, such as [Barcelona™](#) or the new [Oracle™](#). The curvature is measured in inches and can vary considerably, from 7 ½" to 20" or more. The ERB-type multi-string basses can reach a curvature of 90" and may have a flat fingerboard. The greater the number of inches, the flatter the fingerboard will be.

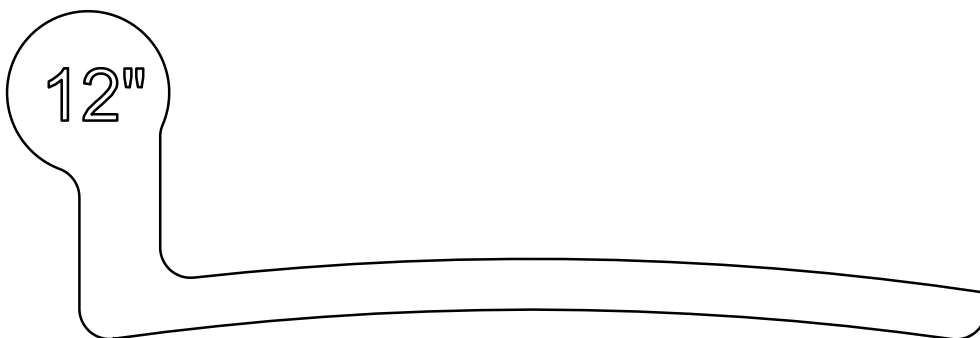

Fig. 1 Example of a **Type A** template for a 12" curvature

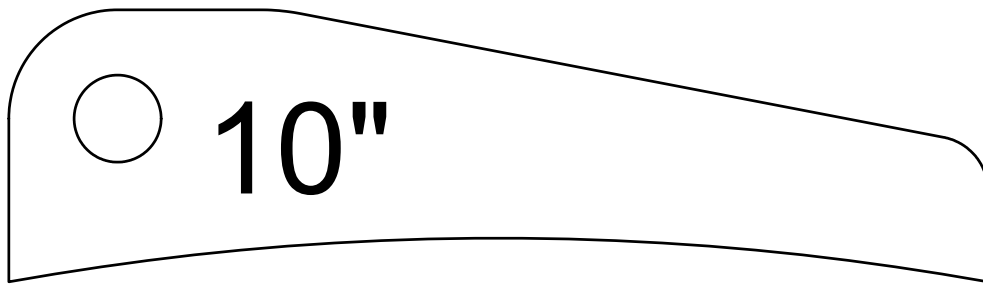

Fig. 2 Example of a **Type B** template for a 10" curvature

Measuring the Curvature of the Fingerboard

First, before adjusting the height of the strings, you have to determine the true curvature of the fingerboard. If you already know it, you can skip this step.

You will need to remove all of the strings to be able to measure it using the templates provided in this Guide. Once you know the curvature, you will only need to use the template that corresponds to your instrument's fingerboard.

Adjusting the Height of the Strings

It is very important that the strings be at a consistent distance from the surface of the fingerboard (the frets). First, you will need to adjust the height of the two outer strings, that is, the thinnest and the thickest.

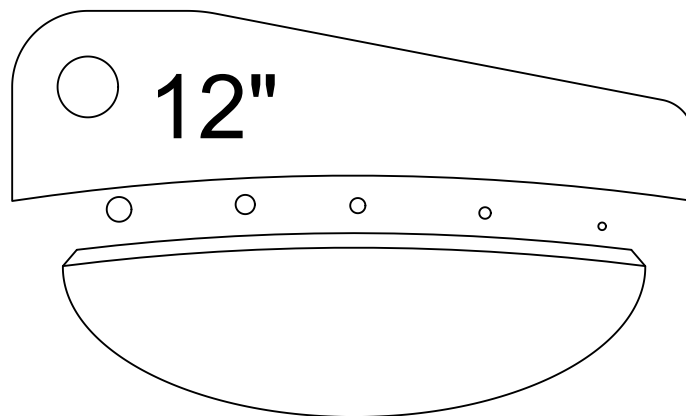

Fig. 3 Curvature template used to adjust the distance of the strings relative to the curvature of the fingerboard.



Fig. 4

Approximate Reference Heights:

Standard Bases		
Bass	approximate thin string height	approximate thick string height
4 strings	G (Sol) 1,8 - 2,0 mm	E (Mi) 2,0 - 2,5 mm
5 strings with Low B	G (Sol) 1,8 - 2,0 mm	B (Si) 2,2 - 2,7 mm
5 strings with High C	C (Do) 1,7 - 1,9 mm	E (Mi) 2,0 - 2,5 mm
6 strings	C (Do) 1,7 - 1,9 mm	B (Si) 2,2 - 2,7 mm
Extended Range Bases		
Bajo	approximate thin string height	approximate thick string height
7 strings	F (Fa) 1,6 - 1,8 mm	B (Si) 2,2 - 2,7 mm
8 strings	1,5 - 1,7 mm *)	2,2 - 2,7 mm *)
9 strings	1,5 - 1,7 mm *)	2,6 - 3,0 mm *)
10 strings	1,1 - 1,5 mm *)	2,6 - 3,0 mm *)
11 strings	1,1 - 1,5 mm *)	2,5 - 3,0 mm *)

**) The values of the strings are not specified because ERB-type instruments can easily accommodate alternative tunings.*

Once you have adjusted the height of the outer strings, adjust the height of the remaining strings using the template with the same curvature as the fingerboard (**Fig. 4**). You will need to cut out all of the templates to determine the true curvature of your instrument's fingerboard.

Two Types of Templates

There are two types of templates: **Type A** (**Fig. 1**) and **Type B** (**Fig. 2**). The **Type A** templates are slightly more precise because they measure from the underside of the strings, which prevents any errors resulting from the varying thickness of the strings.

In **Fig. 5** you can see that the measuring surfaces are different. In the case of the **Type A** template, the measuring surface is from the underside of the strings, but in the case of the **Type B** template, the measuring surface is from the exposed side.

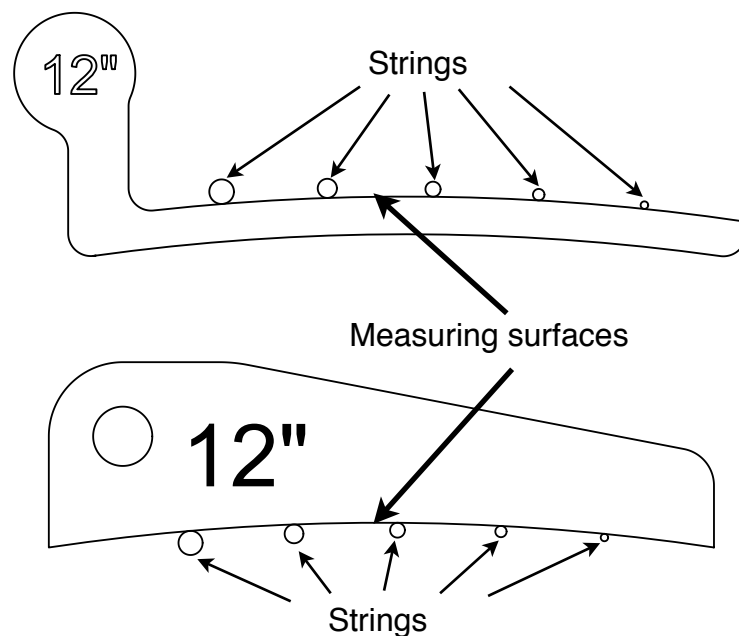

Fig. 5

Neck Adjustment

The neck adjustment is the most delicate part of the whole process and requires the highest level of expertise. As I have already mentioned, if you don't have any experience adjusting your own instrument, practice first on another one that isn't being used. If you follow all of the instructions that are laid out here, the neck of your instrument will not be at risk.

Why Does the Neck Have a Truss-Rod and What Does It Do?

If adjusting and tuning your own instrument is all new to you, then you have probably asked yourself this question more than once.

In general, all basses have a truss-rod, except for those that have a neck made of carbon-fiber (we will discuss those necks later on) or those that are very inexpensive.

The truss-rod runs along the inside of the neck across its length from the head stock to the point where it connects to the body. The truss-rod, itself, may vary, but its function is always the same: to counterbalance the tension of the strings and hold the neck in the correct position and shape when it comes to making an optimal adjustment. There are both fixed and adjustable truss-rods.

Fixed Truss-Rods

The only purpose of fixed truss-rods is to reinforce the neck and these are usually round or flat steel, titanium, aluminum or carbon-fiber rods. We won't spend a lot of time discussing this type of truss-rod, since it doesn't allow for making precision adjustments to the neck.

Adjustable Truss-Rods

This type of truss-rod comes in several different formats and can function in several different ways.

The simplest format is the one used in the basses made by Fender®, for example the Jazz Bass®, Precision Bass® or the MusicMan® and is basically a round rod approximately $\frac{3}{16}$ " in diameter.

It is connected to the neck on one side and is threaded with a head on the other side. This long, threaded screw can be tightened at the head of the truss-rod and is usually slightly bent inside the channel (**Fig. 6**).

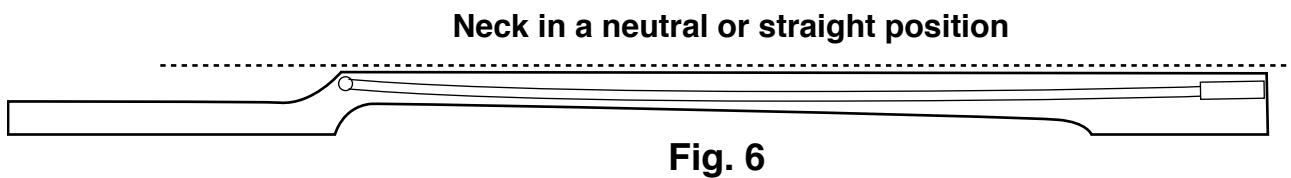

When we loosen the truss-rod, the tension of the strings (red arrow) increases as the tension of the truss-rod (green arrow) gives way, causing the neck to begin bending forward (**Fig. 7**), resulting in a depression in the middle.

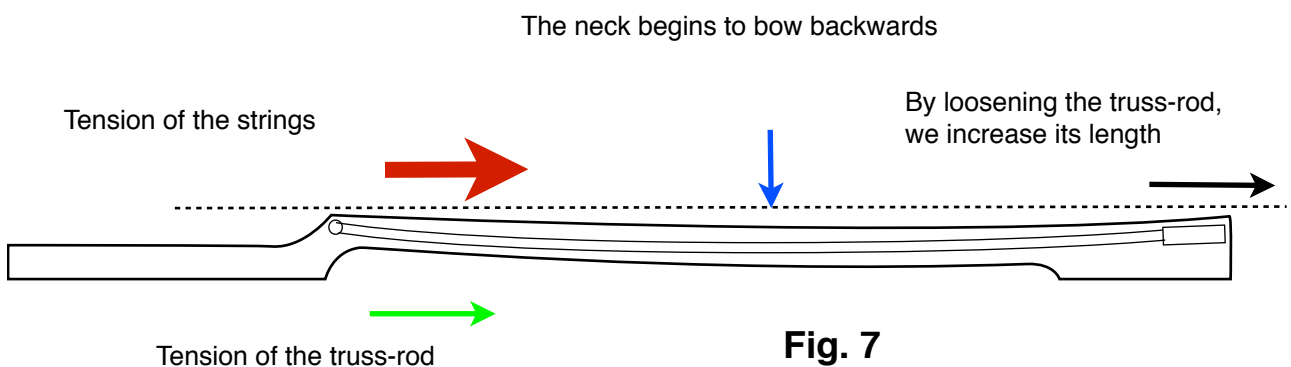

When we tighten the truss-rod, the tension of the strings (red arrow) is no longer sufficient to compensate for the tension of the truss-rod (green arrow), causing the neck to bend backwards (**Fig. 8**) and rise in the middle.

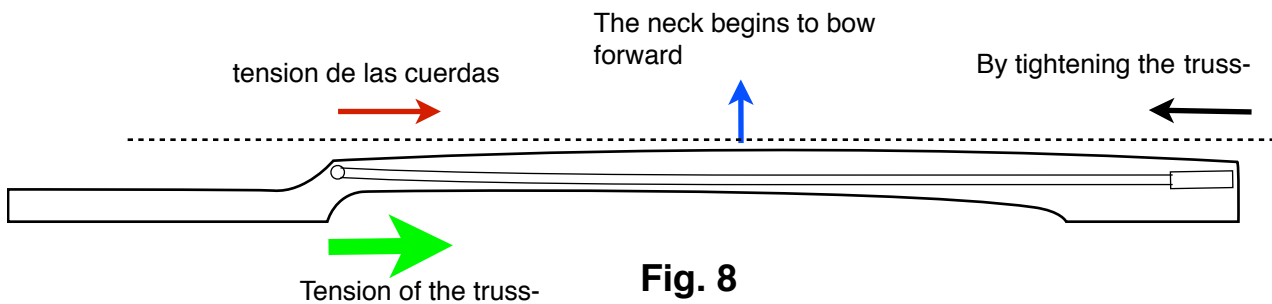

Now, you will probably ask, "What good does this do? Isn't it good enough to have a completely straight neck that is strong enough to resist bending no matter which gauge of strings I'm using?"

Well, here's the point. An optimally adjusted neck shouldn't be straight.

You will discover that the truss-rod doesn't just compensate for the tension of the strings, but rather it does so in a very precise way, depending on their gauge.

Logic would tell us that once the neck is balanced, it should be completely straight, but in reality, it doesn't work that way. In **Fig. 9**, you can see what happens: when a string vibrates, that vibration reaches its maximum width right in the middle of the string at ① and a straight neck doesn't leave it enough room, so it begins to hit the neck more or less at ②

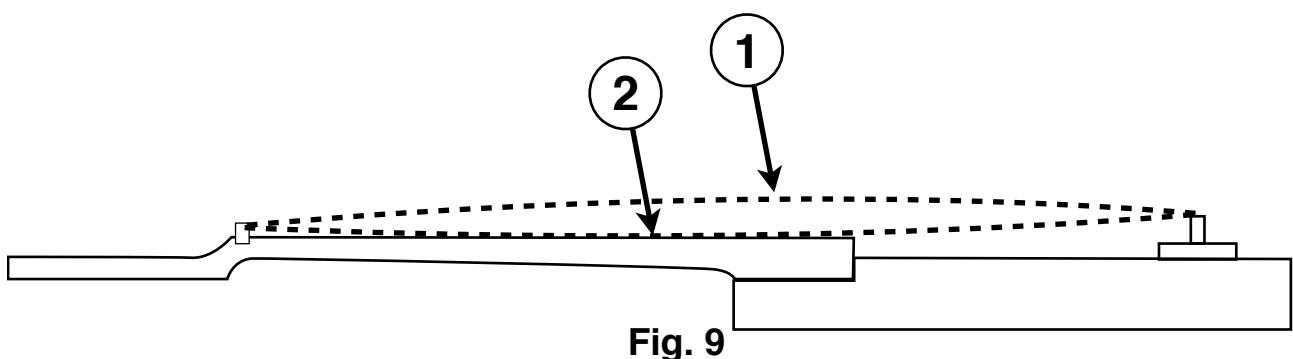

This unwanted effect is commonly called "buzzing" and in order to avoid it, we have to raise the strings at the bridge, ③ in **Fig. 10**.

After raising the strings, the instrument won't buzz ①, but you will find that it isn't very comfortable to play, especially in the higher positions ②. To prevent this problem, you must slightly arch (**Fig. 11**) the neck ④ in such a way so that it accommodates the natural shape of the strings as they vibrate. By doing this, we make sure that the bass doesn't buzz, so we can then lower the strings at the bridge ③, achieving a more consistent string height over the neck ① ②, which will give us much more playing comfort all along its length as opposed to the awkwardness we feel when the neck is completely straight.

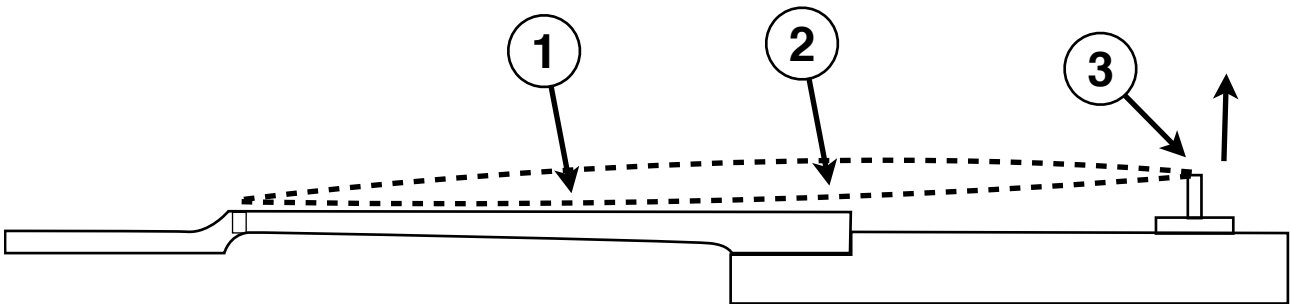

Fig. 10

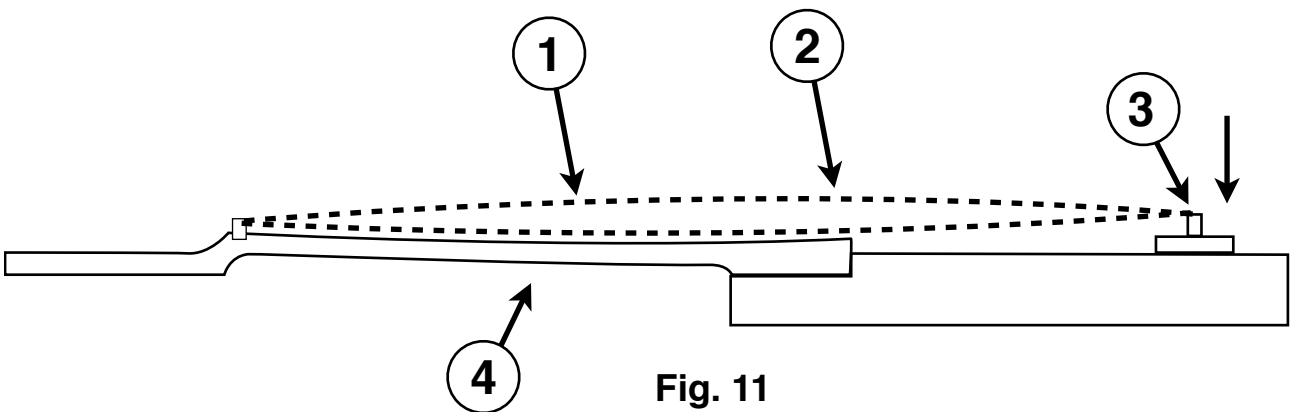

Fig. 11

Now, you are probably wondering, "How much should the neck arch and how do I measure it?"

And here we come to the big secret in this unique **The Ultimate Guide to The Perfect Bass Setup ! :-))))**

How to Measure the Arc

You should always correctly tune the instrument before proceeding. To measure the current arc of your instrument, you should sit in a comfortable position and support it on your knee just as if you were going to play it.

Depress the string at the first fret with the index finger of your left hand until it makes contact (**Fig. 11a**) and then do the same thing with your right index finger at the last fret on the neck (**Fig. 11b**).

Now, observe the string over the 7th through the 9th frets or thereabouts. If the string is touching all of them, this means that the neck is straight or may even be bent backwards, as in **Fig. 8**.

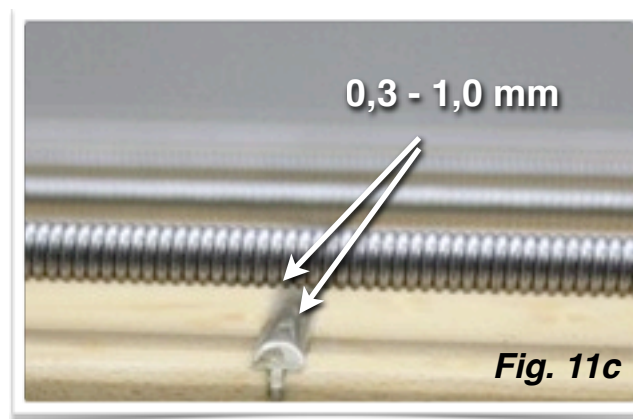
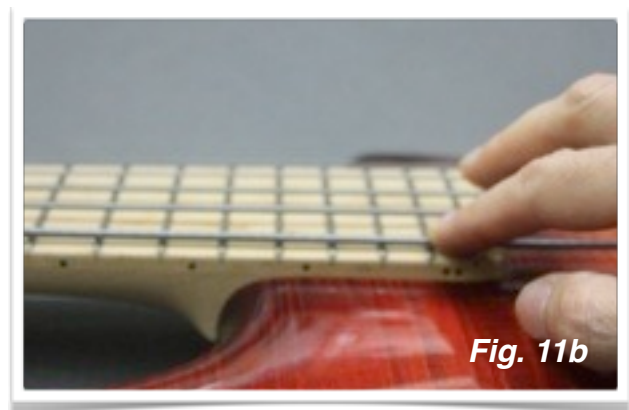

If the string doesn't touch the 7th through the 9th frets and there is some distance between the two, this means that there is an arc. Now, all we have to do is measure this distance to find out if it is correct.



To measure the arc, you will need another person to help you or else you will need a capo (*Fig. 12*) so that you can hold the strings down at the first fret. You will also need a set of gauges, as I mentioned in the Tools section of **Chapter 1**. If you don't have a capo, you



can improvise using a pencil and a rubber band (*Fig. 13*).

Place the capo at the first fret so that the strings are touching it. While you are sitting and holding your instrument as if you were going to play it, hold the string down at the last fret with your right index finger and use a gauge to measure the distance between the string and the 7th through the 9th frets. This distance should normally be between .3mm and 1mm, depending on your instrument and playing style. This is not an exact science, but rather an Art and you will have to experiment a little in order to find the optimal distance that works for you.

If you don't care so much about having high strings, then this distance can be very slight, approximately .3mm. If you prefer rather low strings, this distance should be a little greater. However, it isn't recommended to have a distance greater than 1mm because in spite of the fact that the bass won't buzz on the first frets, it will start to buzz on the last ones. On the other hand, if the neck buzzes on the first frets, then we should increase the

distance between the fret and the underside of the string. As a matter of fact, this is the indicator we will use to carry out the whole adjustment process.

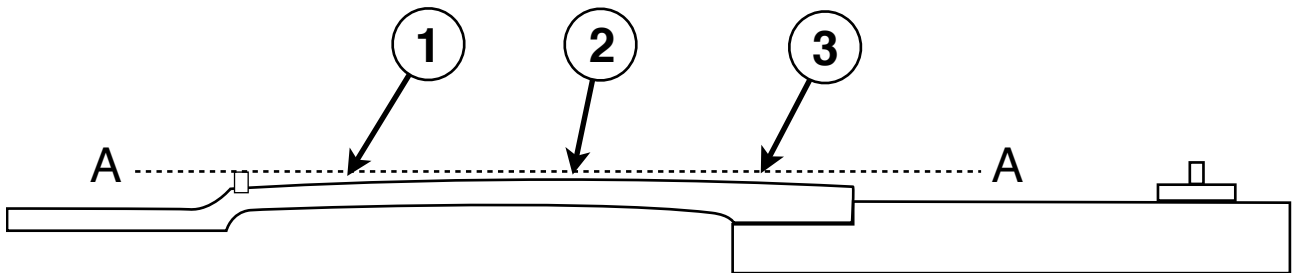

Fig. 14

In **Fig. 14** you can see that the bass buzzes at the first frets ① and stops buzzing more or less at the middle of the neck ② and doesn't buzz at all at the last frets ③, which is a sign that you need to loosen the truss-rod because the neck isn't arched or it is bowed back, as you can see in relation to the straight line A-A.

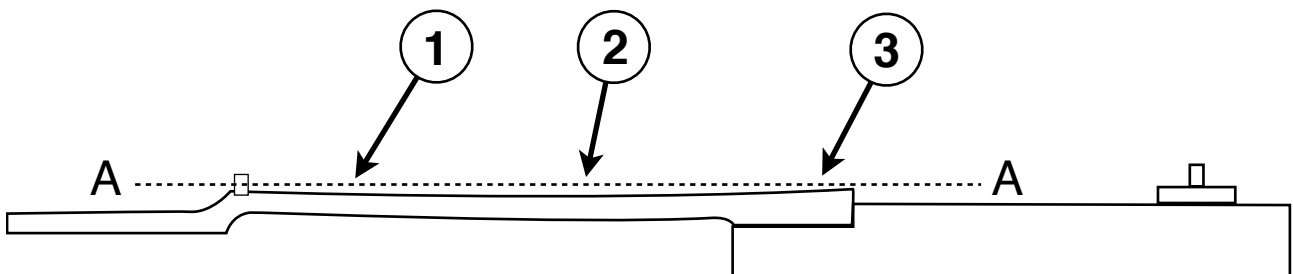

Fig. 15

In **Fig. 15** the instrument is arched in the correct direction but too much so. The instrument doesn't buzz at the first frets or in the middle, but it will buzz at the last frets, which is a sign that the neck should be straightened by tightening the truss-rod. In the case of most common truss-rods, you will need to tighten the head a quarter-turn clockwise.

So, now you know the basic mechanics of how the truss-rod works and the procedures for adjusting it. Next we are going to adjust the neck step by step.

The Neck Adjustment Process

1. As a general rule, the bass should be tuned using standard tuning or whatever tuning you normally use. Tune it now if you haven't already.
2. Determine the arc of the neck, as described in the previous section.
3. The neck should have a slight arc and the distance between the 7th through the 9th frets and the underside of the strings should be between .3mm and 1mm.
4. If the arc is greater than this, you need to tighten the truss-rod a quarter-turn clockwise and if the arc is less than this, you should loosen the truss-rod a quarter-turn counterclockwise.
5. **Remember that most truss-rods work this way; however, in some cases to tighten them, you have to turn them counterclockwise and to loosen them, you have to turn them clockwise. Please read the instructions that came with your instrument very carefully.**
6. Tune the instrument again to compensate for the changes you have made to the neck tension.
7. Test the arc again and if it still isn't within .3mm to 1mm, you will have to repeat the process as many times as necessary starting from step 4.
8. **Remember that you should NEVER tighten or loosen the truss-rod by more than a quarter-turn at a time. You can even turn it as little as an eighth of a turn if you only need to make a small adjustment.**
9. Once the arc has been adjusted, check the tuning again and try playing the instrument in all positions to make sure that it doesn't buzz.
10. If it doesn't, you may even be able to lower the strings a bit on the bridge. A half-turn of the saddle pins should do the trick.
11. Pay attention to where the instrument buzzes. If it does it at the first frets (**Fig. 14**), you should loosen the truss-rod a quarter-turn. If it does it at the last frets (**Fig. 15**), then you should tighten the truss-rod a quarter-turn.

12. The optimum point is between the place where the bass stops buzzing at the first frets and the place where it stops buzzing at the last ones.
13. If you can't make it stop buzzing, this means that the strings are too low and you will need to raise them at the bridge by giving each of the saddle pins a half-turn, as described in the section **Adjusting the Height of the Strings** [here](#). You should readjust the height of the outer strings first and then adjust the height of the others using the correct curvature template (**Fig. 4**).
14. You will have to repeat this process of raising the strings on the bridge as many times as necessary until the bass doesn't buzz at any point along the neck.
15. If the neck buzzes randomly at certain frets, this means that the frets have worn out or have started to lift up and you will have to turn to a professional luthier to level them.

Bridge – Setting the Intonation

You should know that the distance from the nut to the bridge, which is also called the "scale length" of the instrument, is the distance between the nut and the 12th fret multiplied by two (**Fig. 16**).

As a general rule, the scale length is expressed in inches and the most common one is 34", although this is only in theory because in practice, each of the strings has to be adjusted slightly in order for the bass to have perfect intonation.

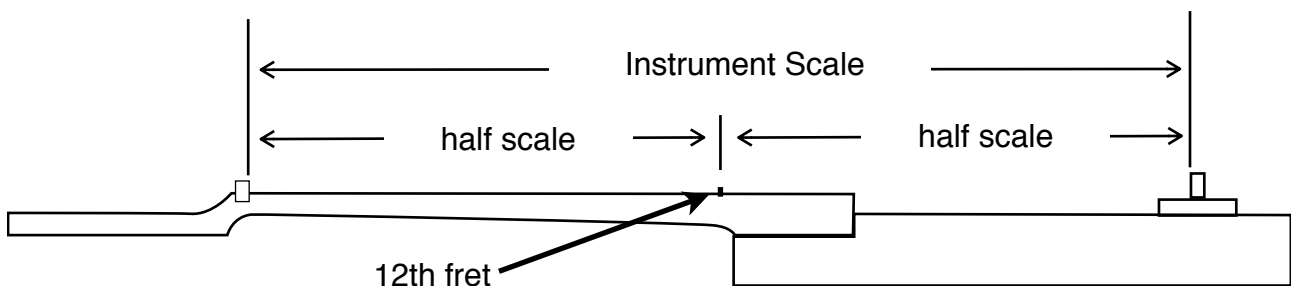

Fig. 16

The 12th fret is located right in the middle of the scale length (neck) of the instrument

Setting the intonation is the process of correcting the length of the strings so that the bass is perfectly in tune at every position (fret).

Due to the different thicknesses of the strings, the elasticity of each one changes, which means that the strings with less elasticity won't be perfectly in tune in all positions because this loss of elasticity causes the effective length of the strings (the part that vibrates) to be shorter than the distance between the nut and the bridge.

The thicker a string is, the more elasticity it loses and we have to compensate more and more by moving the saddle of the bridge further from the theoretical "scale length" of the instrument, which you will observe in an instrument that has been adjusted correctly.

You will see that the saddles have a repeating adjustment pattern: the thicker the string is, the longer it has to be in order to compensate for this elasticity problem (**Fig. 16**).

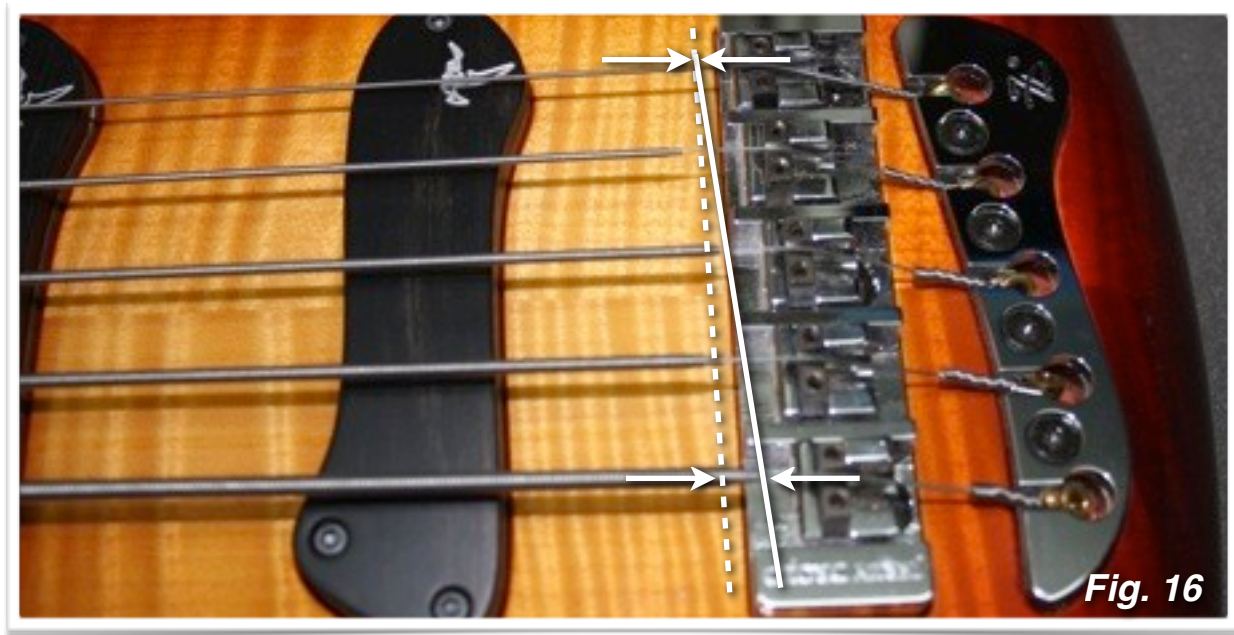

The Intonation Setting Process

The procedure is very simple. To compensate for the elasticity problem, we have to move the saddle of the bridge until the harmonic of the 12th fret coincides with the pitch of the 12th fret. In this way, we will synchronize the distances of the frets with the actual pitches of the string.

1. Check the tuning again and begin setting the intonation starting with the thinnest string.
2. Place the tip of your left index finger on the 12th fret, touching the string lightly without pressing it all the way down (as if you were trying to stop the string from vibrating) and strum the string with one of the fingers of your right hand to produce the harmonic of the 12th fret.
3. While the harmonic is still sounding, tune the string to its correct pitch. For example, if it's the G string, tune it to G.

4. Now, play the pitch of the 12th fret (not the harmonic) by pressing the string all the way against the fret.
5. If the note is higher (**Fig. 17**), you need to move the saddle away from the pickups toward the outside of the body.
6. If the note is lower (**Fig. 18**), you need to move the saddle closer to the pickups.
7. The more difference there is between the harmonic of the string and the correct pitch, the more we have to move the saddle to compensate for this difference.
8. You should repeat this process as many times as necessary until the pitch at the 12th fret coincides with its harmonic. In this case, the tuner should indicate the correct pitch in the middle (**Fig. 19**).
9. Repeat this same process with each string.

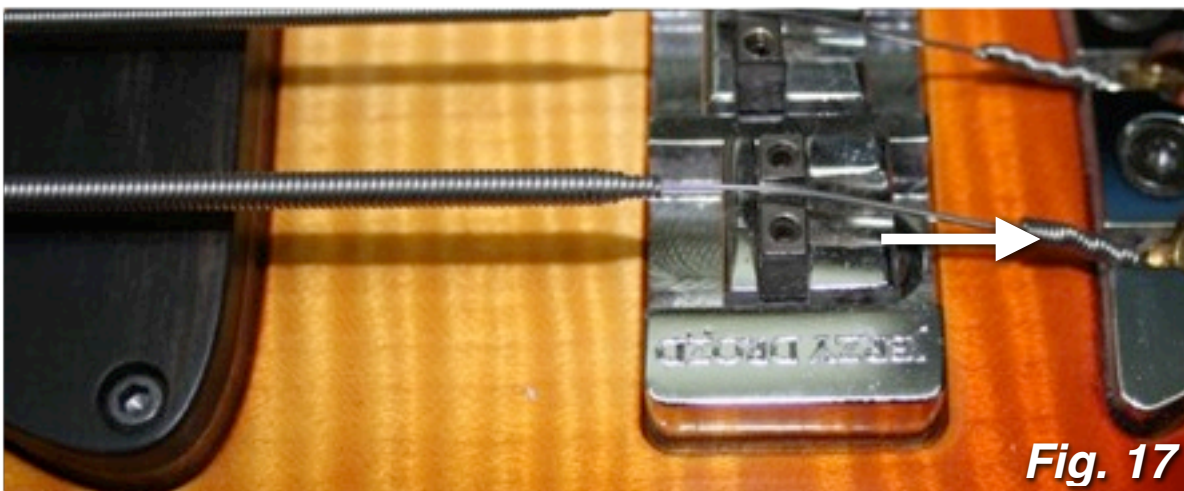
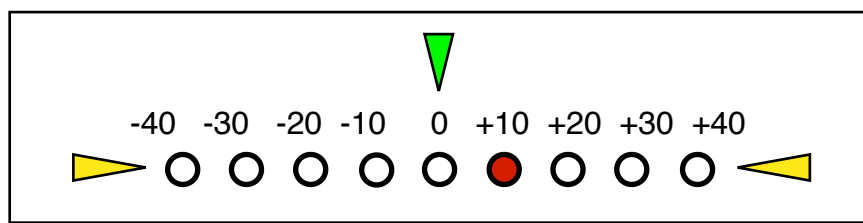
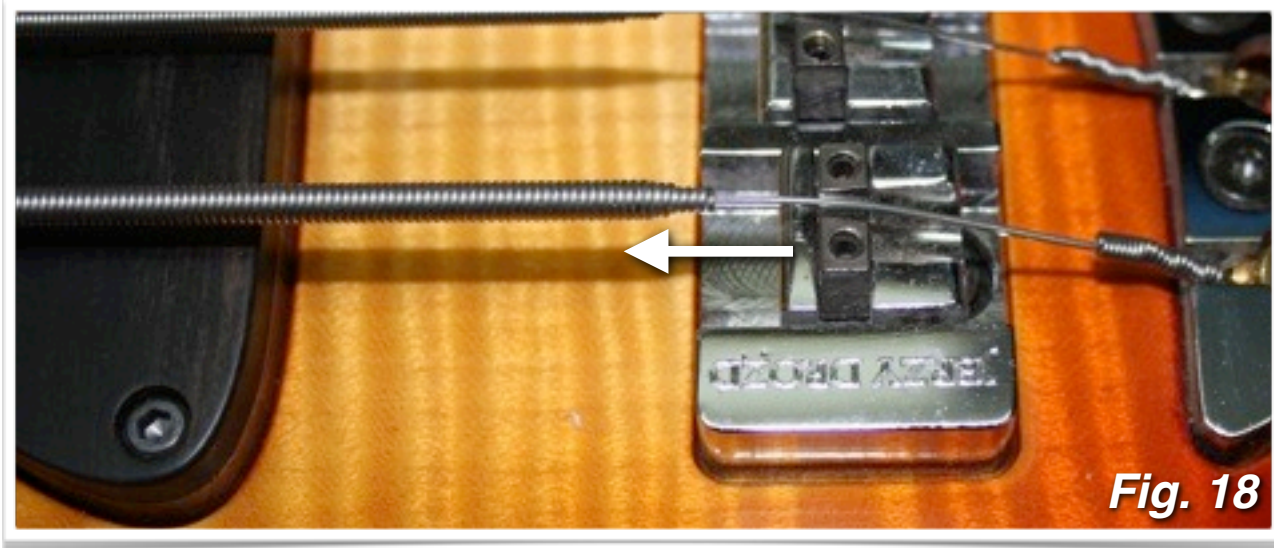
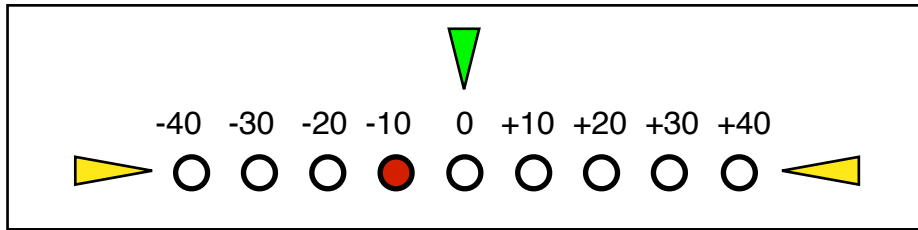

Fig. 17

The higher the pitch at the 12th fret in relation to the harmonic, the more you will have to move the saddle outward and away from the pickups to lengthen the string. Move the saddle away from the pickups if the note is higher than the harmonic.



The lower the pitch at the 12th fret in relation to the harmonic, the more you will have to move the saddle toward the pickups to shorten the string. Move the saddle toward the pickups if the note is lower than the harmonic.

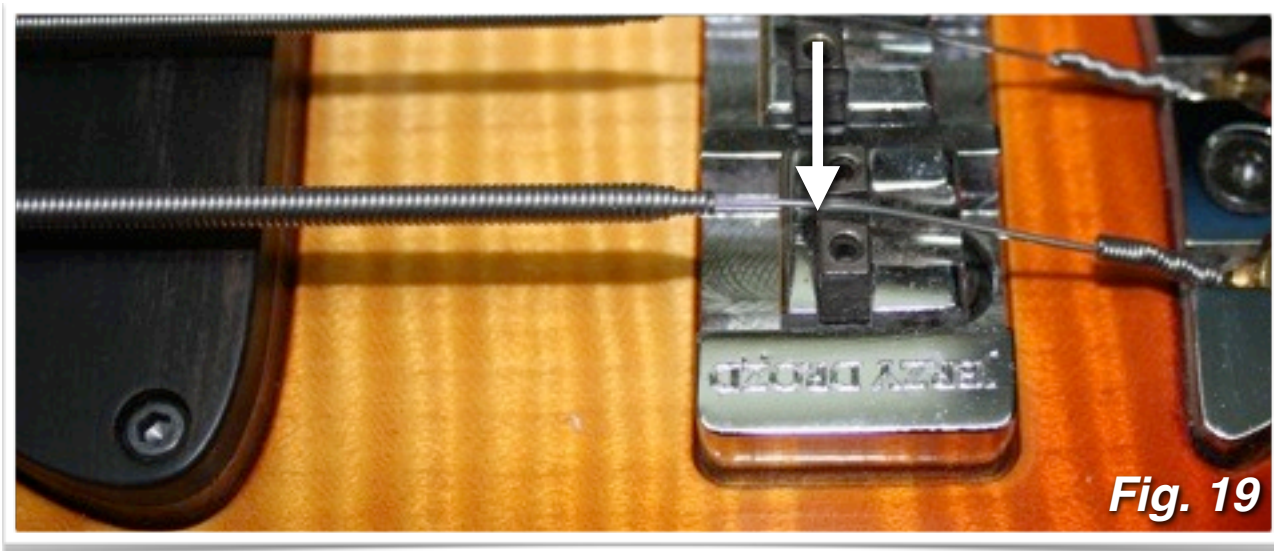
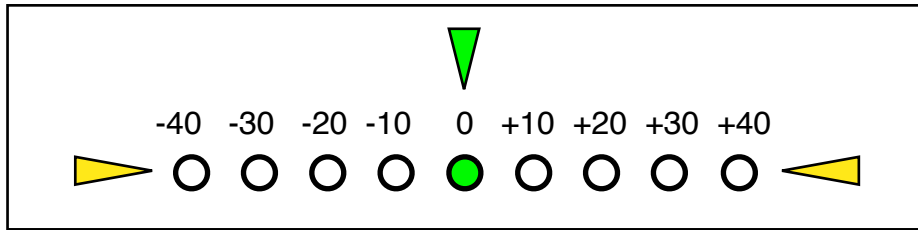

Fig. 19

When the pitch and the harmonic at the 12th fret coincide, this means that you have correctly set the intonation of the string. Leave the saddle where it is when the note and the harmonic are the same.

Adjusting the Height and Angle of the Pickups

A very important point that we often overlook is the adjustment of the height of the pickups.

Basically, adjusting the height of the pickups is necessary to accommodate the different volumes that are produced depending on their position. The pickup closest to the fingerboard and furthest from the bridge produces a higher volume than the pickup closest to the bridge. This is because of the change in the width of the string's vibration (**Fig. 20**).

This adjustment also helps accommodate the differences in volume between the thinner and thicker strings (**Fig. 22**) and lastly, it helps prevent the pickups from grating against any strings that are too close to them.

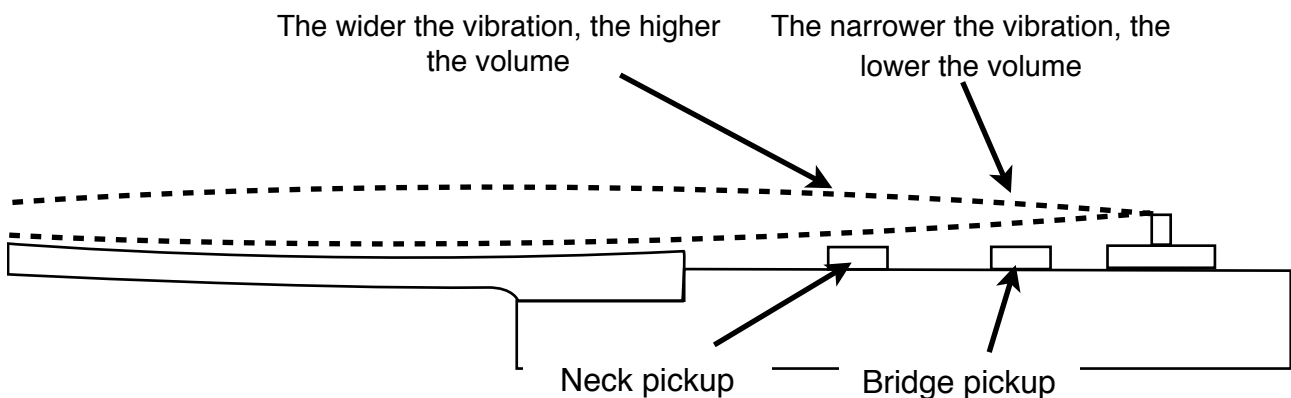

Fig. 20

The Adjustment Process

1. Place the instrument on a flat surface.
2. Press the lowest string against the last fret with your left index finger (**Fig. 21**).
3. Using the gauges, adjust the distance between the string and the surface of the higher pickup to somewhere between 1.5mm and 2.5mm and for the lower pickup, between 2mm and 3mm.
4. Repeat the same process with the highest string.

5. You might have to decrease this distance for the highest strings in order to balance the volume between the strings (**Fig. 22**).



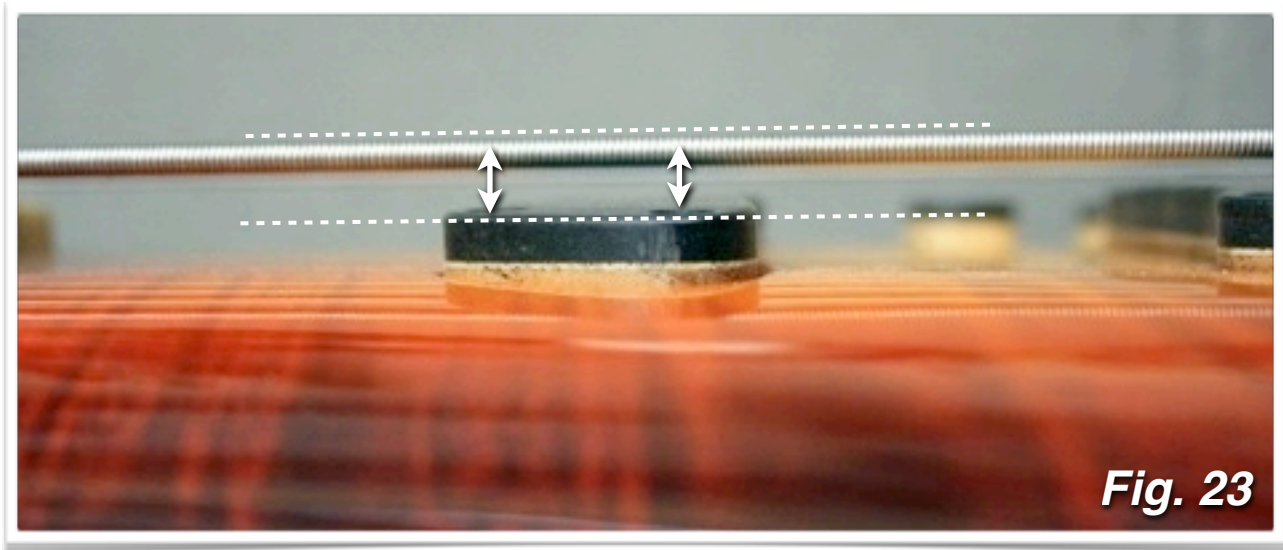

Lastly, if the pickups of your bass have more than 2 mounting screws, like those of the MusicMan® bass, which have 3 or the JazzBass®, which have 4, you will need to adjust the surface of the pickup so that it is parallel to the central axis of the string (**Fig. 23**).

The Adjustment Schedule

Routine adjustment of the instrument, which includes adjusting the truss-rod, the bridge and the height of the pickups, that is, everything we have discussed so far, should be done every 6 to 12 months. The reason why this period can vary so widely is because some instruments fall out of adjustment much more quickly than others due to the design of the bridge and the structure of the neck.

Check the status of your instrument every 6 months. If you find that the adjustment has hardly changed and the neck is still stable, then you can wait 12 months between routine adjustments.

Chapter 3

Instruments with a Double Truss-Rod

Instruments with a Double Truss-Rod

Instruments with two truss-rods are not at all rare these days. There are several manufacturers that use this type of system, especially in the ERB-type basses, which require a somewhat independent adjustment at the two extremes of their unusually wide fingerboards.

There are some manufacturers that use this system in conventional basses and have done so for many years, as is the case with Rickenbacker basses, the old Tobias basses or the Alembic basses.

Basically, there are two kinds of double truss-rod systems used in basses:

1. Parallel truss-rods that are joined together inside the middle of the neck
2. Diagonal and parallel truss-rods at each edge of the fingerboard

Parallel Truss-Rod System (A+A)

This system differs very little from the conventional single truss-rod system. The two truss-rods must have the same tension and that's about all there is to it. If you have a bass with this system, study the previous chapter on adjusting a bass with a single truss-rod again and follow the instructions just the same, the

Tip #5

In basses with two parallel truss-rods, whenever possible, use a torque wrench. This is a type of hand tool that is used to tighten screws that require very precise adjustments due to their function. This will allow you to apply the same tension consistently to the two truss-rods in this kind of system.

Wikipedia Source:

http://en.wikipedia.org/wiki/Torque_wrench

only difference being that you will need to make sure that both truss-rods are set at the same tension, which requires a little more experience and a lot of caution.

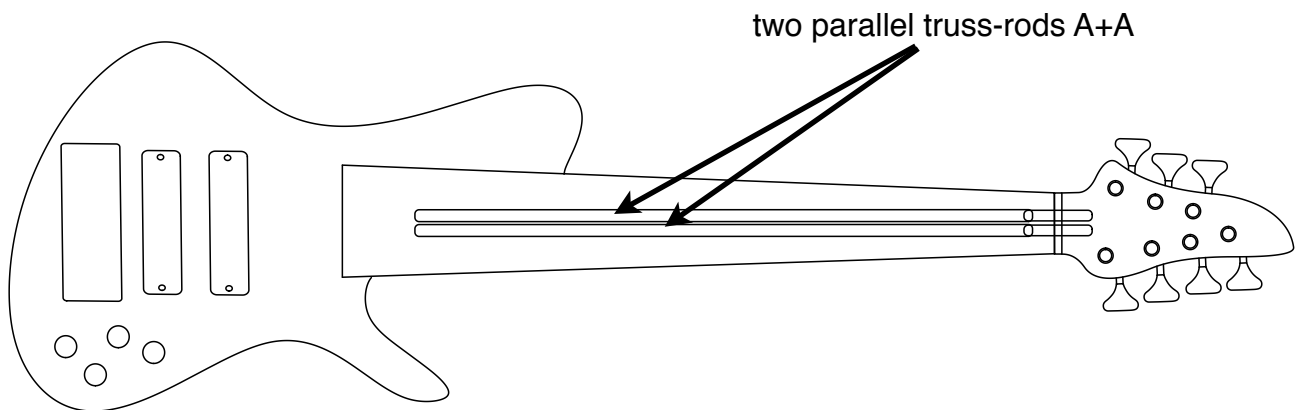

Diagram of an instrument with a parallel truss-rod system A+A

The premise is always the same: it's better to under-tighten than to over-tighten. To make adjusting this kind of instrument easier and to prevent damaging it, I suggest that you use a torque wrench (see Tip #5) whenever possible.

Diagonal Double Truss-Rod System (A+B)

The situation starts to get complicated and confusing when there is a diagonal truss-rod system.

In this case, the adjustment doesn't seem quite as simple as it is with the parallel truss-rods that are side by side. In reality, and this is the paradox, the diagonal double truss-rod system is much easier to adjust than the parallel double truss-rod system! Strange, isn't it?

First, let me explain the reason for this kind of system and the idea behind it. This will help you understand how it works and afterwards, the adjustment will seem easy – no more complicated than adjusting a neck with a single truss-rod.

The Philosophy of the System

The idea behind this system is very simple. You already know from the previous chapter that the neck needs to have a slight arc so that the strings are kept at an optimum height over the fingerboard.

This arc isn't the same for all of the strings because it varies slightly according to their thickness. This is due to the width of the string's vibration.

The strings of the highest gauge have a wider vibration than the thinner strings, so these thicker strings require a more pronounced arc while the thinner ones require a less pronounced arc.

When we're talking about basses with 4, 5 or even 6 strings, this difference in arc isn't very big and a truss-rod located along the central axis of the neck is sufficient. Things get more complicated in multi-string instruments of the ERB (Extended Range Bass) type.

These basses with 7, 8, 9 or up to 12 strings have extremely wide fingerboards and the gauge of the strings varies widely, which makes it necessary to apply a different arc at each edge of the fingerboard, which is made possible by the diagonal truss-rod system.

You should also know that once the strings are tuned to the correct pitch, they have different tensions. But we already know this, right?

However, what most people don't know is that the strings with the greatest tension are the thin ones and not the thick ones, as logic might suggest.

This puts more stress on the neck from the high strings and less stress from the low ones. Going back to the arc, if we have to apply less curvature on the side where the high strings are located and more on the side where the low strings are located, we will notice that the truss-rod that has to withstand the most stress is truss-rod "A."

So, now that we know this, how should we adjust the neck with a diagonal double truss-rod (A+B)?

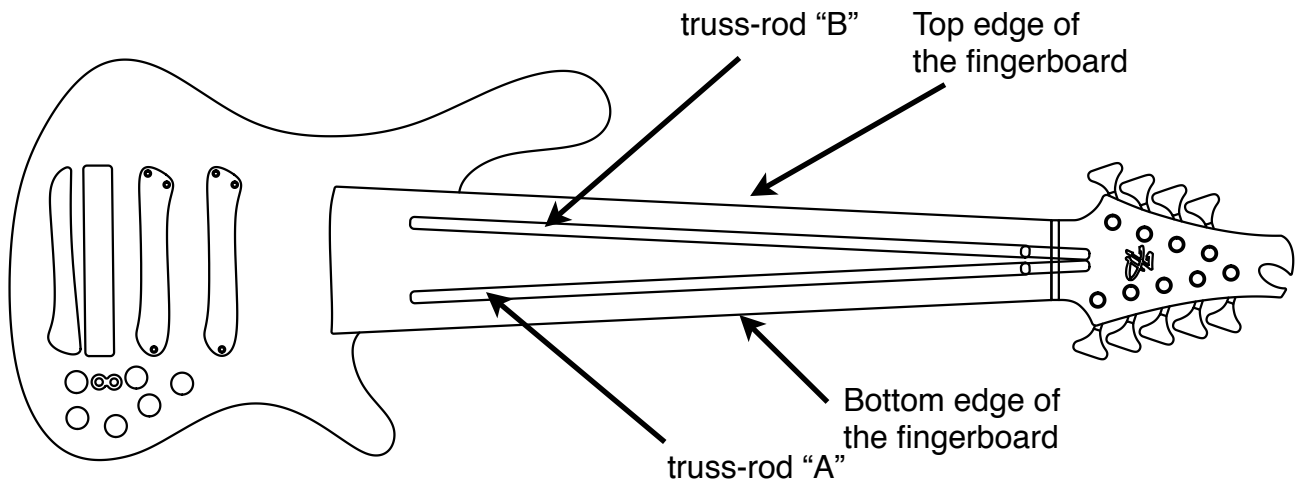

Diagram of an instrument with a diagonal truss-rod system A+B

It's Really Very Simple!

Treat it as if it were a bass with a single truss-rod, adjusting only truss-rod "A". Truss-rod "B" will only be used, then, to compensate in case the arc of the top edge is too pronounced or curved.

Here's the Complete Procedure:

- 1) Loosen truss-rod "B" completely so that there's no tension at all.
- 2) Tune the instrument again to compensate for the reduced neck tension.
- 3) Check the arc of the neck at the lower edge of the highest string, just as we did in the previous chapter.
- 4) If the neck is too bowed, tighten truss-rod "A" by a quarter-turn.
- 5) If the neck isn't bowed enough, loosen truss-rod "A" by a quarter-turn.
- 6) Tune the instrument again to compensate for the change in neck tension.
- 7) Repeat the process starting at step 3 until the lower edge has the correct arc.

- 8) Tighten truss-rod "B," if necessary, so that the top edge has the correct arc. In most cases, this won't be necessary and you will only have to tighten it minimally so that the head of the truss-rod isn't completely loose.
- 9) If it is necessary to decrease the arc of the top edge of the fingerboard, you will have to tighten truss-rod "B" by an eighth of a turn.
- 10) Tune the instrument again to compensate for the increased neck tension.
- 11) Check the resulting arc again after having tightened truss-rod "B" and if it still isn't right, repeat the process starting at step 8 until it is.
- 12) If you have had to tighten truss-rod "B" a bit, once you have done this, check the arc at the bottom edge of the fingerboard again and if necessary, tighten or loosen truss-rod "A" to compensate.



Appendix A

Standard Tuning Table

	4 string Bass	5 string Bass	6 string Bass
B		✓	✓
E	✓	✓	✓
A	✓	✓	✓
D	✓	✓	✓
G	✓	✓	✓
C			✓

Tuning Table for ERB Basses

String	7 string Bass	8 string Bass	9 string Bass	String	10 string Bass	11 string Bass	12 string Bass
Standard ERB Tuning Style				Yves Carbonne Tuning Style			
C			(✓)	B*		✓	✓
F#		(✓)	✓	E*	✓	✓	✓
B	✓	✓	✓	A*	✓	✓	✓
E	✓	✓	✓	D*	✓	✓	✓
A	✓	✓	✓	G*	✓	✓	✓
D	✓	✓	✓	C*	✓	✓	✓
G	✓	✓	✓	F*	✓	✓	✓
C	✓	✓	✓	Bb	✓	✓	✓
F#	✓	✓	✓	Eb	✓	✓	✓
		(✓)	✓	Ab	✓	✓	✓
			(✓)	Db	✓	✓	✓
				Gb			✓

*Strings tuned one octave below standard tuning

Cut-Out Templates for Curvature Adjustment Standard Formats A and B

To conserve the exact measurements of these templates, you should print this page on A4 paper. The 100mm and 200mm distances that are indicated should be used as a legend to set your printer so that the template measurements remain faithful when printed.

Once they are printed out, glue them onto a piece of rigid plastic (methacrylate or polystyrene) about 2mm – 3mm thick, cut them out with hair clippers or a small handsaw and use 120-180 grade sandpaper to smooth any rough edges so that the templates are precise.

Cut-Out Templates Standard Format

"A" type

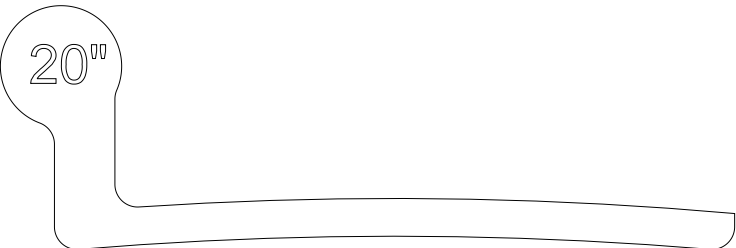
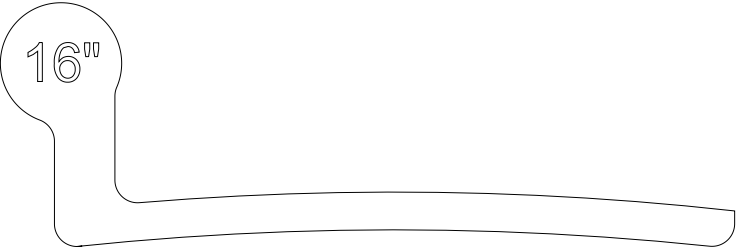
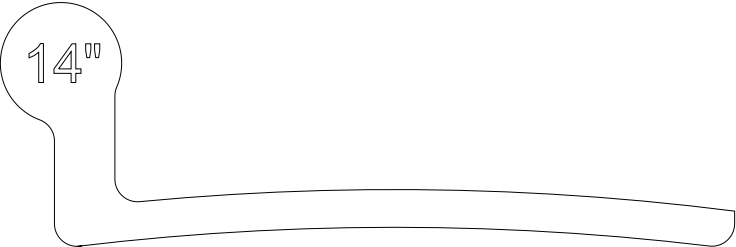
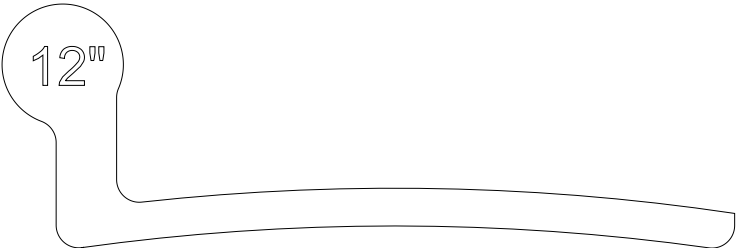
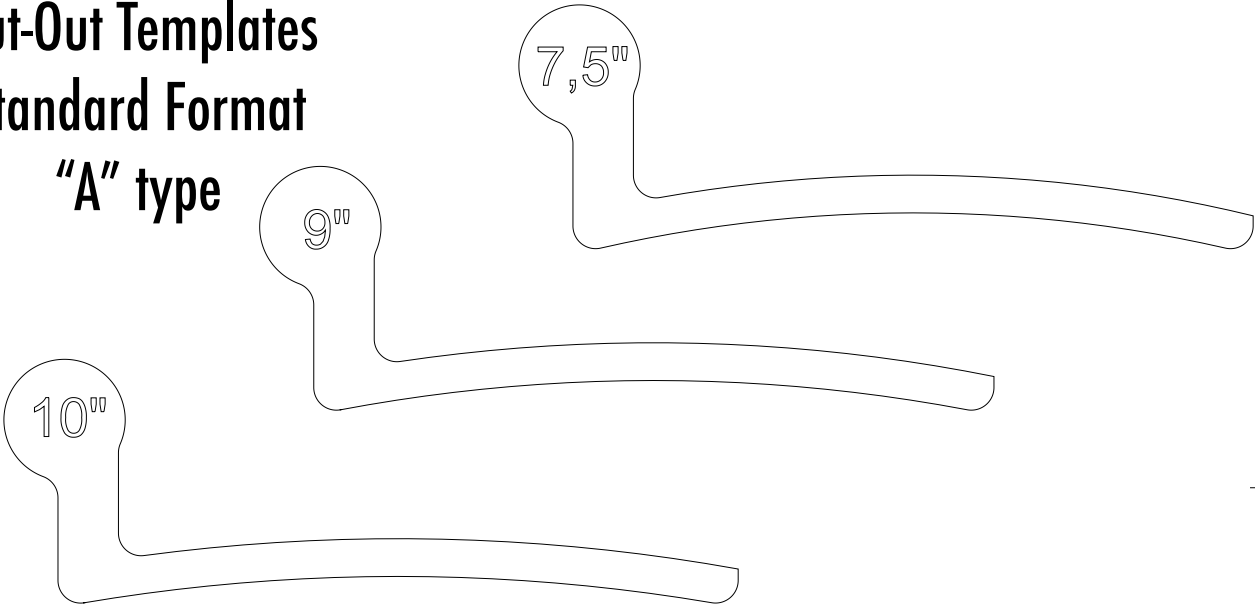

distancia
200mm

distancia
100mm

distancia
100mm

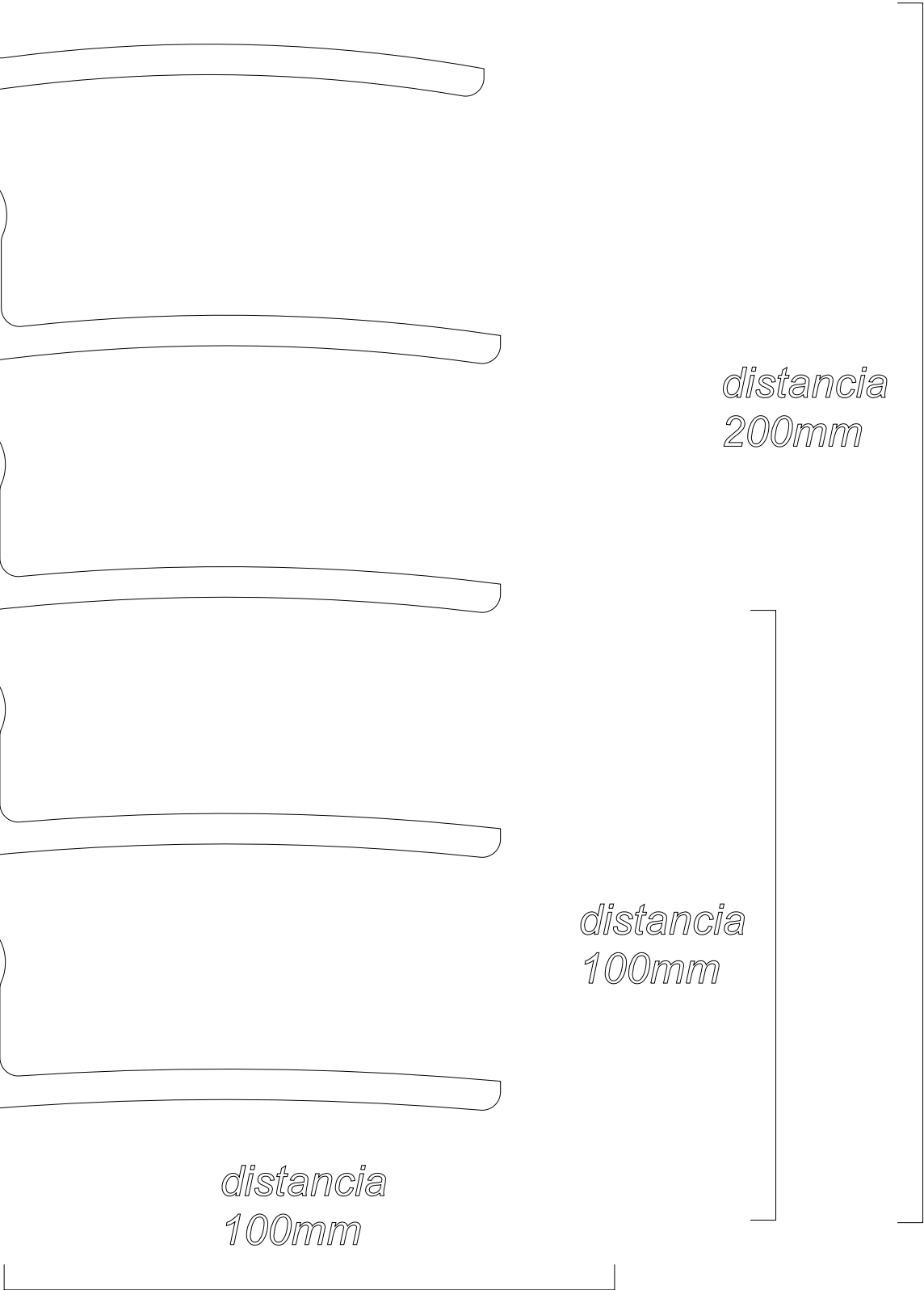

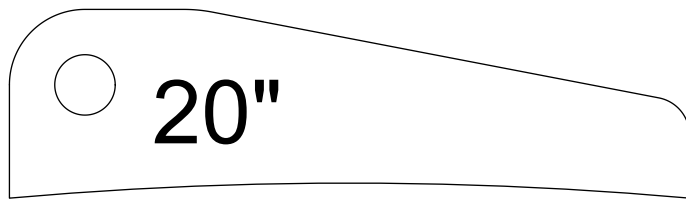
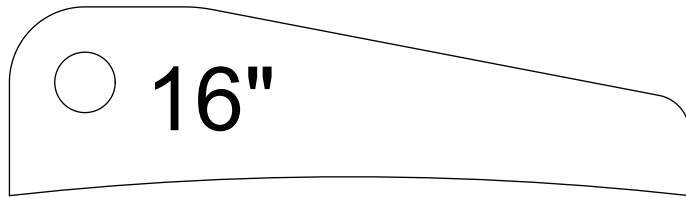
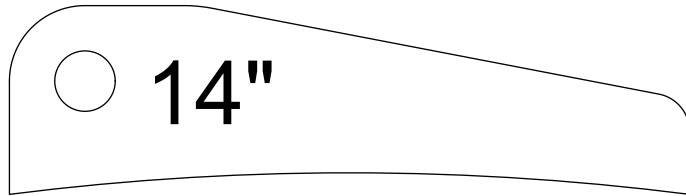
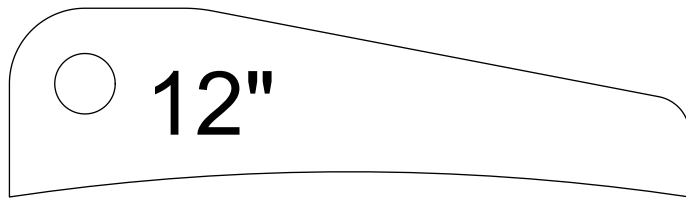
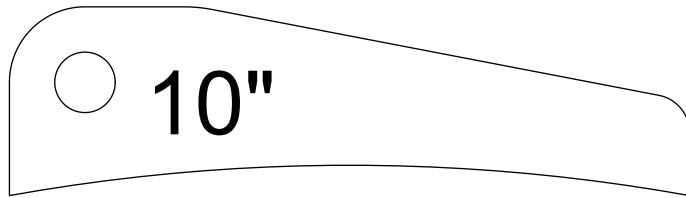
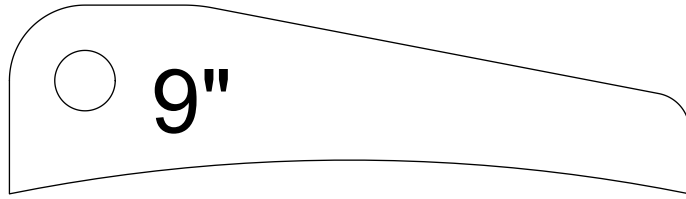
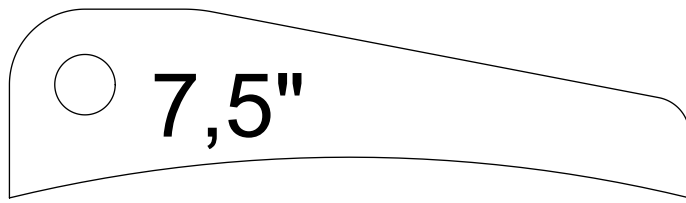

Cut-Out Templates Standard Format "B" type

*distancia
200mm*

*distancia
100mm*

*distancia
100mm*

Cut-Out Templates for Curvature Adjustment ERB Formats A and B

To conserve the exact measurements of these templates, you should print this page on A4 paper. The 100mm and 200mm distances that are indicated should be used as a legend to set your printer so that the template measurements remain faithful when printed.

Once they are printed out, glue them onto a piece of rigid plastic (methacrylate or polystyrene) about 2mm – 3mm thick, cut them out with hair clippers or a small handsaw and use 120-180 grade sandpaper to smooth any rough edges so that the templates are precise.

Cut-Out Templates ERB Format "A" type

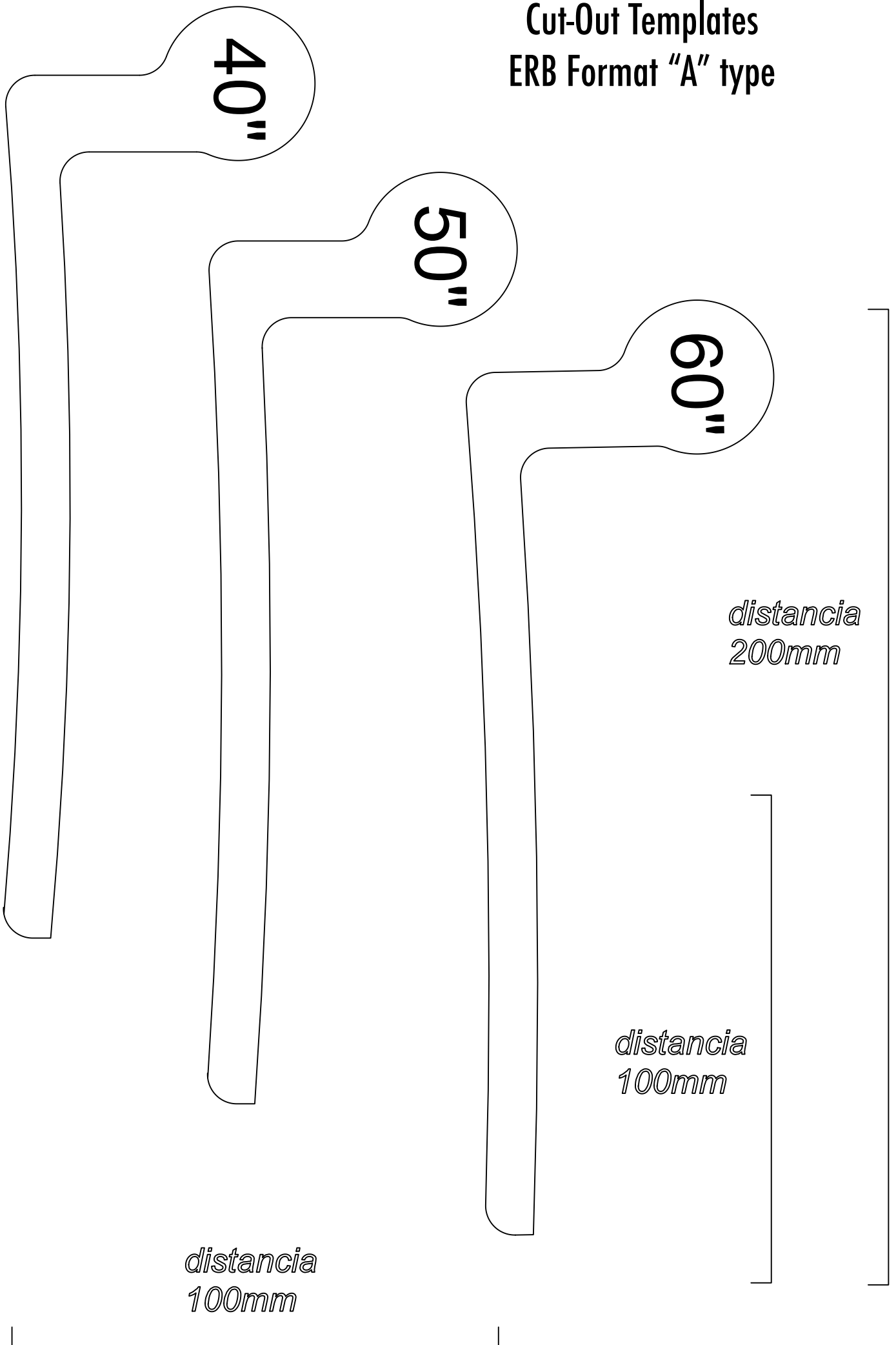

Cut-Out Templates ERB Format "A" type

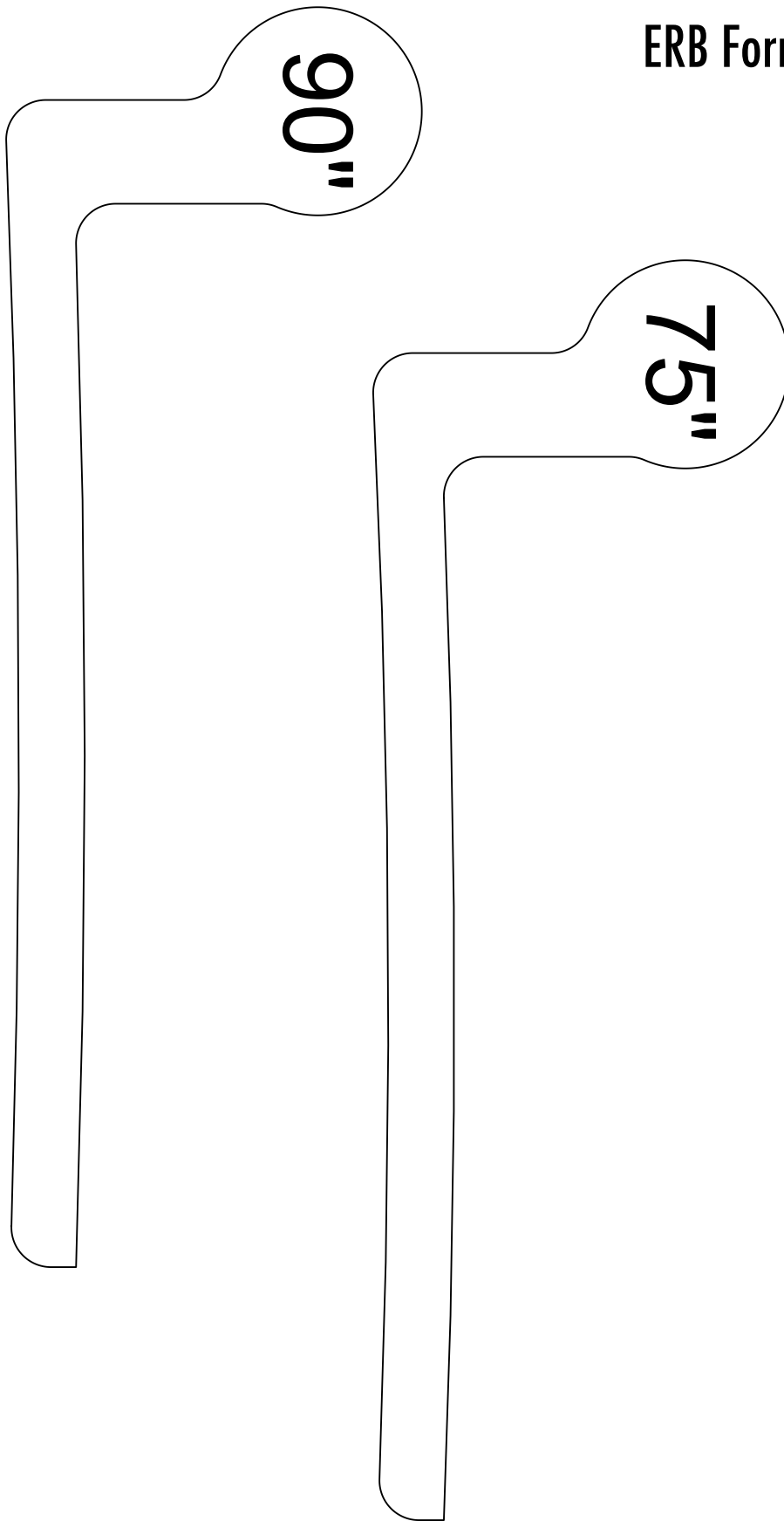

distancia
200mm

distancia
100mm

distancia
100mm

Cut-Out Templates ERB Format "B" type

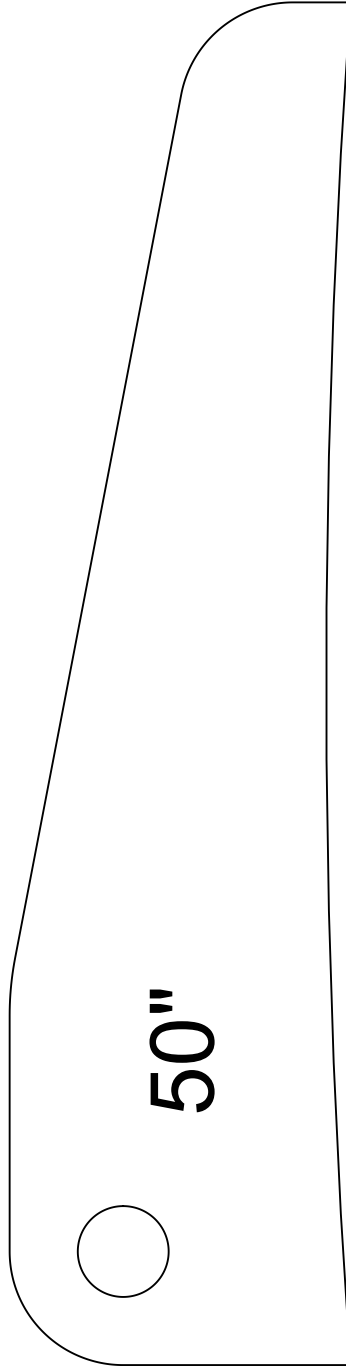
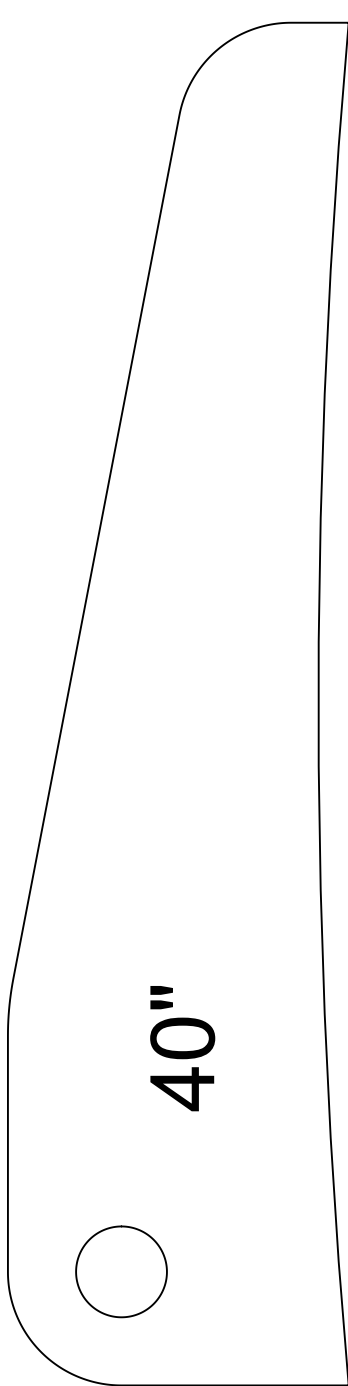
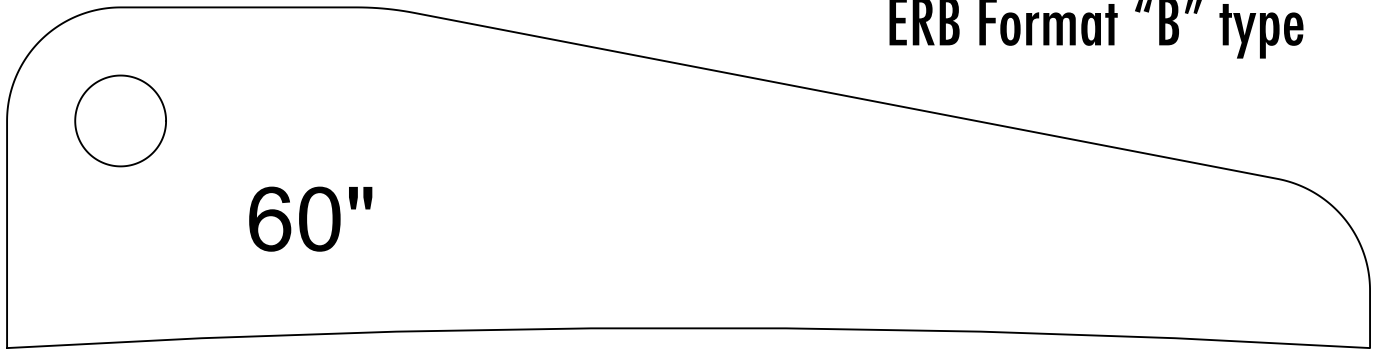

distancia
200mm

distancia
100mm

distancia
100mm

Cut-Out Templates ERB Format "B" type

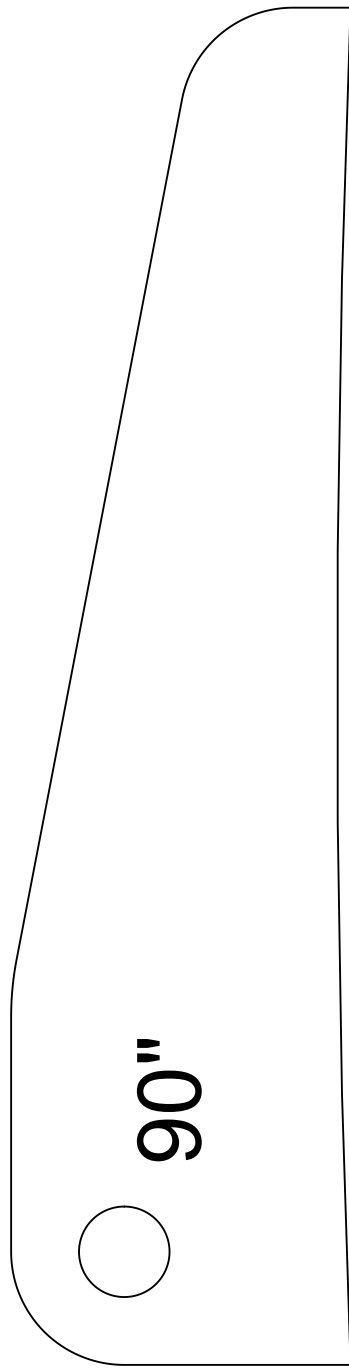
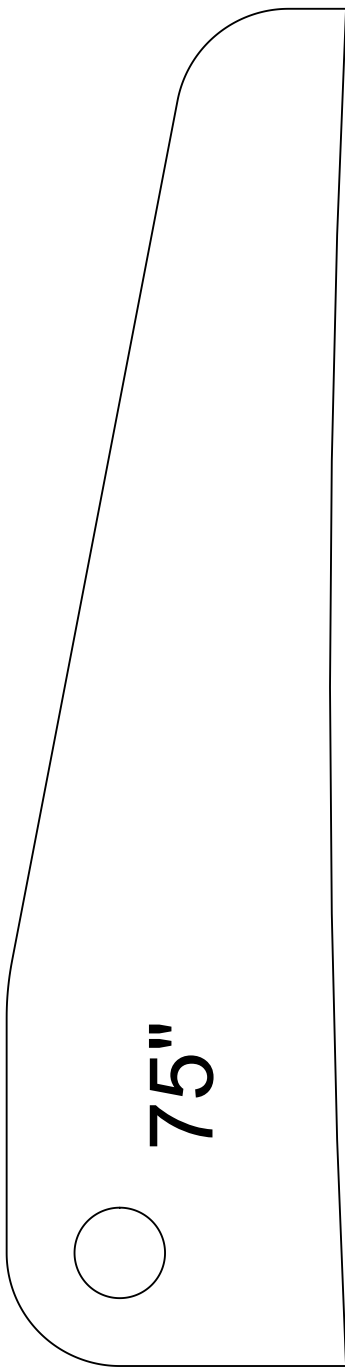

*distancia
200mm*

*distancia
100mm*

*distancia
100mm*

Appendix B

More Educational Products From Jerzy Drozd

If you have enjoyed this **Ultimate Guide to the Perfect Bass Setup** and have found it to be useful, you can learn about other products from Jerzy Drozd in the following pages:

- [The Alchemy of Sound - The Book](#)
- [Bass Design Fundamentals - Basic Video Course on Professional Bass Design](#)

<http://www.jerzydrozdbasses.com/alquimia-de-sonido.html>

The Alchemy of Sound - The Book

The Definitive Sound Bible for: Bass Players, Retailers and Luthiers

The Best-Kept Secrets about Sound and How to Use Them to:

- ★ Better Understand the Sound of Your Bass
- ★ Help You Make a Decision when Buying Your Next Instrument
- ★ Help Your Clients Decide Which Instrument to Buy
- ★ Construct a Bass with Maximum Sound Quality

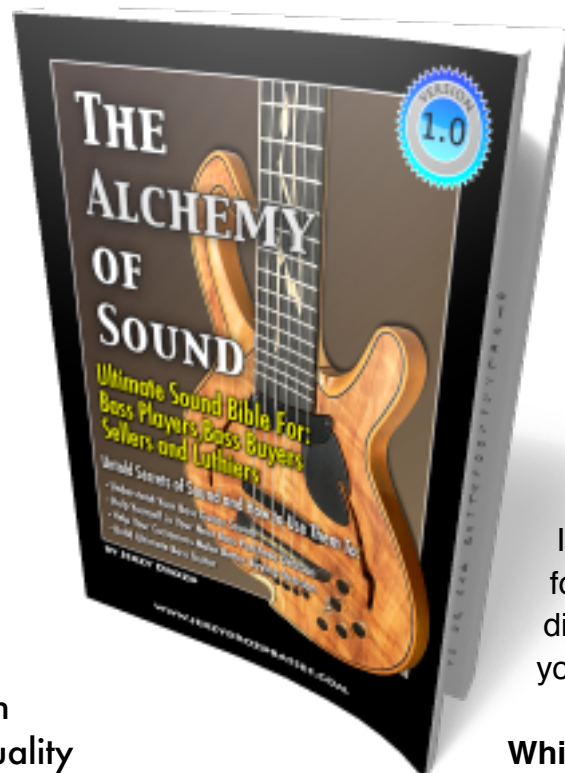

The Alchemy of Sound The Book

Never before has there existed a book that so sincerely reveals all of the closely-guarded secrets of the great luthiers regarding the nature of the sound of such a beautiful instrument as the electric bass.

This one-of-a-kind book is a world-class rarity, which compiles the principles that govern the sound of all stringed instruments, based on physical laws, as explained for the first time by the world-renowned luthier, Jerzy Drozd.

There is no other book that encompasses and brings together the secrets that are uncovered here, much less in Spanish.

This book is written for every kind of bass player and perspective buyer who is interested in learning more about proven methods for choosing a new instrument.

It is likely that you have found yourself in the same dilemma and have asked yourself these questions:

Which bass is ideal for me in terms of the sound I'm looking for?

Should I choose a bass with a detachable neck or with a conjoined neck and body?

Do the construction and the type of wood really influence the sound of the bass as much as they claim?

...and many other questions that you have probably asked yourself

This book is also dedicated to venders, so that they can better advise their customers.

Last but not least, it is dedicated to any luthier who wants to learn how to construct instruments with a unique and superior sound quality and avoid the years of trial and error that are usually necessary in order to learn and understand these principles.

In this book, you will discover:

- The two unique factors that determine the overall sound of the instrument**
- The formula for calculating the sonorous properties of different woods**
- The real reason why basses with a detachable neck and those with a conjoined neck and body sound so different**
- The "Floating Neck" theory**

- The 7 Laws of Bass Sound that will help you choose the ideal bass for your playing style without even having to try it out**
- How to position the pickups so that you will avoid those dreaded "dead spots"**
- How the scale length of your bass affects its playing comfort, but most of all, its sound quality**

...and much more

This book is still in the process of being written, but should be available sometime next year.

For more information:

<http://www.jerzydrozdbasses.com/alquimia-de-sonido.html>

Bass Design Fundamentals - Video Course

With this **Bass Design Fundamentals Course**, you will learn all of the techniques and secrets I use when I design my own instruments.

I have used these techniques to design basses like the Obsession series (Legend, Sequel, Excellency Prodigy Le, etc.), Barcelona or the latest Oracle™ bass guitar.

Here is an inside look at what you will learn in this **Bass Design Fundamentals Course**,:



Bass Design Fundamentals – Basic Video Course on Professional Bass Design

Have you ever dreamed of building your own bass guitar?

A great bass-building project starts with great bass design.

1. Basic principles of the structure-driven and creativity-driven elements of bass guitar design
2. Bridge positioning Principles
3. Headstock design techniques
4. Placement of the Tuners
5. Body design techniques
6. Design scaling principles
7. Body & Headstock Fairing techniques
8. Pickup positioning secrets
9. Design of the Control Cavity and Layout of the Knobs
10. Rear cavity design
11. Printing
12. Export to .dxf format

13. ... and much more!
14. I will also add a few surprises

This course is directed at those who want to learn bass design skills and no previous experience is necessary.

CAD software is used in this course, but you do not need any special skills or knowledge of this software; you will learn it at your own pace.

Now, you will probably have some questions:

What if I don't have CAD Software?

Well, actually you don't need to have it in order to begin the first lesson. I have included resources that will help you find great CAD software for just a few bucks and one of the best Pro CAD software programs I will show you is 100% FREE and 100% legal! So, it's up to you which one you choose, but you can be sure that software won't be a problem.

Can I still learn with your course even though I'm not a computer geek?

Yes. In fact, every lesson demonstrates universal techniques that you can apply whether you work with CAD programs or you just use a plain-old sheet of paper, a

pencil and a table (actually, that's the way I worked for years before the CAD explosion).

More information will be available soon.

For more information:

<http://www.jerzydrozdbasses.com/bass-design-fundamentals-es.html>

Also check out my Blog:

<http://www.jerzydrozdbasses.com/blogit/bass-design-fundamentals-design-your-own-bass-guitar>

This book is **FREE** but If you have find it interesting with useful information and actualy it helps you in your daily instrument adjustment, please consider dontation. I will appreciate that and will work on more useful stuff like this book ;-)

Donate

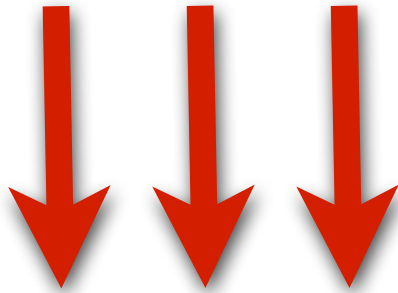

Here

Thank you! :-))))