

Guided drives DFM/DFM-B



Guided drives DFM/DFM-B

Key features

FESTO

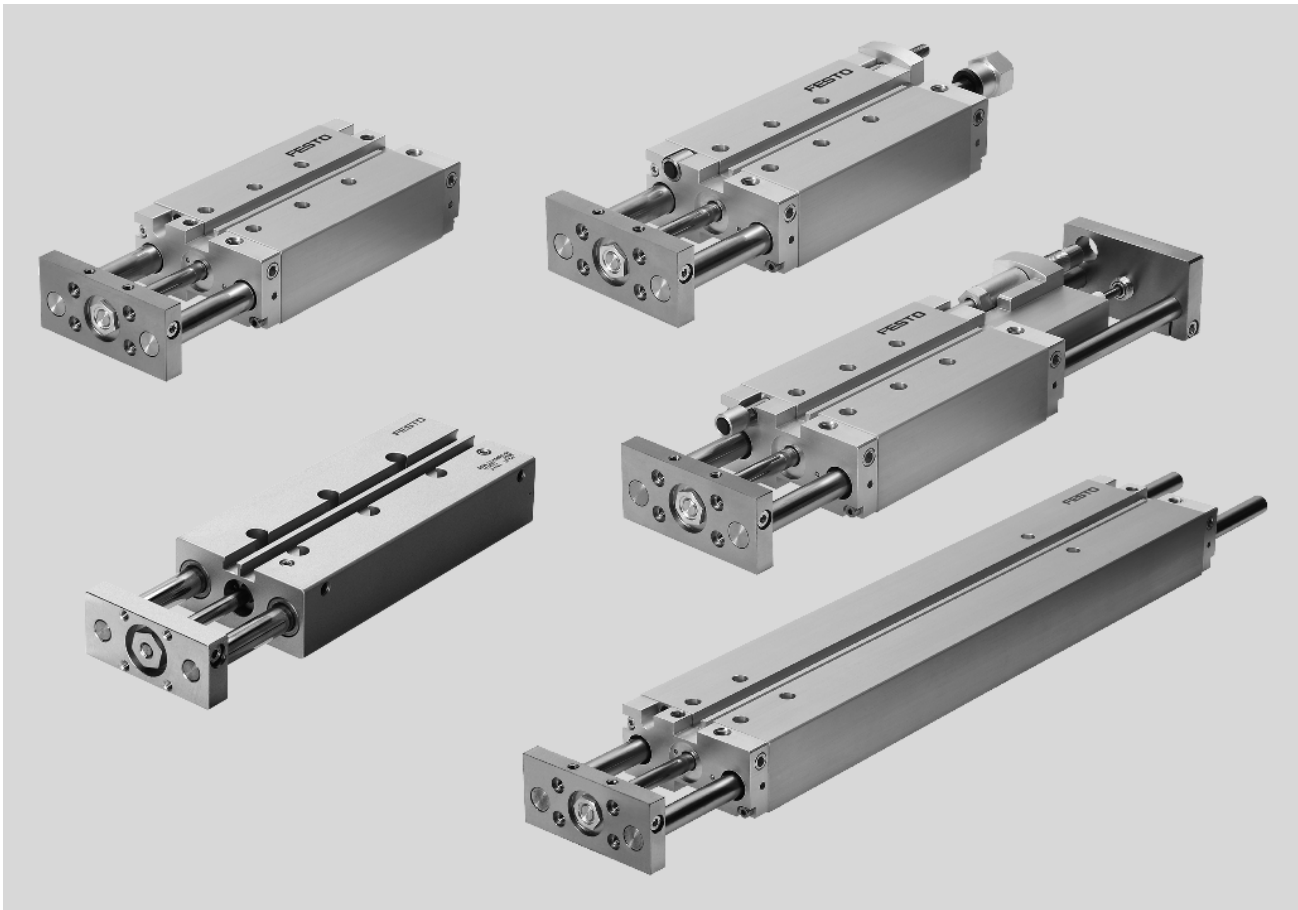

Drive and guide unit in a single housing

- Minimal space requirement
- Minimal assembly time
- Choice of supply ports
- Versatile mounting options

Sturdy and accurate

- Good protection against torsion
- Rigid construction
- Maintenance-free

High resistance to torques and lateral forces

- With plain-bearing guide:
It offers high rigidity thanks to its large-diameter guide rods and four plain-bearing bushes
- With recirculating ball bearing guide:
For applications involving torque loads

Wide choice of variants

- With adjustable end position
- With shock absorber
- Long-stroke version
- With pneumatic end-position cushioning PPV

Guided drives DFM/DFM-B

Key features

Use in conveyor systems

Lifting

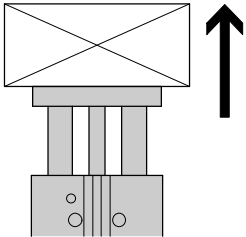

Pushing

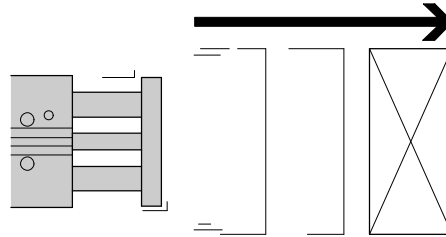

Stopping

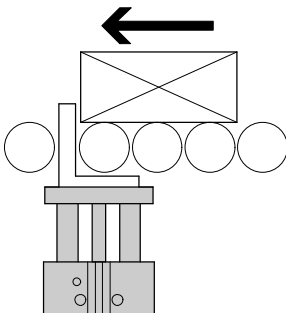

Stopping via stop bracket

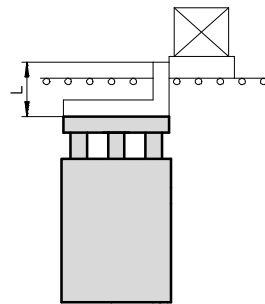

It is recommended to fit a buffer on the workpiece carrier.

Mounting options

Flat from above

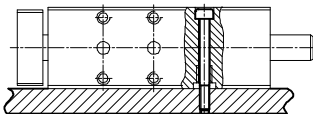

Flat from below

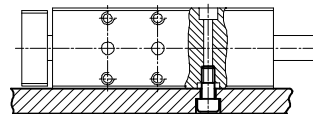

Side mounting from below

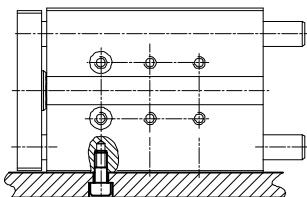



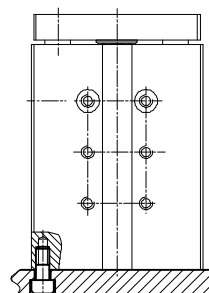



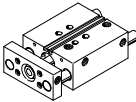
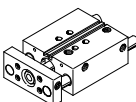
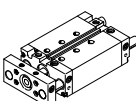

On end

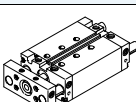

Guided drives DFM/DFM-B

Product range overview

Function	Version	Type	Piston Ø	Stroke	Variable stroke
			[mm]	[mm]	[mm]
Double-acting	DFM basic version with recirculating ball bearing guide				
		DFM Piston rod at one end	12, 16	10, 20, 25, 30, 40, 50, 80, 100	–
			20, 25	20, 25, 30, 40, 50, 80, 100	–
			32	20, 25, 30, 40, 50, 80, 100, 125, 160, 200	–
			40, 50, 63, 80, 100	25, 50, 80, 100, 125, 160, 200	–
	DFM basic version with plain-bearing guide				
		DFM Piston rod at one end	12, 16	10, 20, 25, 30, 40, 50, 80, 100	–
			20, 25	20, 25, 30, 40, 50, 80, 100	–
			32	20, 25, 30, 40, 50, 80, 100, 125, 160, 200	–
			40, 50, 63, 80, 100	25, 50, 80, 100, 125, 160, 200	–
	DFM-B with recirculating ball bearing guide				
		DFM-B Piston rod at one end	12, 16	10, 20, 25, 30, 40, 50, 80, 100, 125, 160, 200	10 ... 200 
			20, 25, 32	20, 25, 30, 40, 50, 80, 100, 125, 160, 200, 250, 320, 400	20 ... 400 
			40, 50, 63	25, 50, 80, 100, 125, 160, 200, 250, 320, 400	25 ... 400 
	DFM-B with plain-bearing guide				
		DFM-B Piston rod at one end	12, 16	10, 20, 25, 30, 40, 50, 80, 100, 125, 160, 200	10 ... 200 
			20, 25, 32	20, 25, 30, 40, 50, 80, 100, 125, 160, 200, 250, 320, 400	20 ... 400 
			40, 50, 63	25, 50, 80, 100, 125, 160, 200, 250, 320, 400	25 ... 400 

Note

GSED
sizing software
→ www.festo.com

Guided drives DFM/DFM-B

Product range overview

Type	Position sensing	Cushioning			Heat-resistant seals	Precision end-position adjustment		→ Page/Internet
		Not adjustable	Adjustable for heavy loads	Self-adjusting end position adjustable for heavy loads		Advanced end position	Retracted end position	
	A	P	PPV	YSRW	S6 	AJ	EJ	
DFM basic version with recirculating ball bearing guide								
DFM Piston rod at one end	■	■	-	-	-	-	-	8
DFM basic version with plain-bearing guide								
DFM Piston rod at one end	■	■	-	-	-	-	-	8
DFM-B with recirculating ball bearing guide								
DFM-B Piston rod at one end	■	■	■ Ø 16 and above	■ Ø 20 and above	-	■	■ Ø 20 and above	30
DFM-B with plain-bearing guide								
DFM-B Piston rod at one end	■	■	■	-	■	■	■	30

Guided drives DFM

Peripherals overview

FESTO

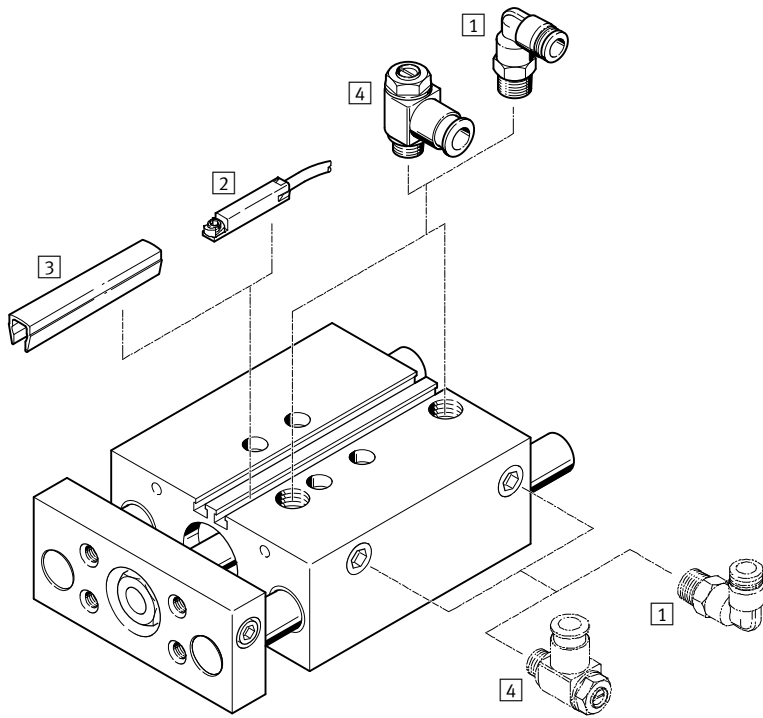

Accessories		
	Brief description	→ Page/Internet
1	Push-in fitting QS	For connecting compressed air tubing with standard O.D. quick star
2	Proximity sensor SME-/SMT-8	Can be integrated in the profile barrel 60
3	Slot cover ABP-5-S	To protect the sensor cable and keep dirt out of the sensor slots 62
4	One-way flow control valve GRLA	To regulate speed 62
-	Centring sleeves ZBH	4 pieces included in scope of delivery 60
-	Adapters	For drive/drive combinations 63
		For drive/gripper combinations gripper

Guided drives DFM

Type codes

	DFM	-	50	-	80	-	P	-	A	-	
Type											
Double-acting											
DFM	Guided drive										
Piston Ø [mm]											
Stroke [mm]											
Cushioning											
P	Flexible cushioning rings/plates at both ends										
Position sensing											
A	For proximity sensing										
Guide											
GF	Plain-bearing guide										
KF	Recirculating ball bearing guide										

High functionality

Direction of movement

Excellent protection against torsion, high resistance to torques and lateral forces

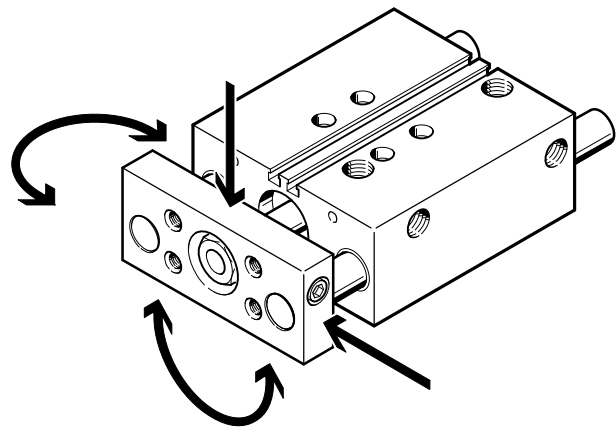
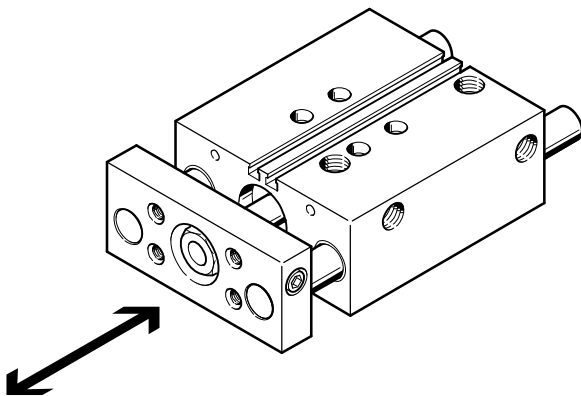

Guided drives DFM

Technical data

Function

www.festo.com/en/Spare_parts_service

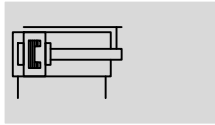

- N- Diameter
12 ... 100 mm
- T- Stroke length
10 ... 200 mm

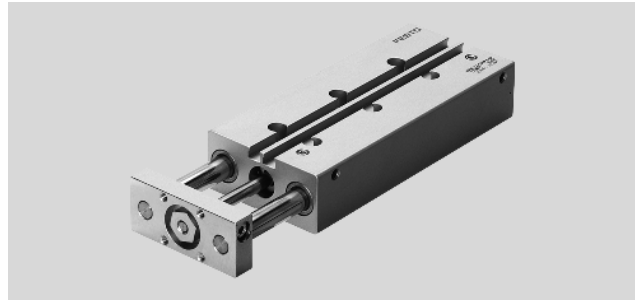

General technical data										
Piston Ø	12	16	20	25	32	40	50	63	80	100
Pneumatic connection	M5	M5	M5	G1/8	G1/8	G1/8	G1/4	G1/4	G3/8	G3/8
Operating medium	Compressed air in accordance with ISO 8573-1:2010 [7:4:4]									
Note on operating/pilot medium	Operation with lubricated medium possible (in which case lubricated operation will always be required)									
Operating pressure [bar]	2 ... 10			1.5 ... 10			1 ... 10		0.5 ... 10	
Design	Piston									
	Piston rod									
	Guide rods with yoke									
Cushioning	Flexible cushioning rings/plates at both ends									
Position sensing	For proximity sensing									
Type of mounting	Via through-holes									
	Via female threads									
Assembly position	Any									
Protection against torsion/guide	Guide rod with yoke/with plain-bearing or ball bearing guide									

Note: This product conforms to ISO 1179-1 and ISO 228-1

Ambient conditions		
Variant	Plain-bearing guide GF	Recirculating ball bearing guide KF
Ambient temperature ¹⁾ [°C]	-20 ... +80	-5 ... +60
Corrosion resistance class CRC ²⁾	2	-
ATEX	Specified types → www.festo.com	

- 1) Note operating range of proximity sensors
- 2) Corrosion resistance class 1 according to Festo standard 940 070
 Components requiring low corrosion resistance. Transport and storage protection. Parts that do not have primarily decorative surface requirements, e.g. in internal areas that are not visible or behind covers
 Corrosion resistance class 2 according to Festo standard 940 070
 Components requiring moderate corrosion resistance. Externally visible parts with primarily decorative surface requirements which are in direct contact with a normal industrial environment or media such as coolants or lubricating agents

Speeds [m/s]										
Piston Ø	12	16	20	25	32	40	50	63	80	100
Cushioning P										
Maximum speed, advancing	0.8	0.8	0.8	0.8	0.8	0.8	0.6	0.6	0.4	0.4
Maximum speed, retracting	0.8	0.8	0.8	0.8	0.8	0.8	0.6	0.6	0.4	0.4

Forces [N]										
Piston Ø	12	16	20	25	32	40	50	63	80	100
Theoretical force at 6 bar, advancing	68	121	188	295	482	754	1178	1870	3016	4712
Theoretical force at 6 bar, retracting	51	90	141	247	415	686	1057	1750	2827	4418

Guided drives DFM

Technical data

FESTO

Impact energy [J]										
Piston Ø	12	16	20	25	32	40	50	63	80	100
Max. impact energy at the end positions	0.09	0.10	0.14	0.35	0.40	0.52	0.64	0.70	0.75	1.00

Permissible impact velocity:

$$v_{\text{perm.}} = \sqrt{\frac{2 \times E_{\text{perm.}}}{m_{\text{dead}} + m_{\text{load}}}}$$

$v_{\text{perm.}}$ Permissible impact velocity
 $E_{\text{perm.}}$ Max. impact energy
 m_{dead} Moving load (drive)
 m_{load} Moving work load

Note

These specifications represent the maximum values which can be reached. Note the maximum permitted impact energy.

Maximum permissible load:

$$m_{\text{load}} = \frac{2 \times E_{\text{perm.}}}{v^2} - m_{\text{dead}}$$

DFM with plain-bearing guide GF										
Stroke [mm]	Piston Ø [mm]									
	12	16	20	25	32	40	50	63	80	100
Product weight [g]										
10	338	449	–	–	–	–	–	–	–	–
20	371	515	777	1250	1770	–	–	–	–	–
25	405	540	825	1270	1835	2145	3431	4472	6984	11000
30	435	571	865	1340	1915	–	–	–	–	–
40	494	707	1060	1420	2120	–	–	–	–	–
50	540	770	1150	1630	2230	2520	4092	5213	8185	12589
80	690	920	1350	1990	2795	2980	5016	6273	9743	14699
100	775	1085	1595	2226	3092	3531	5434	6791	10482	15760
125	–	–	–	–	3586	3915	6338	7865	11490	17094
160	–	–	–	–	3630	4520	7219	8920	12910	18980
200	–	–	–	–	4777	5389	8139	10172	14363	21148
Moving load [g]										
10	170	230	–	–	–	–	–	–	–	–
20	190	250	400	650	1040	–	–	–	–	–
25	190	260	420	670	1070	1190	2050	2510	4140	6300
30	200	280	440	690	1090	–	–	–	–	–
40	230	340	550	760	1150	–	–	–	–	–
50	250	370	580	800	1210	1330	2280	2740	4720	7110
80	290	430	680	910	1480	1600	2720	3190	5460	8140
100	320	470	740	990	1590	1720	2910	3370	5730	8520
125	–	–	–	–	1840	1960	3300	3760	6080	9000
160	–	–	–	–	2040	2170	3630	4090	6550	9670
200	–	–	–	–	2280	2400	4000	4460	7100	10430

Guided drives DFM

Technical data

DFM with recirculating ball bearing guide KF										
Stroke [mm]	Piston Ø [mm]									
	12	16	20	25	32	40	50	63	80	100
Product weight [g]										
10	320	424	-	-	-	-	-	-	-	-
20	340	481	732	1185	1583	-	-	-	-	-
25	377	507	760	1215	1639	1953	3135	4155	6506	10520
30	403	535	810	1288	1711	-	-	-	-	-
40	466	647	967	1425	1849	-	-	-	-	-
50	508	704	1050	1534	1993	2342	3704	4880	7582	11980
80	560	878	1290	1871	2425	2867	4489	5791	8895	13612
100	723	988	1330	2089	2726	3166	4930	6337	9500	14587
125	-	-	-	-	3627	3616	5626	7860	10485	15820
160	-	-	-	-	3890	4161	6409	8110	11750	17545
200	-	-	-	-	4189	4798	7550	9300	13214	21124
Moving load [g]										
10	150	200	-	-	-	-	-	-	-	-
20	160	220	360	590	860	-	-	-	-	-
25	160	230	380	600	880	1000	1720	2180	3670	5700
30	170	240	390	620	900	-	-	-	-	-
40	190	290	480	670	960	-	-	-	-	-
50	200	300	500	700	980	1100	1880	2340	4090	6320
80	230	350	570	790	1160	1280	2180	2640	4630	7110
100	250	380	620	850	1240	1360	2310	2770	4840	7410
125	-	-	-	-	1400	1530	2580	3040	5090	7780
160	-	-	-	-	1540	1670	2810	3270	5450	8310
200	-	-	-	-	1710	1830	3070	3530	5860	8910

Materials

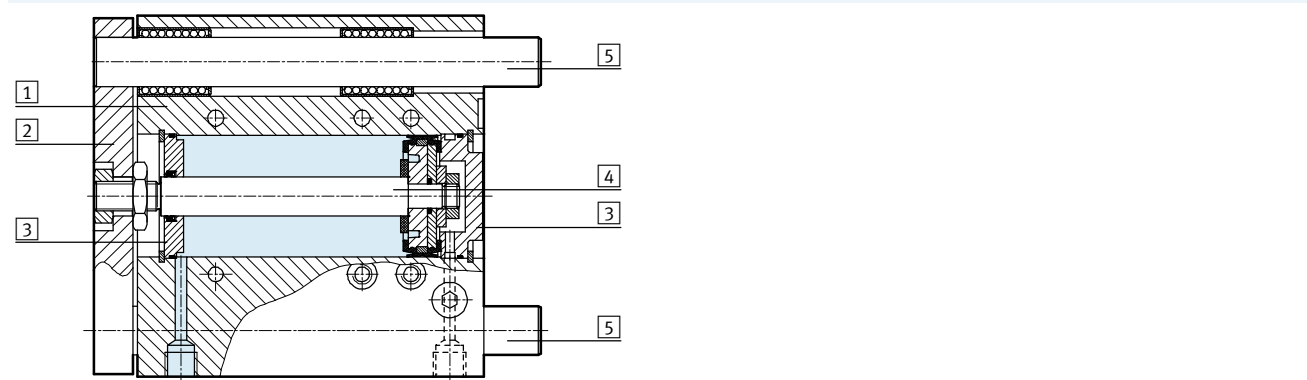

Variant	Plain-bearing guide GF	Recirculating ball bearing guide KF
1 Housing	Wrought aluminium alloy, anodised	Wrought aluminium alloy, anodised
2 Yoke plate	Tempered steel	Tempered steel
3 Bearing and end caps	Wrought aluminium alloy, anodised	Wrought aluminium alloy, anodised
4 Piston rod	High-alloy stainless steel	High-alloy stainless steel
5 Guide rods	High-alloy stainless steel	Tempered steel
- Static seals	Nitrile rubber	Nitrile rubber
- Dynamic seals	Polyurethane	Polyurethane
Note on materials	RoHS compliant	

Guided drives DFM

Technical data

FESTO

Maximum effective load F [N]

Plain-bearing guide GF and recirculating ball bearing guide KF

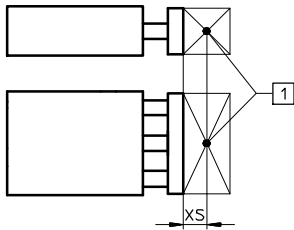

1 Centre of gravity of effective load

Piston Ø [mm]	XS [mm]	Stroke [mm]											
		10	20	25	30	40	50	80	100	125	160	200	
12	GF	25	28	24	23	21	31	28	22	19	-	-	-
	KF		27	23	21	20	23	22	20	19	-	-	-
16	GF	50	63	56	53	51	73	67	55	49	-	-	-
	KF		45	31	27	24	58	56	51	48	-	-	-
20	GF	50	-	67	64	61	110	103	86	77	-	-	-
	KF		-	45	39	35	91	88	80	75	-	-	-
25	GF	50	-	121	116	112	123	115	96	86	-	-	-
	KF		-	88	86	84	100	97	89	85	-	-	-
32	GF	50	-	188	180	173	161	150	166	150	168	146	127
	KF		-	120	118	116	112	109	134	128	144	135	126
40	GF	50	-	-	180	-	-	150	166	150	168	146	127
	KF		-	-	118	-	-	109	134	128	144	135	126
50	GF	50	-	-	257	-	-	216	234	212	229	200	174
	KF		-	-	182	-	-	168	201	193	211	199	188
63	GF	50	-	-	257	-	-	216	234	212	229	200	174
	KF		-	-	182	-	-	168	201	193	211	199	188
80	GF	125	-	-	276	-	-	311	352	329	304	274	245
	KF		-	-	220	-	-	275	329	318	306	291	277
100	GF	125	-	-	452	-	-	509	568	533	494	446	400
	KF		-	-	332	-	-	415	495	480	463	442	422

Permissible torque load M [Nm]

Plain-bearing guide GF and recirculating ball bearing guide KF

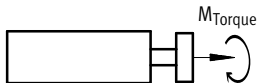

Piston Ø [mm]	Stroke [mm]											
	10	20	25	30	40	50	80	100	125	160	200	
12	GF	0.60	0.50	0.48	0.45	0.65	0.60	0.45	0.40	-	-	-
	KF	0.55	0.47	0.44	0.42	0.47	0.45	0.41	0.38	-	-	-
16	GF	1.44	1.30	1.23	1.18	1.68	1.56	1.28	1.14	-	-	-
	KF	1.03	0.71	0.62	0.55	1.34	1.29	1.18	1.12	-	-	-
20	GF	-	1.85	1.75	1.70	3.00	2.80	2.35	2.10	-	-	-
	KF	-	1.30	1.13	1.01	2.64	2.56	2.34	2.23	-	-	-
25	GF	-	4.15	3.95	3.80	4.20	3.90	3.25	2.90	-	-	-
	KF	-	3.00	2.92	2.85	3.40	3.30	3.02	2.89	-	-	-
32	GF	-	7.30	7.00	6.70	6.20	5.80	6.40	5.80	6.50	5.70	5.00
	KF	-	4.70	4.60	4.55	4.40	4.25	5.25	5.00	5.60	5.25	4.90
40	GF	-	-	7.90	-	-	6.55	7.25	6.55	7.35	6.40	5.55
	KF	-	-	5.20	-	-	4.80	5.90	5.65	6.35	5.95	5.55
50	GF	-	-	14.15	-	-	11.85	12.85	11.65	12.55	11.00	9.60
	KF	-	-	10.00	-	-	9.30	11.00	10.60	11.60	11.00	10.30
63	GF	-	-	15.90	-	-	13.30	14.45	13.10	14.10	12.30	10.70
	KF	-	-	11.30	-	-	10.50	12.50	12.00	13.20	12.40	11.70
80	GF	-	-	21.40	-	-	24.20	27.20	25.50	23.50	21.30	19.00
	KF	-	-	17.10	-	-	21.30	25.50	24.70	23.70	22.60	21.50
100	GF	-	-	42.40	-	-	47.80	53.40	50.10	46.40	42.00	37.60
	KF	-	-	25.70	-	-	32.20	38.40	37.20	35.90	34.20	32.70

Note

GSED
sizing software
→ www.festo.com

Guided drives DFM

Technical data



Torsional backlash p

Plain-bearing guide GF and recirculating ball bearing guide KF in retracted state, without load

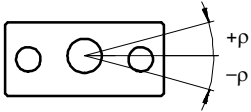

Piston \varnothing		12	16	20	25	32	40	50	63	80	100
Torsional backlash [°]	GF	0.09	0.09	0.07	0.07	0.06	0.06	0.05	0.05	0.03	0.03
	KF	0.08	0.08	0.07	0.07	0.05	0.05	0.05	0.05	0.03	0.03

Deflection of piston rod

Bearing backlash plain-bearing guide GF and recirculating ball bearing guide KF (without load)

DFM-12 ... 20 stroke \leq 30 mm

DFM-12 ... 20 stroke $>$ 30 mm

1 bearing per guide rod

DFM-25 ... 100:

2 bearings per guide rod

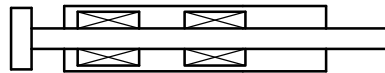
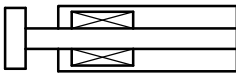

Piston \varnothing		12	16	20	25	32	40	50	63	80	100
Bearing backlash [mm]	GF	0.11	0.11	0.11	0.10	0.13	0.13	0.12	0.12	0.12	0.12
	KF	0.10	0.08	0.08	0.08	0.08	0.08	0.08	0.08	0.07	0.07

Mean deflection f_1 due to bearing backlash as a function of the stroke l

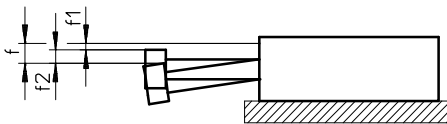

$$f = f_1 + f_2$$

f = Total deflection of piston rod

f_1 = Deflection due to bearing backlash

f_2 = Deflection due to lateral force

DFM with 2 bearings per guide rod

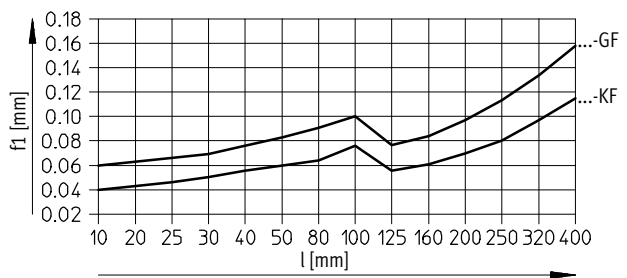

Guided drives DFM

Technical data

Use as a stopper cylinder

When used as a stopper cylinder, only guided drives with plain-bearing guide DFM-...-GF may be used.

In addition, the distance l_{max} (→ drawing) must not be exceeded.

The permissible kinetic impact energy at the end stop must also not be exceeded.

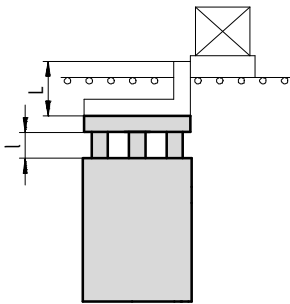

$$l_{max} = \text{Stroke } l + \text{height of stop bracket } L$$

$$l_{max} = 50 \text{ mm}$$

Impact mass m as a function of the impact velocity v

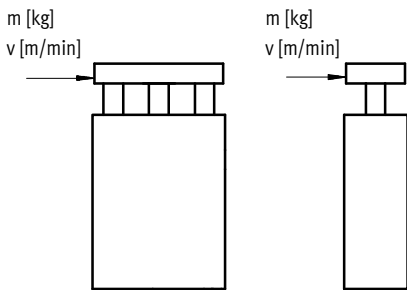

DFM-12 ... 25-GF
Stroke < 30 mm

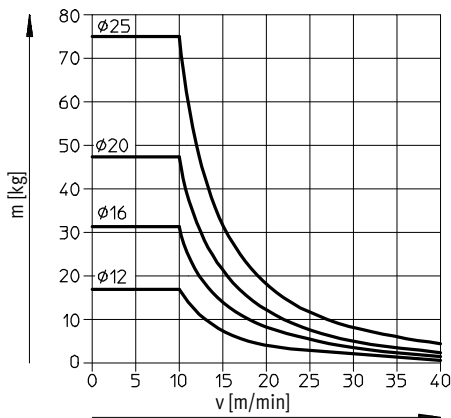

The values in the above graph are based on the assumption that the workpiece carrier is fitted with a flexible buffer with a deformation of 1 mm. Only guided drives with plain-bearing guide GF and a stroke of < 30 mm may be used.

DFM-32 ... 100-GF
Stroke < 50 mm

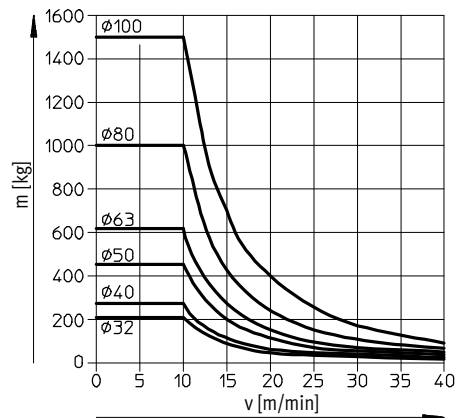

The values in the above graph are based on the assumption that the workpiece carrier is fitted with a flexible buffer with a deformation of 2 mm. Only guided drives with plain-bearing guide GF and a stroke of < 50 mm may be used.

Guided drives DFM

Technical data

Used as lifting cylinder

Permissible load with plain-bearing guide GF

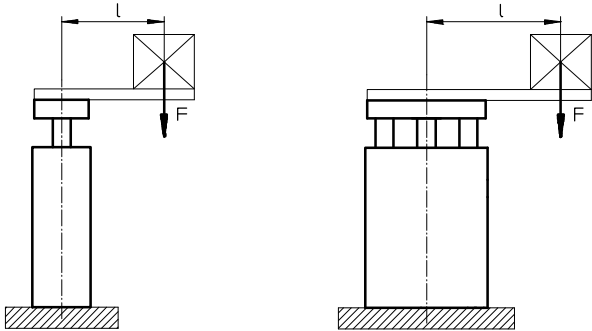

F = Longitudinal force [N]
l = Lever arm [mm]

DFM-12 ... 25-GF
Stroke 30 mm

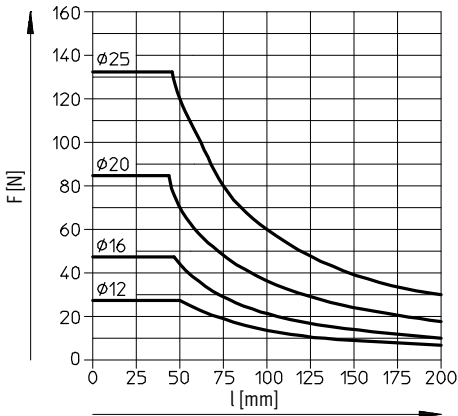

DFM-12 ... 25-GF
Stroke 40 ... 100 mm

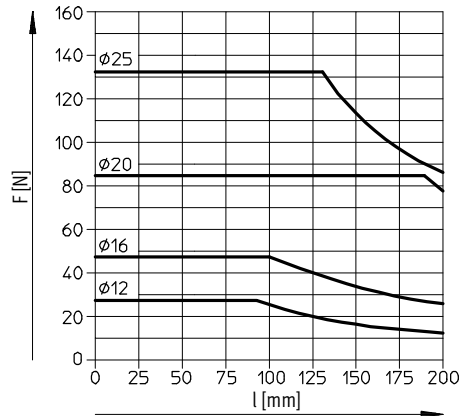

DFM-32 ... 63-GF
Stroke 50 mm

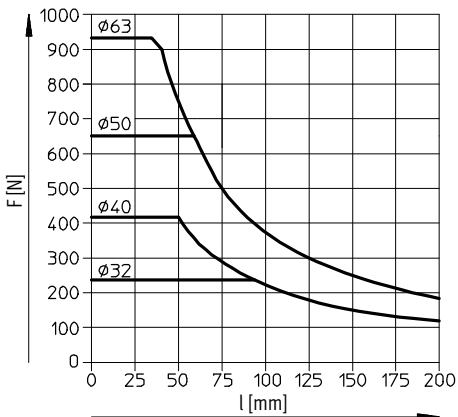

DFM-32 ... 63-GF
Stroke 80 ... 100 mm

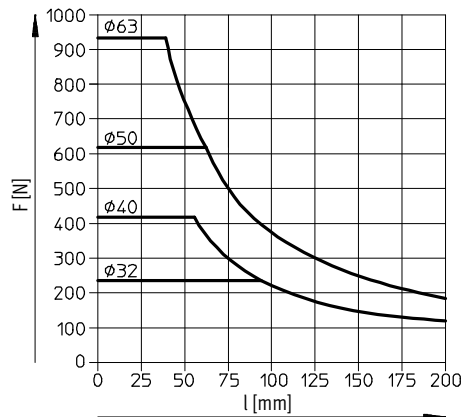

Guided drives DFM

Technical data

Used as lifting cylinder

Permissible load with plain-bearing guide GF

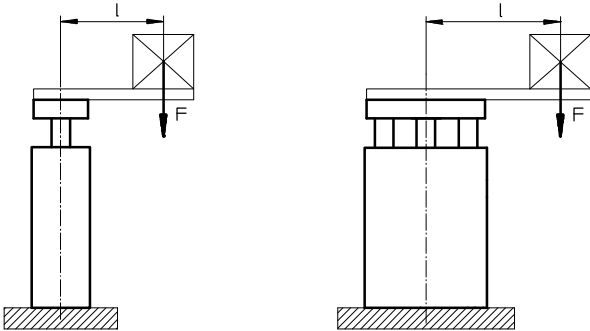

F = Longitudinal force [N]
l = Lever arm [mm]

DFM-32 ... 63-GF
Stroke 125 ... 200 mm

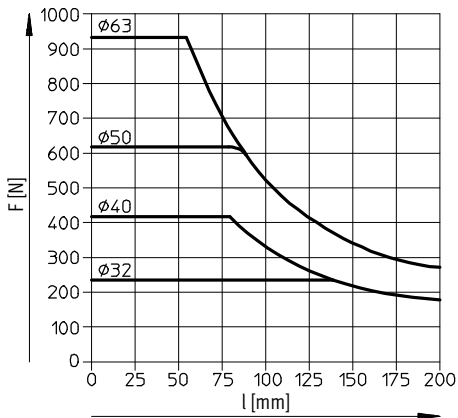

DFM-80 ... 100-GF
Stroke 25 mm

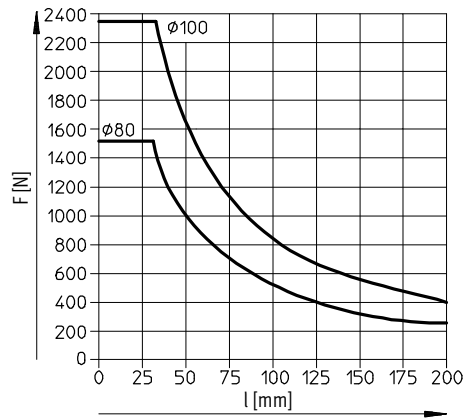

DFM-80 ... 100-GF
Stroke 50 mm

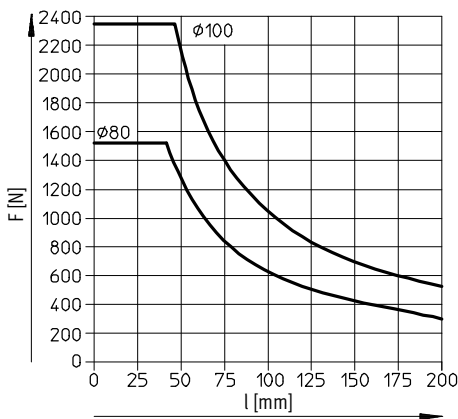

DFM-80 ... 100-GF
Stroke 80 ... 200 mm

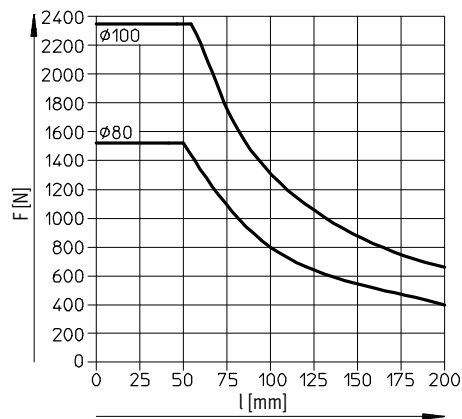

Guided drives DFM

Technical data

Used as lifting cylinder

Permissible load with recirculating ball bearing guide KF

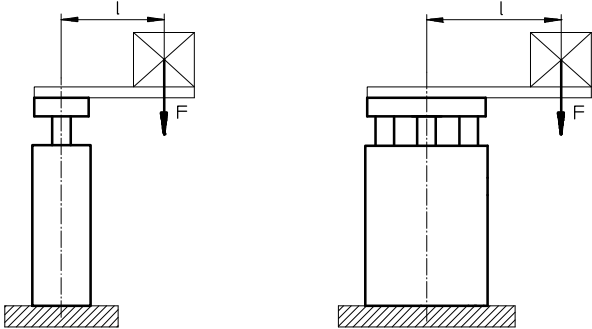

F = Longitudinal force [N]
l = Lever arm [mm]

DFM-12 ... 25-KF
Stroke 30 mm

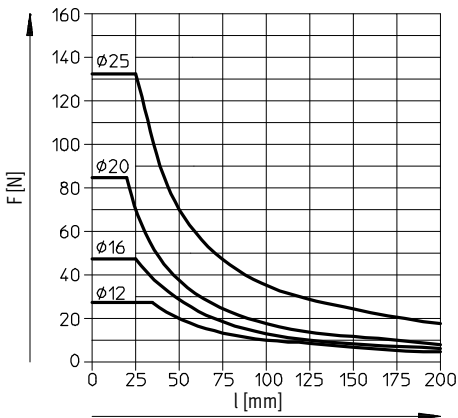

DFM-12 ... 25-KF
Stroke 40 ... 100 mm

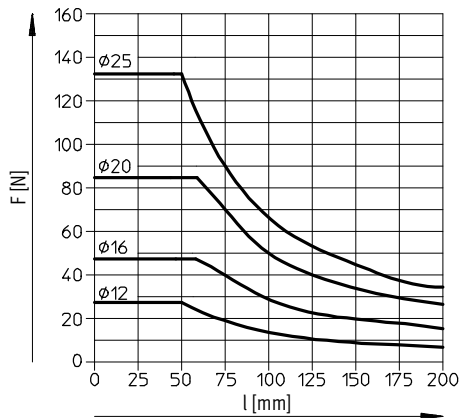

DFM-32 ... 63-KF
Stroke 50 mm

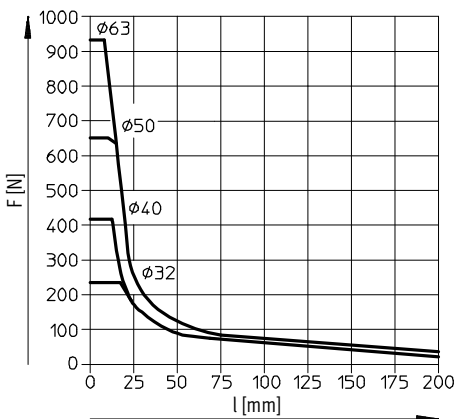

DFM-32 ... 63-KF
Stroke 80 ... 100 mm

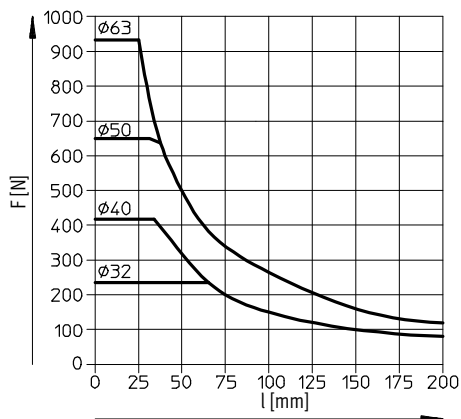

Guided drives DFM

Technical data

Used as lifting cylinder

Permissible load with recirculating ball bearing guide KF

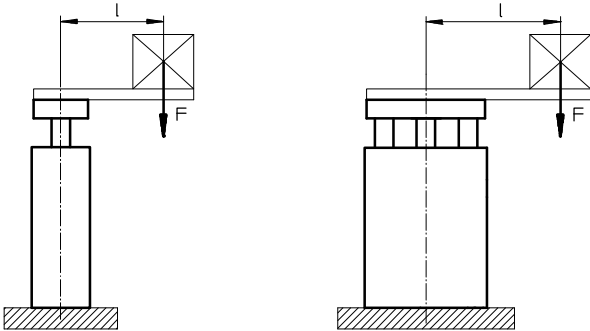

F = Longitudinal force [N]
l = Lever arm [mm]

DFM-32 ... 63-KF
Stroke 125 ... 200 mm

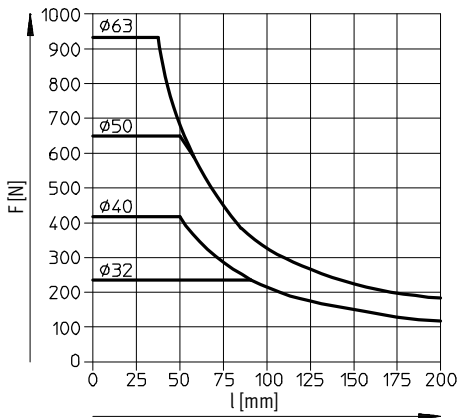

DFM-80 ... 100-KF
Stroke 25 mm

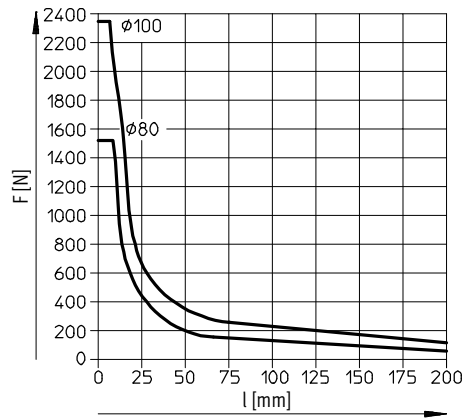

DFM-80 ... 100-KF
Stroke 50 mm

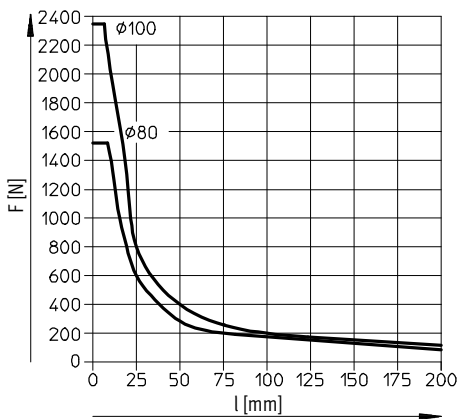

DFM-80 ... 100-KF
Stroke 80 ... 200 mm

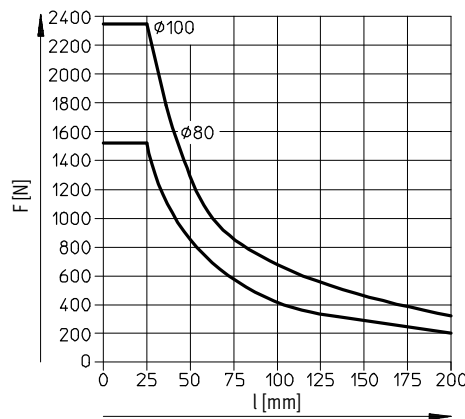

Guided drives DFM

Technical data

FESTO

Dimensions

Piston \varnothing 12 ... 16 mm

Download CAD Data → www.festo.com/us/cad

First-angle projection

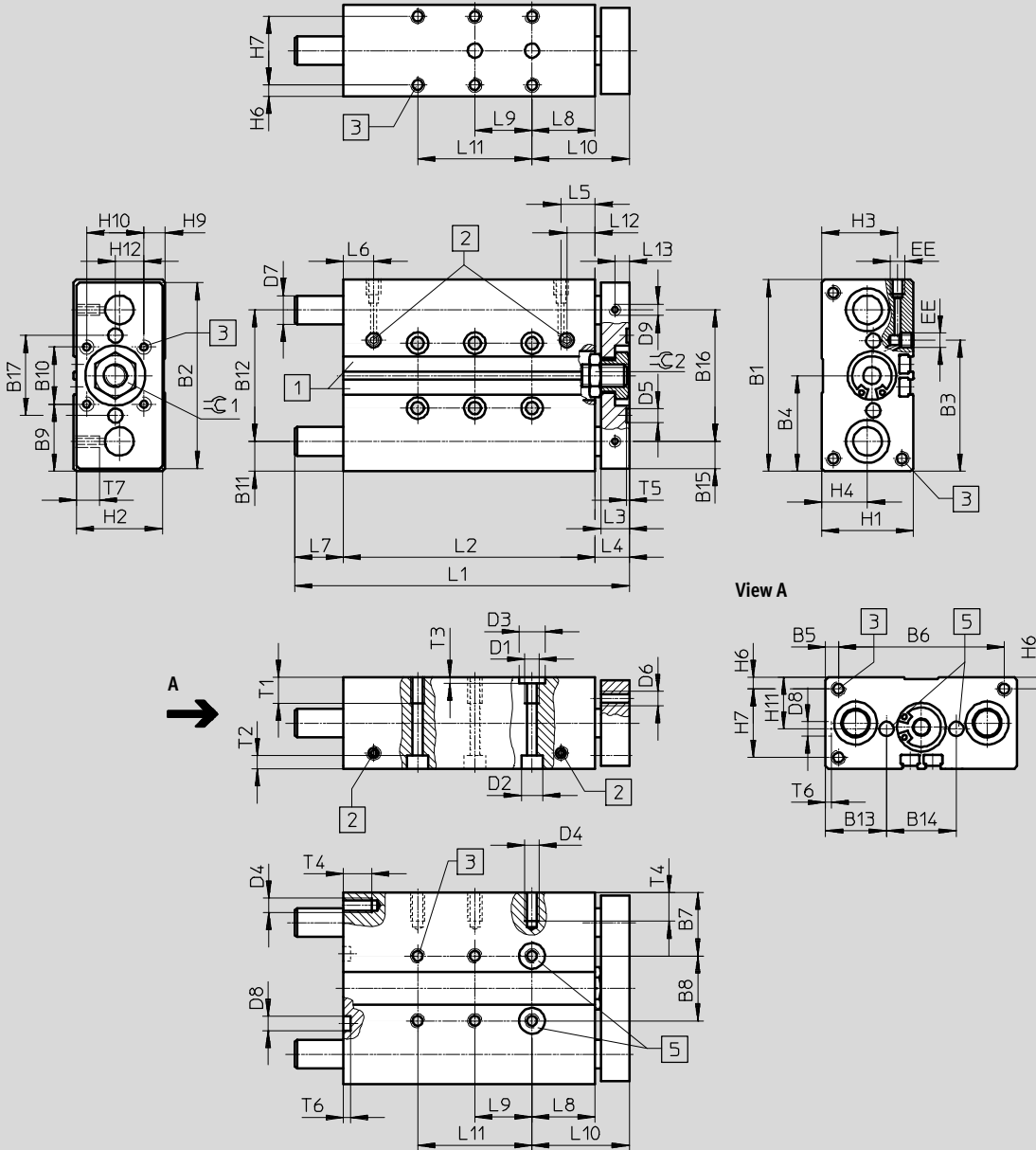
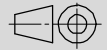

1 Mounting slot for proximity sensor SME-/SMT-8

2 Supply port optionally at side or top

3 Mounting thread

5 Tolerance between centring holes ± 0.02 mm

Note

If the guide rods project beyond the housing when the unit is in its retracted end position (→ dimension L7), a recess must be provided in the

mounting surface if the unit is to be mounted against a surface in order to allow the guide rods to move freely.

Guided drives DFM

Technical data

∅ [mm]	B1	B2	B3	B4	B5	B6	B7	B8	B9	B10	B11	B12	B13	B14	B15	B16	B17	D1	D2 ∅	D3 ∅ H7
12	60	58	42.4	30	4.5	51	20.5	19	20	20	9.5	41	19.5	21	8.5	41	25	M5	8	9
16	67	65	45.9	33.5	4.5	58	22	23	23.5	20	10.5	46	21.3	24.4	-	-	28	M5	7.5	9

∅ [mm]	D4	D5 ∅ H7	D6	D7 ∅		D8 ∅ H7	D9	EE	H1	H2	H3	H4	H6	H7	H9	H10	H11	H12
				GF	KF													
12	M4	5	M4	10 _{h8}	8 _{h6}	5	M4	M5	28	26	24	14	4	20	4	20	14	10
16	M5	5	M5	12 _{h8}	10 _{h6}	5	-	M5	32	30	26.5	16	4	24	7.4	20	16	10

∅ [mm]	Stroke [mm]	L1	L2	L3	L4	L5	L6	L7	L8	L9	L10 ±0.1	L11
20	69	56	-	-	-							
25	74	61	-	20	-							
30	79	66	-	20	-							
40	95	76	6	20	-							
50	105	86	6	40	-							
80	135	116	6	40	-							
100	155	136	6	40	80							
16	10	60	48	10	12	11.9	10.6	22	34	-	-	-
20	70	58	-							-	-	
25	75	63	-							20	-	
30	80	68	-							20	-	
40	107	78	17							20	-	
50	117	88	17							40	-	
80	147	118	17							40	-	
100	167	138	17							40	80	

∅ [mm]	Stroke [mm]	L12	L13	T1	T2	T3	T4	T5	T6	T7	≈C1	≈C2
12	10	11.4	5	9	9.4	2.1	8	1.2	1	8	10	10
	20											
	25											
	30											
	40											
	50											
	80											
100												
16	10	11.9	-	9	4.6	2.1	10	1.2	1	-	14	14
	20											
	25											
	30											
	40											
	50											
	80											
100												

Guided drives DFM

Technical data

FESTO

Dimensions

Piston \varnothing 20 ... 25 mm

Download CAD Data → www.festo.com/us/cad

First-angle projection

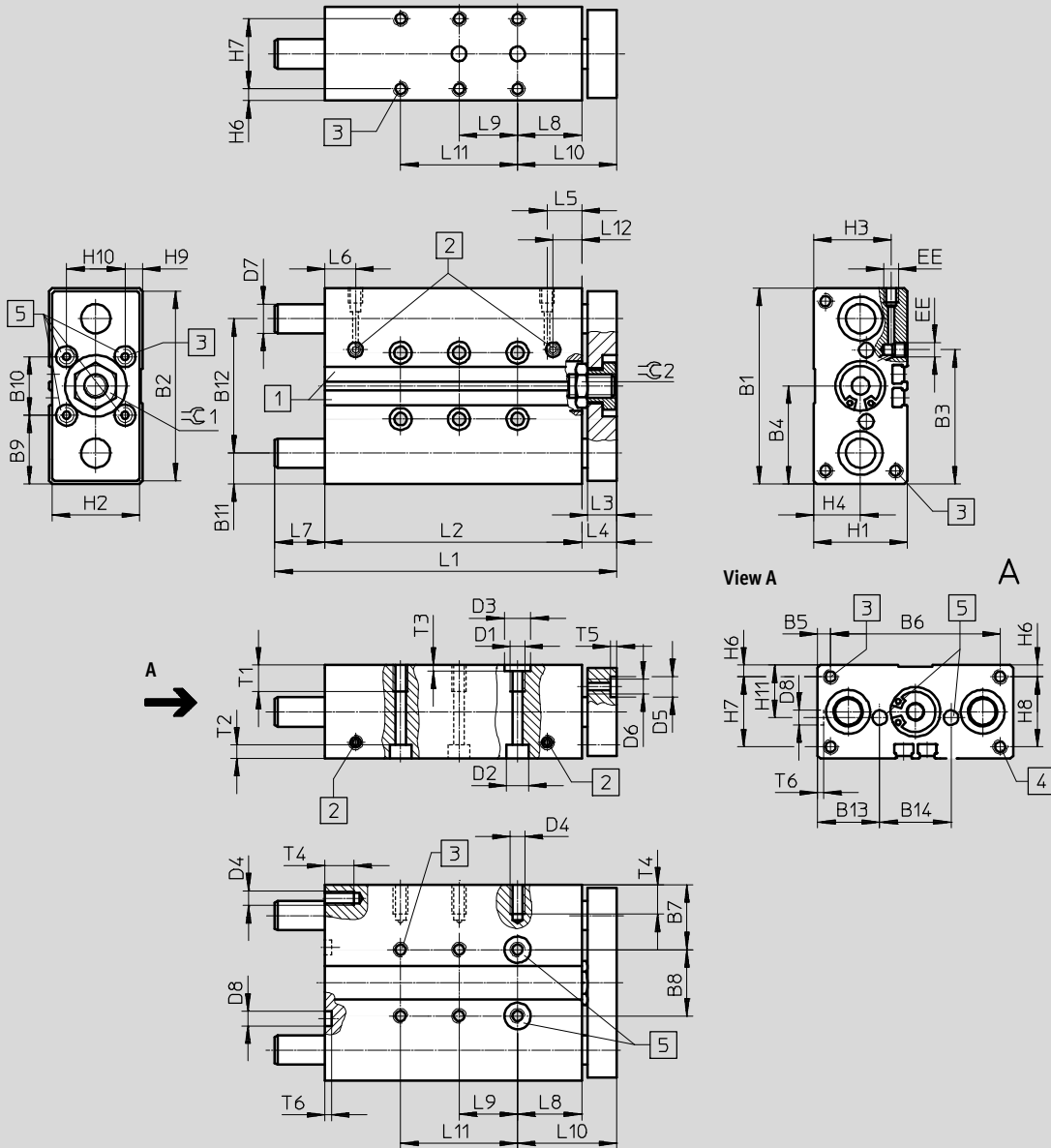
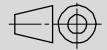

1 Mounting slot for proximity sensor SME-/SMT-8

2 Supply port optionally at side or top

3 Mounting thread
4 Mounting thread (not with \varnothing 20)

5 Tolerance between centring holes ± 0.02 mm

Note

If the guide rods project beyond the housing when the unit is in its retracted end position (→ dimension L7), a recess must be provided in the

mounting surface if the unit is to be mounted against a surface in order to allow the guide rods to move freely.

Guided drives DFM

Technical data



∅ [mm]	B1	B2	B3	B4	B5	B6	B7	B8	B9	B10	B11	B12	B13	B14	D1	D2 ∅	D3 ∅ H7	D4
20	83	81	53.6	41.5	6.5	70	26.5	30	26.5	30	12.5	58	26	31	M6	9	9	M5
25	95	93	70	47.5	15.5	64	30	35	27.5	40	13.5	68	29	37	M6	9	9	M6

∅ [mm]	D5 ∅ H7	D6	D7 ∅		D8 ∅ H7	EE	H1	H2	H3	H4	H6	H7	H8	H9	H10	H11
			GF	KF												
20	9	M5	14h8	12h6	7	M5	36	34	29.5	17	4.5	27	-	7	20	18
25	9	M6	16h8	14h6	7	G1/8	44	42	34.8	19	4.5	35	35	12	20	22

∅ [mm]	Stroke [mm]	L1	L2	L3	L4	L5	L6	L7	L8	L9	L10 ±0.1	L11
25	25	80	66	-	20	-						
30	30	85	71	-	20	-						
40	40	121	81	26	20	-						
50	50	131	91	26	40	-						
80	80	161	121	26	40	-						
100	100	181	141	26	40	80						
25	20	93	65.6	12	14	17.5	9.5	26	26	13.4	-	-
25	25	98	70.6							13.4	20	-
30	30	103	75.6							13.4	20	-
40	40	123	85.6							23.4	20	-
50	50	133	95.6							23.4	40	-
80	80	163	125.6							23.4	40	-
100	100	183	145.6							23.4	40	80

∅ [mm]	Stroke [mm]	L12	T1	T2	T3	T4	T5	T6	≈C1	≈C2
20	20	14	12	5.7	2.1	10	2.1	1.6	17	17
	25									
	30									
	40									
	50									
	80									
25	20	15	14	5.7	2.1	12	2.1	1.6	17	17
	25									
	30									
	40									
	50									
	80									

Note: This product conforms to ISO 1179-1 and ISO 228-1

Guided drives DFM

Technical data

Dimensions

Piston \varnothing 32 ... 63 mm

Download CAD Data → www.festo.com/us/cad

First-angle projection

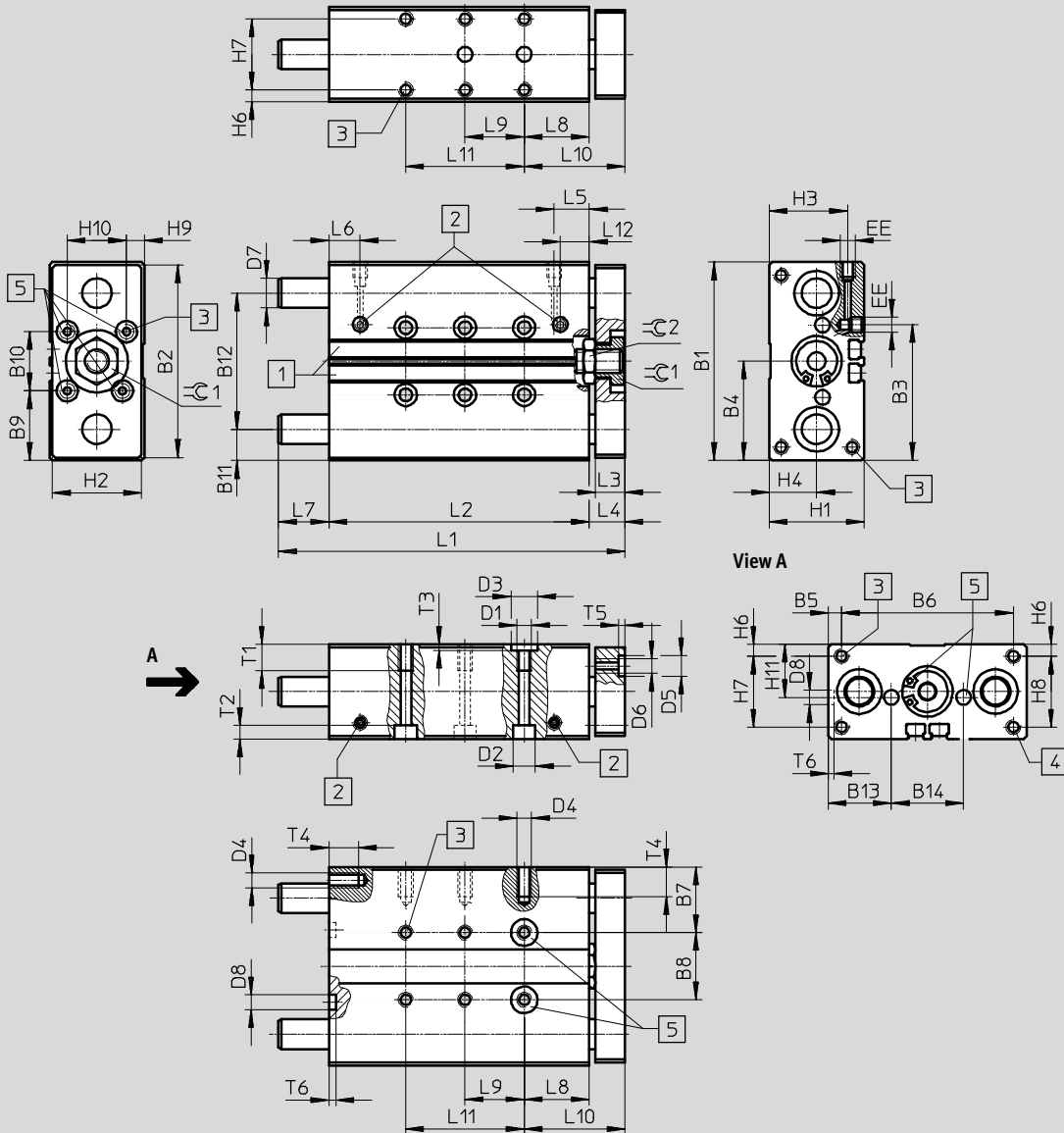
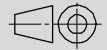

- 1 Mounting slot for proximity sensor SME-/SMT-8
- 2 Supply port optionally at side or top
- 3 Mounting thread
- 4 Mounting thread
- 5 Tolerance between centring holes ± 0.02 mm

Note

Since the guide rods project beyond the housing when the unit is in its retracted end position (→ dimension L7), a recess must be provided in the

mounting surface if the unit is to be mounted against a surface in order to allow the guide rods to move freely.

Guided drives DFM

Technical data

∅ [mm]	B1	B2	B3	B4	B5	B6	B7	B8	B9	B10	B11	B12	B13	B14	D1	D2 ∅	D3 ∅ H7	D4
32	110	108	81	55	20	70	33.5	43	35	40	16	78	32.5	45	M8	11	12	M6
40	120	118	94	60	15	90	34.5	51	35	50	16	88	32.5	55	M8	11	12	M8
50	148	146	116.5	74	19	110	42	64	44	60	19	110	40	68	M8	11	12	M8
63	162	160	139	81	9	144	41	80	41	80	18.4	125	39.5	83	M10	15	12	M10

∅ [mm]	D5 ∅ H7	D6	D7 ∅		D8 ∅ H7	EE	H1	H2	H3	H4	H5	H6	H7	H8	H9	H10	H11
			GF	KF													
32	9	M6	20h8	16h6	9	G $\frac{1}{8}$	49	47	38.5	22	23.5	6	37	37	8.5	30	24.5
40	9	M6	20h8	16h6	9	G $\frac{1}{8}$	54	52	40.5	24	25	6	42	42	10	30	27
50	12	M8	25h8	20h6	12	G $\frac{1}{4}$	64	62	50.5	29.5	29.7	7	50	50	12	40	32
63	12	M8	25h8	20h6	12	G $\frac{1}{4}$	78	76	55	32	36.8	9	60	60	19	40	39

∅ [mm]	Stroke [mm]	L1	L2	L3	L4	L5	L6	L7	L8	L9	L10 ±0.1	L11	L12	T1	T2	T3	T4	T5	T6	=C1	=C2
25	106	73	17	20	-																
30	111	78	17	20	-																
40	121	88	17	20	-																
50	131	98	17	40	-																
80	179	128	35	40	-																
100	199	148	35	40	80																
125	244	173	55	40	80																
160	279	208	55	40	120																
200	319	248	55	40	160																
40	25	106	76	14	16	17.8	13.1	14	29	20	45	-	17.8	15	6.8	2.6	16	2.1	2.1	17	22
50	131	101	14					40		-											
80	179	131	32					40		-											
100	199	151	32					40		80											
125	244	176	52					40		80											
160	279	211	52					40		120											
200	319	251	52					40		160											
50	25	118	77	16	18	17.8	14.2	23	32	20	50	-	17.8	15	6.8	2.6	16	2.6	2.6	19	24
50	143	102	23					40		-											
80	194	132	44					40		-											
100	214	152	44					40		80											
125	259	177	64					40		80											
160	294	212	64					40		120											
200	334	252	64					40		160											
63	25	118	83	16	18	18.5	14.8	17	32	20	50	-	18.5	20	9	2.6	20	2.6	2.6	19	24
50	143	108	17					40		-											
80	194	138	38					40		80											
100	214	158	38					40		80											
125	259	183	58					40		120											
160	294	218	58					40		160											
200	334	258	58					40		200											

Note: This product conforms to ISO 1179-1 and ISO 228-1

Guided drives DFM

Technical data

∅	B1	B2	B3	B4	B5	B6	B7	B8	B9	B10	B11	B12	B13	B14	D1	D2	D3
[mm]																∅	∅
80	200	192	162.5	100	21.5	157	48.5	103	41	110	22.5	155	48.5	103	M10	15	12
100	240	232	201	120	21	198	54	132	56	120	26	188	57	126	M12	18	15

∅	D4	D5	D6	D7		D8	EE	H1	H2	H3	H4	H6	H7	H8	H9	H10
				∅												
[mm]		∅		GF	KF	∅										
80	M10	12	M10	30h8	25h6	12	G $\frac{3}{8}$	92	84	61	35	9	62	40	16	60
100	M12	15	M12	35h8	30h6	15	G $\frac{3}{8}$	112	104	66	39.5	10	68	44	16	80

∅	Stroke	L1	L2	L3	L4	L5	L6	L7	L8	L9	L10	L11	L12	T1	T2	T3	T4	T5	T6	≙C1	≙C2
[mm]	[mm]										±0.1										
80	25	137	93	20	23	23	16	21	41	20	64	-	23	20	9	2.6	20	2.6	2.6	27	30
	50	183	118					42		40		-									
	80	243	148					72		40		-									
	100	263	168					72		40		80									
	125	288	193					72		40		120									
	160	323	228					72		40		160									
	200	363	268					72		40											
100	25	150	109	20	23	29	20	18	13	40	36	-	29	25	11	3.1	24	3.1	3.1	32	30
	50	197	134					40		40		80									
	80	257	164					70		40		80									
	100	277	184					70		40		120									
	125	302	209					70		40		160									
	160	337	244					70		40		160									
	200	377	284					70		40		200									

Note: This product conforms to ISO 1179-1 and ISO 228-1

Guided drives DFM

Technical data

Ordering data – Plain-bearing guide GF						
Stroke [mm]	Part No.	Type	Part No.	Type	Part No.	Type
	Piston Ø 12 mm		Piston Ø 16 mm		Piston Ø 20 mm	
10	170 824	DFM-12-10-P-A-GF	170 832	DFM-16-10-P-A-GF	–	–
20	170 825	DFM-12-20-P-A-GF	170 833	DFM-16-20-P-A-GF	170 840	DFM-20-20-P-A-GF
25	170 826	DFM-12-25-P-A-GF	170 834	DFM-16-25-P-A-GF	170 841	DFM-20-25-P-A-GF
30	170 827	DFM-12-30-P-A-GF	170 835	DFM-16-30-P-A-GF	170 842	DFM-20-30-P-A-GF
40	170 828	DFM-12-40-P-A-GF	170 836	DFM-16-40-P-A-GF	170 843	DFM-20-40-P-A-GF
50	170 829	DFM-12-50-P-A-GF	170 837	DFM-16-50-P-A-GF	170 844	DFM-20-50-P-A-GF
80	170 830	DFM-12-80-P-A-GF	170 838	DFM-16-80-P-A-GF	170 845	DFM-20-80-P-A-GF
100	170 831	DFM-12-100-P-A-GF	170 839	DFM-16-100-P-A-GF	170 846	DFM-20-100-P-A-GF
125	–	–	–	–	–	–
160	–	–	–	–	–	–
200	–	–	–	–	–	–
	Piston Ø 25 mm		Piston Ø 32 mm		Piston Ø 40 mm	
10	–	–	–	–	–	–
20	170 847	DFM-25-20-P-A-GF	170 854	DFM-32-20-P-A-GF	–	–
25	170 848	DFM-25-25-P-A-GF	170 855	DFM-32-25-P-A-GF	170 864	DFM-40-25-P-A-GF
30	170 849	DFM-25-30-P-A-GF	170 856	DFM-32-30-P-A-GF	–	–
40	170 850	DFM-25-40-P-A-GF	170 857	DFM-32-40-P-A-GF	–	–
50	170 851	DFM-25-50-P-A-GF	170 858	DFM-32-50-P-A-GF	170 865	DFM-40-50-P-A-GF
80	170 852	DFM-25-80-P-A-GF	170 859	DFM-32-80-P-A-GF	170 866	DFM-40-80-P-A-GF
100	170 853	DFM-25-100-P-A-GF	170 860	DFM-32-100-P-A-GF	170 867	DFM-40-100-P-A-GF
125	–	–	170 861	DFM-32-125-P-A-GF	170 868	DFM-40-125-P-A-GF
160	–	–	170 862	DFM-32-160-P-A-GF	170 869	DFM-40-160-P-A-GF
200	–	–	170 863	DFM-32-200-P-A-GF	170 870	DFM-40-200-P-A-GF
	Piston Ø 50 mm		Piston Ø 63 mm		Piston Ø 80 mm	
10	–	–	–	–	–	–
20	–	–	–	–	–	–
25	170 871	DFM-50-25-P-A-GF	170 878	DFM-63-25-P-A-GF	170 885	DFM-80-25-P-A-GF
30	–	–	–	–	–	–
40	–	–	–	–	–	–
50	170 872	DFM-50-50-P-A-GF	170 879	DFM-63-50-P-A-GF	170 886	DFM-80-50-P-A-GF
80	170 873	DFM-50-80-P-A-GF	170 880	DFM-63-80-P-A-GF	170 887	DFM-80-80-P-A-GF
100	170 874	DFM-50-100-P-A-GF	170 881	DFM-63-100-P-A-GF	170 888	DFM-80-100-P-A-GF
125	170 875	DFM-50-125-P-A-GF	170 882	DFM-63-125-P-A-GF	170 889	DFM-80-125-P-A-GF
160	170 876	DFM-50-160-P-A-GF	170 883	DFM-63-160-P-A-GF	170 890	DFM-80-160-P-A-GF
200	170 877	DFM-50-200-P-A-GF	170 884	DFM-63-200-P-A-GF	170 891	DFM-80-200-P-A-GF
	Piston Ø 100 mm					
10	–	–				
20	–	–				
25	170 892	DFM-100-25-P-A-GF				
30	–	–				
40	–	–				
50	170 893	DFM-100-50-P-A-GF				
80	170 894	DFM-100-80-P-A-GF				
100	170 895	DFM-100-100-P-A-GF				
125	170 896	DFM-100-125-P-A-GF				
160	170 897	DFM-100-160-P-A-GF				
200	170 898	DFM-100-200-P-A-GF				

Guided drives DFM

Technical data

Ordering data – Recirculating ball bearing guide KF						
Stroke [mm]	Part No.	Type	Part No.	Type	Part No.	Type
	Piston Ø 12 mm		Piston Ø 16 mm		Piston Ø 20 mm	
10	170 899	DFM-12-10-P-A-KF	170 907	DFM-16-10-P-A-KF	–	–
20	170 900	DFM-12-20-P-A-KF	170 908	DFM-16-20-P-A-KF	170 915	DFM-20-20-P-A-KF
25	170 901	DFM-12-25-P-A-KF	170 909	DFM-16-25-P-A-KF	170 916	DFM-20-25-P-A-KF
30	170 902	DFM-12-30-P-A-KF	170 910	DFM-16-30-P-A-KF	170 917	DFM-20-30-P-A-KF
40	170 903	DFM-12-40-P-A-KF	170 911	DFM-16-40-P-A-KF	170 918	DFM-20-40-P-A-KF
50	170 904	DFM-12-50-P-A-KF	170 912	DFM-16-50-P-A-KF	170 919	DFM-20-50-P-A-KF
80	170 905	DFM-12-80-P-A-KF	170 913	DFM-16-80-P-A-KF	170 920	DFM-20-80-P-A-KF
100	170 906	DFM-12-100-P-A-KF	170 914	DFM-16-100-P-A-KF	170 921	DFM-20-100-P-A-KF
125	–	–	–	–	–	–
160	–	–	–	–	–	–
200	–	–	–	–	–	–
	Piston Ø 25 mm		Piston Ø 32 mm		Piston Ø 40 mm	
10	–	–	–	–	–	–
20	170 922	DFM-25-20-P-A-KF	170 929	DFM-32-20-P-A-KF	–	–
25	170 923	DFM-25-25-P-A-KF	170 930	DFM-32-25-P-A-KF	170 939	DFM-40-25-P-A-KF
30	170 924	DFM-25-30-P-A-KF	170 931	DFM-32-30-P-A-KF	–	–
40	170 925	DFM-25-40-P-A-KF	170 932	DFM-32-40-P-A-KF	–	–
50	170 926	DFM-25-50-P-A-KF	170 933	DFM-32-50-P-A-KF	170 940	DFM-40-50-P-A-KF
80	170 927	DFM-25-80-P-A-KF	170 934	DFM-32-80-P-A-KF	170 941	DFM-40-80-P-A-KF
100	170 928	DFM-25-100-P-A-KF	170 935	DFM-32-100-P-A-KF	170 942	DFM-40-100-P-A-KF
125	–	–	170 936	DFM-32-125-P-A-KF	170 943	DFM-40-125-P-A-KF
160	–	–	170 937	DFM-32-160-P-A-KF	170 944	DFM-40-160-P-A-KF
200	–	–	170 938	DFM-32-200-P-A-KF	170 945	DFM-40-200-P-A-KF
	Piston Ø 50 mm		Piston Ø 63 mm		Piston Ø 80 mm	
10	–	–	–	–	–	–
20	–	–	–	–	–	–
25	170 946	DFM-50-25-P-A-KF	170 953	DFM-63-25-P-A-KF	170 960	DFM-80-25-P-A-KF
30	–	–	–	–	–	–
40	–	–	–	–	–	–
50	170 947	DFM-50-50-P-A-KF	170 954	DFM-63-50-P-A-KF	170 961	DFM-80-50-P-A-KF
80	170 948	DFM-50-80-P-A-KF	170 955	DFM-63-80-P-A-KF	170 962	DFM-80-80-P-A-KF
100	170 949	DFM-50-100-P-A-KF	170 956	DFM-63-100-P-A-KF	170 963	DFM-80-100-P-A-KF
125	170 950	DFM-50-125-P-A-KF	170 957	DFM-63-125-P-A-KF	170 964	DFM-80-125-P-A-KF
160	170 951	DFM-50-160-P-A-KF	170 958	DFM-63-160-P-A-KF	170 965	DFM-80-160-P-A-KF
200	170 952	DFM-50-200-P-A-KF	170 959	DFM-63-200-P-A-KF	170 966	DFM-80-200-P-A-KF
	Piston Ø 100 mm					
10	–	–				
20	–	–				
25	170 967	DFM-100-25-P-A-KF				
30	–	–				
40	–	–				
50	170 968	DFM-100-50-P-A-KF				
80	170 969	DFM-100-80-P-A-KF				
100	170 970	DFM-100-100-P-A-KF				
125	170 971	DFM-100-125-P-A-KF				
160	170 972	DFM-100-160-P-A-KF				
200	170 973	DFM-100-200-P-A-KF				

Guided drives DFM-B

Peripherals overview

FESTO

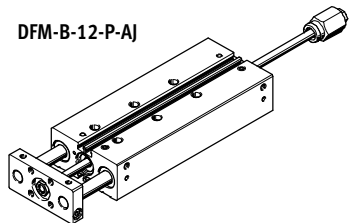
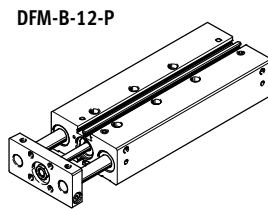
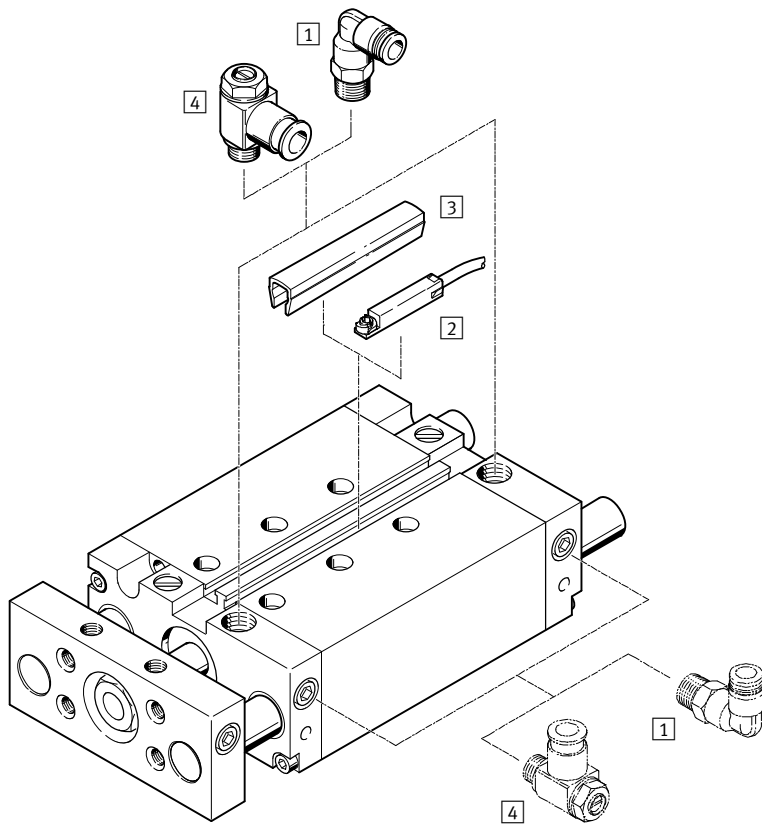

Variants

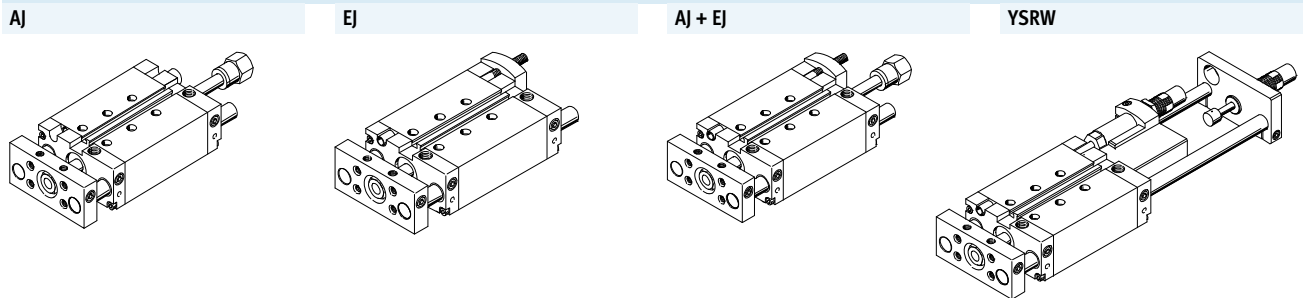

Accessories

	Brief description	→ Page/Internet
1 Push-in fitting QS	For connecting compressed air tubing with standard O.D.	quick star
2 Proximity sensor SME-/SMT-8/10	Can be integrated in the profile barrel	61
3 Slot cover ABP-5-S	To protect the sensor cable and keep dirt out of the sensor slots	62
4 One-way flow control valve GRLA	To regulate speed	62
- Centring sleeves ZBH	4 or 6 pieces included in scope of delivery	60

Note

The proximity sensors SM...0-8E cannot be used with the DFM-B.

Guided drives DFM-B

Type codes

DFM - 50 - 80 - B - P - A - GF - S6 - AJ - ZUB - 10S - G

Type

DFM	Guided drive
-----	--------------

Piston Ø [mm]

Stroke [mm]

Generation

B	Series
---	--------

Cushioning

P	Flexible cushioning rings/plates at both ends
PPV	Pneumatic cushioning adjustable at both ends
YSRW	Self-adjusting at both ends

Position sensing

A	For proximity sensing
---	-----------------------

Guide

GF	Plain-bearing guide
KF	Recirculating ball bearing guide

Variant

S6	Heat-resistant seals up to max. 120 °C
----	--

Precision adjustment

AJ	Advanced end position
EJ	Retracted end position

Accessories

ZUB	Supplied separately
-----	---------------------

Slot cover

...S	Sensor slot
------	-------------

Proximity sensor

...G	With cable, 2.5 m
...I	Contactless with cable, 2.5 m

Guided drives DFM-B

Technical data

FESTO

Function

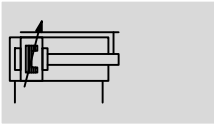
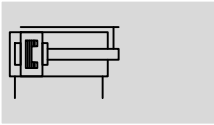

- N- Diameter
12 ... 63 mm
- T- Stroke length
10 ... 400 mm

www.festo.com/en/Spare_parts_service

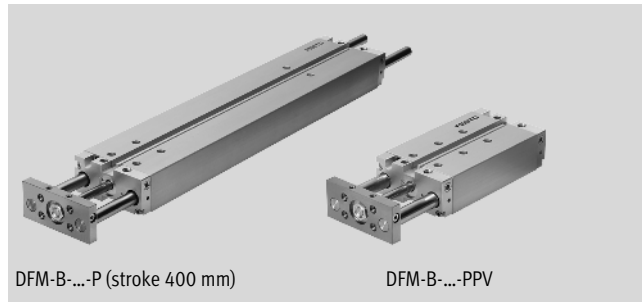

DFM-B-...-P (stroke 400 mm)

DFM-B-...-PPV

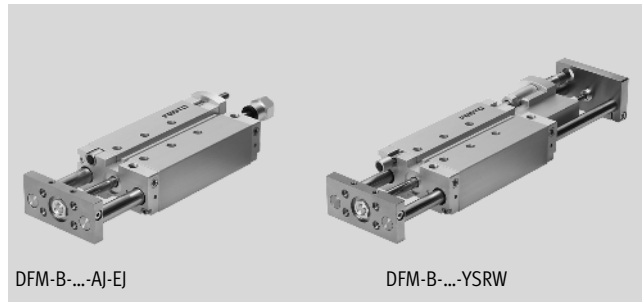

DFM-B-...-AJ-EJ

DFM-B-...-YSRW

General technical data								
Piston Ø	12	16	20	25	32	40	50	63
Pneumatic connection	M5	M5	M5	G $\frac{1}{8}$	G $\frac{1}{8}$	G $\frac{1}{8}$	G $\frac{1}{4}$	G $\frac{1}{4}$
Operating medium	Compressed air in accordance with ISO 8573-1:2010 [7:4:4]							
Note on operating/pilot medium	Operation with lubricated medium possible (in which case lubricated operation will always be required)							
Operating pressure [bar]	2 ... 10	2 ... 10	2 ... 10	1.5 ... 10	1.5 ... 10	1.5 ... 10	1 ... 10	1 ... 10
Design	Piston							
	Piston rod							
	Guide rods with yoke							
Cushioning	Flexible cushioning rings/plates at both ends							
	-	Pneumatic cushioning adjustable at both ends						
	-	-	Self-adjusting at both ends					
Cushioning length (PPV) [mm]	-	12	15	15	16	17	19	19
Position sensing	For proximity sensing							
Type of mounting	Via through-holes							
	Via female threads							
Assembly position	Any							
Protection against torsion/guide	Guide rod with yoke/with plain-bearing or ball bearing guide							
Variant AJ, EJ and YSRW								
Setting range [mm]	0 ... 10							
Variant YSRW with shock absorber								
Repetition accuracy [mm]	-	-	Max. 0.05					

Note: This product conforms to ISO 1179-1 and ISO 228-1

Guided drives DFM-B

Technical data

Ambient conditions				
	Plain-bearing guide GF	Recirculating ball bearing guide KF	Variant YSRW with shock absorber	S6
Ambient temperature ¹⁾ [°C]	-20 ... +80	-5 ... +60	0 ... +60	0 ... +120
Corrosion resistance class CRC ²⁾	2	-	-	2
ATEX	Specified types → www.festo.com			

1) Note operating range of proximity sensors

2) Corrosion resistance class 1 according to Festo standard 940 070

Components requiring low corrosion resistance. Transport and storage protection. Parts that do not have primarily decorative surface requirements, e.g. in internal areas that are not visible or behind covers

Corrosion resistance class 2 according to Festo standard 940 070

Components requiring moderate corrosion resistance. Externally visible parts with primarily decorative surface requirements which are in direct contact with a normal industrial environment or media such as coolants or lubricating agents

Speeds [m/s]								
Piston Ø	12	16	20	25	32	40	50	63
Cushioning P, precision stroke adjustment AJ and E]								
Maximum speed advancing, retracting	0.8	0.8	0.8	0.8	0.8	0.8	0.6	0.6
Cushioning P, plain-bearing guide GF in combination with S6								
Maximum speed advancing, retracting	0.5	0.5	0.5	0.5	0.5	0.5	0.4	0.4
Cushioning PPV, YSRW, PPV S6								
Maximum speed advancing, retracting	-	1.5	1.5	1.5	1.5	1.5	1	1

Forces [N]								
Piston Ø	12	16	20	25	32	40	50	63
Cushioning P, PPV, YSRW, precision stroke adjustment E]								
Theoretical force at 6 bar, advancing	68	121	188	295	482	754	1178	1870
Theoretical force at 6 bar, retracting	51	90	141	247	415	686	1057	1750
Precision stroke adjustment AJ and AJ+E]								
Theoretical force at 6 bar, advancing	51	90	141	247	415	686	1057	1750
Theoretical force at 6 bar, retracting	51	90	141	247	415	686	1057	1750

Guided drives DFM-B

Technical data

Impact energy [J]								
Piston Ø	12	16	20	25	32	40	50	63
Cushioning P								
Max. impact energy at the end positions	0.09	0.15	0.2	0.35	0.40	0.7	1.0	1.3
Max. impact energy at the end positions S6	0.035	0.075	0.1	0.15	0.2	0.35	0.5	0.65
Cushioning YSRW								
Max. energy absorption per stroke	–	–	4	8	12	35	35	70
Max. energy absorption per hour	–	–	21000	30000	41000	68000	68000	100000

Permissible impact velocity:
$$v_{perm.} = \sqrt{\frac{2 \times E_{perm.}}{m_{dead} + m_{load}}}$$

$v_{perm.}$ Permissible impact velocity
 $E_{perm.}$ Max. impact energy
 m_{dead} Moving load (drive)
 m_{load} Moving work load

Note
 These specifications represent the maximum values which can be reached. Note the maximum permitted impact energy.

Maximum permissible load:
$$m_{load} = \frac{2 \times E_{perm.}}{v^2} - m_{dead}$$

DFM-B with plain-bearing guide GF, cushioning P, PPV								
Stroke [mm]	Piston Ø [mm]							
	12	16	20	25	32	40	50	63
Product weight [g]								
10	385	621	–	–	–	–	–	–
20	432	680	1026	1474	2163	–	–	–
25	452	706	1068	1530	2238	2606	4290	5568
30	476	736	1109	1586	2337	–	–	–
40	523	795	1215	1726	2489	–	–	–
50	570	854	1298	1838	2640	3047	5019	6457
80	712	1033	1572	2218	3210	3663	5909	7503
100	803	1148	1733	2435	3502	3981	6376	8116
125	962	1352	2000	2800	4018	4534	7151	9050
160	1128	1560	2293	3193	4549	5118	8017	10137
200	1318	1797	2628	3642	5158	5786	9007	11379
250	–	–	3237	4430	6259	6962	10813	13509
320	–	–	3823	5215	7322	8129	12545	15682
400	–	–	4493	6113	8537	9462	14525	18165
Moving load [g]								
10	201	283	–	–	–	–	–	–
20	216	302	506	715	1147	–	–	–
25	223	312	520	734	1176	1305	2217	2640
30	230	322	534	753	1230	–	–	–
40	245	342	586	823	1289	–	–	–
50	260	362	615	861	1347	1476	2567	2990
80	304	423	724	1022	1644	1776	3002	3426
100	333	463	781	1098	1764	1893	3189	3613
125	420	579	917	1289	2059	2188	3586	4009
160	472	649	1016	1422	2264	2393	3913	4336
200	530	730	1129	1573	2499	2627	4286	4710
250	–	–	1489	2017	3164	3293	5351	5774
320	–	–	1688	2283	3574	3703	6005	6428
400	–	–	1914	2587	4042	4171	6752	7176

Guided drives DFM-B

Technical data

DFM-B with plain-bearing guide GF, cushioning P, PPV, variant S6								
Stroke [mm]	Piston \varnothing [mm]							
	12	16	20	25	32	40	50	63
Product weight [g]								
0	283	488	745	1080	1594	1847	3124	3992
10	328	548	–	–	–	–	–	–
20	376	607	907	1298	1889	–	–	–
25	395	633	949	1354	1964	2257	3735	4762
30	419	663	990	1410	2063	–	–	–
40	466	722	1096	1550	2215	–	–	–
50	514	781	1179	1662	2366	2698	4464	5651
80	656	959	1452	2042	2936	3314	5354	6696
100	747	1074	1614	2259	3228	3632	5821	7310
125	905	1279	1880	2624	3745	4186	6596	8244
160	1072	1486	2173	3017	4276	4770	7462	9331
200	1261	1724	2508	3466	4884	5437	8452	10573
250	–	–	3118	4254	5985	6613	10258	12703
320	–	–	3704	5039	7048	7780	11990	14876
400	–	–	4374	5937	8264	9114	19970	17359
Moving load [g]								
0	130	188	329	463	755	810	1428	1601
10	145	208	–	–	–	–	–	–
20	159	229	386	539	873	–	–	–
25	167	239	400	558	902	956	1662	1834
30	174	249	414	577	956	–	–	–
40	188	269	467	647	1015	–	–	–
50	203	289	495	685	1073	1127	2012	2184
80	247	349	604	847	1373	1427	2447	2620
100	276	389	661	922	1490	1544	2634	2806
125	364	506	797	1113	1785	1840	3031	3203
160	415	576	896	1246	1990	2045	3358	3530
200	474	657	1010	1397	2225	2279	3731	3904
250	–	–	1370	1842	2890	2944	4796	4968
320	–	–	1568	2107	3300	3354	5450	5622
400	–	–	1794	2411	3768	3823	6197	6370

Guided drives DFM-B

Technical data

DFM-B with recirculating ball bearing guide KF, cushioning P, PPV								
Stroke [mm]	Piston Ø [mm]							
	12	16	20	25	32	40	50	63
Product weight [g]								
10	345	543	–	–	–	–	–	–
20	388	596	935	1395	1932	–	–	–
25	405	619	974	1447	1998	2366	3907	5185
30	427	647	1012	1499	2079	–	–	–
40	470	700	1105	1624	2213	–	–	–
50	513	754	1181	1729	2346	2753	4523	5961
80	641	916	1428	2074	2817	3270	5272	6865
100	723	1020	1577	2276	3073	3552	5682	7423
125	852	1190	1809	2599	3490	4006	6327	8226
160	1002	1378	2079	2966	3958	4526	7094	9214
200	1174	1593	2388	3384	4494	5121	7971	10343
250	–	–	2905	4073	5369	6072	9419	12115
320	–	–	3445	4805	6305	7112	10953	14091
400	–	–	4063	5642	7376	8301	12707	16347
Moving load [g]								
10	168	239	–	–	–	–	–	–
20	178	254	437	631	933	–	–	–
25	183	261	447	646	954	1082	1830	2254
30	188	268	458	661	990	–	–	–
40	198	283	498	716	1030	–	–	–
50	208	297	520	746	1071	1199	2067	2491
80	238	341	602	873	1271	1400	2361	2785
100	259	370	646	934	1352	1481	2492	2915
125	316	452	748	1083	1548	1677	2758	3182
160	352	503	824	1189	1690	1819	2986	3410
200	392	561	911	1310	1852	1981	3247	3671
250	–	–	1180	1656	2291	2420	3953	4377
320	–	–	1332	1868	2575	2703	4410	4833
400	–	–	1505	2111	2899	3027	4931	5355

Guided drives DFM-B

Technical data

Additional weights with precision stroke adjustment AJ – GF, KF

When using the precision stroke adjustment AJ, the following weight must be taken into account in addition to the load specified from page 32:

Product weight [g] precision stroke adjustment AJ (piston rod + stop)								
Stroke [mm]	Piston Ø [mm]							
	12	16	20	25	32	40	50	63
10	55.4	58.8	–	–	–	–	–	–
20	57.6	61	75.6	115.4	185.7	–	–	–
25	58.7	62.1	77.6	118.5	190.2	188.7	350.7	350.5
30	59.9	63.3	79.6	121.6	194.7	–	–	–
40	62.1	65.5	83.6	127.8	203.6	–	–	–
50	64.3	67.7	87.5	134	212.5	211	390.4	390.2
80	71	74.4	99.5	152.6	239.3	237.8	438	437.8
100	75.5	78.9	107.5	165	257.2	255.7	469.8	469.6
125	81.1	84.5	117.3	180.5	279.5	278	509.5	509.3
160	88.9	92.3	131.2	202.5	310.8	309.3	565.1	564.9
200	97.8	101.2	147.1	227	346.5	345	628.6	628.4
250	–	–	167	258.1	391.2	389.7	708.1	707.9
320	–	–	194.8	301.5	453.8	452.3	819.2	819
400	–	–	226.5	351.1	525.2	523.7	946.3	946.1

Moving load [g] precision stroke adjustment AJ (piston rod + stop)								
Stroke [mm]	Piston Ø [mm]							
	12	16	20	25	32	40	50	63
10	51.5	52.3	–	–	–	–	–	–
20	53.7	54.5	76	116.6	185.9	–	–	–
25	54.8	55.6	78	119.7	190.4	190	351.7	351.7
30	56	56.8	80	122.8	194.9	–	–	–
40	58.2	59	84	129	203.8	–	–	–
50	60.4	61.2	87.9	135.2	212.7	212.7	391.4	391.4
80	67.1	67.9	99.9	153.8	239.5	239.5	439	439
100	71.6	72.4	107.8	166.2	257.4	257.4	470.8	470.8
125	77.2	78	117.7	181.7	279.7	279.7	510.5	510.5
160	85	85.8	131.6	203.4	311	311	566.1	566.1
200	93.9	94.7	147.5	228.2	346.7	346.7	629.6	629.6
250	–	–	167.4	259.3	391.4	391.4	709.1	709.1
320	–	–	195.2	302.7	454	454	820.2	820.2
400	–	–	226.9	352.3	525.4	525.4	947.3	947.3

Guided drives DFM-B

Technical data

FESTO

Additional weights with precision stroke adjustment EJ – GF, KF

When using the precision stroke adjustment EJ, the following weight must be taken into account in addition to the load specified from page 32:

Product weight [g] precision stroke adjustment EJ (piston rod + stop)						
Stroke [mm]	Piston Ø [mm]					
	20	25	32	40	50	63
20	55.7	117.1	134.1	–	–	–
25	56.4	119.1	136.1	153.9	302.8	354
30	57.2	121	138	–	–	–
40	58.8	125	142	–	–	–
50	60.3	129	146	163.8	318.3	369.5
80	65	140.9	157.9	175.7	336.9	388.1
100	68.1	148.8	165.8	183.6	349.4	400.6
125	71.9	158.8	175.8	193.6	364.9	416.1
160	77.4	172.7	189.7	207.5	386.6	437.8
200	83.6	188.5	205.5	223.3	411.4	462.6
250	91.3	208.4	225.4	243.2	442.4	493.6
320	102.2	236.2	253.2	271	485.9	537.1
400	114.6	268	285	302.8	535.5	586.7

DFM-B with recirculating ball bearing guide KF, cushioning YSRW						
Stroke [mm]	Piston Ø [mm]					
	20	25	32	40	50	63
Product weight [g]						
20	1684	2641	3717	–	–	–
25	1733	2707	3801	4995	7594	10816
30	1780	2773	3884	–	–	–
40	1874	2903	4053	–	–	–
50	1970	3035	4222	5455	8275	11657
80	2257	3429	4720	5999	9092	12629
100	2444	3687	5047	6352	9614	13298
125	2677	4008	5458	6801	10294	14137
160	3015	4473	6050	7446	11255	15319
200	3401	5004	6728	8183	12354	16670
250	3855	5641	7545	9074	13700	18340
320	4530	6569	8730	10363	15623	20704
400	5302	7631	10085	11837	17821	23405
Moving load [g]						
20	874	1323	1933	–	–	–
25	894	1350	1969	2386	3735	4996
30	914	1378	2005	–	–	–
40	953	1432	2077	–	–	–
50	993	1487	2149	2566	4021	5282
80	1111	1650	2365	2782	4365	5625
100	1190	1759	2509	2926	4594	5855
125	1289	1896	2690	3106	4880	6141
160	1427	2087	2942	3359	5281	6542
200	1585	2305	3230	3647	5739	7000
250	1782	2578	3590	4007	6312	7572
320	2059	2959	4095	4512	7114	8374
400	2375	3396	4671	5088	8030	9290

Guided drives DFM-B

Technical data

Materials

Sectional view

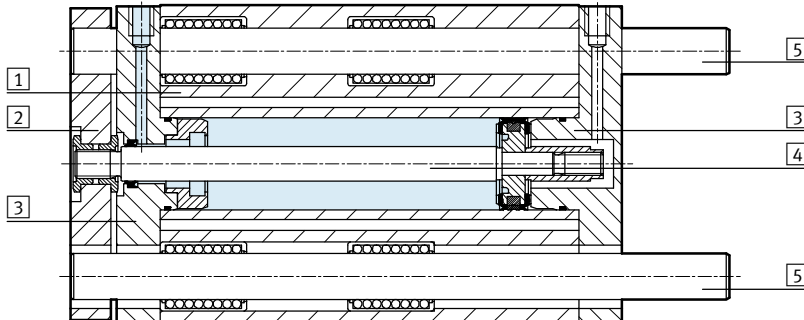

Variant	Plain-bearing guide GF	Recirculating ball bearing guide KF	S6
1 Housing	Wrought aluminium alloy, anodised	Wrought aluminium alloy, anodised	Wrought aluminium alloy, anodised
2 Yoke plate	Tempered steel	Tempered steel	Wrought aluminium alloy
3 Bearing and end caps	Wrought aluminium alloy, anodised	Wrought aluminium alloy, anodised	Wrought aluminium alloy, anodised
4 Piston rod	High-alloy stainless steel	High-alloy stainless steel	High-alloy stainless steel
5 Guide rods	High-alloy steel	Tempered steel	High-alloy steel
- Static seals	Nitrile rubber	Nitrile rubber	Fluoro rubber
- Dynamic seals	Polyurethane	Polyurethane	Fluoro rubber
Note on materials	RoHS compliant		

Maximum effective load F [N]

Plain-bearing guide GF and recirculating ball bearing guide KF

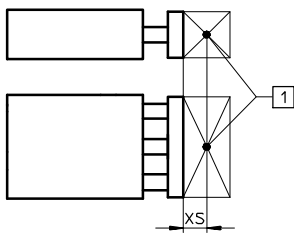

1 Centre of gravity of effective load

Piston Ø [mm]	XS [mm]	Stroke [mm]																
			10	20	25	30	40	50	80	100	125	160	200	250	320	400		
12	GF	25	53	47	45	43	39	36	28	25	23	20	15	-	-	-		
	KF		47	42	40	38	35	32	26	23	20	16	13	-	-	-		
16	GF	50	95	86	83	79	73	67	55	49	37	30	25	-	-	-		
	KF		75	69	66	64	58	56	51	48	30	21	17	-	-	-		
20	GF	50	-	99	96	92	110	103	86	77	71	63	55	47	41	35		
	KF		-	80	77	75	91	88	80	75	65	56	47	40	34	29		
25	GF	50	-	121	116	112	123	115	96	86	86	76	67	53	45	39		
	KF		-	88	86	84	100	97	89	85	80	66	56	46	38	32		
32	GF	50	-	188	180	173	161	150	166	150	168	146	127	106	91	78		
	KF		-	120	118	116	112	109	134	128	144	135	126	135	125	100		
40	GF	50	-	-	180	-	-	150	166	150	168	146	127	106	91	78		
	KF		-	-	118	-	-	109	134	128	144	135	126	135	125	100		
50	GF	50	-	-	257	-	-	216	234	212	229	200	174	145	124	105		
	KF		-	-	182	-	-	168	201	193	211	199	188	179	158	130		
63	GF	50	-	-	257	-	-	216	234	212	229	200	174	145	124	105		
	KF		-	-	182	-	-	168	201	193	211	199	188	179	158	130		

Note

GSED
sizing software
→ www.festo.com

Guided drives DFM-B

Technical data

Permissible torque load M [Nm]

Plain-bearing guide GF and recirculating ball bearing guide KF

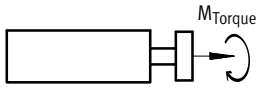

Piston Ø [mm]	Stroke [mm]	Stroke [mm]													
		10	20	25	30	40	50	80	100	125	160	200	250	320	400
12	GF	1.10	0.95	0.90	0.85	0.80	0.75	0.60	0.50	0.45	0.40	0.30	-	-	-
	KF	0.95	0.85	0.80	0.75	0.70	0.65	0.50	0.45	0.40	0.30	0.25	-	-	-
16	GF	2.20	2.00	1.90	1.80	1.70	1.50	1.30	1.10	0.85	0.70	0.60	-	-	-
	KF	1.70	1.60	1.50	1.45	1.35	1.30	1.20	1.10	0.70	0.50	0.40	-	-	-
20	GF	-	2.90	2.80	2.70	3.20	3.00	2.50	2.20	2.10	1.80	1.60	1.40	1.20	1.00
	KF	-	2.30	2.20	2.15	2.60	2.55	2.30	2.20	1.90	1.60	1.40	1.20	1.00	0.85
25	GF	-	4.15	3.95	3.80	4.20	3.90	3.25	2.90	2.90	2.60	2.30	1.80	1.50	1.30
	KF	-	3.00	2.92	2.85	3.40	3.30	3.02	2.89	2.70	2.20	1.90	1.50	1.30	1.10
32	GF	-	7.30	7.00	6.70	6.20	5.80	6.40	5.80	6.50	5.70	5.00	4.10	3.50	3.00
	KF	-	4.70	4.60	4.55	4.40	4.25	5.25	5.00	5.60	5.25	4.90	5.20	4.80	3.90
40	GF	-	-	7.90	-	-	6.55	7.25	6.55	7.35	6.40	5.55	4.60	4.0	3.40
	KF	-	-	5.20	-	-	4.80	5.90	5.65	6.35	5.95	5.55	5.95	5.50	4.40
50	GF	-	-	14.15	-	-	11.85	12.85	11.65	12.55	11.00	9.60	7.98	6.82	5.78
	KF	-	-	10.00	-	-	9.30	11.00	10.6	11.60	11.00	10.30	9.82	8.67	7.17
63	GF	-	-	15.90	-	-	13.30	14.45	13.10	14.10	12.30	10.70	9.06	7.75	6.56
	KF	-	-	11.30	-	-	10.50	12.50	12.00	13.20	12.40	11.70	11.16	9.85	8.15

Torsional backlash p

Plain-bearing guide GF and recirculating ball bearing guide KF in retracted state, without load

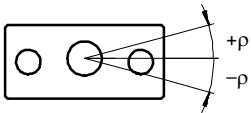

Piston Ø		12	16	20	25	32	40	50	63
Torsional backlash [°]	GF	0.09	0.09	0.07	0.07	0.06	0.06	0.05	0.05
	KF	0.08	0.08	0.07	0.07	0.05	0.05	0.05	0.05

Guided drives DFM-B

Technical data

Deflection of piston rod

Mean deflection f_1 due to bearing backlash as a function of the stroke l

DFM-GF with 2 bearings per guide rod

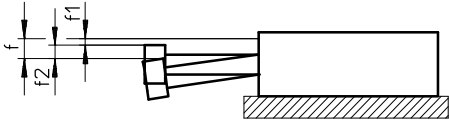

$$f = f_1 + f_2$$

f = Total deflection of piston rod

f_1 = Deflection due to bearing backlash

f_2 = Deflection due to lateral force

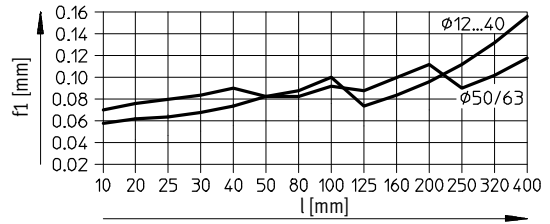

Deflection f_2 due to lateral force F as a function of the stroke with plain-bearing guide GF

Stroke 50 mm

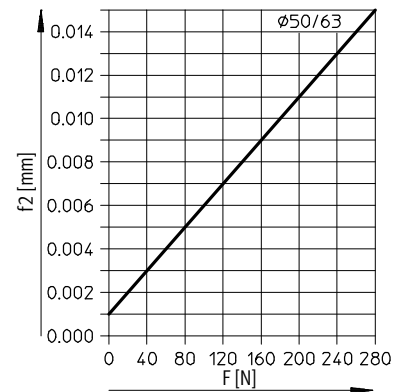
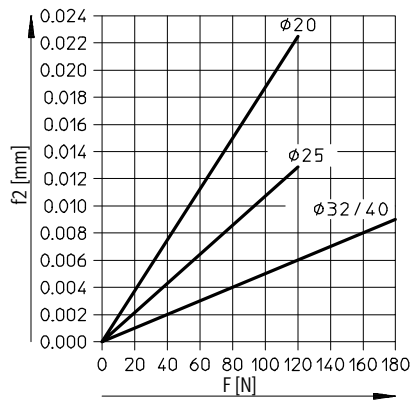
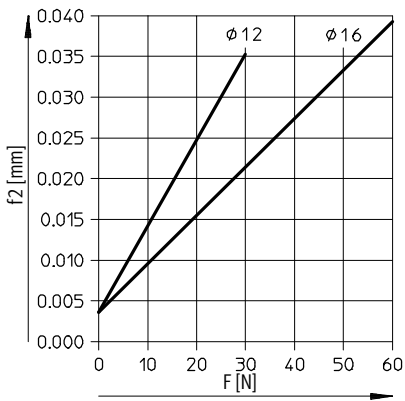

Stroke 100 mm

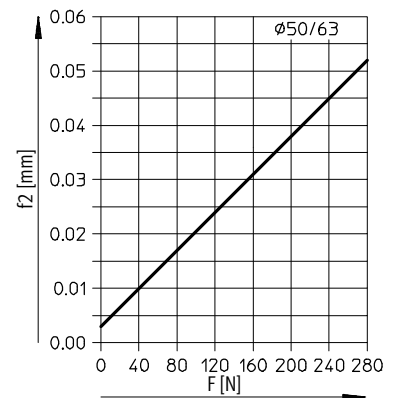
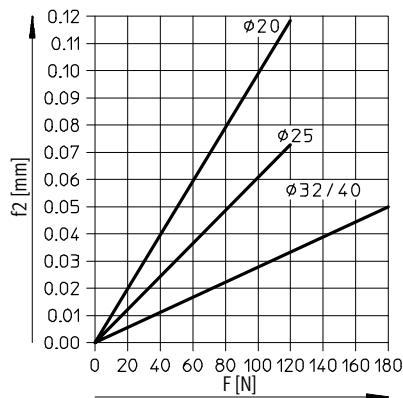
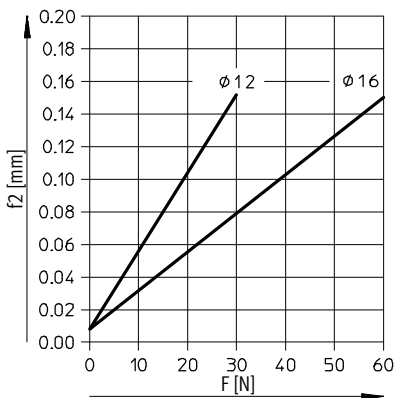

Guided drives DFM-B

Technical data



Deflection of piston rod

Mean deflection f_1 due to bearing backlash as a function of the stroke l

DFM-GF with 2 bearings per guide rod

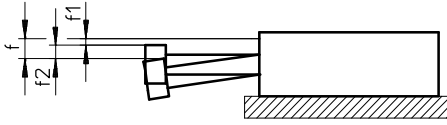

$$f = f_1 + f_2$$

f = Total deflection of piston rod

f_1 = Deflection due to bearing backlash

f_2 = Deflection due to lateral force

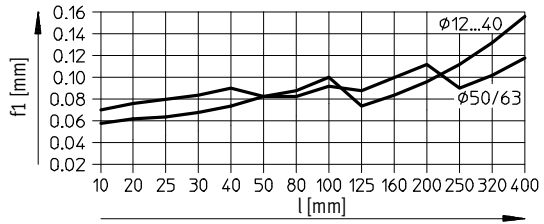

Deflection f_2 due to lateral force F as a function of the stroke with plain-bearing guide GF

Stroke 200 mm

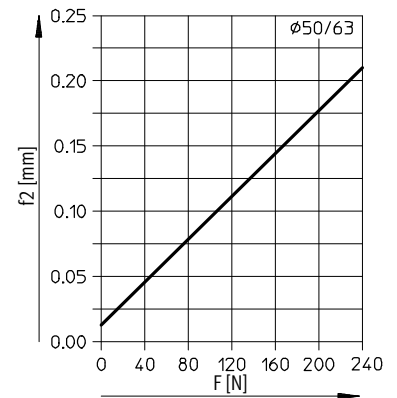
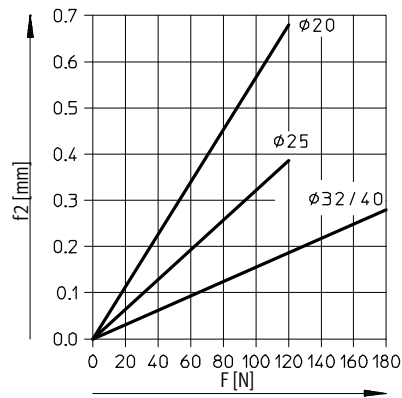
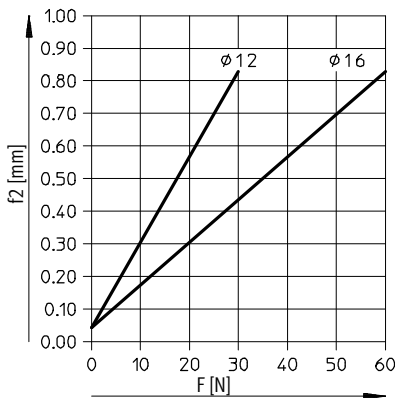

Stroke 400 mm

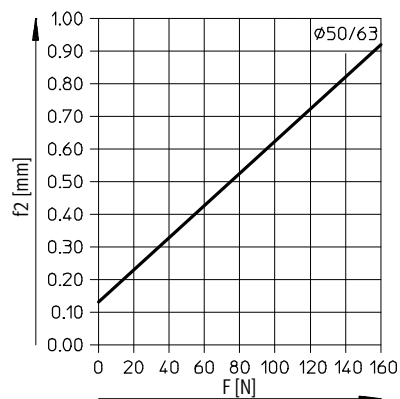
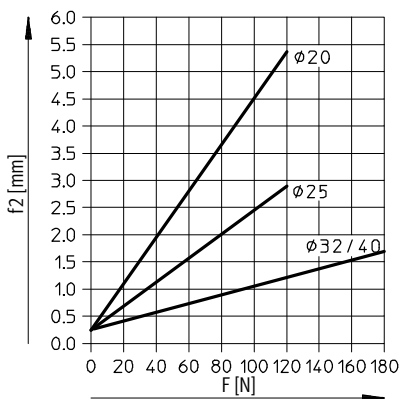

Guided drives DFM-B

Technical data

Deflection of piston rod

Mean deflection f_1 due to bearing backlash as a function of the stroke l

DFM-KF with 2 bearings per guide rod

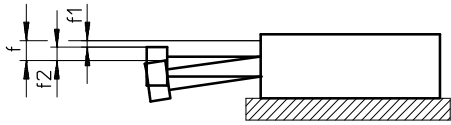

$$f = f_1 + f_2$$

f = Total deflection of piston rod

f_1 = Deflection due to bearing backlash

f_2 = Deflection due to lateral force

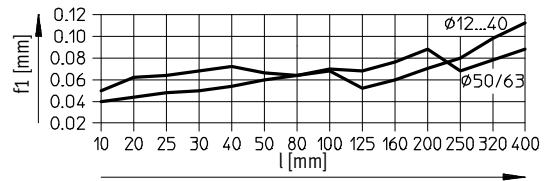

Deflection f_2 due to lateral force F as a function of the stroke with recirculating ball bearing guide KF

Stroke 50 mm

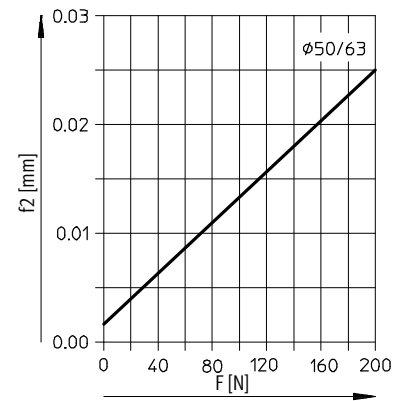
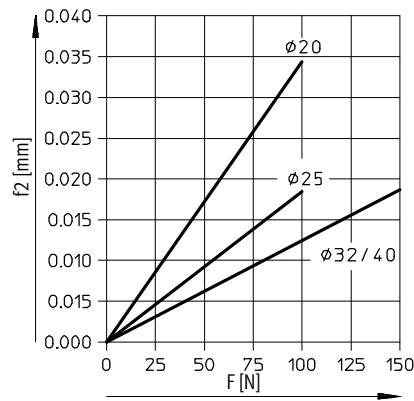
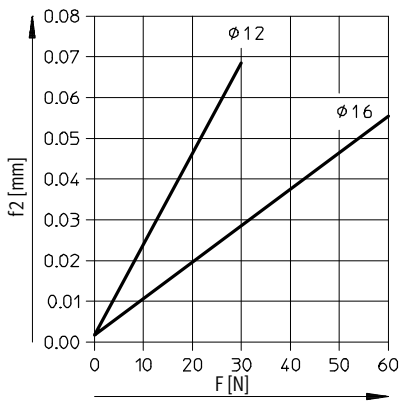

Stroke 100 mm

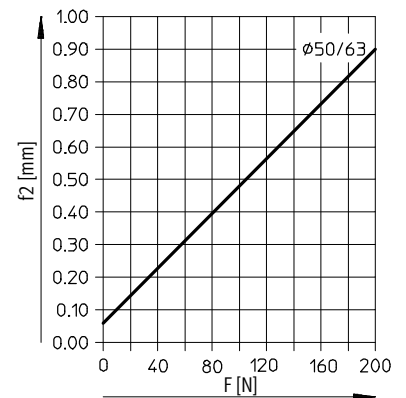
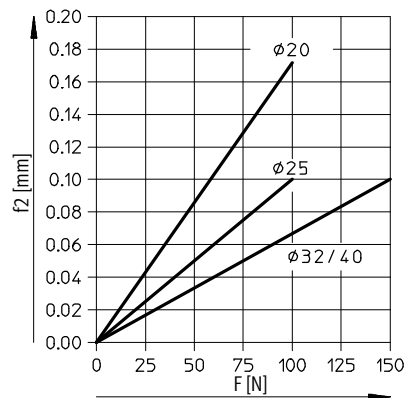
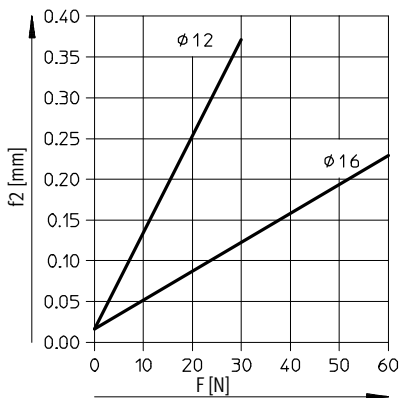

Guided drives DFM-B

Technical data



Deflection of piston rod

Mean deflection f_1 due to bearing backlash as a function of the stroke l

DFM-KF with 2 bearings per guide rod

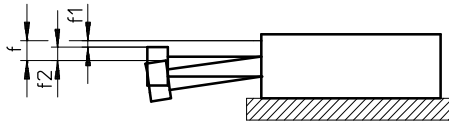

$$f = f_1 + f_2$$

f = Total deflection of piston rod

f_1 = Deflection due to bearing backlash

f_2 = Deflection due to lateral force

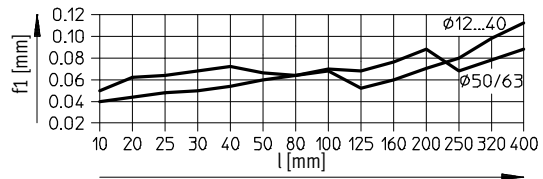

Deflection f_2 due to lateral force F as a function of the stroke with recirculating ball bearing guide KF

Stroke 200 mm

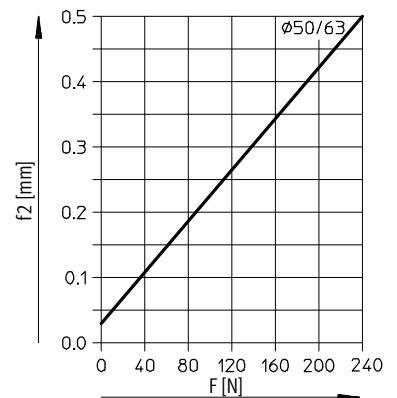
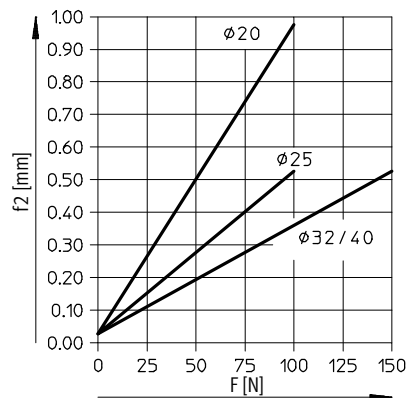
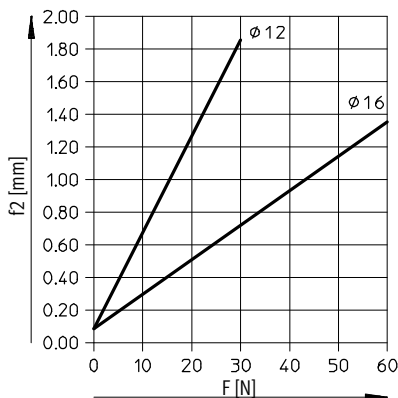

Stroke 400 mm

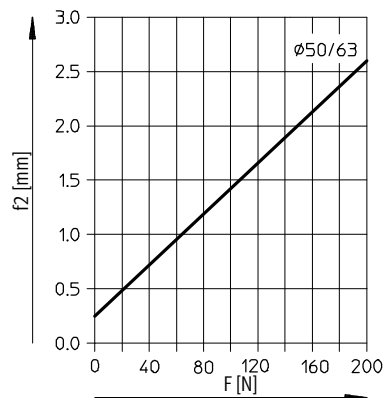
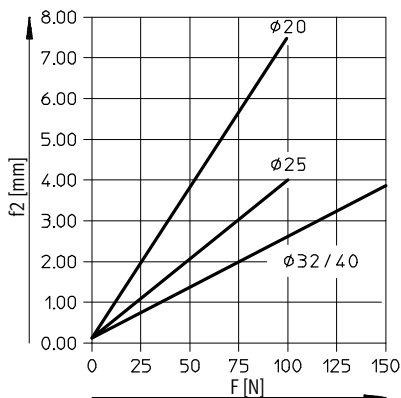

Guided drives DFM-B

Technical data

Used as lifting cylinder

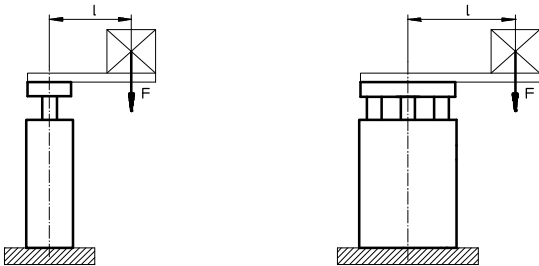

Note

Additional graphs → starting on page 14.

F = Longitudinal force [N]
l = Lever arm [mm]

Permissible load with plain-bearing guide GF

Stroke 40 ... 400 mm

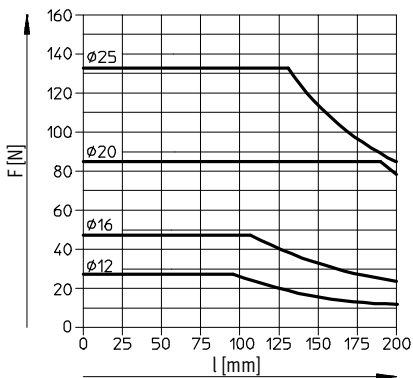

Stroke 250 ... 400 mm

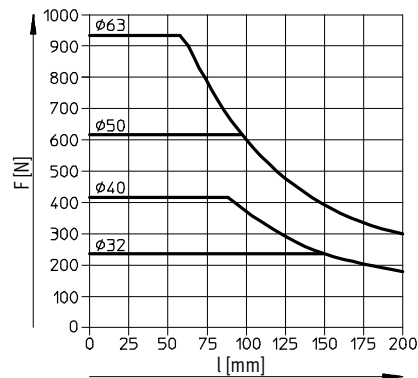

Permissible load with recirculating ball bearing guide KF

Stroke 40 ... 100 mm

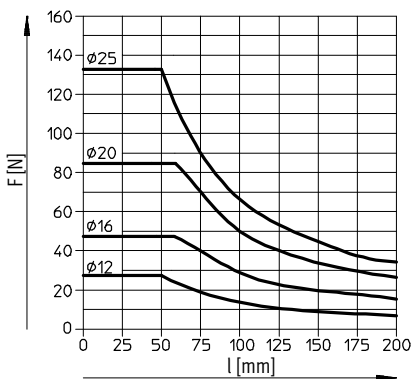

Stroke 125 ... 200 mm

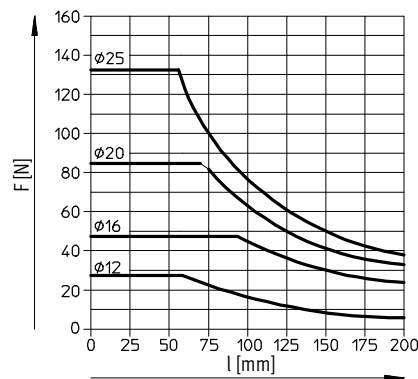

Stroke 250 ... 400 mm

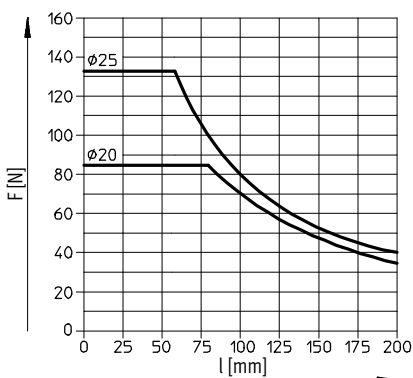

Stroke 200 ... 400 mm

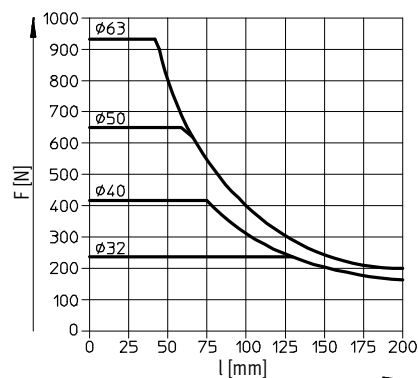

Guided drives DFM-B

Technical data



Permissible load m as a function of the permissible speed v

Horizontal operation, cushioning YSRW

DFM-20...-B-YSRW

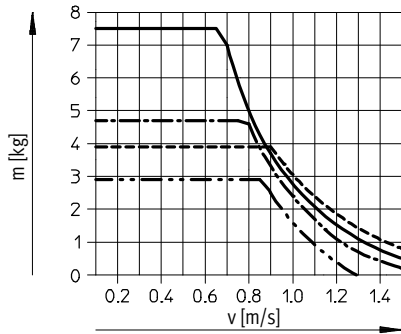

DFM-25...-B-YSRW

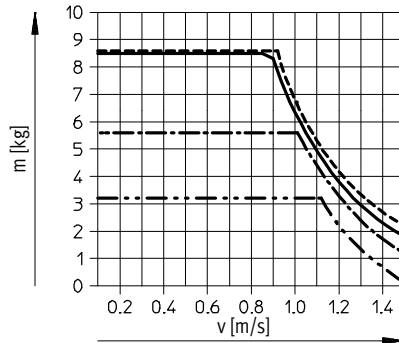

DFM-32...-B-YSRW

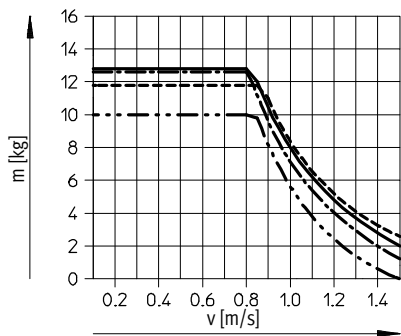

DFM-40...-B-YSRW

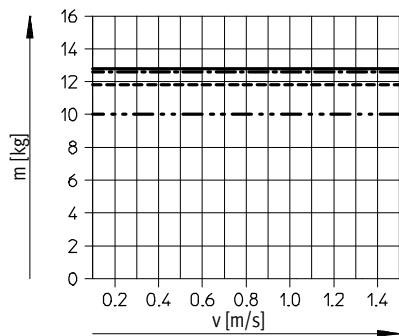

DFM-50...-B-YSRW

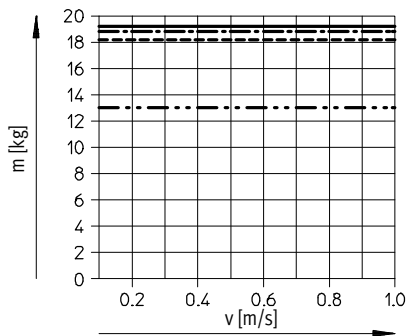

DFM-63...-B-YSRW

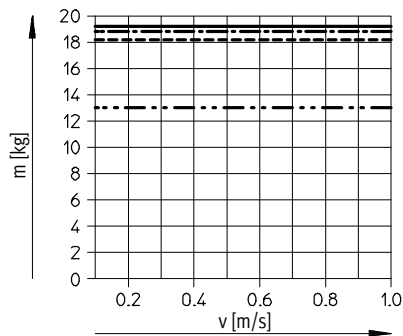

- 25 mm stroke
- 100 mm stroke
- · - · - 200 mm stroke
- · · · · 400 mm stroke

Guided drives DFM-B

Technical data

Vertical operation, cushioning YSRW

DFM-20-...-B-YSRW

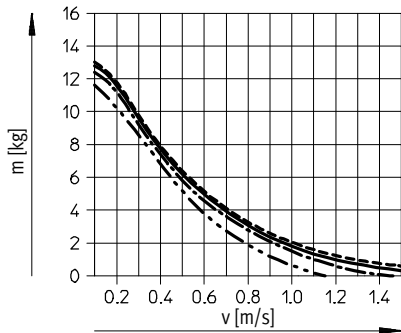

DFM-25-...-B-YSRW

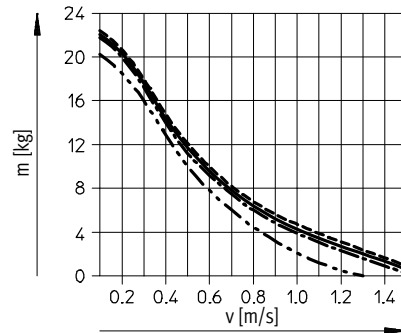

DFM-32-...-B-YSRW

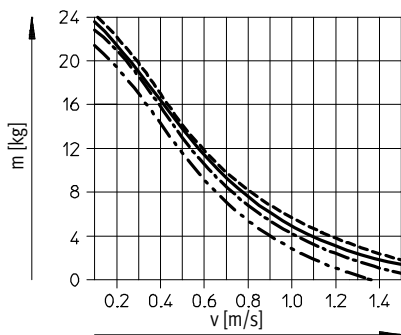

DFM-40-...-B-YSRW

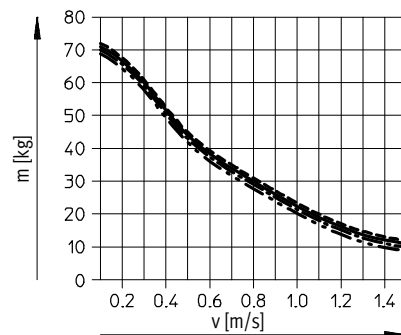

DFM-50-...-B-YSRW

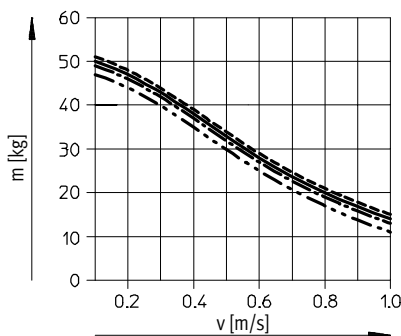

DFM-63-...-B-YSRW

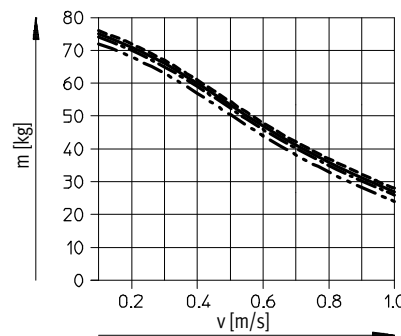

- 25 mm stroke
- 100 mm stroke
- · - · - 200 mm stroke
- · · · · 400 mm stroke

Guided drives DFM-B

Technical data



Dimensions

Piston \varnothing 12, 16 mm

Download CAD Data → www.festo.com/us/cad

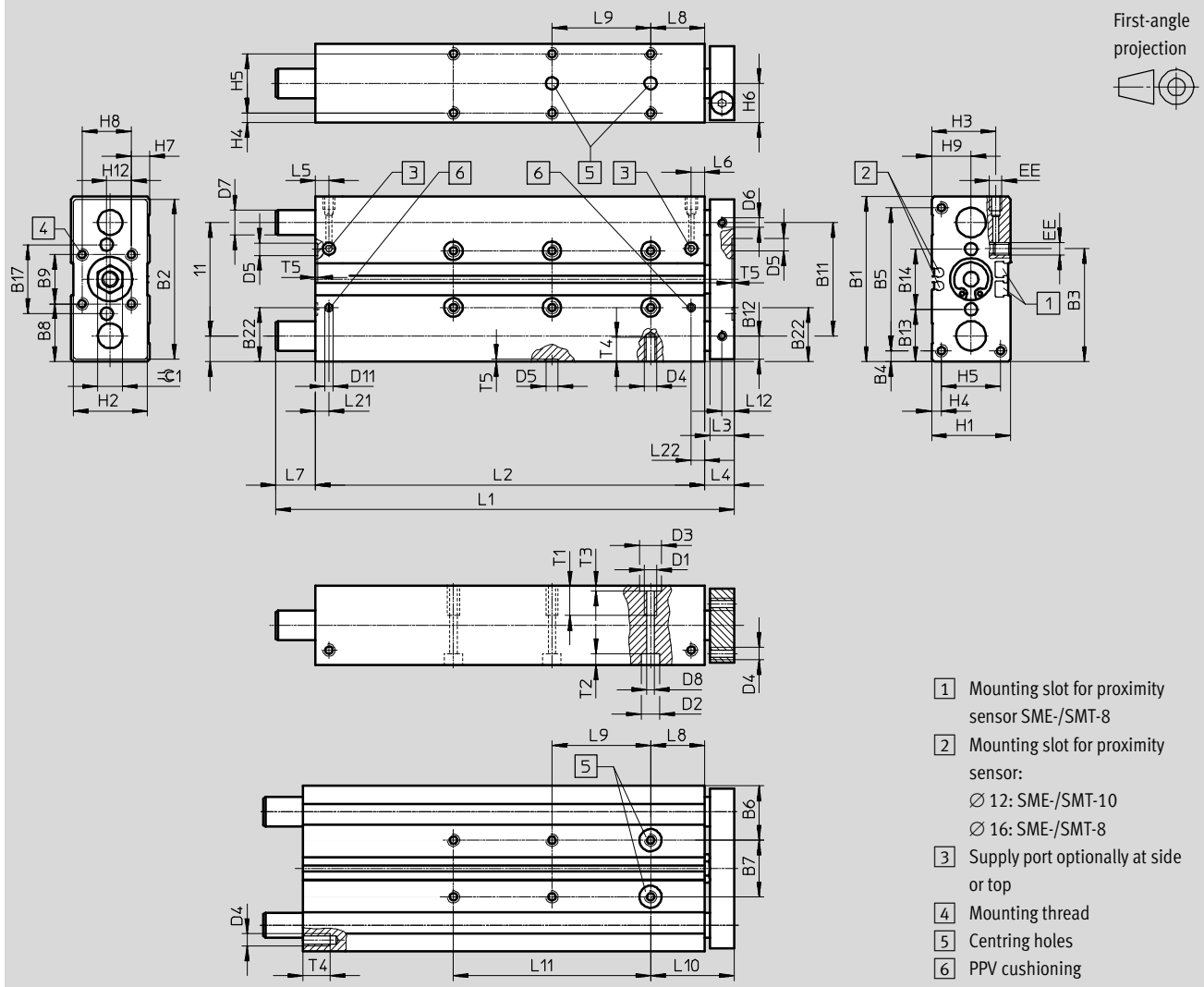

\varnothing	B1	B2	B3	B4	B5	B6	B7	B8	B9	B10	B11	B12	B13	B14	B17	B22	D1
[mm]							$\pm 0.02^{1)}$							$\pm 0.02^{1)}$			
12	60	58	40.7	4.5	51	20.5	19	20	20	9.5	41	8.5	19.5	21	25	-	M5
16	67	65	45	4.5	58	22	23	23.5	20	10.5	46	9.5	21.3	24.4	28	22.5	M5

1) Tolerance between centring holes

\varnothing	D2	D3	D4	D5	D6	D7		D8	D11	EE	H1	H2	H3	H4	H5	H6	H7
[mm]	\varnothing	\varnothing		\varnothing	\varnothing	GF	KF	\varnothing	\varnothing								
12	8	9	M4	5	M4	10 _{h8}	8 _{h6}	4.3	-	M5	28	26	24	4	20	14	4
16	7.5	9	M5	5	M4	12 _{h8}	10 _{h6}	4.3	3.3	M5	32	30	26.5	4	24	16	7.4

\varnothing	H8	H9	H12	L3	L4	L5	L6	L8	L10	L12	L21	L22	T1	T2	T3	T4	T5	$\approx \varnothing 1$
[mm]																		
12	20	14	10	10	13	14.8	11.2	21	34	5	-	-	10	9.4	2.1	8	1.2	10
16	20	16	10	10	12	9.8	9.3	22	34	5	9.8	9.3	12	4.6	2.1	10	1.2	10

Guided drives DFM-B

Technical data

Stroke [mm]	Piston Ø [mm]									
	12					16				
	L1	L2	L7	L9 ±0.02 ¹⁾	L11	L1	L2	L7	L9 ±0.02 ¹⁾	L11
10	74	50	11	-	-	80	68	-	-	-
20	84	60	11	-	-	90	78	-	-	-
25	89	65	11	20	-	95	83	-	20	-
30	94	70	11	20	-	100	88	-	20	-
40	104	80	11	20	-	110	98	-	20	-
50	114	90	11	40	-	120	108	-	40	-
80	144	120	11	40	-	150	138	-	40	-
100	164	140	11	40	80	170	158	-	40	80
125	230	165	52	40	80	229	183	34	40	80
160	265	200	52	40	120	264	218	34	40	120
200	305	240	52	40	160	304	258	34	40	160

1) Tolerance between centring holes

Note

If the guide rods project beyond the housing when the unit is in its retracted end position (→ dimension L7), a recess must be provided in the

mounting surface if the unit is to be mounted against a surface in order to allow the guide rods to move freely.

When using a variable stroke, the dimensions L1, L2, L7, L9 and L11 correspond to the next longest standard stroke.

Dimensions

Download CAD Data → www.festo.com/us/cad

AJ – Precision stroke adjustment, advanced end position

Ø 12, 16 mm

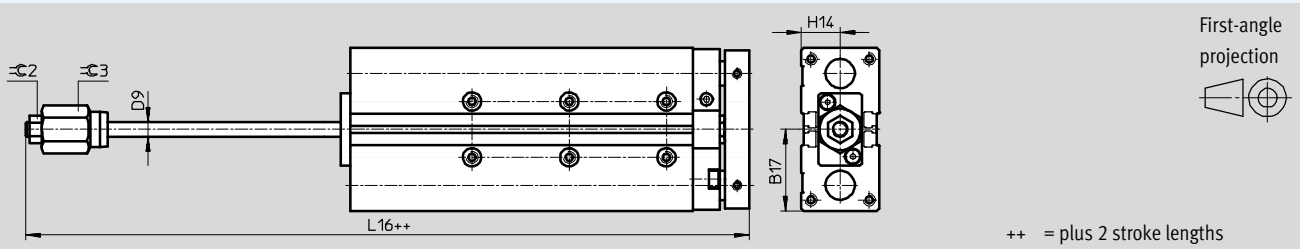

Ø	B17	D9 Ø	H14	L16	C2	C3
[mm]						
12	30.5	6	14	90.6	10	17
16	33.5	6	16	107.9	10	17

Guided drives DFM-B

Technical data

FESTO

Dimensions

Piston \varnothing 20 ... 40 mm

Download CAD Data → www.festo.com/us/cad

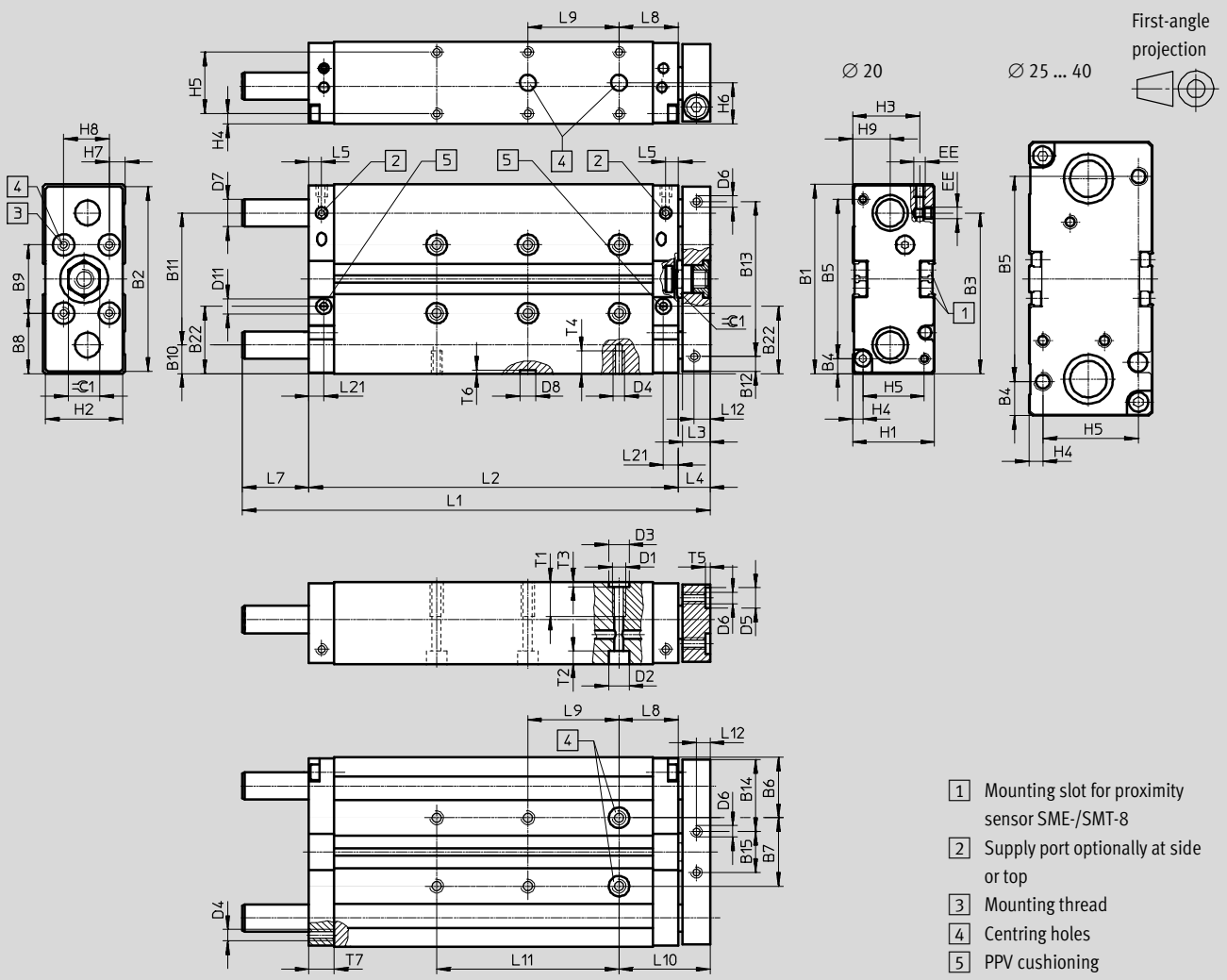

Guided drives DFM-B

Technical data

∅	B1	B2	B3	B4	B5	B6	B7	B8	B9	B10	B11	B12	B13	B14	B15	B22	D1
[mm]							±0.02 ¹⁾		±0.02 ¹⁾								
20	83	81	70.5	6.5	70	26.5	30	26.5	30	12.5	58	6.5	68	31.5	18	29.5	M6
25	95	93	67	15.5	64	30	35	27.5	40	13.5	68	12.5	68	32.5	28	33.5	M6
32	110	108	77	20	70	33.5	43	35	40	16	78	15	78	41	26	41	M8
40	120	118	86	15	90	34.5	51	35	50	16	88	15	88	41	36	41	M8

1) Tolerance between centring holes

∅	D2	D3	D4	D5	D6	D7		D8	D11	EE	H1	H2	H3	H4	H5	H6	H7
	∅	∅		∅	∅	∅	∅	∅	∅								
[mm]		H7		H7		GF	KF	H7									
20	9	9	M5	9	M5	14	12	7	6	M5	36	34	29.5	4.5	27	18	7
25	9	9	M6	9	M6	16	14	7	8	G1/8	44	42	34.8	4.5	35	22	12
32	11	12	M6	9	M6	20	16	9	8	G1/8	49	47	39	6	37	24.5	8.5
40	11	12	M8	9	M6	20	16	9	8	G1/8	54	52	41.5	6	42	27	10

∅	H8	H9	L3	L4	L5	L8	L10	L12	L21	T1	T2	T3	T4	T5	T6	T7	≙C1
[mm]																	
20	20	16.5	12	14	5.5	26	40	6	6.5	12	5.7	2.1	10	2.1	1.6	11	14
25	20	19	12	14	8.5	26	40	6	10	15	5.7	2.1	12	2.1	1.6	15	17
32	30	21	14	16	8.5	29	45	7	10	20	6.8	2.6	11	2.1	2.1	15	17
40	30	26	14	16	8.5	29	45	7	10	20	6.8	2.6	16	2.1	2.1	15	17

Stroke	Piston ∅ [mm]																			
	20					25					32					40				
[mm]	L1	L2	L7	L9	L11	L1	L2	L7	L9	L11	L1	L2	L7	L9	L11	L1	L2	L7	L9	L11
				±0.02 ¹⁾					±0.02 ¹⁾					±0.02 ¹⁾					±0.02 ¹⁾	
20	105	82	9	20	-	111	90	7	20	-	118	95	7	20	-	-	-	-	-	-
25	110	87	9	20	-	116	95	7	20	-	123	100	7	20	-	123	101	6	20	-
30	115	92	9	20	-	121	100	7	20	-	133	105	12	20	-	-	-	-	-	-
40	135	102	19	20	-	141	110	17	20	-	143	115	12	20	-	-	-	-	-	-
50	145	112	19	40	-	151	120	17	40	-	153	125	12	40	-	153	126	11	40	-
80	185	142	29	40	-	196	150	32	40	-	208	155	37	40	-	208	156	36	40	-
100	205	162	29	40	80	216	170	32	40	80	228	175	37	40	80	228	176	36	40	80
125	257	187	56	40	80	271	195	62	40	80	283	200	67	40	80	283	201	66	40	80
160	292	222	56	40	120	306	230	62	40	120	318	235	67	40	120	318	236	66	40	120
200	332	262	56	40	160	346	270	62	40	160	358	275	67	40	160	358	276	66	40	160
250	472	312	146	40	200	476	320	142	40	200	483	325	142	40	200	483	326	141	40	200
320	542	382	146	40	240	546	390	142	40	240	553	395	142	40	240	553	396	141	40	240
400	622	462	146	40	320	626	470	142	40	320	633	475	142	40	320	633	476	141	40	320

1) Tolerance between centring holes

Note: This product conforms to ISO 1179-1 and ISO 228-1

Note

If the guide rods project beyond the housing when the unit is in its retracted end position (→ dimension L7), a recess must be provided in the

mounting surface if the unit is to be mounted against a surface in order to allow the guide rods to move freely.

When using a variable stroke, the dimensions L1, L2, L7, L9 and L11 correspond to the next longest standard stroke.

Guided drives DFM-B

Technical data

FESTO

Dimensions

Download CAD Data → www.festo.com/us/cad

YSRW – Self-adjusting cushioning

Ø 20 ... 40 mm

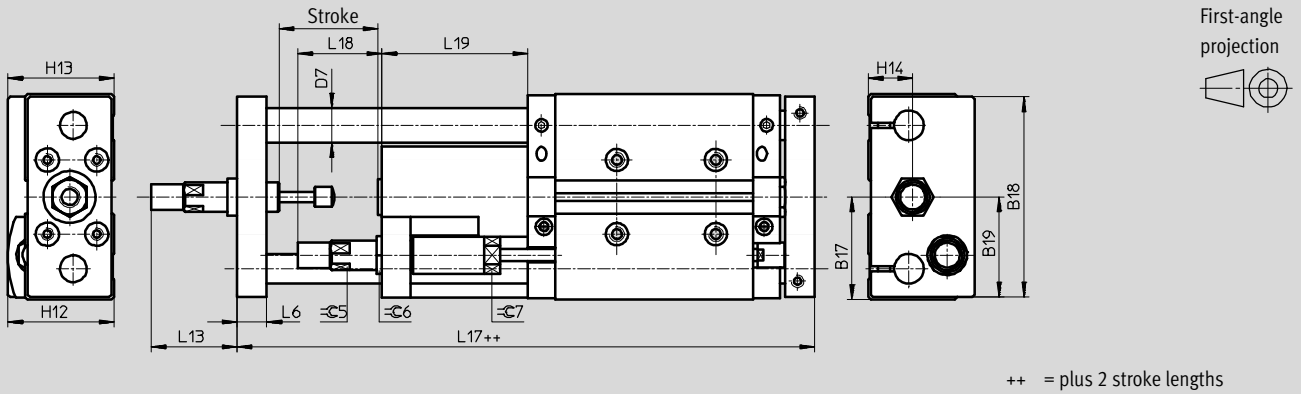

AJ/EJ – Precision stroke adjustment, advanced end position and retracted end position

Ø 20 ... 40 mm

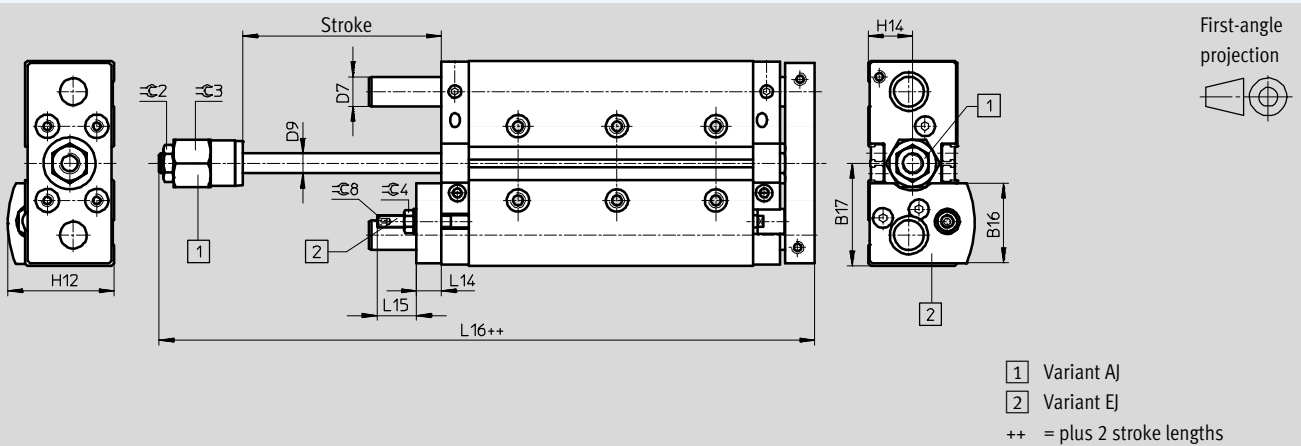

Guided drives DFM-B

Technical data

∅ [mm]	B16	B17	B18	B19	D7 ∅		D9 ∅	H12	H13	H14	L6	L13	L14
					GF	KF							
20	32.5	41.5	81	40.5	14	12	8	43	43	18	12	36.5	10
25	38.6	47.5	90	45	16	14	10	49.5	50.5	22	14	43	12
32	43.4	55	105	52.5	20	16	12	56.5	56	24.5	16	52	12
40	46.2	60	116	58	20	16	12	62.5	63.5	27	16	72	12

∅ [mm]	L15	L16	L17	L18	L19	≈C2	≈C3	≈C4	≈C5	≈C6	≈C7	≈C8
20	16	110	153.5	34	59	13	19	8	11	15	13	2.5
25	23.5	119.5	176.5	37.5	71	17	24	13	13	17	16	4
32	18.5	129.5	190.5	48.5	76	17	30	13	15	17	19	4
40	18.5	132	209.5	55.5	95	17	30	13	20	22	27	4

Guided drives DFM-B

Technical data

∅	B1	B2	B3	B4	B5	B6	B7	B8	B9	B10	B11	B12	B13	B14	B15	B20	B21
[mm]							±0.02 ¹⁾		±0.02 ¹⁾								±0.02 ¹⁾
50	148	146	104.5	19	110	42	64	44	60	19	110	18	110	52	42	40	68
63	162	160	117	9	144	41	80	41	80	18.5	125	17.5	125	51	58	39.5	83

∅	B22	D1	D2	D3	D6	D7		D11	EE	H1	H2	H3	H4	H5	H6	H7	H8
[mm]			∅	∅	∅	∅	∅	∅									
			H7	H7		GF	KF										
50	52.5	M8	11	12	M8	25	20	8	G¼	64	62	48.5	7	50	32	12	40
63	54	M10	15	12	M8	25	20	8	G¼	78	76	55	9	60	39	19	40

∅	H9	L3	L4	L5	L8	L10	L12	L21	T1	T2	T3	T4	T5	T6	T7	T8	≈C1	≈C2
[mm]																		
50	29	16	18	10.5	32	50	8	13.5	20	6.8	2.6	16	2.6	2.6	21	16	24	19
63	32	16	18	10.5	32	50	8	13.5	24	9	2.6	20	2.6	2.6	21	16	24	19

Stroke	Piston ∅ [mm]									
	50					63				
[mm]	L1	L2	L7	L9	L11	L1	L2	L7	L9	L11
				±0.02 ¹⁾					±0.02 ¹⁾	
25	137	113	6	20	-	137	114	5	20	-
50	177	138	21	41		177	139	20	40	
80	227	168	62		40	227	169	61		40
100	247	188		139		40	247		189	
125	293	213	200		40		293	214	200	40
160	328	248		250		40	328	249		
200	368	288	320		40		368	289	320	40
250	495	338		400		40	495	339		
320	565	408	400		40		565	409	400	40
400	645	488		400		40	645	489		

1) Tolerance between centring holes

Note: This product conforms to ISO 1179-1 and ISO 228-1

Note

Since the guide rods project beyond the housing when the unit is in its retracted end position (→ dimension L7), a recess must be provided in the

mounting surface if the unit is to be mounted against a surface in order to allow the guide rods to move freely.

When using a variable stroke, the dimensions L1, L2, L7, L9 and L11 correspond to the next longest standard stroke.

Guided drives DFM-B

Technical data

FESTO

Dimensions

Download CAD Data → www.festo.com/us/cad

YSRW – Self-adjusting cushioning

Ø 50 ... 63 mm

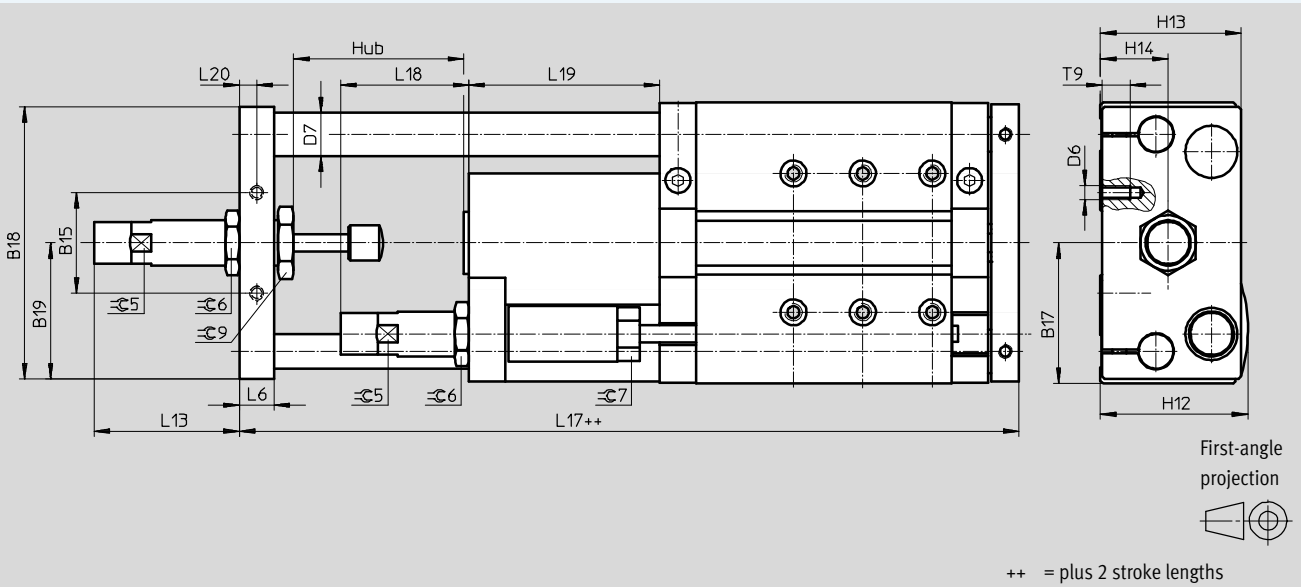

A/EJ – Precision stroke adjustment, advanced end position and retracted end position

Ø 50 ... 63 mm

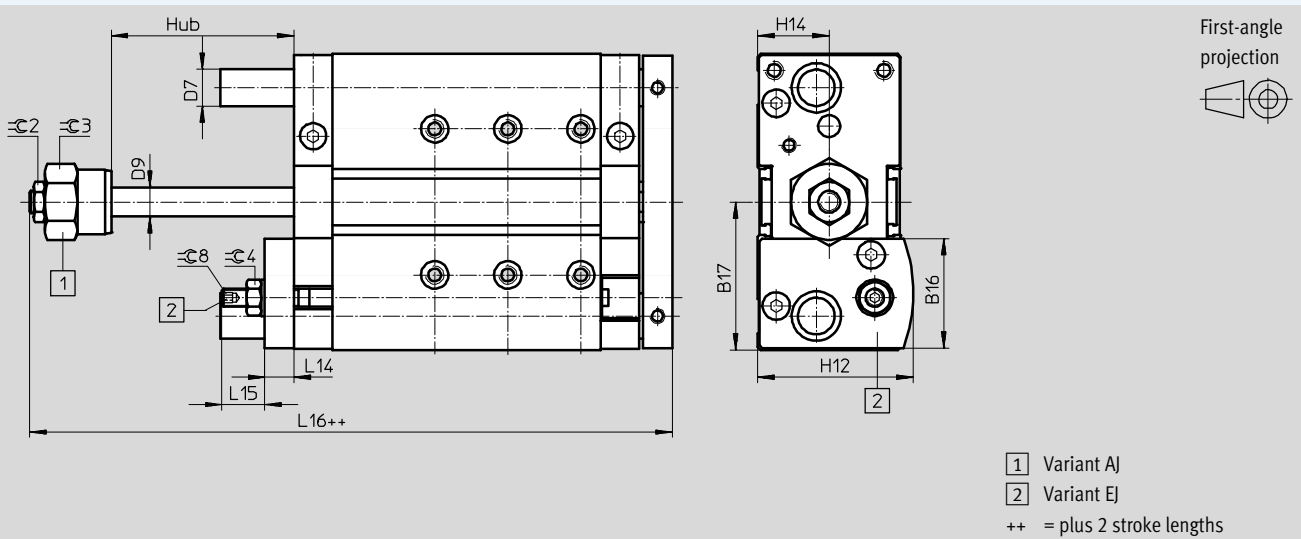

Guided drives DFM-B

Technical data

∅ [mm]	B15	B16	B17	B18	B19	D6	D7 ∅		D9 ∅	H12	H13	H14	L6	L13	L14
							GF	KF							
50	42	57.6	74	157	72	M8	25	20	16	74	71	32	16	67.6	16
63	58	60	81	144	78.5	M8	25	20	16	81	81	39	20	83.3	16

∅ [mm]	L15	L16	L17	L18	L19	L20	T9	≈C2	≈C3	≈C4	≈C5	≈C6	≈C7	≈C8	≈C9
	50	24.5	152.1	226.4	58.5	93	8	16	19	36	17	20	27	22	5
63	23.5	151.8	249.2	74	110	10	16	19	36	17	24	32	27	5	36

Guided drives DFM-B, with plain-bearing guide GF

Ordering data – Modular products

M Mandatory data →

Module No.	Design	Size	Stroke	Generation	Cushioning	Position sensing	Guide
529 119	DFM	12	10 ... 400	B	P PPV	A	GF
529 120							
532 316							
532 317							
532 318							
532 319							
534 769							
534 770							
534 770							
Ordering example							
532 319	DFM	- 40	- 400	- B	- P	- A	- GF

Ordering table												
Size	12	16	20	25	32	40	50	63	Condition s	Code	Enter code	
M Module No.	529 119	529 120	532 316	532 317	532 318	532 319	534 769	534 770				
Design	Guided drive									DFM	DFM	
Size	12	16	20	25	32	40	50	63		-...		
Stroke [mm]	10	10	-	-	-	-	-	-		-...		
	20	20	20	20	20	-	-	-		-...		
	25	25	25	25	25	25	25	25		-...		
	30	30	30	30	30	-	-	-		-...		
	40	40	40	40	40	-	-	-		-...		
	50	50	50	50	50	50	50	50		-...		
	80	80	80	80	80	80	80	80		-...		
	100	100	100	100	100	100	100	100		-...		
	125	125	125	125	125	125	125	125		-...		
	160	160	160	160	160	160	160	160		-...		
	200	200	200	200	200	200	200	200		-...		
		-	-	250	250	250	250	250	250		-...	
	-	-	320	320	320	320	320	320		-...		
	-	-	400	400	400	400	400	400		-...		
Variable stroke [mm]	10 ... 200		20 ... 400			25 ... 400			[1]	-...		
Generation	B series									-B	-B	
Cushioning	Flexible cushioning rings/plates at both ends									-P		
	-	Pneumatic cushioning adjustable at both ends									[2]	-PPV
Position sensing	For proximity sensing									-A	-A	
Guide	Plain-bearing guide									-GF	-GF	

[1] ... Not in combination with precision adjustment AJ

[2] PPV Not in combination with precision adjustment AJ, EJ

Transfer order code

DFM - - - **B** - - - **A** - - **GF**

Guided drives DFM-B, with plain-bearing guide GF

Ordering data – Modular products

0 Options						
Temperature-resistant	Precision adjustment in the end positions, advanced	Precision adjustment in the end positions, retracted	Accessories	Slot cover for sensor slot	Proximity sensor with cable	Proximity sensor, contactless with cable
S6	AJ	EJ	ZUB	...S	...G	...I
- S6	- AJ	- EJ	ZUB	- 10S	10G	10I

Ordering table											
Size	12	16	20	25	32	40	50	63	Conditions	Code	Enter code
0 Temperature-resistant	Heat-resistant seals up to max. 120 °C								3	S6	
Precision adjustment in the end positions, advanced	Precision adjustment advanced									-AJ	
Precision adjustment in the end positions, retracted	-	-	Precision adjustment retracted							-EJ	
Accessories	Supplied separately									ZUB-	ZUB-
Slot cover for sensor slot	1 ... 10									...S	
Proximity sensor	With cable 2.5 m									...G	
	Contactless with cable 2.5 m									...I	

3 S6 Not in combination with precision adjustment AJ, EJ

Transfer order code

- - - ZUB -

Guided drives DFM-B, with recirculating ball bearing guide KF

Ordering data – Modular products

M Mandatory data →

Module No.	Design	Size	Stroke	Generation	Cushioning	Position sensing	Guide
529 119	DFM	12	10 ... 400	B	P PPV YSRW	A	KF
529 120		16					
532 316		20					
532 317		25					
532 318		32					
532 319		40					
534 769		50					
534 770		63					
Ordering example							
532 319	DFM	- 40	- 400	- B	- P	- A	- KF

Ordering table												
Size	12	16	20	25	32	40	50	63	Condition s	Code	Enter code	
M Module No.	529 119	529 120	532 316	532 317	532 318	532 319	534 769	534 770				
Design	Guided drive									DFM	DFM	
Size	12	16	20	25	32	40	50	63		-...		
Stroke [mm]	10	10	-	-	-	-	-	-		-...		
	20	20	20	20	20	-	-	-		-...		
	25	25	25	25	25	25	25	25		-...		
	30	30	30	30	30	-	-	-		-...		
	40	40	40	40	40	-	-	-		-...		
	50	50	50	50	50	50	50	50		-...		
	80	80	80	80	80	80	80	80		-...		
	100	100	100	100	100	100	100	100		-...		
	125	125	125	125	125	125	125	125		-...		
	160	160	160	160	160	160	160	160		-...		
200	200	200	200	200	200	200	200		-...			
	-	-	250	250	250	250	250	250		-...		
	-	-	320	320	320	320	320	320		-...		
	-	-	400	400	400	400	400	400		-...		
Variable stroke [mm]	10 ... 200		20 ... 400			25 ... 400			[1]	-...		
Generation	B series									-B	-B	
Cushioning	Flexible cushioning rings/plates at both ends									-P		
	-	Pneumatic cushioning adjustable at both ends								[2]	-PPV	
	-	Shock absorber with progressive cushioning								[3]	-YSRW	
Position sensing	For proximity sensing									-A	-A	
Guide	Recirculating ball bearing guide									-KF	-KF	

[1] ... Not in combination with precision adjustment AJ, cushioning YSRW
 [2] **PPV** Not in combination with precision adjustment AJ, E

[3] **YSRW** Not with precision adjustment AJ, E, since already integrated

Transfer order code

DFM - - - **B** - - - **A** - - **KF**

Guided drives DFM-B, with recirculating ball bearing guide KF

Ordering data – Modular products

Options					
Precision adjustment in the end positions, advanced	Precision adjustment in the end positions, retracted	Accessories	Slot cover for sensor slot	Proximity sensor with cable	Proximity sensor, contactless with cable
AJ	EJ	ZUB	...S	...G	...I
- AJ	- EJ	ZUB	- 10S	10G	10I

Ordering table												
Size	12	16	20	25	32	40	50	63	Conditions	Code	Enter code	
Options	Precision adjustment advanced									-AJ		
	-	-	Precision adjustment retracted								-EJ	
Accessories	Supplied separately									ZUB-	ZUB-	
Slot cover for sensor slot	1 ... 10									...S		
Proximity sensor	With cable 2.5 m									...G		
	Contactless with cable 2.5 m									...I		

Transfer order code

- - ZUB -

Guided drives DFM/DFM-B

Accessories



Centring sleeve ZBH

Material:
High-alloy steel

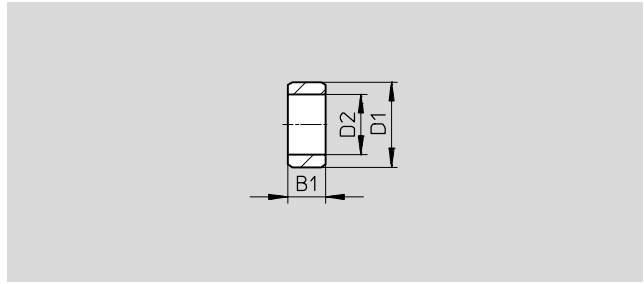

Dimensions and ordering data (repeat order)							
B1	D1	D2	CRC ¹⁾	Weight	Part No.	Type	PU ²⁾
-0.2	∅ h7	∅		[g]			
2.4	5	3.2	2	1	189652	ZBH-5	10
3	7	5.3	2	1	186717	ZBH-7	10
4	9	6.4	2	1	150927	ZBH-9	10
5	12	10.3	2	1	189653	ZBH-12	10
6	15	12.4	2	1	191409	ZBH-15	10

- 1) Corrosion resistance class 2 according to Festo standard 940 070
Components requiring moderate corrosion resistance. Externally visible parts with primarily decorative surface requirements which are in direct contact with a normal industrial environment or media such as coolants or lubricating agents
- 2) Packaging unit quantity

Centring sleeves included in scope of delivery			
DFM	Piston ∅ [mm]	Centring sleeves	
		for housing	for yoke plate
	12	2x ZBH-5, 2x ZBH-9	2x ZBH-5
	16	2x ZBH-5, 2x ZBH-9	2x ZBH-5
	20	2x ZBH-7, 2x ZBH-9	2x ZBH-9
	25	2x ZBH-7, 2x ZBH-9	2x ZBH-9
	32	2x ZBH-9, 2x ZBH-12	2x ZBH-9
	40	2x ZBH-9, 2x ZBH-12	2x ZBH-9
	50	2x ZBH-12	2x ZBH-12
	63	2x ZBH-12	2x ZBH-12
	80	2x ZBH-12	2x ZBH-12
	100	2x ZBH-15	2x ZBH-15

Centring sleeves included in scope of delivery			
DFM-B	Piston ∅ [mm]	Centring sleeves	
		for housing	for yoke plate
	12	2x ZBH-5, 2x ZBH-9	2x ZBH-5
	16	2x ZBH-5, 2x ZBH-9	2x ZBH-5
	20	2x ZBH-7, 2x ZBH-9	2x ZBH-9
	25	2x ZBH-7, 2x ZBH-9	2x ZBH-9
	32	2x ZBH-9, 2x ZBH-12	2x ZBH-9
	40	2x ZBH-9, 2x ZBH-12	2x ZBH-9
	50	2x ZBH-12	2x ZBH-12
	63	2x ZBH-12	2x ZBH-12
	-	-	-
	-	-	-

Guided drives DFM/DFM-B

Accessories

FESTO

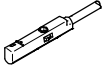

Proximity sensors for piston $\varnothing 12$ with DFM-B

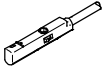
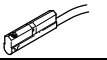
Ordering data – Proximity sensors for C-slot, magneto-resistive						Technical data → Internet: smt	
	Type of mounting	Switch output	Electrical connection, connection direction	Cable length [m]	Part No.	Type	
N/O contact							
	Insertable in the slot from above	PNP	Cable, 3-wire, in-line	2.5	551373	SMT-10M-PS-24V-E-2,5-L-OE	
			Plug M8x1, 3-pin, in-line	0.3	551375	SMT-10M-PS-24V-E-0,3-L-M8D	
			Plug M8x1, 3-pin, angled	0.3	551376	SMT-10M-PS-24V-E-0,3-Q-M8D	

Ordering data – Proximity sensors for C-slot, magnetic reed						Technical data → Internet: sme	
	Type of mounting	Switch output	Electrical connection, connection direction	Cable length [m]	Part No.	Type	
N/O contact							
	Insertable in the slot from above	Contacting	Plug M8x1, 3-pin, in-line	0.3	551367	SME-10M-DS-24V-E-0,3-L-M8D	
			Cable, 3-wire, in-line	2.5	551365	SME-10M-DS-24V-E-2,5-L-OE	
			Cable, 2-wire, in-line	2.5	551369	SME-10M-ZS-24V-E-2,5-L-OE	
	Insertable in the slot from above	Contacting	Plug M8x1, 3-pin, in-line	0.3	173212	SME-10-SL-LED-24	
			Cable, 3-wire, in-line	2.5	173210	SME-10-KL-LED-24	

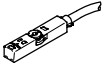
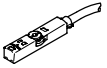
Proximity sensors for piston $\varnothing 16 \dots 63$

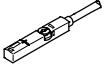
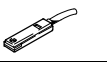

Ordering data – Proximity sensors for T-slot, magneto-resistive						Technical data → Internet: smt	
	Type of mounting	Switch output	Electrical connection	Cable length [m]	Part No.	Type	
N/O contact							
	Insertable in the slot from above, flush with cylinder profile, short design	PNP	Cable, 3-wire	2.5	574335	SMT-8M-A-PS-24V-E-2,5-OE	
			Plug M8x1, 3-pin	0.3	574334	SMT-8M-A-PS-24V-E-0,3-M8D	
			Plug M12x1, 3-pin	0.3	574337	SMT-8M-A-PS-24V-E-0,3-M12	
		NPN	Cable, 3-wire	2.5	574338	SMT-8M-A-NS-24V-E-2,5-OE	
			Plug M8x1, 3-pin	0.3	574339	SMT-8M-A-NS-24V-E-0,3-M8D	
N/C contact							
	Insertable in the slot from above, flush with cylinder profile, short design	PNP	Cable, 3-wire	7.5	574340	SMT-8M-A-PO-24V-E-7,5-OE	

Ordering data – Proximity sensors for T-slot, magnetic reed						Technical data → Internet: sme	
	Type of mounting	Switch output	Electrical connection	Cable length [m]	Part No.	Type	
N/O contact							
	Insertable in the slot from above, flush with cylinder profile	Contacting	Cable, 3-wire	2.5	543862	SME-8M-DS-24V-K-2,5-OE	
			Cable, 3-wire	5.0	543863	SME-8M-DS-24V-K-5,0-OE	
			Cable, 2-wire	2.5	543872	SME-8M-ZS-24V-K-2,5-OE	
			Plug M8x1, 3-pin	0.3	543861	SME-8M-DS-24V-K-0,3-M8D	
	Insertable in the slot lengthwise, flush with the cylinder profile	Contacting	Cable, 3-wire	2.5	150855	SME-8-K-LED-24	
			Plug M8x1, 3-pin	0.3	150857	SME-8-S-LED-24	
N/C contact							
	Insertable in the slot lengthwise, flush with the cylinder profile	Contacting	Cable, 3-wire	7.5	160251	SME-8-O-K-LED-24	

Guided drives DFM/DFM-B

Accessories

FESTO

Ordering data – Connecting cable				Technical data → Internet: nebu	
	Electrical connection, left	Electrical connection, right	Cable length [m]	Part No.	Type
	Straight socket, M8x1, 3-pin	Cable, open end, 3-wire	2.5	541333	NEBU-M8G3-K-2.5-LE3
			5	541334	NEBU-M8G3-K-5-LE3
	Straight socket, M12x1, 5-pin	Cable, open end, 3-wire	2.5	541363	NEBU-M12G5-K-2.5-LE3
			5	541364	NEBU-M12G5-K-5-LE3
	Angled socket, M8x1, 3-pin	Cable, open end, 3-wire	2.5	541338	NEBU-M8W3-K-2.5-LE3
			5	541341	NEBU-M8W3-K-5-LE3
	Angled socket, M12x1, 5-pin	Cable, open end, 3-wire	2.5	541367	NEBU-M12W5-K-2.5-LE3
			5	541370	NEBU-M12W5-K-5-LE3

Ordering data – Slot cover for T-slot			
	Assembly	Length	Part No. Type
	Insertable from above	2x 0.5 m	151680 ABP-5-S

Ordering data – One-way flow control valves			Technical data → Internet: grla		
	Connection		Material	Part No.	Type
	Thread	For tubing O.D.			
	M5	3	Metal design	193137	GRLA-M5-QS-3-D
		4		193138	GRLA-M5-QS-4-D
		6		193139	GRLA-M5-QS-6-D
	G ¹ / ₈	3		193142	GRLA- ¹ / ₈ -QS-3-D
		4		193143	GRLA- ¹ / ₈ -QS-4-D
		6		193144	GRLA- ¹ / ₈ -QS-6-D
		8		193145	GRLA- ¹ / ₈ -QS-8-D
	G ¹ / ₄	6		193146	GRLA- ¹ / ₄ -QS-6-D
		8		193147	GRLA- ¹ / ₄ -QS-8-D
		10		193148	GRLA- ¹ / ₄ -QS-10-D
	G ³ / ₈	6		193149	GRLA- ³ / ₈ -QS-6-D
		8		193150	GRLA- ³ / ₈ -QS-8-D
		10		193151	GRLA- ³ / ₈ -QS-10-D

Guided drives DFM/DFM-B

Accessories



Adapter kit
DHAA, HAPB

Material:
Wrought aluminium alloy
Free of copper and PTFE
RoHS-compliant

Note

The kit includes the individual mounting interface as well as the necessary mounting material.

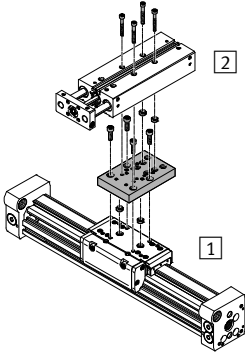
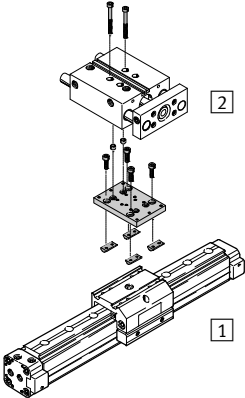
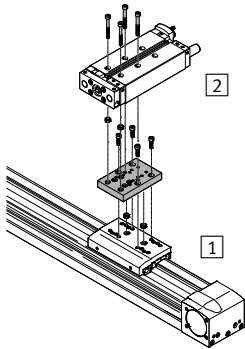
Permissible drive/drive combinations with adapter kit				Download CAD Data → www.festo.com/us/cad	
Combination	[1] Drive	[2] Drive	Adapter kit		
	Size	Size	CRC ¹⁾	Part No.	Type
	DGC	DFM	DHAA		
	25	12, 16, 20	2	562152	DHAA-D-L-25-G7-12
	20, 25	32		562153	DHAA-D-L-32-G7-20
	25, 32, 40	40		562154	DHAA-D-L-40-G7-25
	DG...	DFM	HAPB		
	25	12, 16	2	192690	HAPB-12/16
	32 ²⁾	20, 25		192691	HAPB-20/25
	40	32, 40		192692	HAPB-32/40
	EGC	DFM	DHAA		
	80	12, 16, 20	2	562152	DHAA-D-L-25-G7-12
	120	25, 32, 40		562154	DHAA-D-L-40-G7-25

- 1) Corrosion resistance class CRC 2 to Festo standard FN 940070
Moderate corrosion stress. Indoor applications in which condensation may occur. External visible parts with primarily decorative requirements for the surface and which are in direct contact with the ambient atmosphere typical for industrial applications.
- 2) Only for DGPL/DGPIL-...