

---

# Guidelines for Recording and Reporting Architectural Resources in Nevada

---



*Farrington Ranch dugout home, Reese River Valley, dates from 1916 (USFS).*

Prepared by

USDI Fish and Wildlife Service, USDI Bureau of Land Management, and USDA Forest Service

February 14, 2014

Revised: November 25, 2014

## **Acknowledgements**

The *Guidelines for Recording and Reporting Architectural Resources in Nevada* and *Nevada Architecture Recordation and Assessment (NARA)* form reflect a group effort. Over the past year, meetings, e-mails, and phone calls have provided a dynamic forum for expressing opinions and discussing issues relevant to architectural resources in Nevada. The *Guidelines* draw from BLM, FS, and NDOT protocols and were compiled by Lou Ann Speulda-Drews and Elizabeth Dickey. Fred Frampton, Bryan Hockett, and Tom Burke reviewed many drafts and provided instructive comments. Graphics and photographs were contributed by Dickey, Frampton, Hockett, and Speulda-Drews. Special thanks to Ron Reno for preparing the roof and floorplan sketches and to Elizabeth Dickey for the examples of styles with illustration/descriptions that are appended to the guidelines. Many more individuals, including JoEllen Ross-Hauer, Mella Harmon, Rob McQueen, Jonah Blustain, Mike Drews, Courtney Mooney, Susan Slaughter, Mary Ringhoff, Robin Michael, Diana Painter, Michelle, Schmitter, and Charles Zeier provided edits, comments, and questions that have made the Guidelines a better document and the NARA form a more useable product. Thanks also to Karen de Dufour and the SHPO staff who reviewed and provided comments on an earlier version. Thank you for contributing.

# Table of Contents

Chapter 1. Introduction	1
Definitions – Building, Structure, Object, Site, Associated Resource, District	2
Chapter 2. Brief History of Architecture in Nevada	7
Chapter 3. Historic Contexts	12
Application of the criteria	14
Researching Historic Resources	14
Chapter 4. Project Planning and Section 106, NHPA	19
Pre-Fieldwork Planning	21
Requesting SHPO Resource Numbers	21
File Searches	23
Survey “Cut-off” Dates	24
Permission from Land Owners	24
Chapter 5. Fieldwork and Standards of Recordation	25
Professional Qualifications	25
Tools of the trade	26
Mapping, Photographs, Description -- required for all	27
Recording Buildings	28
Recording Structures	29
Recording Objects	31
Recording Sites/Ruins	31
Recording Linear Resources	31
Recording Associated Resources	35
Recording Districts	35
Chapter 6. Evaluating Eligibility and Integrity	36
Chapter 7. Reporting Standards and Guidelines	38
Report outline	38
Summary	44
Chapter 8. NARA and District form Instructions	45
Parts 1-5 Instructions	45
Parts 6-7 Instructions	47
Part 8-10 - Historic Context/National Register of Historic Places Evaluation	49
Parts 11-14 – Maps and Photographs	50
Part 15 – Building Recording Guide	51
Part 16 – Associated Resources	51
District Form-Parts 6-13	51

References	52
Appendix A: Glossary	56
Appendix B: Building Recording Guide	62
Appendix C: Structure Recording Guide	63
Appendix D: Architectural Style Guide	64
Appendix E: Floor Plan Types and Roof Types (R. Reno)	67
Appendix F: Illustrations of Nevada’s Architectural Styles	72
Appendix G: Photographic Standards	81
Appendix H: Historic Resources Contact List	82

## List of Figures

COVER. Farrington Ranch dugout home, Reese River Valley, dates from 1916 (USFS). Not only a stone building, but built by a man whose mother was Shoshone, and father white, and it was built as a Native American homestead.

Figure 1. BUILDING: Jack Longstreet Cabin, Ash Meadows NWR (USFWS).	2
Figure 2. STRUCTURE: Battle Mountain Tybo Kiln (BLM).	3
Figure 3. Sign post, example of an OBJECT (NDOT).	4
Figure 4. OBJECT: Winn District, Pole Canyon Wagon (BLM).	4
Figure 5. SITE: Collapsed building and scatter of artifacts, Ash Meadows (USFWS).	5
Figure 6. ASSOCIATED RESOURCE: Pumphouse, ranch property (USFWS).	6
Figure 7. Craftsman style home in Sparks, Nevada (Ron Reno, 2009).	10
Figure 8. Vernacular example – RR-Tie Cabin (USFWS).	11
Figure 9. Topographic map from 1893.	15
Figure 10. Detail from Reno 1918 Sanborn Insurance map.	16
Figure 11. Advertisement from the Luskey’s 1961 Henderson-Boulder City Directory	18
Figure 12. A 1927 photograph of Aurora from the Frasher Foto Postcard Collection...	19
Figure 13. When requesting a SHPO Resource number, ..	22
Figure 14. “House #1” is located in Township 16 North, Range 20 East, Section 20...	23
Figure 15. Use NARA example.	30
Figure 16. Use IMACS example.	30
Figure 17. Carson City Assay Building, Washoe Valley (BLM).	32
Figure 18. Segment of the Old Victory Highway...	33
Figure 19. Cabin in poor condition with good integrity (USFWS).	38
Figure 20. Example of project vicinity map (NDOT).	40
Figure 21. Example of APE map on USGS 7.5’ map (NDOT).	41
Figure 22. Example of detail map of project area (NDOT).	42
Figure 23. Example of detailed sketch map with resources identified with SHPO # (NDOT).	43

## Chapter 1 – Introduction

The primary goals of the *Guidelines and for Recording and Reporting Architectural Resources in Nevada (Guidelines)* is to ensure the careful and consistent recordation of Nevada’s built environment and to create fields that can be linked to a searchable database. While a database that contains searchable architectural fields is not yet a reality, creating a recording method with the fields identified is an important first step. Accordingly, the Nevada Architectural Resource Assessment (NARA) form was developed with input from many individuals including: state agencies; local governments; consultants; and federal agencies. Currently, the NARA use is sponsored by the U.S. Fish & Wildlife Service (FWS), the Bureau of Land Management (BLM), and the USDA Forest Service (FS). Architectural resources recorded on lands managed by the FWS, BLM, or FS should use the NARA. SHPO also accepts documentation of architectural resources on the Architectural Recording and Assessment (ARA) form.

Federal agencies have a special responsibility under the Section 106 process defined by the National Historic Preservation Act of 1966, as amended (NHPA) (36CFR 800) to make “a reasonable and good faith effort to carry out appropriate identification efforts” especially to determine if a historic property will be affected by an activity. The NARA and *Guidelines* grew out of a need by federal agencies to make a “good faith” effort to define a process for identifying historic properties that is clear and concise. Certified Local Governments and State agencies also identify historic properties in a similar process to federal agencies. Hopefully, all who record historic architecture in Nevada will find this guide useful.

Chapter 2 of the *Guidelines*, presents a brief history of Nevada’s architectural styles as an introduction to events and trends that have influenced the state’s architecture; Chapter 3 provides guidance on developing historic contexts; Chapter 4 suggests how to plan for a project; Chapter 5 focuses on fieldwork and recording architectural resources; Chapter 6 considers the evaluation process and National Register Eligibility and integrity; Chapter 7 presents standards for reports and graphics; and Chapter 8 offers instructions for completing the *Nevada Architectural Resources Assessment* form; following the chapters are the references and eight Appendices with a glossary, recording guides, examples of styles, and research contacts.

The *Nevada Architectural Resources Assessment* (NARA) form can be used when recording a building (B), structure (S), object (O), and an associated resource. The NARA form can also be used for individual components within a district. A District (D) form was also created to reflect the NARA organization. The NARA forms were developed to contain the SHPO required fields with additional information required by Federal Agencies. In the future, it is hoped that a web-based NARA form will be created that allows the user to in-fill information directly into the database. But, for now, the WORD version of NARA is the standard.

The *Guidelines* are written for a broad audience and supports an approach to recording resources that raises an awareness of Nevada’s built environment. An important strategy of the NARA is to develop consistent use of architectural terms, definitions, and method of recordation to accurately described resources. In many instances field recordation of a resource will be conducted by an individual who does not meet the *Secretary of Interior Standards* for an architectural historian. However, analysis and evaluation of a property will be completed by or with the assistance of a professional architectural historian.

### **Definitions of a building, structure, object, and site**

Definitions for a building, structure, object, ruin, and site are taken from National Register of Historic Places Bulletin 16, National Park Service, to provide guidance for what constitutes an above ground resource that merits recording on an architectural resource form vs. an archaeological resource form. There will always be resources that are difficult to determine. The underlying tenet is that if the resource contains information that is more useful to architecture, even if it is collapsed, then record it on a NARA form. And, if the remains cannot be deciphered to a building type, record the remains as an archaeological site using the IMACS form. If in doubt, discuss with the federal agency or SHPO architectural historian.

**B**uilding: an enclosed space providing protection from the elements and that shelters some form of human activity; typically includes walls, a roof, and other components (Figure 1). “Building” may also be used to refer to a historically and functionally related unit, such as a courthouse and jail or a house and barn. Building examples: Commercial buildings may include banks; breweries; casinos; factories; stamp mills, foundries; garages; hangers; laundries; mortuaries; office buildings; railroad stations; blacksmith’s shops; stores; theaters; and warehouses; residential types may be single family dwellings, duplexes, apartment buildings, barracks, dormitories, hotels, bunkhouses, quarters, shacks, and shanties; institutional buildings may be academies, amphitheaters, armories, arsenals, asylums, aviaries; capitols and other governmental buildings, churches, courthouses, fortifications, hospitals, jails, libraries, museums, post offices, and schools; agricultural and rural buildings may be barns, cellars, blinds, kennels, pole structures, Quonset huts, sheds, stables, smokehouses, and storehouses. Trailer homes, mobile homes, pre-fabricated residences are all considered buildings.

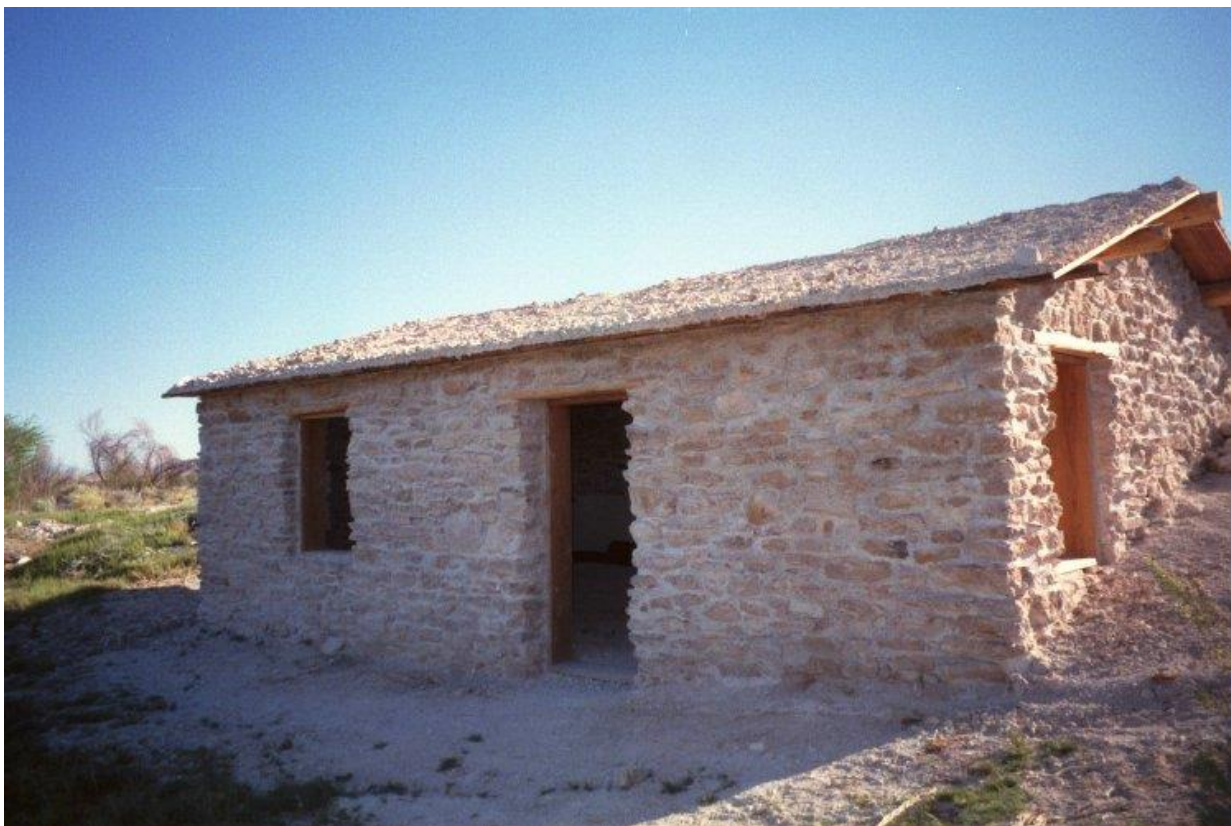

Figure 1. BUILDING: Jack Longstreet Cabin, Ash Meadows NWR (USFWS).

**Structure:** Structures are usually an engineering work, or constructed for purposes other than to provide shelter (Figure 2). Examples of structures include: aqueducts; blast furnaces; bridges; cisterns; canals; dams; fortifications; flumes; kilns; railroad grades; turntables; reservoirs; cellars; silos; snow sheds; ore bins; head frames; water tanks; viaducts; wellheads; and windmills. Linear resources such as trails, roads, ditches, fences, and powerlines can be recorded as structures or as archaeological resources. The determining factors in whether a linear resource is architecture or archaeology are based on several questions: Does the resource include an engineered attribute such as a rock lined culvert? Is the resource primarily valued for its architectural merit? Or, does the resource provide additional information to the archaeological site? (See Chapter 5, Recording Linear Resources for examples). If in doubt, please consult with the federal agency to determine the appropriate method of recordation.



Figure 2. STRUCTURE: Tybo Charcoal Kiln (BLM).

**Object:** The term “object” is used to distinguish a resource from buildings and structures as those constructions that are a material thing of functional, aesthetic, cultural, historical, or scientific value which are primarily artistic in nature or are relatively small in scale and simply constructed (Figure 3). Although it may be movable, an object is usually associated with a specific setting or environment (Figure 4). Examples of objects are boundary markers, fountains, mileposts, monuments, sculptures, statuary, signs, railroad cars, airplanes, boats, etc. Small objects are normally not eligible, such as transportable sculpture,

furniture, and other decorative arts that are not associated with a specific place. Travel trailers can be recorded as an object if not within a residential context. Road markers can be recorded as an associated resource to the road or included in a district.



Figure 3. Sign post, example of an Object (NDOT).



Figure 4. OBJECT: Winn District, Pole Canyon Wagon (BLM).



**Site:** A site is the location of a significant event, a prehistoric or historic occupation or activity, or a building or structure, whether standing, ruined, or vanished, where the location itself possesses historic, cultural, or archaeological value regardless of the value of any existing architectural resource (Figure 5). Archaeological sites are recorded on IMACS forms.

Determining if a building or structure has deteriorated to the point of a ruin and thus should be considered an archaeological site can be difficult. Based on discussions for these *Guidelines*, if a building or structure has lost most of its basic elements, and the shape, form, and use cannot be construed, then it is considered a “ruin,” categorized as an archaeological site, and recorded on the IMACS. For instance, if the only part of a building present is the chimney, then it is considered a ruin, because the architectural information is limited to one element and no information remains regarding the size or shape of the building. However, sometimes a collapsed or nearly collapsed building still retains all of its elements and can be described in architectural terms, in this case the building should be recorded on a NARA form. For instance, if the dimensions, foundation, roof, exterior cladding, or any other details are present then record it on the NARA.



Figure 5. SITE: Collapsed building and scatter of artifacts, Ash Meadows NWR (USFWS).

**Associated Resources:** A structure or building that is related to the primary resource. For example a ranch headquarters that includes a house (primary building) along with an outhouse or pumphouse (Figure 6). Or, an urban property with a house and detached garage or shed. Associated resources are secondary buildings, structures, or objects that contribute to the setting, feeling, and function of the primary

property. The property as a unit should be recorded and evaluated. More than one building on the property can be recorded and receive a B-#. For instance, the ranch house and barn can each receive a B-#. And, if all that is left on the ranch property is the tool shed or garage, then the remnant resource can be recorded as Building or Structure.



Figure 6. ASSOCIATED RESOURCE: Pumphouse, ranch property, Stillwater NWR (USFWS).

**District:** a geographically-definable area, urban or rural, possessing a noteworthy concentration, linkage, or continuity of sites, buildings, structures, or objects united historically or aesthetically by plan or physical development. A District may include architectural and archaeological resources. Individually recorded resources can be contributing or non-contributing resources of the district. If the resource is within a listed or eligible district please include the name and/or number on the NARA recording form. Townsites, ranches, mining districts, and linear resources such as railroads are often recorded as districts to encompass the variety and extent of the related features. It is possible to have a district within a district. A district designation is sometimes useful for a large, complex property with many components, but is more commonly used to distinguish urban neighborhoods that share a theme, time period, or architectural style. Twentieth century development, suburban neighborhoods, and military installations are examples of resources commonly defined as districts.

## Chapter 2 – Brief History of Architecture in Nevada

Nevada's history is reflected in its architectural resources. Carson City as the capitol city provides a snapshot of the styles, trends, and historical perspective for the state. Additionally, twentieth century developments in southern Nevada, military installations, and industrial expansion have left their mark on architecture. While it is impossible to include the entire range of historic resources within this brief history, a recently completed National Register nomination for the Carson City Westside Historic District (Pezzoni 2011) contains a review of some of the historical events and associations that affected architectural styles and is useful as a starting point for this chapter.

Beginning in 1858,

The newly established town of Carson City capitalized on the traffic that followed the California Emigrant Trail and quickly became an important link in international communications. A telegraph line reached the city from California on August 13, 1859. The line was a factor in the location of a Pony Express station in the town the following year. During the operation of the Pony Express beginning in 1860 and prior to the construction of the transcontinental telegraph line in mid-1861, westward communication first reached Carson City where it was telegraphed on to California.<sup>1</sup>

Perhaps another factor in the founding of Carson City was an expectation that it would be able to service surrounding mining communities. Curry and his partners had experience in the gold fields of California and it is conceivable they considered the possibility that substantial mineral wealth would be discovered in Nevada. They would have known about the small-scale placer mining then occurring in the mountains surrounding the city. As it occurred, major gold and silver discoveries in the Virginia Range in 1859 led to the development of the Comstock Lode and elevated Carson City's status as a supply depot.<sup>2</sup>

The construction of the Virginia and Truckee Railroad from 1869 to 1872 marked an important development in Carson City's history. The line facilitated the shipping of precious metals and supplies between Carson City and Virginia City, the two termini of the road's original section, completed in 1870. In 1872 the line was built through to the transcontinental Central Pacific at Reno, greatly enhancing market opportunities for businessmen and consumers alike. By 1875 a branch line had been constructed southward from town along Stewart Street and in 1905 this line was extended to Minden in the Carson Valley.<sup>3</sup>

Following Nevada Territorial status, Nevadans began working towards statehood... A constitutional convention met in Carson City in July 1864, the citizenry voted overwhelmingly in favor of the constitution... President Lincoln, who wanted Nevada electoral votes in time for the 1864 presidential election,... proclaimed Nevada the thirty-sixth state on October 31, 1864.<sup>4</sup>

---

<sup>1</sup> "Pony Express in Nevada;" "Central Overland Route;" Gamble, transcontinental telegraph; Angel, *History of the State of Nevada*, 553.

<sup>2</sup> Nicoletta, *Buildings of Nevada*, 11, 99; Angel, *History of the State of Nevada*, 555; Greeley, *Overland Journey*, 277; Simpson, *Report of Explorations*, 91; Works Progress Administration, *Nevada, A Guide to the Silver State*, 200; "Nevada Place Names Populations, 1860-2000."

<sup>3</sup> Ossa, "Virginia and Truckee Railroad Depot;" Drew, "Virginia & Truckee;" Works Progress Administration, *Nevada, A Guide to the Silver State*, 202.

<sup>4</sup> Bowers, *Sagebrush State*, 17, 23; Cerveri, *With Curry's Compliments*, 26-27.

Carson City's architectural development began in 1858 but something is known about the pre-existing building that helped spark the creation of the city. The Eagle Ranch trading post was described in the nineteenth century as a "fine log house" built with trees cut in nearby Kings Canyon. Log construction, a feature of Hispanic building tradition as well as European-American tradition, was well established in the West by the late antebellum period, and simple log structures were probably built during the early years of the city's development. Most descriptions and photographs of early Carson City, however, indicate the dominance of two other architectural traditions in the city's nascent development. The more ephemeral of the two was the Hispanic tradition of adobe construction. Mud, sand, and straw adobe bricks were quick and easy to make, and covered with a protective layer of mud stucco they were ideal for the dry Nevada climate.<sup>5</sup>

Carson City's earliest stone and frame houses typically reflect the influence of the Greek Revival style in their form and detail. This is not unexpected considering the popularity of the style in California during the years preceding and coinciding with the settlement boom in Nevada. The Greek Revival, as its name suggests, evoked the architecture of classical Greece (and, to an extent, Rome) through the use of the column motif, gable-front forms in imitation of pedimented Greek temple fronts, and, oftentimes, simplicity and restraint in ornamentation. The heyday of the style in its vernacular manifestations was the period from the 1830s to about 1870, although in many areas it remained common well into the late nineteenth century. Architectural historian Harold Kirker notes that the style "was the domestic vernacular on California's architectural frontier" from the mid-1840s through the 1860s....The small gable-front houses or cottage form is typical.<sup>6</sup>

Contemporary with the Greek Revival style in Carson City were the Italianate and Gothic Revival styles. The Italianate style, loosely inspired by the villa architecture of rural Italy, is most prominently displayed on the city's monumental government buildings of the boom period from the 1860s to 1870s. Round-arch windows are the distinguishing Italianate feature often with the added embellishment of paired round-arch sashes in each window, or curved brackets in its cornice, bracketed cornices being another hallmark of Italianate influence.<sup>7</sup>

The Gothic Revival style, which emulated the richly-ornamented non-classical architecture of medieval Europe, finds its fullest expression in Carson City's domestic architecture in the 1860s to 1870s period....Gothic features include narrow lancet-arch (pointed) windows, sidelight windows flanking the front entry, lancet-arch doors, ornate balconies and balustrades, tracery-like muntins between window panes, and a delicate vergeboard with cusps and quatrefoil cutouts in the steep gable of the front entry projection.<sup>8</sup>

As a side note: Greek and Gothic-Revival styles can be found on the same building. In the later Victorian period decorative wood elements were often mass-produced and shipped by rail

---

<sup>5</sup> Stilgoe, *Common Landscape of America*, 38; Kirker, *California's Architectural Frontier*, 3-4, 9; "Adobe;" Greeley, *An Overland Journey from New York to San Francisco*, 277; Cerveri, *With Curry's Compliments*, 13; Angel, *History of the State of Nevada*, 551, 137, 533.

<sup>6</sup> Kirker, *California's Architectural Frontier*, 41, plates 13, 14, 24; Uhlhorn, *Virginia and Truckee Railroad Directory, 1873-74*, lii.

<sup>7</sup> Angel, *History of the State of Nevada*, 97; Chambers, "Mathias Rinckel Mansion;" Goodwin and Wieprecht, *First Presbyterian History*, 2, 38.

<sup>8</sup> Harmon and Rocha, "Foreman-Roberts House;" Nicoletta, *Buildings of Nevada*, 101-103, 107, 108-109; Humphreys, "Ormsby-Rosser House."

creating the potential for inexpensive ornate elements easily added to buildings. Booms periods in many towns can be dated by the style of their large public buildings.

And back to the Carson City history (Pezzoni 2011):

Most Carson City residences were accompanied by outbuildings that served for storage or domestic functions. Early photographs show these to have been mostly gabled or shed-roofed frame structures with weatherboard, vertical board, or board-and-batten siding. Some would have been built of adobe and log, as noted before, and there are a few surviving stone and brick examples.

Multifunctional outbuildings of characteristic long narrow form were popular in the district during the nineteenth and early twentieth centuries. Typically these buildings have multiple doors and windows for entering and lighting the various specialized spaces. Frame construction and shed roofs are common features of the buildings. The linear shed-roofed outbuilding form was already common by 1875 as shown in the bird's-eye perspective of that year. Probably a few of the long outbuildings included space for carriages or buggies.

Many of Carson City's late-nineteenth-century houses can be grouped under the more general term Victorian. The wood-working plants established in the vicinity in the late 1860s and 1870s were presumably a leading source for the mass-produced brackets, porch elements, and other fancy millwork that adorn Carson's Victorian dwellings. Another common feature of Victorian domestic architecture is the bay window, a typically rectangular-plan or angled projection with multiple windows designed to funnel light into an interior... In Carson City there is evidence that a number of houses built in the 1860s and early 1870s had their bay windows added years or decades after original construction...Conservatory was another name for a bay window that in local usage implied a larger construction almost approaching a greenhouse wing in size and number of windows.<sup>10</sup>

Several of the district's houses illustrate the Second Empire style, a French-derived style distinguished by its use of the tall mansard roof form... Another popular style of the era was the Queen Anne style, characterized by complex massing and roof lines, textured wall claddings such as decorative shingles, and gracious verandas that often wrap around two or more sides of a dwelling. The style was prevalent nationally during the decades around 1900...The purest example of the Classical Revival style in the district is the 1908-09 Governor's Mansion at 606 Mountain, a broadly proportioned residence with a monumental Ionic portico and a one-story wraparound veranda.<sup>11</sup>

From the outset, Carson City's houses reflected the influences of styles that were popular nationwide. This trend became even more pronounced in the twentieth century with the introduction of Craftsman style houses to the district (Figure 7). The Craftsman style was closely intertwined with a specific house type—the one-story or story-and-a-half bungalow form—which saw its earliest American development in California during the first decade of the twentieth century before rocketing to popularity in the 1910s and 1920s. Bungalow designs were widely disseminated through print media such as magazines and plan books while companies like Sears, Roebuck, Montgomery Ward, and Aladdin shipped entire houses as disassembled kits.

---

<sup>10</sup> Angel, *History of the State of Nevada*, 549; Serafin, Pezzoni, and Pruitt, "Kelly-Schulz House;" Cerveri, *With Curry's Compliments*, 76.

<sup>11</sup> Wieprecht, "Brougher Mansion;" Wieprecht, "Governor's Mansion".

Beginning probably in the 1910s, the dawn of the nation's Automobile Age, Carson City homeowners' added garages to their properties. These are typically frame buildings of gable-fronted form and weatherboard or board-and-batten siding, their diminutive scale a reflection of the small size of cars at the time. It is conceivable some of the district's garages were converted from carriage or buggy houses. By the 1920s and 1930s a few houses were built with attached garages...After World War II, as car sizes increased, the detached garages built in the district also tended to increase in size and more multi-vehicle garages were constructed...The architectural coordination of houses and garages was introduced to the district during the interwar period.



Figure 7. Craftsman style home in Sparks, Nevada (Ron Reno, 2009).

Mission-style buildings represent one of the exotic styles popular nationwide during the first half of the twentieth century. The Mission style evoked the colonial architecture of California in particular and the traditions of the Mediterranean world in general through the use of such treatments as stucco and Spanish roof tiles...other features of the style include round-arch window, door, and porch openings and a squat tower-like element that recalls the bell towers of Spanish missions. The Tudor Revival, another exotic style of the era...is associated with a front chimney, entry porch, and false half-timbered gables. The Ranch style, like the earlier Craftsman style, was a California import. The long, low-slung, mostly gabled Ranch (or "Rambler") form was inspired by the Golden State's tradition of unpretentious ranch houses as interpreted by architects beginning in the 1930s.<sup>12</sup>

"The Colonial Revival style, which saw its first flush of popularity in Nevada in the 1930s, continued in use after World War II"(Pezzoni 2014, personal communication). Post-World War II housing exuberantly embraced the emerging Ranch-style and created several sub-styles, including the Split-Level, Contemporary, and Contractor Modern. The 1950s-1970s also saw influences from the classic styles re-imagined with grander scale, new materials, and combinations to create Neo-Tudor, Neo-Victorian, McMansions, etc. Experimenting with shapes and materials led to the design and construction of Geodesic Domes; A-Frames; and modular or mobile homes. The post-war boom also led to the creation of suburban neighborhoods created with very consistent architectural elements. The uniform appearance of the streets has been much maligned for lacking in creativity, but the mass-produced housing boom met a need of the returning military and the GI bill which guaranteed low interest loans for houses. The growing

<sup>12</sup> James and Harvey, *Nevada's Historic Buildings*, 166-167.

middle-class relied on automobiles rather than city mass-transit which further created the suburban neighborhood and houses with attached garages. The growth of the size and prominence of garages since the 1970s is epitomized by the “snout-house” style whereby the garage completely dominates the house façade. Cities such as Las Vegas were essentially developed overnight by developers with nearly uniform styles reflected in the neighborhoods. Walled neighborhoods is a later nuance that creates clear boundaries between the urban and suburban landscapes.

Smaller towns in Nevada may reflect the entire range of architectural styles and chronological periods within a single street or a few blocks. Understanding architecture as reflecting the mechanism of change is an important element in a historic context.

Architectural styles continue to change as new materials, social trends, population dynamics, and creativity contribute to the development of new styles. As the 50 year criteria for consideration creeps forward, understanding and documenting the new trends and styles is a critical element that will need to be included in updated versions of this document.

Nevada has a strong vernacular tradition. In fact, vernacular forms are so common in Nevada that they are often viewed as “styles” in their own right. Vernacular in Nevada takes many forms and crosses every time period. Vernacular can also be used to describe a “true” style that has idiosyncratic elements or casual attention to the true representation of the style. Standard architectural descriptions are sometimes difficult to impose on vernacular buildings which can only be described based on the individualistic details of materials and workmanship. Vernacular can be used to describe buildings created from local materials, constructed with the skills and tools at hand. For instance, cabins built in mining camps, homesteads, and ranches often exemplify the “true vernacular style” that is unique, charming, and possibly reminiscent of a period style. Vernacular buildings can also evoke the period of construction by the materials used, such as flattened tin cans in a mining community or railroad ties from abandoned railroads (Figure 8).



Figure 8. Vernacular example – RR-Tie Cabin, Pahrnagat NWR (USFWS).

## Chapter 3 – Historic Contexts

Historic Contexts are valuable research tools that provide a solid basis for understanding, describing, and evaluating historic resources. Essentially an analytical tool for evaluating historic resources, a historic context is a statement that characterizes the time period, place, and theme(s) of a project/property and provides a basis for understanding significance and creates an inventory of property types and systematic process for evaluating resources. Historic contexts should be developed at an appropriate scale to the size and level of complexity of the project or survey.

Much of the information below was provided by NDOT from their cultural resource guidelines (2013), along with information from the National Park Service’s White Paper, “The Components of a Historic Context,” prepared by Barbara Wyatt in 2009, and from the website at [http://www.nps.gov/nr/publications/bulletins/nrb15/nrb15\\_5.htm](http://www.nps.gov/nr/publications/bulletins/nrb15/nrb15_5.htm).

*Definition of the Context* -- the three elements of a historic context are the theme, geographic parameters, and temporal limits:

Theme: The historic context could be guided by the thematic study units identified in the *Nevada Comprehensive Preservation Plan* (1991) and National Register Bulletins.

Place (Geographic Parameters): Geographic parameters can be based on a variety of factors. They may be determined by the extent of a survey effort, such as the Lincoln Highway through Nevada, or by municipal boundaries, such as Cast Iron Architecture in Virginia City.

The selected geographic parameters must be justified in the context. For example, generally the boundaries of a historic district do not constitute sufficient geographic parameters for the historic context. If bungalows and foursquare houses contribute to an architecturally significant district, the context needs to explain the manifestation of these house types in the broader neighborhood and city. In some cases, the introduction of a style or the occurrence of an event is explained from a statewide or national perspective.

Time (Temporal Limits): The temporal limits of a context are generally based on the earliest and latest occurrence of an event, activity, or date of development/construction.

For example, one assumes a context called *Atomic Testing in Nevada* relates to 1951-1992; however, the context could extend to events leading up to the testing of atomic weapons and events that happened shortly after testing stopped. If so, the temporal limits should state the year of the earliest event and latest event that are considered within the parameters of the context.

Once the parameters of the study are clearly stated then it is useful to present a brief overview of the history of the geographic area encompassed by the context, with a focus on its relationship to the property. Based on the background study a list of property types, important individuals, events, or trends should be defined. Armed with this information, the surveyor should be able to recognize the properties that match the expectations and those that do not.

Historic contexts can be developed for National, State and Local levels of importance. Suggestions regarding information to include in contexts that are state and local in scope are provided below.



**Statewide Contexts:** For contexts of statewide significance, describe how the historical themes generally unfolded in the state. A historic context for Agriculture --cattle ranching in Nevada, could be developed as follows:

- Identify the geographic area and time period of the context;
- Provide a brief history of cattle ranching in the area and relate it to state development;
- Describe the types of buildings, structures, and objects that are part of a ranch;
- Describe the property types that you expect or that are represented on the property;
- Compare the subject property with other ranches in the state;
- Describe any new property types that add to our understanding of cattle ranching in Nevada;
- Describe any connection with ethnic groups;
- Document the individuals associated with the ranch and determine if they made contributions or advances in cattle ranching that are recognized statewide; and
- Describe the level of integrity of the property types based on comparisons with other evaluated ranches.

**Local Contexts:** For local contexts, describe how and why the theme or Area of Significance developed. Discuss the contributions of individuals or groups, and present factors outside the local area that influenced the theme, such as technological advances, the completion of transportation networks, the emerging popularity of an architectural style, or a boom in the national economy that may have had a direct impact on the local context.

**Property Types:** Identify the types of resources that are related to the context and their locational patterns. Property types should be inclusive, reflecting all manifestations, throughout the period and the area encompassed by the theme. For example, properties associated with hay farming in Nevada may reflect agriculture, as well as transportation, marketing, and technological developments. Therefore, various types of agricultural buildings, structures, and landscapes may be associated with hay farming. Be as specific as possible in identifying property types. Information about the occurrence and survival of property types should be presented, as well as general impressions about their adaptive uses and condition.

**Character-Defining Features and Integrity:** Define the essential physical features that are “character-defining” for each property type. Then, discuss how the seven aspects of integrity are represented by the property as based on National Register Bulletin 15: *How to Apply the National Register Criteria for Evaluation*. The property should also be compared with other examples to determine how well it represents the character-defining elements in order to determine eligibility to the National Register of Historic Places (NRHP).

**Bibliography:** The historic context may distill a great deal of research and fieldwork into a relatively brief document. Because of the summary nature of the documentation, it is essential to include a bibliography of sources consulted in its preparation. The bibliography should not be a “reading list,” but sources that are cited in the text or that directly influenced the content of the context.

**Application of the Criteria** (from *Secretary of the Interior's Guidelines for Evaluation*, refer to Chapter 6 <http://www.nps.gov/history.htm> for more information on significance criteria and integrity).

The first step in evaluation is considering how the criteria apply to the particular historic context. This is done by reviewing the previously developed narrative for the historic context and determining how the criteria would apply to properties in that context, based on the important patterns, events, persons and cultural values identified...This step includes identification of which criteria each property type might meet and how integrity is to be evaluated for each property type under each criterion. Specific guidelines for evaluating the eligibility of individual properties should be established. These guidelines should outline and justify the specific physical characteristics of data requirements that an individual property must possess to retain integrity for the particular property type; and define the process by which revisions or additions can be made to the evaluation framework (*The Secretary of the Interior's Standards for the Treatment of Historic Properties*, 1995).

The evaluation of eligibility to the NRHP generally includes:

- Classifying a property within an appropriate historic context(s) and property type(s). If no existing property type is appropriate, a new property type is defined, its values identified, and the specific characteristics or data requirements are outlined and justified as an addition to the historic context. If necessary, a new historic context is defined for which values and property types and their integrity requirements are identified and justified.
- Comparing the existing information about the property and the integrity characteristics or data required for the property type.

The evaluation should state how the particular property meets the integrity requirements for its type. The seven aspects of integrity are: location; design; setting; materials; workmanship; feeling; and association. Essentially, the reason the property is important, its character defining features, need to be evaluated against the aspects of integrity. As an example, on a street with 10 ranch style houses, is there one that is more intact, has more of the ranch-style characteristics than the others? Integrity should be a tool for identifying the “best” example of a particular style. For vernacular properties, this is more difficult, but should be geared toward why the building is important, and how strongly it conveys that value. “When a property is disqualified for loss of integrity, the evaluation statement should focus on the kinds of integrity expected for the property type, those that are absent for the disqualified property, and the impact of that absence on the property’s ability to exemplify architectural, historical, or research values within a particular historic context (*Secretary of the Interior's Guidelines for Evaluation*).” Evaluating object’s integrity is difficult, but should be based on the setting that is appropriate to their significant historic use, role, or character.

### **Researching Historic Resources**

How old is the resource? What was it used for? Who built it? Who used it? When was it altered or moved? These are simple questions, but the answers are not always apparent without research. Searching for information at historical societies, museums, archives, libraries, and photo collections can answer some questions. For most architectural surveys conducted to satisfy Section 106 requirements, the purpose of the survey is to evaluate a resource for its eligibility to the NRHP. Research should

concentrate on gathering information about the initial construction, period of use or significance, persons associated with the property, and alterations to the building or function of the property. Research should be focused on answering the question: Does this resource meet the requirements for listing on the NRHP under criterion A, B, C, or D?

A list of selected museums, libraries, historical societies and other organizations that may be useful for research on historic resources is included in Appendix H. Below are a few of the research tools available. And, luckily today, many of the sources have on-line access.

*Historic Topographic Map:* Topographic maps are useful for establishing the development of transportation routes, locating springs, and charting the growth of townsites, among other things (Figure 9). Current and historic topographic maps are available at the USGS website: [www.usgs.gov](http://www.usgs.gov).

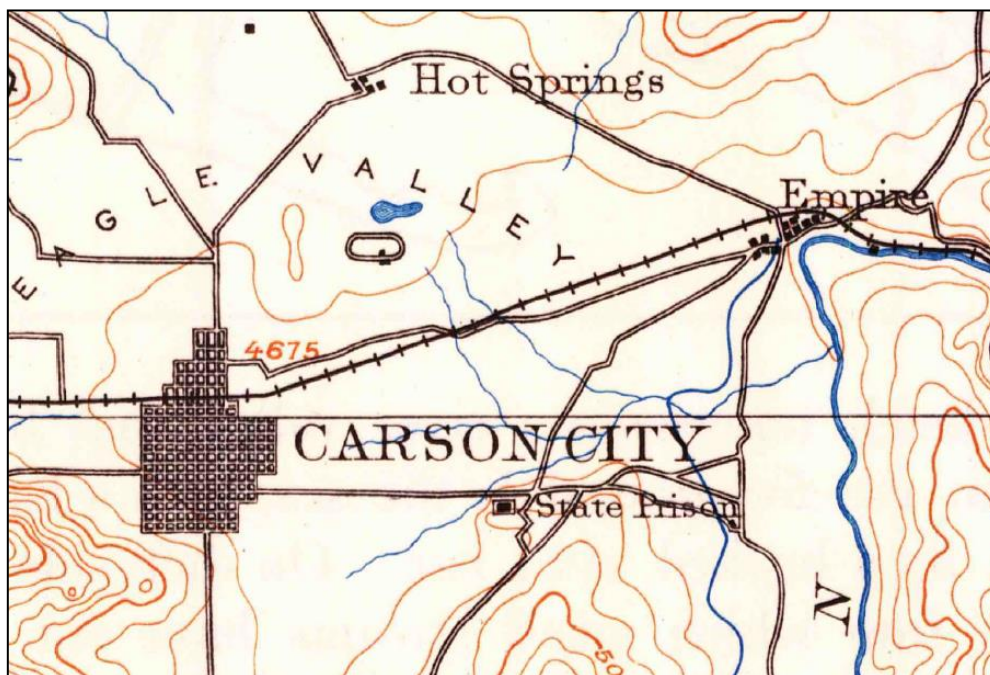

Figure 9. Topographic map from 1893. Map shows Carson City, the state prison, railroad lines, roads, and even Theodore Winter's oval horse racing track northeast of Carson City. Dense urban centers such as Carson are depicted with a grid. Lesser populated towns, such as Empire, may show the location of individual buildings represented by a black rectangle.

*General Land Office (GLO) Maps:* The GLO surveyed and platted the western United States for the purpose of selling public land. The maps they created for Nevada in the 1870s-1900s often show vast expanses of undeveloped land, but they also show ranches, cultivated land, springs, and roads. To find GLO maps, identify the Township, Range and Section(s) of the survey area and then access the BLM website at: [www.nv.blm.gov/LandRecords/](http://www.nv.blm.gov/LandRecords/). Or, the DeLaMare Library at UNR has a map library on-line link: [www.delamare.unr.edu/maps/digitalcollections/nvmaps/plats/default.htm](http://www.delamare.unr.edu/maps/digitalcollections/nvmaps/plats/default.htm)

*Sanborn Insurance Maps:* These historic maps produced by the Sanborn Insurance Company provide detailed information on the location of buildings, what material they were made

from, how tall they were and notes on what kind of infrastructure a town had (Figure 10). The maps span from 1867 to 1970 and the company is still in business today. Historic Sanborn Maps for many Nevada towns are available on-line through the DeLaMare Library (see link above). While the UNR library has digitized most of the Sanborn maps available for Nevada, it is not a complete collection. Other Sanborn maps can be found at libraries, including the Nevada State Library & Archive in Carson City, either as a hardcopy or on microfilm. A complete set of Historic Sanborn maps are also available through ProQuest at this website: [www.sanborn.umi.com/](http://www.sanborn.umi.com/). The website can be accessed for free at some libraries or by a paid subscription.

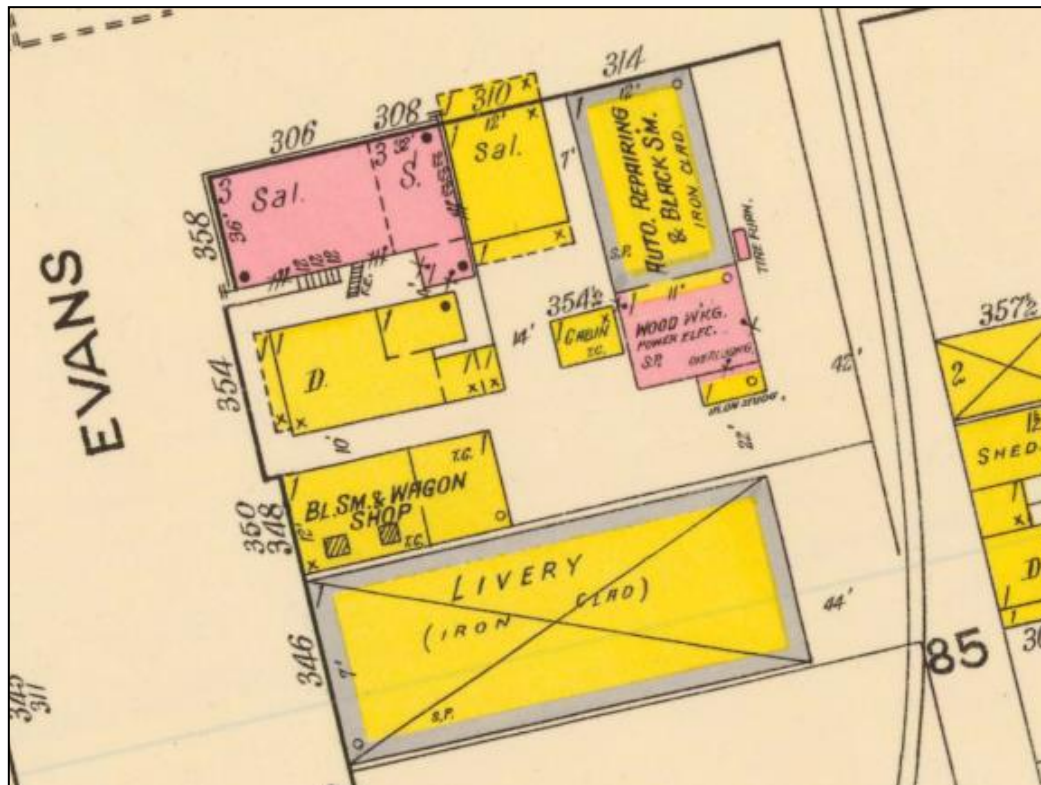

Figure 10. Detail from the Reno 1918 Sanborn insurance map. Pink indicates a brick building, yellow is wood frame, and “D” stands for “Dwelling.”

*Federal Agency Records/Maps:* Many Forest Service offices have maps dating from 1906. Homestead records are available through the National Archives. Individual agency offices often have institutional histories, historic photographs, and maps related to their lands. Contacting the cultural resources specialist at each office or agency is recommended.

*State Records:* The Nevada Department of Water Resources online database is another research tool. Their records on water rights are extremely useful for researchers of ranches as well as mining districts. Many of the water rights applications include maps that have buildings, structures, mines, roads, etc. on them and show changes over time.  
[www.water.nv.gov/waterrights/](http://www.water.nv.gov/waterrights/)

The Nevada Department of State Lands has a searchable database for land records, such as homesteads filed on state lands. [www.lands.nv.gov/patent/patents.htm](http://www.lands.nv.gov/patent/patents.htm)

Nevada Department of Transportation (NDOT), conducts archaeological and architectural inventories and should be contacted if a project is near a state road.

*Aerial Photographs:* Some of the earliest aerial photographs of Nevada date to the 1930s when NDOT began taking photographs from an airplane to aid in surveying for road construction. The Highway Department's collection of aerial photographs was donated to the Nevada Bureau of Mines and Geology.

The US military and Forest Service also conducted many early aerial surveys of Nevada. These photographs occasionally pop up in historical society and museum collections. The Bureau of Mines and Geology has an extensive collection of aerial photographs. Aerial photographs of varying qualities are available for free from the website: [www.historicaerials.com](http://www.historicaerials.com)

*Criss-Cross City Directories:* Criss-Cross city directories are a telephone/address book that can be searched either by knowing the address or by knowing the name of the person or business. Far more than just a phone book, these directories listed an individual's profession and whether they owned or rented their home. The directories also had general histories of the town, along with maps, photographs, statistics, and advertisements (Figure 11).

Luskey Brothers & Co. and the R. L. Polk & Co. produced most of the directories in Nevada. Luskey's and Polk Criss-Cross directories can be found at most local libraries and some have been scanned and are available for free on Google Books: [www.books.google.com](http://www.books.google.com).

*County Assessor's Records:* County assessor's records can provide information on the date a building or structure was listed on tax rolls, *usually* this coincides with the construction date or when alterations were made. Sometimes floor plans and photographs of the building or structure are included in the records. Almost every county in Nevada has a searchable on-line database. However, if the scope of the survey requires more intensive research, a visit to the assessor's office will probably be necessary. Chain-of-title searches are valuable to establish the name of the original owner, subsequent owners, and can sometimes provide additional details about the property. County records may also be compiled in such a way as to provide false data. For instance, in Clark County building records begin from the early 1920s, so that is what is listed as the earliest construction date. And, if a building was constructed in 1933 without a permit, but then got a permit in 1945, only the 1945 date will show up as the construction date. So, be aware when researching that some dates may be inaccurate. Assessor Parcel Numbers (APN's) also can change over time.

*Historic Photographs:* Historic photographs have to be worth more than a thousand words for all the information they can provide. Libraries, museums, historical societies, private collections, and universities are all good places to start searching for historic photographs (Figure 12).



Figure 11. Advertisement from the Luskey's 1961 Henderson-Boulder City Directory.

Some on-line finding aids and digital collections include:

- Frasher Foto Collection at the Pomona Public Library: [www.content.ci.pomona.ca.us/index\\_frasher.php](http://www.content.ci.pomona.ca.us/index_frasher.php)
- Matthewson-IGT Knowledge Center Special Collections, Photograph Collections: [www.knowledgecenter.unr.edu/materials/specoll/photos.aspx](http://www.knowledgecenter.unr.edu/materials/specoll/photos.aspx)
- Nevada Historical Society: [www.renotahoe.about.com/gi/o.htm?zi=1/XJ&zTi=1&sdn=renotahoe&cdn=citiestowns&tm=5&f=00&su=p284.13.342.ip\\_p554.23.342.ip\\_&tt=11&bt=3&bts=12&zu=http%3A//museums.nevadaculture.org/index.php%3Foption%3Dcom\\_content%26view%3Darticle%26id%3D446%26Itemid%3D401](http://www.renotahoe.about.com/gi/o.htm?zi=1/XJ&zTi=1&sdn=renotahoe&cdn=citiestowns&tm=5&f=00&su=p284.13.342.ip_p554.23.342.ip_&tt=11&bt=3&bts=12&zu=http%3A//museums.nevadaculture.org/index.php%3Foption%3Dcom_content%26view%3Darticle%26id%3D446%26Itemid%3D401)
- State Library & Archives: [www.nsla.nevadaculture.org/index.php?option=com\\_content&task=view&id=657&Itemid=418](http://www.nsla.nevadaculture.org/index.php?option=com_content&task=view&id=657&Itemid=418)
- University of Nevada, Las Vegas, Photograph Collections: [www.library.unlv.edu/speccol/photographs/photos.html](http://www.library.unlv.edu/speccol/photographs/photos.html)
- University of Nevada, Reno, Digital Conservancy: [www.contentdm.library.unr.edu](http://www.contentdm.library.unr.edu)
- Western Nevada Historic Photo Collection: [www.wnhpc.com](http://www.wnhpc.com)

*Historic Newspapers:* Many historic newspapers are being scanned with optical character recognition software, which can make searches much easier. Some of the more obscure newspapers may still only be found on microfilm stored in libraries and historical societies. The most complete single repository of digitally scanned newspapers is Newspaper Archive ([www.newspaperarchive.com](http://www.newspaperarchive.com)). It requires a subscription, but can be accessed for free at some libraries, including the Nevada State Library & Archive in Carson City. Adjoining states newspaper records should also be researched.



Figure 12. A 1927 photograph of Aurora from the Frasher Foto Postcard Collection at Pomona Public Library.

*Genealogy:* The history of buildings is the history of people. There are many genealogy sources that can offer crucial information about a building and its inhabitants. [www.ancestry.com](http://www.ancestry.com) provides on-line access to national census records, draft records, city directories and other useful resources; however, it does require a paid subscription.

*Oral Histories:* Talking to former or current owners, residents, employees, family members or neighbors connected with a historic resource can provide information that can be found nowhere else. Most people appreciate contributing their first-hand knowledge to the historic record. Enlist the help of museums and historical societies to find knowledgeable people in the community. The University of Nevada maintains an Oral History Archive on-line at: [www.contentdm.library.unr.edu/digitalprojects/unohp/UNOHP-home.html](http://www.contentdm.library.unr.edu/digitalprojects/unohp/UNOHP-home.html)

## Chapter 4 – Project Planning and Section 106

Identifying the project parameters and requirements is the initial phase of planning. While not all architectural surveys are associated with a Federal undertaking as defined in Section 106 of the National Historic Preservation Act (NHPA), the planning steps presented in the NHPA provide a standard outline that any survey can use. See Advisory Council on Historic Preservation for information on Section 106 at <http://www.achp.gov/> or the Nevada State Historic Preservation Office <http://www.shpo.nv.gov/>. Often a local government or agency receives funds from a federal source and carries out the survey in order to assist the federal agency to comply with Section 106. Grant programs can require the agency to hire consultants and conduct surveys to identify historic properties and meet Section 106 conditions.

Federal agencies follow the process outlined in 36 CFR 800.3, as initiating the Section 106 process: establish the undertaking; identify appropriate SHPO/THPO and identify interested parties for consultation; define the Area of Potential Effects (APE); identify historic properties.

*Determining an Undertaking:* The agency official shall determine whether the proposed Federal action is an undertaking and, if so, whether it is a type of activity that has the potential to cause effects on historic properties.

*SHPO/THPO consultation:* As part of its initial planning, the agency official shall determine the appropriate SHPO(s) to be involved in the section 106 process. And, whether the undertaking may occur on or affect historic properties on tribal lands and, if so, whether a THPO(s) has assumed the duties of the SHPO.

*Public Participation:* In consultation with the SHPO/THPO, the agency official shall plan for involving the public in the section 106 process. The public includes local governments, Indian tribes, and individuals or organizations that request to be included in consultation, in writing.

*Area of Potential Effects (APE):* The federal agency determines the size, complexity, and sensitive issues associated with the project which defines the APE. The federal agency usually transmits the project information to the SHPO/THPO for review and acceptance to ensure that all activities associated with the project are included.

As defined in 36 CFR 800.16(d), an APE is

the geographic area or areas within which an undertaking may directly (caused by the undertaking) or indirectly (caused by the undertaking and are later in time, further in distance, or are cumulative but are still reasonably foreseeable) cause alterations in the character or use of historic properties, if any such properties exist. The area of potential effects is influenced by the scale and nature of an undertaking and may be different for different kinds of effects caused by the undertaking.

An APE depends on an undertaking's potential for effects. Effects to be considered may include, but are not limited to; physical damage or destruction of all or part of a property; physical alterations; moving or realigning a historic property, isolating a property from its setting; visual, audible, or atmospheric intrusions; vibrations; and change in access or use.

An APE delineates the boundaries within which it can be reasonably expected that a proposed undertaking has the potential to affect historic properties, should any be present. An APE includes project-related activity areas such as utility relocations, access roads, staging areas, equipment storage areas, or conservation or scenic easements that are set as part of the project prior to contracting.

An APE must also address indirect effects and cumulative effects. Indirect effects may include, but are not limited to: visual, audible, or atmospheric intrusions; vibrations from construction activities; or change in access or use. Indirect effects can also include growth-inducing effects and other effects related to changes in the pattern of land use, population density, or growth rate. Cumulative effects reflect the likelihood of subsequent actions that will affect historic resources, for instance, if one house is slated for demolition as the current APE, but within 5 years another few houses will be demolished, then the entire project should be considered. Delineation of the APE must be considered carefully.



Buildings, structures, objects, and districts are more likely to be subject to indirect, as well as direct, effects; thus an inventory for the built and cultural environment is usually broader than an archaeological inventory in order to identify properties that would be affected indirectly. For instance, the first row of houses beyond the right-of-way may be subject to such effects, and thus be included in an indirect APE. If the project scope is revised, the APE needs to be revised commensurate with the nature and scope of the changed potential effects.

#### *Level of Effort (36CFR800.4(b)(1):*

The agency official shall make a reasonable and good faith effort to carry out appropriate identification efforts, which may include background research, consultation, oral history interviews, sample field investigations, and field survey. The agency official shall take into account past planning research and studies, the magnitude and nature of the undertaking and the degree of Federal involvement, the nature and extent of potential effects on historic properties, and the likely nature and location of historic properties within the area of potential effects.

#### **Pre-Fieldwork Planning**

The following identification efforts are recommended for a project that may include architectural resources:

- A search of the SHPO Architectural Database and reports, contact the NVCRIS manager;
- A search of other known architectural history documents that may not be included in the SHPO Architectural Database, such as NDOT architectural reports, historic contexts, and architectural reports prepared by or for other agencies;
- A search of the NPS NRHP Database (<http://www.nps.gov/NR/research/>);
- A search of the county assessor records for the date of construction;
- A search of county museums, libraries, and archives (see Appendix H);
- Search of federal agency records and files and National Archives; and
- Search of historic maps and GLO records.

#### **Requesting SHPO Resource Numbers**

Like archaeological sites, SHPO requires that each architectural resource have a unique ID number. This is the “SHPO Resource Number” and will start with either “B,” “S,” “O,” or “D” depending on whether the resource is a **building**, **structure**, **object**, or **district**. You must have a SHPO Resource number before a NARA form can be submitted to SHPO. Associated resources do not receive their own number. If the resource is determined to be a ruin or site, then it should be recorded on an IMACS site form and will receive a trinomial number. For resources that include associated or overlapping architecture and archaeological resources, the identification numbers should be cross-referenced on the forms.

To request an SHPO Resource number, send an e-mail with the following information to SHPO staff:

- A PDF of the first page of the NARA form(s) (a draft version is acceptable);
- If on federal land, include the Federal agency number;
- A GIS shapefile with a point, polyline, or polygon indicating the location of the resource. Multiple points, polylines or polygons for multiple resources can be in one shapefile. (If you don’t have access to GIS, see the following section, “What if I Don’t Have Access to GIS?”);

- Most buildings, structures and objects will be represented with a **point** shapefile. Place the point in the center of the resource;
- Linear resources are represented with a **polyline** shapefile. If you are evaluating a *segment* of a linear resource--for example, a one mile segment of railroad track--the polyline will be the length of the recorded segment only, not the entire rail line;
- District boundaries are represented with a **polygon** shapefile; and
- All GIS information needs to be projected in **NAD 83**.

If you are requesting SHPO Resource numbers for multiple resources, make sure there is a way to link the points in the shapefile to the first page of the NARA form, such as having the resource’s address, name, or a unique field ID number included in the shapefile’s “Attribute Table” (Figure 13).

*What if I Don’t Have Access to GIS:* If you don’t have access to GIS you will need to go “old school” and submit a paper map instead of a GIS shapefile. SHPO will use the paper map to plot the location of the resource into their GIS database. For consistency, SHPO requests that the location of the resources be legibly identified on a 7.5 minute topographical (topo) map at an appropriate scale (in other words, big enough to see the individual resources clearly but with enough context around the resources that it can be located on the map). Essentially, this will be the “Location Map” that is required in the NARA form (Figure 14).

FID	Shape *	Id	SHPO_ID	Name	Address	City	County	Parcel	Type
0	Point	1		Currie Depot	North of US 93	Currie	Elko	Unknown	Building
1	Point	2		Currie Hotel	North of US 93	Currie	Elko	009030003	Building
2	Point	3		Goshutes Store	North of US 93	Currie	Elko	Unknown	Building
3	Point	4		Water Tank	North of US 93	Currie	Elko	009030125	Structure
4	Point	5		Gas Station Sign	72 US 93	Currie	Elko	009030126	Object

Figure 13. When requesting an SHPO Resource number, the shapefile’s Attribute Table should have unique identifying information, such as the resource name, address, or parcel number, so that the point can be linked to the correct NARA form.

The easiest way to find the correct 7.5 minute topo map is to use the “Map Locator & Downloader” tool available for free at [www.usgs.gov](http://www.usgs.gov). Giving the SHPO a fragment of a topo map with the location marked on it is not going to be very helpful. You will also need to provide them the quadrangle map name, Township, Range, and Section.

If you don’t have access to GIS, you might want to consider downloading ArcGIS Explorer Desktop. It is a free GIS viewer that allows you to use a limited number of basemaps. You will not be able to create georeferenced shapefiles in ArcGIS Explorer Desktop, but you can draw the location of the resources on the basemaps. For more information about ArcGIS Explorer Desktop see [www.esri.com](http://www.esri.com).

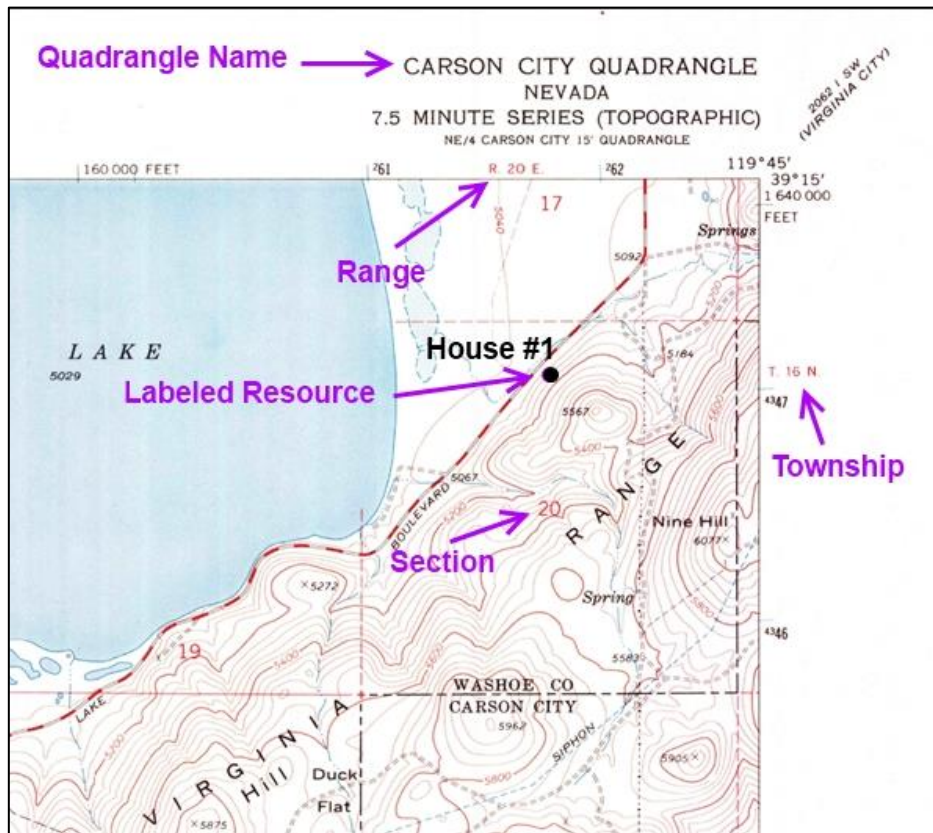

Figure 14. "House #1" is located in Township 16 North, Range 20 East, Section 20 on the Carson City Quadrangle.

### File Searches

The purpose of the file search is to establish what surveys have already been done in the area. Nevada does not have a centralized database where you can check for all previous architectural surveys and results. To establish if there are any previous architectural surveys that overlap or are near your survey area, check these resources:

*Nevada State Historic Preservation Office (SHPO):* Nevada surveys that completed the Section 106 or the Section 110 process are archived at the State Historic Preservation Office, along with letters documenting the agency's determination of eligibility and SHPO's comments. If you need copies of the reports and inventory forms contact SHPO.

Nevada SHPO Architectural GIS Database: The SHPO has a database of architectural properties that were documented on a variety of forms such as the Historic Resources Information Form, Architectural Resource Assessment Form, etc. SHPO can supply you with a data cut of the GIS layer, as well as copies of the forms and selected portions of the original survey report (usually the cover page, table of context, and bibliography). To make a request, contact SHPO Staff (775-684-3450).

Nevada Cultural Resource information System (NVCRIS): NVCRIS, is the *archaeological* database maintained by SHPO and available by subscription. Until recently, many architectural resources in rural areas were recorded as part of an archaeological survey.

Linear resources such as roads, railroads, canals and telephone lines are often categorized as “archaeology”, depending on their context, and will be identified in NVCRIS. Non-archaeologists usually do not have access to NVCRIS because it contains confidential information that is protected from the Freedom of Information Act. If you do not have access to NVCRIS, contact the SHPO to request a search of architectural resources identified by NVCRIS. Cultural resource surveys have only been completed for about 12% of the state, so there are many areas that have not been inventoried.

*National Park Service Database:* This is an on-line database of all properties that have been listed on the NRHP. It is searchable by location or property name. Many properties have a scan of their NRHP nomination form and one or two photographs. The website is: [www.nps.gov/nr/research](http://www.nps.gov/nr/research)

*Federal Agencies:* If an architectural survey was completed for a federal agency a copy of the report is usually filed at the agency office. If your survey area is on federal land, check with the appropriate federal agency for previous architectural reports. Landowning federal agencies in Nevada include: Bureau of Land Management; Bureau of Reclamation; National Park Service; National Forest Service; US Fish and Wildlife Service; Department of Defense (Navy and Air Force); and U.S. Department of Energy.

*Other Agencies:* Certified Local Governments (CLG) and the Nevada Department of Transportation (NDOT) also maintain architectural surveys. There are four CLGs in Nevada: Carson City, Las Vegas, Reno, and Storey County’s Comstock Historic District. If your survey area includes any of these CLGs, check with them for previous survey information (See Appendix H for contact information).

### **Survey “Cut-off” Dates**

Architectural resources that are less than 50 years old are usually not considered for NRHP eligibility unless they meet one or more of the seven special criteria considerations. Because projects often take several years to complete, and resources may turn 50 years old before the project is completed, the Agency or project proponent may require resources that are less than 50 years of age, usually 45 years, be included and evaluated for the NRHP. The evaluation will be based on their integrity and significance as if they met the 50 year criterion.

### **Permission from Land Owners**

Historic resources often cross on to private land or the survey may include a neighborhood or ranch that is privately owned. Linear resources in particular often cross many jurisdictions. Planning the survey and determining land ownership from records at the office of the county recorder, county assessor, or BLM-land records will ensure correct identification of property ownership, so that property permission can be obtained prior to fieldwork.

## Chapter 5 – Fieldwork and Standards of Recordation

With the planning and initial background research completed and armed with a historic context, the next step is fieldwork. Surveyors should be aware of the property types expected, but also be open to finding previously undocumented resources. It is common to find evidence of roads, irrigation ditches, or buildings that may not fit the historic context expectations, but will require documentation and additional research. The historic context works best as a flexible, dynamic document that assists with fieldwork and is improved by survey results. Included in this chapter are a few suggestions for the procedures for recording architectural resources.

**Professional Qualifications:** A person who meets the *Secretary of the Interior's Historic Preservation Professional Qualification Standards* (36CFR61, Appendix A, [http://www.nps.gov/history/local-law/arch\\_stnds\\_9.htm](http://www.nps.gov/history/local-law/arch_stnds_9.htm)) (see definitions below). Typically, a professional Architectural Historian has expertise in research, survey, documentation, and evaluation of architectural resources, including buildings, structures, objects, and districts. A graduate degree in Architectural History or a closely related field of study, plus a minimum of two years of full-time professional experience applying the theories, methods, and practices of Architectural History that enables professional judgments to be made about the identification, evaluation, documentation, registration, or treatment of historic properties; OR an undergraduate degree in Architectural History or a closely related field of study, Plus a minimum of four years of full-time professional experience.

### History

The minimum professional qualifications in history are a graduate degree in history or closely related field; or a bachelor's degree in history or closely related field plus one of the following:

1. At least two years of full-time experience in research, writing, teaching, interpretation, or other demonstrable professional activity with an academic institution, historic organization or agency, museum, or other professional institution; or
2. Substantial contribution through research and publication to the body of scholarly knowledge in the field of history.

### Architectural History

The minimum professional qualifications in architectural history are a graduate degree in architectural history, art history, historic preservation, or closely related field, with coursework in American architectural history, or a bachelor's degree in architectural history, art history, historic preservation or closely related field plus one of the following:

1. At least two years of full-time experience in research, writing, or teaching in American architectural history or restoration architecture with an academic institution, historical organization or agency, museum, or other professional institution; or
2. Substantial contribution through research and publication to the body of scholarly knowledge in the field of American architectural history.

### Architecture

The minimum professional qualifications in architecture are a professional degree in architecture plus at least two years of full-time experience in architecture; or a State license to practice architecture.

### **Historic Architecture**

The minimum professional qualifications in historic architecture are a professional degree in architecture or a State license to practice architecture, plus one of the following:

1. At least one year of graduate study in architectural preservation, American architectural history, preservation planning, or closely related field; or
2. At least one year of full-time professional experience on historic preservation projects.

Such graduate study or experience shall include detailed investigations of historic structures, preparation of historic structures research reports, and preparation of plans and specifications for preservation projects (*Secretary of the Interior's Historic Preservation Professional Qualification Standards*).

Closely related fields include: Art History; Historic Preservation; American Architectural History; American Studies; American Civilization; Architecture; Landscape Architecture; Urban and Regional Planning; American History; Historic Preservation; and Public History.

Non-professionals may assist with the survey and recordation of architectural resources, but the final evaluation needs to be completed with the assistance of someone meeting the professional standards. In Nevada there is a shortage of Architectural Historians, therefore, the following discussions are geared for the non-architecturally trained individual. However, before a non-professional architectural historian begins an architectural survey, they should have:

- a basic vocabulary of building elements;
- a basic vocabulary of historic and modern building materials; and
- an understanding of historic and modern construction techniques

**Tools of the Trade:** If you have never recorded an architectural resource here are a few tips to get started; you will need:

- Clipboard or writing surface and pen or pencil
- Measuring tape (ft, inches) – architecture is primarily recorded in feet/inches.
- Graph paper (for the sketch map), scale ruler
- Field form or blank NARA form
- Digital camera, extra battery
- Map of survey area or list of resources to survey
- Business cards
- GPS unit

*Do I want to be “visible” or not?:* Unlike archaeological surveys, architectural surveys are often in urban environments, and that means other people will be around. They will be wondering why you are taking a picture of their property and writing down notes. A common misconception is that you are taking notes for the assessor’s office in order to raise their taxes. It is usually best to make yourself very visible, wear a safety vest, an official shirt or hat from your company, carry business cards to pass out, and be ready to explain the purpose of the survey. For rural areas it is also important to carry identification that provides entry onto the survey area. Residents may be an important source of information for alterations or additions to the properties in the survey area.

If you do not have permission from the owner to enter the property, then the survey will be conducted from the public right-of-way. This usually means, from the sidewalk. You do not need express permission to enter a public building, but is recommended to inform someone about your project.

**Safety:** You already know these safety rules, but they bear repeating:

- If possible always survey with a partner or at least carry a cell phone.
- Tell someone where you are going and when you expect to return.
- If you feel threatened by a property owner, leave.
- If you come across items of illegal nature or pot garden, leave.
- Do not enter structures or buildings if they do not look stable.
- Do not stand near buildings, structures, or objects if they look like they are going to collapse.
- Do not go in or near mine shafts, adits, tunnels, etc.

**Mapping, Photographs, and Description:** Graphically presenting the features of the architectural resource is very important. A sketch map that details the shape of the building, location of primary windows and doors is usually documented on a “floor-plan” level sketch of the building exterior. Additionally, walkways, driveways, mature landscaping, trees, and the property boundary are needed to define the setting. If access to the interior is possible, the floor-plan is a good tool, especially for determining alterations. Detailed descriptions of windows and doors with measurements can reveal subtle changes or modifications that may not be obvious from a quick glance. Notes, measurements, photos, and a photo log are invaluable when writing the final description and evaluation sections of the NARA form and report.

The most important thing you can do while in the field is take a lot of pictures and keep an accurate log of the photos and the photo points. It is acceptable to document resources with digital images, the old standard of Black and White film is no longer necessary. Take pictures of the whole building, elevations, façade, details like windows, hardware, foundations, and rafters; the setting; views to the resource, views from the resource. Taking a few seconds to steady yourself, make sure the camera is level, and the building is nicely framed in the view finder will save you hours of cropping and rotating your photos later. Photo logs are essential for accurately tracking multiple properties and details noted in the field. Photo logs are required as an appendix to the final report. And, photo point locations depicted on a map or sketch plan, or listed with UTM's may also be required.

On small urban surveys it might be more helpful to just take a close up picture of the address before photographing the rest of the resource. Later you can figure out the direction the camera is pointing by using an aerial photograph or map. Photo logs are more important for surveys in rural areas with no addresses and where the orientation of the camera might not be self-evident when perusing the photographs back in the office.

Federal agencies (FWS, FS and BLM) recommend the following graphic standards for reports in order to meet the SHPO requirements (refer to Appendix G):

- Photographs of the resource should include: a) the front and one side; b) the rear and one side; c) the front elevation; d) environmental view showing the building as part of its larger landscape; and as appropriate, e) details of major elements of the building, including doors, windows, additions, etc.; f) decorative details; and g) details of materials and hardware. Interior photographs, if

permitted access, should yield information about the floor plan, construction details, and materials ;

- Reproductions of historic photographs, if available should be included in the report or as an appendix to illustrate the resource;
- Digital images and copies of existing drawings or plans, if available. If reproduced materials are included in the report, it is the responsibility of the researcher to obtain proper permission. Copies of permission forms must be submitted with the report;
- Drawings, site plan, and sketch plan. The site plan must include the resource’s cardinal orientation in its natural landscape and include the scale and a north arrow. The sketch plan is usually a more refined site plan with layout and floor plan, with dimension details of the resource. The sketch plan need not be a “measured drawing,” but an approximate scale should be included; and
- All graphics will be identified/labeled with the SHPO Resource Number, name of the property, the date rendered, the name of the photographer or renderer, orientation of the photograph or drawing. If using B&W or color film, do not paste, glue, or otherwise adhere the photograph to the pages of the report. Please place them in properly-labeled archival jackets.

**Recording Buildings:** A guide for recording buildings is attached to the NARA form to provide cues for recording resources (Appendix B). Cultural resource professionals, including archaeologists, are often on the front lines of field surveys. Archaeologists can bring a great holistic perspective to architectural surveys, looking at a building’s connection to the landscape, to other buildings, and to transportation routes. But, all surveyors should be familiar with the vocabulary of building elements, materials, and construction techniques before attempting to record architectural resources.

The NARA form’s “Building Characteristics” page (Appendix B) provides prompts that, when filled out completely, provide a consistent and thorough description of a building. But the description will only be as reliable as the accuracy of your observations.

Correct identification of building materials *while in the field* is particularly important. An architectural historian can describe building elements based on good photographs, but it is difficult to identify materials based on photographs. Is it vinyl siding or steel siding? Is the brick a veneer or structural? Verify all descriptions while in the field.

Buildings are typically built with English measuring system and should be described and measured using feet and inches. For survey-level recordation does not require “measure drawings” but should include an accurate sketch of the footprint. Vernacular buildings may vary from the standard. The landscape plan, boundaries, etc. can be mapped in metric or with a GPS unit and note where the UTM reading is taken on the building, e.g. front entry or corner.

It is usually best to begin by measuring the exterior of the building, creating a plan of the shape of the building. With the plan drawn, add windows and doors, and note any additions. The roof shape often provides a clue to the style, so beginning the description at the type of roof, orientation of the gable, and working down the wall cladding to the foundation is one method of recordation. Or, you may want to



start at the foundation and build your description up to the roof. Using a consistent method of recordation for every building reduces the likelihood of forgetting important details. Describe decorative details, porches, etc. If the building presents a recognizable style, then refer to the style guides to ensure that all of the elements are adequately described. The integrity of the building is based on the presence of characteristic elements. It is very important to note any alterations, for instance if windows have been replaced.

Photographs of the overall building with details of the windows, doors, and decorative elements are very helpful for the final written description and analysis, even if the photos are not included in the NARA or report, they will be useful for writing the narrative. Additional photographs that provide information about the setting or surroundings may be especially valuable for determining visual effects or integrity.

Sketch maps should include the surrounding property and if the house is within a city block, include the boundaries of the lot, vegetation, walkways, driveways, and any associated resources, such as a detached garage or shed. Signature trees, orchard trees, and urban landscape plantings that may be from the historic period should be noted on the sketch map. For rural properties include enough surrounding area to link the resource with the landscape, e.g. include windrows, mature trees and plantings, and associated resources, including fencelines, roads, ditches, outbuildings, wells, etc.

Twentieth century neighborhoods or large federal facilities may comprise a large number of similar buildings or structures. If faced with 100s of a similar property type it may be advisable to quickly review the range of examples, choose the best, most intact property as the principal property and describe and document it in great detail. Then document the other properties in relationship to the principal property with any alterations noted.

Architectural resources in Nevada can take many forms and be in fairly dilapidated condition and still be significant. For most surveys it is unlikely that a “high style” building will be identified, rather the small ranch house or vernacular shed, claim cabin, or dug-out will constitute the architectural record. Determining when a property is of architectural merit vs. an archaeological site is an on-going discussion that the authors and contributors of this report have had on many occasions (Figures 15 and 16). The question does not have a simple answer. The issue becomes more complicated when a “ruin” of a dug-out building is excavated and reveals stone walls, a fireplace, and other architectural details. Thus, a note of caution to surveyors to keep in mind the potential for architectural information that may be buried.

**Recording Structures:** Structures come in all shapes and sizes, so it may be difficult to know where to begin. Like buildings, an accurate recordation of structures requires a specialized vocabulary and understanding of construction techniques (See Appendix C). Structures such as silos, bridges, railroad grades, irrigation canals, mine headframes, and roads, all have their own particular terminology. Educate yourself before recording these structures so you know what you are looking at.

For a structure like a charcoal kiln, beginning with measurements is always helpful. Structures are more likely to need a plan view and an elevation view. Most structures were built using English measurements (Ft and inches), so record the structure using feet and inches. Describe construction details and materials or function. The integrity of the structure is based on the presence of characteristic elements or original parts that convey the function.



Figure 15: Use NARA form: This resource retains most of its elements, the walls, floor, and parts of the roof are still there, it has just fallen apart. All the elements of the building can be described and should be recorded on a NARA form. Packard, Pershing County (E. Dickey, 2012).



Figure 16: Use IMACS example: The floor and lumber from the collapsed walls is all that remains of this former building in Packard, Pershing County. (E. Dickey, 2012)

Photographs of the overall structure with details of the unique or representative elements are very helpful for the final analysis. Even if the field photos are not included in the NARA or report, they will be useful for writing the narrative.

A sketch map of the property is usually required. Landscape features (mature plantings, fencelines, roads, etc.) that may be from the historic period should be noted on the sketch map. For rural properties include enough surrounding area to link the resource with the landscape, e.g. mining complex.

**Recording Objects:** By their nature, objects are usually smaller than buildings or structures. If you have access, always try to measure the dimensions of an object. It should be fairly easy to measure objects such as mile post markers, Lincoln Highway markers, or grave markers. An educated guess on the height of taller objects, such as signs, is sufficient.

For another example, an object such as a single wagon in a remote location can be recorded by measuring the object and describing the component parts. Photographs and a sketch map that includes the surrounding landscape should be completed. Here again, the sketch map should include enough of the surroundings to note the presence of a road or drainage that may have influenced the final resting spot for the wagon.

**Recording Sites and Ruins:** Generally, a ruin and site are recorded on the Archaeological form (IMACS) in Nevada and the Forest Service form if on National Forest lands. But, when is a building or structure considered a ruin? In the case of a house – if the roof is present with enough pieces to figure out the shape (gable, shed, etc.); if the footprint/form of the house can be deciphered (T-shaped, square, etc.); if the wall materials are present (log, adobe, brick, etc.); if the construction method and materials are identifiable then you should record it on the NARA (refer to Figures 15-16). If the building is represented by one element like a wall or chimney, then the resource is a ruin and should be recorded on an IMACS form. If you're unsure, contact the lead agency or SHPO (Figure 17).

### **Recording Linear Resources:**

Many prominent cultural resources in Nevada are linear features from the historic period, such as trails, roads, highways, railroads, canals, telegraph lines, and other similar features (Figure 18). Some historic linear features have an excellent documentary record showing when they were created, who was involved in their creation, where they are located, and what has happened to them during their existence. However, problems arise in determining how much to record, how to evaluate, and thresholds of integrity. As a result, a consistent method of providing the information required to record, evaluate, and manage linear features is provided herein.

The evaluation of a linear resource is more challenging than that of a non-linear resource with manageable boundaries. The linear resource may possess varying states of preservation and integrity along its length and may pass through federal, state, county, and private lands, causing recordation and evaluation to be a complex task. Surveys of linear resources should attempt to ascertain or reconstruct the nature, extent, and chronology of the resource, and the historic context to which it belongs. Recording linear features is problematic because the full extent of the resource usually extends beyond the APE. It should be agreed upon in advance (with SHPO and Agency) whether the project should involve the recordation and evaluation of the entire resource or a portion of it.



Figure 17. Carson City Assay Building, Washoe Valley (BLM). Because the building only retains remnant walls it should be recorded as a ruin on an IMACS.

Linear resources such as trails, roads, ditches, fences, powerlines can be recorded as structures or as archaeological resources. The determining factors in whether a linear resource is architecture or archaeology are based on several questions: Does the resource include distinctive engineered attributes such as a rock lined culvert, a water control structure, or does it display unusual materials, finishes, or details that distinguish the resource? Is the resource primarily valued for its architectural or engineering merit? Or, does the resource provide additional information to the archaeological site?

*Conducting Research for Historic Linear Features or Districts:* Pre-field research may indicate the presence of historic linear features. They may be present on General Land Office (GLO) plat maps, agency maps, and USGS topographical maps. Secondary sources of history may also provide information about their presence. Historic photographs, plans, and engineering drawings of the resource are also useful for documenting the historic character of a resource.

When linear features are encountered, the investigator needs to assess whether a linear resource is historic in origin. The following three criteria should be applied to make such a determination:

- Is the general alignment present on historic maps, such as GLO plats, Agency, or USGS maps?
- Does the resource possess artifacts of the period?
- Does the resource possess physical characteristics similar to other identified linear resources?



Figure 18. Segment of the Old Victory Highway, also known as US 40, near Dunphy, Elko County. This road has been continually maintained but is on its original alignment and has three 1940s era bridges on it (Cliff Creger, 2012)

To evaluate the feature, prepare a historic context using information found in records such as GLO records, State Board of Control/Engineers records, Highway Department records, Army Topographical Corps reports, USGS topographical maps, aerial photographs, and county records. General histories of Nevada and the region should be consulted to determine if the project or the individuals involved are historically significant. Newspapers may provide a wealth of information on construction events reported at the time. If the structure was considered important in engineering or design, then local histories should be consulted. The investigator should also consult the transportation chapter of the *Nevada Comprehensive Preservation Plan (1991)* and any Certified Local Governments or historical society archives within the project parameters. References should be cited in the documentation, whether they yielded pertinent information or not. The results of the records search should be incorporated into the report and included in the NARA or IMACS.

*Documenting Historic Linear Resource:* Some specific considerations for documenting linear resources, for either IMACS or NARA:

- Location and Boundaries--on a map (or maps) of appropriate scale indicate the location of the known extent of the resource and identify the portion(s) being documented, as well as any feature associated with the linear resource.
- Linear resources may intersect or exceed limits of an Area of Potential Effect (APE). Unless otherwise specified by the project proponent or Agency, recording of linear features exceeding the APE will extend 100 meters beyond the APE boundaries.

- Description--provide information on the construction techniques, configuration of, and materials used to construct the linear feature. Describe any features and/or artifacts that may be associated with it. Describe in detail each cultural feature associated with the linear resource. Features of a linear resource generally consist of components integral to the functioning of the resource. Feature descriptions should include information about its construction details, dimensions, and any brand names or patent information recorded on machinery, if available. Plans, cross-sections, and elevations of associated features should be included in the engineering documentation section of the report. Examples of features associated with linear resources include:
  - Roads: retaining walls, culverts, borrow pits, road beds and grades, fences, signs, right-of-way markers, bridges, and tunnels;
  - Ditches/Water Systems: siphons, flumes, ditches, spill gates, gate valves, dams, headgates, sluices, canals, laterals, pipes, ditch/flume tenders' cabins, and reservoirs;
  - Trails: blazes, cairns, retaining walls, and paving;
  - Railroad Grades: through cuts, sidings, retaining walls, culverts, spurs, signals, switch stations, depot remains, fences, bridges, tunnels, and trestles;
  - Telegraph/Power Lines: poles, access roads.
- Physical setting--Describe in detail the natural or physical environment through which the linear resource passes. Such information should include descriptions of natural features, landscape characteristics, slope, vegetation, etc. Provide an estimate of the proportion of the resource that has been destroyed or modified, where possible.
- Dimensions--describe the dimensions of the entire linear feature or the portion being documented in the following manner:
  - Top Width--measure the linear feature at its highest point. For water systems such as ditches and canals, the top width should be measured at the crest of the berm(s) or wall(s). Record more than one width or range of widths, if appropriate. For example, a single water delivery system may be composed of a flume, earthen ditch, and concrete canal with different top widths. Clearly identify on a map or drawing the elements being measured and the locations where measurements were taken.
  - Bottom Width--provide a width for the base of the feature or provide a range of widths, as appropriate.
  - Height--provide the maximum height of the resource, as applicable, or indicate the variation in that dimension along the length of the linear feature, or the segment being documented.
  - Depth--provide the maximum depth of the resource, as applicable, or indicate the variation in that dimension along the length of the linear feature, or the segment being documented. Note any changes to this measurement, such as siltation or vegetation in a ditch.
  - Length--provide the overall length of the linear feature and the segment being documented, if applicable.

*Evaluating Historic Linear Resources: Issues to Consider*: Evaluating the significance and National Register eligibility of a linear resource is as problematic as documenting it, because it will likely display varying states of preservation and integrity along its length. An investigator must

identify the criteria under which the linear resource may be eligible for inclusion in the National Register before considering integrity issues. However, integrity, and thereby eligibility may be determined on a segment-by-segment basis. The intact or eligible portions of a linear resource should be clearly marked on a map.

The Setting is an important integrity factor, along with materials, workmanship, and design in demonstrating integrity of a linear resource. The setting must reflect the character of the historic period with minimal intrusive elements. The National Register has been liberal in the evaluation of numerous linear resources in Nevada by determining eligibility on the basis that there has been little change in the landscape since the historic period. For example, a railroad grade may lack ties and tracks, but if little of the setting's historical appearance has changed, it may still be eligible for the National Register under Criterion A. Because of the importance of setting to a linear resource, the viewshed may become a major consideration in determining project effects. However, setting may be less important in evaluating a water conveyance feature because the feature may be most significant for its engineering, thus its design and workmanship become more important for determining integrity.

Some linear resources possess structural and/or engineering features that lend themselves to considering design, materials, and workmanship as presented by distinctive engineering features such as rock retaining walls, trestles, or culverts. If so, determine whether these elements exhibit structural integrity. If the resource retains some degree of its original fabric and workmanship, ascertain if it is sufficient to convey the feature's significance. Significance might then be viewed in terms of distinction as a representative of a type or style. It is also important to identify associated resources that aid in an understanding of the linear resource.

On-going maintenance and continued use of a linear resource may or may not affect the resource's integrity. Maintenance and use that has been conducted consistent with methods employed when the resource was developed do not compromise the historic integrity of the resource. These resource activities include canals, the use of roads along the canal, and cleaning silt from the canal; for railroads, the in-kind replacement of ties, rails and switching facilities; and for roads, in-kind repairing, grading, and cleaning of roads. Maintenance, repair, and use that is inconsistent with original materials and use compromise the integrity of a historic resource. Modification of the route of any linear feature may also compromise its integrity.

**Recording Associated Resources:** Associated resources are secondary buildings, structures, or objects that contribute to the setting, feeling, and function of the primary property. For instance, a farm house is usually within a setting that includes a barn, shop, pump house, fences, corrals, sheds, ditches, orchards, etc. The property as a unit should be recorded and evaluated. Recording and evaluating only the primary building disconnects the property from its context and function. Recording associated resources is simplified on the NARA form. It is important to represent the resource on a sketch map and photograph. Photographs that capture multiple associated buildings can be referenced and do not need to be repeated if they convey the information adequately. Accurately portraying the location of buildings is also important for describing the different types of farms.

**Recording Districts:** If you find a concentration of buildings, structures sites, or objects that are united historically, by plan, design, or function then they should be considered as a District. The NARA individual

recording form can be used to document each resource, then a district form is completed that provides the overall historic context, evaluation, and integrity considerations for the district. Resources within the District are evaluated as contributing or non-contributing. And, it is possible to have a district within a district. Individual resources can also be individually eligible. Districts can also be used as an “umbrella” that keeps track of various resources within a location.

It is important to justify the boundary of the district, using property ownership, contiguous arrangement of resources, or landscape. Also, need to describe the period(s) of significance and historic context theme(s).

## Chapter 6 – Evaluating Eligibility and Integrity

In most instances architectural resources are recorded and evaluated to determine their level of significance based on criteria established by the National Register of Historic Places (NRHP), although states also focus attention on identifying historic properties and actively solicit architectural inventories through the Certified Local Government program, in-house research, property owners, and individuals. A property’s significance is also associated with local, state, or national levels of importance.

Evaluations by an agency will be “In consultation with the SHPO/THPO and any Indian tribe or organization that attaches religious and cultural significance to identified properties and guided by the *Secretary of the Interior’s Standards and Guidelines for Evaluation* the agency official shall apply the National Register criteria (36 CFR part 63) to properties identified within the area of potential effects that have not been previously evaluated for National Register eligibility. The passage of time, changing perceptions of significance, or incomplete prior evaluations may require the agency official to reevaluate properties previously determined eligible or ineligible” (36CFR800.4(c)(1)).

Significance is determined by assessing the property according to the Criteria for Evaluation (36 CFR part 60.4):

- A. That are associated with events that have made a significant contribution to the broad patterns of our history; or
- B. That are associated with the lives of persons significant in our past; or
- C. That embody the distinctive characteristics of a type, period, or method of construction, or that represent the work of a master, or that possess high artistic value, or that represent a significant and distinguishable entity whose components may lack individual distinction; or
- D. That have yielded, or may be likely to yield, information important in prehistory or history.

Criteria considerations. Ordinarily cemeteries, birthplaces, or graves of historical figures, properties owned by religious institutions or used for religious purposes, structures that have been moved from their original locations, reconstructed historic buildings, properties primarily commemorative in nature, and properties that have achieved significance within the past 50 years are not be considered eligible for the National Register. However, such properties will qualify if they are integral parts of districts that do meet the criteria of if they fall within any of the following special categories:

- (a) A religious property deriving primary significance from architectural or artistic distinction or historical importance; or



- (b) A building or structure removed from its original location but which is significant primarily for architectural value, or which is the surviving structure most importantly associated with a historic person or event; or
- (c) A birthplace or grave of a historical figure of outstanding importance if there is no appropriate site or building directly associated with his productive life.
- (d) A cemetery which derives its primary significance from graves of persons of transcendent importance, from age, from distinctive design features, or from association with historic events; or
- (e) A reconstructed building when accurately executed in a suitable environment and presented in a dignified manner as part of a restoration master plan, and when no other building or structure with the same association has survived; or
- (f) A property primarily commemorative in intent if design, age, tradition, or symbolic value has invested it with its own exceptional significance; or
- (g) A property achieving significance within the past 50 years if it is of exceptional importance.

The National Register defines integrity as the ability of a resource to convey its significance. The evaluation of integrity must always be grounded in an understanding of a resource's physical features and how they relate to its significance. Each resource must be evaluated by all seven of the aspects of integrity. The seven aspects of integrity are: **location, design, setting, materials, workmanship, feeling, and association.**

Location, setting, feeling, and association are generally represented by an intact, historic appearance of the landscape, setting, viewshed, and location of the resource. The appropriateness of the setting and viewshed are linked with the property's historic period. Historic photographs can be very useful for assessing the integrity of setting.

Integrity of design, materials, and workmanship are usually more measurable, e.g. the original design is still observed, materials have not been substantially altered, and workmanship is clearly evident.

Integrity is often confused with condition. Condition evaluates the physical elements of a resource, such as, there are holes in the roof, windows are broken, etc. Whereas integrity details the elements that are original, e.g. the roof may have holes but it is original sod; the window panes are broken but the sash and trim are still intact. Therefore, a building may be in poor condition but still retain integrity (Figure 19).



Figure 19. Cabin in poor condition, but with good integrity, Ruby Lake NWR (USFWS).

## Chapter 7 – Reporting Standards and Guidelines

The following reporting guidance is a general summary of the standard in Nevada. For specific guidance please contact the federal agency for which the work is being conducted. To satisfy the documentation requirements for architectural resources eligible for the National Register, a report detailing the historic context and significance of the property and recordation of the property on a NARA form need to be completed. Documentation should include the following elements:

### Report Outline

An outline of the Architectural History Survey Report should include (based on Agency standards):

#### *Title Page/Cover Sheet*

Report title, author, organization, lead federal agency, identification numbers, and the date the report was prepared. The title should be unique and include the location or name of the property. Short titles that present the unique information first are recommended. Such as, *Jimmy Cricket Mining Claim: Architectural Inventory and Evaluation Report*. A cover sheet is required by SHPO with the submission (see website for latest version of the cover sheet).

#### *Table of Contents*

The table of contents should list report chapters and all subdivisions. Pagination must be shown in the table of contents.

### *Executive Summary/Introduction*

Summary of the report including, description of federal undertaking and APE as defined by federal agency, and results of the survey, number of resources identified, and number and types of resources that are NRHP eligible. If there is an assessment of project affects that should be included in the introduction. The Executive Summary should be concise, try to limit to one page.

### *Methods/Project Description*

Detailed description of the scope of the project, including location of the project, the physical limits of the project (what is the tallest element, how wide will the project be), and the location of the staging area(s). If the description of the project requires technical terminology, be sure to explain what it means. Provide a brief description of methods used to accomplish the documentation.

### *Establishing the Area of Potential Effects*

Describe the project's potential direct effects and the area these effects will occur. Boundary should be drawn on a map. Describe the project's potential indirect effects, if any, and how the indirect effects relate to the APE. Visual effects may be at a distance from the APE of direct effects. Describe the project's potential for cumulative effects, if any.

### *Acreage*

Acreage of the APE, the area surveyed, and the project acres all need to be calculated. The APE is derived by drawing a line around the area affected by the undertaking and then counting the number of acres encompassed by the boundary. The federal agency should define the APE for the surveyor. The surveyed acres, are calculated by noting the areas reviewed and determining the acres. The entire project may be greater than the APE and should be described. (Note: the "survey area" may be different from the "Area of Potential Effect" and the two terms are not interchangeable). Surveyed acreage is tracked by SHPO and needs to be included in the report and cover sheet.

### *Maps*

The report will include one map (or set of maps depending on the size of the project) that uses a 7.5' USGS topographic base map. The topographic base map will show the entire project area with the boundary of the APE and survey area if different from the APE illustrated on it.

Other maps may use a topographic, aerial, or other background as appropriate to the scale and type of project. In addition to the maps in the report, GIS shapefiles will be prepared to meet current agency standards (please check with the agency for specific requirements). At a minimum shapefiles will be projected in UTM, NAD 83 and submitted with the report.

According to SHPO guidance, at least three maps are required for each survey report: the Project Vicinity Map; APE Overview Map; and Resource Map. All maps will be printed on paper no larger than 11 x 17 in. A map with the survey transects depicted is also required and usually uses the USGS quadrangle map as the background.

### Project Vicinity Map

The Project Vicinity map shows the state of Nevada and county boundaries with the general project area pointed out (Figure 20). This may be a stand-alone map or presented as an inset map in the corner of the APE Overview Map.



Figure 20. Example of project vicinity map (NDOT).

### APE Overview Map

The APE Overview map will depict the entire APE for direct and indirect effects using a USGS topographic base map, at a 1:24,000 scale (Figure 21). If the APE will not fit on a single map then use multiple maps at the same scale with match points. For larger or complex projects, detail maps may be needed. The maps should still use a topographic base map at an appropriate scale to be clear enough to identify individual sections of the APE (Figure 22). Aerial photographs are also useful to depict resources as a detailed graphic.

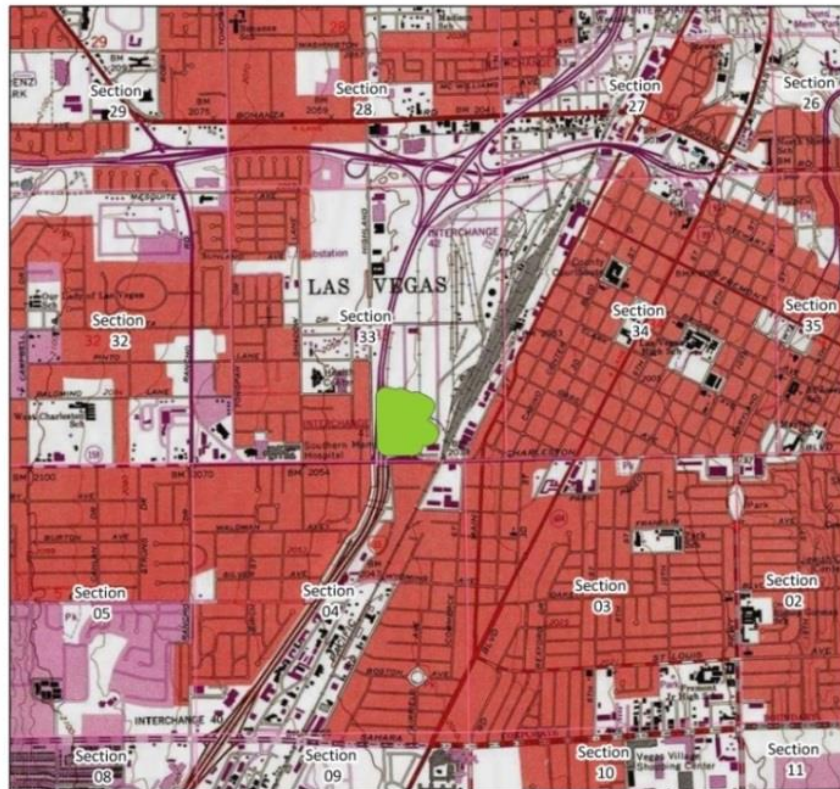

USGS 7.5 Minute Topographic Map, Las Vegas NW Quadrangle, T 20S & 21S, R 61E

1:24,000



 Area of Potential Effects

THIS MAP IS FOR DISPLAY PURPOSES ONLY.  
MAP COMPILED FROM BEST AVAILABLE DATA SOURCES.  
NOT ALL FEATURES PORTRAYED DUE TO SCALE.  
DATA PROVIDED BY ENVIRONMENTAL DIVISION  
ARCHAEOLOGY SECTION, 2013.

Figure 21. Example of APE map on USGS 7.5' map (NDOT).

Resource Maps (if needed or included in an Appendix)

The location of each surveyed architectural resource will be identified on a map. If the scale of the APE Overview Map or Detail Map prevent the location of the surveyed resources from being clearly distinguishable from each other, then additional maps will be needed (Figure 23). Each resource will be identified on the map with the SHPO Resource number. The SHPO Resource number will be included on the Complete List of resources within the APE. Individual resource maps should be included with the NARA form as an Appendix to the report.

*Setting/Background*

Setting refers to the physical environment of the survey area or property. The background usually presents prehistoric, ethnographic, and historical information that may be relevant to the understanding of the property or survey area.



Figure 22. Detail APE map of project area (NDOT).

### Historic Context

Developing a historic context relies on historical research and documentation. The context should provide background and enough information to formulate the significance evaluation to address the four criteria of eligibility. If there is a historic context for your topic, area, or property type then use it as a starting point to add new information or revise the context. There is no need to reprint in total a previously written work. It is more valuable to assess each project/property and enhance our understanding of a style or time period in Nevada's history. (For guidance on writing a historic context, please refer to Chapter 3).

### Identification of Historic Properties

#### Identification Methodology

Description of the methodology and the resources used to identify historic properties in the APE (e.g. County Assessor's website, historic maps, field survey, and results of previous surveys).

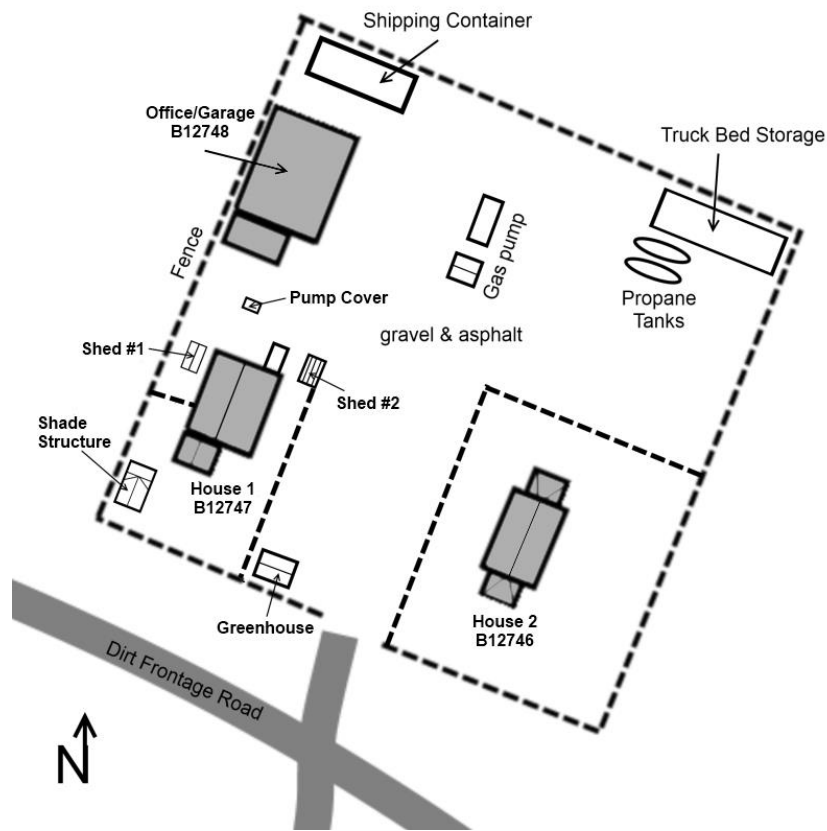

Figure 23. Resource Map, detailed sketch map with resources identified with SHPO # (NDOT).

### Previous Work

List of all architectural surveys completed within one mile of the APE. A review of archaeological surveys may also shed light on the potential for resources and should be included in the records search. This list will include information on the title, author, year report was completed, whom the report was prepared for (if known), and information on any historic properties or ineligible resources identified that are also in this project’s APE. Also include undocumented historic-aged resources and previously documented resources that require an update.

### “Cut Off” Date

The year used as a “cut-off” date to decide whether or not a property should be evaluated for the NRHP is usually established in lead agency policy and/or by agreement with SHPO. These dates can also be derived from consultation with SHPO. Usually a 45 or 50 year cut off is used. If a project will take several years to complete, the cut-off date should be the expected year of completion, minus 50 years. This will eliminate the need to evaluate resources that turn 50 years old before the project is finished.

### Historic Properties

Describe efforts to identify historic properties and the results of those efforts. This section (or an appendix) will include a list of historic properties within the APE.

### *Architectural Survey Methodology*

Describe personnel who worked on the project, what their roles were, and what their qualifications are. Describe who completed fieldwork, when it was done, and how it was done.

### *Survey Results*

Present a description and analysis of the types of historic architectural resources within the APE and statement of their significance. All resources will be evaluated according to the NRHP Criteria A, B, C and D, along with the seven aspects of integrity. Property types should be discussed within the appropriate historic context.

### *Finding of Effect*

Description of the justification for the finding of effect, see federal agency guidance.

### *Bibliography*

References to secondary sources should indicate author, title, and date of publication. Primary sources should be identified by name, collection identifier, and location. Interviews should be noted including the date and location of the interview, and names of both parties.

### *Appendices (as appropriate)*

A NARA Building, Object, Structure, and/or District Form will be completed for newly documented properties or resources that require an updated form. Each NARA form will be represented by a row in a GIS polygon shapefile.

Appendices may include:

- A complete list of all the resources in the APE, if this was not included in the body of the report;
- Additional maps;
- Historic maps;
- Historic photographs that were not included in the Historic Context;
- Official correspondence letters from SHPO or the lead federal agency (such as a letter from SHPO that concurs on the APE for the project);
- Plan sets, or details from plan sets; and

Additional information that will be submitted with the report (as required by SHPO) includes:

- SHPO's Cultural Resources Survey Coversheet;
- A CD of digital photographs, a PDF of the report, and PDFs of the site forms; and
- Photo logs.

### **Summary**

In order for the Federal agency to complete the Section 106 process, they will transmit the results of the project to SHPO/THPO and consult on the eligibility of resources and assessment of project effects. If a report includes both archaeological and architectural resources it might be necessary to submit two copies to SHPO for simultaneous review by SHPO staff. It is recommended that the architectural and archaeological information be organized into separate sections of the report, because the resource types follow different paths in the SHPO office and need to be clearly recognized to expedite review and appropriate curation.



## Chapter 8 – NARA and District Form Instructions

Filling out the NARA form for Building, Structure, and Object are provided in detail below. For District forms, please follow the guidance for the general NARA form for Parts 1-5, then follow the District form instructions for Parts 6-13, following the NARA form instructions.

Information in the first four parts of the NARA form is linked to identification numbers, such as SHPO, the Federal Agency, and perhaps a Trinomial. The physical location description, land owner status, eligibility status, and preparer information are regarded as the “administrative” aspects of the form. If there is no information available to complete a box, use a dash-line or N/A in the box to indicate that no information was available.

### Parts 1-5 Instructions

#### **Part 1- Property ID:**

Historic resources are often identified by a name, such as “Jack Longstreet Cabin” or “Bliss Mansion.” If there is no associated historic name with the property, you can use the common name, such as the name of the business occupying the historic building, or use N/A to note that no information is available.

County: County where property is located. If more than one county, use multiple, and list in the narrative portion of the form.

SHPO Resource Number: This is the assigned SHPO Resource Number and will start with “B” for Buildings, “S” for structures, “O” for objects, and “D” for districts. **Newly recorded resources must have a resource number prior to SHPO reviewing the report.** When submitting finalized reports, the SHPO Resource Number must be referenced throughout the report for resource(s) being discussed. To obtain new resource numbers, contact SHPO staff. The Federal Agency number should also be included to ensure cross-reference conformity. To reduce efforts and duplicates, SHPO requires a USGS 7.5’ quadrangle map or Geographical Information System (GIS) shapefile with a request for resource number assignment.

Other ID #: Unique identifier for the survey or other number.

IMACS Associated – yes or no, is the building or structure associated with an archaeological site that has a Trinomial. Please include this information so that the overlapping resources can be tracked.

Is the resource NRHP listed or within a historic district? If the resource is within what you suspect could be a historic district, but the district has not been evaluated for the NRHP, mark “No.”

If the property is within a listed or eligible Historic District please include the district name and SHPO assigned District number (D-#).

Lead Agency: Who is the survey sponsor or land owner? (BLM, FS, FWS, etc.)

Agency #: Federal agencies often have their own in-house numbering/filing system and this space reflects the need to keep track of multiple numbering systems.

Report # and Name: Often there is a survey report or project report that includes the property, please provide the report name and any identifying report numbers so that the form and report are linked.

**1. PROPERTY I.D.:**

<b>*Historic Name:</b>	<b>*County:</b>	<b>*SHPO B, S, O Resource #:</b>
<b>Common Name:</b>	<b>Other ID #:</b>	<b>Within a District? Y/N</b>
<b>IMACS Associated:</b> <input type="checkbox"/> Yes <input type="checkbox"/> No	<b>Trinomial #:</b>	<b>District Name/ID #:</b>
<b>Lead Agency:</b>	<b>Agency #:</b>	
<b>Report # and Title:</b>		

**Part 2 -- Eligibility Status:** This simple box replaces the previous box at the top of the page marked SHPO Use Only. If the property is known to be listed or within a district, please note this. Usually the recorder/contractor provides a Recommendation of Eligibility (ROE). Then the Lead Agency provides its Determination of Eligibility (DOE). This form will probably only reflect the status at the time of the recordation. There is a line for the date of SHPO determination if this is completed and added to the form.

**2. ELIGIBILITY STATUS**

<b>NRHP Status:</b> [Listed; Contributor to District; Non-contributor]:			
<i>Recommendation and Determination of Eligibility if not listed:</i>			
<b>Lead Agency DOE:</b>	<b>Date:</b>	<b>Contractor/Recorder ROE:</b>	<b>Date:</b>
<b>SHPO DOE:</b>	<b>Date:</b>		

**Part 3 -- Photo:** Photograph on the front page for easy reference and meets the need for one of the three photos suggested by SHPO to provide a clear record of the resource. This initial reference shot of the resource should be taken from a vantage that best captures the character of the resource, usually the front or an oblique shot. The photo file name should be unique to the photo.

**Part 4 -- Property Location Information:** A very important element for recording any resource is identifying where it is located in very precise terms. Several different options are available. In an urban setting the resource will commonly have an address, town, tax lot, and/or assessor’s parcel number (APN), although addresses and APN numbers can change. For rural properties the location is usually determined by Township, Range, and Section, but may also have a APN. All properties need to be located with a GPS and the Nevada Revised Statutes, NRS 327.005, require state agencies to generate all GIS shapefiles using NAD 83 projection. NAD 83 is the projection used by Federal agencies and the Nevada SHPO. All of Nevada is UTM Zone 11. The USGS 7.5’ map is the standard topographical map for identifying property location (refer to Figure 21).

Assessor’s Parcel Number (APN): If property is within a city, provide the current assessor’s parcel number. (see county assessor’s web page). Ownership is useful to include for management purposes. The property owner may not be known, but this is a required field for the USDA Forest Service.

**4. PROPERTY LOCATION INFORMATION URBAN OR RURAL**

<b>Address:</b>		<b>Township:</b>	<b>Range:</b>	<b>Section(s):</b>
<b>City:</b>	<b>Zip:</b>	<b>Ownership:</b> <input type="checkbox"/> Federal <input type="checkbox"/> Private <input type="checkbox"/> Other:		
<b>Assessor Parcel Number (APN):</b>		<b>USGS 7.5’ Map:</b>		
<b>Current Owner’s Name/Address:</b>		<b>NAD 83, UTM: Zone 11,</b>	<b>Easting /</b>	<b>Northing</b>

**Part 5 -- Form Information:** It is useful to know when the resource was recorded and by whom.

## 5. FORM INFORMATION

Documented by:	Survey Date:
Company/Agency:	e-mail:

### Parts 6-7 Instructions--NARA

Parts 6 and 7 are really the heart of the recordation – this is where a detailed review of the architectural resource is required. The Building Recording Guide (Part 15-Guide, Appendix B) provides a step by step list of the features for a building that need to be recorded. Information from the Guide will be useful when determining the style, form, date of construction, and original function. It is important to use common terms to ensure consistency in recordation. In the future, these key words can be adapted for a drop-down or look-up table and linked to a database with searchable fields. Of course, if you are recording a building that doesn't fit the descriptive terms, use Other and describe the attributes in more detail in the written narrative section, Part 10.

**Part 6 – Architectural Information:** What is it? A Building, Structure, or Object. Check the appropriate box. And describe the resource. This usually describes the Building/Structure/Object's **original** purpose, such as: house, barn, gas station, bridge, or monument. If a church was converted into a house, its "property type" would still be "church."

Architectural Style: The term for the architectural style should be taken from the list (Appendix D), if the property reflects more than one style, or is difficult to decipher, write "Other" and describe it in the text. Do not make up new architectural terms for styles. Style is a key identification attribute that is needed for comparative research, thus consistent use of terms is critical. For guidance on architectural styles, consult SHPO's architectural historians.

"If there is a local style important for understanding the architecture such as "Old Tahoe Style" this should be discussed in the descriptive part of the form while the most appropriate style from the approved list should be used in the data entry block. Also, do not be concerned if you have trouble deciding on the "right" style. Architectural historians often do not agree in many cases, particularly with more recent buildings" (R. Reno 2014, personal communication). The style date ranges are not set in stone, but are provided as a general guide. Appendices E and F provide additional information for describing building styles and characteristics.

Architectural Form: Generally speaking, vernacular is used for simplified versions of a higher style, or a completely unique form. Therefore the shape and roof form may provide the best information for describing the property, see Appendix E for floor plans and roof types. Also, when describing a vernacular property, note the type of materials and method of construction.

Architect/Designer/Builder: If the architect/designer/builder is known please include their name, or the name of the firm or company. If the architect, designer, or builder is unknown, write "Unknown."

Date Built: The date built may be difficult to determine while in the field, but at least put a best guess and check the “circa” box to indicate that the date is within a range. Further research of the county assessor’s records, historic maps, and other documents may help identify the date the building was first constructed. This field is to indicate the date of the initial construction, note any other important dates, such as for an addition or date the building was moved. If the building has several noteworthy additions, they should be described in the narrative.

When describing a building or structure it is useful to start with the general form or shape of the resource. Refer to the recording guide as a check list. The size, shape, and roof form provide clues to the style and period. Once the overall characteristics are described, focus on the details such as the number, type, and arrangement of windows, doors, and decorative details. Refer to Appendix F for additional illustrations of styles.

**6. ARCHITECTURAL INFORMATION**     BUILDING [COMPLETE BUILDING ATTRIBUTES PAGE]     STRUCTURE     OBJECT

*Property Type /Original Function: [e.g. gas station, barn, residence, store]	
*Architectural Style: [e.g. Classical Revival, Bungalow, Ranch]	
*Architectural Form:	
*Architect/Designer/Builder:	*Date Built:            circa <input type="checkbox"/>
*Architect/Engineer:	Contractor/Builder:
Object Attributes/Type (describe):	

**Part 7 -- Condition/Integrity:** Note if the property is unoccupied, abandoned, or in-use. **Condition** of the property relates to physical condition of the roof, walls, foundation, windows, and doors. Is the property deteriorated, falling down? **Integrity** identifies how much of the resource is original. Thus, a building can be in poor condition but have excellent integrity if all of the original parts are present. For example, a building with a collapsed roof can still be considered to retain integrity if all the other original parts (doors, windows, trim) are present. Some modifications, if completed more than 50 years ago, need to be considered within the historic context of the building. Describe the type of alteration, such as if the windows have been replaced. The seven elements of integrity should be addressed (design, materials, feeling, association, workmanship, setting, and location). Threats to the resource should be readily apparent such as graffiti or rodent nests/droppings.

**7. CONDITION/INTEGRITY**                     UNOCCUPIED                     ABANDONED                     IN-USE

Condition: <input type="checkbox"/> Excellent <input type="checkbox"/> Good <input type="checkbox"/> Fair <input type="checkbox"/> Poor	
Integrity: <input type="checkbox"/> Original <input type="checkbox"/> Intact <input type="checkbox"/> Moved <input type="checkbox"/> Altered <input type="checkbox"/> Other:	
Date(s) Modified:	Date Moved:
Description of Alterations:	
Integrity: (Location, design, materials, workmanship, setting, feeling, and association)	
Threats to Resource: [e.g. vandalism, animal infestation, etc.]	

**Parts 8-10 Instructions--NARA**

**Part 8 – National Register Eligibility and Recorder’s Recommendation:** This portion of the NARA is where the information gathered during fieldwork and research is distilled down to the essential information in order to evaluate whether the property is eligible to the National Register of Historic Places (NRHP). Please note if the property has been previously determined eligible. If the property is not listed, then the recorder defines their recommendation for eligibility based on all four criteria. This table serves as the initial recommendation for NRHP status. The justification for the recommendation is presented in Part 9.

**8. NATIONAL REGISTER ELIGIBILITY**

<input type="checkbox"/> *NRHP Listed	*Date Listed:	State Register:	Local Recognition:
Level of Significance: <input type="checkbox"/> Local <input type="checkbox"/> State <input type="checkbox"/> National			

<b>Recorder’s Recommendation of Eligibility (ROE)</b>		
<input type="checkbox"/> Eligible: <input type="checkbox"/> A <input type="checkbox"/> B <input type="checkbox"/> C <input type="checkbox"/> D	<input type="checkbox"/> Not Eligible	<input type="checkbox"/> Unevaluated
Criterion Consideration (if applicable):		
<input type="checkbox"/> Non-contributing to a district		
*Historic Theme(s): [e.g. Area of Significance]		
*Period(s) of Significance:		

**Part 9 – NRHP Eligibility Justification:** The justification statement is a succinct statement that provides information to support the NHRP recommendation in Part 8. Generally, the narrative should include the theme, temporal period represented, a description of the appearance, condition, and associative values of the property. Identify the character defining features of the property and how it compares to other similar properties.

The evaluation should state how the particular property meets the integrity requirements for its type. When a property is disqualified for loss of integrity, the evaluation statement should include a statement that defines the level of integrity expected for the property type, and the impact of that absence on the property’s ability to exemplify architectural, historical, or research values within a particular historic context.

A revised version of The Nevada Comprehensive Preservation Plan (Plan 1991) is available at <http://www.nvshpo.org>. The Plan serves several purposes, including the identification of Nevada’s historical resources, and their state of preservation, and to assist the development of historic contexts by identifying themes in Nevada’s history.

Usually, it will take additional research to develop a context to adequately evaluate the resource to NRHP standards for the final draft. However, it is useful to provide a brief narrative of why the property might be eligible during the field recordation. The text box can be converted to text by going into the table and clicking on “convert to text,” or simply expand the table by clicking the bottom line of the box and pulling it to the size needed. If the narrative is very long, use a continuation sheet. If using a continuation sheet, note which part of the form is being continued, e.g. Part 9, continued.

**9. NRHP ELIGIBILITY JUSTIFICATION:** [DISCUSS HISTORIC CONTEXT AND ELIGIBILITY – A,B,C,D AND INTEGRITY – EXPAND BOX TO ACCOMMODATE TEXT]

**Part 10 -- Written Narrative:** The written narrative should be a clear, concise description of the resource, including construction materials, additions, or alterations. Briefly describe the setting and surrounding landscape. Note unusual or distinctive features and if there are other associated buildings, structures, objects, or sites. Key questions include: What is it? How old is it? What is it associated with? and Why is it here? Describe the appearance, style, and condition, along with the date of construction. Key questions serve as the basis for developing the historic context. The context is built from the geographic area, chronological period, and theme(s). Determining the property type should provide a link to the theme and other properties and their context statements. If no existing property type is appropriate, a new property type is defined, its values identified, and the specific characteristics or data requirements are outlined and justified as an addition to the historic context. If necessary, a new historic context is defined for which values and property types and their integrity requirements are identified and justified.

The text box can be converted to text by going into the table and clicking on “convert to text,” or simply expand the table by clicking the bottom line of the box and pulling it to the size needed. If the narrative is very long, use a continuation sheet. If using a continuation sheet, note which part of the form is being continued, e.g. Part 10, continued.

**10. WRITTEN NARRATIVE:** [DESCRIBE PROPERTY EXTERIOR, SETTING/LANDSCAPE, AND BOUNDARY– EXPAND BOX TO ACCOMMODATE TEXT]

**Parts 11-14 Instructions--NARA**

**Parts 11-13 -- Maps:** Graphically displaying the location of the property may require several maps, however, three separate maps are NOT required. The basic requirement is for a map that shows the general location within the state of Nevada and County, and then a specific location on a USGS 7.5’ map or lot/block map. The location within the state and county can be included as an inset on the more precise location map. If the property is complex (e.g. multiple resources) or if the surroundings are important, then a sketch map is necessary for clearly identifying all of the features. The sketch map should include property boundaries, other associated properties, landscape features such as roads, fences, creeks, along with a north arrow, scale, and key. More than one resource can be presented on the sketch map (refer to Figure 23).

Three blank sheets are included in the form to ensure that the general location, specific location, and sketch map are integrated into the final form. Additional maps can be included.

**Part 14 – Photographs (Appendix G):** Photographic recording during a survey documents both individual resources and the survey area. Each NARA should contain a minimum of three images at a 3 x 5” size or larger. The three photos should show the front, a side, the rear, or the setting. Additional photographs of details, additions, and landscaping are always useful, please add continuation sheets to accommodate the number of photos. Either digital or black and white film is acceptable for the NARA. Each photograph caption should include information on the photographer, date taken, the subject, view to, and an identification number (such as the digital file name or the negative number). A photo log should be submitted with the final report.

**Part 15 Instructions--NARA**

**Part 15 -- Building Recording Guide -- Attributes, Physical Characteristics & General Layout:** If the resource is a building, please use the guide to describe the resource which provides standard descriptive terms for a building (see Appendix B). Please use the standard terms for preparing the narrative description. Other guides to assist with recording resources are encompassed by Appendix C, D, E, and F. Appendix D provides a list of architectural styles along with general date ranges for the styles. The list of styles is based on a Nevada SHPO list and the National Register Bulletin 16A. Appendix E presents building floor plans and roof types to provide common terms for describing the basic shapes and building a consistent vocabulary of architectural terms. Appendix F presents illustrations of a few of Nevada’s architectural styles with descriptions.

**Part 16 Instructions--NARA**

**Part 16 -- Associated Resources:** Associated resources are buildings, structures, or objects that are related to the primary resource, such as a chicken house, shed, or windmill to a ranch house. The associated resource identification can be a brief description, photograph, and marked on the sketch map. The resource type and a very brief description box are provided. All resources should be identified on a sketch map. Associated resources do not receive a B, S, or O #'s, therefore identification on the map should be consistent with the resource name or type. Add additional pages as needed.

**District Form Instructions—DISTRICT Part 6-13**

See the general NARA form instructions for Parts 1-5.

**Part 6 – Architectural Information:** Account for all of the resources within the District boundaries, there should be a total number of resources. This is a tally of the recommendation based on the survey and research results.

**6. NATIONAL REGISTER OF ELIGIBILITY**

<input type="checkbox"/> *NRHP Listed	*Date Listed:				
<input type="checkbox"/> Eligible under:	<input type="checkbox"/> A	<input type="checkbox"/> B	<input type="checkbox"/> C	<input type="checkbox"/> D	Criterion Consideration (if applicable):
Level of Significance:	<input type="checkbox"/> Local	<input type="checkbox"/> State	<input type="checkbox"/> National		

<b>If District is not listed on the National Register—Recorder’s Recommendation:</b>			
<input type="checkbox"/> District Eligible: <input type="checkbox"/> A <input type="checkbox"/> B <input type="checkbox"/> C <input type="checkbox"/> D	<input type="checkbox"/> Not Eligible	<input type="checkbox"/> Unevaluated	
Criterion Consideration (if applicable):			
*Historic Theme(s): (e.g. Area of Significance)			
*Period(s) of Significance:			
<b>TOTAL # of Architectural Resources in District:</b>		<b>TOTAL # of Archaeological Resources in District:</b>	
# of <b>CONTRIBUTING</b> Architectural Resources:		# of <b>CONTRIBUTING</b> Archaeological Resources:	
# of <b>NON-CONTRIBUTING</b> Architectural Resources:		# of <b>NON-CONTRIBUTING</b> Archaeological Resources:	
# of <b>UNEVALUATED</b> Architectural Resources:		# of <b>UNEVALUATED</b> Archaeological Resources:	
Total # of <b>ACRES</b> in District:			

**Part 7 – NRHP Eligibility Justification Statement:** Discussion of historic context and how district resources illustrate the context. The justification statement is a succinct statement that provides information to support the NHRP recommendation in Part 6. Generally, the narrative should include the theme, temporal period represented, and identify the character defining features of the district.

The evaluation should state how the particular property meets the integrity requirements. When a district is disqualified for loss of integrity, the evaluation statement should include a statement that defines the level of integrity expected for the district/property type, and the impact of that absence has on the ability to exemplify architectural, historical, or research values within a particular historic context.

The text box can be converted to text by going into the table and clicking on “convert to text,” or simply expand the table by clicking the bottom line of the box and pulling it to the size needed. If the narrative is very long, use a continuation sheet. If using a continuation sheet, note which part of the form is being continued, e.g. Part 7, continued.

**Part 8 – Written Narrative:** Discuss the methods used to identify the district along with the character defining features. It is also useful to include a brief description of the non-contributing and unevaluated elements within the district. The written narrative should be a clear, concise description of the resource. Briefly describe the setting and surrounding landscape.

The text box can be converted to text by going into the table and clicking on “convert to text,” or simply expand the table by clicking the bottom line of the box and pulling it to the size needed. If the narrative is very long, use a continuation sheet. If using a continuation sheet, note which part of the form is being continued, e.g. Part 8, continued.

**Part 9 – SHPO District Summary Table:** Complete the table with all of the district resources.

	<b>SHPO Resource # (and Trinomial)</b>	<b>Field Number/Address</b>	<b>Common Name/Resource Type</b>	<b>Year Built</b>	<b>NRHP Eligibility</b>
1					
2					



**Parts 10-12 -- Maps:** Graphically displaying the location of the property may require several maps, especially for a district. The three separate maps are included to ensure that the general location, specific location, and sketch map are integrated into the final form. The basic requirement is for a map that shows the general location within the state of Nevada and County, and then a specific location on a USGS 7.5' map or lot/block map. The location within the state and county can be included as an inset on the more precise location map. The district map should include the boundaries, each resource, landscape features such as roads, fences, creeks, along with a north arrow, scale, and key.

**Part 13 – Photographs (Appendix G):** Photographic recording during a survey documents both individual resources and the survey area. The District form should contain images of all contributing and non-contributing resources accounted for within the district boundaries. Photos should depict a clear view of the resource. Additional photographs of details, additions, and landscaping are always useful, please add continuation sheets to accommodate the number of photos. Either digital or black and white prints are acceptable. Each photograph caption should include information on the photographer, date taken, the subject, view to, and an identification number (such as the digital file name or the negative number). A photo log should be submitted with the final report.

## References

Angel, Myron, ed.

1881 *History of the State of Nevada*. Thompson and West, Oakland, CA.

Blumenson, John J. G.

1995 *Identifying American Architecture: A pictorial guide to styles and terms, 1600-1945*. AltaMira Press, Walnut Creek, CA.

Bowers, Michael W.

2002 *The Sagebrush State: Nevada's History, Government, and Politics*. Second Edition. University of Nevada-Reno Press, NV.

CALTRANS.

2008 *A Historical Context and Archaeological Research Design for Agricultural Properties in California*.

Cerveri, Doris.

1990 *With Curry's Compliments: The Story of Abraham Curry*. Nostalgia Press, Elko, NV.

Chambers, S. Allen, Jr.

1973 *The Architecture of Carson City, Nevada*. The Historic American Buildings Survey, Washington, D.C.

1973 "Mathias Rinckel Mansion." In S. Allen Chambers Jr. *The Architecture of Carson City, Nevada*. The Historic American Buildings Survey, Washington, D.C.

Drew, Stephen E.

n.d. "V&T Historical Narrative." On line at the Virginia and Truckee Railroad Historical Society website (<http://www.vtrrhs.org>).

- Gamble, James.  
1881 Transcontinental telegraph account first published in *The Californian* in 1881. Online at [www.telegraph-history.org](http://www.telegraph-history.org).
- Goodwin, Victor, and Wilbur Wieprecht.  
1997 "First Presbyterian Church, Carson City, Nevada, History, 1861-1997." Report, ca. 1997.
- Greeley, Horace.  
1999 *An Overland Journey from New York to San Francisco in the Summer of 1859*. University of Nebraska Press, Lincoln (reprint).
- Harmon, Mella Rothwell, and Guy L. Rocha.  
2005 "Foreman-Roberts House." National Register of Historic Places Registration Form.
- Hulse, James W.  
1998 *The Silver State*. Second Edition. University of Nevada-Reno Press, NV.
- Humphreys, Noreen I. K.  
1979 "Ormsby-Rosser House." National Register of Historic Places Inventory- Nomination Form.
- James, Ronald M., and Elizabeth Safford Harvey.  
2009 *Nevada's Historic Buildings: A Cultural Legacy*. University of Nevada-Reno Press, NV.
- Kirker, Harold.  
1986 *California's Architectural Frontier*. Peregrine Smith Books (reprint of 1960 edition), Salt Lake City, UT.
- Marschall, John P.  
1984 "Jews in Nevada: 1850-1900." *Journal of the West* 23:62-72, (January 1984).
- McAlester, Virginia and Lee McAlester  
1984 *A Field Guide to American Houses*. Alfred A. Knopf, New York.
- Moreno, Richard.  
2011 *A Short History of Carson City*. University of Nevada-Reno Press, NV.
- National Park Service  
National Register Bulletins 15 and 16. [Http://www.nps.gov/nr/bulletins.htm](http://www.nps.gov/nr/bulletins.htm).
- Nicoletta, Julie.  
2000 *Buildings of Nevada*. Oxford University Press, New York.
- Ossa, Rebecca R.  
1998 *Virginia and Truckee Railroad Depot, Carson City*. National Register of Historic Places Registration Form.
- Painter, Diana J.  
2009 "Carson City Historic Context."  
  
2007 "Carson City Mid-Century Survey, Phase I Report."

- Pezzoni, J. Daniel  
2011 *West Side Historic Distric, Carson City*. National Register of Historic Places Registration Form.
- Phillips, Steven J.  
1989 *Old-House Dictionary*. American Source Books, Lakewood, Colorado.
- Serafin, Peter; J. Daniel Pezzoni; and Jennifer Pruitt.  
2010 "Kelly-Schulz House Report."
- Simpson, James H.  
1983 *Report of Explorations across the Great Basin of the Territory of Utah*. University of Nevada-Reno Press (reprint), NV.
- Stilgoe, John R.  
1982 *Common Landscape of America, 1580 to 1845*. Yale University Press, New Haven, CN
- Uhlhorn, John F., comp.  
1873 *Virginia and Truckee Railroad Directory, 1873-74*. H. S. Crocker, Sacramento and San Francisco, CA
- Walker, Lester  
1997 *American Shelter*. The Overlook Press, New York.
- Water Conveyance Systems in California, Historic Context Development and Evaluation Procedures. CALTRANS, 2000, JRP Historical Consulting Services, Davis, CA.
- Wieprecht, Wilbur E.  
1980 "Brougher Mansion." National Register of Historic Places Inventory-Nomination Form.  
1975 "Governor's Mansion." National Register of Historic Places Inventory-Nomination Form.
- Works Project Administration.  
1940 *Nevada, A Guide to the Silver State*. Binford and Mort, Portland, OR.

## APPENDIX A: Glossary

(Primarily from NVSHPO Architectural Guidelines)

**Associated Resource** -- A building, structure, or object that is subordinate to the principal resource. A resource such as a stable, chicken house, or garage that would not exist if not for a primary resource.

**Accompanying documentation** -- USGS map, Assessor's parcel map, photographs, and sketch maps that accompany a completed form.

**Acreage** -- The area inside of the project boundary calculated in acres.

**Adverse Effect** -- an effect of a U.S. federally assisted undertaking on a historic property that may diminish the integrity of the property's character defining features.

**Advisory Council on Historic Preservation (ACHP, Council):** <http://www.achp.gov/> . An independent U.S. federal agency created by the National Historic Preservation Act of 1966 that advises the president and Congress and assists other federal agencies in reviewing the effects of their actions and decisions on properties of historical, architectural, archaeological and cultural significance and defining a consultation process that all federal agencies must follow in order to be within compliance for Section 106.

**Architectural significance** -- importance of a property based on physical aspects of its design, materials, form, style, or workmanship, and is recognized by National Register criterion C.

**Area of Potential Effects (APE)** -- the geographic area or areas within which an undertaking may directly (caused by the undertaking) or indirectly (caused by the undertaking and are later in time, further in distance, or are cumulative but are still reasonably foreseeable) cause alterations in the character or use of historic properties, if any such properties exist. The area of potential effects is influenced by the scale and nature of an undertaking and may be different for different kinds of effects caused by the undertaking. The APE is determined jointly by the federal agency with the authority over the undertaking, the state historic preservation officer, Tribal historic preservation officer, federally recognized tribes, interested parties, and the Advisory Council on Historic Preservation, as part of the consultation process under Section 106.

**Area of significance** -- the aspect of history a property represents that makes it eligible for listing in the National Register of Historic Places, such as agriculture, industry, or architecture. A property may meet the criteria under more than one area of significance.

**Association** -- link of a historic property with a historic event, activity, or person.

**Boundaries** -- lines delineating the geographic extent of area of a historic property.

**Boundary description** -- a precise description of the lines that define a historic property.

**Boundary justification** -- an explanation of the reasons for selecting the boundaries of a historic property.

**Bureau of Land Management (BLM)** -- federal agency that requires the NARA in Nevada.

**Consultation** -- a process of preservation conflict resolution, especially the method required of U.S. federal agencies by Section 106 of the NHPA in order to seek ways to reduce or avoid harm to historic properties, which might otherwise result from a federal undertaking.

**Contributing resource** – a building, site, structure, or object that adds to the historic significance of a property or district.

**Criteria** – standards set by the National Park Service by which it determines the eligibility of a resource for the National Register of Historic Places.

**Criteria considerations** – additional eligibility standards set for certain kinds of properties, such as cemeteries, reconstructed or relocated buildings or structures, or properties less than 50 years old. For further information please see 36 CFR 60.4. <http://www.nps.gov/nr/regulations.htm>

**Criteria for Evaluation for National Register of Historic Places (NRHP)** – the quality of significance in American history, architecture, archaeology, engineering, and culture is present in districts, sites, buildings, structures, and objects that possess integrity of location, design, setting, materials, workmanship, feeling, and association, and:

- Criterion A – that are associated with events that have made a significant contribution to the broad patterns of our history;
- Criterion B – that are associated with the lives of persons significant to our past;
- Criterion C – that embody the distinctive characteristics of a type, period, or method of construction, or that represent the work of a master, or that possesses high artistic values, or that represent a significant and distinguishable entity whose components may lack individual distinction;
- Criterion D – that have yielded, or may be likely to yield, information important in prehistory or history.

**Cultural affiliation** – archaeological or ethnographic culture to which a collection of sites, resources, or artifacts belong.

**Cultural resource** – structures, buildings, objects, features, and historic and prehistoric archaeological sites.

**Design** – the combination of elements that create the form, plan, space, structure, and style of a property.

**Determination of Eligibility (DOE)** – an action through which the eligibility of a property for National Register listing is confirmed without actual listing in the National Register. Nominating authorities and federal agencies commonly request determinations of eligibility for federal planning purposes.

**District/Historic District** – a significant concentration, linkage, or continuity of sites, buildings, structures, or objects united historically or aesthetically by plan or physical development.

**Documentation Standards** – requirements for describing, locating, and stating the significance of a property for listing in the National Register.

**Eligibility** – the ability of a property to meet National Register Criteria – see above Criteria for Evaluation...

**Event** – an occasion, circumstance, or activity that occurred within a particular period of time, or continued over an extended period of time.

**Feeling** – the property's expression of the aesthetic or historic sense of a particular period of time.

**Fish and Wildlife Service (FWS)** -- federal agency that requires the NARA in Nevada.

**Forest Service (FS)** – federal agency that requires the NARA in Nevada.

**Function** – purpose for which a building, site, structure, object or district is used.

**Historic** – related to the known or recorded past.

**Historic context** – a compilation of information about a resource that shares a common theme, geographic area, and time period. The development of this information serves as a foundation for decisions about planning, identification, evaluation, registration, and treatment of historic properties.

**Historic Function** – use of a district, site, building, structure, or object at the time it attained historic significance.

**Historic property** – any prehistoric or historic district, building, site, structure, or object listed in or eligible for listing in the National Register of Historic Places.

**Historic significance** – importance for which a property has been evaluated and found to meet the National Register criteria.

**Identification** – process through which information about historic properties is gathered.

**Important person** – an individual who has made significant contributions in American history, architecture, archaeology, engineering

**Information potential** – ability of a property to provide important information about history or pre-history through composition and physical remains; importance recognized by criterion D.

**Integrity** – the ability of a property to convey its significance. The National Register identifies seven aspects of integrity: location, design, setting, materials, workmanship, feeling, and association.

**Intensive survey** – identification and description of specific historic properties in an area. Should include: kinds of properties looked for, boundaries of surveyed area(s), method of survey and estimate of coverage, recording precise locations of all resources identified and information on appearance, significance, integrity and boundaries of each property sufficient to permit an evaluation of its significance.

**Inventory** – one of the components of a survey. Typically it is a compilation of information on properties that are evaluated as significant. Can also be used with properties encountered within a certain date range or other sets of criteria.

**Lead Agency** – the federal agency responsible for Section 106 compliance.

**Level of significance** – geographic magnitude or scope of a property's historical significance: national, state, or local.

**Linear Resources** – type of resource that extends across the landscape such as roads, canals, railroads, ditches, that may cross several land owners. APE boundaries often segment or cross a portion of a linear resource.

**Listing** – the formal entry of a property in the National Register of Historic Places.

**Local significance** – importance of a property to the history of its community or people.

**Location** – the place where the historic property was constructed or the place where the historic event occurred.

**Materials** – the physical elements that were combined or deposited during a particular period of time and in a particular pattern or configuration to form a historic property.

**Methods** – Explanation of how information is obtained for the identification of historic properties and the possible limitations or gaps in the information.

**Nevada Architectural Resources Assessment (NARA) form** – form designed by USFWS, BLM, and US FS that should be completed whenever an architectural resources is encountered on lands managed by these federal agencies in Nevada.

**National Historic Preservation Act, of 1966, as amended (NHPA)** – U.S. federal legislation establishing the Advisory Council on Historic Preservation, expanding the National Register of Historic Places, and extending the National Historic Preservation Programs to properties of State and local significance. Regulations promulgated in 36CFR800 require federal agencies to consider historic properties prior to an undertaking.

**National Register Historic District** – a group of historically-related resources meeting the established criteria for eligibility and significant at the national, state, or local level. A district may contain both contributing and non-contributing resources.

**National Register of Historic Places (NRHP)** – the official federal list of districts, sites, buildings, structures, and objects determined to be significant in American history, architecture, archaeology, engineering, and culture. This federal program is administered by the National Park Service and coordinated in Nevada by the State Historic Preservation Office.

**National Significance** – value of a property to the history of the United States based on national-level of association and importance.

**Non-contributing resource** – a building, site, structure, or object that does not add to the historic significance of a property or district.

**Nevada Cultural Resources Information System (NVCRIS)** – archaeological website maintained by SHPO with archaeological survey and site documentation information.

**Not eligible** – a resource that has been recorded and formally evaluated by a federal agency and does not meet any of the criteria for listing in the National Register of Historic Places.

**Period of significance**—the span of time during which a property attained the significance that makes it eligible for the National Register of Historic Places.

**Physical characteristics**—visible and tangible attributes of a historic property or group of historic properties.

**Potential to yield information** – likelihood of a property to provide information about an important aspect of history or prehistory through its physical composition and remains.

**Prehistoric** – related to the period before recorded history.

**Principal building** – the main or most important building on a site, as opposed to an associated resource.

**Property**—area of land containing a single historic resource or a group of resources, and constituting a single entry in the National Register of Historic Places.

**Property type** – a grouping of properties defined by common physical and associative attributes.

**Reconnaissance survey**—a general survey, also known as a windshield survey, which notes the kinds of properties and boundary of survey. Often this type of survey is the first step in a more intensive survey to get a sense of the resources within a defined area.

**Resource**—any building, structure, site, or object that is part of or constitutes a history property.

**Resource type**—the general category of property (building, structure, site, district, or object) that may be listed in the National Register of Historic Places.

**Recommendation of Eligibility (ROE)** – A recommendation by the individual recording a property as to the likelihood that the property will be determined eligible or not to the National Register of Historic Places. This opinion may or may not be reflected in the agency and SHPO determinations, but is useful for drawing a conclusion regarding eligibility.

**Rural** – pertaining to any resources found in an area outside cities and towns.

**Setting**—the physical environment of a historic property.

**Secretary of the Interior’s Standards of the Treatment of Historic Properties (SOI, or Standards)** – Guidelines developed by the National Park Service to ensure consistent and appropriate methods for handling historic properties. <http://www.nps.gov/hps/tps/standguide/>

**Section 106** – A portion of the National Historic Preservation Act of 1966, as amended that requires all federal agencies to take into account the effects of their undertaking (activities) on historic properties, and to afford the Advisory Council on Historic Preservation an opportunity to comment on any such undertakings. These undertakings are triggered if federal permit, funding, or land is involved. See 36CFR800.

**SHPO resource number** – a unique identification number assigned by the SHPOs office to architectural resources within the state and includes Building-numbers, Structure-numbers, Object-numbers, and District-numbers.

**Significance**—See area of significance, level of significance, and period of significance.

**Significant dates**—date of an event or activity related to the importance for which a property meets the National Register of Historic Places criteria.

**Site**—location of a significant event, a prehistoric or historic occupation or activity, or building or structure, whether standing, ruined, or vanished, where the location itself possesses significance independent of the value of any existing structure at that location.

**Statement of significance**—section of the nomination form that states and explains the reasons a property meets the criteria for listing in the National Register of Historic Places.



**Survey**—the collection and analysis of information concerning the physical remains of cultural resources. Typically includes: field recordation of resources; planning and background research; organization and presentation of survey data; and the development of inventories.

**Theme**—a trend or pattern in history or prehistory relating to a particular aspect of cultural development, such as mining, ranching, or gaming.

**Undertaking**—any project, activity, or program under the direct or indirect jurisdiction of a federal agency, or licensed, permitted, funded, or assisted by a federal agency, that can result in changes in the character or use of historic properties.

**Unevaluated**—a resource that has not been formally recorded and evaluated by a federal agency for listing in the National Register of Historic Places.

**Urban**—areas characterized by higher population density and vast human features in comparison to areas surrounding it, typically considered cities or towns.

**UTM** – a set of coordinates (easting and northing) that indicates a unique location according to the Universal Transverse Mercator (UTM) grid appearing on maps of the United States Geological Survey (USGS).

**Workmanship**—the physical evidence of the crafts of a particular culture or people during any given period of history or prehistory.

## APPENDIX B: Building Recording Guide *ATTRIBUTES, PHYSICAL CHARACTERISTICS & GENERAL LAYOUT*

No. of Stories: 1, 1½	Dimensions: Length	Width	Gross Square Footage:
Footprint/Form: L-shaped, rectangular, etc.			

### Construction

*Construction Method: (e.g. Platform, Box Frame, Masonry, other-)	*Construction Material: (e.g. Wood, metal, adobe, RR tie, other-)
---	---

### Foundation Details

Foundation Type: (e.g. perimeter, slab, other-)	Foundation Material: (e.g. concrete, stone, wood, other-)	Basement: (e.g. None, Unknown, walk-out, other-)
---	---	--

### Exterior Cladding

Cladding Type: (e.g. shingles, lap board, B&B, other-)	Cladding Material: (e.g. vinyl, wood, asbestos, metal, other-)
--	--

### Primary Facade

Pattern of Fenestration: (Symmetrical, asymmetrical?)	Window/Door Arrangement: (e.g. W W D W)
Decorative Details:	

### Roof

Roof Type: (e.g. Front-gabled, Side-gabled, Hipped, Flat, other-)	Roof Pitch: (Steep, Moderate, Low)	Roof Material: (e.g. Wood Shingle, Wood Shake, Metal, other-)	Historic Color (if known):
---	------------------------------------	---	----------------------------

### Chimney(s) No Chimney

Chimney Material: (e.g. stovepipe, brick, CMU, other-)	Chimney Placement: (e.g. interior, exterior, south wall, other-)
--	--

### Dormer(s) No Dormers

Dormer Type: (e.g. Wall, Roof)	Dormer Roof Shape: (e.g. Front gabled, Shed, eyebrow, other-)	Dormer Placement: (direction facing)	Historic Color (if known):
--------------------------------	---	--------------------------------------	----------------------------

### Windows

Window Type: (e.g. Casement, Hopper, other-)	Window Material: (e.g. Wood, Vinyl, Aluminum, other-)	Lights: (e.g. 1/2, 6/1, 6-6)	Historic Color (if known):
--	---	------------------------------	----------------------------

### Door(s)

Door Type: (e.g. Flush, panel, Christian, other-)	Door Material: (e.g. wood, metal, other-)	# of Panels:	# of Lights:	Historic Color (if known):
---	---	--------------	--------------	----------------------------

### Porch(es) No Porch

Porch Type: (e.g. Inset, attached, other-)	Porch placement: (direction facing or front, rear)	Porch Roof: (e.g. Shed)	Historic Color (if known):
--	--	-------------------------	----------------------------

### Interior Walls Interior not accessible

Wall Material: (e.g. lathe and plaster, drywall, other-)	Details: (e.g. wainscot, wallpaper, paneling)	Historic Color (if known):
--	---	----------------------------

## APPENDIX C: Structure Recording Guide

No. of Stories: 1, 1½	Footprint: H, L, I, rectangular	Function: Mill, kiln, etc.
Dimensions: Length	Width	Depth

### Construction

Construction Method: (e.g. Platform, Box Frame, Masonry)	Construction Material: (e.g. Wood, metal, adobe, RR tie)
--	--

### Foundation Details

Foundation Type: (e.g. perimeter, slab, etc.)	Foundation Material: (e.g. concrete, stone, wood, etc.)
---	---

### Exterior Cladding

Cladding Type: (e.g. shingles, lap board, B&B, etc.)	Cladding Material: (e.g. vinyl, wood, asbestos, metal, etc.)
--	--

### Roof

Roof Type: (e.g. Front-gabled, Side-gabled, Hipped, Flat, etc.)	Roof Pitch: (Steep, Moderate, Low)	Roof Material: (e.g. Wood Shingle, Wood Shake, Metal, etc.)	<i>Historic Color (if known):</i>
---	------------------------------------	---	-----------------------------------

### Windows

Window Type: (e.g. Casement, Hopper, etc.)	Window Material: (e.g. Wood, Vinyl, Aluminum, etc.)	Lights: (e.g. 1/2, 6/1, 6-6)	<i>Historic Color (if known):</i>
--	---	------------------------------	-----------------------------------

### Door(s)

Door Type: (e.g. Flush, panel, Christian)	Door Material: (e.g. wood, metal)	# of Panels:	# of Lights:	<i>Historic Color (if known):</i>
---	-----------------------------------	--------------	--------------	-----------------------------------

### Primary Facade

Pattern of Fenestration: (Symmetrical, asymmetrical?)	Window/Door Arrangement: (e.g. W W D W)
Decorative Details:	

### Additional Details

Shape: Round, beehive, etc.	Other:
-----------------------------	--------

**APPENDIX D: Architectural Styles** (Revised from SHPO, HRIF guidelines)

<b>Architectural Style</b>	<b>A.K.A.</b>	<b>Related Styles &amp; Sub-styles</b>	<b>Characteristic Elements</b>	<b>Date Range</b>
Alpine Modern	Swiss Chalet Modern			1930s-present
American Colonial	Colonial Revival	Adamesque, Georgian, Federal, Dutch Colonial		1790-1820s
Art Deco				1920-1930s
Beaux Arts	Beaux Arts Classicism			1920-1940
Brutalism				1940s-1970s
Cape Cod				1800-present
Classical	Classical Revival		Rectangular plan; symmetrical façade; central entrance; paired and Palladian windows; hipped roof; projecting cornice, porches, columns, Ionic or Corinthian capitals.	1895-1915
Commercial Style		Chicago Style, Sullivanesque		Late 1800s-present
Contemporary				1940s-present
Cottage	Cottage Revival	Storybook Cottage, Norman Cottage, English Cottage	1 story; stone, stucco or brick; asymmetrical; steep pitched roof with little overhang; few windows.	1900-1940s
Craftsman	Bungalow, Western Stick	Stewart Craftsman, Prairie School	Rectangular, square, L-shaped; 1-1 1/2 stories; shiplap, shingles, masonry; low pitch roof, wide overhanging eaves, front, cross, side gables; windows grouped in pairs or ribbons, multi-pane; raised entry porches, porch columns or piers; stick work, dormers, extended rafter ends, eave braces and brackets, balconies, bay windows; detached garages.	1905-1930s
Eastlake	Stick Style, Eastern Stick		Steep pitched roof, gabled or cross-gable; decorative trusses at the gables; overhanging eaves supported by simple brackets; horizontal board siding with stick work decoration; porches with diagonal braces.	1875-1895
Eclectic	Mixed Style			
Exotic		Egyptian Revival, Moorish Revival		1920s-1940s
Fantasy	Mimetic, Eccentric			

<b>Architectural Style</b>	<b>A.K.A.</b>	<b>Related Styles &amp; Sub-styles</b>	<b>Characteristic Elements</b>	<b>Date Range</b>
Formalism	New Formalism, Neo Formalism, Neo Palladianism			1950s-1970s
Googie	Roof architecture		Space age, Jetson's	1950s-1960s
Gothic	Residential, Religious, Commercial	Carpenter Gothic, Collegiate Gothic, Steamboat Gothic  Gothic Revival	Rectangular, L-or T-Shaped; 1-11/2 stories; clapboard, B&B; steep pitch roof, cross gables; pointed arch or gothic windows and entry; sidelights, transoms; jigsaw cut barge-boards, brackets, balustrades, porch, end frieze.	1820-1875; 1920s-1940s
Greek Revival		Greek Revival, Roman Revival	Rectangular or L-Shaped; 1-2 stories; horizontal clapboards; med. Pitched gable roof, eave returns, gable facing front; DH 6x6 windows; sidelights and transoms; frieze board, dentils.	1850-1870
International	Miesian, Modern			1950s-1960s
Italianate		Italian Villa	Rectangular; 2 stories; shiplap; low pitched, hipped or gabled roof; tall, narrow, sometimes arched 1x1 light with heavy crowns; tall door with transom, recessed door, boxed cornice with brackets, bay windows, cupolas, entry hood.	1875-1900
Mansard	Second Empire		Rectangular, 2+ stories; shiplap; mansard with dormers, dormers often patterned wood shingle; tall narrow windows, sometimes arched 1x1 with heavy crowns; tall door with transom, recessed door; boxed cornice with brackets, window bays, cupolas, entry hoods.	1830-1880s
Mediterranean	Mediterranean Revival		Heavy tile roof; plain ornamentation; stucco walls; few windows; casements, framed; small second story balconies.	1900-1940
Minimal Traditional			Low to moderate pitched roof; eaves and rake close to wall; large chimney; front-facing gable; Tudor-cottage details; small.	1940s-1960
Mission	Mission Revival			Late 1800s-1920s
Modern	Contractor, Corporate, Mid-Century, Late, Expressionist			1940s-present

<b>Architectural Style</b>	<b>A.K.A.</b>	<b>Related Styles &amp; Sub-styles</b>	<b>Characteristic Elements</b>	<b>Date Range</b>
Moderne	Streamline Moderne, Art Moderne, Modernistic			1920s-1940s
Mountain Rustic	Resort Rustic			1920s-1940s
Neo Victorian				
No Style	Utilitarian			
Northwestern				
Post medieval English	Post medieval English Revival	Tudor, Jacobethan, Elizabethan		Late 1800s-1930s
Pre-manufactured	Modular, Mobile Home			1930s-present
Pueblo	Pueblo Revival			1930s-present
Queen Anne		Victorian	Irregular plan; 2+ stories; shiplap, clapboard, fancy cut shingles; hipped or gabled or combination; conical roof over tower; many types and shapes of windows; classical or ornate single or double doors, often a sidelight; spindlework, turned balustrade, frieze.	1880-1905
Ranch	Rancher, Rambling Ranch	Transitional Ranch	Rectangular or L-shaped; low-pitched roof; long, narrow and low to ground; hipped roof with wide overhanging eaves; wide porches; large patios ; de-emphasis of the main entrance; integral garage; large windows. Rustic drop, B7B; masonry veneer.	1940-present
Renaissance	Renaissance Revival			1880s-1920
Romanesque	Romanesque Revival	Richardson Romanesque		1880s-1940s
Shed Style	Sea Ranch, Third Bay Tradition			?
Shingle Style				1840-1880
Spanish Colonial	Spanish Colonial Revival			1800s-present
Split Level	Ranch variation		Horizontal lines, low-pitched roof, overhanging eaves; but added a two-story unit intercepted at mid-height by a one-story wing to make three levels.	1955-1975
Starved Classical		Restrained Classical, WPA Moderne, Depression Classical		1930s
Vernacular	Folk	Folk Vernacular, Mass Vernacular, Salvage Vernacular		1840s-Present

**APPENDIX E: House Floor Plans** (by Ron Reno)

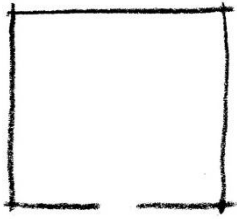

Single Cell

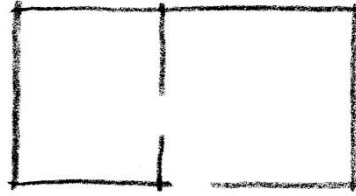

Hall-Parlor

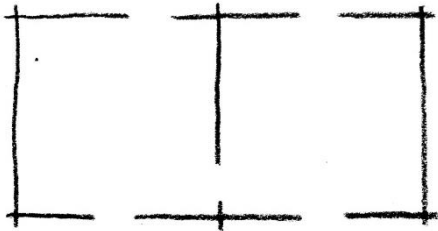

Double-Cell

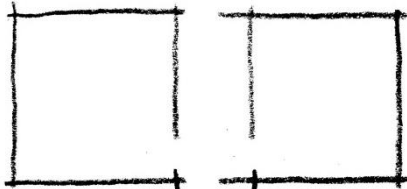

Central Passage (I-house)

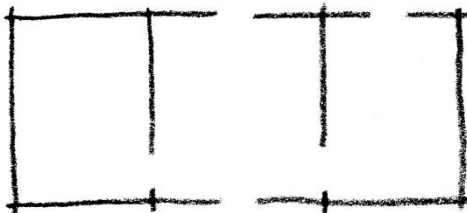

Pair-House

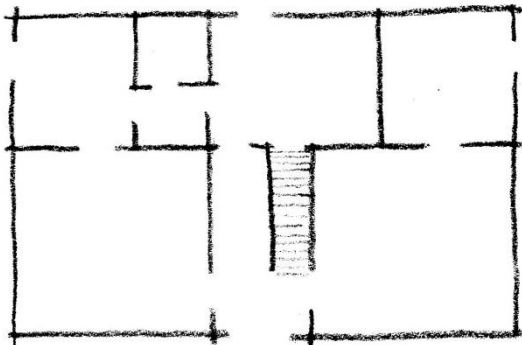

Double Pile (Georgian variant)

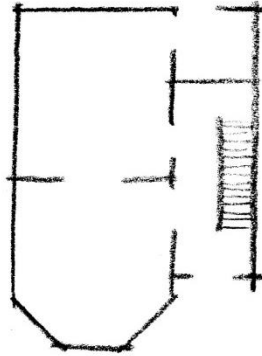
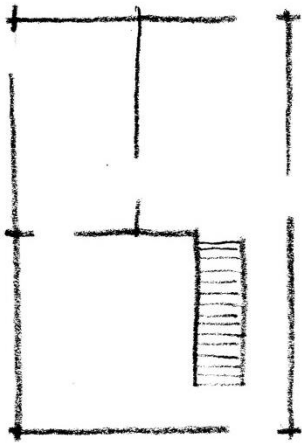

Side Passage/Entry Hall (two variants) Victorian examples often have many protruding bays.

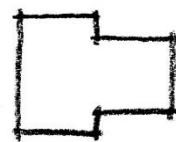
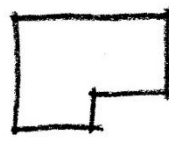
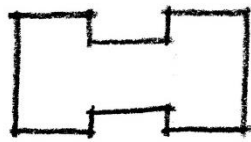
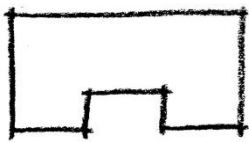

Cross Wing (four variants) U, I, L, and T-shaped floor plans

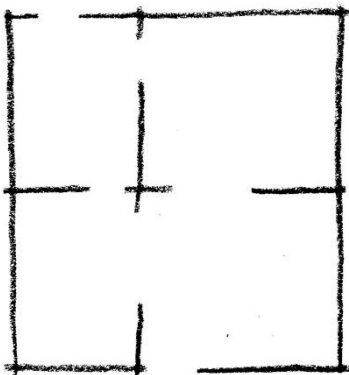

Foursquare

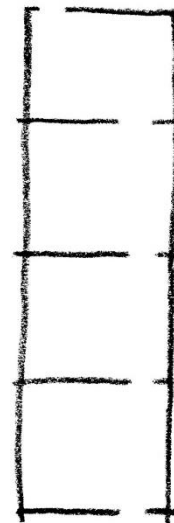

Shotgun



## ROOF TYPES (by Ron Reno)

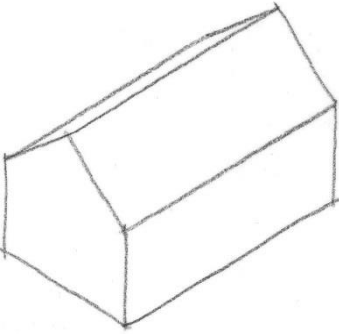

Gabled

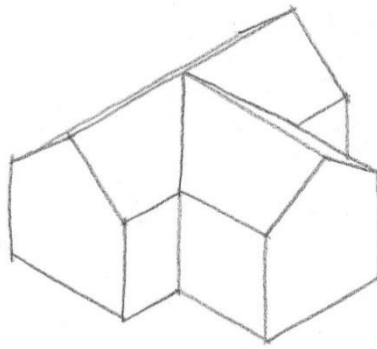

Cross-gabled

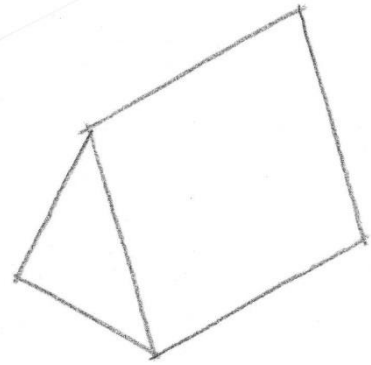

A-Frame

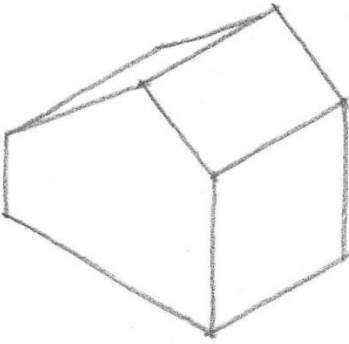

Saltbox

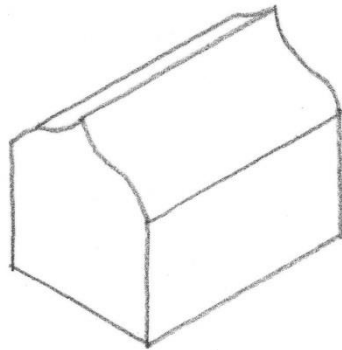

Ogee

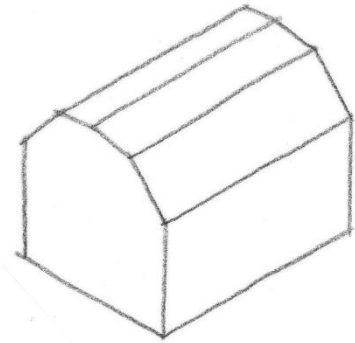

Gambrel

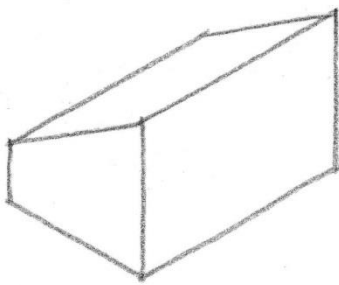

Shed

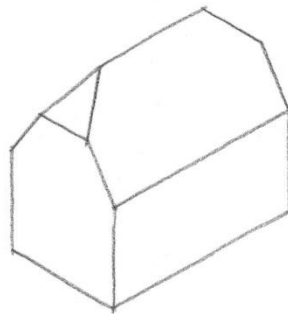

Clipped Gable (Jerkin-head)

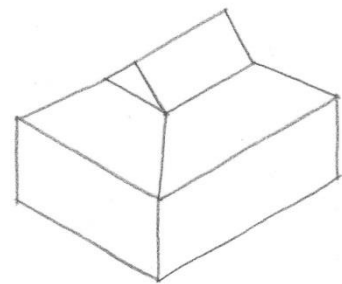

Gable-and-hip

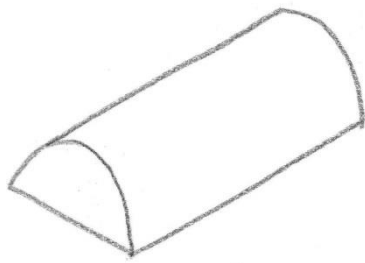

Semi-cylindrical

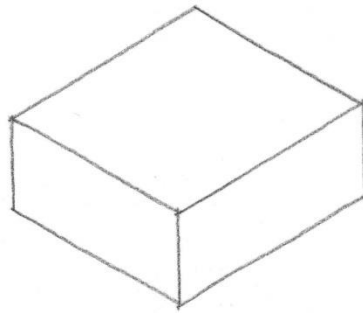

Flat

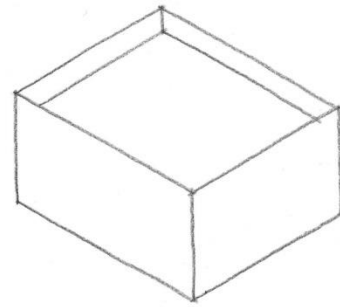

Flat with parapet

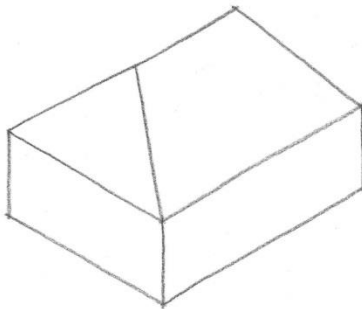

Hip

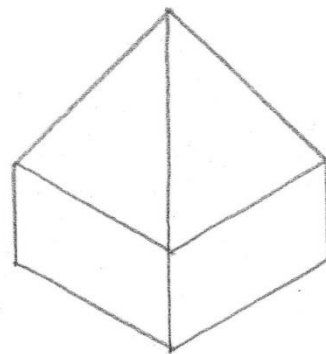

Pyramidal, square

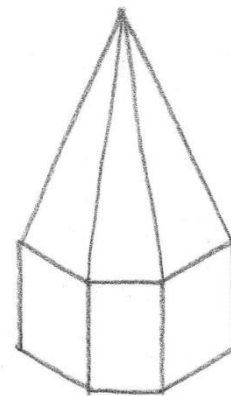

Pyramidal, octagonal

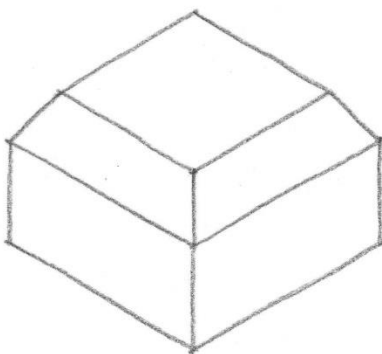

Mansard

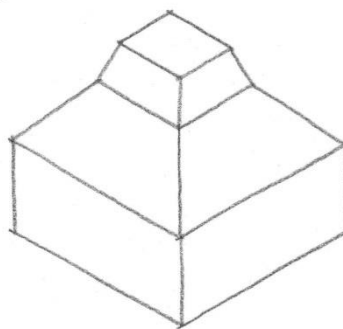

Pavilion

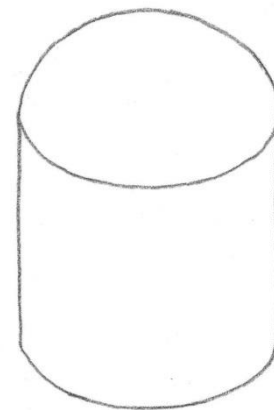

Hemispherical

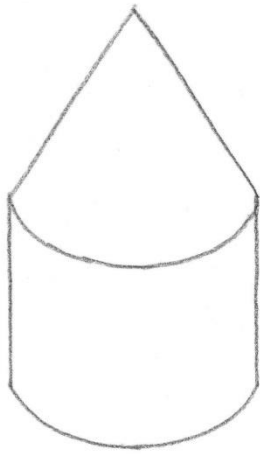

Conical

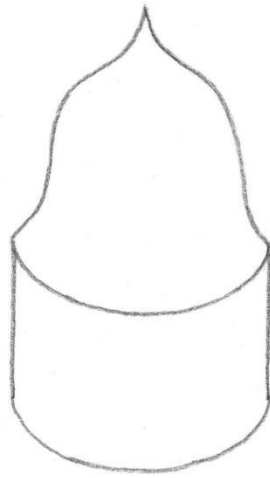

Bell

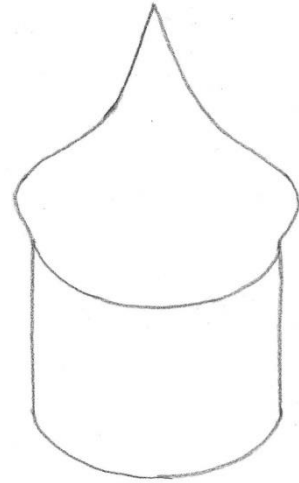

Onion

**APPENDIX F: Illustrations of Nevada Architecture – Alphabetically**  
 (With special permission from Elizabeth Dickey, NDOT)

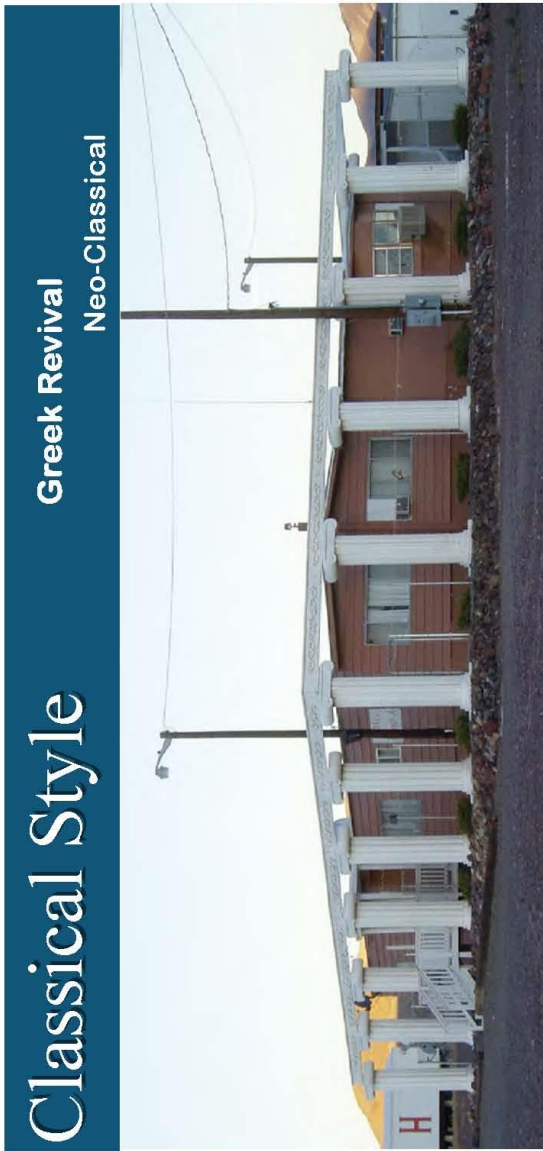

“Classical” does not always equal “classy.” Modern-day interpretation of the Classical style at a brothel. Las Vegas Highway, Clark County. (Ron Reno 2008)

**Time Frame:** Mid 1800s-Present

**Common Character Defining Traits:**

- Uses elements from classic Greek architecture including columns, architraves, friezes, and pediments.
- Broken returns on roofline
- Cornerboards mimic columns
- Symmetrical
- Decorative accent such as dentils , acanthus leaves, or egg and dart molding

**Notes:** High style classical buildings are usually public buildings such as schools, banks or courthouses. Classical influences on domestic architecture is usually subtle, sometimes just a pedimented lintel, a broken eave return, or a cornerboards that allude to a column.



Ionic columns surround the Lagomarsino House in Sparks, Washoe County. This is a version of the “hipped box” form. (Elizabeth Dickey)



Pershing County’s unusual round courthouse in Lovelock was designed by Nevada State Architect Frederick J. DeLongchamps. (Elizabeth Dickey, 2010)

# Contemporary Style

**Time Frame:** 1940s-present

**Common Character Defining Traits:**

- Low pitched or flat roofs
- Decoration tends to be abstract or geometric
- Asymmetrical and geometric massing
- Prominent structural elements such as posts or exposed rafters
- Integrated into the landscape

**Notes:** Contemporary Style is a softened, more livable version of the International Style and the Modern Style of the 1940s-1960s. The Contemporary Ranch is ubiquitous and remains a popular residential style to this today.



Residence in Reno, Washoe County (Suzan Slaughter, 2013)



Residence in Lovelock, Pershing County. The angled supports for the porch are the only Contemporary style element of this building. (E. Dickey, 2010)



Apartment building in Carson City, Carson City County. The geometric massing and applied decorative elements are typical of a Contemporary building (Mason Kirtz, 2013)

# CRAFTSMAN STYLE

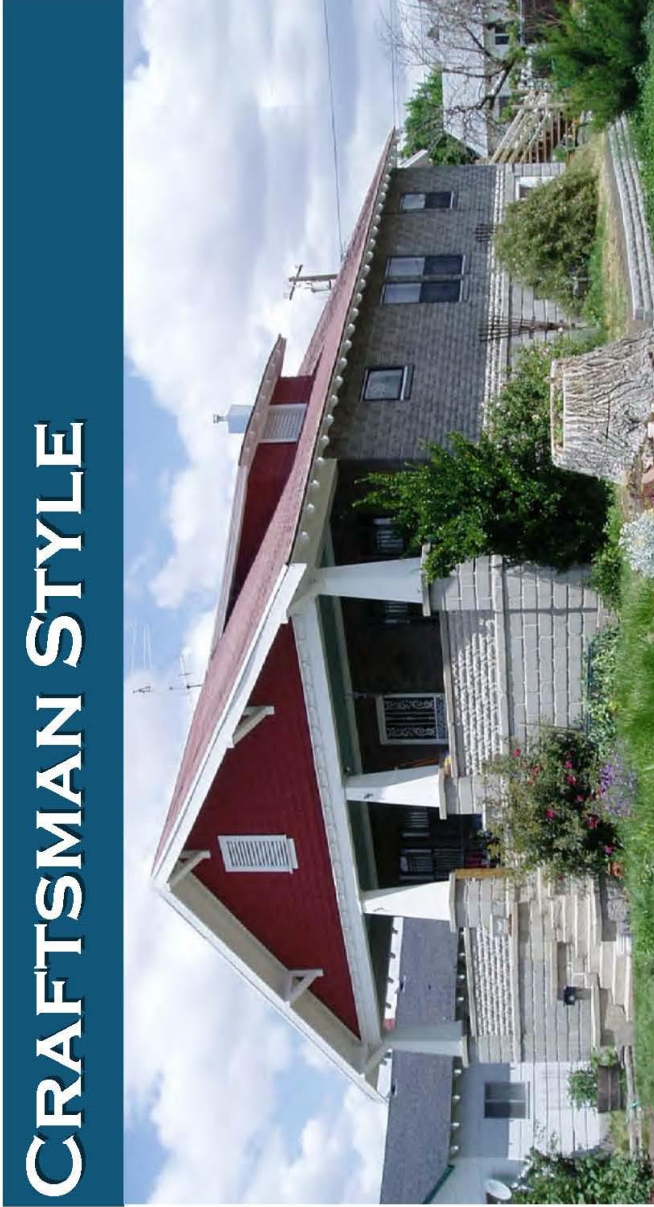

The cast concrete “stone” blocks on this Craftsman style home in Sparks, Washoe County, were a popular building material from 1900 to 1930. (Ron Reno, 2009)

**Time Frame:** 1900s-1920s

**Common Character Defining Features:**

- Battered or squared porch posts
- Decorative brackets under eaves
- Mix of materials such as stone, shingles and lap board
- Broad overhanging eaves
- Exposed rafter tails and beams
- Jerkin head (clipped hip) roof
- Compact massing under a low to moderate pitched roof

**Notes:**

This was a common residential style from the 1900s to the late 1920s/early 1930s. Designs often came from plan books or whole house kits were mail ordered from catalogs.



Lovelock, Pershing County. (Elizabeth Dickey, 2009)



Craftsman style garage in Lovelock, Pershing County. (Elizabeth Dickey, 2009)

# FORMALISM

## Neo Palladianism

### Neo Formalism



Las Vegas, Clark County.



Carson City, Carson City County. (Megan Kilty, 2013)

**Time Frame:** 1950s–1970s

**Common Character Defining Traits:**

- Common materials include concrete and glass panels
- Uses classical elements such as columns and friezes, but simplified
- Flat, overhanging roof
- Repetitive abstract patterns created from the structure of the building.

**Notes:** This was a popular style for banks, government buildings, and office buildings. It shares many common traits with the Contemporary Style but tends to be used for larger, public buildings and draws more heavily on classical architecture.

# Minimal Traditional Style

**Time Frame:** 1940s-1950s

**Common Character Defining Traits:**

- Very little, or no, eave overhang
- Small, one or one-and-a-half story
- Usually no porch
- Gabled roof
- Metal casement windows are common
- Little or no ornamentation
- Boxy, compact massing

**Notes:**

Popular during WWII when a scarcity of material forced builders to economize wherever possible. Popular style for residences.

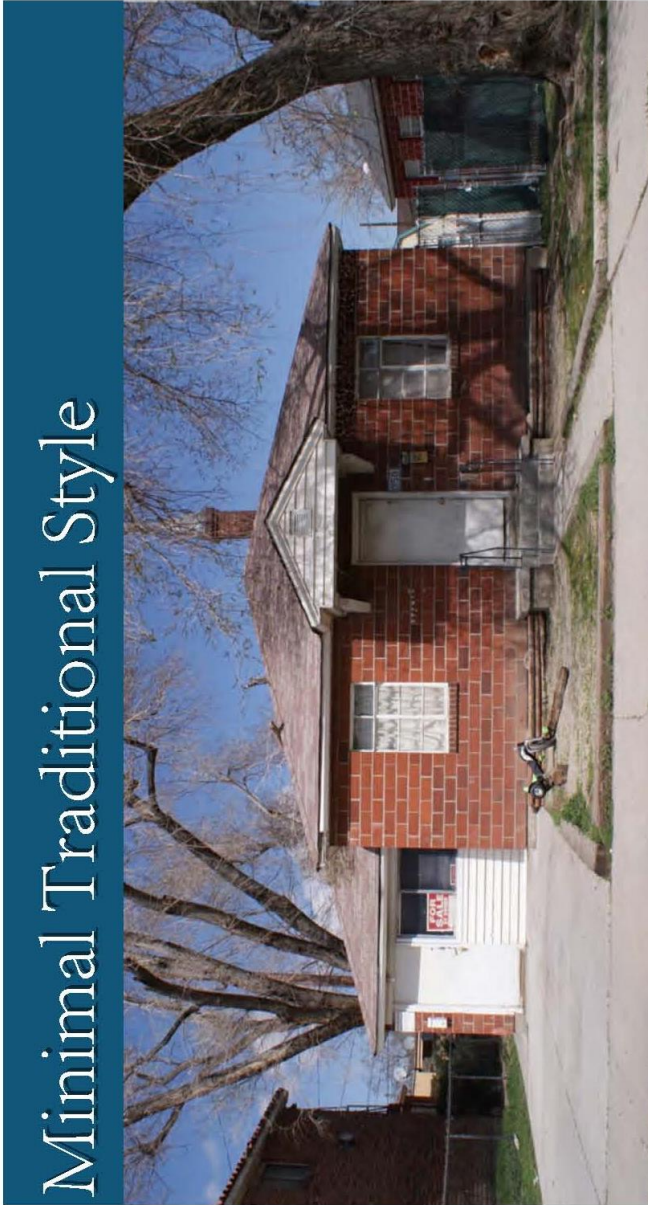

Reno, Washoe County. (Elizabeth Dickey, 2010)



Sparks, Washoe County. (Ron Reno, 2010)



Lovelock, Pershing County. (Elizabeth Dickey, 2010)



# Mission Style

Spanish Mission Revival



Rhyolite Train Depot, Rhyolite, Nye County. (Jennifer Riddle, 2013)

**Time Frame:** Late 1800s -1920s

## Common Character Defining

### Traits:

- Smooth or textured stucco surface
- Clay barrel tile roof
- Rounded arches

**Notes:** Other great examples of the Mission style used on train stations are the stations at Caliente and East Ely.



Mission style applied to a bungalow form in Lovelock, Pershing County. (Elizabeth Dickey, 2009)



Mission style false fronted commercial building in Sparks, Washoe County. (Elizabeth Dickey, 2010)

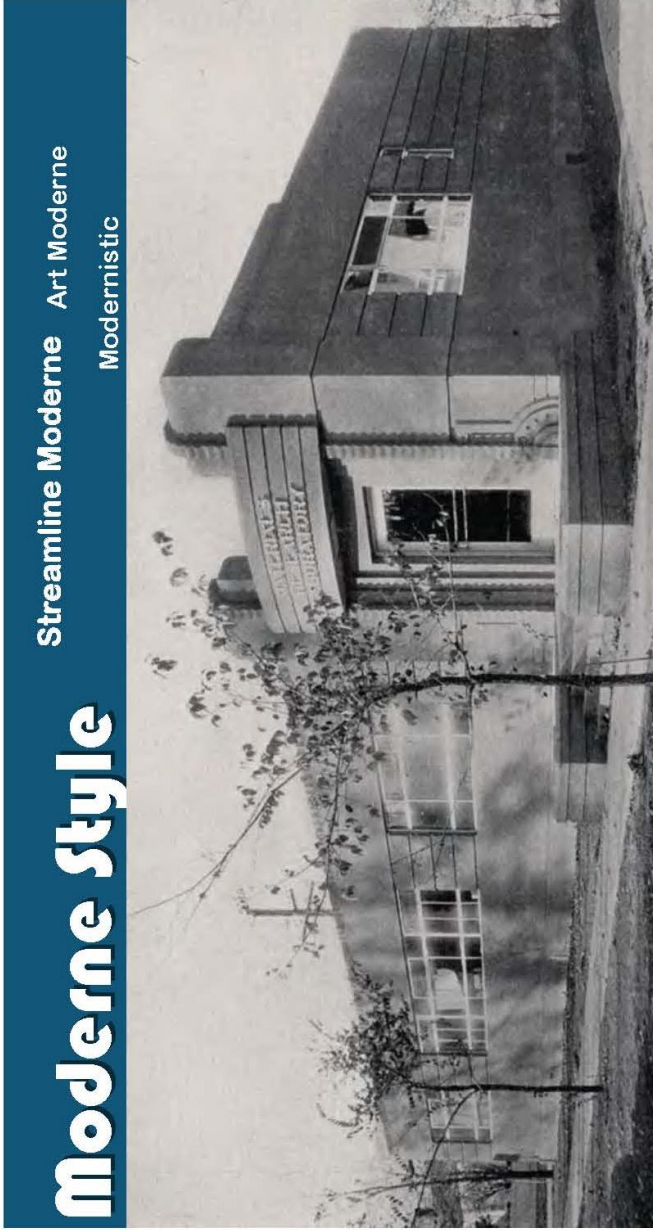

Materials and Research Laboratory for the Nevada Highway Department in Carson City, Carson City County. This building is still standing but suffers from a second story addition. (Nevada Highway Department Biennial Report)

**Time Frame:** 1920s-1940s

**Common Character Defining Features:**

- Horizontal lines
- Incised “speed whiskers”
- Smooth stucco surfaces
- Use of glass block
- Rounded edges

**Notes:** More common in commercial buildings. Also used on Nevada Highway Department bridges in the 1940s.



Lovelock, Pershing County. (Elizabeth Dickey)



Moderne bridges, like this on ein Dunphy, Eureka County, were a standard design in Nevada in the 1940s. (Cliff Creger, 2011)

# Rustic Style

## Mountain Rustic

### Resort Rustic



Dobson Hall at Zephyr Point Presbyterian Conference Center, Zephyr Cove. (Elizabeth Dickey, 2012)

**Time Frame:** 1920s-1940s

**Common Character Defining Features:**

- Exposed rafters
- Steeply gabled roof
- Porches
- Common materials include: milled half “logs”, real logs, wood novelty siding, local stone
- Accents such as porch railings or brackets made from branches
- Integrated into the landscape to take advantage of views

**Notes:** A treasure trove of Rustic Style building can be seen around Lake Tahoe. The buildings are often simple and distinguished only by their rustic materials.



Cabin at Zephyr Point Presbyterian Conference Center, Zephyr Cove. (Elizabeth Dickey, 2012)



Cabin at Zephyr Point Presbyterian Conference Center, Zephyr Cove. (Elizabeth Dickey, 2012)

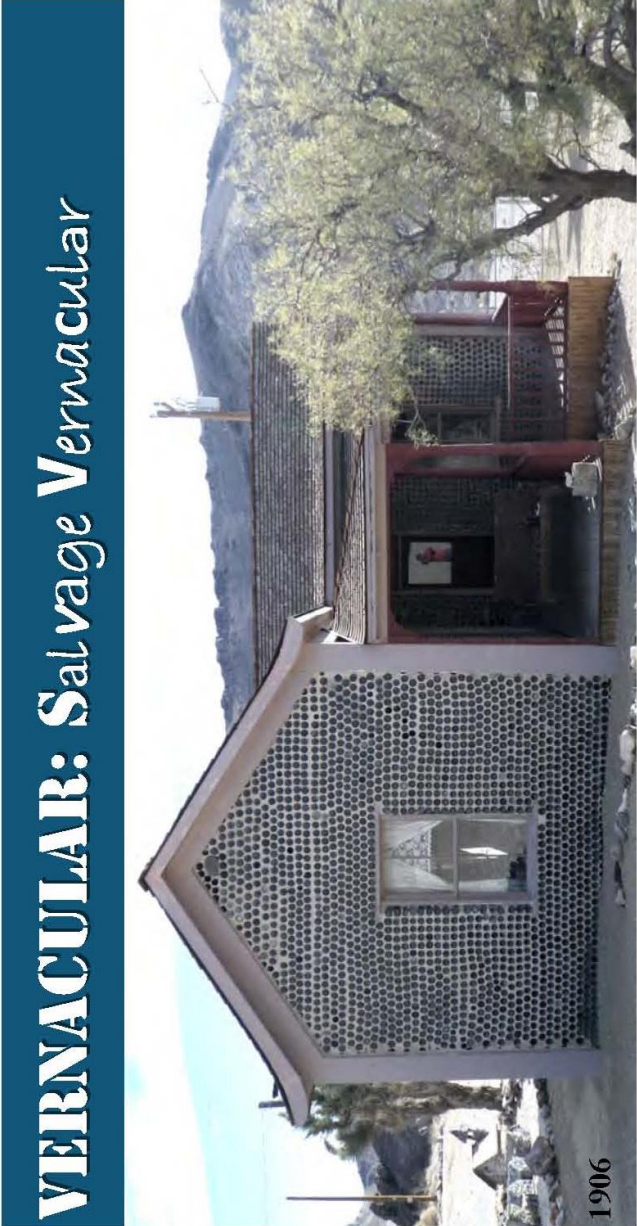

**Time Frame:** 1840s-Present

**Common Character Defining Traits:**

- Uses salvaged materials not originally intended for construction, such as glass bottles, barrels, tin cans, packing crates, and railroad ties.
- May repurpose larger structures or objects for use as a building, such as railroad cars and shipping containers.
- Small in size with simple massing
- Combines salvaged material and mass produced material (usually windows and doors).

**Notes:**

Salvage Vernacular buildings can be found throughout Nevada. They are especially common where access to transportation routes was limited. Remote mining communities perfected the architectural use of the flattened tin can. Some Salve vernacular buildings were created from necessity, some were created from convenience, such as the railroad tie buildings found in railroad communities. Some were created out of eccentricity such as the bottle house of Rhyolite built by Tom Kelly.

The Bureau of Land Management recently restored the bottle house in Rhyolite, Nye County (Jennifer Riddle, 2013)

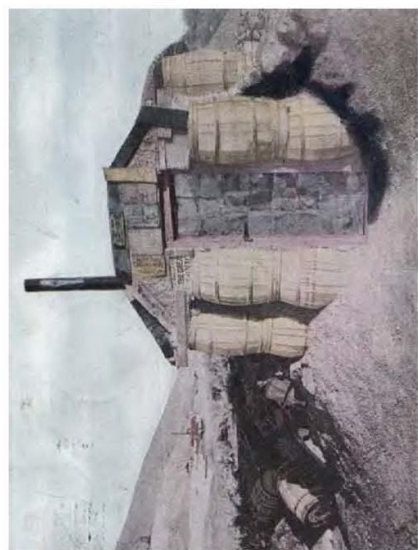

Half-dugout made from discarded barrels and flattened cans in Tonopah, Nye County. (The Dennison)

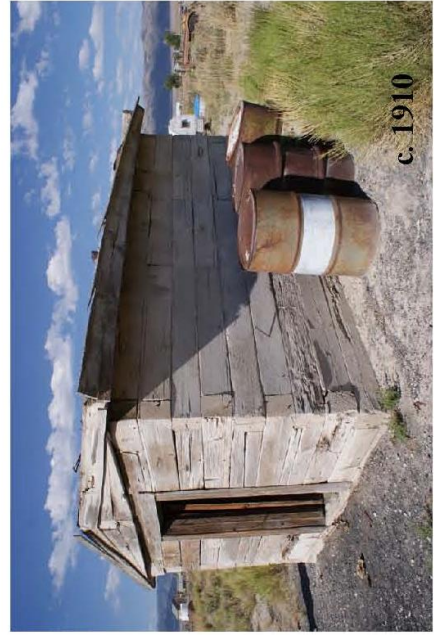

Shed made from railroad ties. Currie, Elko County. (Elizabeth Dickey)

## **APPENDIX G: Standards for Digital Photography for Inventory and Recording (from BLM Protocols)**

The standards presented below reflect the 2014 BLM protocols, however, it is always advisable to review the most current standards or consult with the federal agency prior to conducting fieldwork. High quality digital color images should be submitted with reports to record heritage resources (including buildings and structures), artifacts, settings, landscapes and related subjects found during inventory and evaluation phases. A standard metric or metric/English scale must accompany artifact photos and other images where scale is needed to convey essential information.

### **Inventory-level Digital Image Recording and Submission Standards**

1. High-quality digital images are required.
  - a. Individual image files must be a minimum of 1200-x-1600 pixels (approximately 1.9 megapixels) each.
  - b. These images must allow for printing a high-quality image in either color or black-and-white with a minimum of 300 x 300 dots per inch (dpi) or higher.
2. Images are required in digital format, and may also be required in print format, or both digital and print formats.
  - a. The Agency should be consulted to determine whether print copies will be required for submittal to SHPO.
  - b. Digital images included in the NARA form must be accompanied by a label including: the photo caption; View to or direction of photo; the photographer, date, and the photo file name. The SHPO Resource number, site number, and Agency number may also be included. If persons are present in the image, they should be identified by first and last name.
  - c. Printed images submitted with reports must measure no less than 4-x-6 inches and may be printed on either standard-sized paper (8.5 x 11 inch) or as individual print images on photographic paper, as determined by agency.
3. Digital images will be submitted in an acceptable electronic format (e.g., compact disk, flashdrive).
  - a. Agency's should be consulted to determine the acceptable means of storing digital images.
  - b. Image file formats should be as JPEG or TIFF.
  - c. Storage media must be labeled individually with the project name, project number or other assignment, month and year, and source or provider (e.g., permittee company name).

## APPENDIX H: Historic Resources Contact List

### State Historic Preservation Office

901 S Stewart Street, Suite 5004  
 Carson City, NV 89701  
 775-684-3448  
[www.shpo.nv.gov](http://www.shpo.nv.gov)

### Nevada Department of Transportation

Cultural Resources Section  
 1263 S. Stewart Street  
 Carson City, NV 8973  
 775-888-7013  
[www.nevadadot.com/About\\_NDOT/NDOT\\_Divisions/Engineering/Environmental\\_Services/Cultural\\_Resources.aspx](http://www.nevadadot.com/About_NDOT/NDOT_Divisions/Engineering/Environmental_Services/Cultural_Resources.aspx)

Contact Name	Address/Phone	Website/E-mail
<b>Certified Local Governments CLGs</b>		
<b>Carson City Historic Resource Commission</b>  Carson City Planning Division	108 E. Proctor St. Carson City, NV 89701 775-887-2180	E-mail: <a href="mailto:planning@carson.org">planning@carson.org</a>  <a href="http://www.carson.org/index.aspx?page=792">www.carson.org/index.aspx?page=792</a>
<b>City of Las Vegas Historic Preservation Commission</b>  Las Vegas Planning Department	333 N. Rancho Drive Las Vegas, NV 89106 702-229-5260	<a href="http://www.lasvegasnevada.gov/Government/20646.htm">www.lasvegasnevada.gov/Government/20646.htm</a>
<b>Comstock Historic District Commission</b>	P.O. Box 128 Virginia City, NV 89440 775-847-0281	<a href="http://www.nvshpo.org/boards-and-commissions-441/comstock-historic-district-commission.html">www.nvshpo.org/boards-and-commissions-441/comstock-historic-district-commission.html</a>
<b>Reno Historical Resources Commission</b>  Reno Planning Department	1 East First Street Reno, NV 89501 775-321-8309	<a href="http://www.reno.gov/government/boards-commissions/d-r/historical-resources-commission">www.reno.gov/government/boards-commissions/d-r/historical-resources-commission</a>
<b>History Museums by County</b>		
<b>Carson City County</b>  <b>Foreman-Roberts House Museum</b>	1207 North Carson Street Carson City, NV 89706 775-887-2174	<a href="http://www.carson.org/index.aspx?page=1093">www.carson.org/index.aspx?page=1093</a>
<b>Nevada State Capitol Museum</b>	Nevada State Capitol, 2 <sup>nd</sup> floor North Carson Street Carson City, NV 89701	
<b>Nevada State Museum</b>	600 North Carson Street Carson City, NV 89701	<a href="http://www.museums.nevadaculture.org/index.php?option=com_content&amp;view=article&amp;id=486&amp;Itemid=406">www.museums.nevadaculture.org/index.php?option=com_content&amp;view=article&amp;id=486&amp;Itemid=406</a>

Contact Name	Address/Phone	Website/E-mail
	775-687-4810	
<b>Nevada State Railroad Museum</b>	2180 South Carson Street Carson City, NV 89701 775-687-6953	<a href="http://www.museums.nevadaculture.org/index.php?option=com_content&amp;view=article&amp;id=412&amp;Itemid=123">www.museums.nevadaculture.org/index.php?option=com_content&amp;view=article&amp;id=412&amp;Itemid=123</a>
<b>Warren Engine Company No. 1 Museum</b>	111 North Curry Street Carson City, NV 89703 775-887-2210	
<b>Churchill County Buckland Station</b>	US 95 A Silver Springs, NV 775-577-4880	<a href="mailto:bucklandstation@hotmail.com">bucklandstation@hotmail.com</a> <a href="http://www.parks.nv.gov/category/buckland-station-2">www.parks.nv.gov/category/buckland-station-2</a>
<b>Churchill County Museum &amp; Archives</b>	1050 South Maine Street Fallon, NV 89406 775-423-3677	<a href="http://www.ccmuseum.org">www.ccmuseum.org</a>
<b>Fort Churchill State Historic Park</b>	Ft. Churchill Road Silver Springs, NV 89429 775-577-2335	<a href="mailto:ftchurchill@hdiss.net">ftchurchill@hdiss.net</a> <a href="http://www.parks.nv.gov/parks/fort-churchill-state-historic-park/">www.parks.nv.gov/parks/fort-churchill-state-historic-park/</a>
<b>Clark County Boulder City/Hoover Dam Museum</b>	1305 Arizona Street Boulder City, NV 89005 702-294-1988	<a href="mailto:info@BCMHA.org">info@BCMHA.org</a> <a href="http://www.bcmha.org">www.bcmha.org</a>
<b>Clark County Heritage Museum</b>	1830 South Boulder Highway Henderson, NV 89002 702-455-7955	<a href="http://www.clarkcountynv.gov/Depts/parks/Pages/clark-county-museum.aspx">www.clarkcountynv.gov/Depts/parks/Pages/clark-county-museum.aspx</a>
<b>Lost City Museum</b>	721 S Moapa Valley Blvd Overton, NV 89040 702-397-2193	<a href="mailto:lostcity@nevadaculture.org">lostcity@nevadaculture.org</a>
<b>The Mob Museum</b>	300 Stewart Avenue Las Vegas, NV 89101 702-229-2734	<a href="http://www.themobmuseum.org">www.themobmuseum.org</a>
<b>The National Atomic Testing Museum</b>	755 E Flamingo Road Las Vegas, NV 89119 702-794-5151	<a href="http://www.nationalatomictestingmuseum.org/">http://www.nationalatomictestingmuseum.org/</a>
<b>Neon Museum</b>	770 N Las Vegas Blvd Las Vegas, NV 89101 702-387-6366	<a href="http://www.neonmuseum.org">www.neonmuseum.org</a>
<b>Nevada State Museum – Las Vegas</b>	309 S Valley View Road Las Vegas, NV 89107 702-486-5205	<a href="http://www.museums.nevadaculture.org/index.php?option=com_content&amp;view=article&amp;id=427&amp;Itemid=438">www.museums.nevadaculture.org/index.php?option=com_content&amp;view=article&amp;id=427&amp;Itemid=438</a>
<b>Nevada State Railroad Museum, Boulder City</b>	601 Yucca Street Boulder City, NV 89005 702-486-5933	<a href="http://www.museums.nevadaculture.org/index.php?option=com_content&amp;view=article&amp;id=409&amp;Itemid=124">www.museums.nevadaculture.org/index.php?option=com_content&amp;view=article&amp;id=409&amp;Itemid=124</a>
<b>Old Las Vegas Mormon Fort State Historic Park</b>	500 East Washington Avenue Las Vegas, NV 89101 702-456-3511	<a href="mailto:oldfort@parks.nv.gov">oldfort@parks.nv.gov</a> <a href="http://www.parks.nv.gov/parks/old-las-vegas-mormon-fort/">www.parks.nv.gov/parks/old-las-vegas-mormon-fort/</a>
<b>Searchlight Historic Museum</b>	Searchlight Community Center 200 Michael Wendall Way Searchlight, NV 89046	<a href="mailto:info@searchlighthistoricmuseum.org">info@searchlighthistoricmuseum.org</a> <a href="http://www.searchlighthistoricmuseum.org/index.html">www.searchlighthistoricmuseum.org/index.html</a>

<b>Contact Name</b>	<b>Address/Phone</b>	<b>Website/E-mail</b>
<b>Walker African-American Museum</b>	705 West Van Buren Ave Las Vegas., NV 89106 702-647-2242	
<b>Douglas County Danberg Ranch</b>	1450 Highway 88 P.O. Box 1158 Minden, NV 89423 775-783-9417	<a href="mailto:curator@dangberghomeranch.org">curator@dangberghomeranch.org</a> <a href="http://www.dangberghomeranch.org">www.dangberghomeranch.org</a>
<b>Genoa Courthouse Museum</b>	2304 Main Street Genoa, NV 89411 775-782-4325	<a href="http://www.genoanevada.org/genoamuseum.htm">www.genoanevada.org/genoamuseum.htm</a>
<b>Mormon Station State Historic Park</b>	2295 Main Street Genoa, NV 89411 775-782-2590	<a href="http://www.parks.nv.gov/parks/mormon-station-state-historic-park/">www.parks.nv.gov/parks/mormon-station-state-historic-park/</a>
<b>Elko County Northeastern Nevada Museum</b>	1515 Idaho Street Elko, NV 89801 775-738-3418	<a href="http://www.museumelko.org/index.html">www.museumelko.org/index.html</a>
<b>National Historic California Emigrant Trails Interpretive Center</b>	8 miles west of Elko at Hunter exit 292 775-738-1849	<a href="http://www.blm.gov/nv/st/en/fo/elko_field_office/blm_programs/blm_special_areas/california_trail_historic.html">www.blm.gov/nv/st/en/fo/elko_field_office/blm_programs/blm_special_areas/california_trail_historic.html</a>
<b>Eureka County Eureka Sentinel Museum</b>	10 North Monroe Street Eureka, NV 775-237-5010	<a href="http://www.co.eureka.nv.us/tourism/museum01.htm">www.co.eureka.nv.us/tourism/museum01.htm</a>
<b>Humboldt County Humboldt Museum</b>	175 Museum Lane P.O. Box 819 Winnemucca, NV 89446 775-623-2912	<a href="mailto:museum@winnemucca.net">museum@winnemucca.net</a> <a href="http://www.humboldtmuseum.org">www.humboldtmuseum.org</a>
<b>Lander County Gridley Store Museum</b>	180 Main Street Austin, NV 89310 775-964-1202	
<b>St. Augustine's Cultural Center</b>	113 Virginia Street P.O. Box 503 Austin, NV 89310 775-964-2200	<a href="mailto:staugustines@goaustinnevada.com">staugustines@goaustinnevada.com</a> <a href="http://www.goaustinnevada.com/staug.html">www.goaustinnevada.com/staug.html</a>
<b>Lincoln County Lincoln County Historical Museum</b>	69 Main Street Pioche, NV 89043 775-962-5207	<a href="http://www.robertwynn.com/PiocheMuseum.htm">www.robertwynn.com/PiocheMuseum.htm</a>
<b>Virgin Valley Heritage Museum</b>	35 West Mesquite Blvd Mesquite, NV 89027 702-346-5295	
<b>Lyon County Dayton Museum</b>	485 Shady Lane P.O. Box 485 Dayton, NV 89403 775-246-6316	<a href="http://www.daytonnvhistory.org/museum_contacts.htm">www.daytonnvhistory.org/museum_contacts.htm</a>
<b>Lyon County Museum</b>	215 South Main Street Yerington, NV 89447 775-463-6576	<a href="mailto:info@lyoncountymuseum.com">info@lyoncountymuseum.com</a> <a href="http://www.lyoncountymuseum.com">www.lyoncountymuseum.com</a>
<b>Mineral County</b>	925 E Street	<a href="http://www.hawthorneordnancemuseum.com">www.hawthorneordnancemuseum.com</a>



Contact Name	Address/Phone	Website/E-mail
<b>Hawthorne Ordnance Museum</b>	P.O. Box 2008 Hawthorne, NV 89415 775-945-5400	
<b>Mineral County Museum</b>	400 Tenth Street P.O. Box 1584 Hawthorne, NV 89415 775-945-5142	<a href="mailto:gm@mcmuseum.hawthorne.nv.us">gm@mcmuseum.hawthorne.nv.us</a> <a href="http://www.web2.greatbasin.net/~mcmuseum/index.html">www.web2.greatbasin.net/~mcmuseum/index.html</a>
<b>Nye County Beatty Museum &amp; Historical Society</b>	417 Main Street Beatty, Nevada 89003 775-553-2303	<a href="http://www.beattymuseum.org">www.beattymuseum.org</a>
<b>Central Nevada Museum</b>	1900 Logan Field Road Tonopah, NV 89049 775-482-9676	<a href="mailto:cnmuseum@citlink.net">cnmuseum@citlink.net</a> <a href="http://www.tonopahnevada.com/CentralNevadaMuseum/default.html">www.tonopahnevada.com/CentralNevadaMuseum/default.html</a>
<b>Friends of the Belmont Courthouse</b>	P.O. Box 985 Tonopah, Nevada 89049 775-482-3968	<a href="http://www.belmontcourthouse.org">www.belmontcourthouse.org</a>
<b>Manhattan Town Library &amp; Museum</b>	Hwy 377 and Gold Street Manhattan, NV 89022 775-487-2326	
<b>Pahrump Valley Museum &amp; Historical Society</b>	401 E Basin Ave Pahrump, NV 89060 775-751-1970	<a href="http://www.facebook.com/pahrumpvalleymuseum">www.facebook.com/pahrumpvalleymuseum</a>
<b>Tonopah Historic Mining Park</b>	520 McCulloch Ave P.O. Box 965 Tonopah, NV 89049 775-482-9274	<a href="http://www.tonopahhistoricminingpark.com">www.tonopahhistoricminingpark.com</a>
<b>Pershing County Frank Chang Memorial Museum</b>	Garage of Cadillac Inn 1395 Cornell Ave Lovelock, NV 89419 775-273-2798	
<b>Marzen House Museum</b>	25 Marzen Lane Lovelock, NV 89419 775-273-7213	<a href="http://www.loverslock.com/Lovelock-Historical_Sites.html">www.loverslock.com/Lovelock-Historical_Sites.html</a>
<b>Storey County Comstock History Center</b>	20 North E Street Virginia City, NV 89440 775-847-0419	<a href="http://www.visitvirginiacitynv.com/attractions/virginia-city-museums/list-of-museums.html#comstock">www.visitvirginiacitynv.com/attractions/virginia-city-museums/list-of-museums.html#comstock</a>
<b>Comstock Firemen's Museum</b>	125 South C Street Virginia City, NV 89440 775-847-071	<a href="http://www.comstockfiremuseum.com">www.comstockfiremuseum.com</a>
<b>Fourth Ward School Museum</b>	537 South C Street P.O. Box 4 Virginia City, NV 89440 775-847-0975	<a href="mailto:director@fourthwardschool.org">director@fourthwardschool.org</a> <a href="http://www.fourthwardschool.org">www.fourthwardschool.org</a>
<b>Julia Bulette Red Light Museum</b>	5 North C Street Virginia City, NV 89440 775-847-9288	
<b>Mark Twain Museum at the Territorial Enterprise</b>	53 South C Street Virginia City, NV 89440	

Contact Name	Address/Phone	Website/E-mail
	775-847-0525	
<b>Nevada Gambling Museum</b>	50 South C Street Virginia City, NV 89440 775-847-9022	
<b>Silver State National Peace Officers Museum</b>	Virginia City, NV 89440 26 South B Street Reno, NV 89511	<a href="mailto:info@peaceofficersmuseum.org">info@peaceofficersmuseum.org</a> <a href="http://www.peaceofficersmuseum.org">www.peaceofficersmuseum.org</a>
<b>The Way it Was Museum</b>	113 North C Street Virginia City, NV 89440 775-847-0766	
<b>Western Historic Radio Museum</b>	109 South F Street Virginia City, NV 89440 775-847-9047	<a href="http://www.radioblvd.com">www.radioblvd.com</a>
<b>Washoe County Pyramid Lake Paiute Tribe Museum &amp; Visitors Center</b>	709 State Street Nixon, NV 89424 775-574-1088	<a href="mailto:museum@plpt.nsn.us">museum@plpt.nsn.us</a>
<b>Sparks Heritage Museum &amp; Cultural Center</b>	814 Victorian Ave Sparks, NV 89431 775-355-1144	<a href="mailto:info@sparksmuseum.org">info@sparksmuseum.org</a> <a href="http://www.sparksmuseum.org">www.sparksmuseum.org</a>
<b>Thunderbird Lodge Preservation Society</b>	P.O. Box 6812 Incline Village, NV 89450 775-832-8750	<a href="http://www.thunderbirdtahoe.org">www.thunderbirdtahoe.org</a>
<b>W. M. Keck Earth Science and Mineral Engineering Museum</b>	University of Nevada, Reno Mackay School of Mines 1664 North Virginia Street Reno, NV 89557 775-784-4528	<a href="http://www.mines.unr.edu/museum">www.mines.unr.edu/museum</a>
<b>White Pine County Nevada Northern Railway Museum</b>	P.O. Box 150040 East Ely, NV 89315 1-866-40STEAM	<a href="mailto:info@nnry.com">info@nnry.com</a> <a href="http://www.nevadanorthernrailway.net">www.nevadanorthernrailway.net</a>
<b>White Pine Museum</b>	2000 Aultman Street Ely, NV 89301 775-289-4710	<a href="mailto:wpmuseum@sbcglobal.net">wpmuseum@sbcglobal.net</a> <a href="http://www.wpmuseum.org">www.wpmuseum.org</a>
<b>White River Valley Museum (Mormon Settlement Museum)</b>	Main Street Lund, NV 89317 775-289-8877	
<b>Historical Societies and Organizations -- Statewide</b>		
<b>Board of Museums and History</b>	708 North Curry Street Carson City, NV 89703 775-687-4340	<a href="http://www.museums.nevadaculture.org/index.php?option=com_content&amp;view=article&amp;id=1273&amp;Itemid=379">www.museums.nevadaculture.org/index.php?option=com_content&amp;view=article&amp;id=1273&amp;Itemid=379</a>
<b>Lincoln Highway Association</b>	136 N. Elm Street P.O. Box 308 Franklin Grove, IL 61031 815-456-3030	<a href="mailto:nv.director@lincolnhighwayassoc.org">nv.director@lincolnhighwayassoc.org</a> <a href="http://www.lincolnhighwayassoc.org">www.lincolnhighwayassoc.org</a>
<b>Nevada State Landscape Architecture Board</b>	P. O. Box 17039 Reno, NV 89511 775-530-4602	<a href="mailto:LandscapeBoard@nsbla.nv.gov">LandscapeBoard@nsbla.nv.gov</a>
<b>Nevada Historical Society</b>	1650 North Virginia St	<a href="mailto:mmaher@nevadaculture.org">mmaher@nevadaculture.org</a>

Contact Name	Address/Phone	Website/E-mail
	Reno, NV 89503 Research Library: 775.688.1190 x 227	
<b>Preserve Nevada</b>	4505 Maryland Parkway P.O. Box 455020 Las Vegas, NV 89154 702-895-2908	<a href="mailto:preservenevada@gmail.com">preservenevada@gmail.com</a> <a href="http://www.preservenevada.org">www.preservenevada.org</a>
<b>Local Organizations by County</b>		
<b>Clark County Henderson Historical Society</b>	121 South Water Street Henderson, NV 89015	<a href="http://www.hendersonhistoricalsociety.org/">www.hendersonhistoricalsociety.org/</a>
<b>Nevada State Museum &amp; Historical Society</b>	309 S Valley View Road Las Vegas, NV 89107 702-486-5205	<a href="http://www.museums.nevadaculture.org/index.php?option=com_content&amp;view=article&amp;id=427&amp;Itemid=438">www.museums.nevadaculture.org/index.php?option=com_content&amp;view=article&amp;id=427&amp;Itemid=438</a>
<b>Old Spanish Trail Association</b>	P.O. Box 909 Las Vegas, NM 87701 505-425-6039 Nevada Chapter: Las Vegas, NV 702-374-3812	<a href="http://www.oldspanishtrail.org/index.php">www.oldspanishtrail.org/index.php</a>
<b>E. Clampus Vitus, Queho Posse Chapter 1919</b>	P.O. Box 530115 Henderson, NV 89053	<a href="http://www.quehopause.org">www.quehopause.org</a>
<b>Classic Las Vegas</b>	As We Knew It, LLC 5424 Laurel Canyon Blvd # 228 Valley Village, CA 9160	<a href="http://www.classiclasvegas.com/home/home.htm">www.classiclasvegas.com/home/home.htm</a>
<b>The Morelli House</b>	Junior League of Las Vegas 702-822-6536 <a href="mailto:jrleagueoflv@aol.com">jrleagueoflv@aol.com</a>	<a href="http://morellihouse.org/preservation/index.html">http://morellihouse.org/preservation/index.html</a>
<b>Nevada Preservation Foundation</b> Las Vegas, NV		<a href="http://www.nevadapreservation.org">www.nevadapreservation.org</a>
<b>Carson City County Carson City Historical Society and Foundation for the Betterment of Carson City Parks and Recreation</b> (Maintains Robert-Foreman House and Wungenema House)	P.O. Box 1864 Carson City, NV 89702	<a href="http://www.cchistorical.org">www.cchistorical.org</a>
<b>Nevada State Prison Preservation Society</b>	P.O. Box 1991 Carson City, NV 89702 775-722-0394	<a href="http://www.nspps.org">www.nspps.org</a>
<b>Douglas County Douglas County Historical Society/ Carson Valley Museum and Cultural Center</b>	1477 Highway 395 N, Suite B Gardnerville, NV 89410 775-782-2555	<a href="mailto:dchs@historicnevada.org">dchs@historicnevada.org</a> <a href="http://www.historicnevada.org">www.historicnevada.org</a>
<b>Elko County</b>	P.O. Box 544 Elko, NV 89803	

Contact Name	Address/Phone	Website/E-mail
<b>E. Clampus Vitus, Lucinda J. Saunders Chapter 1881</b>		
<b><i>Esmeralda County</i> Goldfield Historical Society</b>	P.O. Box 393 Goldfield, NV 89013 775-485-3560	<a href="mailto:goldfieldhistorical@gmail.com">goldfieldhistorical@gmail.com</a> <a href="http://www.goldfieldhistoricalsociety.com/index.html">www.goldfieldhistoricalsociety.com/index.html</a>
<b><i>Lander County</i> Austin Historical Society (Gridley Store Museum)</b>	180 Main Street Austin, NV 775-964-1202	
<b><i>Lyon County</i> Historical Society of Dayton Valley</b>	485 Shady Lane P.O. Box 485 Shady Lane Dayton, NV 89403	<a href="http://www.daytonnvhistory.org/">www.daytonnvhistory.org/</a>
<b><i>Nye County</i> Beatty Museum &amp; Historical Society</b>	417 Main Street Beatty, Nevada 89003 775-553-2303	<a href="http://www.beattymuseum.org">www.beattymuseum.org</a>
<b>Pahrump Valley Museum &amp; Historical Society</b>	401 E Basin Ave Pahrump, NV 89060 775-751-1970	<a href="http://www.facebook.com/pahrumpvalleymuseum">www.facebook.com/pahrumpvalleymuseum</a>
<b><i>Storey County</i> Gold Hill Historical Society</b>	Gold Hill, NV (Restoration of the Gold Hill Depot)	<a href="http://www.goldhillnv.org">www.goldhillnv.org</a>
<b>E. Clampus Vitus, Julia Bullette Chapter 1864</b>		<a href="http://www.juliabullette.com">www.juliabullette.com</a>
<b><i>Washoe County</i> Historic Reno Preservation Society</b>	P.O. Box 14003 Reno, NV 89507 775-747-4478	<a href="http://www.historicreno.org">www.historicreno.org</a>
<b>Washoe County Courthouse Historical and Preservation Society</b>	P.O. Box 1066 Reno, NV 89505 775-328-3266	<a href="http://www.washoecounty.us/clerks/historical_society.php">www.washoecounty.us/clerks/historical_society.php</a>
<b>E. Clampus Vitus, Snowshoe Thompson Chapter 1827</b>	P.O. Box 2599 Sparks, NV 89432	
<b>Nevada Westerners Corral Jack Hursh, Sheriff</b>	2875 Idlewild Drive 100 Reno, Nevada 89509	<a href="http://www.nevadawesterners.org">www.nevadawesterners.org</a>
<b>Verdi History Preservation Society, Inc. &amp; Verdi History Center</b>	740 Second Street P.O. Box 663 Verdi, NV 89439 775-345-0173	verdihistory@sbcglobal.net <a href="http://www.verdihistory.org">www.verdihistory.org</a>
<b>Selected Libraries</b>		
<b>Nevada State Library and Archives</b>	100 North Stewart Street Carson City, Nevada 89701 775-684-3360	<a href="http://www.nsla.nevadaculture.org">www.nsla.nevadaculture.org</a>
<b>UNLV Special Collections</b>	Lied Library University of Nevada, Las Vegas Las Vegas, NV 89154 702-895-2100	<a href="http://www.library.unlv.edu/speccol">www.library.unlv.edu/speccol</a>
<b>UNR Special Collections</b>	Mathewson-IGT Knowledge	<a href="http://www.knowledgecenter.unr.edu/materials/specoll/d">www.knowledgecenter.unr.edu/materials/specoll/d</a>

Contact Name	Address/Phone	Website/E-mail
	Center University of Nevada, Reno 1664 N Virginia Street Reno, NV 89557 775-682-5660	<a href="#">efault.aspx</a>
<b>On-Line Resources</b>		
<b>General Land Office Records</b>	<i>Search for historic GLO maps and land patents by name or Township, Range and Section.</i>	<a href="http://www.glorerecords.blm.gov/default.aspx">http://www.glorerecords.blm.gov/default.aspx</a>
<b>Historic Aerial Photographs</b>	<i>Searchable aerial photographs and topo maps.</i>	<a href="http://www.historicaerials.com">www.historicaerials.com</a>
<b>National Park Service Database</b>	<i>List of Properties on the National Register of Historic Places.</i>	<a href="http://www.nps.gov/nr/research">www.nps.gov/nr/research</a>
<b>Nevada State Historic Preservation Office Website</b>		<a href="http://www.shpo.nv.gov">www.shpo.nv.gov</a>
<b>Nevada History in Maps</b>	<i>Sanborn Insurance maps, Government Land Office maps, and other historic maps.</i>	<a href="http://www.delamare.unr.edu/maps/digitalcollections/nvhistory">www.delamare.unr.edu/maps/digitalcollections/nvhistory</a>
<b>United States Geological Survey Website</b>	<i>Find and download topographic maps.</i>	<a href="http://www.usgs.gov">www.usgs.gov</a>
<b>Western Nevada Historic Photo Collection</b>		<a href="http://www.wnhpc.com">www.wnhpc.com</a>
<b>Preservation Association of Clark County</b>		<a href="http://www.pacc.info">www.pacc.info</a>
<b>City of Las Vegas' Historic Preservation</b>		<a href="http://www.lasvegasnevada.gov/hp">www.lasvegasnevada.gov/hp</a>
<b>Nevadans for Cultural Preservation</b>	<u>PO Box 19082, Las Vegas NV 89132</u>	<a href="http://www.nvfc.org">www.nvfc.org</a>
<b>County Assessor's Offices</b>		
<b>Carson City County Assessor</b>	201 North Carson Street, Suite 6 Carson City, NV 89701 775-887-2130	<a href="http://www.carson.org">www.carson.org</a>
<b>Churchill County Assessor</b>	155 North Taylor, #200 Fallon, NV 89406 775-423-6584	<a href="mailto:assessor-njg@churchillcounty.org">assessor-njg@churchillcounty.org</a> <a href="http://www.churchillcounty.org/index.aspx?nid=88">www.churchillcounty.org/index.aspx?nid=88</a>
<b>Clark County Assessor</b>	500 South Grand Central Parkway, 2nd Floor Las Vegas, NV 89155 702-455-3891	<a href="http://www.clarkcountynv.gov/assessor">www.clarkcountynv.gov/assessor</a>
<b>Douglas County Assessor</b>	P. O. Box 218 Minden, NV 89423 775-782-9834	<a href="http://www.assessor.co.douglas.nv.us">www.assessor.co.douglas.nv.us</a>
<b>Elko County Assessor</b>	550 Court St. Elko, NV 89801 775-738-3088	<a href="http://www.elkocountynv.net/departments/assessor1/index.html">www.elkocountynv.net/departments/assessor1/index.html</a>

Contact Name	Address/Phone	Website/E-mail
<b>Esmeralda County Assessor</b>	P. O. Box 471 Goldfield, NV 89013 775-485-6380/6383	<a href="mailto:assessor3@frontiernet.net">assessor3@frontiernet.net</a> <a href="http://www.accessesmeralda.com/county_offices/assessor/index.php">www.accessesmeralda.com/county_offices/assessor/index.php</a>
<b>Eureka County Assessor</b>	P. O. Box 88 Eureka, NV 89316 775-237-5270	<a href="http://www.co.eureka.nv.us/assessor/assessor.htm">www.co.eureka.nv.us/assessor/assessor.htm</a>
<b>Humboldt County Assessor</b>	50 West 5th Street Winnemucca, NV 89445 775-623-6310	<a href="mailto:Assessor@hcnv.us">Assessor@hcnv.us</a> <a href="http://www.hcnv.us/assessor/assessor.htm">www.hcnv.us/assessor/assessor.htm</a>
<b>Lander County Assessor</b>	315 S. Humboldt St. Battle Mountain, NV 89820 775-635-2610	<a href="mailto:assessor@landercounty.org">assessor@landercounty.org</a> <a href="http://www.landercountynv.org/lander-county-elected-officials/assessors-office">www.landercountynv.org/lander-county-elected-officials/assessors-office</a>
<b>Lincoln County Assessor</b>	P.O. Box 420 Pioche, NV 89043 775-962-5890	<a href="mailto:lincolncoassr@yahoo.com">lincolncoassr@yahoo.com</a> <a href="http://www.lincolncountynv.org/assessor.htm">www.lincolncountynv.org/assessor.htm</a>
<b>Lyon County Assessor</b>	27 S. Main Street Yerington, NV 89447 775-463-6520	<a href="http://www.lyon-county.org/index.aspx?nid=55">www.lyon-county.org/index.aspx?nid=55</a>
<b>Mineral County Assessor</b>	P.O. Box 400 Hawthorne NV 89415 775-945-3684	<a href="mailto:djfassessor@mineralcountynv.org">djfassessor@mineralcountynv.org</a> <a href="http://www.mineralcountynv.us/index.php?option=com_content&amp;view=category&amp;layout=blog&amp;id=34&amp;Itemid=57">www.mineralcountynv.us/index.php?option=com_content&amp;view=category&amp;layout=blog&amp;id=34&amp;Itemid=57</a>
<b>Nye County Assessor</b>	P.O. Box 271 101 Radar Road Tonopah, NV 89049 775-482-8174	<a href="http://www.nyecounty.net/index.aspx?nid=267">www.nyecounty.net/index.aspx?nid=267</a>
<b>Nye County Assessor-Tonopah Office</b>	160 N. Floyd Dr. Pahrump, NV 89048 775-751-7060	
<b>Pershing County Assessor</b>	P. O. Box 89 Lovelock, NV 89419 775-273-2369	<a href="http://www.pershingcounty.net/county-officials/assessor.html">www.pershingcounty.net/county-officials/assessor.html</a>
<b>Storey County Assessor</b>	P. O. Box 494 Virginia City, NV 89440 775-847-0961	<a href="mailto:Kweeks@storeycounty.org">Kweeks@storeycounty.org</a> <a href="http://www.storeycounty.org/assessor/">www.storeycounty.org/assessor/</a>
<b>Washoe County Assessor</b>	P. O. Box 11130 Reno, NV 89520 775-328-2200	<a href="http://www.washoecounty.us/assessor">www.washoecounty.us/assessor</a>
<b>White Pine County Assessor</b>	955 Campton Street Ely, NV 89301 775-289-3016	<a href="mailto:WPCOAssessor@sbcglobal.net">WPCOAssessor@sbcglobal.net</a> <a href="http://www.whitepinecounty.net/index.aspx?NID=433">www.whitepinecounty.net/index.aspx?NID=433</a>

## NATIONAL REGISTER LISTED HISTORIC DISTRICTS BY COUNTY (AS OF JANUARY 2014)

### **Carson City County**

- West Side Historic District, Carson City

### **Clark County**

- Berkley Square Historic District, Las Vegas

- Boulder City Historic District, Boulder City
- Brownstone Canyon Archaeological District
- Historic School Buildings in the Evolution of the Fifth Supervision School District MPS
- John S. Park Historic District, Las Vegas
- Las Vegas High School Neighborhood Historic District, Las Vegas
- Railroad Cottage Historic District, Las Vegas
- Sheep Mountain range Archaeological District
- Old Spanish Trail-Mormon Road Historic District

***Douglas County***

- Genoa Historic District, Genoa

***Esmeralda County***

- Goldfield Historic District, Goldfield, [www.goldfieldhistoricdistrict.org](http://www.goldfieldhistoricdistrict.org)

***Eureka County***

- Eureka Historic District, Eureka

***Lander County***

- Austin Historic District, Austin

***Lincoln County***

- Panaca Summit Archaeological District
- White River Narrows Archaeological District

***Nye County***

- Berlin Historic District, Berlin

***Storey County***

- Comstock Historic District, Virginia City/Dayton/Goldhill/Silver City (National Landmark)

***White Pine County***

- Johnson Lake Mine Historic District, Great Basin National Park

***Washoe County***

- Cliff, Walter, Ranch District
- University of Nevada Reno Historic District, Reno