

2011-2012



Good
VIBRATIONS

MOTORSPORTS

*Specializing in
Blown Applications*



Performance Products

800-576-7661

Open 24/7: www.dragparts.com

Mission Statement

At Good Vibrations Motorsports we strive to provide high quality performance products at discount prices without sacrificing customer service.



Sales & Tech Crew

"We're here to serve you!"

Why Buy From Good Vibrations?

* Prices

Never pay Retail. All products are generously discounted.

* Quality

We sell premium quality products only.

* Technical Support

No Question is too tough.

Deal directly with enthusiasts that speak your language.

* Promptness

Most orders are shipped the same day. Calls are returned ASAP.

How to Contact Us

Orders... **800/576-7661**

Tech/BS **562/945-7669**

Fax..... **562/693-9553**

E-mail... **sales@DragParts.com**

Web..... **www.GoodVibrationsRacing.com**



Jim Maher



Jessica Lascano



Randy Walton



Maribel Menchaca



Kasey Smith



Eric Ortiz



James



Jessica

Mail: 8858 Painter Ave, Ste. E, Whittier, CA 90602



We Ship International !!

Blower Injectors



All blower injectors are complete with: Barrel Valve, Fuel Lines, Nozzles & Bodies, Check Valve, Distribution Block & Bypass Pills.

Injectors are set up per customer application FREE at NO additional charge.

Blown	E-1002 Bugcatcher	\$ 1098
Alky	E-1004 Birdcatcher	\$ 1279

Blown	E-1001 Bugcatcher	\$ 1199
Gas	E-1003 Birdcatcher	\$ 1349

Injector Hat - Partial

Includes:

Polished Hat, Shaft, Stops, Double Arms and Butterflies.



E-4005 Bug **\$ 529** E-4006 Bird **\$ 689**

3-Rib Nostalgia Bugcatcher



It's Back!



This injector is nearly identical to the original Bugcatcher of days gone by. Has the three ribs on the top rear. Ideal for that nostalgia look.

E-4005F Finned Bugcatcher **\$ 579**

Big & Ugly Injector

Your Choice: TALL or SHORT

This new tall aluminum injector hat is Enderle's replica of the carbon fiber hats. It has a highly luster polished finish and billet front. Available complete or partial w/ Shaft, Butterflies, Stops & Arms.

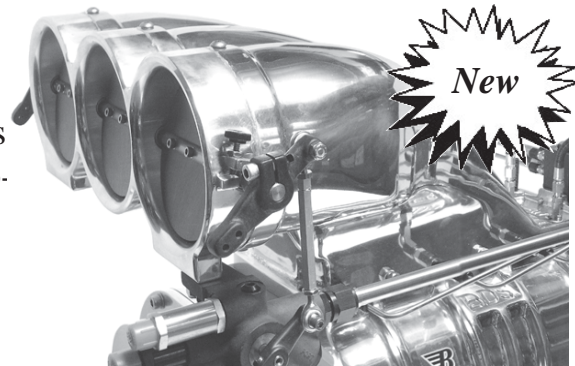

Weight ... 16lbs
Tall ... 10.7"
Short 8.3"

4 Butterfly Sizes: 3 9/16, 4 3/8, 5 and 5 9/16

E-BAU-1 5 9/16 Injector. Complete **\$ 1999**

E-BAU-1-SB 5 9/16 Injector. Partial **\$ 1339**

E-BAU-3 4 3/8 Injector. Complete **\$ 1799**

E-BAU-3-SB 4 3/8 Injector. Partial **\$ 1099**

Barrel Valve Leakdown

- * Block off all injector lines & returns except for hat nozzles
- * Connect dual gauge tester to outlet of compressor
- * Set Air Compressor to read 100psi on 1st gauge
- * Connect tester to inlet of barrel valve
- * Read % on 2nd gauge
- * Adjust Linkage Turnbuckle for desired % (Lengthen to Richen, Shorten to Lean)

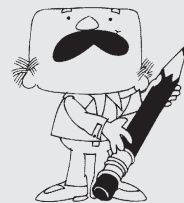

Leakdown Tester

Dual Gauge w/ 14mm Cylinder Hose Professional Grade

\$ 105
T-2002



T-2008 Injector Hose AN6 **\$19**

Why Enderle Mechanical Fuel Injection ??

- * *Consistent & Responsive*
- * *Dependable & Affordable*
- * *FREE Tech Support*
- * *Looks Cool !*

E-2100A Bugcatcher	\$ 1199
E-2101A Birdcatcher	\$ 1349
E-7075 Edelbrock BBC TR Base ...	\$ 399
E-7070 Edelbrock SBC TR Base ...	\$ 359
E-460BT Blue Thunder BBF Base ..	\$ 629
E-TRA7075 BBC Top Plate	\$ 148
E-SBTRA SBC Top Plate	\$ 148



*Injectors are set up per customer application
FREE at NO additional charge.*



Intake sold separately

*All Tunnel Ram Injectors are complete with:
Barrel Valve, Fuel Lines, Nozzles & Bodies, Main and
Secondary Check Valves, Dist Block & Bypass Pills.*

Convert Your 4 Barrel Manifold into Fuel Injection!

Single/Dual Butterfly Injector

Injectors complete with: Barrel Valve, Lines, Nozzles, Pills and Air Filter Bracket. Has standard Holley four barrel bolt pattern. **Gas or Alky.** (E-67260SB Progressive Linkage.. \$49)

Single Body

E-2020.39 4" Assy	\$ 989
E-2020.50 5" Assy	\$ 999

Dual Body

E-2030.39 4" Assy	\$1249
E-2030.50 5" Assy	\$1349

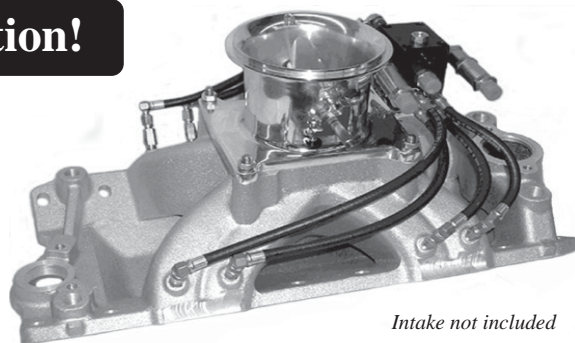

Intake not included



Premium Fuel Filters

System One filters are made from billet alum and feature a reusable 30 micron SS filter. Handles high pressure without volume loss.

Pro-Street 2 x 4" \$89

SYS-200-201406 AN6
SYS-200-201408 AN8
SYS-200-201410 AN10



Gas, Alky & Nitro



Race 2 x 6" \$113

SYS-201-203406 AN6
SYS-201-203408 AN8
SYS-201-203410 AN10
SYS-201-203412 AN12

Race - Long 2 x 9" \$135

SYS-202-202406 AN6
SYS-202-202408 AN8
SYS-202-202410 AN10
SYS-202-202412 AN12

JAZ inline billet aluminum filters are 5in long and feature a 35 micron element.

JAZ-836-001-11 3/8" Barb
JAZ-836-006-11 AN6
JAZ-836-008-11 AN8
JAZ-836-010-11 AN10

Gas Only



\$39



\$62

E-4056

Aluminum fuel filter designed to mount before the pump. Has two AN12 female ports and a reusable stainless steel screen.

AN12 Mounts
Inline



\$28

X-980012FS

SS Pump Loop Lines

Most \$23

Pre-bent stainless steel loop lines are designed to return fuel to inlet of pump.

- E-110HS6 110 High Speed
- E-110SO6 110 Shut Off
- E-110SOT6 110 Shut Off using a tee (shown)
- E-80AHS6 80A High Speed
- E-80ASO6 80A Shut Off
- E-80ASOT6 80A Shut Off using a tee
- E-Loop-AN6 AN6 K-style B/V (shown)

Complete Loop Kits: \$69 to \$79

Line Only
(Call for Kits)



Fuel Pump Exts



- * 3pc Billet Aluminum
- * 360 Degrees Adjustable
- * Internal Shaft & Bearing

Lengths: 2 - 6 inches (1/2" Inc.)

- Standard Ext From **\$120**
- Quick Release From **\$148**
- QR SS Clamp **\$45**

Pump Belt Drive

from **\$250**

Belt drive kits allow one to drive the fuel pump off the crankshaft. Required if your water pump blocks access to the cam.

- E-5011 SBC
- E-5010 BBC
- E-5012 SBF
- E-5014 BB Mopar
- E-5014A Blown
- E-5015 BBF



Pump Inlet Fitting with Returns

Return fuel lines to the inlet of pump. Available for most fuel pumps.



\$33

3-Way Fuel Shutoff Valve



Adjustable 360 Degrees
Includes Arm & Fittings

Mandatory on Enderle pumps

- E-85110 AN6 S/O Valve **\$84**
- E-85210 AN8 S/O Valve **\$109**
- E-110BR Cable Bracket Kit ... **\$32**
- E-85103 O-Ring/Seal Kit AN6 **\$12**
- E-85203 O-Ring/Seal Kit AN8 **\$12**

Flowed Fuel Pumps



All Pumps are Coated Inside

- E-3002 80A-0 (4 gpm) **\$469**
- E-3003 80A-1 (7.1 gpm) **\$469**
- E-3003.DSR 80A-1 (7.5) **\$539**
- E-3004A 600 (9.2 gpm) **\$529**
- E-3004 110 (13.2 gpm) **\$529**
- E-3005 990 (15.5 gpm) **\$629**
- E-3006 1100 (17.2 gpm) **\$649**
- E-3008 1270 (20.2 gpm) **\$719**
- Lil Bertha (20.0 gpm) **\$1489**
- E-2000C 3-Hole Collar **\$39**

Fuel Pump Drive for Jesel



Drive a fuel pump off a Jesel Belt Drive



Billet Alum Plate
Steel Hex Drive

Includes
Mounting Hardware

- I-2085 SB Chevy I-2088 BBC **\$169**

Barrel Valves



Enderle Barrel Valves can be used on Gas, Alky or Nitro.

Available for Blowers & Tunnel Rams.

- E-MVORM O-Ring Kit (Specify Style) **\$10**
- E-4018 Gas Metering Piston **\$69**
- E-4018-32 Tunnel Ram Metering Piston ... **\$69**
- E-4019 Alcohol Metering Piston **\$69**
- E-4020A Alky Metering Piston K-Style **\$83**
- E-4023 Square-Style Barrel Valve Assy **\$259**
- E-4024A K-Style Barrel Valve Assy **\$279**



Pills, Nozzle Jets, Holders



Enderle **Bypass Pills** are the Screw-In style and are designed to divert fuel away from the engine. The larger the pill, the leaner the mixture.



Sizes:
.020 to .209

E-7009 Bypass Pill **\$3.19**



Install pills without damaging. Stores 8 pills.
E-7009.SD Driver **\$35.95**



Alum storage holder is a convenient place to store up to 40 bypass pills.

E-7010 Pill Holder **\$19.99**



Hi-Speed kit .050-.095 **\$30.99**

Enderle **Nozzle Jets** are the "Screw-In" style

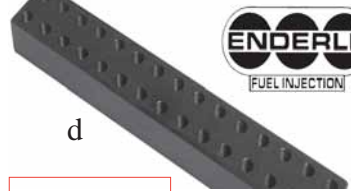

Anodized aluminum storage holder is a convenient and safe place to store up to 60 jets.



- Sizes:** .016 to .099
- a. E-7007 Brass Nozzle Jet **\$ 4.75**
 - a. E-7007A Flowed Nozzle Jet **\$ 6.99**
 - b. E-7121A Port Nozzle Body **\$ 9.99**
 - b. E-7130A Ball Check Port Body **\$ 16.99**
 - c. E-7110A Top Nozzle Body **\$ 9.99**
 - d. E-7011 Jet Storage Holder **\$ 21.99**



Hydrometer Kits

Hydrometer kits come complete with hydrometer, glass beaker and protective wooden carrying case.

Available: Gas, Alcohol and Nitro.

Nitro Sizes: 0-50% & 50-100%

- E-7012 Hydrometer Kit Gas/Alky .. **\$ 159**
- E-7013 Hydrometer Kit Nitro **\$ 165**
- E-7014 Hydrometer only **\$ 56**
- E-7015 Beaker only **\$ 38**

Injector Hat Spacer



Polished Spacers are 2 or 3" tall with a C-C of 13.25". Includes Studs and Nuts.



Billet Adapter allows one to bolt a smaller hat (13.25" bolt pattern) to a large blower (15.25").

- E-BS2 2in Injector Spacer **\$ 89**
- E-BS3 3in Injector Spacer **\$ 94**
- B-9055 Billet Hat Adapter **\$169**

Injector Hat Filter Assembly

Keeps rocks and debris out of your engine & blower.

A Must for the Sand!

Kit includes:

- Outerware
- Stainless Steel Rods
- Billet aluminum housing
- SS Quick Disconnect Pins
- Reusable Filter element



- Bugcatcher 10"..... **\$ 395**
- Bugcatcher 5"..... **\$ 395**
- Birdcatcher 10" ... **\$ 395**
- Birdcatcher 5"..... **\$ 395**
- Buzzardcatcher 10" **\$ 449**
- Big & Ugly 10" **\$ 498**

Also Available:
Replacement Filters, SS Quick Pins & Rod Kits



Outerware: (Red, Blue, Black, Purple) **\$25**

Port Line Kit

\$ 369



Complete w/ Nozzles and Bodies, SS Lines, Dist Block, AN8 Check Valve.

Available with Rubber Hoses .. \$ 339

Quality Fuel Injection Components



- E-4013 Bugcatcher butterfly (black, red, blue, plain) \$ 12
- E-4014 Birdcatcher butterfly (black, red, blue, plain) ... \$ 18
- E-4103 Buzzard butterfly (black, red, blue, plain) \$ 21
- E-4103CF Big & Ugly butterfly (black, red, plain) \$ 23
- E-4011 Small serrated arm \$ 8
- E-4011A-5/16 Double serrated arm Bug \$ 16
- E-4011A Double serrated arm Bird/Buzz \$ 16
- E-4011B Long double serrated arm Bird/Buzz \$ 17
- E-4012-5/16 Throttle stop Bug \$ 10
- E-4012 Throttle stop Bird/Buzz \$ 10
- E-4012TS Throttle stop thumb screw \$ 2
- E-4026 Barrel Valve Linkage Turnbuckle Assy \$ 17



- E-5001 SBC Alum Front Cover \$ 107
- E-5002 SBC Front Cover Seal \$ 14
- E-5003 SBF Alum Front Cover \$ 107
- E-5004 BBC Alum Front Cover \$ 107
- E-5008 Hex Drive Assy Chevy \$ 46
- E-4009 Bugcatcher shaft \$ 79
- E-4010 Birdcatcher shaft \$ 99
- E-4102 Buzzardcatcher shaft \$ 112
- B-5019 Hat Injector Stud & Nut Kit 4pc \$ 11
- E-4031 Stainless Steel Hat Line Set \$ 110

Hi-Speed Assembly

Bleeds off fuel at higher rpm. Frees up top-end horsepower. Installs between pump and distribution block.



E-7019 HS Unblown E-7018 HS Blown

Distribution Blocks

Distribution Blocks feature a black billet alum housing and includes fittings. Also machined for use with a primer check valve.



- E-4027 Hat Dist Block w/ 8 fittings \$ 65
- E-4027A Hat Dist Block w/ 12 fittings \$ 77
- E-4027VW Port Dist Block w/ 4 fittings \$ 34
- E-4028 Port Dist Block w/ 8 fittings \$ 58

Fuel Y-Blocks

Machined from alum & hard anodized. Has Single Inlet and Dual Outlets. Gas, Alky or Nitro.



AN Sizes: 8-6 10-8 12-8 12-10 12-12

Fuel Log

Routes three AN6 returns into one outlet. Mounts to the side of Shutoff Valve. Accepts "Screw-In" style bypass pills.



GS-FuelLog .. \$99

Check Valves

Brass check valves feature a one-way, spring-loaded poppet design. PSI is varied by springs and shims.

- AN6 Check Valves \$ 38
- AN8 Check Valves \$ 55
- Primer Check Valve AN4 \$ 21
- AN6 Spring & Shim Kit \$ 19

On-Board Primer System

Prime mechanical fuel injection from inside the driver's cockpit. Includes 1/2 qt Stainless-Steel tank.

\$99

Kit Includes

- SS Fuel Cell 1/2 qt
- Primer Check Valve
- 5' Braided SS Hose
- Hose Fittings

* Electric Pump Required





Injected? Get Connected!



B-5113
\$ 98

Throttle Cable Bracket

6061 Billet aluminum swingover hookclamp. Provision for springs. Fits most blower & tunnel ram injectors. TF/TA Approved.

Throttle Stop

Quick Release in < 1 Second
Billet Aluminum w/ SS Pin
Top Fuel/ TA Legal

B-5120 **\$ 59**

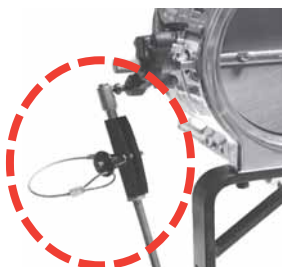

Return Springs



Special bend prevents spring from detaching from injector. Includes Grade 8 10-24 bolt & locking nut.

B-5115 Primary (Strong)

B-5116 Secondary (Medium)

\$6.99

Injector Hat Linkage Kit

\$ 89



Designed to work with mechanical fuel injection (Bug or Birdcatcher) on blown applications only. Adjustable heim end design and needle bearings for smooth throttle operation.

E-76-GVIHL

Blower Mounted Throttle Cable Bracket

Works with Bug or Bird. Anodized aluminum. Mounts to front of blower. Swingover hook clamp. Provision for springs. SAE-239-B

\$ 35



Carb Linkage Kits

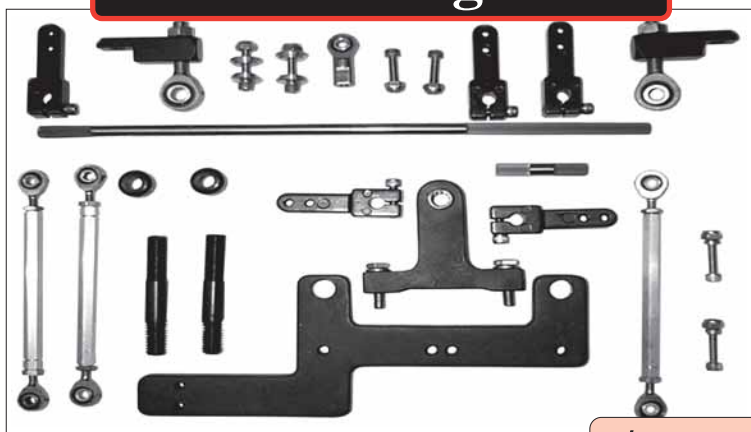

Blower Linkage Kits

\$ 119

For dual Holley double pumpers, Dominators & Predators mounted **Side-Saddle**. Includes adjustable heim end design and needle bearings for smooth throttle operation. E-76-107

For Holley vacuum secondary, Dominators, Predators & Carters mounted **Inline** on a 8 9/16 center-to-center distance. Includes adjustable heim end design and needle bearings for smooth throttle operation. E-55-501

Tunnel Ram Linkage Kits

Everything needed for mounting **Dual Carbs** on a Tunnel Ram **Side-Saddle**

\$ 119



E-72-2000 SBC

E-71-1000 BBC

E-75-107 Ford 351C

E-75-220 Ford 460

Progressive .. \$ 58

Dual Carbs Inline on a TR

E-67-260FSB **SB Chevy**

E-67-260FBB **BB Chevy**

Fabricated Valve Covers

Valve covers are fabricated from 6061 alum and welded with billet rails. Designed for the racers who demand a higher quality valve cover with extra room for valve train.

Includes all hardware



- RPC-S6144** SB Chevy **\$ 139**
- RPC-S6244** BB Chevy **\$ 179**
- RPC-S6344** SB Ford **\$ 149**
- RPC-S6247** BB Mopar 440 **\$ 179**

426 Hemi

Show Polished Aluminum.
Use Stock Tubes.
Original Design.
Machined for Breathers.

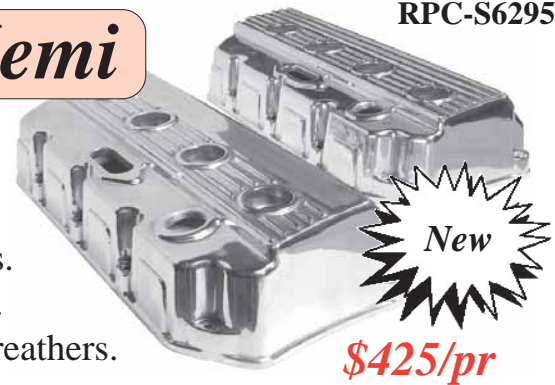

Premium Gaskets

Steel Core * Teflon Coated
Popular with Top Alky & Top Fuel Teams



- SCE-266075** Hemi **\$35**
- w/o Steel Core **\$22**



Pontiac



Aluminum Valve Covers

- * Tall for Clearance
- * Quality Casting
- * Recessed & Baffled
- * Hole for Breather

- RPC-S6152** SB Chevy 283-350 **\$ 79**
- RPC-S6230-1** BB Chevy 396-502 **\$109**
- RPC-S6172** 289-351W 5.0L Ford **\$ 85**
- RPC-S6133** 326-455 Pontiac **\$ 89**
- RPC-S1006** Wing Nut 1/4 -20 x 4in **\$ 3**

Dress Up Kits

Consist of chrome steel valve covers (baffled), breather cap and rubber grommets. Several kits contain chrome timing chain cover, dipstick with tube, wing nuts and timing tab.

- RPC-S3023** SBC Kit - Short **\$ 44.95**
- RPC-S3024** SBC Kit - Tall **\$ 44.95**
- RPC-S3025** Ford 289-351W **\$ 49.95**
- RPC-S3026** BBC Kit - Tall **\$ 54.95**
- RPC-S3027** BBC Kit - Short **\$ 54.95**
- RPC-S3029** SB Mopar Kit **\$ 49.95**
- RPC-S3030** Pontiac Kit **\$ 49.95**



Valve Cover Gaskets

High performance black rubber with solid steel core.



- S7484** SBC **\$ 12.95**
- S7485** BBC **\$ 14.95**
- S7486** SBF **\$ 12.95**
- S7493** BBF **\$ 14.95**
- S7494** Mopar .. **\$ 14.95**
- S7490** Olds **\$ 14.95**
- S7482X** Pont .. **\$ 14.95**

More Quality Gaskets?
See Pg 38

Billet Case Blowers!

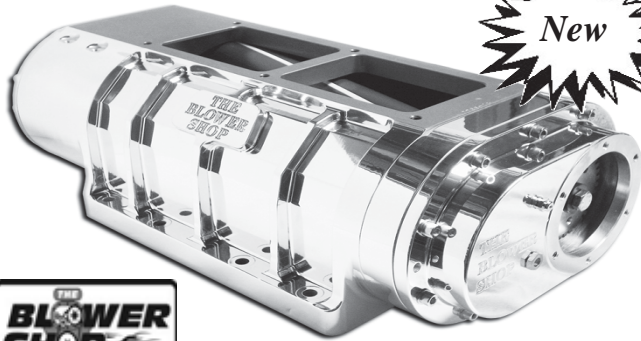

New

The Blower Shop superchargers are some of the finest on the market. Their BILLET case is superior to cast casings and has a show polished finish.

Proven successful in professional motorsports including: Drags, Marine and Tractor Pulling.

HA = Anodized Rotors/ Case
Race = HA & 18 strips of teflon and case drilled for rear nozzles..



Billet Case/ Cast Rotors

6.71 HA	\$ 2795
6.71 Race	\$ 2995
8.71 HA	\$ 2795
8.71 Race	\$ 2995

Billet Case/ Billet Rotors

6.71 Race	\$ 3895
8.71 Race	\$ 3995
10.71 Race	\$ 3995
14.71 Race	\$ 4195

Show Quality Blowers

Polished 6.71 -14.71



BDS blowers are hand assembled with competition components.

Special features include: Double lipped teflon seals, heavy-duty bearings, double pinned rotors, sight gauge and Billet bearing plates.
Options: Hard anodizing, teflon strips and front discharge cases.

Many blower companies use reconditioned GM diesel rotors in their blowers. **Air-Loc** are BDS brand NEW cast rotors. Makes more boost at cooler temperature. **Bottom line:** More Horsepower.

BDS **Pro-Loc** are **Billet** rotors; available in standard or hi-helix.

Air-Loc Cast Rotors

6.71 Street-GM	\$ 1595
6.71 Street	\$ 2595
6.71 Race	\$ 3395
8.71 Street	\$ 2595
8.71 Race	\$ 3395

Pro-Loc Billet Rotors

8.71 Pro-Loc	\$ 4345
14.71 Pro-Loc	\$ 4479
14.71 Hi-Helix	\$ 4950

Race style has 18 strips of teflon. Rotors and inside of case are hard anodized.

BDS Blower Kits are some of the finest on the market. Show-Quality & Precision Machined.

Kits Include: Air-Loc Blower, 1 Vee Drive Kit, Dual Carb Adap, Bolts, Gaskets & Warranty!

Kits are Custom Assembled per your Application

SB Chevy 6.71 Kit	\$ 2990
BB Chevy 8.71 Kit	\$ 3690
426 Hemi 8.71 Kit	\$ 3990
460 Ford 8.71 Kit	\$ 4190

Call for Others

Popular Kit Options:

Polish Blower	\$205	Upgrade to 8mm	\$65
Polish Manifold	\$110	Upgrade Stage II Blower	\$239

Street/Strip Blower Kits

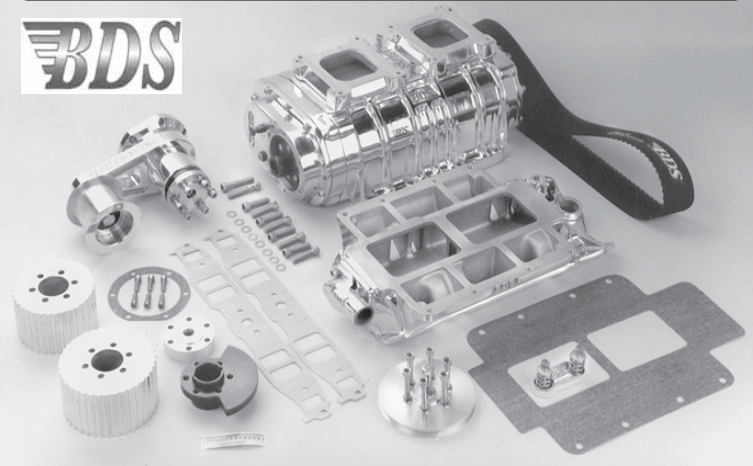



8mm



Drive Ratio Chart

B
O
T
T
O
M
P
U
L
L
E
Y

TOP PULLEY

	43	44	45	46	47	48	49	50	51	52	53	54	55	56
47	9.3	6.8	4.4	2.2	1.0	-2.1	-4.1	-6.0	-7.2	-9.6	-11.3	-13.0	-14.5	-16.1
48	11.6	9.1	6.7	4.3	2.1	1.0	2.0	-4.0	-5.9	-7.7	-9.4	-11.1	-12.7	-14.3
49	14.0	11.4	8.9	6.5	4.3	2.1	1.0	-2.0	-3.9	-5.8	-7.5	-9.3	-10.9	-12.5
50	16.3	13.6	11.1	8.7	6.4	4.2	2.0	1.0	-2.0	-3.8	-5.7	-7.4	-9.4	-10.7
51	18.6	15.9	13.3	10.9	8.5	6.3	4.1	2.0	1.0	-1.9	-3.8	-5.6	-7.3	-8.9
52	20.9	18.2	15.6	13.0	10.6	8.3	6.1	4.0	2.0	1.0	-1.9	-3.7	-5.5	-7.1
53	23.2	20.5	17.8	15.2	12.8	10.4	8.2	6.0	3.9	1.9	1.0	-1.9	-3.6	-5.4
54	25.5	22.7	20.0	17.4	14.9	12.5	10.2	8.0	5.9	3.8	1.9	1.0	-1.8	-3.6
55	27.9	25.0	22.2	19.6	17.0	14.6	12.2	10.0	7.8	5.8	3.8	1.9	1.0	-1.8
56	30.2	27.3	24.4	21.7	19.1	16.7	14.3	12.0	9.8	7.7	5.7	3.7	1.8	1.0
57	32.5	29.5	26.7	23.9	21.3	18.8	16.3	14.0	11.8	9.6	7.5	5.6	3.6	1.8
58	34.8	31.9	28.9	26.1	23.4	20.8	18.4	16.0	13.7	11.5	9.4	7.4	5.5	3.6
59	37.2	34.1	31.3	28.3	25.5	22.9	20.4	18.0	15.7	13.5	11.3	9.3	7.3	5.4
60	39.5	36.4	33.3	30.4	27.7	25.0	22.4	20.0	17.6	15.4	13.2	11.1	9.1	7.1
61	41.8	38.6	35.6	32.6	29.8	27.1	24.5	22.0	19.6	17.3	15.1	13.0	10.9	8.9
62	44.2	40.9	37.8	34.8	31.9	29.2	26.5	24.0	21.6	19.2	17.0	14.8	12.7	10.7
63	46.5	43.2	40.0	37.0	34.0	31.1	28.6	26.0	23.5	21.2	18.9	16.7	14.5	12.5
64	48.8	45.5	42.2	39.1	36.2	33.3	30.6	28.0	25.5	23.1	20.8	18.5	16.4	14.3
65	51.2	47.7	44.4	41.3	38.3	35.4	32.7	30.0	27.5	25.0	22.6	20.4	18.2	16.1
66	53.5	50.0	46.7	43.5	40.4	37.5	34.7	32.0	29.4	26.9	24.5	22.2	20.0	17.9
67	55.8	52.3	48.9	45.6	42.6	39.6	36.7	34.0	31.4	28.8	26.4	24.1	21.8	19.6
68	58.1	54.5	51.1	47.8	44.7	41.7	38.8	36.0	33.3	30.8	28.3	25.9	23.6	21.4
69	60.5	56.8	53.3	50.0	46.8	43.8	40.8	38.0	35.3	32.7	30.2	27.8	25.5	23.2
70	62.8	59.1	55.6	52.2	48.9	45.8	42.9	40.0	37.3	34.6	32.1	29.6	27.3	25.0

13.9mm/14mm 1/2" Pitch 30-41T

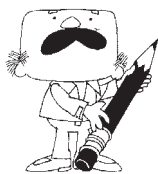

B
O
T
T
O
M
P
U
L
L
E
Y

TOP PULLEY

	25	26	27	28	29	30	31	32	33	34	35	36	37
25	1.0	-3.8	-7.4	-10.7	-13.8	-16.7	-19.4	-21.9	-24.2	-26.5	-28.6	-30.6	-32.4
26	4.0	1.0	-3.7	-7.1	-10.3	-13.3	-16.1	-18.7	-21.2	-23.5	-25.7	-27.8	-29.7
27	8.0	3.8	1.0	-3.6	-6.9	-10.0	-12.9	-15.6	-18.2	-20.6	-22.9	-25.0	-27.0
28	12.0	7.7	3.7	1.0	-3.4	-6.7	-9.7	-12.5	-15.2	-17.6	-20.0	-22.2	-24.3
29	16.0	11.5	7.4	3.6	1.0	-3.3	-6.5	-9.4	-12.1	-14.7	-17.1	-19.4	-21.6
30	20.0	15.4	11.1	7.1	3.4	1.0	-3.2	-6.2	-9.1	-11.8	-14.3	-16.7	-18.9
31	24.0	19.2	14.8	10.7	6.9	3.3	1.0	-3.1	-6.1	-8.8	-11.4	-13.9	-16.2
32	28.0	23.1	18.5	14.3	10.3	6.7	3.2	1.0	-3.0	-5.9	-8.6	-11.1	-13.5
33	32.0	26.9	22.2	17.9	13.8	10.0	6.5	3.1	1.0	-2.9	-5.7	-8.3	-10.8
34	36.0	30.8	25.9	21.4	17.2	13.3	9.7	6.3	3.0	1.0	-2.9	-5.6	-8.1
35	40.0	34.6	29.6	25.0	20.7	16.7	12.9	9.4	6.7	2.9	1.0	-2.8	-5.4
36	44.0	38.5	33.3	28.6	24.1	20.0	16.1	12.5	9.1	5.9	2.9	1.0	-2.7
37	48.0	42.3	37.0	32.1	27.6	23.3	19.4	15.6	12.1	8.8	5.7	2.8	1.0
38	52.0	46.2	40.7	35.7	31.0	26.7	22.6	18.8	15.2	11.8	8.6	5.6	2.7
39	56.0	50.0	44.4	39.3	34.5	30.0	25.8	21.9	18.2	14.7	11.4	8.3	5.4
40	60.0	53.8	48.1	42.9	37.9	33.3	29.0	25.0	21.2	17.6	14.3	11.1	8.1
41	64.0	57.7	51.9	46.4	41.4	36.7	32.3	28.1	24.2	20.6	17.1	13.9	10.8
42	68.0	61.5	55.6	50.0	44.8	40.0	35.5	31.3	27.3	23.5	20.0	16.7	13.5
43	72.0	65.4	59.3	53.6	48.3	43.3	38.7	34.4	30.3	26.5	22.9	19.4	16.2
44	76.0	69.2	63.0	57.1	51.7	46.7	41.9	37.5	33.3	29.4	25.7	22.2	18.9
45	80.0	73.1	66.7	60.7	55.2	50.0	45.2	40.6	36.4	32.4	28.6	25.0	21.6

Blower Belts



Race > 35% OD

8mmGT, 13.9 & 14mm

Street/ Race < 35% OD

8mm, 1/2" Pitch

Available in
Rubber or
PolyChain/
Carbon (GT)

Belts listed are
3" Wide.

1/2 Pitch



540H300	\$ 69
555H300	\$ 69
560H300	\$ 69
570H300	\$ 69
585H300	\$ 69
600H300	\$ 79
630H300	\$ 89
660H300	\$ 89
700H300	\$ 99

8mm



1280M75	\$ 109
1360M75	\$ 109
1440M75	\$ 109
1440M75gtc	\$ 169
1512M75gt2	\$ 139
1520M75	\$ 129
1600M75	\$ 129
1600M75gtc	\$ 179
1792M75gtc	\$ 239

13.9 & 14mm



13.9mm	
1543M75	\$ 189
14mm	
1400M75....	\$ 299
1568M75gtc	\$ 299
1610M75	\$ 299
1610M75gtc	\$ 299
1694M75	\$ 329
1750M75gtc	\$ 329

Good Vibrations offers one of the largest selection of blower pulleys.

Billet Alum Blower Pulleys

3.5" Wide
2.0" Register



1/2 Pitch

OD < 15%
Sizes: 30-41
From **\$ 79**



8mm

Ratios < 35%
Sizes: 43-70
From **\$ 83**



8mmGT

Ratios > 35%
Sizes: 43-75
From **\$ 96**



13.9mm

Ratios > 35%
Sizes: 25-45
From **\$ 89**



14mm & GT

Ratios > 35%
Sizes: 25-46
From **\$ 89**

Pulleys are 3.5" wide with a 2" register. Machined from billet 6061 alum and T-6 heat treated.

Hard anodizing is standard on the 8mmGT, 13.9 and 14mm pulleys.

V-Groove Pulleys

V-Groove Pulleys are machined from billet 6061-T6 alum. Has a 2" register and bolt directly to crank hub with 6 bolts. Can be stacked together for PS, AC, Etc...

Adapter-style pulleys bolt directly to harmonic balancers and are available in single or double V-Grooves. **Billet aluminum spacers** allow one to easily align both top and lower blower pulleys.



B-2205 Single V-Groove Pulley	\$ 65
B-2211 Single V-Groove Adap SBC	\$ 85
B-2212 Dual V-Groove Adap SBC	\$109
B-2221 Single V-Groove Adap BBC	\$ 85
B-2222 Dual V-Groove Adap BBC	\$109

Pulley Spacers



.300 - 1.40" widths
from **\$ 19**

Accessory Pulleys



Billet Aluminum
Uppers are Polished

Fits **Short** Water Pumps

RPC-S8840POL Water Pump BBC	\$ 39.95
RPC-S8841 Lower Pulley BBC	\$ 29.95
RPC-S9478POL Water Pump SBC	\$ 39.95
RPC-S9480 Lower Pulley SBC	\$ 29.95
RPC-S9487POL Alternator Chevy	\$ 29.95

Blower Manifolds

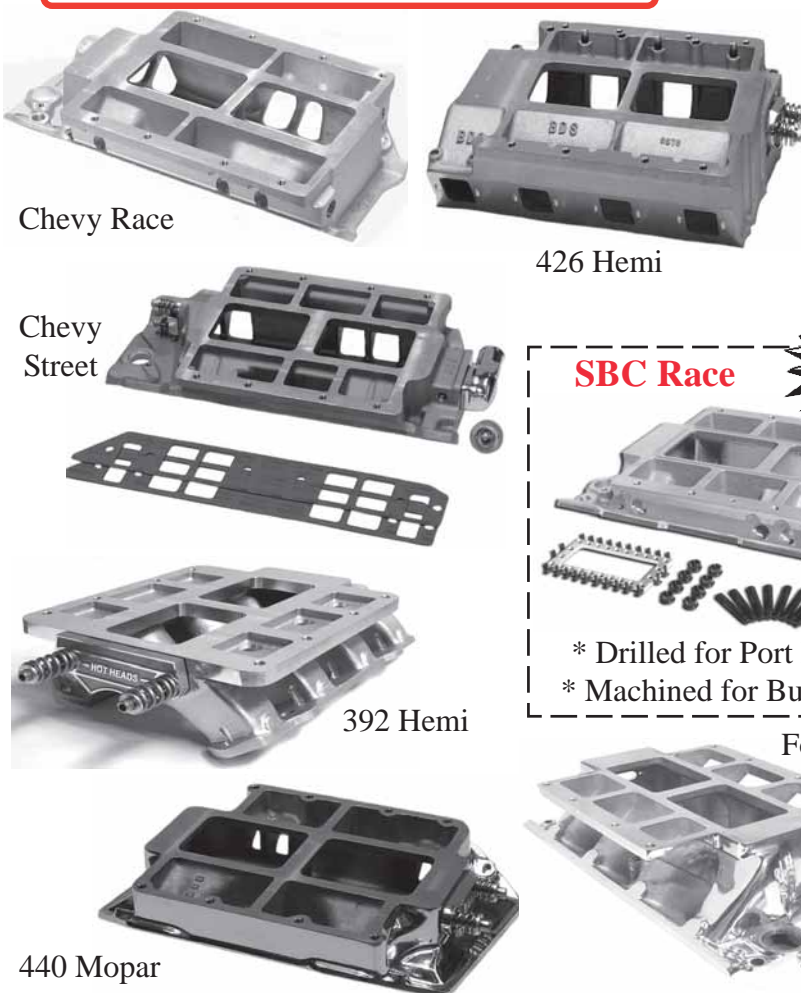

Standard Features Include:

- Raised tented floor for improved airflow.
- Solid sides for added strength and rigidity.
- Competition models have port nozzle provisions.
- Most will accept 6.71 through 14.71 blowers.
- Street includes thermostat housing and backfire valve.

BDS Most Manifolds are in Stock! 

SBC Race *New*

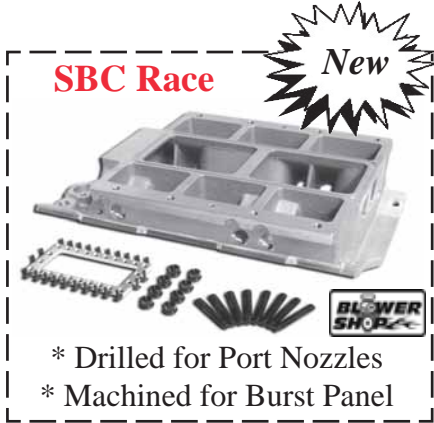

* Drilled for Port Nozzles
* Machined for Burst Panel

BDS-8006-1206 SB Chevy Street ...	\$ 495
B-7100 SB Chevy Race Mooneyham	\$ 448
TBS-2533 SB Chevy Street LG port	\$ 549
TBS-2536 SB Chevy Race LG port	\$ 779
BDS-8026S BB Chevy Street Std ...	\$ 548
BDS-8026T BB Chevy Street Tall ...	\$ 578
BDS-8027S BB Chevy Race Std	\$ 448
BDS-8027T BB Chevy Race Tall	\$ 498
BDS-8607 Pontiac 326-455	\$ 548
BDS-8386-H Mopar 392 Hemi	\$ 478
BDS-8376 Mopar 426 Hemi	\$ 528
BDS-8366 Mopar 440	\$ 448
BDS-8406 Ford 289-302	\$ 998
BDS-8456 Ford 429-460	\$ 698
BDS-8456BT 429-460 Blue Thunder	\$ 779

Show Polishing (Most \$110)

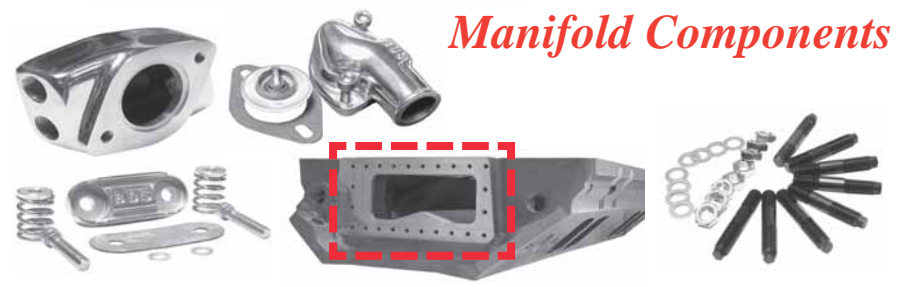

Manifold Components

BDS-1401 Thermostat Housing Kit.....	\$ 49
RPC-S6009 Swivel Thermostat Housing ...	\$ 29
BDS-1400-2 Billet Remote Housing	\$ 75
BDS-8366AK Large Backfire Valve Kit ..	\$ 49
B-5025.K Alum Blower Stud Kit 2.5"	\$ 35
B-5101 Machine for Burst Panel	\$175

Need Quality Gaskets? See Page 38

Burst Panel



Panels are **SFI** Approved. Very popular on Top Fuel & Alcohol Engines.

BP Adapter



Eliminates welding and machining on older intakes.

B-5100 Burst Panel, SFI Approved	\$ 25
B-5100-3 Burst Panel, <i>3 pack special!</i>	\$ 65
B-5102 2pc Alum Frame Kit w/ 24 bolts	\$ 65
B-5109 Burst Panel Alum Adapter	\$ 75
B-5110 Burst Panel Alum Adapter Weld-On	\$ 75

PSI Blower Tandem Kit

2pc Alum Frame Kit. Has side brass fitting for quick check of inner panel. Also includes 24 Stainless-Steel bolts and 2 sfi burst panels.

B-5106 ... \$195



Blower Components

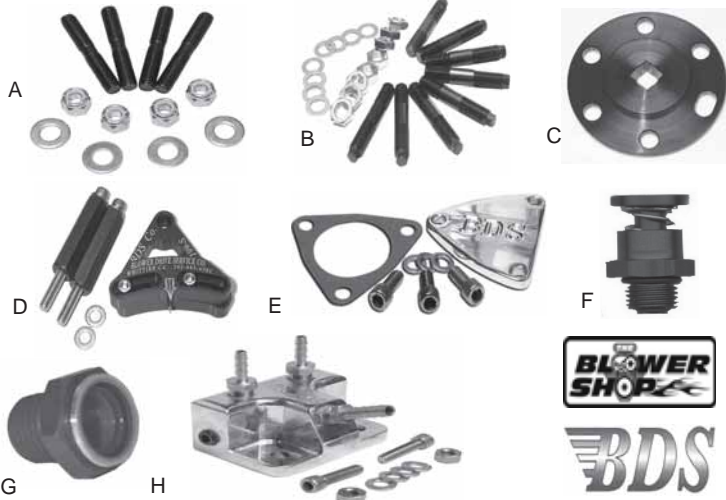

- A **B-5019** Injector Hat Stud Kit (4) \$ 11
- B **B-5025.K** Blower Stud Kit Alum 2.5" (8) \$ 35
Longer Blower Studs 3.00" & 3.50" (each) \$ 5
- C **B-5038** Alum Blower Turning Plate \$ 35
- D **BDS-198** Billet Alum Timing Pointer \$ 49
- E **BDS-333K** Billet Tri-Plate Kit \$ 19
- F **B-5135** Pressure Relief Valve 1/8 SS \$ 16
- F **B-5136** Pressure Relief Valve 7/16 Black \$ 17
- G **B-5138** Oil Level Sight Gauge Lexan 1/4 NPT. \$ 18
- G **BDS-556** Oil Level Sight Gauge Lexan 7/16-20 \$ 18
- H **BDS-1150** Trans Pressure Diversion Valve \$ 69

Street Snouts are Polished!

Blower Snouts

Drive Snouts are machined from billet aluminum. Has double ball bearings and HD oil seal. 48-Tooth spline shaft is made from heat-treated 4100 steel.



Shaft Size

- Street 1.125
- Race 1.250

Includes Grade 8 Bolts & Washers



- B-5300** Street Snout 3.90" \$ 298
- B-5310** Street Snout 5.75" \$ 338
- B-5302** Coupler for above \$ 86
- B-5340** Race Snout 3.90" \$ 289
- B-5342** Coupler for 3.90" \$ 74
- B-5350** Race Snout 5.25" \$ 299
- B-5352** Coupler for 5.25" \$ 79
- B-5360** Race Snout 6.00" \$ 339
- B-5362** Coupler for 6.00" \$ 84
- B-5370** Race Snout 7.00" \$ 359
- B-5372** Coupler for 7.00" \$ 89

Blower Front Covers



Complete Kit includes: Cover, Pressure Relief Valve, Sight Gauge, Gaskets, Bolts & Washers.

- BDS-671-1C** Cover Only -Satin \$ 115
- BDS-671-1CP** Cover Only -Polished \$ 139
- BDS-671-1C-2** Cover Only -BILLET \$ 189
- BDS-671-1CK** Cover Kit -Satin \$ 149
- BDS-671-1CKP** Cover Kit -Polished \$ 169

Specify: Half or Full Round

Bearing Plates and Covers are available in

Polished or Satin finish.

Works on most brands of blowers.

Blower Bearing Plates

FRONT

Front Plates includes:

Heat-Treated dowels & Bearing Retainers (pr).



Cast REAR Billet

Specify: All Square (Detroit style), Half Round or All Round

Rear Plates includes:

Heat-Treated dowels & Bearing Caps (pr).

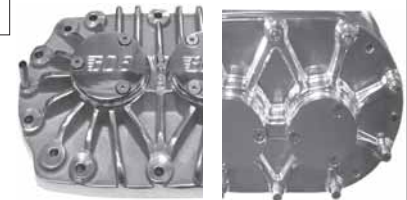

- BDS-671-2C** Front Plate -Satin \$ 109
- BDS-671-2CP** Front Plate -Polished \$ 119
- BDS-671-4** Rear Plate -Satin \$ 129
- BDS-671-4P** Rear Plate -Polished \$ 154
- BDS-671-5** Rear Bearings Caps Pr. \$ 25
- BDS-671-22** Bearing Retainer Pr. \$ 29
- G-3320** Bearing/Seal Kit Street 4ea \$ 89
- G-3322** Bearing/Seal Kit Comp 4ea \$ 119

Bearings & Seals also Sold Separate

See Page 38



Chromoly Crank Hubs

Hubs are designed to replace your harmonic balancer. Machined from 4100 steel and broached for 2 keyways.



Internal Balance

External Balance



Billet Pointer & Degree Ring



Bearing Support -Front

Bearing Support -Rear



Hub with optional Thick Degree Ring

Race Proven on Top Fuel and Alky!

Crank Bolts

7/16 - 1/2 - 3/4"



\$39

Chevy
Hemi
Ford

Heat-treated
Gun Drilled
Chrome-Moly Steel
Black Oxide Finish

12pt Pulley Bolts
3/8-24 x 1.00"



6 pk
\$ 11.95

Crank Hubs - Standard

- B-2040 SBC Int Bal 3/16-1/4 Keys **\$ 125**
- BDS-100C SBC Ext 3/16-1/4 Keys **\$ 179**
- B-2053 BBC Int Bal 3/16-1/4 Keys **\$ 125**
- B-2054 BBC Int Bal Dual 1/4 Keys **\$ 125**
- B-2055 BBC Ext Bal 3/16-1/4 Keys **\$ 229**
- B-2056 BBC Ext Bal Dual 1/4 Keys **\$ 229**
- B-2060 Hemi 426 PSI Spline **\$ 169**
- B-2064 Hemi 426 Dual 1/4 Keys ... **\$ 139**
- RCD-202803-04 Hemi 392 **\$ 159**
- BDS-139 Hemi 392 3/16-1/4 Keys **\$ 139**
- BDS-125 Ford 429-460 **\$ 129**

Crank Hubs - Bearing Support

- B-2046 SBC Int Bal 3/16-1/4 Keys **\$ 329**
- B-2057 BBC Int Bal 3/16-1/4 Keys **\$ 329**
- B-2058 BBC Int Bal Dual 1/4 Keys **\$ 329**
- 202603-0020 Hemi Dual 1/4 Keys **\$ 369**
- B-2066 Hemi Dual 1/4 Keys **Rear \$ 269**

Degree Rings & Pointers

- BDS-198 Billet Pointer (SB or BB) **\$ 49**
- BDS-199 Thin Degree Ring 7in **\$ 69**
- B-2032 Thick Degree Ring 6.375 **\$ 69**
- B-2034 Thick Degree Ring 7.000 **\$ 69**
- BDS-198 Billet Pointer (SB or BB) **\$ 49**
- BDS-199 Alum Degree Ring 7in ... **\$ 69**

Dampner/Crank Hub Installation Kit



\$ 99

Premium Quality
Remove & Installs
Heavy Duty Case
RPC-S3940

Degree Ring w/ Magnets

\$ 179



B-2038 7.000 Offset

Fits Scalloped Crank Hub
.250 Thick
1, 5 & 10
Degree Marks

\$ 119



B-2033 6.375in
B-2037 7.000in

Crank Triggers

Trigger Brackets

- RCD-202010-55 SBC Right **\$ 69**
- RCD-202010-56 SBC Left **\$ 69**
- RCD-202010-50 BBC Right **\$ 79**
- RCD-202010-51 BBC Left **\$ 79**
- RCD-202010-60 426 Hemi (Pr) **\$149**
- RCD-202010-63 TFX (Pr) **\$149**
- RCD-202010-70 392 Right **\$ 79**
- RCD-202010-71 392 Left **\$ 79**



**Billet Aluminum
Brackets &
Holders**

Pickup Holders

- RCD-202015-03 MSD Std **\$ 49**
- RCD-202015-05 Leahy Std **\$ 49**
- RCD-202015-08 MSD Short Left **\$ 39**
- RCD-202015-10 MSD Short Right **\$ 39**
- RCD-202015-12 Leahy Short Left **\$ 39**
- RCD-202015-14 Leahy Short Right **\$ 39**

Short



Std



Billet Pointers (For 7" Rings)

- RCD-202022-09 Fixed SBC **\$ 25**
- RCD-202000-0010 Adj KB, BBC **\$ 35**



SBC



HEMI & BBC



Billet Idler Pulleys and Brackets

Machined from Billet 6061-T6 and Show Polished



Billet Idler Pulley

Idler Pulleys are machined from 6061-T6 alum and polished. Feature an offset double ball bearing. Crowned center helps keep belt centered. Available in 3.3 or 4.5in Diameter.

Includes: Idler Pulley, Alum Standoff and Washer.



B-6092 2" wide x 3.3 **\$ 139**

B-6095 3" wide x 3.3 **\$ 139**

B-6096 3" wide x 4.5 **\$ 159**

B-6090 Steel T-Nut **\$ 25**



Aluminum Idler Pulley Spacers

Spacer Widths .400 to 1.400 **From \$10**



Blower Mounted

Billet L-Shape bracket mounts directly to the front of most roots blowers.

Kit Includes: Bracket, T-Nut, Bolts and Alum Standoffs.

B-6000 Bracket Only **\$ 67**

B-6001 Standard Kit **\$ 145**

B-6002 Long Kit **\$ 149**

Long Kits include .700 spacer & longer bolt.



Swing Arm

Billet Swing Arm Bracket clamps to snouts (with 3.38" OD). Allows one to adjust the idler pulley For and Aft.

B-6007 Billet Arm **\$ 139**

Idler Bolt 5/8-11 x 4" **\$ 5**

Engine Mounted Kits

Includes: Polished Alum Bracket, Water Standoffs (Drilled & Tapped), Mounting Spacers & Bolts, Idler Bolt & Chromoly T-Nut.



BDS-606K SBC Kit **\$ 239**

B-6051 BBC Kit **\$ 199**

Engine Mounted Brackets



BDS-606 SB Chevy **\$ 104**

B-6050 BB Chevy **\$ 109**

B-6062 426 Hemi **\$ 165**

156206-09 392 Hemi **\$ 159**

Mounts to Engine Block. 3/4" Aluminum Prevents Warpage.

Outboard Support HEMI Kit

Includes: Alum Bracket, Outboard Support, 3.10" Idler Pulley, Bolt, T-Nut and Hardware. Fits BAE, KB, TFX.

Mount for Dunn Offset Mag Drive



B-6065 HEMI Kit **\$ 449**

B-6067 Mag Mount **\$ 98**

HEMI Outboard Support Bracket Angled w/ T-Nut & Mounting Hardware.

BAE, KB, TFX.

No idler pulley or outboard support



B-6062 Hemi **\$214**

Dual Carb Scoops



\$249

Fits Blowers & Most Tunnel Rams

Scoops are replicas of the famous Bugcatcher Injector. Designed to fit single or dual carbs. Highly polished with anodized butterflies.

Complete with Mounting Hardware and Filters!

RPC-S5339 Smooth RPC-S5239 Ribbed

Dual Carbs:
7.75 - 9.25 c-c

Hilborn-Style

Hilborn-style scoops are designed for single or dual carbs on Tunnel Rams & Blowers. Polished aluminum with finned or smooth top. *Includes:* Adjustable mounting hardware, front screen & filter(s).



New



RPC-S5246 Single Carb **\$ 129**
RPC-S5233 Dual Carb **\$ 149**
RPC-S5236 Shotgun-Style .. **\$ 249**

Blower Only Carb Scoops



Polished aluminum *Dual Carb* scoop for **Standard** four-barrel style carbs *mounted inline* or *side-saddle* on 8 5/8" centers. (Won't fit most Tunnel Rams)

BDS-9000 Dual Carb Blower Scoop **\$ 229**
BDS-9000C Above w/ Filters **\$ 299**



Polished *Dual Carb* scoop for **Dominator** style carbs mounted *side-saddle* on 8.75" centers.

BDS-9000D-2 Dual Dom Scoop **\$ 389**
BDS-9000DC-2 Above w/ Filters..... **\$ 519**



K&N Air Filter Element, Polished Stainless-Steel Top, Stud & Nut.
BDS-9100K STD Holley **\$39** BDS-9100KD Dominator **\$79**



Heavy-Duty Vinyl Scoop Covers embroidered with BDS logo.
Colors: Black, Blue, Purple, Red, Yellow & Pink.
BDS-9001 Vinyl Cover **\$25** BDS-9000D1 Dom Cover **\$29**

Carb Adapter Plate

Carb Plate Includes: Billet Plate, Screen Gasket, Carb Base Gaskets, Cadum Plated Bolts & Washers.



Dual four barrel carb adapter plate for a 6.71 or 8.71 blower. Accepts two **Standard** Holley carbs sidesaddle or Carter carbs inline on an 8-5/8" center to center. Holley carbs without secondary metering plates may be run inline.

B-9050 Dual Standard \$ 139

Dual Holley **Dominator** carb plate. Accepts two Holley Dominator carbs mounted sidesaddle at 8-3/4" center to center. **B-9053 Dom \$ 139**

Single four barrel carb adapter plate for 6.71 or 8.71 blower. Accepts **Standard** Holley and Carter four barrel carbs.



BDS-14B6-2 Single Carb \$ 129



2" Xcelerator is machined from billet aluminum, hard anodized and machined for o-ring. Accepts **carb adapter** plate or **injector**. 3" forward offset for airflow.

BDS-5400-14 \$ 469

Pressure Gauge

Liquid Filled
Boost, Oil, Fuel **\$39**

X-710000 0-15psi
X-710030 0-30psi
X-710060 0-60psi
X-710100 0-100psi



1.50" Diameter

Blower Boost Memory Kit .. \$ 45

(Gauge not included in kit)

Pro Street Cells

16 Gallon

With Fuel Level Sender

These 16 gallon cells fit between big wheel tubs or tight frame rails. Features two AN8 pickup fittings and one AN6 vent. Available with or without foam. Fitted with a fuel level sending unit of your choice.



JAZ-253-116-01	18x18x12; 240-33 ohms	\$ 239
JAZ-256-116-01	Same Above No Foam	\$ 195
JAZ-253-016-01	25x17x9; 240-33 ohms	\$ 237
JAZ-256-016-01	Same Above No Foam	\$ 195

Horizontal Race Fuel Cells

Features flush aerospace style cap assembly, two AN8 pickup fittings in the sump and one AN6 vent (or return) on top. Cells are foam filled. Suitable for drag racing, circle track, off-road and street.



JAZ-250-005-01	5 Gallon	\$ 125
JAZ-250-008-01	8 Gallon	\$ 135
JAZ-250-012-01	12 Gallon	\$ 149
JAZ-250-016-01	16 Gallon	\$ 194



Funny Car/Altered Cells



This 12 gallon fuel cell is specially made with one AN12 pickup (Optional AN16). There is one AN6 fitting on top for venting. Fuel injection return lines can be easily installed near the top of this cell.

JAZ-290-112-01 .. \$ 169

Vertical Fuel Cells

Vertical drag race cells come standard with two AN8 pickup fittings in the sump. Each cell is mil-spec foam filled and features a flush aerospace style filler cap.



JAZ-250-001-01	1 Gallon	\$ 125
JAZ-250-003-01	3 Gallon	\$ 125
JAZ-250-004-01	4 Gallon	\$ 132
JAZ-250-105-01	5 Gallon	\$ 132

Steel Mounting Hardware **\$33.95**

Caps & Accessories

Huge selection of premium quality parts for fuel cells.



JAZ Poly Seats

Seats feature one-piece, double walled, seamless construction. Has provisions for 5pt harness. Molded-in threaded inserts included on bottom of seat.

JAZ-100-100-01 \$ 69.97

Seat Covers

Covers are made of heavy duty, leather grained vinyl and are foam padded. Snaps are included for easy installation.

JAZ-150-101-01 \$ 57.97



What makes JAZ Poly Seats and Fuel Cells unique?

JAZ polyethylene seats and fuel cells feature hollow, one piece seamless construction with molded-in colors that won't fade, peel or scratch off. These seats and cells each have excellent high and low temperature impact. They will not corrode or rust.

They can be frozen, hit with a hammer and will not break. The double-walled construction of the seats deliver a comfortable, impact absorbing ride. The crosslinking process provides maximum strength and minimum weight with sufficient elasticity to resist shock and vibration damage.

Each seat has molded-in threaded inserts which will withstand a pull-out force of 1600lbs each. Installation is fast and trouble-free.

Aluminum Drag Seat

This seat is designed for serious door slammer applications. It is extremely rigid yet weighs only 9lbs with the cover. Made from 5052 grade .090 aluminum.

JAZ-120-300-03 \$ 139.97

Black Vinyl Seat Cover

JAZ-150-301-01 \$ 72.97



Universal Seat Mounts

Bracket kit fits all JAZ seats. Pre-drilled for nine separate seat heights and angle adjustments.

JAZ-450-010-09 ... \$ 29.95



Sliding Seat Mount

Easy to operate single lever. Heavy cadmium plated steel prevents rusting. Can be used on all JAZ seats featuring a flat bottom.

JAZ-450-011-03 ... \$ 38.95



Roll Bar Padding

SFI 45.1

Colors
Black
Red
Blue



Roll bar padding is made from high-density foam with double-sided tape for secure, non-slip, easy installation. Padding fits 1-1/2" to 1-3/4" diameter tubing. Available in 1/2" & 3/4" thickness.

Sold in 3 foot lengths

\$22.95

Also Available for Helmet Bars (1 - 1.25")

Foam Padding 3' Length



\$7.95

Black, Silver, Red, Orange, Yellow, Blue

Sealed Battery Box

Fits Standard Group 24 battery.
NHRA & IHRA Approved.
Measures 10.5 x 13 x 9.5" tall
Completely sealed lid.
Vent tube to carry battery gases
outside of vehicle.
Rotational molded plastic case is
resistant to battery acid.



JAZ-700-500-01 **\$ 77**



Mounting brackets and all hardware included!

Stainless Steel Battery Mount



Lightweight
Polished SS
*Mounting
Hardware
Included*

RPC-S9323 Universal Mount **\$ 29**
RPC-S6323 Optima Yellow Top **\$ 88**
RPC-S6324 Optima Blue Top **\$ 99**
RPC-S6325 Optima Red Top **\$ 99**

**NHRA &
IHRA
Legal**

Torke-Totes



Torke-Totes are designed to house an 8
to 11" torque converter in a dry and
clean environment. Torke-Totes can
also be used as shipping containers.

JAZ-700-100-07 **\$ 52**

Krank Kase

Prevents journal damage.
Great for transporting/storing
those expensive crankshafts.
Strong enough for shipping.



JAZ-700-300-07 SBC **\$ 67**
JAZ-700-301-11 BBC

Cell Mounting Kits

Pre-fab Steel Brackets designed
to perfectly fit JAZ fuel cells.



JAZ-400-008-03 8 gal cell **\$ 36**
JAZ-400-012-03 12 gal cell **\$ 37**
JAZ-400-016-03 16 gal cell **\$ 39**
JAZ-400-022-03 22 gal cell **\$ 42**

All JAZ Sizes Available



Head Kase

JAZ storage cases are designed to house a complete
cylinder head with studs and springs in a
clean and safe environment. Great for shipping.

JAZ-700-200-07 SBC .. **\$ 74.95ea**

20 JAZ-700-201-11 BBC .. **\$ 81.95ea**



Third Member Storage Case



Keeps third member free of dirt. Fits all Ford 9" and
are stackable. Built-in handles makes for easy handling.
Great for shipping and storage.

JAZ-700-009-01 Horizontal ... **\$ 51.95**

JAZ-700-010-01 Vertical **\$ 54.95**



Breather Tanks

This remote 1qt breather/ oil separator easily mounts to a rollbar or firewall. Comes standard with molded-in inserts and a swivel petcock for easy draining.

- JAZ-605-025 AN6 **\$ 45.95**
- JAZ-605-825 AN8 **\$ 47.95**
- JAZ-605-125 AN10 **\$ 52.95**
- JAZ-605-225 AN12 **\$ 61.95**
- JAZ-605-000 Blank **\$ 34.95**



Mini Breathers

\$ 62

Jr Dragsters, Go Carts & small CID Engines

Similar to above breathers but is 1 pint and has two 3/8 or 1/4 hose barbs.

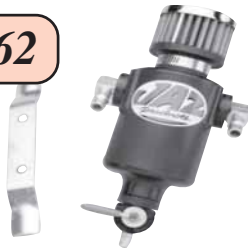

JAZ-605-375



Radiator Overflow Catch-Cans

One-piece molded construction with unique swivel elbow input. Lever handle petcock for easy draining. Meets NHRA requirements for 1qt. capacity. Easy mounting with molded-in threaded inserts.

JAZ-600-025

\$ 21

Colors: Black, Red, Blue, Purple, Orange, Clear



Stainless Steel Overflow

New !

High Luster SS
2pt Capacity
w/ Mounting Bracket

- RPC-S6075X 2x19"
- RPC-S6076X 3x10"

\$ 45

Fuel Cell Tip Over Valve

\$22

Fuel cell vent prevent fuel spill if tipped upside-down

- JAZ-834-006 AN6
- JAZ-834-008 AN8



Small Fuel Cells

Cells are designed for applications utilizing gas & alcohol fuel. The 1 gallon features an aircraft style cap, 1/4" petcock fitting for fuel pickup and vent.



- JAZ-230-025-01 1 Quart **\$ 46.97**
- JAZ-230-051-01 2 Quart **\$ 59.97**
- JAZ-230-001-01 1 Gallon **\$ 120.97**

Funnels & Filters

JAZ funnels feature anti-splash lips. Can be cut to desired length & flow rate. 11 & 14" accepts 60 micron Stainless Steel filter.



- JAZ-555-008-06 8" Round **\$ 15.95**
- JAZ-555-011-06 11" Round **\$ 23.95**
- JAZ-550-014-06 14" Triangular **\$ 15.95**
- JAZ-500-000-01 Filter 60 micron **\$ 21.95**

Radiator Hose Kits

This kit contains 48" of braided stainless steel radiator hose with 4 chrome alum end caps, clamps, hose sleeve adapters and rubber reducers. For upper & lower hoses.



RPC-S7311 Radiator Hose Kit **\$ 89.95**

Braided Stainless Steel Kit
Covers upper radiator hose, heater, fuel & vacuum hoses. Includes chromed alum ends.

RPC-S6678 **\$29**



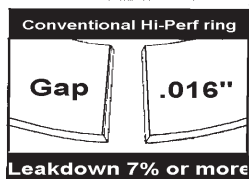

Leakdown 7% or more

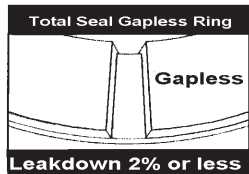

Leakdown 2% or less

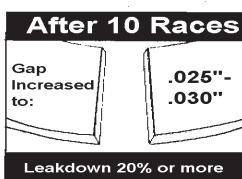

Leakdown 20% or more

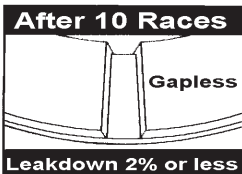

Leakdown 2% or less

Gapless Piston Rings

As a normal ring wears, the gap opens up allowing more combustion gasses to escape. The Total Seal Gapless ring has no gap. Instead, its patented design incorporates a 2-part interlocking ring to close the gap and provide a more perfect seal between the piston and cylinder.

Keeps Leakdown to 2% or Less!

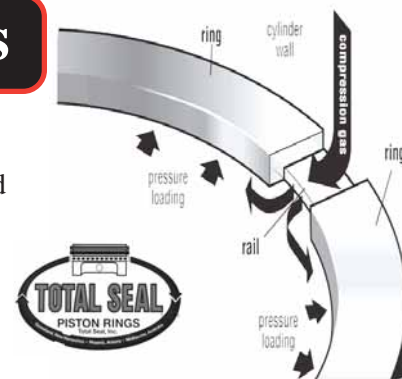

Leakdown Tester



Dual Gauge
w/ 14mm Hose
Professional Grade
T-2002

Ring Compressor



Heat Treated
Anodized Alum
\$39

Ring Filer

Files piston rings simply and accurately.

Bench mounted



Gapless 2nd RACE Sets (1/16 1/16 3/16)

4.035 TS-T3690.35	\$ 228	4.355 TS-T6490.35	\$ 232
4.065 TS-T3690.65	\$ 228	4.385 TS-T6490.65	\$ 232
4.155 TS-T0690.30	\$ 228	4.445 TS-T9190.195	\$ 232
4.255 TS-T9190.05	\$ 232	4.505 TS-T9190.255	\$ 232
4.285 TS-T9190.35	\$ 232	4.567 TS-T9130.5	\$ 256
4.315 TS-T9190.65	\$ 232	4.605 TS-T9150.5	\$ 256

Most Popular Sizes Including *Dykes* are in Stock

KING Premium Engine Bearings



Proven effective on circle track engines running at 8000rpm, on Top Fuel Blown Engines producing 5500HP as well as on high performance street vehicles. Alecular material offers an extremely high temperature threshold and high load capacity.

R O D

X-CR-848HPSTD	SBC w/o Dowel	62.99
X-CR-848HPSTD-X	SBC .001 Oversize w/o Dowel	62.99
X-CR-850HP010	305 SBC .010 w/ Dowel	65.99
X-CR-850HPSTD	305 SBC STD w/ Dowel	65.99
X-CR-850HPSTD-X	305 SBC .001 Oversize w/ Dowel	65.99
X-CR-850HP020	305 SBC .020 w/ Dowel	65.99
X-CR-851HP020	327 SBC .020 w/o Dowel	65.99
X-CR-853HP001	BBC .001 w/ Dowel	84.99
X-CR-853HP010	BBC .010 w/ Dowel	84.99
X-CR-853HP020	BBC .020 w/ Dowel	84.99
X-CR-853HPSTD	BBC STD w/ Dowel	84.99
X-CR-853HPSTD-X	BBC .001 Oversize w/ Dowel	84.99
X-CR-849HP010	BBC .010 w/o Dowel	79.99
X-CR-849HPSTD	BBC STD w/o Dowel	80.99
X-CR-840HP	426 HEMI w/ Dowel	95.99
X-CR-840HP001	426 HEMI .001 w/ Dowel	95.99
X-CR-840HP010	426 HEMI .010 w/ Dowel	95.99
X-CR-863HP	426 HEMI Upper Only	95.99

M A I N

X-MB-5142HPSTD	SBC	73.99
X-MB-5142HPSTD-X	SBC .001 Oversize	73.99
X-MB-5142HP020	SBC .020	73.99
X-MB-5147HPSTD	BBC STD 3/4 Groove	91.99
X-MB-5147HPSTD-X	BBC .001 Oversize 3/4 Groove	91.99
X-MB-5147HP001	BBC .001 3/4 Groove	91.99
X-MB-5147HP010	BBC .010 3/4 Groove	91.99
X-MB-5147HP020	BBC .020 3/4 Groove	91.99
X-MB-5164HPSTD	BBC STD Full Groove	91.99
X-MB-5164HP010	BBC .010 Full Groove	91.99
X-MB-5116HP	426 HEMI	79.99
X-MB-5116HP010	426 HEMI .010	79.99

Blower Restraints



Billet 7075-T6 Aluminum
Silver Aluminized Straps
Quick Disconnect Pins

Re-certifiable

- DJ-141000 Restraint w/ Hardware SFI 14.1 **\$ 319**
 - Restraint Only, No Hardware SFI 14.1 **\$ 249**
 - DJ-141999 Re-Certification SFI 14.1 **\$ 79**
 - DJ-141002 Adjustable Silver Straps (4ea) .. **\$ 119**
 - DJ-141900 Mounting Hardware w/ pins **\$ 125**
 - DJ-142007 Top Alcohol Restraint with Kevlar Ballistic Bag and Steel Hardware SFI 14.2 **\$1049**
 - DJ-143101 Top Fuel Restraint with Kevlar Ballistic Bag and Steel Hardware SFI 14.3 **\$1598**
- (Need Premium Gaskets? See Page 38)*

Window & Wheelie Bar Nets

- DJ-221721 Angular 17x21 **\$ 44**
- DJ-221824 Square 18x24 **\$ 33**
- JAZ-906-03 Installation kit **\$ 57**
- DJ-220001 Wheelie Bar **\$ 59**



SFI 27.1

Trans Blankets



Multiple layers of Ballistic material to capture exploding shrapnel.

SFI 4.1

Water and Oil Resistant
Re-certifiable

Engine Diapers



SFI 7.2

Snap-in Absorbant Pads.
Q.D. Adjustable Straps.
Ballistic Nylon.
Premium Quality.
DJ-730350 **SBC**
DJ-730454 **BBC**
DJ-730426 **Hemi**
Most Makes Available



\$195

Pro Diapers

Adjustable quick release buckles attaches to the header flanges.
Reusable Snap-in Absorbant Pads.Can be recertified.



SFI 7.1

TF/TA Legal

- DJ-711001.bal Soft Ballistic Nylon **\$ 548**
- DJ-711002 Soft Kevlar (shown) ... **\$ 779**
- DJ-710002 Carbon Fiber Bucket ... **\$ 949**
- DJ-710401 Replacement Pads (pr) **\$ 59**

Plug Wire Shield

Protect spark plug wires in the event of a burst panel or blower back-fire.



DJ-070200 ... **\$ 19.99**

- DJ-801012 Powerglide **\$ 139**
 - DJ-801014 Turbo 350/400 **\$ 179**
 - DJ-801126 Lenco Reverser (only) **\$ 129**
 - DJ-801124 Lenco 2spd w/Rev **\$ 159**
 - DJ-801152 Lenco 3spd w/Rev **\$ 198**
- Over 2 Dozen Models Available !*

Heavy Duty Race Car Tiedowns

Webbing is 2" wide. Burst Strength: 5,000lbs
12' Standard Length. Snap-in J-Hooks Ends

- A. DJ-236201.12 Inline Ratchet Tiedown .. **\$ 27.95**
- B. DJ-236205.8 w/ Sewn-In Axle Loop **\$ 29.95**
- C. DJ-238044 Flush Mounted D-Ring **\$ 9.99**
- D. DJ-237224 Heavy Duty Axle Strap 24" **\$ 10.95**
- E. D-36605 Cycle Tiedown w/ S-Hook **\$ 8.50**
- D-36604 1" x 6' Mini Ratchet **\$ 15.95**
- DJ-241202 Heavy Duty Tow Strap 14' **\$ 26.99**



Don't trust your cool ride to inferior brands

Seat Belts and Harnesses

DJ Safety offers over 100 combinations of 5pt Seat Harnesses. **Options include:** Latch/ Link design or Quick Release (CamLock), 2" or 3" wide. **3 Styles of Attachment:** Wrap-around, Bolt-in or Snap-in.

Cam
\$159

SFI 16.1

Latch
\$ 89

Also Available in 6 & 7pt.

Colors:
Black, Red & Blue
Fresh Dates!

Seat Belts Out-of-Date?

5pt Latch/Link style ... <i>most</i>	\$ 89
w/ Fire Protective Covering	\$ 149
5pt Cam Lock style	\$ 159
w/ Fire Protective Covering	\$ 198
Rewebb & Recert <i>most</i>	\$ 69
w/ Fire Protective Covering	\$ 109

Buckle Styles

Cam Lock Latch/Link

Belt Mounting Options

A. Snap-In
B. Bolt-In
C. Wrap Around

Premium Mechanix Gloves

Designed to help the professional mechanic with increased grip. Protects from heat & cold. Features CLARINO palm, 3-ply mesh top and elastic Velcro wrist.

Sizes: XS-XL

\$19

Feature 100% heat-resistant woven Kevlar fabric, extra long sleeve protects arm above the elbow, oil and fuel resistant, snug fit allows comfortable fit.

Heat Sleeves
MG-05-902
\$25

Shoulder Pads

D-70200 2" Slip-On pads **\$ 19**
DJ-603050 3" Fire Retardant Pads **\$ 35**

Shoulder pads are available as Slip-Ons or Sewn-In. Great Driver Comfort.



Premium Seatbelt Hardware

Hardware is made of high quality steel for that measure of safety you are looking for and deserve.

- A. DJ-600105 Snap-In Kit w/ Hardware **\$ 6.95**
- B. DJ-600305 Floor Mount Kit w/Hrdwr (pr) **\$ 6.95**
- C. DJ-600402 3-Bar Adjuster 2" (pr) **\$ 3.95**
- C. DJ-600403 3-Bar Adjuster 3" (pr) **\$ 5.95**

Arm Restraints



Arm Restraints have velcro closure and are adjustable in length.

SFI 3.3 **DJ-605000** Arm Restraints **\$ 29/pr**



Too Fast? We Can Stop You!

Drag Chutes



- DJ-851252 Super Quad (s/g, s/c) \$ 219
- DJ-851424 Blown Gas or Alcohol Boat \$ 439
- DJ-851070 Pro Mod & Top Alcohol \$ 399
- DJ-851079 Top Fuel Dragster/ FC \$ 425
- D-30470 Nylon Pack 7x7 \$ 79
- DJ-852999 Nylon Pack 9x9 \$ 69
- DJ-852996 Silver Pack 9x9 \$ 98
- DJ-852809 Pilot Chute Heavy Duty \$ 69
- DJ-852200 Release Cable with Lever \$ 39
- DJ-999999 "Remove Before Run" Flag \$ 5

Colors:
Black * Red * Blue

Over a Dozen styles
to choose from !!

Chutes Include: Quad Cross-Form Canopy, Pack, Pilot and Bridle Line.

Coldfire 302 Fire Systems

Coldfire302 is a harmless plant & water based fire suppressing agent. Is especially effective in Class B fires (Oil/fuel). Also suitable for wood & paper fires. Suppresses quickly, prevents reflash, safe to store and leaves virtually no residue. Biodegradable and environmentally safe.



Systems		
DJ-911050	5lb	\$ 369
DJ-911100	10lb	\$ 399
DJ-911100	20lb	\$ 899



- DJ-911101 10lb Bottle Only \$ 299
- A. DJ-911327 Manual Injector \$ 79
- B. DJ-911328 Mnl Injector & Bracket \$ 85
- C. DJ-911329-2 Pull-Style Adapter \$ 59
- D. DJ-911329 Pneumatic Injector \$ 149
- E. DJ-910410 Mounting Bracket 5.25 \$ 32
- D-89260.438 Mounting Bracket 4.38 \$ 29
- DJ-911311 Nozzle & Fitting Kit 3pc \$ 79
- Alum Tubing 1/4" (10ft Coil) \$ 14
- DJ-911203 Remote Cable From 3ft \$ 49

Accepted by Most Sanctioning Bodies

Fire System is DOT & SFI Approved.
Bottles can also be Refilled.

Nomex Driving Suits

Driving Suits are manufactured to meet one of the following specs:

SFI 3.2A/1, 5 or 20.

Standard Suits are one solid color with contrasting trim.

Sizes: S-XXL
Colors: Black, Red, Blue

DJ Safety sfi /20 suits can be recertified every 5 years!

Options:
Arm Restraints
Kool Pad Pockets
Embroidery



SFI 1 Suits (1 Layer)	
DJ-011200 Jacket ..	\$ 79
DJ-011300 Pants	\$ 69
DJ-011100 1pc Suit .	\$ 129
SFI 5 Suits (2 Layer)	
DJ-012200 Jacket ...	\$ 169
DJ-012300 Pants	\$ 169
DJ-012100 1pc Suit	\$ 299
SFI 20 Suits (4 Layer)	
DJ-014200 Jacket ...	\$ 699
DJ-014300 Pants	\$ 549
Sewn-in Restraints	\$ 59

Choose from 1pc or Separate Jacket and Pants

Driving Boots



DJ styling Driving Shoes feature padded Kevlar lining and velcro closure.



Sizes: 1-13 in Full Sizes
Colors: Black, Red, Blue, Gray

- DJ-050000 sfi 3.3/5 Shoes \$ 79
- DJ-051000 Alky/TF sfi 3.3/20 Boots \$ 229

Kool Vest

Keeps driver or crew member comfortable for upwards of an hour. Thin vest easily fits under driver's suit. Has one pad on upper back and one on each kidney.

Sizes: S-XXL



D-03520 ... \$ 79

D-03520-3 Extra/Replacement Kool Pads \$8.99ea

Driving Gloves

Leather Palm Gloves offer excellent protection while maintaining a high level of comfort.

- D-04100.331 Nomex sfi 3.3/1 \$ 77
- DJ-022000 Nomex sfi 3.3/5 \$ 59
- DJ-024000 Nomex sfi 3.3/15 \$ 129
- D-84600 Nomex sfi 3.3/20 \$ 139



Colors: Black, Red, Blue

How to Measure Glove Size:



Lay hand flat with fingers and thumb together. Measure circumference at widest point.

8"	= Sml
9"	= Med
10"	= Lrg
11"	= XL



Race Helmets



Helmets are built to meet and exceed Snell 2010. The "SA" rating has a fire-resistant liner.

Full Face

Sizes: XS-XXL

SA2010 \$ 299

M2010 \$ 279



Open Face

Sizes: XS-XXL

SA2010 \$ 279

M2010..... \$ 199



Note: Blown Alcohol & Nitro applications usually requires a Snell "SA" rating

Save \$50 !!

We have a limited selection of SA2005 Helmets. They're discounted \$50 off the above price. Call for sizes & availability

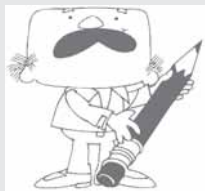

How to Measure Helmet Size

To properly determine head circumference, run a soft tape measure around your head (approximately one inch above your eyebrows and just over the ears).

Hat Size Circumference

XS	6 1/2"....	21 5/8"
S	7".....	22"
S	7 1/8"....	22 3/8"
M	7 1/4"	22 3/4"
M	7 3/8"	23 1/8"
L	7 1/2"	23 1/2"
XL	7 5/8" ...	24"
XXL	8"	25"

Equipment Bags



Made from a high quality rip-stop nylon. Internal padding. 3 pockets.

Helmet Bag

DJ-036010 \$29.95

Gear Bag

DJ-070410 \$49.95



Helmet Supports

Velcro Closure

SFI Approved

DJ-040009 \$ 29



Tapered For Comfortable Fit

Head Socks/ Underwear

Head Socks are designed to be worn under the helmet. These soft nomex knit hoods provide an extra measure of protection. Nomex underwear are also soft and gives a driver a few extra critical seconds of time.

D-03211 1 Layer \$ 29

DJ-062002 2 Layer, *sfi 3.3* \$ 45

DJ-060000 Top S-XL \$ 69

DJ-061000 Pants S-XL \$ 69

DJ-063040 Socks \$ 22



Nostalgia Mask

Made of aluminized silver.

Includes breathers.

D-83110-SIL Mask non-SFI \$ 349



We stock jr Dragster Safety Equipment !!



You just found those Hard-To-Find Tools !!

Cam Degree Installation



Here is a tool that makes degreering a cam a lot quicker and easier. This fixture attached to the block over cylinder #1 using two of the block studs (or bolts).

An adjustable stop is included for helping determining top-dead center. There are 2 spring-loaded rods for each lifter. Simply install a dial indicator into either the intake or exhaust hole of the fixture.

T-1115 SBC **\$159**

T-1117 HEMI **\$149**

Valve Lash Adjuster

Quickly and accurately adjust your valves with this custom tool. Machined from stainless steel for durability with choice of 7/16 or 1/2 hex. Fits SBC, BB, Mopar & most Fords. 1/8" or 3/16 hardened Tip.



\$59

7/16 Hex

T-1124 1/8 Tip

T-1125 3/16 Tip

T-1126 1/2 Hex 3/16 Tip

Main Cap Puller

The bottom-end guy sure appreciates this main cap slide puller. The 5/16 heat-treated threads are easily threaded into the main cap using the slip-proof knurled knob. A simple tug of the tool allows the cap & lower bearing to drop safely into your hand. A great asset for between round thrashes. Also great to have one at the shop.



T-1103 2.5 Lbs **\$59**

T-1100 4.5 lbs **\$89**

Adjustable AN Wrench

Protect the anodize on your AN Hose Ends. Knurl Thumbscrew. Minimizes chance of over-tightening.



\$49

Fits AN3-20

Hemi Top Dead Center Checker

Wanna' check your top dead center like a pro? Then grab one of these. Simply thread the checker into Cylinder #1 of your Hemi and rotate the crank until the dial indicator maxes out. A real time saver when trying to dial in a magneto or camshaft at the track.



T-1134

\$149



Push Rod Straightness Checker

\$139

Valve train failure is normally catastrophic and a bent push rod can be attributed as a culprit in many instances. A pushrod out-of-round as little as .010 will begin to flex. I'm sure you have seen the wear marks on the sides of your pushrods and wonders how they got there. With the Pushrod Checker, simply insert the pushrod into the spring loaded end, rotate 360 degrees and quickly check the roundness of a pushrod to less than .001.

T-1120 BBC

T-1121 FATHEAD

T-1122 HEMI FUEL

Rod Bolt Stretch Checker

One simply inserts the rod bolt into the Bolt Stretch Checker and records the reading on the gauge. Bolts that are stretched more than .007 are usually discarded. A complete set of 16 bolts can be checked in less than 60 seconds. Might just be the best minute you invested in your engine assembly.



T-1128 **\$65**

Rod-Piston Pusher

Here is a tool that allows one to safely and quickly install or remove the rod-piston combo out of the block. The pointed end of The Pusher is simply inserted into one of the two threaded holes in the connecting rod. The bend in the shaft allows easy navigation around the crankshaft journal. The diver with hot oil dripping onto his face will thank you profusely.



Billet Alum

T-1131 **\$39**

Magneto Wrench

Designed to very quickly and safely remove the drive from a Mallory or MSD magneto/ Distributor. It simply slips over and holds the 4-Pin or Hex Cross Drive so that one can remove the inner nut. No need to remove the magneto cap and hold the rotor. Ditto for installing the drive.



T-1017 **\$24**



T-1003
\$145

Spark Plug T-Wrench

Save time and head damage. This torque wrench only allows the spark plug to tighten to a predetermined safe setting. Machined from billet aluminum for strength & lightweight. Very popular among Top Fuel & Alcohol teams.

The Gapper

Quickly, precisely and accurately gap spark plugs. Billet Alum.



T-1002 **\$59**

Spark Plug Storage Rack

Heavy-Duty, yet lightweight rack is designed to store 8 spark plugs safely and in order. Large flat anodized bottom keep the rack upright and easily cleans up. Can be used stand-alone or bolted to a work bench. Those that assemble the engine top end will truly appreciate this rack regardless if they're at the shop or in the pits.



T-1136 Holds 8 **\$39**

T-1138 Holds 16 **\$47**

Valve Train Trays

These trays are made of a very light-weight yet rigid plastic material with built-in handles. The valve tray holds valve springs, valve locks, and the largest of valves. The rocker tray holds push rods, lifters, poly locks, spark plugs and rocker arms. Perfect for the home mechanic or pro racer.



\$29



JAZ-735-001-06 Valve & Spring
JAZ-735-002-06 Rocker Arm & Lifter

Billet Primer Bottle Top

Machined from Billet Alum and precisely drilled to allow correct flow of fluid during priming of a blown alcohol or nitro engine. Fits most plastic bottles. Used by the Pros.



\$29

Rack 'em Up

Piston & Rod

Safely hold and protect a complete set of Pistons & Rods during assembly. A must for the serious racer.



T-3003

\$154

Head Repair

Here's a great rack to store your Valves, Lash Caps, Shims & Retainers during head repairs. Sturdy billet anodized aluminum bottom tray.



T-3009

\$129



Lifter/ Push Rod

Just set this tray in your lifter valley and store your pushrods & lifters in order.



T-3013

\$114

Clutch Stand

This rack is heavy-duty yet lightweight, Holds 5 discs and rotors. Designed by a racer for racers.



T-3005

\$109

Injector Hat Tool Tray

Injector Hat Tool Tray is made from high grade aluminum and black powder coated for an attractive long-lasting finish. The tray has plenty of space for tools & also accommodates 16 spark plugs. Fits on top of Bug, Bird, Buzzard.

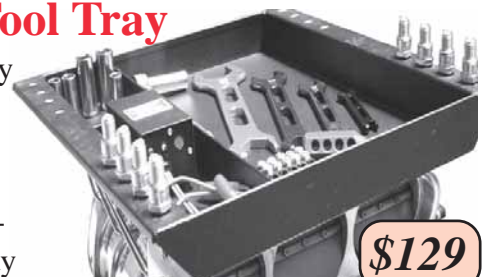

\$129

OLS-TT600

Quick-Connect Burndown Tubes

- * Anodized Aluminum
- * Positive Locking
- * Heat Treated Flanges



HEMI
C-7152

Accepted by:
NHRA & IHRA

\$149/ Set

1.25" Hose Clear
B-5125... **\$5/ft**



ALL
OTHERS
C-7150



PS Anglia-Style Boulton Spindle Kits

Billet or Stainless Steel. 2" King pin bosses.
CNC machined and double-lock on steering arm
to ensure against movement.

Funny Cars, Dragsters & Altered

- C-7103 Billet **\$319**
- C-7105 SS **\$339**
- C-7107 Arm **\$29**

Complete with:

Pins, 2 Arms, Caps & Grade 8 Hardware.



Professional Oil Filters

Spin-On aluminum filter
features a re-usable
Stainless Steel element.
Very easy to inspect oil.



A

Remote Mounts and Block Adapters

Machined from Billet alum and anodized.
Available in AN10 or 12.



B

C

D

- A. SYS-209-312361 Oil Filter 4.25" **\$141**
- A. SYS-211-510571 Oil Filter 6.37" **\$169**
- Replacement SS Element 6.375" **\$58**
- B. SYS-221-90004 Remote Mount **\$139**
- C. SYS-220-90006 Remote 1.50" **\$164**
- D. SYS-228-90556 Block Adapter **\$192**

FC/Altered Front Brake Kits



Designed for the PS/
Anglia style spindle
popular on Funny
Cars and Altered.

\$498.98

Front Brake Kit

Includes Mounting Hardware!

In-line Residual Valves retain a minimum line
pressure (2 psi) to eliminate excessive pedal travel.



Wilwood Master Cylinders are
High Pressure die-cast from
High-Grade Aluminum, fully
machined and assembled with
exclusive features.



We Specialize in Drag Racing Brakes



- W-260-4894 Master Cylinder Dual **\$118.98**
- W-260-6764 Master Cylinder 3/4" **\$57.98**
- W-260-6765 Master Cylinder 7/8" **\$57.98**
- W-260-6766 Master Cylinder 1" **\$57.98**
- W-260-1874 Residual Valve 2psi **\$17.98**
- W-120-2498 Front Caliper Dynalite **\$92.85**
- W-120-6818 Rear Caliper Dynalite **\$124.95**
- W-150-1251K Front Pads Round Spot **\$32.98**
- W-150-8937K Front Pads Square **\$39.98**
- W-150-8850K Rear Pads **\$42.98**
- W-140-3326 FC/Altered Front Brake Kit ... **\$498.98**

Determine Correct Cable

1. Select The Housing Style
2. Measure the Length (Tip to Tip)

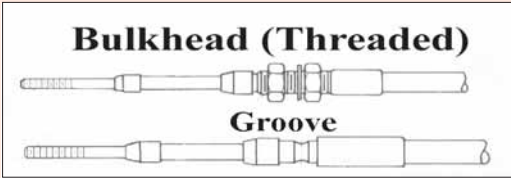

**Custom Length Cables?
No Problem!**

24" Throttle Cable



CC-UV-100-24 Nylon Housing **\$29**

CC-UV-200-24 Stainless Steel **\$39**

*** Cables can be shortened ***



**18'
Chute
Cable**

Stainless Steel Center Wire CC-PCTG-216 .. **\$31**
With Lever .. **\$40**

The Choice of the Pros in Top Fuel & Alcohol



- *Threaded 10-32 Both Ends
- *Grooved or Bulkhead Housing
- *Stainless Steel Inner
- *Heavy Duty Quality



Grooved Housing on Both Ends.

* Throttle



Double-Nut **Bulkhead Housing** on One or Both Ends.

* Shifter



Grooved Housing on One End.

T-Handle with Double-Nut **Bulkhead** on Driver's End.

* Fire System, Fuel Shutoff

Length	Groove	Bulkhead	T-Handle
2 Foot (24")	\$ 38.99	\$ 48.99	\$ 60.99
3 Foot (36")	\$ 39.99	\$ 49.99	\$ 61.99
4 Foot (48")	\$ 40.99	\$ 51.99	\$ 63.99
5 Foot (60")	\$ 43.99	\$ 53.99	\$ 65.99
6 Foot (72")	\$ 45.99	\$ 55.99	\$ 67.99
7 Foot (84")	\$ 47.99	\$ 58.99	\$ 70.99
8 Foot (96")	\$ 50.99	\$ 60.99	\$ 72.99
9 Foot (108")	\$ 52.99	\$ 62.99	\$ 74.99
10 Foot (120")	\$ 55.99	\$ 65.99	\$ 77.99
11 Foot (132")	\$ 57.99	\$ 67.99	\$ 79.99
12 Foot (144")	\$ 59.99	\$ 69.99	\$ 81.99
13 Foot (156")	\$ 62.99	\$ 72.99	\$ 84.99
14 Foot (168")	\$ 64.99	\$ 74.99	\$ 86.99

Cable Brackets

Billet Aluminum & Lightweight

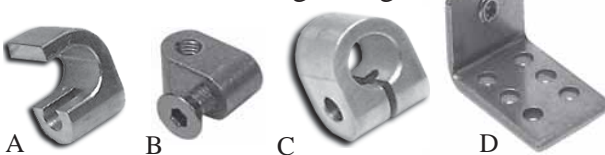

- A. CC-161-011-V Billet Half Clamp
- A. CC-161-011-P Billet Chute Clamp **\$7**
- B. CC-091-SP3-A Chute Pivot
- C. CC-161-011-VF Billet Full Clamp
- D. CC-161-011-M Swing Hook Clip **\$9**

Cable Ends

\$8ea

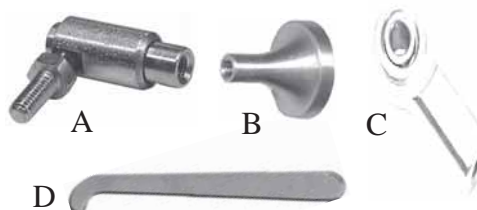

- A. CC-175-403-0030 Q.D. Ball Joint
- B. CC-165-172-307A Round Knob
- C. CC-CREF-3-3 Female Heime
- D. CC-PCH-100 Alum Lever **\$9**

Injector Throttle Cable Bracket

\$35



Anodized alum bracket mounts to the front of the blower. Allows quick disconnect of throttle cable.

SAE-239-B **Bug/Bird**

AN Thread Sizes

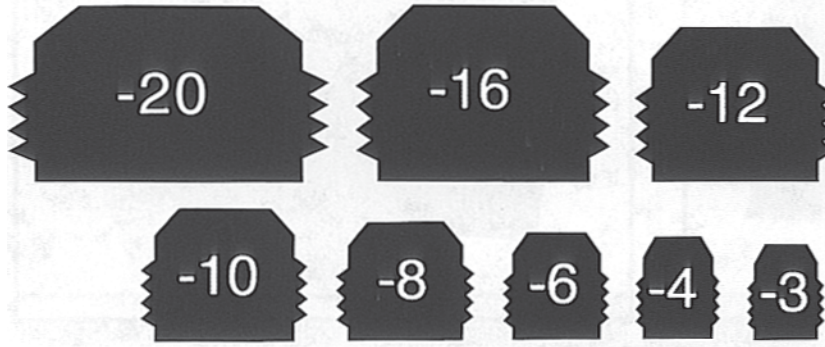

AN Size	Metal Tube O.D.	Thread Size
4	1/4"	7/16-20 UNJ
6	3/8"	9/16-18 UNJ
8	1/2"	3/4-16 UNJ
10	5/8"	7/8-14 UNJ
12	3/4"	1-1/16-12 UNJ
16	1"	1-5/16-12 UNJ
20	1-1/4"	1-5/8-12 UNJ

NPT Thread Sizes

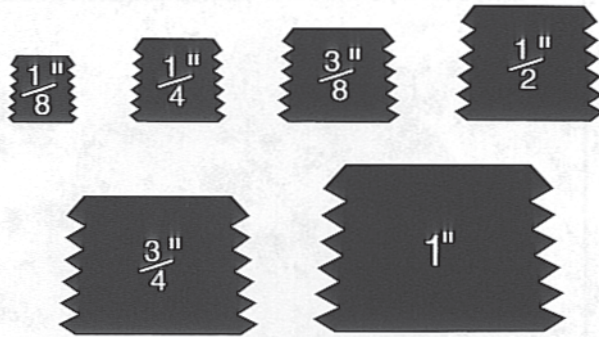

Pipe Thread Size	Threads Per Inch	Fitting I.D.	Closest AN Fitting Size
1/8"	27	1/8"	4
1/4"	18	1/4"	6
3/8"	18	3/8"	8
1/2"	14	1/2"	10
3/4"	14	3/4"	12
1"	11-1/2	1"	16
1-1/4"	11-1/2	1-1/4"	20

Bulkhead Nut Sizes

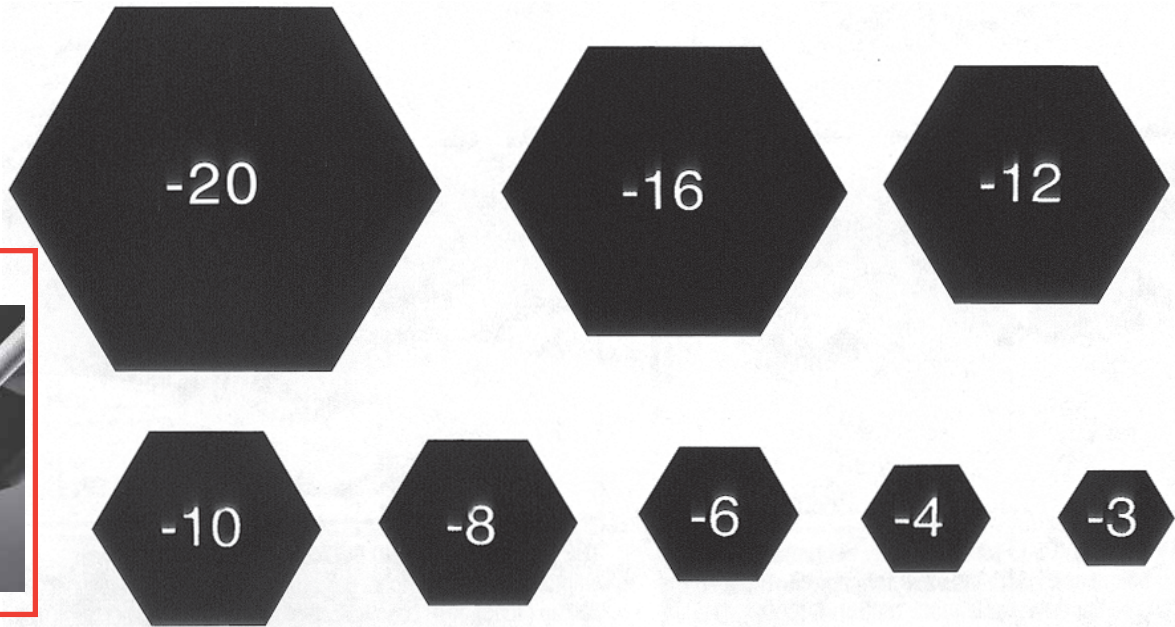

Plumbing Catalog

80 pages of plumbing technical data and photos.



FREE with Purchase!

Aluminum AN Weld Bungs

Female

AN6	X-987106	\$ 9.57
AN8	X-987108	\$ 10.15
AN10	X-987110	\$ 11.99
AN12	X-987112	\$ 12.37
AN16	X-987116	\$ 19.99

Male

X-997106	\$ 3.76
X-997108	\$ 4.99
X-997110	\$ 5.86
X-997112	\$ 9.96
X-997116	\$ 12.90

Alum Female Pipe Weld Bungs

Nut

3/8"	X-996703	\$ 4.99
1/2"	X-996704	\$ 5.88
3/4"	X-996706	\$ 8.40
1"	X-996708	\$ 9.96

Round

X-996803	\$ 3.55
X-996804	\$ 3.89
X-996806	\$ 4.06
X-996808	\$ 4.64

Hose Fitting Assembly

1. Wrap hose tightly with tape at cutting point. Using a fine tooth hacksaw, cable cutters or radiac wheel, cut the hose in the middle of the tape. Remove tape after cutting being careful not to fray the braid.

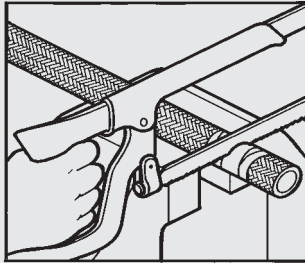

2. Slip hose into socket to the depth indicated by the hose insertion mark on the outside of the socket. This should be just short of the back of the threads. **VERY IMPORTANT** - Mark hose with tape or suitable marking device at rear of socket. This mark will later indicate to you if the hose has pushed out of the socket during assembly.

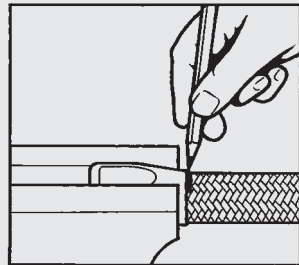

3. Using an anti-seize lubricant, liberally lubricate inside of hose and threads on the nipple. Holding nipple horizontally in a vise equipped with soft aluminum jaws, push socket end carefully with hose nipple with a turning motion and engage nipple threads into those of the socket. Continue tightening by hand as far as possible to make sure that the threads are properly mated and no cross threading has occurred.

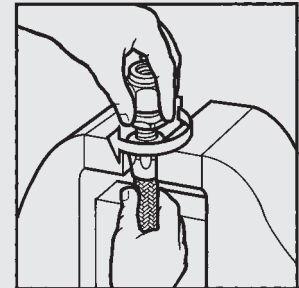

4. Using an aluminum fitting wrench, finish tightening assembly. When properly assembled a small gap of .030" or less should exist between the socket and shoulder of nipple. **NOTE:** Check marks on hose in step 2 for any evidence of push out. Hose assembly must be cleaned and tested to twice the operating pressure.

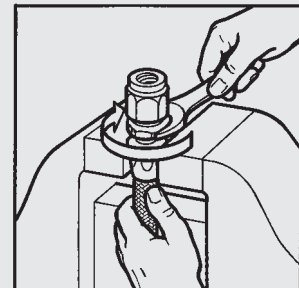

No more Bloody Fingers!

Assemble Braided Stainless Steel hose without poking your fingers. Ideal for racers and performance enthusiasts who have experienced the painful challenge of installing the AN socket.



Award Winner
SEMA Show

KT-468 3pc Kit AN4-6-8 \$ 74

KT-681 3pc Kit AN6-8-10 .. \$ 79

KT-1016 3pc Kit AN10-12-16 \$ 89

KT-416 6pc Kit AN4-16 \$149



\$36

Teflon Hose Separating Tool

Easiest way to assemble braided stainless steel AN3 & AN4 teflon hose. **X-821060**

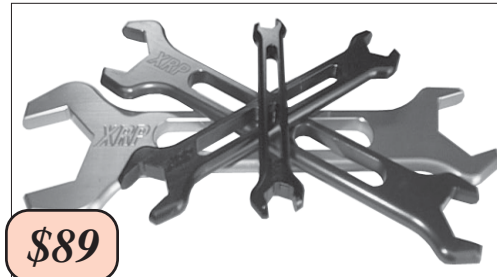

\$89



Professional Aluminum Wrenches

Precisely sized for a perfect fit on AN fittings. Anodized in colors, XRP wrenches are fully radiused to fit your hand. Machined from heat treated 2024 aluminum alloy. **X-750000** AN3-20

Toll-Free Tech Advice &
Online "How-To-Videos"
800/576-7661
DragParts.com



Aluminum Vice Jaws

Vice Jaw inserts protect your hose ends during assembly. Each jaw has magnetic backing to prevent them from falling out of the vice when opened.



X-821010

\$19

Why Use CPE Braided SS Hose ??



Used by Top Teams everywhere, Stainless Steel braid provides durability and Heat Resistance. Inner liner is composed of Chlorinated Polyethylene (CPE) which provides the finest fluid transfer available with a temperature range of -40 degrees to +300 degrees F.

AN-4	\$ 6.35/ft
AN-6	\$ 6.90/ft
AN-8	\$ 7.90/ft
AN-10	\$ 8.90/ft
AN-12	\$10.90/ft
AN-16	\$11.90/ft
AN-20	\$16.90/ft



Fixed

AN-4	100004..	\$ 7.16
AN-6	100006..	\$ 7.63
AN-8	100008..	\$ 9.61
AN-10	100010..	\$12.57
AN-12	100012..	\$17.19
AN-16	100016..	\$26.43
AN-20	100020..	\$41.70

Straight

Blue & Red Fittings.

* Also Available In *

Black & Super Nickel

Swivel Ends allow one to position hose end after it has been installed on hose.



Fixed

AN-4	104504....	\$ 17.10
AN-6	104506....	\$ 18.46
AN-8	104508....	\$ 21.79
AN-10	104510....	\$ 25.80
AN-12	104512....	\$ 31.13
AN-16	104516....	\$ 39.65
AN-20	104520....	\$ 74.69

45 Degree

Swivel

AN-6	204506....	\$ 20.53
AN-8	204508....	\$ 24.08
AN-10	204510....	\$ 28.04
AN-12	204512....	\$ 33.57
AN-16	204516....	\$ 42.15
AN-20	204520....	\$ Call



Fixed

AN-4	109004....	\$ 17.10
AN-6	109006....	\$ 18.46
AN-8	109008....	\$ 21.79
AN-10	109010....	\$ 25.80
AN-12	109012....	\$ 31.13
AN-16	109016....	\$ 39.65
AN-20	109020....	\$ Call

90 Degree

Swivel

AN-6	209006....	\$ 20.13
AN-8	209008....	\$ 24.75
AN-10	209010....	\$ 28.04
AN-12	209012....	\$ 33.64
AN-16	209016....	\$ 42.15
AN-20	209020....	\$ Call



Fixed

AN-4	118004....	\$ 21.84
AN-6	118006....	\$ 23.35
AN-8	118008....	\$ 26.88
AN-10	118010....	\$ 29.73
AN-12	118012....	\$ 33.72
AN-16	118016....	\$ 44.87

180 Degree

Swivel

AN-6	218006....	\$ 23.08
AN-8	218008....	\$ 27.30
AN-10	218010....	\$ 30.68
AN-12	218012....	\$ 38.06
AN-16	218016....	\$ 55.93



Braided SS TEFLON Hose

Braided Stainless Steel TEFLON Hose and Reusable Hose Ends are used in Brake, Clutch, Instruments and other applications where max high pressure protection is a must.

AN-3	X-610003...	\$ 3.20/ft
AN-4	X-610004...	\$ 3.83/ft

TEFLON Hose Ends

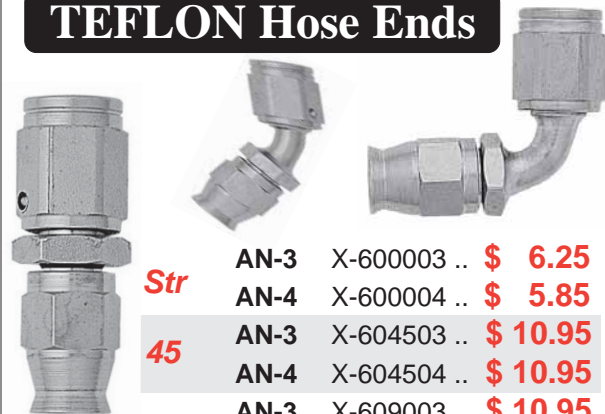

Str
45
90

AN-3	X-600003 ..	\$ 6.25
AN-4	X-600004 ..	\$ 5.85
AN-3	X-604503 ..	\$ 10.95
AN-4	X-604504 ..	\$ 10.95
AN-3	X-609003 ..	\$ 10.95
AN-4	X-609004 ..	\$ 10.95

TEFLON Hose Assembly



We stock Pre-Assembled AN3 & AN4 Braided SS Teflon Hose Assemblies. Straights or 90 Deg Ends. Lengths: 12" - 48"

from.. \$10

Push-On Hose & Ends

From.. \$3.57/ft

Blue and Black Rubber Hose AN4-12

AN6	X-230006	\$ 4.57
Str AN8	X-230008	\$ 5.44
AN10	X-230010	\$ 7.33
AN12	X-230012	\$ 11.95
AN6	X-239006	\$ 16.29
90 AN8	X-239008	\$ 19.55
AN10	X-239010	\$ 22.40
AN12	X-239012	\$ 26.64



Hose Ends also Available in: 30, 60, 120 & 150 Degree



Tube Nuts



Tube Sleeves

Hose Finishers

Anodized Alum.
Includes SS
Worm Clamp

Red
Blue
Black



Anodized	AN-3	X-981803...	\$.91	X-981903...	\$.95
Blue Alum.	AN-4	X-981804...	\$.91	X-981904...	\$.95
Works on	AN-6	X-981806...	\$ 1.19	X-981906...	\$ 1.19
Steel or	AN-8	X-981808...	\$ 1.73	X-981908...	\$ 1.35
Aluminum	AN-10	X-981810...	\$ 2.49	X-981910...	\$ 2.08
Hard Line.	AN-12	X-981812...	\$ 3.36	X-981912...	\$ 3.38
	AN-16	X-981816...	\$ 5.38	X-981916...	\$ 3.85

AN4	X-550104	\$ 4.34
AN6	X-550106	\$ 4.34
AN8	X-550108	\$ 4.62
AN10	X-550110	\$ 5.53
AN12	X-550112	\$ 6.49

Hex Pipe Plug

Internal hex for smooth finish and easy installation.



1/8	X-993202 (pr)	\$ 2.43
1/4	X-993203 (pr)	\$ 2.43
3/8	X-993204 (pr)	\$ 3.08
1/2	X-993205	\$ 3.26
3/4	X-993206	\$ 4.20

EPR O-Rings

Long Lasting - Won't Shrink

X-803003	AN3	\$ 3.66
X-803004	AN4	\$ 4.18
X-803006	AN6	\$ 5.01
X-803008	AN8	\$ 5.01
X-803010	AN10	\$ 7.89
X-803012	AN12	\$ 7.89
X-803016	AN16	\$ 4.50*

* packs of five

Ideal for
Gas,
Alcohol
& Nitro



AN Flare Reducers



Female - Male

AN6-4	X-995006	\$ 6.79
AN8-6	X-995008	\$ 7.75
AN10-6	X-995010	\$ 8.68
AN10-8	X-995011	\$ 8.68
AN12-8	X-995012	\$ 10.33
AN12-10	X-995013	\$ 10.33
AN16-12	X-995017	\$ 27.74

Anodized Alum



Flare Plug

Port Plug

Flare Cap

Hex Nut

AN-3	X-980603...	\$ 1.40	X-981403...	\$ 1.73	X-992903...	\$ 1.84	X-992403...	\$.91
AN-4	X-980604...	\$ 1.40	X-981404...	\$ 2.07	X-992904...	\$ 2.15	X-992404...	\$.91
AN-6	X-980606...	\$ 1.40	X-981406...	\$ 2.10	X-992906...	\$ 3.48	X-992406...	\$ 1.03
AN-8	X-980608...	\$ 2.61	X-981408...	\$ 3.34	X-992908...	\$ 4.13	X-992408...	\$ 2.00
AN-10	X-980610...	\$ 3.36	X-981410...	\$ 5.04	X-992910...	\$ 5.06	X-992410...	\$ 2.07
AN-12	X-980612...	\$ 5.01	X-981412...	\$ 7.44	X-992912...	\$ 6.79	X-992412...	\$ 2.36
AN-16	X-980616...	\$ 6.42	X-981416...	\$ 9.49	X-992916...	\$ 8.75	X-992416...	\$ 4.69

Flare to Pipe Adapters

Most other
Sizes
in Stock



Straight

45 Degree

90 Degree

Flare - Pipe

AN-3.....1/8	981603	\$ 2.28	982303	\$ 7.26	982203	\$ 7.26
AN-4.....1/8	981604	\$ 2.28	982304	\$ 7.39	982204	\$ 7.39
AN-6.....1/4	981606	\$ 2.45	982306	\$ 7.60	982206	\$ 7.60
AN-6.....3/8	981666	\$ 3.17	982366	\$ 10.20	982266	\$ 10.20
AN-8.....1/4	981607	\$ 3.29	982307	\$ 13.04	982207	\$ 13.04
AN-8.....3/8	981608	\$ 3.29	982308	\$ 9.22	982208	\$ 9.22
AN-8.....1/2	981688	\$ 4.81	982388	\$ 14.67	982288	\$ 14.67
AN-10....1/2	981610	\$ 4.88	982310	\$ 14.67	982210	\$ 14.54
AN-10....3/4	981613	\$ 9.12	982313	\$ 21.72	982213	\$ 21.72
AN-12....3/4	981612	\$ 9.12	982312	\$ 21.72	982212	\$ 21.72

Flare Adapters

AN-3	981503	\$ 2.71	AN Flare Coupler
AN-4	981504	\$ 2.71	
AN-6	981506	\$ 2.71	
AN-8	981508	\$ 4.81	
AN-10	981510	\$ 5.60	
AN-12	981512	\$ 10.87	
AN-16	981516	\$ 17.51	



4-3	991902	\$ 4.13	
6-4	991906	\$ 4.24	AN Flare Reducer
8-6	991912	\$ 5.93	
10-6	991914	\$ 8.68	
10-8	991915	\$ 8.42	
12-8	991919	\$ 13.04	
12-10	991920	\$ 13.04	
16-10	991922	\$ 16.95	
16-12	991923	\$ 16.95	
20-12	991925	\$ 23.65	
20-16	991926	\$ 27.95	



Stainless Steel Tubing

Great for plumbing your
Brake, Fuel or Fire System.

E-ST18	3/16	
E-ST25	1/4	\$ 5.95/ft
E-ST37	3/8	



Seamless!!

Male Flare to Female Swivel Tee



AN4	X-900304....	\$ 13.67	<p>On Side</p>
AN6	X-900306....	\$ 16.92	
AN8	X-900308....	\$ 24.73	
AN10	X-900310....	\$ 29.94	
AN12	X-900312....	\$ 31.24	
AN16	X-900316....	\$ 84.12	

On Run

On Side

AN ORB Adapters

Male AN Flare to High Contour Inverse Male AN with an O-Ring.
Hard Anodized Black.
All Sizes in Stock from:
AN3 - AN20



Swivel AN to Male Pipe

AN3 - AN12
1/8 to 3/4 NPT



Fuel Pressure Take Off Adapters

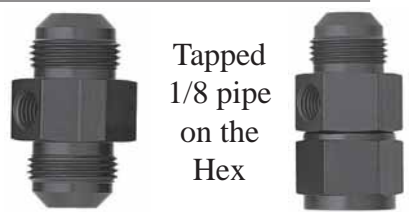

Tapped 1/8 pipe on the Hex

X-700192	-6 Male to -6 Male	\$ 8.33
X-700194	-6 Male to 3/8" Male NPT	\$ 8.33
X-700195	-6 Male to -6 Female Swivel	\$ 9.77
X-700196	-8 Male to -8 Male	\$ 9.73
X-700198	-8 Male to 3/8" Male NPT	\$ 9.73
X-700199	-8 Male to -8 Female Swivel	\$ 11.57
X-700202	-10 Male to -10 Female Swivel	\$ 14.89

Carb Fittings



Dual Feed Holley

X-700106	AN6 to 7/8-20	\$ 7.30
X-700128	AN8 to 7/8-20	\$ 10.94

Single Feed AN6

X-700006	9/16-24 Holley	\$ 5.78
X-700306	5/8-20 Carter	\$ 5.78

Fittings Include Washers

Female Swivel Coupler



AN6	X-900106	\$ 6.63
AN8	X-900108	\$ 8.14
AN10	X-900110	\$ 9.89
AN12	X-900112	\$ 13.86
AN16	X-900116	\$ 19.29



Female Swivel Coupler - 90 Deg

AN4	X-929004 ...	\$ 13.30
AN6	X-929006 ...	\$ 13.30
AN8	X-929008 ...	\$ 14.98
AN10	X-929010 ...	\$ 18.99
AN12	X-929012 ...	\$ 20.48
AN16	X-929016 ...	\$ 47.26

Forged

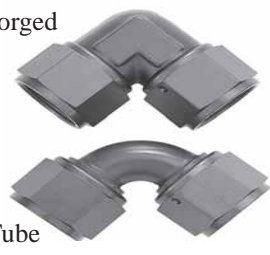

Tube

Liquid Filled Pressure Gauge

Great for **Oil** or **Fuel Pressure**, or **Blower Boost**. Liquid filled for stability and longevity.



X-710000	0-15psi	Shock Resistance
X-710030	0-30psi	
X-710060	0-60psi	
X-710100	0-100psi	

1.50in Diameter **\$39**

Gauge Fittings

Connect your Gauges to AN Hoses



X-705003	STRT to 1/8 Fem NPT AN3	\$ 5.27
X-705004	STRT to 1/8 Fem NPT AN4	\$ 2.05
X-705093	90 Deg to 1/8 Fem NPT AN3	\$ 5.16
X-705090	90 Deg to 1/8 Fem NPT AN4	\$ 3.66



Carburetor Line Kit

Braided Stainless Steel
Multiple Sizes and Styles Available.

Gauge Sold Separately



As low as .. **\$ 64**



Billet Gear Drives

- Billet Alum Cover
- Chromoly Gears
- Fixed Idler
- Premium Fasteners

One of the strongest on the market !



BILLET Gear Drives

RCD-251000-0003 SBC	\$ 899
RCD-251000-0006 SBC w/ BBC ...	\$ 899
RCD-251000-0009 SBC Tall.....	\$ 949
RCD-251500-0002 BBC	\$ 899
RCD-251500-0040 KB OLDS	\$1099
RCD-253500-0002 TFX	\$ 899
RCD-253500-0020 KB, BAE	\$ 999
RCD-253500-0040 KB, BAE Tall ..	\$ 999
RCD-254000-0040 417 Donovan	\$ 999

Gear Drive Components

RCD-300205-0028 Cam Cover (SBC only)	\$ 129
RCD-300205-0032 Cam Cover All Others	\$ 149
B-2121 Cam Cover (KB-BAE-TFX, etc..)	\$ 95
RCD-300209-03 5/8-3/8 Steel Hex Adap	\$ 49
RCD-300207-05 3/8 Steel Shaft 5"	\$ 79
RCD-300201-0032 QR Pump Ext 3 or 5"	\$ 359
B-2125 QR Pump Ext Smooth 5"	\$ 189
B-2126 QR Pump Ext 5" (Fits Non-RCD)	\$ 189



RCD-300205-0028



B-2121

RCD-300209-03



RCD-300207-05

RCD-300201-0032



B-2126



Jesel Belt Drives



- Cam timing adjustment is made externally providing the easiest and most accurate tuning available.
- Billet aluminum Spider is made from 2024-T6 and is available as a solid unit for additional strength.
- Accessories available to run distributor drives, fuel pumps or oil pumps off front of cam.
- Hard coated Billet aluminum 7075 Upper Pulley features patented High Torq Drive™ tooth configuration.
- Teflon® coated high vacuum cam and crank seals.
- Patented High Torq Drive™ reinforced belt operates dry and spins with less friction than timing chains or gear drives and also absorbs harmonics.
- Crank Pulley is heat-treated steel and incorporates a High Torq Drive™ tooth configuration.
- Kit hardware is all Grade 8 Allen and Torx™ head design.



JES-KBD-31000 SBC Standard	\$ 940
JES-KBD-31200 SBC w/ BB Snout	\$1024
JES-KBD-32000 BBC Standard	\$1045
JES-KBD-35000 426-440 Mopar	\$1239

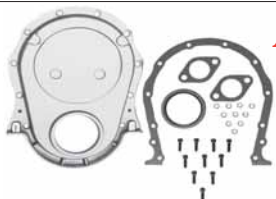

Alum Timing Cover

Polished Aluminum Cover, Gasket, Seal & Chrome Bolts!

RPC-S6040BOX SBC.....	\$ 35.99
RPC-S8422BOX BBC.....	\$ 49.99
RPC-S8425 BBC Gen 5....	\$ 49.99*
RPC-S8430 BBC Gen 6....	\$ 49.99*

* Cover Only

Fixed Single Idler Gear Drive



RPC-S8410



SBC Polished Alum Cover

\$169

Dual Idler Gear Drive

(Will not fit OEM roller)



RPC-S8411 SBC
RPC-S8412 BBC

\$109

Same Day Shipping!



Accu-Seal Gaskets

Accu-Seal is the first choice of engine builders and race teams. The **Accu-Seal E** gasket line delivers precision fit, durability and economy all in one. **Accu-Seal Pro** utilizes state-of-the-art materials such as *proprietary steel core laminate with teflon coating, viton oil seals, and molded rubber* for selected Oil Pan and Valve Cover applications.

p/n: 1xxxxx = **Economy** 2xxxxx = **Pro**

Intake Gaskets



- SCE-111101 SBC Stock Port \$ 12.95/pr
- SCE-211101 SBC Stock Port Silicone Bead \$ 16.95/pr
- SCE-111102 SBC Large Port \$ 12.95/pr
- SCE-211102 SBC Large Port Silicone Bead \$ 17.95/pr
- SCE-113115 BBC Rectangular, No Top bolt \$ 12.95/pr
- SCE-213101 BBC Oval Port Silicone \$ 19.95/pr
- SCE-213102 BBC Rectangular Silicone ... \$ 19.95/pr
- G-2210 426 Hemi Stock Port 2.375 \$ 17.98/pr
- G-2212 426 Hemi Medium Port 2.750 \$ 17.98/pr

Valve Cover Gaskets

Premium Quality & Re-usable



- SCE-211075 SBC Laminated Silicone \$ 19.95/pr
- SCE-213075 BBC Laminated Silicone \$ 23.95/pr
- G-2310 426 Hemi Heavy-Duty \$ 11.47/ea
- SCE-266075 426 Hemi Teflon Coated \$ 34.95/pr

Engine Seals

Front

Rear Viton

- | | | | | |
|----------|-----------|---------|-----------|---------|
| SB Chevy | SCE-11102 | \$ 3.95 | SCE-21105 | \$19.95 |
| BB Chevy | SCE-11302 | \$ 7.95 | SCE-21305 | \$24.95 |
| 351W | SCE-13602 | \$ 7.95 | SCE-23605 | \$14.95 |
| BB Ford | SCE-13502 | \$ 7.95 | SCE-23505 | \$21.95 |
| SB Mopar | SCE-16902 | \$ 7.95 | SCE-16904 | \$ 9.95 |
| BB Mopar | SCE-16402 | \$ 7.95 | SCE-26405 | \$19.95 |
| 417 Hemi | SCE-16702 | \$ 7.95 | SCE-13405 | \$19.95 |
| 426 Hemi | SCE-16602 | \$ 7.95 | SCE-26605 | \$23.95 |

Front Cover



Includes Water Pump & Fuel Pump Gaskets

- SCE-11100 SB Chevy
- SCE-11300 BB Chevy
- SCE-13600 SB Ford
- SCE-13500 BB Ford
- SCE-16900 SB Mopar
- SCE-16400 BB Mopar
- SCE-16600 426 Hemi

\$6.95ea

Blower Gaskets & Seals

Premium Gaskets

- G-2058 Blower Snout \$ 3
- G-2052 Front Cover \$ 5
- G-2022 6.71 Base ... \$ 9
- G-2028 8-10.71 Base \$ 9
- G-2024 14.71 Base \$ 12
- G-2012 Inlet Small \$ 7
- G-2014 Inlet Screen \$ 9
- G-2016 Inlet Large \$ 7
- G-2070 Carb Gasket \$ 3
- G-2072 Dom Gasket \$ 3



Bearings & Seals

Blower Seals are heavy-duty, double-lipped teflon and designed for extreme temperature and pressure. Bearings are premium quality.

- G-3312 Blower Bearing Rear \$ 14
- G-3314 Blower Bearing Front \$ 17
- G-3320 Bearing/Seal kit Street \$ 89
- G-3322 Bearing/Seal kit Comp \$ 119
- G-3300 Standard Rotor Seal \$ 8
- G-3302 Oversize Rotor Seal \$ 8
- G-3304 Rotor Shaft Saver \$ 5
- G-2060 Snout Seal 1.125 \$ 8
- G-2062 Snout Seal 1.250 \$19
- BDS-500-4 Snout Brng 1.125 \$ 35
- BDS-510-4 Snout Brng 1.250 \$ 19



BUNA O-Ring Material

- G-3020 3/32, G-3022 1/8, G-3024 3/16 \$.95 ft

Oil Pan Gaskets

Premium Quality - Reusable
Gas - Alcohol - Nitro



- SCE-111091 SBC Pre 1974 Thin Front Seal \$ 12.95
- SCE-113090 BBC .090 Thick \$ 12.95
- SCE-235091 BB Ford 1pc Molded \$ 32.95
- SCE-113091 KB Olds .090 Thick \$ 15.95
- SCE-113092 Merlin Block, Lge stroke prov \$ 15.95
- SCE-167091 417 Hemi \$ 14.95
- G-2110 426 Hemi, KB, BAE \$ 11.95
- G-2114 TFX-92 \$ 11.95
- G-2118 TFX-96 \$ 11.95
- SCE-266091 426 Hemi Steel Core/ Teflon \$ 29.95

Copper Head Gaskets

Benefits of Using Copper...

Conductivity. Copper is the standard by which all other conductors are measured, therefore a copper gasket provides superior thermal conductivity, acting to stabilize head and block temperatures which makes tuning easier.

25% Coefficient of Elasticity. One of the properties of copper is that it stretches before a catastrophic failure, thereby providing an extra measure of safety in case of severe detonation.

Strength. Copper (in the form SCE use) has a tensile strength of approximately 32,000 psi, compare this to the 1200 to 1800 psi tensile of most facing materials used on conventional performance head gaskets.

Premium Quality * Properly Annealed
Perfect Fit * Dead Soft Copper

- .032 \$ 85/pr
- .043 \$ 85
- .050 \$ 89
- .062 \$ 99
- .070 \$ 179
- .080 \$ 119



O-Ring Wire
304 Stainless Steel
SCE-31541 15ft **\$10.95**



Pro-Copper Exhaust Gaskets

SCE Copper Exhaust Gaskets will permanently seal a warped or uneven flange.



In Stock: Chevy, Mopar, Ford
*** Reusable ***

Embossed **\$29/pr**
Non-Embossed **\$39**



The World's First Self Sealing Copper Head Gasket!

SCE's TITAN gaskets provides unbeatable strength and user friendly installation. This patented headgasket gives you the best of both worlds: The combustion sealing strength of a SCE copper head gasket and the confidence of **built-in coolant and oil seals!** The perfect racing and performance copperhead gasket!



- .032 **\$119**
- .043 **\$119**
- .050 **\$129**
- .062 **\$139**
- .070 **\$199**
- .080 **\$159**

Sold in Pairs

ICS Copper Head Gaskets

Same as above but with a **Integrated Steel O-Ring** means there is no need to machine your Block or Heads!

Sold in Pairs



No O-Ring Required!

- .043 **\$169**
- .050 **\$189**
- .062 **\$199**
- .070 **\$209**
- .080 **\$219**

Embedded silicone to seal oil and water passages. Soft copper is ready to use.

Awarded Best New Product at SEMA Show.

Collector Gaskets

Use SCE copper collector gaskets for maintenance free operation.



2.5, 3 and 3.5in **\$11.95/pr**

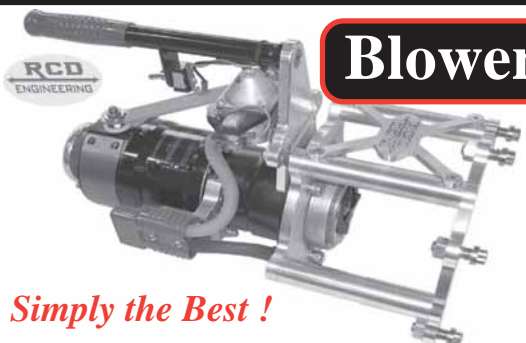

Blower Starter

Lightweight & Removable
36-48-60 Volts

Simply the Best !

- RCD-100500-0011 Blower Starter **\$1689**
- RCD-102505-0065 Battery Cables 15ft **\$ 125**
- RCD-102505-0005 200 Amp HD Relay **\$ 159**
- B-5045 Anti-Tipover Foot Alum **\$ 45**
- MMC-7043K82 Q.D. Battery End **\$ 19**
- RCD-101518-06 HD Starter Brush **\$ 4**

Front Bearing Supports



Chrome-moly crank hub
Billet aluminum plate & standoffs
Minimize crank flex & bearing damage

- RCD-202200-0002 Bearing Support SBC **\$ 439**
- B-2046 Crank Hub SBC 3/16 & 1/4 Keyways **\$ 329**
- RCD-202400-0002 Bearing Support BBC **\$ 469**
- B-2057 Crank Hub BBC 3/16 & 1/4 Keyways **\$ 329**
- B-2058 Crank Hub BBC Dual 1/4 Keyways **\$ 329**
- RCD-202600-0004 Bearing Support HEMI **\$ 649**
- RCD-202603-0020 Crank Hub HEMI **\$ 368**

Degree Rings & Chromoly Crank Bolt See Page 15

Belt Guards & Components

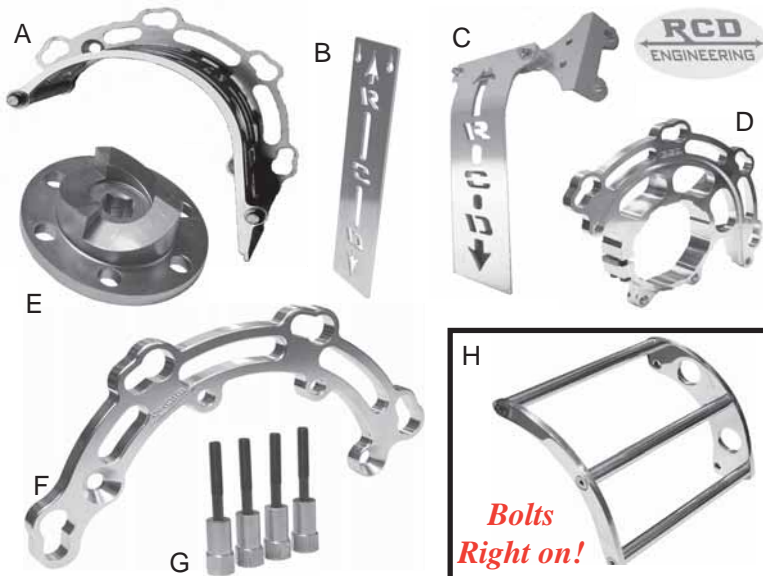

- RCD-103507-0010 Top Belt Guard, SSI 3-Hole **\$ 159**
 - RCD-103507-0018 Top Belt Guard, Snout Mntd **\$ 169**
 - RCD-157019-15 Snout Mounted Guard Clamp **\$ 129**
- (Specify with or w/o Starter Bracket for Belt Guards)

- A. RCD-103507-0004 Top Belt Guard, Roots **\$ 169**
- B. RCD-103512-10 Middle Belt Guard **\$ 45**
- C. RCD-103522-0003 Lower Belt Guard **\$ 135**
- D. RCD-103507-51 Starter Face Plate & Clamp ... **\$ 229**
- E. B-5040 Steel 6 Hole Starter Dog **\$ 66**
- F. RCD-103507-03 Blower Starter Face Plate **\$ 65**
- G. Belt Guard Mounting Kit For RCD Guards **\$ 59**

Mounting Kits Available from 1.75" - 3.00" standoffs

- H. B-5006 Billet Aluminum Belt Guard **\$ 139**
(6 to 12" in length. **No Add't** Hardware Required)

Designed for High Comp and Supercharged Engines

4.40 to 1 Gear Reduction
534 ft./lbs. Torque!
Lightweight (8.8lbs)
Compact and Adjustable
Heat Resistant Solenoid



- 1.3hp **\$179**
- 1.9hp **\$219**
- 2.0kw **\$249**

Chevy
Pontiac
Olds
Ford
Marine
Mopar
VW
Porsche
Harley

Warranty Guaranteed !



Premium Heavy-Duty Chassis Tabs



Carbon Steel 1/8 Thick

- A C-8152 Double Sided 3/8 hole .. \$ 4.99
- C-8152.5 5 Pack \$23.99
- B C-8150L Single Sided LH \$ 4.99
- C-8150L.5 5 Pack \$23.99
- C C-8150R Single Sided RH \$ 4.99
- C-8150R.5 5 Pack \$23.99
- D C-8154 Universal 3/8 hole \$ 1.99
- C-8154.5 5 Pack \$ 7.99

Chromoly 1/8 Thick

- A C-8186 Double Sided 3/8 hole ... \$ 7.99
- C-8186.5 5 Pack \$36.99
- D C-8182 Universal 3/8 hole \$ 5.99
- C-8182.5 5 Pack \$27.99

Over 97 %
of all race
parts sold
by Good
Vibrations
Products
are Proudly
made in the
USA!



Premium DZUS Fasteners

- A C-83010 Steel .550 Button \$ 1.55
- 10 Pack \$13.95
- B C-83013 Steel Backing Plate \$.65
- 10 Pack \$ 5.95
- C C-83015 Steel Spring \$.70
- 10 Pack \$ 6.95
- D C-83017 Doubler Round \$.85
- 10 Pack \$ 7.95
- E C-83018 Doubler Square \$.85
- 10 Pack \$ 7.95



- F C-83020 SE Button Assy \$ 2.20
- 10 Pack \$19.95
- G C-83023 SE Backing Plate \$.65
- 10 Pack \$ 5.95
- H C-83025 SE Steel Spring \$.70
- 10 Pack \$ 6.95

**Self
Ejecting
DZUS
(SE)**



Dimpling Tool
Professional way to
dimple your sheet
metal for DZUS.
C-83005 \$18

\$10



Hi-Quality Rod Ends

Male & Female

Left & Right Hand



Female Right Hand

- CREF-3-3 10-32 \$7.99
- CREF-4-4 1/4-28 \$6.99
- CREF-5-5 5/16-24 \$7.99
- CREF-6-6 3/8-24 \$7.99
- CREF-7-7 7/16-20 \$8.99
- CREF-8-8 1/2-20 \$9.99

Male Right Hand

- CREM-3-3 10-32 \$6.99
- CREM-4-4 1/4-28 \$6.99
- CREM-5-5 5/16-24 \$7.99
- CREM-6-6 3/8-24 \$7.99
- CREM-7-7 7/16-20 \$8.99
- CREM-8-8 1/2-20 \$9.99

Female Left Hand

- CREF-3L-3 10-32 \$7.99
- CREF-4L-4 1/4-28 \$6.99
- CREF-5L-5 5/16-24 \$7.99
- CREF-6L-6 3/8-24 \$7.99
- CREF-7L-7 7/16-20 Call
- CREF-8L-8 1/2-20 Call

Male Left Hand

- CREM-3L-3 10-32 \$6.99
- CREM-4L-4 1/4-28 \$6.99
- CREM-5L-5 5/16-24 \$7.99
- CREM-6L-6 3/8-24 \$7.99
- CREM-7L-7 7/16-20 Call
- CREM-8L-8 1/2-20 Call

Zoomie Headers

Weld-Up Kits

.065 Wall Thickness
Includes Flanges!

Dragster

(Single Wall)

- 2.00" SBC \$375
- 2.50" BBC \$395
- 2.50" Hemi \$450

FC/ Altered

(Double Wall)

- 2.25" Hemi 392
- 2.50" BBC & Hemi
\$ 475 Kit



Front Offset Drive

Alum drive allows one to drive the fuel pump and magneto off the gear drive. Clamps to your fuel pump extension. Gear driven - no belt to replace!



E-4116.M

\$ 579



Billet Offset Drives

Accepts Mallory or MSD Mags. Belt Driven. Includes Bronze Gear. Available in Fixed Flange or Adjustable Clamp Styles.

- A. I-2020 3.56" Fixed Flange **\$ 569**
- A. I-2024 6.56" Fixed Flange **\$ 669**
- B. I-2022 3.56" Adj Clamp **\$ 599**
- B. I-2026 6.56" Adj Clamp **\$ 699**
- C. I-2027 Star Coupler **\$ 49**
- D. RCD-302000-0005 Front **\$ 898**
- E. I-2062 Front Drive **\$ 995**
- F. T-1016 MSD Support **\$ 159**
- G. I-2030 Chevy Offset **\$ 695**
- H. I-2040 KB, TFX, BAE **\$ 795**
- I. I-2037 Cross Coupler **\$ 33**

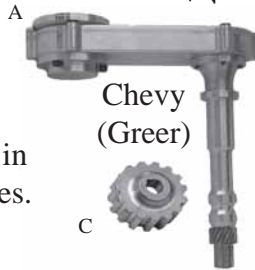

Chevy
(Greer)



Front Pump/ Magneto Drive (Sitko)

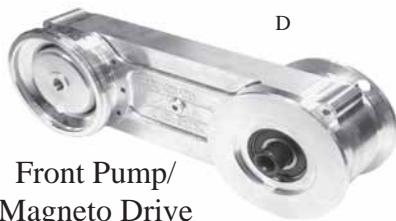

Front Pump/ Magneto Drive (RCD)



Chevy



Hemi

Magneto Offsets (Dunn)



Need Spark?

Mallory Super Mag III
3.8 amps

Great for supercharged alcohol engines. **Include:** Generator Assembly, Billet Aluminum Base, Pro Coil, QD Wiring Harness, Instructions and Case.

- M-35-36544 LH Hemi Pro Cap
 - M-35-59544 RH Chevy Pro Cap
 - M-35-59514 RH Chevy Stack Cap
- Also Available for Fords & Mopar*

\$ 1249

Includes padded shipping case!

Billet Magneto Bases



- A. M-35595 Chevy Base w/ Bronze Gear **\$ 239**
- M-35365 Hemi Straight Base **\$ 245**
- B. RCD-303000-0015 Hemi Angled Base **\$ 928**
- C. RCD-301811 Hemi Hold-Down Clamp **\$ 65**
- D. M-45520 Alum Slip Collar Clamp **\$ 29**
- E. I-2038 Magneto Clamp Billet Alum **\$ 98**
- F. M-26041A SS Steel Magneto Clamp **\$ 69**
- G. M-29426 Ford-Chevy Bronze Gears **\$ 61**
- I E-7025 Hemi Straight Base w/ oil shaft **\$ 356**

Move your Chevy Distributor or Magneto to the front.

Clamps to Pump Extension. Uses Std height BBC Base. Positions magneto behind blower belt. Includes Support Bracket.

RCD-302500-0010 ... **\$ 709**





Magneto Components



- M-28103A Advance Lock Out \$ 34.99
- M-28995 Rotor (RH) Stack Cap \$ 41.99
- M-28995A Rotor (LH) Stack Cap \$ 42.99
- M-29038 Rotor Adapter \$ 8.99
- M-29772 Rotor (RH) Pro Cap \$ 22.99
- M-29772C Rotor/Adapter w/ nylon screws \$ 64.99
- M-29773 Rotor (LH) Pro Cap \$ 24.99
- M-25758M Premium Contact Points \$ 24.99
- M-28005A .36mf (Small) Condenser \$ 32.99
- M-28005 .56mf (Large) Condenser \$ 39.99



- M-28862 Wiring Harness \$ 21.99
- M-205M HEI Stack Cap \$ 63.99
- M-29745 HEI Pro Cap \$ 54.99
- M-29744 Wire Retainer \$ 29.99
- M-26007B 4 Pin Drive Flange \$ 38.99
- M-26030 Woodruff Key \$ 1.95
- M-28797 Shrink Sleeving..... \$ 6.99
- M-28974 Timing Indicator \$ 3.98

Electronic Distributors

Low profile with flat cap for max clearance
CNC billet housing / Unilite Pointless
Small Diameter Bowl



Curved for Blown Engines

- M-3755801 Ford 351W \$ 419
- M-3756001 Ford 460
- M-3768501 Chevy V8



Electronic Ford Offset

Billet Alum * Pro Cap * Belt Driven
Ideal for Blown Engines

- Ford 302 / Ford 460 \$ 945



PRO Plug Wire

Mallory PRO WIRE Plug Wires are designed to withstand the high temperatures that performance engines produce. PRO WIRE Spark Plug Wire provides protection to over 500 degrees F.

SS or Carbon Core

- M-787 Hemi SS Straight Ends \$ 138
- M-783M Chevy SS 90 Deg Ends .. \$ 69
- M-797 Chevy Carbon 90 Deg Ends \$ 59

Red PRO Shield 25'

PRO SHIELD is a insulated sleeve that may be installed on all 7 & 8mm wires for protection against cross-fire and arching. Also helps reduce damage to plug wires from sharp edges. Pro Shield prevents spark plug wire damage from contact with water, oil or fuel.



- M-836 \$ 89

SUPER-MAG Transformer

COIL is externally mounted making for a more efficient and powerful magneto. HEI style contact terminals resulting in a more positive wire retention.



- M-28900A Pro Oil-Filled Coil \$ 234
- M-28900B Epoxy-Filled Coil \$ 285

Oil Pump Drives



- M-29003 Std Chevy Deck Pump Drive \$ 82
- M-29007 Tall BBC Deck Pump Drive \$ 119

Don Zig Mag Buzzer

Necessary To Set Magneto Timing

- ZIG-TB100 \$ 119



Kill Switches



Designed specifically for mags.
Positive push-off. Internally sealed to prevent corrosion.

- M-26072..... \$ 289

Air Actuated Kill Switch

Ideal for Top Fuel & Alky.
Connect to your CO2.



- I-2095 \$ 369



Power Building DVD's

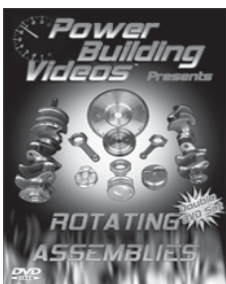
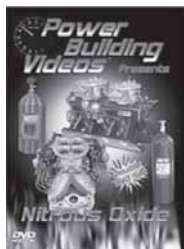

Multi-DVD sets are part of a series tailored towards racing and street performance. Filled with money and time saving advice. Great for the novice and veteran.

- PWR-D-NITROUS Nitrous**
- PWR-D-SUPR Blowers**
- PWR-D-CARB Carburetors**
- PWR-D-ROT Rotating Assy**

\$29.95

Good Vibrations will refund the price of the Blower DVD with the purchase of a blower!

Legal Stuff... Telephone Orders

Order lines are open between 8am and 4:30pm (PST) Mon-Fri. Also online at: www.DragParts.com. Most orders are processed and shipped within 24 hours. UPS is the method of shipping unless otherwise specified. Domestic UPS Ground is approximately 1-4 business days, depending on your location. Faster service is available (See Pg 2).

Payment Policy

Orders can be prepaid by Mastercard, Visa, Discover credit/debit cards. Cancelled orders can be subject up to a 15% cancellation fee.

Freight & Shipping

All shipments are shipped freight prepaid unless other arrangements are made. All shipments are fully insured. If your shipment is damaged, save all packaging material and contact the freight carrier immediately.

Returns

A copy of the original invoice must accompany all returns within 30 days of the original purchase date. No reasonable return will be refused, however we reserve the right to apply up to a 15% restocking fee.

Shortages or Discrepancies

All shortages or discrepancies must be reported within 10 days from receipt of shipment. Please include invoice number and date of receipt.

Warranty

Most products carry the manufactures warranty. Good Vibrations Motorsports will not be held liable for any loss, damage, injury or casualty arising from the use of products supplied by Good Vibrations. Not for sale or use on pollution controlled vehicles

Prices & Specifications

All prices are subject to state sales taxes where applicable.
All prices are subject to change without notice.

Not for sale or use on pollution controlled vehicles

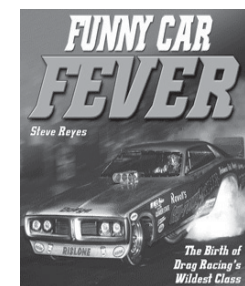
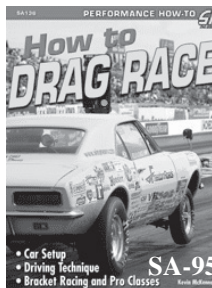
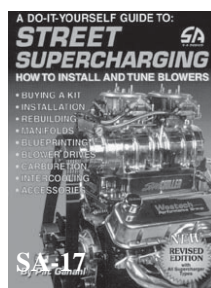

2 Great Books for the Coffee Table, Office or where ever you do your best reading! Rich in History with 100's of Color Pics.

- FC Fever** **Slingshots**
- SA-CT443** **SA-CT464**



\$25

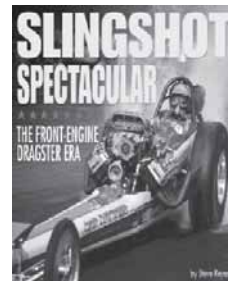

Performance Books

Books are 128 pages.
Feature 300 photos!

- SA-78 BUILD PERF PONTIAC**
 - SA-85 BUILD BIG INCH SBF**
 - SA-87 BUILD BIG INCH SBC**
 - SA-104 BIG INCH SB Mopar**
- Above Titles **\$16.95**

- SA-17 Street Supercharging \$19.95**
- SA-104 Big Inch SB Mopar \$19.95**
- SA-161 Electronic Fuel Injection \$25**
- SA-95 How To DRAG RACE \$25**

Limited Edition T-Shirt

\$12

Good Vibrations (Rear)

Enderle (Front)

Silkscreened 6 Colors

100% Pre-shrunk

USA Cotton

S-3XL



Hats & Shop Aprons

High Quality
Embroidery.
Velcro Closure.
Full Color.



Hats \$12



Aprons \$18

Shotgun Carb Scoop



Pg 17



Magneto & Pump Front Drive



Pg 42

Pg 28



Valve Adjuster

Pg 29



Spark Plug Torque Wrench

Pg 3



Small 4 3/8 Big & Ugly

New Products!!

Injection Primer Kit



Pg 7

Pg 44



Hats & Aprons !!



HEMI Valve Covers

Pg 9

Pg 37



Jesel Belt Drive



Pg 30

Steel Spindles

Pg 42



Magneto Front Drive

Instant \$10 off First Web Order!

Coupon Code: 8999

Our Mission:

At *DragParts.com*, we strive to provide high quality performance products at discount prices without sacrificing customer service.

GOOD VIBRATIONS

8858 Painter Ave, Suite E
Whittier, CA 90602

PRSR STD
US Postage
PAID
Whittier, CA
Permit #243



Proudly Made
in the USA

Since 1985

New Racing Products
Used Performance Parts
Free Technical Advice
Free Racing Classifieds



We STOCK these
Quality Brands



Online 24/7

GoodVibrationsRacing.com

New & Preowned Performance Products

Toll Free (800) 576-7661