

Hammer Lug Unions

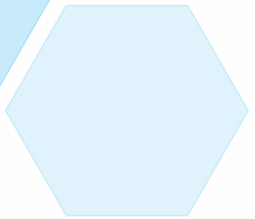
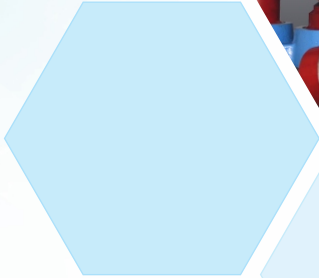
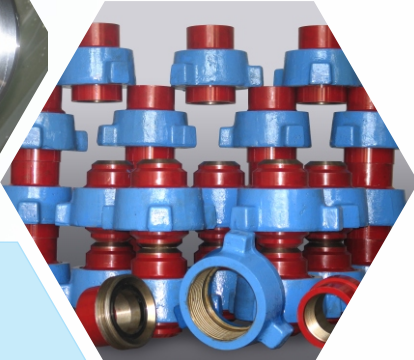
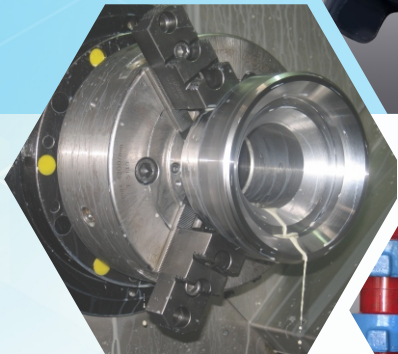

Specifications

Fig No.	Color key for standard service	Pressure Rating (psi)				Nominal Pipe Sizes inches/mm									
		Standard Service		Sour Gas Service		1	1 ¼	1 ½	2	2 ½	3	4	5	6	8
		Cold Working	TEST	Cold Working	TEST	25	32	40	50	65	80	100	125	150	200
50		500	750	N/A	N/A										
100		1,000	1,500	N/A	N/A										
200		2,000	3,000	2,000	3,000										
206		2,000	3,000	2,000	3,000										
207		2,000	3,000	2,000	3,000										
600		6,000	9,000	N/A	N/A										
602		6,000	9,000	6,000	9,000										
1002		10,000	15,000	7,500	11,250										
1003		10,000	15,000	7,500	11,250										
1004		10,000	15,000	7,500	11,250										
1502		15,000	22,500	10,000	15,000										
2002		20,000	30,000	N/A	N/A										
2202		N/A	N/A	15,000	22,500										

Hammer Lug Union

Figure 50 500 psi cwp (35 bar)

The suction and low pressure Figure 50 is manufactured from steel throughout and is available Threaded or Socket Weld in 4 inch or 5 inch sizes. The same nut and 'O' ring are used in both sizes, male and female blanking caps are also available.

The Figure 50 is so named because it is designed to withstand 500 psi cold working pressure (35 bar).

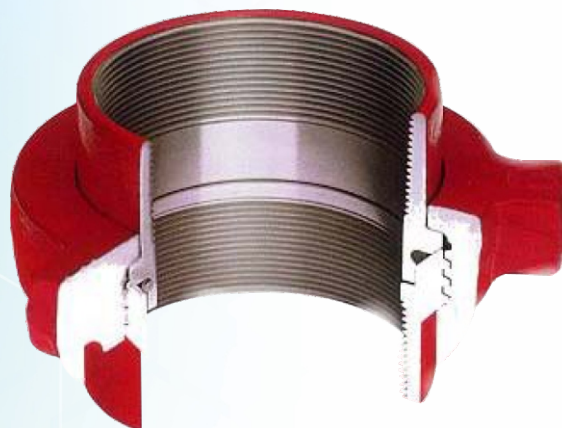
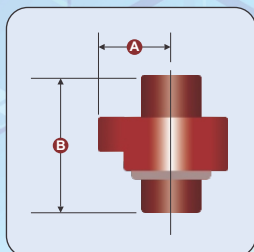

Line Pipe Thread					Socket Weld		
Size Inch	Weight (lbs)	Mass (Kg)	Nut Radius A	Total Length B	Weight (lbs)	Mass (Kg)	Total Length B
4"	27.5	12.5	5.13"	6.00"	26.0	11.8	4.06"
5"	22.0	10	5.13"	5.62"	20.5	9.3	4.06"

Note : Where dimensions and weight are critical please consult the factory

Figure 100 1000 psi cwp (69 bar)

A low pressure general purpose threaded union suitable for air, water oil or gas service. Fig 100 unions are manufactured from steel, not cast iron. This has enabled us to reduce the weight and physical dimensions, at the same time retaining interchangeability with our competitors interior brands.

The Figure 100 gets its name from its ability to withstand 1,000 psi cwp (69 bar)



Line Pipe Thread					
Size Inch Diameter	Weight (lbs)	Mass (Kg)	Nut Radius A	Total Length B	Body C
2"	4.8	2.2	2.88"	3.23"	2.75"
2 1/2"	10.0	4.5	3.50"	4.25"	3.38"
3"	16.5	7.5	4.06	4.56"	4.12
4"	23.0	10.5	4.56"	4.83"	5.12"
5"	32.5	14.8	5.75"	6.00"	6.38"
6"	47.5	21.6	6.50"	6.84"	7.38"
8"	66.0	30	7.25"	7.19"	9.56"

Note : Where dimensions and weight are critical please consult the factory

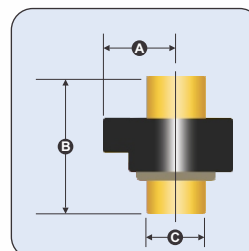

Hammer Lug Union

Figure 200 2,000 psi cwp (138 bar)

A general purpose, all steel constructed union designed to meet a variety of applications up to and including service at 2000 pounds per square inch. The Figure 200 is a compact and economical union, available with Threaded and ButtWeld ends.

Line Pipe Thread					
Size Inch Diameter	Weight (lbs)	Mass (Kg)	Nut Radius A	Total Length B	Body C
1"	1.7	0.8	2.00"	2.48"	1.59"
1 ¼"	2.2	1.0	2.25"	2.78"	2.00"
1 ½"	2.7	1.2	2.44"	2.90"	2.28"
2"	4.8	2.2	2.88"	3.19"	2.75"
2 ½"	8.4	3.8	3.50"	4.12"	3.31"
3"	14.8	6.7	3.88"	4.59"	4.09"
4"	18.2	8.3	4.50"	4.94"	5.12"
5"	32.5	14.8	5.75"	6.00"	6.38"
6"	47.5	21.6	6.50"	6.84"	7.38"
8"	66.0	30	7.25"	7.19"	9.56"

Note : Where dimensions and weight are critical please consult the factory

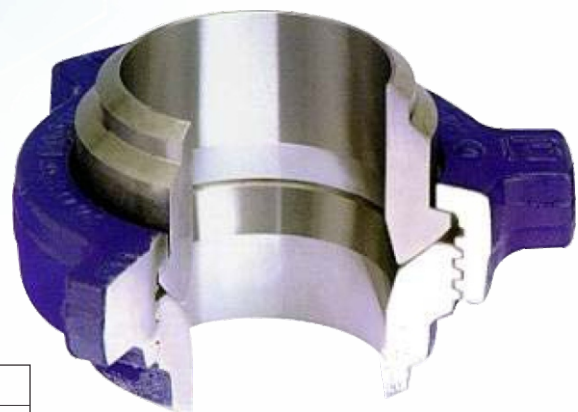
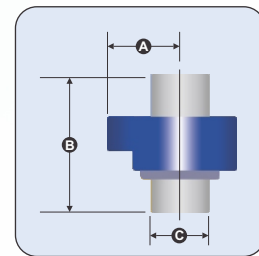
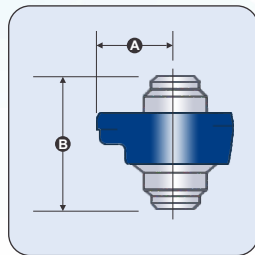

Butt Weld Sch 40					Butt Weld SCH 80		
Size Inch	Weight (lbs)	Mass (Kg)	Nut Radius A	Total Length B	Weight (lbs)	Mass (Kg)	Total Length B
2"	5.4	2.5	2.88"	3.15"	5.7	2.6	3.25"
3"	11.8	5.7	3.88"	4.00"	12.4	5.6	4.14"
4"	14.8	6.7	4.50"	4.82"	16.0	7.3	4.98"
5"	35.2	14.8	5.75"	6.00"	37.5	17.0	6.17"
6"	47.8	21.7	6.50"	5.82"	51.2	23.3	6.06"
8"	68.5	31.1	7.25"	6.91"	74.5	33.9	7.19"

Note : Where dimensions and weight are critical please consult the factory

Figure 206 2,000 psi cwp (138 bar)

The Figure 206 is the Figure 200 with a secondary seal to supplement the metal-to-metal ball and cone seat.

All dimensions and weights are the same as for the Figure 200 range of unions.



Hammer Lug Union

Figure 207 2,000 psi cwp (138 bar)

Figure 207 Blanking Caps and unions are fully interchangeable with Figure 200 and 206 unions. For use where the blanking off at the end of a line is desirable. The cap is fitted with 'O' ring to ensure a leakproof seal.

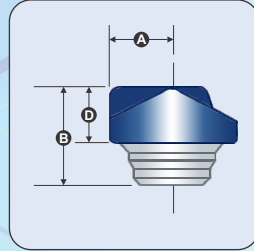
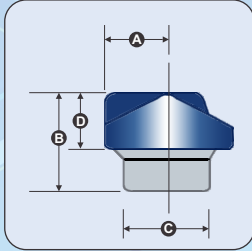

Size Inch	Butt Weld Sch 40						Butt Weld SCH 80		
	Weight (lbs)	Mass (Kg)	Nut Radius A	Total Length B	Body Diameter C	Cap Height D	Weight (lbs)	Mass (Kg)	Total Length
3"	9.9	4.5	2.88"	3.69"	4.09"	2.38"	8.8	4	3.56"
4"	20.6	9.4	3.66"	4.31"	5.12"	2.63"	21.8	9.0	4.35"
6"	44.8	20.4	5.00"	5.60"	7.38"	3.19"	46.3	6.17	4.25"

Note : Where dimensions and weight are critical please consult the factory

Figure 600 6000 psi cwp (414 bar)

The Figure 600 designed to easily perform at 6000 psi (414 bar).

It is a bronze seated union designed to **combat rust and corrosion** on lines where a metal-to-metal seal is desirable and condensation is a problem.

The Figure 600 is ideal for steam service

Line Pipe Thread					
Size Inch	Weight (lbs)	Mass (Kg)	Nut Radius A	Total Length B	Body Diameter C
1"	3.8	1.7	2.25"	3.56"	1.75"
2"	14.5	6.6	3.50"	6.41"	3.00"
3"	29.0	13.2	4.50"	8.75"	4.19"
4"	40.0	18.2	4.94"	10.06"	5.25"

Note : Where dimensions and weight are critical please consult the factory

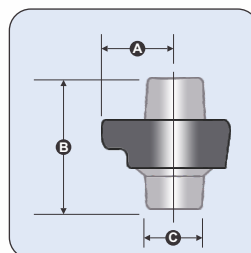

Hammer Lug Union

Figure 602 6,000 psi cwp (414 bar)

The Figure 602 is designed for pressure up to 6,000 pounds per square inch, that's 414 bar, but tests have taken it much higher!

Scroll down to see individual tables for both Threaded and Butt Weld Figure 602 Unions



Line Pipe Thread					
Size Inch	Weight (lbs)	Mass (Kg)	Nut Radius A	Total Length B	Body Diameter C
1"	4.0	1.8	2.25"	3.52"	1.75"
1.1/2"	9.0	4.1	3.00"	4.88"	2.56"
2"	13.5	6.1	3.50"	5.25"	3.06"
3"	21.5	9.8	4.50"	6.19"	4.20"
4"	34.0	15.5	4.94"	8.19"	5.30"

Note : Where dimensions and weight are critical please consult the factory

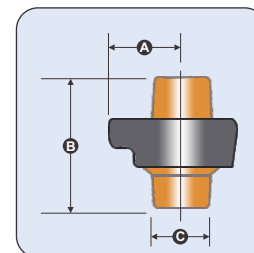

BUTT WELD FIGURE 602 / 602-LC / 602-18

We also produce three types of Butt Weld Figure 602 Unions to suit particular applications. The standard type being manufactured from (subs) AISI 4130, a low carbon type from ASTMA350 LF2 and a high tech, high strength, low carbon type from modified A350 LF2.

The standard AISI 4130 Fig 602 is a fully rated union manufactured for welding to pipe sections up to Sch XXS. Available in Sour Gas or Standard Service trim.

The low carbon A350 LF2 union is specifically designed for welding to ASTM A106 Grade B or ASTM A333 Grade 6 tubulars of Sch 80 section. This has become a favorite with the well test companies as it is a low cost, readily available union, for use with pipework that is not required to function above the recommended pressures as set out in API RP 14E which, in turn, is based on the allowable stress values in ANSI/ASME B31.3. These unions are available in 2" and 3" sizes only.

The high tech, high strength Figure 602-18 union is manufactured from low carbon steel forgings that retain ductility at high strength. These unions are readily weldable and are available in 2 inch, 3 inch and 4 inch sizes with pipe sections up to and including Sch.XXS. Depending upon wall section and pipe used, this union can be fully rated at 6,000 psi cwp. When inquiring or placing an order for any of the Butt Weld Figure 602 unions described above, refer to them as follows:



The Standard Union (Sour or Standard Service) - Fig.602 Butt Weld

The Low Carbon A350 LF2 Type - Fig.602-LC Butt Weld

The High Tech, High Strength - Fig. 602-18 Butt Weld

(The LC refers to low carbon and the -18 to the last two digits of our special steel forging specification.)

Line Pipe Thread					Butt Weld XXS		
Size Inch	Weight (lbs)	Mass (Kg)	Nut Radius A	Total Length B	Weight (lbs)	Mass (Kg)	Total Length B
1"	3.0	1.4	2.25"	3.25"	4.0	1.8	3.53"
2"	12.5	5.7	3.50"	4.68"	14.5	6.6	5.02"
3"	22.0	10	4.50"	4.90"	24.5	11.1	5.35"
4"	29.2	13.3	4.94"	5.27"	33.7	15.3	5.79"

Note : Where dimensions and weight are critical please consult the factory

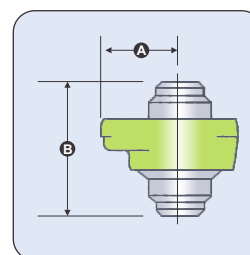

Hammer Lug Union

Figure 1002 10,000 psi cwp (690 bar) 1-4"
7,500 psi cwp (483 bar) 5-6"

The Figure 1002 union is a high pressure low alloy steel union fitted with a replaceable elastomer seal ring.

In sizes between 1 and 4" the figure 1002 is designed for 10,000 psi, at sizes of 5" and 6" it covers a respectable 7,500 psi. The 1 inch through to 4 inch sizes have lip type seals and the 5 inch and 6 inch utilize 'O' rings. The 5 inch and 6 inch are available in Butt Weld only.

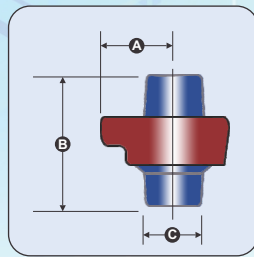
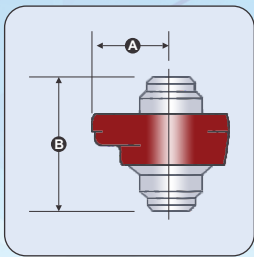
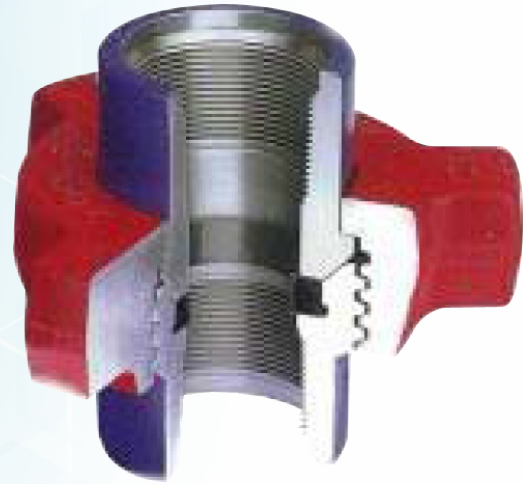

Size Inch	Line Pipe Thread					Butt Weld XXS		
	Weight (lbs)	Mass (Kg)	Nut Radius A	Total Length B	Body Diameter C	Weight (lbs)	Mass (Kg)	Total Length B
1"	4.0	1.8	2.25"	3.52"	1.75"	4.0	1.8	3.53"
2"	13.5	6.1	3.50"	5.25"	3.06"	14.5	6.6	5.02"
3"	21.5	9.8	4.50"	6.19"	4.20"	24.5	11.1	5.35"
4"	34.0	15.5	4.94"	8.19"	5.30"	33.7	15.3	5.79"
5"	-	-	6.00"	-	-	59.4	27	6.19"
6"	-	-	7.25"	-	-	85.8	39	6.55"

Note : Where dimensions and weight are critical please consult the factory

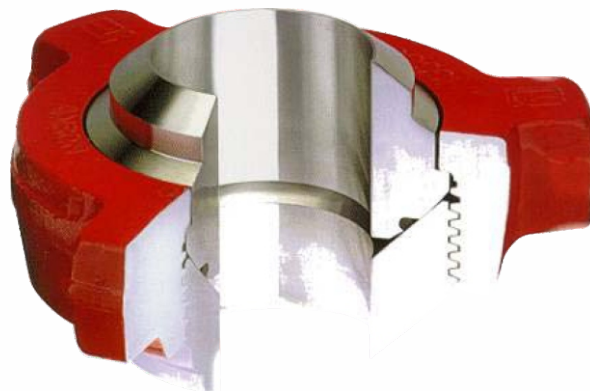

Hammer Lug Union

Figure 1003 10,000 psi cwp (690 bar) 2-3"
7,500 psi cwp (483 bar) 4-5"

The Figure 1003 Unions are misaligned types and will allow for a misalignment of up to 701/2° off the center line, 15° included. The exception is the 2 inch which has an included maximum of 7° or 3.1/2° off the center line. Available as Line Pipe Threaded or Butt Weld with 5 inch unions available Butt Weld only. Both 2 and 3 inch allow for 10,000 psi cwp (690 bar), the 4 and 5 inch sizes allow for 7,500 psi cwp (483 bar).

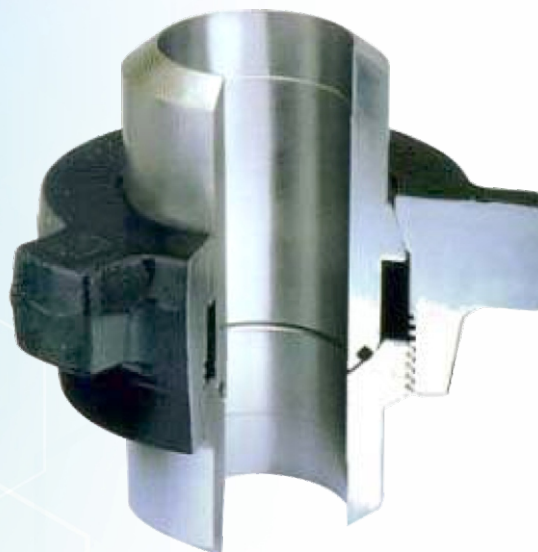
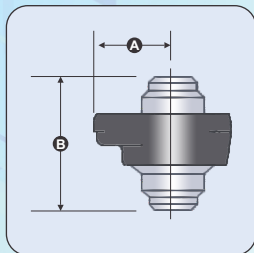
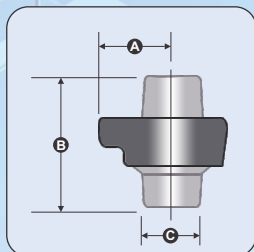

Line Pipe Thread						Butt Weld XXS		
Size Inch	Weight (lbs)	Mass (Kg)	Nut Radius A	Total Length B	Body Diameter C	Weight (lbs)	Mass (Kg)	Total Length B
2"	12.4	5.6	3.50"	4.73"	3.06"	13.2	6.0	4.73"
3"	43.0	19.5	4.88"	9.12"	4.45"	44.3	20.1	9.12"
4"	78.4	35.6	6.00"	11.00"	5.50"	81.2	36.9	11.00"
5"	-	-	6.00"	-	-	80.0	36.4	10.95"

Note : Where dimensions and weight are critical please consult the factory

Figure 1000 10,000 psi cwp (690 bar)

The 5 inch and 6 inch Figure 1002 Unions utilize elastomer 'o' rings for sealing purposes. This type of union must be made up perfectly square and if not it can be troublesome. To improve matters we have introduced two new sizes of Butt Weld Unions that utilize lip type elastomer seals similar to those fitted into the smaller unions. We have called them "Figure 1004". They are available in Standard Service or Sour Gas trim.

Line Pipe Thread				
Size Inch	Weight (lbs)	Mass (Kg)	Nut Radius A	Total Length B
5"	85.0	38.6	6.0"	8.25"
6"	140.0	63.6	7.25"	9.38"

Note : Where dimensions and weight are critical please consult the factory

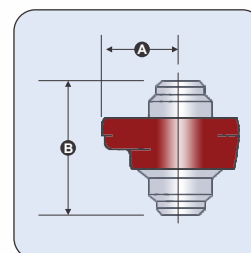
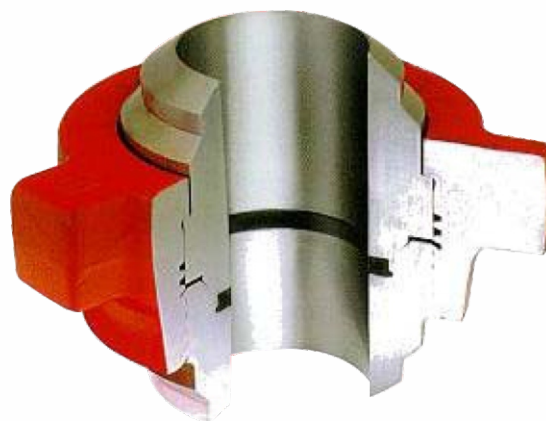

Hammer Lug Union

Figure 1502 15,000 psi cwp (103^s bar)

With the ability to superbly handle 15,000 psi cwp, the Fig.1502 Union is probably the most widely used end connection of the hammer union family. It is used in a wide range of applications due to its rugged construction.

The figure 1502 is available with Line Pipe Threads or Butt Weld ends, in standard or Sour Gas trim. we have introduced a 5 inch and 6 inch Figure 1502 (Butt Weld only) for those applications where modern demands are calling for greater flow rates at high pressure.

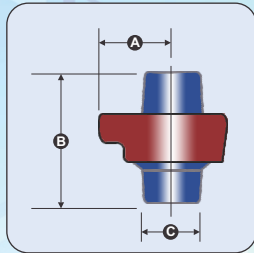

Size Inch	Line Pipe Thread					Butt Weld XXS		
	Weight (lbs)	Mass (Kg)	Nut Radius A	Total Length B	Body Diameter C	Weight (lbs)	Mass (Kg)	Total Length B
1"	8.4	3.8	2.70"	4.36"	2.17"	8.2	3.7	4.36"
1.1/2"	16.4	7.5	3.63"	5.38"	2.97"	16.5	7.5	16.5"
2"	18.5	8.4	3.75"	7.04"	3.22"	2.10	9.5	21.0"
3"	31.0	14.1	4.57"	7.63"	4.50"	28.5	13.0	28.5"
4"	-	-	6.00"	-	-	75.0	-	75.0"
5"	-	-	6.50"	-	-	95.0	-	95.0"
6"	-	-	7.25"	-	-	145.0	-	145.0"

Note : Where dimensions and weight are critical please consult the factory

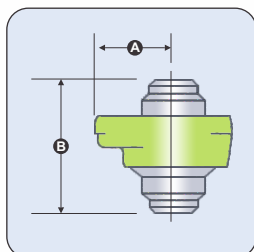

Hammer Lug Union

Figure 2002 20,000 psi cwp (1380 bar) SS
15,000 psi cwp (103^s bar) SG

Standard Service Figure 2002 Unions are manufactured throughout from the finest of steels selected to give the ultimate in performance. Lip type elastomer seals with anti-extrusion rings are supplied with this union. Available Butt Weld only.

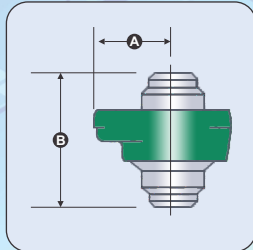

Size Inch	Butt Weld (Not Threaded)				Weld Prep	
	Weight (lbs)	Mass (Kg)	Nut Radius A	Total Length B	O/D	I.D
2"	23.0	10.5	3.75"	7.40"	2.50"	1.25"
3"*	48.0	21.8	4.88"	9.56"	4.125"	2.06"
4"*	76.0	34.5	6.00"	8.50"	5.20"	3.00"
5"	110.0	50	6.50"	10.75"	6.12"	4.00"
6"	170.0	77.3	7.25"	13.00"	7.75"	5.00"

Note : Where dimensions and weight are critical please consult the factory. Weight indicated is for the weld prep shown. Differing OD and ID preps can be supplied upon request.

*3" and *4" Unions are sometimes referred to as 2.1/2" and 3" respectively by other manufacturers.

Figure 2202 15,000 psi cwp

The Figure 2202 Sour Gas Union is ruggedly proportioned and manufactured to the highest quality standards to ensure safety and reliability in service. Lip type elastomer seals with stainless steel anti-extrusion rings are fitted as standard. All H₂S Service Unions manufactured by Anson are subjected to vigorous examination to ensure the latest requirements of N.A.C.E. are adhered to and the product is fit for purpose. Anson are active members of the National Association of Corrosion Engineers. (NACE)

