

SERVICE MANUAL

M O D E L S :

**INCLUDING
PARTS LIST**

**A,
A-100
AB, BA, BC,
BCV, BV, B2, B3,
C, CV, C2, C-2G, C3,
D, DV, D-100, E, G,
GV, RT, RT-2, RT-3**

H000-000495

CAUTION

SEE SAFETY NOTICE ON
INSIDE COVER SHEET

SAFETY NOTICE

Great care has been taken in the design and manufacture of this product to assure that no shock hazard exists on any exposed metal parts. Internal service operations can expose the technician to hazardous line voltages and accidentally cause these voltages to appear on exposed metal parts during repair or reassembly of product components. To prevent this, work on these products should only be performed by those who are thoroughly familiar with the precautions necessary when working on this type of equipment.

To protect the user, it is required that all enclosure parts and safety interlocks be restored to their original condition and the following tests be performed before returning the product to the owner after any service operation.

Plug the AC line cord directly into a line voltage AC receptacle (do not use an isolation transformer for this test) and turn the product on. Connect the network (as shown below) in series with all exposed metal parts and a known earth ground such as a water pipe or conduit. Use an AC VOM of 5,000 ohms per volt or higher sensitivity to measure the voltage drop across the network. Move the network connection to each exposed metal part (metal chassis, screw heads, knobs and control shafts, enclosure, etc.) and measure the voltage drop across the network. Reverse the line plug and repeat the measurements. Any reading of 4 volts RMS or more is excessive and indicates a potential shock hazard which must be corrected before returning the product to the user.

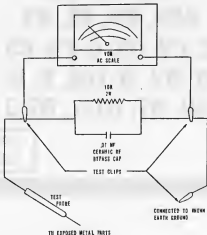

SECTION I	PAGE
GENERAL - A BRIEF DESCRIPTION AND SOME ILLUSTRATIONS OF THE FOLLOWING MODEL ORGANS AND TONE CABINETS	
ORGANS	PAGE
Models - A, AB	1-1
Models - 6C, 6V, 6CV, 8-2 & 83	1-1
Model BA (Full Player Organ)	1-2
Models C, CV, C-2, C-3, D & 6V	1-2
Models G, C-2, 2S, C-2S Console & G-40, NR-40G Tone Cabinets	1-3
Model E (Concert Model)	1-3
Models RT, RT-2, & RT-3	1-4
Models A-100, G-100	1-4A
TONE CABINETS	
Model A-20	1-5
Model A-40	1-6
Model G-40	1-6
Model C-20	1-6
Model C-40	1-7
Model G-20	1-7
Model ER-20	1-8
Model F-40	1-8
Models H-40, HR-40, X-40, XR-40	1-8
Model JR-20	1-8
Model PR-20	1-10
Model P-40, D-40	1-10
Model PR-40, DR-40	1-11
THEORY OF OPERATION	1-13
Description	1-13
Presets Keys	1-14
Pedal Tone Pistons (Model E Console)	1-15
Pedal Solo Unit Models RT, RT-2, RT-3 & G-100	1-18
Echo Switch	1-18
Transmitt	1-17
Percussion	1-17
Tone Generator	1-18
Tone Cabinets	1-18
Rotor Transmitt	1-18
Power Amplifier	1-19
Reverberation System	1-19
SECTION II - INSTALLATION, MAINTENANCE AND TECHNICAL INFORMATION	
ACOUSTICS	2-1
General Installation	2-1
Reverberation	2-2
INSTALLATION & MAINTENANCE	
CABLES	2-4
Block Diagrams	2-4
Wiring Diagrams	2-5
Block Diagrams (Figures 1 thru 11)	Thru 2-6
MAIN GENERATOR (FIGURE 1)	
81 Frequency Generator	2-8
82 Frequency Generator	2-11
Model M Generator	2-12
Generator Illustrations (Figure 2 thru 8)	2-12
CHORUS GENERATOR	
Models 6C, D, E, & G Illustrations (Figure 1 thru 3)	2-14
CONSOLE POWER WIRING	
Minor Circuits (Figure 1)	2-15
Run Switches (Figure 2)	2-18
Side Panel (Figure 3 & 4)	2-18
MANUALS & PEDALS	
Manual Assembly (Figure 1)	2-17
Manual Chassis Models A, AV, B, BA, 6C, E, CV, G, 6V, RT	2-17
Key Contact Spring (Figure 2)	2-17
Manual Contacts (Figure 3)	2-17
Manual Chassis Models E-2, C-2, RT-2	2-18
Models E-3, C-3, RT-3, A-100, G-100	2-18
Model E	2-18
Manual Wiring Models A, AV, B, BA, 6C, 6CV, E, CV, G, 6V, E, & 6V, RT	2-19
Models E-2, B-3, C-2, D-3, RT-2, RT-3, A-100, G-100	2-19
Model M Series	2-19
Key & Frequency Chart (Figure 4)	2-19
Pedal Switch Assembly (Figure 5)	2-20
Pedal Circuits (Figure 8 thru 12)	2-21
	thru 2-22
Pedal Switch Assembly RT-1,2,3 & G-100	2-22A
Pedal Circuits	2-22B
Pedal Keyboard	2-22C
Models RT, RT-2, RT-3 & G-100	2-23
Model E	2-23
Pedal & Frequency Chart (Figure 13)	2-23
Pedal Keyboard (Figure 14)	2-24
PRESET PANELS	
Model A, AV, B, BA, 6C, 6CV, 6V, E, CV, G, 6V, E, 6V, RT	2-24
Models D-2, B-3, C-2, D-3, RT-2, RT-3, A-100, G-100, E	2-24
Charts (Figure 15)	2-25
Matching Transformers	2-25
Presets Keys	2-25
Presets Credits (Figure 16)	2-26
TREMULANT	2-27
Models A, AB, 6C, C, G, & B	2-27
Model E	2-27
SHOUSTAT BOX	2-27
Receptor Circuits (Figure 1 thru 6)	2-28
	thru 2-31
VIBRATO	
Vibrato Diagram (Figure 1)	2-32
Use Box (Figures 2 & 3)	2-33
Vibrato Switch (Figure 4)	2-34
Scanner (Figure 5)	2-34
Model M	2-34
Schematics (Figure 6 thru 8)	2-35
	2-38
PERCUSSION	2-37
Operation	2-37
Percussion Cut-Off	2-38
REVERBERATION	
Fixed Type	2-39
Illustrations (Figure 1 & 2)	2-40
Filing & Adjustment	2-41
Dry Type	2-42
PR & OR Tone Cabinets Installation of PR & OR Tone Cabinets	2-43
Service Suggestions	2-44
Earlier Tone Cabinets	2-44
Self-Contained Units	2-44

ECRD EQUIPMENT	2-45
Echo Organ Kit	
Block Diagrams (Figure 1 & 2)	2-45
Install Kit in	
Model E	2-48
Early Model B & BC	2-47
Model A	2-47
Wiring of Echo Kit (Figure 5 A & B)	2-48
Carphones	2-48

SECTION III

LIST OF ILLUSTRATION AND INDEX	3-1
Models A, B, BC, C, & D	3-2
Wiring Diagram (Figure 15)	3-2
Schematic (Figure 16)	3-3
Model A-100	3-58
Schematic (Figure 30)	3-58
Wiring Diagram (Figure 31)	3-60
Model BV, CV	3-4
Wiring Diagram (Figure 17)	3-4
Schematic (Figure 18)	3-5
Model C-20	3-8
Wiring Diagram	3-8
Schematic	3-7
Models G2 & C2	3-8
Wiring Diagram (Figure 20)	3-8
Wiring Diagram (Figure 20A)	3-9
Schematic (Figure 21)	3-10
Models G-3 & C-3	3-11
Wiring Diagram (Figure 23)	3-11
Schematic (Figure 24)	3-12
Model G-100	3-66
Schematic (Figure 33)	3-66
Wiring Diagram (Figure 35)	3-67
Model E	3-18
Wiring Diagram (Sheet 1)	3-18
Wiring Diagram (Sheet 2)	3-18
Model RT	3-13
Wiring Diagram (Figure 19)	3-13
Schematic (BV, BC, & RT) (Figure 18)	
SEE PAGE	3-5
Model RT-2	3-14
Wiring Diagram (Figure 22)	3-14
Wiring Diagram (Figure 22A)	3-14
Schematic (B-2, C-2, & RT-2)	
SEE PAGE (Figure 21)	3-10
Model RT-3	3-18
Wiring Diagram (Figure 25A)	3-18
Schematic (B-3, C-3, & RT-3)	
SEE PAGE (Figure 24)	3-12

PEDAL SOLO UNIT

General	3-21
Wiring Diagrams	3-22
Tuning	3-23
Block Diagrams (Figure 1 & 10)	3-24
Model RT Schematic	3-25
Model RT-2 Schematic	3-26
Tube Voltages	3-28
Service Suggestions	3-28
Removing Parts	3-30
Parts List	3-31
Wiring Diagrams Pedal Solo Generator	3-31
(Figure 4, 4B, & 4C)	3-32

AMPLIFICATION SYSTEM

Pre-Amplifier Schematics	
Model A (Figure 1)	3-35
Models A & B (Figure 2 & 3)	3-38
Models A, B, C, D, Flyer & G	
(Figure 4 & 5)	3-37
Models BV, CV, BCV, CX, DV & RT	
(Figure 6)	3-38
Model E (Figure 7)	3-38
Model E (Figure 8 & 9)	3-38

POWER AMPLIFIER SCHEMATICS (USED IN TONE CABINETS)

Models A-20, A-40, B-40, C-40 (Figure 10)	3-40
Models A-25, A-40, B-40, C-40, D-20,	
OR-20, G, GX-20 (Figure 11)	3-40
Models G-20, OR-20, B-40, ER-20,	
FR-20, F-40 (Figure 12)	3-41
Models G-20, F-40, FR-40 (Figure 13)	3-41
Models OR-20, ER-20, FR-40 (Figure 14)	3-42
Models H-40, HR-40 (Figure 15)	3-42
Models H-40, HR-40 (Figure 16)	3-43

REVERB PRE-AMPLIFIERS SCHEMATICS

Models OR-20, ER-20 (Figure 17)	3-44
Models OR-20, ER-20, FR-40 (Figure 18)	3-45

POWER AMPLIFIER SCHEMATIC (USED IN TONE CABINETS)

MODELS H-40, HR-40 (Figure 15)	3-48
Models H-40, HR-40 (Figure 16)	3-47

PRE-AMPLIFIER SCHEMATICS

Models B-2, C-2, RT-2 (Figure 20)	3-47
Models B-2, D-2, RT-2 (Figure 20A)	3-47

POWER AMPLIFIERS SCHEMATICS (USED IN TONE CABINETS)

Model JR-20 (Figure 22)	3-48
Model JR-20 (Figure 22A)	3-48
Model JR-20 (Figure 22B)	3-48

PRE-AMPLIFIERS SCHEMATICS

Models B-3, C-3, RT-3 (Figure 24)	3-50
-----------------------------------------	------

POWER AMPLIFIERS SCHEMATICS (USED IN TONE CABINETS)

Models PR-40, OR-40 (Figure 26)	3-50
Models PR-20 (Figure 28)	3-51

TONE CABINETS

Models PR-40, OR-40	3-52
Models PR-40, OR-40 (Figure 26A)	
Schematic	3-53
Models PR-40, OR-40 (Figure 27A)	
Schematic later units	3-54
Models P-40, G-40	3-55
Models P-40, G-40 (Figure 25)	
Schematic	3-58
Model PR-20	3-57
Model PR-20 Schematic	3-58

POWER AMPLIFIERS (USED IN CONSOLES)

MODEL A-100	3-61
Schematic (Figure 32)	3-61
Wiring Diagram (Figure 33)	3-62
Model G-100 (Figure 36)	3-68

REGENERATION AMPLIFIERS (USED IN CONSOLES)

Model A-100 (Figure 34)	3-63
(Figure 35)	3-64
(Figure 35A)	3-65

TROUBLE LOCATION

Trouble Shooting	3-69
Sectionalizing Trouble	3-75
Trouble Shooting Chart	3-80
Repair & Disassembly of Vibrato Scanner	3-82

SECTION IV - ALIGNMENT PROCEDURES

Power Panel Tone Selection	4-1
Alignment of Coil Assemblies	4-1
Adjustment of Percussion Cut-Off Control	4-4
Adjustment of Intermittent or Non-Opening Keys	4-4

SECTION V - STAGE DATA AND FINAL TESTING

Detailed Theory of Operation	5-1
Replacement of Components	5-9

SECTION VI - PARTS LIST

B-3, G-3	6-1
Unique Parts for Other Models Listed	6-5
in Service Manual	6-23
Tone Cabinets (PR-40, etc.)	6-31

MODELS A & AB: (IN PRODUCTION JUNE 1935 TO OCTOBER 1938).

CABINET SIZE: 48-1/2" WIDE, 47" HIGH, 38-1/2" DEEP.

FINISH: AMERICAN WALNUT

MANUALS: SMALL AND GREAT, 61 PLAYING KEYS EACH.

PEDAL KEYBOARD: 25-NOTE, RADIATING, DETACHABLE.

TONAL CONTROLS: 9 PRESS KEYS AND 2 SETS OF 9 ADJUSTABLE HARMONIC DRAWERS FOR EACH MANUAL; 2 ADJUSTABLE DRAWERS (16" AND 8") FOR PEDALS.

EXPRESSION: ONE EXPRESSION PEDAL CONTROLLING SMALL, GREAT, AND PEDALS.

FEATURES: ONE TONE GENERATOR, ONE ADJUSTABLE TREMBLANT AFFECTING BOTH MANUALS AND PEDALS EQUALLY.

AC INPUT: APPROX. 30 WATTS, PLUS WATTAGE REQUIRED BY TONE CABINETS.

WEIGHT: AS ILLUSTRATED, APPROX. 350 POUNDS.

SERIAL NO. 2501 AND ABOVE USED LARGER WOODWORK CASE DESIGNATED AS AB.

SEE B SERIES FOR CASE DIMENSIONS AND WEIGHT.

MODEL AB: SAME AS MODEL A BUT ENCLOSED IN LARGER WOODWORK. ONE TONE GENERATOR, ONE ADJUSTABLE TREMBLANT AFFECTING BOTH MANUALS AND PEDALS EQUALLY.

CABINET SIZE: WITH PEDAL KEYBOARD AND BENCH: 48-3/4" WIDE, 49-1/2" DEEP, 46" HIGH.

MODEL BC: (IN PRODUCTION DECEMBER 1936 TO NOVEMBER 1942). SAME AS MODEL AB BUT WITH ONE ADDITIONAL GENERATOR AND APPROPRIATE SWITCHING TO CREATE CHORUS EFFECT.

FINISH: WALNUT.

MODEL BV: (IN PRODUCTION APRIL 1945 TO DECEMBER 1949). SAME AS MODEL B BUT EQUIPPED WITH HARMOND VIBRATO PROVIDING THREE DEGREES OF TRUE VIBRATO AND "OFF" POSITION, EFFECTIVE SIMULTANEOUSLY ON BOTH MANUALS, TOGETHER WITH VIBRATO CHORUS USABLE IN THREE DIFFERENT DEGREES AND "OFF".

FINISH: WALNUT.

MODEL BCV: (IN PRODUCTION DECEMBER 1949 TO DECEMBER 1954). SAME AS MODEL BC BUT HAS HARMOND VIBRATO AND VIBRATO CHORUS. NONE PRODUCED. CONVERTED BY VIBRATO KIT ADDED AFTER 1945.

MODEL B-2: SAME AS MODEL BV BUT WITH CONTROLS WHICH PROVIDE VIBRATO ON EITHER OR BOTH MANUALS. ALSO ADDITIONAL CONTROL FOR "NORMAL" OR "SOFT" OVERALL SOUND.

(IN PRODUCTION DECEMBER 1949 TO DECEMBER 1954)
FINISH: WALNUT.

MODEL B-3: (IN PRODUCTION JANUARY 1955 TO) SAME AS MODEL B-2 BUT WITH HARMOND PERCUSSION FEATURE.

FINISH: WALNUT-CHERRY.

MANUALS: SMALL AND GREAT, 61 PLAYING KEYS EACH.

PEDAL KEYBOARD: 25-NOTE RADIATING, DETACHABLE.

TONAL CONTROLS: 9 PRESS KEYS AND 2 SETS OF 9 ADJUSTABLE HARMONIC DRAWERS FOR EACH MANUAL. 2 ADJUSTABLE DRAWERS (16" AND 8") FOR PEDALS.

EXPRESSION: ONE EXPRESSION PEDAL CONTROLLING SMALL, GREAT AND PEDALS.

AC INPUT: APPROXIMATELY 30 TO 50 WATTS, PLUS WATTAGE REQUIRED BY TONE CABINETS.

WEIGHT: AS ILLUSTRATED, APPROXIMATELY 425 LBS



MODEL A - AB



HOME MODELS BC, BV, BCV, B-2, AND B-3

(IN PRODUCTION JANUARY 1938 TO DECEMBER 1938).

THIS INSTRUMENT IS TONALLY AND ELECTRICALLY SIMILAR TO THE MODEL BC CONSOLE DESCRIBED ON THE PRECEDING PAGES.

IN ADDITION TO NORMAL PLAYING IT COULD ALSO BE PLAYED WITH ROLLS SIMILAR TO A PLAYER PIANO.

FLOOR DIMENSIONS ARE ALSO SIMILAR TO THE BC WITH A SOMEWHAT HIGHER BACK SECTION TO ACCOMMODATE PNEUMATIC ACTION.



HOME MODEL B-A



CHURCH MODELS C, CV, C-2, C-3, D AND DV

MODEL C: (IN PRODUCTION SEPTEMBER 1939 TO JUNE 1942). SAME AS MODEL AB BUT WITH DIFFERENT STYLE WOODWORK. ONE TONE GENERATOR, ONE ADJUSTABLE TRIPLETON AFFECTING BOTH MANUALS AND PEDALS EQUALLY.

CABINET SIZE: WITH PEDAL KEYBOARD AND BENCH: 48-3/4" WIDE, 47" DEEP, 46" HIGH.

FINISH: WALNUT.

MODEL CV: (IN PRODUCTION SEPTEMBER 1943 TO DECEMBER 1949). SAME AS MODEL C BUT EQUIPPED WITH HARMONO VIBRATO, INCLUDING VIBRATO CHORDS.

FINISH: WALNUT.

MODEL C-2: (IN PRODUCTION DECEMBER 1949 TO DECEMBER 1954). SAME AS MODEL CV BUT WITH CONTROLS WHICH PROVIDE VIBRATO ON EITHER OR BOTH MANUALS. ALSO ADDITIONAL CONTROL FOR "NORMAL" OR "SOFT" OVERALL VOLUME.

FINISH: WALNUT

MODEL C-3: (IN PRODUCTION JANUARY 1955 TO) SAME AS MODEL C-2 BUT WITH HARMONO PERCUSSION PEATER.

FINISH: WALNUT - OAK. LATER VERSION IN BOTH FINISHES LESS QUATREFOOT.

MODEL D: (IN PRODUCTION JUNE 1939 TO NOVEMBER 1942). SAME AS MODEL C BUT WITH ONE ADDITIONAL TONE GENERATOR AND APPROPRIATE SWITCHING TO CREATE CHORDS EFFECT. SIMILAR TO MODEL BC.

FINISH: WALNUT.

MODEL DV: SAME AS MODEL D BUT WITH HARMONO VIBRATO, INCLUDING VIBRATO CHORDS. SEE BCV. NOW PRODUCED, KIT ASSED IN FIELD.

HANDLS: SMALL AND GREAT, 61 PLAYING KEYS EACH.

PEDAL KEYBOARD: 25-NOTE, RADIATING, DETACHABLE.

TONAL CONTROLS: 9 PRESET KEYS AND 2 SETS OF 9 ADJUSTABLE HARMONIC DRAWBARS FOR EACH MANUAL; 2 ADJUSTABLE DRAWBARS (10" AND 8") FOR PEDALS.

EXPRESSION: ONE EXPRESSION PEDAL CONTROLLING SMALL, GREAT, AND PEDALS.

AC INPUT: APPROXIMATELY 40 TO 60 WATTS, FINE WAVEAGE REQUIRED BY TONE CABINETS.

WEIGHT: AS ILLUSTRATED, APPROXIMATELY 450 LBS.

The Model G consoles and tone cabinets were built for the Government, and now will be found in use throughout the United States and foreign countries in chapels of all services, Officers Clubs, or recreation service buildings.

The console is identical to the Model D except for the decorative woodwork and provision for detachable handles.

The tone cabinet (Model G-40) contains two amplifiers and four speakers mounted in a horizontal row and is electrically similar to Model B-40 tone cabinets, but has a re-verbération control unit.

Produced from June 1941 to NOVEMBER 1944.

MODEL C-2G, C-3G CONSOLES AND BR-40G

These consoles are identical in appearance to the C-2 and C-3 except that a monitor speaker is located on the lower left hand side.

The preamplifier in the C-2G is designed to operate the monitor speaker. In the C-3G the preamplifier is the same as in the C-3. A small auxiliary amplifier drives the monitor speaker. In both Models, 8- voltage from the tone cabinet is required to make the monitor speaker operative.

The BR-40G is identical to the BR-40 except that it is equipped with a standard 5 conductor cable which must be used in conjunction with the C-2G console.

C-2G in production June 1952 to March 1953.

C-3G in production January 1955 to



CONCERT MODEL E

MODEL E: (IN PRODUCTION JULY 1957 TO JULY 1947.)

CABINET WITH PEDAL KEYBOARD: 57" WIDE, 46-7/8" HIGH, 47-5/8" DEEP.

FINISH: WALNUT

MANUALS: SWELL AND GREAT, 61 PLAYING KEYS EACH.

PEDAL KEYBOARD: 32-NOTE, CONCAVE, RADIATING, DETACHABLE, SUIT TO AGO SPECIFICATIONS.

TONAL CONTROLS: 5 PRESET BUTTONS AND 2 SETS OF 9 ADJUSTABLE HARMONIC BRASSBARS FOR EACH MANUAL; FOR PEDALS - 4 NUMBERED AND LABELED TONE PISTONS 2 ADJUSTABLE DRAWBARS (16' AND 8') AND GREAT TO PEDAL 8' COUPLER

EXPRESSION: 2 EXPRESSION PEDALS, ONE FOR SWELL AND ONE FOR GREAT AND PEDALS. VISUAL POSITION INDICATORS OF SLIDING ROD TYPE.

FEATURES: SEPARATE ADJUSTABLE THERMOSTATS FOR SWELL AND GREAT MANUALS. STANDARD MAIN AND CHORUS GENERATOR UNITS; ON AND OFF SWITCH FOR CHORUS.

AC INPUT: APPROXIMATELY 30 WATTS, PLUS WATTAGE REQUIRED BY TONE CABINET.

WEIGHT: AS ILLUSTRATED, APPROXIMATELY 570 LBS.



CONCERT MODELS RT, RT-2, AND RT-3

MODEL RT:	(IN PRODUCTION JULY 1949 TO SEPTEMBER 1949), EQUIPPED WITH HARMONO VIBRATO PROVIDING THREE DEGREES OF TRILL VIBRATO AND AN "OFF" POSITION, EFFECTIVE SIMULTANEOUSLY ON BOTH MANUALS, TOGETHER WITH VIBRATO CHOSEN USABLE IN THREE DIFFERENT DEGREES AND "OFF".	MANUALS:	SWELL AND GREAT, 40 PLAYING KEYS EACH.
CABINET SIZE:	WITH PEDAL KEYBOARD: 57" WIDE, 46-7/8" HIGH 47-3/8" DEEP.	PEDAL KEYBOARDS:	32-NOTE, CONCAVE, RADIATING DETACHABLE, SUITS TO ADD SPECIFICATIONS.
FINISH:	WALNUT.	PEDAL SOLO SYSTEM:	WAS PEDAL SOLO SYSTEM WITH SEPARATE VOLUME CONTROL, PROVIDING FOLLOWING SOLO EFFECTS: 32-FOOT BOURDON, 32-FOOT BOURBARD, 16-FOOT SOLO, 8-FOOT SOLO, 4-FOOT SOLO, 2 and 1-FOOT SOLO. ALSO TABLETS FOR MUTE CONTROL AND PEDAL ON.
MODEL RT-2:	(IN PRODUCTION NOVEMBER 1949 TO JANUARY 1955). SAME AS MODEL RT BUT WITH CONTROLS WHICH PROVIDE VIBRATO ON EITHER OR BOTH MANUALS, ALSO ADDITIONAL CONTROL FOR "NORMAL" OR "SOFT" OVERALL VOLUME.	TONAL CONTROLS:	5 PRESET KEYS AND 2 SETS OF 9 ADJUSTABLE HARMONIC DRAWBAR FOR EACH MANUAL; FOR PEDALS, TWO ADJUSTABLE DRAWBARS (16" AND 8").
FINISH:	WALNUT.	EXPRESSION:	ONE EXPRESSION PEDAL, CONTROLLING SWELL, GREAT AND PEDALS.
MODEL RT-3:	(IN PRODUCTION JANUARY 1955 TO). SAME AS MODEL RT-2 BUT WITH HARMONO PERCUSSION FEATURE.	AC INPUT:	APPROXIMATELY 110 TO 130 WATTS, PLUS WATERAGE REQUIRED BY TONE CABINETS.
FINISH:	WALNUT - OAK.	WEIGHT:	AS ILLUSTRATED, APPROXIMATELY 525 POUNDS.



- MODEL :** A-100 (IN PRODUCTION 1959 TO 1965). HOME STYLE CONSOLE. SAME AS C-3 BUT WITH
A-101 BUILT-IN SOUND SYSTEM INCLUDING REVERB CONTROL.
A-102
- A-105 (IN PRODUCTION 1962 TO 1975). CHURCH STYLE CONSOLE. SAME AS C-3 BUT
WITH BUILT-IN SOUND SYSTEM INCLUDING REVERB CONTROL.
- CABINET :** A-100 WITH PEDAL KEYBOARD AND BENCH 47-1/2" WIDE, 45-1/2" HIGH, 43" DEEP
SIZE : A-101
A-102
A-105 SAME AS MODEL C
- FINISH :** A-100 RED MAHOGANY — LIGHT WALNUT
A-101 BROWN MAHOGANY - GRAY MAHOGANY - BLACK
A-102 LIGHT CHERRY - DARK CHERRY
A-105 LIGHT OAK - DARK WALNUT
- OUTPUT :** 27 WATTS - 2 AMPLIFIERS, 3-12" SPEAKERS
- AC INPUT :** APPROXIMATELY 200 WATTS



MODEL : D-100 (IN PRODUCTION 1963 TO 1969). SAME AS RT-3 BUT WITH BUILT-IN SOUND SYSTEM INCLUDING REVERB CONTROL.

CABINET SIZE : SAME AS RT

FINISH : D-152 WALNUT
D-155 OAK

OUTPUT : 50 WATTS — 3 AMPLIFIERS, 2-12" SPEAKERS, 2-18" SPEAKERS

AC INPUT : APPROXIMATELY 330 WATTS

WEIGHT : AS ILLUSTRATED, APPROXIMATELY 543 LBS.



MODEL A-20 TONE CABINET

MODEL A-20 (IN PRODUCTION OCTOBER 1935 TO JULY 1939).

CABINET SIZE: 27" WIDE, 30" HIGH, 15" DEEP.

FINISH: AMERICAN WALNUT

WEIGHT: 133 POUNDS

OUTPUT: 20 WATTS - 1 AMPLIFIER, 2 - 12" SPEAKERS.

AC INPUT: APPROXIMATELY 180 WATTS.

THIS SMALL DECORATIVE TONE CABINET IS USED FOR HOMES, NIGHTCLUBS, AND SMALL CHURCHES, SEATING NOT OVER 100 PERSONS, WHERE A LIMITED AMOUNT OF POWER IS REQUIRED.

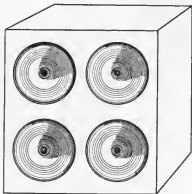

MODEL A-40 TONE CABINET

MODEL A-40 (IN PRODUCTION OCTOBER 1935 TO OCTOBER 1947).

CABINET SIZE: 26-1/2" WIDE, 28" HIGH, 19" DEEP.

FINISH: BLACK LAQUER.

WEIGHT: 155 POUNDS

OUTPUT: 40 WATTS - 2 AMPLIFIERS, 4 - 12" SPEAKERS

AC INPUT: APPROXIMATELY 360 WATTS.

A NON-DECORATIVE, DOUBLE-DUNGER CABINET, DESIGNED FOR USE IN BANKS OF FOUR OR MORE, IN LARGE INSTALLATIONS WHERE THE CABINETS ARE CONCEALED.

MODEL B-40: (IN PRODUCTION NOVEMBER 1936 TO DECEMBER 1947.)

CABINET SIZE: 36" WIDE, 36" HIGH, 28-1/2" DEEP

FINISH: WALNUT STAIN

WEIGHT: 225 POUNDS

OUTPUT: 40 WATTS - 2 AMPLIFIERS, 4 - 12" SPEAKERS.

AC INPUT: APPROXIMATELY 360 WATTS.

A SEMI-DECORATIVE, DOUBLE-STRENGTH CABINET DESIGNED FOR USE INDIVIDUALLY OR IN GROUPS. THE B-40 IS FOUND DESIRABLE FOR MANY CHURCHES AND FOR LARGE INSTALLATIONS, FOR IT MAY BE USED APPROPRIATELY IN ALMOST ANY SETTING.



MODEL B-40 TONE CABINET



MODEL C-20: (IN PRODUCTION 1937 TO MARCH 1942).

MODEL CX-20: (IN PRODUCTION 1939 - 1942) EQUIPPED WITH REGENERATION UNIT.

MODEL CXR-20: (IN PRODUCTION JANUARY 1939 TO MARCH 1942). EQUIPPED WITH ROTOR TROMBLANT. SEE MODEL CXR-20 FOR PICTURE OF THIS FEATURE.

MODEL CXR-20: (IN PRODUCTION NOVEMBER 1939 TO MARCH 1942) EQUIPPED WITH ROTOR TROMBLANT AND REGENERATION UNIT.

DIMENSIONS: 29" WIDE, 53" HIGH, 18-1/4" DEEP.

FINISH: MATCHED AMERICAN BUTT WALNUT AND ANTIQUE BRASS HARDWARE.

WEIGHT: 153 POUNDS

OUTPUT: 20 WATTS, 1 AMPLIFIER, 2 - 12" SPEAKERS

AC INPUT: APPROXIMATELY 200 WATTS.

MODEL C-20, CX-20, AND CXR-20 TONE CABINET



MODEL C-40 TONE CABINET

MODEL C-40: (IN PRODUCTION JUNE 1936 TO DECEMBER 1937).

CABINET SIZE: 38" WIDE, 71" HIGH, 27-1/2" DEEP.

FINISH: WALNUT STAIN

WEIGHT: 315 POUNDS

OUTPUT: 40 WATTS - 2 AMPLIFIERS AND 4 - 12" SPEAKERS

AC INPUT: APPROXIMATELY 360 WATTS.

THE C-40 CABINET HAS A WIDE VARIETY OF APPLICATIONS. IT IS ESPECIALLY ADAPTED FOR USE IN ENCLOSURES WHERE THE INDIRECT PRODUCTION OF SOUND IS DESIRABLE. VERY OFTEN THE CEILING AND FLOOR ARE THE ONLY "LIVE" OR REFLECTING SURFACES AND THIS TYPE CABINET MAKES USE OF THESE.

THE C-40 CABINET IS USED INDIVIDUALLY OR IN GROUPS OF TWO OR MORE.



MODEL D-20: (IN PRODUCTION OCTOBER 1937 TO MARCH 1952). TOTALLY IDENTICAL WITH MODEL C-20, THE D-20 FILLS A NEED FOR AN INEXPENSIVE CABINET FOR USE IN A WIDE VARIETY OF INSTALLATIONS WHERE DECORATIVE QUALITIES ARE A SECONDARY CONSIDERATION.

MODEL DX-20: (IN PRODUCTION OCTOBER 1938 TO JUNE 1942). EQUIPPED WITH ROTON TREMULANT.

MODEL DR-20: (IN PRODUCTION AUGUST 1939 TO MARCH 1942). EQUIPPED WITH REGENERATION UNIT.



MODEL DR-20: (IN PRODUCTION APRIL 1939 TO JUNE 1942). EQUIPPED WITH ROTON TREMULANT AND REGENERATION UNIT.

CABINET SIZE: 28" WIDE, 56" HIGH, 16-3/4" DEEP.

FINISH: FACE AND SIDES OF AMERICAN WALNUT.

WEIGHT: 149 POUNDS - D-20; 171 POUNDS - DR-20;
176 POUNDS - DX-20.

OUTPUT: 20 WATTS - 1 AMPLIFIER, 2 - 12" SPEAKERS.

AC INPUT: APPROXIMATELY 200 WATTS.

MODEL ER-20s (IN PRODUCTION MARCH 1947 TO DECEMBER 1950)

CABINET SIZEs 31" WIDE, 36-1/4" HIGH, 18" DEEP.

FINISHs WALNUT.

WEIGHTs 144 POUNDS.

OUTPUTs 20 WATTS - 1 AMPLIFIER, 2 - 12" SPEAKERS.

AC INPUTs APPROXIMATELY 200 WATTS.

THE ER-20 TONE CABINET IS ELECTRICALLY EQUIVALENT TO THE DE-20 TONE CABINET. HOWEVER, THE WOODWORK IS DESIGNED FOR USE IN HOMES WHERE A MORE ARTISTIC CABINET IS PREFERRED.



MODEL ER-20 TONE CABINET



MODEL F-40 AND FR-40 TONE CABINET

MODEL F-40
MODEL FR-40 (IN PRODUCTION JANUARY 1948 TO DECEMBER 1957)

CABINET SIZEs 30-15/16" WIDE; 39-3/16" HIGH; 28-1/8" DEEP.

FINISHs WALNUT STAIN

WEIGHTs F-40 - 208 LBS. FR-40 - 228 LBS.

OUTPUTs 40 WATTS - 2 AMPLIFIERS, 4 - 12" SPEAKERS.

AC INPUTs APPROXIMATELY 300 WATTS.

THE F-40 REPLACES THE E-40 TONE CABINET. DIMENSIONS OF THE WOODWORK HAVE BEEN ALTERED SO THAT A REGENERATION UNIT MAY BE ACCOMMODATED. WITH THE ADDITION OF THE REGENERATION UNIT IT IS DESIGNATED AS FR-40.



MODEL PR-40

MODEL PR-40: (IN PRODUCTION FEBRUARY 1959)
CABINET SIZE: 31-1/2" WIDE; 37-1/2" HIGH; 18" DEEP.
FINISH: WALNUT - OAK - CHERRY
WEIGHT: 130 POUNDS
MODEL QR-40: (IN PRODUCTION JUNE 1959)
CABINET SIZE: 31" WIDE; 36-5/8" HIGH; 37-1/4" DEEP.
WEIGHT: 121 POUNDS
AC INPUT: 220 VOLTS
OUTPUT: 50 WATTS R.F.A.



MODEL QR-40

EQUIPPED WITH TWO 12" SPEAKERS FOR BASS TONES AND TWO 12" SPEAKERS FOR THE TREBLE TONES, THEY PROVIDE THREE DIMENSION AMPLIFICATION WHICH CREATES A BEAUTIFUL REVERBERATION EFFECT IN STEREO. THESE CABINETS FEATURE THE NEW AND IMPROVED HARMONIC REVERBERATION CONTROL FOR BOTH BASS AND TREBLE TONES. CONVEYERBELT OUTSIDE CONTROLS MAKE IT EASY TO CHANGE THE DEGREE OF REVERBERATION FOR EACH.

THE QR-40 IS ELECTRICALLY SIMILAR TO THE PR-40 BUT WITH ITS UTILITY TYPE CABINET IS ONLY USED WHERE APPEARANCE IS NOT A CONSIDERATION, SUCH AS IN TONE AND REVERBERATION CHAMBERS.

THE TREBLE DIRECT SPEAKER IS NORMALLY MOUNTED IN THE TOP. IN AN UNUSUAL INSTALLATION WHERE THE CEILING IS VERY LOW OR CABINETS ARE STACKED OR RADIATION IS OTHERWISE RESTRICTED, IT IS POSSIBLE TO MOVE THIS SPEAKER TO THE HOLE PROVIDED IN THE FRONT. THE METAL DIFFUSER IN FRONT OF THE SPEAKER MUST ALSO BE MOVED, AND THE WOODEN COVER MUST BE ATTACHED UNDER THE TOP TO CLOSE THE HOLE.



THEORY OF OPERATION

The console of the Hammond Organ contains the entire tone-producing mechanism, which is completely electrical in operation. Within it are produced all the tones and tone combinations of the organ. The electrical waves are made audible, as music, by one or more tone cabinets containing suitable amplifiers and loud speakers. The block diagrams (Figures 13 and 14) show the chief components of the instrument.

Electrical impulses of various frequencies are produced within a unit known as the "tone generator", containing a number of "phonic wheels" or "tone wheels" driven at predetermined speeds by a motor and gear arrangement. Each phonic wheel is similar to a gear, with high and low spots, or teeth, on its edge. As the wheel rotates these teeth pass near a permanent magnet, and the resulting variations in the magnetic field induce a voltage in a coil wound on the magnet. This small voltage, when suitably filtered, produces one note of the musical scale, its pitch or frequency depending on the number of teeth passing the magnet each second.

A note of the organ, played on either manual or the pedal keyboard, generally consists of a fundamental pitch and a number of harmonics, or multiples of the fundamental frequency. The fundamental and eight harmonics available on each playing key are individually controllable by means of drawbars and preset keys or buttons. By suitable adjustment of these controls the player is enabled to vary the tone colors at will.

The resulting signal passes through the expression or volume control and through the preamplifier (where vibrato is introduced) to the tone cabinet. Here reverberation is added electrically and a power amplifier feeds the signal into loud speakers.

DESCRIPTION

A Hammond Organ console (Fig. 2) includes two manuals or keyboards: the lower, or Great, and the upper, or Swell, and a pedal keyboard of 25 keys. The concert models have a 32-key pedalboard and are constructed to A. G. O. specifications. Various controls have appeared on different models. The operation of these controls is covered in the following paragraphs.

STARTING THE ORGAN



FIGURE 1

To start the organ, hold the "start" switch (Fig. 1) in "on" position for approximately eight seconds. Still holding it, push the "run" switch to "on" position. After leaving both switches on for about four seconds, release the start switch to return to its normal position.

If the console is very cold, or if a frequency regulator is used, it may be necessary to hold the start switch slightly longer.



The console of the Hammond Organ contains the entire tone-producing mechanism, which is completely electrical in operation. Within it are produced all the tones and tone combinations of the organ. The electrical waves are made audible, as music, by one or more tone cabinets containing suitable amplifiers and loud speakers. The block diagrams (Figures 13 and 14) show the chief components of the instrument.

Electrical impulses of various frequencies are produced within a unit known as the "tone generator", containing a number of "phonic wheels" or "tone wheels" driven at predetermined speeds by a motor and gear arrangement. Each phonic wheel is similar to a gear, with high and low spots, or teeth, on its edge. As the wheel rotates these teeth pass near a permanent magnet, and the resulting variations in the magnetic field induce a voltage in a coil wound on the magnet. This small voltage, when suitably filtered, produces one note of the musical scale, its pitch or frequency depending on the number of teeth passing the magnet each second.

A note of the organ, played on either manual or the pedal keyboard, generally consists of a fundamental pitch and a number of harmonics, or multiples of the fundamental frequency. The fundamental and eight harmonics available on each playing key are individually controllable by means of drawbars and preset keys or buttons. By suitable adjustment of these controls the player is enabled to vary the tone colors at will.

The resulting signal passes through the expression or volume control and through the preamplifier (where vibrato is introduced) to the tone cabinet. Here reverberation is added electrically and a power amplifier feeds the signal into loud speakers.

DESCRIPTION

A Hammond Organ console (Fig. 2) includes two manuals or keyboards: the lower, or Great, and the upper, or Swell, and a pedal keyboard of 25 keys. The concert models have a 32-key pedalboard and are constructed to A.C.O. specifications. Various controls have appeared on different models. The operation of these controls is covered in the following paragraphs.

STARTING THE ORGAN

To start the organ, hold the "start" switch (Fig. 1) in "on" position for approximately eight seconds. Still holding it, push the "run" switch to "on" position. After leaving both switches on for about four seconds, release the start switch to return to its normal position.

If the console is very cold, or if a frequency regulator is used, it may be necessary to hold the start switch slightly longer.



FIGURE 1



THE
CONCERT MODEL
HAMMOND
ORGAN



THE
HOME MODEL
HAMMOND
ORGAN

FIGURE 2

PRESET KEYS

At the left end of each manual are twelve keys identical to the playing keys except reversed in color. (Fig. 3). These are replaced by twelve numbered buttons on the Model E console.



FIGURE 3

When a preset key is depressed it locks down and is released only when another is depressed. The exception to this is the cancel key at the extreme left, which serves only to release any key which may be locked down. Only one preset key is used at one time. If by mistake two are depressed and locked, they may be released by means of the cancel key.

Each preset key, with the exception of the cancel key and the two adjust keys at the extreme right of the group, makes available a different tone color which has been set up on the preset panel located inside the console. These tone colors are set up at the factory in accordance with a standard design which

has been found to best meet the average organist's requirements. They may be changed, if desired, by removing the back of the console and changing the preset panel connections in accordance with instructions on a card located near the preset panel.

When either adjust key is depressed, the organ speaks with whatever tone color is set up on the harmonic drawbars associated with that key. The percussion effect on Models B-3, C-3, RT-3, A-100 & D-100 is introduced when the upper manual 'B' preset key is depressed (see "percussion" also)

HARMONIC DRAWBARS

Each console has **four** sets of harmonic drawbars, two for each manual. Figure 4 shows one group of harmonic drawbars, by which the organist is enabled



FIGURE 4 ONE HARMONIC DRAWBAR GROUP

to mix the fundamental and any, or all, of eight different harmonics in various proportions. The third bar from the left controls the fundamental, and each of the other bars is associated with a separate harmonic. If a drawbar is set all the way in, the harmonic it represents is not present in the mixture.

Each drawbar may be set in eight different positions by the organist in addition to the silent position. Each position, as marked on the drawbars, represents a different degree of intensity of the harmonic it controls. When drawn out to position 1, the harmonic it represents will be present with minimum intensity, when drawn out to position 2, with greater intensity, and so on up to position 8.

A tone color is logged by noting the numerical position of the various drawbars. For instance, the tone set up on Figure 4 is known as tone 14 610 5210. After a tone is so logged it may be made available again by setting the harmonic drawbars to that number.

The drawbars in earlier consoles have distinct intensity positions with silent spots between them. Later consoles are equipped with "continuous contact" drawbars which move smoothly with no interruption in tone.

HARMONIC DRAWBARS FOR THE PEDALS

In the pedals the harmonic resources have been combined into two drawbars which may be used separately or in combinations. When the left drawbar is used emphasis is given to the lower harmonics, and similarly the higher harmonics are emphasized when the right drawbar is used. The pedal drawbars are located between the two sets of manual drawbars.

PEDAL TOE PISTONS - MODEL E CONSOLE



FIGURE 5

Four pedal toe pistons are located to the left of the expression pedals. Numbers one and two of these pistons are pedal presets. The third is a Great-to-Pedal coupler, which makes the pedals speak with whatever 8 foot tone is set up on the Great manual. The left pedal drawbar may be used with the coupler to add 16 foot tone. The fourth piston connects the pedals to the two pedal drawbars.

Lighted piston indicators are provided on the left side of the console just above the Small manual. Each time a toe piston is depressed, the proper indicator is automatically illuminated so the organist always knows which toe piston is depressed.

A pedal solo unit is incorporated in the concert Models to provide a series of bright pedal solo tones in addition to the usual pedal accompaniment tones available on other models. The pedal solo tones, generated by a vacuum tube oscillator circuit, are controlled by a volume control knob and eight timing stop tablets located at the right end of the Great manual (Fig. 5). One tablet turns all the pedal solo tones on or off and the others provide various pitch registers and tone colors. The pedal solo unit is independent of the electromagnetic tone generator and can be turned off without affecting the remainder of the organ.

NORMAL - SOFT VOLUME CONTROL
(Models B-2, B-3, C-2, C-3, RT-2, RT-3, A-100 Q-100)

This control (Fig. 3) is a tilting tablet which supplements the action of the expression pedal. In "soft" position it reduces the volume of the whole instrument. It is particularly useful when playing in a small room or when the organist wishes to practice without disturbing others.

CHORUS CONTROL
(Models BC, BCV, D, DV, E)

On these models an extra generator known as a chorus generator will be found. To use the tones generated by this unit at will, one extra black drawbar has been added which operates a switch located on the generator. The drawbar labeled "chorus" is located at the right-hand end of the console. (Fig. 6)

When the organ is played with the chorus drawbar pushed in (the "off" position) it operates in exactly the same way as though no chorus were included. Pulling the drawbar out (to the "on" position) instantaneously adds the ensemble or "chorus" effect to whatever is being played. Actually it adds a series of slightly sharp and slightly flat tones to the true tones produced by the main generator. The resulting electrical wave contains a complex series of undulations which enhance the pleasing effect of many tone qualities, notably string and full organ combinations.

The chorus control should not be confused with the "vibrato chorus" effect, described under "vibrato". The two effects are similar musically, but are produced by completely different means.

EXPRESSION OR SWELL PEDAL

The swell pedal, located in the customary position, is operated by the right foot and with it the volume of the organ may be controlled over a wide range. It operates on the two manuals and pedals equally, that is to say, once the manuals and pedals are balanced, they retain their relative balance over the entire swell pedal range.

Two expression pedals are provided for the Model E Console. Both are equipped with adjustable clamps to regulate the tension and the distance through which they move. Adjustable pedal indicators, operated by wires from the rheostat box, are located at the extreme right side of the console above the Swell manual.



FIGURE 4

ECHO SWITCH

Located above the starting and running switches on some consoles is the "echo switch" (Fig. 4). With this switch it is possible to use two tone cabinets and have either cabinet or both speak, depending on the position of the switch. Generally one tone cabinet is placed rather distant from the console and is called the "echo organ". This feature can be added to a Hammond Organ by installation of an "Echo switch kit".

TREMULANT

The tremulant or tremolo is a periodic variation in intensity of all tones without change in pitch. It is produced by a variable resistance driven by the motor of the main tone generator, and is controlled by a variable resistor in shunt. When the tremulant control is turned as far as possible to the left, the tremulant is entirely off. As it is turned to the right (clockwise) the degree of tremolo gradually increases until it reaches a maximum at the extreme right position. The white dot marker on the knob indicates at a glance the degree of tremolo present. Two tremolo controls are used on the Model E console, one for each manual. These are controlled by separate levers located on the console.

The tremulant is not incorporated in models having vibrato.

VIBRATO



FIGURE 7

The vibrato effect is created by a periodic raising and lowering of pitch, and thus is fundamentally different from a tremolo, or loudness variation. It is comparable to the effect produced when a violinist moves his finger back and forth on a string while playing, varying the frequency while maintaining constant volume.

The vibrato mechanism includes an electrical time delay line, which shifts the phase of all tones fed into it. A rotating scanner, mounted on the main tone generator, picks up successive signals from various line sections. These signals represent various amounts of phase shift, and the combination of signals produces a continuous frequency variation.

When the "vibrato chorus" switch (Fig. 7) (Models AV, BV, BCV, CV, DV, and RT) is pushed to the left, normal vibrato is obtained with the vibrato switch in positions 1, 2, or 3. When the lever is pushed to the right a chorus or ensemble effect, combining foundation organ tone with vibrato tone, is obtained. The center position of this switch is not intended to be used. No harm will result from leaving the switch in this position, but reduced volume will be obtained.

Models B-2, B-3, C-2, C-3, RT-2, RT-3, A-100 & D-100 have the "selective vibrato" feature which makes the vibrato effect available on either manual separately or on both together. Two bling tablets (Figure 8) control the vibrato for the two manuals, while the rotary switch selects the degrees of vibrato or vibrato chorus effect. The "Great" tablet controls the vibrato for the pedals as well as for the Great manual.

The vibrato is not present on models having the tremulant.

PERCUSSION



FIGURE 8

The Percussion feature (Models B-3, C-3, RT-3, A-100 & D-100) is controlled by four bling tablets (Fig. 8) at the upper right side of the manuals. Percussion is available only on the upper manual and only when the "B" preset key is depressed. The four tablets (from left to right) select Percussion on or off, normal or soft Volume, fast or slow Decay, and second or third Harmonic tone quality.

Percussion tones are produced by borrowing the second or third harmonic signal from the corresponding manual drawbar, amplifying it, returning part of the signal to the

same drawbar, and conducting the balance of the signal through push-pull control tubes where its decay characteristics are controlled.

The Percussion signal is then combined with the signal from the manuals after the vibrato but before the expression control. The control tubes are keyed through the eighth harmonic key contacts and bushbar.

STONE GENERATOR

The main tone generator furnishes 82 or 91 different musical frequencies, depending on the console model. It includes a tone wheel, magnet, and coil

for each frequency. Mounted on top of the generator are tuned filters to insure purity of the tones.

PREAMPLIFIER

The preamplifier is located in the console. Several types have been used in the various console models. Some obtain their plate voltage from the power amplifier through the console-to-cabinet cable, while others have a self-contained power supply.

STONE CABINETS

Tone cabinets are made in a number of models differing in size, finish, and power output. The numbers 20 and 40 in the model designations indicate the nominal power output in watts. Each tone cabinet includes one or two power amplifiers and two or more speakers.

Cables of special design are used to connect the console to the tone cabinet or cabinets.

REVERBERATION CONTROL

Tone cabinets having the letter R within the model designation are equipped with the Hammond Reverberation Control. This is an electro-mechanical device designed to supply reverberation for installations that are acoustically "dead" or have insufficient natural reverberation. A portion of the musical signal is delayed by passing through fluid-damped coil springs and then combined with the direct signal. By adjustment of the amount of delayed signal the reverberation characteristics of large or small enclosures may be simulated. A tone cabinet having this unit must be handled in accordance with directions on the instruction card in order to avoid damaging the unit or spilling the fluid.

ROTOR TREMULANT

Tone cabinets having the letter X in their model designation contain a drum rotor mounted above the speakers and driven by a small motor. Rotating in the path of sound from the loud speakers, it produces the effect of a periodic volume and pitch variation in all tones of the organ.

A switch for controlling its operation can be mounted on the tone cabinet, or an additional cable with a switch located at the console may be used.

When a console having the Hammond Vibrato is connected to this type cabinet use of the rotor tremulant is not recommended.

POWER AMPLIFIER

A-100

A twelve watt amplifier is mounted on the lower shelf of the console. It receives the signal from the Preamplifier and increases it in power to drive the two 12" speakers.

D-100

A fifty watt three channel amplifier (bass with reverberation, treble, treble with reverberation) together with its independent power supply is located on the lower shelf of the console. It receives the signal from the preamplifier and furnishes power to drive the 2-12" speakers and 2-8" speakers.

REVERBERATION SYSTEM

A-100

To the left of the amplifier are the reverberation amplifier and reverberation unit. A portion of the output signal of the power amplifier passes through the reverberation unit to the reverberation amplifier and this drives a third 12" speaker housed within the console. The degree of reverberation heard can be regulated by rotating the knob marked "Reverberation Control" shown in Figure 5.

D-100

To the left of the pedal solo generator is the Hammond Reverberation unit. Signals from the preamplifier are applied to the "treble with reverberation" channel of the power amplifier and are heard from the 8" speaker located to the right of the player.

In operation, an electrical signal from the reverberation drive channel is applied to the driver unit in the reverberation device which then converts the electrical signal into mechanical energy. This energy is transmitted through springs to a pickup unit where a part of it is converted back to electrical energy. The remaining portion is reflected back to the driver and again back to the pickup at a time interval determined by the spring lengths. This transaction continues until the signal energy is reduced to one millionth of its original value. The transfer time from driver to pickup and the reflections within the system itself produce the reverberation effect.

SECTION II

ACOUSTICS - THE PART THEY PLAY IN HAMMOND ORGAN INSTALLATIONS

INSTALLATIONS IN GENERAL

The proper installation of a Hammond organ requires the careful observance of four primary rules:

1. The organ should furnish **AMPLE POWER**.
2. The sound energy from the organ should be **EVENLY DISTRIBUTED**.
3. The console and tone cabinets should be so located in relation to each other and to the audience, choir, soloist, etc., that a **PROPER TONAL BALANCE** is accomplished.
4. The organ tone should be **PROPERLY REVERBERATED**.

The observance of these rules with due consideration to the particular use for which the instrument is required will insure the best possible installation in any type of enclosure. These rules will be discussed in detail in the following pages.

POWER

There are so many factors which have a bearing on the amount of power or sound energy necessary for best musical results in a given enclosure that an accurate formula for determining the required power in all cases would be too cumbersome for everyday use. Experience has shown that it is very seldom that too many tone cabinets are specified. Therefore, if there is doubt as to the sufficiency of tone cabinets for any installation it is reasonably safe to double this amount. This will greatly improve the musical quality of the instrument and eliminate overloading of the speakers. Some of the factors which have a bearing on the amount of tone cabinet equipment required in any enclosure are the size and shape of the enclosure, placement of tone cabinets, amount and location of sound-absorbing materials including persons present in the enclosure. The use for which the organ is desired also has a bearing on requirements; for example, an organ to be used primarily to support congregational singing would require more tone cabinets than one that is to be used mainly for accompaniment of soloists or light entertainment.

The following conditions in an enclosure, therefore, usually indicate that more than an average installation may be required:

1. When the area of the boundaries of the enclosure is great in proportion to the volume of the enclosure. Thus, an enclosure of irregular shape having numerous alcoves, etc., would require more tone cabinets than one of cubical shape.
2. When the tone cabinets are located in a position where considerable sound absorption takes place before the sound reaches the listener. A poorly designed or constructed organ chamber is an example.
3. When acoustical correction materials are used on walls or ceiling, when heavy drapes are present and carpets are used for floor covering.
4. When seating capacity is high for the size of the enclosure. For practical purposes an open window is considered as an area of 100 percent absorption of sound. A single person absorbs about as much sound as four square feet of open window. Therefore, an audience of 1,000 people will have the effect on music volume of an open window area of 4,000 square feet as compared with the volume heard when the enclosure is empty. To offset this absorption, a disproportionately greater amount of tone cabinet equipment must be used.

DISTRIBUTION

The sound energy from the organ should be distributed as evenly as possible throughout the enclosure. In order that this may be accomplished, it is important that the sound be distributed in the auditorium above the listeners and that a large percentage of the sound reaching the listener is by numerous reflections from the walls and ceiling. Direct projection as well as direct reflection from the speakers should not reach the listener. Focusing effects of curved surfaces such as barrelled ceilings often cause difficulty in sound distribution unless the tone cabinet is so located as to reduce the direct sound energy that reaches these surfaces.

It must be remembered that although sound is reflected in a manner similar to light, the reflecting surface must be large in relation to the wave length of the sound.

Therefore, a reflecting surface of a given size will reflect sounds above a certain frequency, while sounds of lower frequency will be diffracted or spread out. To reflect fully the lower tones of the organ a reflector thousands of square feet in area is necessary. This, together with the fact that different materials absorb sounds of certain frequencies more than others explains why identical tone colors produced in different enclosures will sound very different to the ear.

BALANCE

The placement of console and tone cabinets should be carefully planned so that the following conditions are fulfilled:

1. The organ should sound as loud or slightly louder to the organist at the console than it does to the audience. This allows the organist to accurately judge the musical effect he is producing and make any necessary corrections before the audience appreciates the need for them. It also reduces the tendency of playing too loud which is usually evident when the organist hears the organ at a lower level than the audience.
2. The organist should hear the organ and the choir with the same relative loudness that the audience hears them, otherwise a perfect tonal balance between organ and choir from the organist's point of hearing will result in an unbalanced effect as heard by the audience. When we refer to the choir we also include instrumental groups or soloists who may have occasion to perform in conjunction with the organ.
3. The tonal equipment of the organ should be so located that the choir, while singing, has adequate support from the organ when played at accompaniment volume. They should not, however, hear the organ so loudly as to have difficulty in singing with it. Good tonal balance and ease of performance should result if the average distance between choir and tone cabinets is about the same distance as between tone cabinets and organist.
4. The audience should hear the choir and the organ as a balanced ensemble, and the tone cabinets should be so placed that the choir voices will not be obscured by the organ tones.

REVERBERATION

Reverberation is the prolongation or persistence of sound by reflection, what we usually mean by "echo". It is measurable by the interval of time required for the sound to decay to inaudibility after the source of the sound has been stopped. It is present in a varying degree in all enclosures and most types of music are more pleasing to the ear when accompanied by a certain amount of reverberation. It is also the most important single factor to be considered in planning an organ installation as proper reverberation makes it easier to attain all of the other requirements necessary for a perfect installation.

In a Hammond organ installation, the proper amount of reverberation may be secured in three ways:

1. By the successive reflections of the sound by the boundaries of the auditorium.
2. By the Hammond Reverberation Control.
3. By placing the tone cabinets in a chamber, the boundaries of which cause the organ tones to reverberate before reaching the auditorium.

REVERBERATION IN THE AUDITORIUM

The reverberation that results from the successive reflections of sound back and forth by the boundaries of the auditorium itself is most desirable from the installation engineer's point of view. (By auditorium we mean any audience room such as a church or concert hall.)

In a reverberant auditorium less power is necessary and problems of sound distribution are greatly simplified and, therefore, the best possible musical results are usually obtained as a matter of course. Unfortunately, however, the reverberation characteristics of an auditorium usually are not alterable by the installation engineer, and he must accept them, good or bad as the case may be.

A reverberation time of one second when a two-thirds capacity audience is present is usually sufficient if reasonable care is taken in locating the organ equipment for proper distribution and balance although a slightly longer reverberation time is often desirable. It must be remembered that the reverberation time in any enclosure is greatly reduced when an audience is present. In general, the higher the ceiling of the auditorium, the less effect the presence of an audience has on the reverberation time; however, this effect is always considerable. If the natural reverberation in the auditorium is insufficient for best musical results from the organ, another method must be used to properly reverberate the organ tones.

HAMMOND REVERBERATION CONTROL

The Hammond Reverberation Unit provides an effective means of securing proper reverberation in all types of installations where the natural reverberation in the auditorium is insufficient. Experience has shown that best installations in homes, radio studios, apartments, and small churches include a tone cabinet equipped with reverberation control. It may also be used to improve the effectiveness of the organ in auditoriums where considerable natural reverberation is present, but where this natural reverberation is characterized by an objectionable echo occurring after the organ tones have seemingly ceased. The Hammond Reverberation Unit will not eliminate an echo or reduce the natural reverberation time, but will often make this natural reverberation more pleasing to the ear by "filling in" that period between the time the organ tones seem to cease and the echo occurs. The Hammond Reverberation Unit will not add to the reverberation time in auditoriums already having excessive natural reverberation. As the reverberation unit is connected to the electrical system of the organ and provides reverberation at the source of sound rather than after the sound comes from the speakers, it allows the installation engineer to place the tone cabinets for best results in balance and distribution without the necessity of compromise for reverberation considerations. The use of this device also eliminates the necessity of costly reverberation chambers, and by allowing the tone cabinets to be so located as to minimize sound energy losses, a saving in the amount of necessary power equipment is often effected. A further advantage is that the reverberation time may be regulated for best musical results after the organ is installed.

With the use of the Hammond Reverberation Unit a good organ installation should always result if the tonal equipment is placed to give even distribution and proper tonal balance.

REVERBERATION CHAMBERS

When it is desired to conceal the organ tone cabinets and there is adequate space available, a properly designed reverberation chamber may be very effective in supplying reverberation for the organ tones. In many cases, however, the space allotted for use as a reverberation chamber is anything but ideal, and often, because of structural limitations, little can be done to improve the effectiveness of the chamber other than to make minor corrections. The following principles of reverberation chamber design are given for guidance in properly evaluating the good and bad characteristics of a given chamber and in making such changes as will improve the effectiveness of the chamber as much as possible.

SIZE

As the reverberation time increases as the size of the chamber increases, the chamber should be as large as possible. Experience has shown that practically the only exception to this rule are when the shape of the chamber may be improved by reducing its size or when the tone opening cannot be made large enough in proportion to the size of the chamber. For best musical results the chamber should be at least 800 cubic feet in volume. The dimensions of the chamber are in most cases ideal if they are in the ratio of approximately 2 : 3 : 4 1/2. A chamber of equal volume but more cubical in form would have a longer reverberation time, while a chamber of less cubical form would have a shorter reverberation time; however, dimensions in the above ratio usually are most desirable. Chambers of complex shape or chambers of regular shape whose greatest dimension is more than three times the least dimension should be avoided.

CHART SHOWING SIZE OF TONE OPENING REQUIRED
FOR REVERBERATION TIME OF ONE SECOND
FOR CHAMBERS WITH DIMENSIONS IN RATIO OF 2 : 3 : 4.5

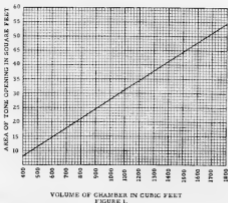

VOLUME OF CHAMBER IN CUBIC FEET
FIGURE 1.

CONSTRUCTION AND FINISH

All boundaries of a reverberation chamber should be of exceptionally rigid construction. Concrete or heavy tile is ideal. If the chamber is to be of frame construction the studs should not be over fourteen inches on centers. Lath should be very securely nailed and the plaster should be hard and given a smooth finish coat.

TONE OPENINGS

The reverberation time of an organ chamber is greatly influenced by the size of the tone opening. For a chamber of given dimensions, the reverberation time is increased as the area of the tone opening is reduced. A large chamber, therefore, may have a large tone opening and still furnish sufficient reverberation, whereas a small chamber might require a very small opening. A chart is shown in Figure 1, giving the area of tone opening required to furnish one second reverberation time when the volume of the chamber is known. This chart is for chambers with dimensions in the ratio of 2 : 3 : 4 1/2 only, however, in practice the areas of tone opening shown are generally satisfactory.

The tone opening should be located in the largest wall surface of the chamber if possible, and preferably near the center of the wall area.

INSTALLATION AND MAINTENANCE

The organ must be connected to a regulated-frequency source of the voltage and frequency specified on the name plate. If the frequency is not regulated the pitch of the organ will be irregular.

When a console is set up for operation the anchoring must be loosened so that the generator will float freely on its spring suspension system. No damage will result if this is not done, but the console will sound noisy, and the same is true if the anchoring is loosened but the console is not level. If the console is to be moved a long distance the anchoring should be tightened during such moves.

Several different types of anchoring have been employed and instructions for loosening and tightening the generator in any particular console are given on the instruction card contained in the bench which accompanied that console.

Each power amplifier has anchoring which should be loosened on installation and tightened for shipping. If the cabinet has a reverberation unit, it should be locked before moving the cabinet and the fluid should be removed as instructed on the card attached to the tone cabinet.

The tone generator is lubricated by putting oil into cups inside the console. It is recommended that each cup be filled three-fourths full, (1 tablespoon) once a year, using only the oil recommended for this purpose.

CABLES

Each console is shipped from the factory with cables sufficient for an ordinary installation having a single tone cabinet. It has a 15 foot 2 conductor line cord for connecting to an AC wall outlet, and a 35 foot console-to-cabinet cable (6 conductor or 5 conductor, depending on the console model) to connect to the first power amplifier. In case the console is located an unusually long distance from the tone cabinet, additional 4 or 5 conductor cable must be ordered. If the console has an echo switch, a 5 conductor cable of the required length must be ordered separately to connect it to the echo tone cabinet. (See "Echo Organ Wiring", on the following page).

For installations having two or more tone cabinets, cable suitable in length must be secured to connect between cabinets. Each power amplifier has a 6 pole input plug and a 5 pole coupling receptacle for connecting additional amplifiers.

TYPES OF CABLES USED

6 Conductor console-to-cabinet cable used only on models A, B, BA, BC, BGV, BV, C, CV, D, DV, E, G, RT. This is used only between these models of consoles and the first power amplifier, and has a 6 pole plug at one end and a 6 pole receptacle at the other. It consists of two AC wires, two grid (signal) wires, a B plus wire to carry plate current from the first power amplifier to the console preamplifier, and a ground (signal return) conductor, which is actually a shield over the B plus wire. This cable is especially designed for use with the Hammond Organ and is approved by the Underwriters' Laboratories for that purpose.

5 Conductor console-to-cabinet or cabinet-to-cabinet cable. This is identical to the 6 conductor cable except that it has no shield and one end has a 5 pole plug instead of a 6 pole plug. It has no B plus conductor, the fifth wire being used for ground. It is used for carrying power and signal between amplifiers, since a B plus connection is never needed beyond the first power amplifier, to connect an echo cabinet, since in this case also no B plus connection is required, and as a console-to-cabinet cable for models where the console preamplifier has its own power supply. In case 5 conductor bulk cable is not available, a 5 conductor cable assembly may be made from 6 conductor bulk cable, using the shielded wire for ground and leaving the shield disconnected. NOTE: 5 conductor console-to-cabinet cable is used with Models B-2, B-3, C-2, C-3, RT-2, RT-3 A-100 & D-100.

3 Conductor cabinet-to-cabinet cable. This is used for carrying only the signal between amplifiers, and is used for connecting cabinets when external AC power circuits are employed. It is standard 3 conductor indoor telephone cord and has 5 pole plugs on both ends. A cable may be made up with a number of plugs along its length in order to connect several cabinets together. This wire can be secured from your local electrical jobber.

2 Conductor line cord. This supplies AC power to the console and has a standard attachment plug on one end and a standard attachment receptacle on the other.

2 Conductor cabinet power cord. This is used to furnish AC power to additional power amplifiers, when the signal is supplied through a 3 conductor signal cable. It has a standard attachment plug at one end and a 6 pole receptacle at the other.

All cables with the exception of the 3 conductor may be ordered in lengths as shown on current price list, with or without connectors attached. Figure 10 shows how all connectors are wired.

For permanent installations, when the cables are to be installed in conduit, special "Jones" fittings manufactured by the Cinch Manufacturing Company are obtainable through your electrical supplier. Those recommended for console location are

- 1-S406-CCE 6 prong socket
- 1-P406-WP 6 prong plug with wall plate

For each tone cabinet location:

- 1-P406-CCE 6 prong plug
- 1-S406-WP 6 prong socket with wall plate

BLOCK DIAGRAMS

Figure 1 is a simplified diagram showing how the console is connected to a single tone cabinet or group of cabinets drawing not over 620 watts input. This is the maximum AC power which can be supplied through the console without damaging the console switch or wiring. The name plate on each cabinet shows its wattage rating.

If the tone cabinet requirements exceed 620 watts, some of the cabinets must be supplied from a separate AC source as indicated in figures 2 and 3. Figure 2 is the preferred method, employing a relay to turn on the additional cabinets. The relay must have a coil of the same voltage and frequency rating as the organ, and must have contacts suitable for carrying the amount of power drawn by the additional cabinets. Allen-Bradley Bulletin 700 relays are suitable for this purpose and may be obtained from your electrical supplier.

When the AC power is supplied separately to additional cabinets, as in figures 2 and 3, a 3 conductor cable is sufficient to carry the signal between cabinets.

DETAILED WIRING DIAGRAMS

Figures 4, 5, and 6 are detailed versions of figure 1. In figure 4 the console is connected to one tone cabinet having a single amplifier, and figure 5 shows connections to a cabinet with two power amplifiers, connected together by a 5 conductor coupling cable. Additional amplifiers, up to a maximum of 620 watts AC input, may be connected as shown in figure 6.

Figure 7 is a detailed diagram of the arrangement in figure 2. The 3 conductor cable carries signal to all cabinets, while each cabinet has its own AC power cord. In this case the 6 pole input plug in each additional cabinet is used for power input only, and the signal is fed into the 5 pole coupling receptacle.

A switch may be connected in place of the relay contacts to convert this circuit to the arrangement of figure 3.

ECHO ORGAN WIRING

Some desirable musical effects may be secured by an "echo" tone cabinet installed at a location some distance from the main cabinet or cabinets. As indicated in the block diagram, figure 8, an echo switch on the console controls only the tone cabinet signal circuits, and all cabinets remain energized so that they will sound instantly when desired. Figure 9 shows the cable connections required.

REVERBERATION EQUIPMENT

Some types of tone cabinets have reverberation units and reverberation preamplifiers built into them. In this case, see the instruction card attached to the cabinet for correct cable connections. While there are several different styles of wiring, it will be found that every cabinet has a 6 pole input plug and a 5 pole output receptacle for connecting additional amplifiers. Some reverberation preamplifiers employ a special detachable coupling cable, wired as shown at the bottom of figure 10.

In reverberation-equipped tone cabinets type QR-20, DR-20, ER-20, FR-40, and G-40, reverberation is applied to all organ frequencies. In this case only one reverberation unit is required for any installation, no matter how many tone cabinets are used. The reverberation unit should be in the cabinet which is connected directly to the console, in order that reverberated signal may be supplied by it to all other cabinets.

In Multi-channel tone cabinets type JR-20, HR-40, KR-40, PR-20, PR-40 and QR-40 a reverberated signal is not available to drive succeeding cabinets. For this reason an installation using several such cabinets must have a reverberation unit in each cabinet if it is desired that reverberation be present in all cabinets.

It is not recommended that Multi-channel cabinets be driven by a reverberated signal from a preceding cabinet because irregularities in the bass response of the reverberation system may be emphasized by the bass amplifier channel. In case one of these cabinets is to be used with one or more reverberation cabinets of other types, it should be connected directly to the console, with the other cabinets following it in the usual way.

Further information on types of reverberation equipment will be found in the section dealing with this item.

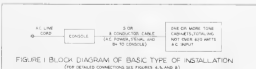

FIGURE 1 BLOCK DIAGRAM OF BASIC TYPE OF INSTALLATION
(FOR DETAILED CONNECTIONS SEE FIGURES 4, 5, AND 6)

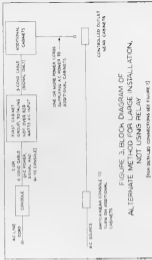
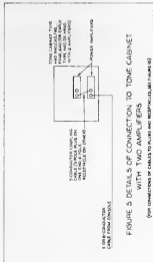
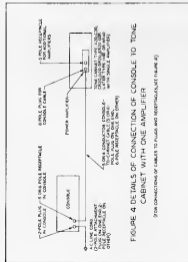

FIGURE 4 DETAILS OF CONNECTION TO TONE CABINET WITH TWO AMPLIFIERS

(FOR CONNECTIONS OF CABLES TO PLUGS AND RECEPTABLES, SEE FIGURE 4)

FIGURE 2 BLOCK DIAGRAM OF LARGE INSTALLATION (WITH TONE CABINETS TOTALING MORE THAN 620 WATTS AC INPUT), USING POWER RELAY

(FOR DETAILED CONNECTIONS, SEE FIGURE 1)

FIGURE 3 BLOCK DIAGRAM OF ALTERNATE METHOD FOR LARGE INSTALLATION, NOT USING RELAY

(FOR DETAILED CONNECTIONS, SEE FIGURE 1)

EXTENDING SPEAKERS

When using one or more 20-watt kits in an installation it is sometimes necessary, because of lack of space or for convenience in future servicing, to place the amplifiers some distance from the speakers. Should this become necessary, the leads to the speakers can be consolidated in four conductors, as Figure 11 shows how this is accomplished, using the two male plugs on the speakers. In this arrangement the field connections are not necessary.

The conductors used for this extension must have insulation to withstand 300 volts and wire size should not be less than #14. Ordinary #14 house-wiring wire, with rubber or plastic insulation, is suitable.

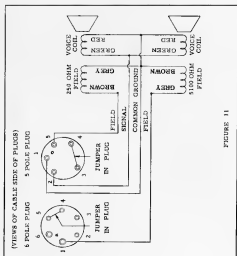

FIGURE 11

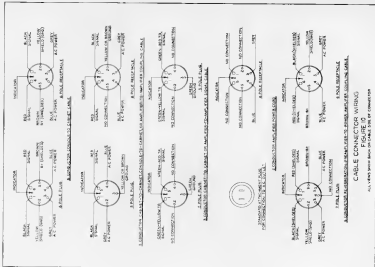

FIGURE 10

All values given based on cable size for connection

MAIN GENERATOR - GENERAL DESCRIPTION

Each Hammond Organ console has a main generator within it, and in some cases, depending on the model, a chorus generator. This section describes the main generator, illustrated below.



Figure 1

The main generator assembly consists of the generator proper, a shaded pole induction motor for starting, a non-self-starting synchronous motor for driving the unit after it is started, and either a tremulant switch mechanism or a Vibrato Scanner mounted on the synchronous motor. The entire assembly is mounted on two long steel angles which also provide the means of mounting the tone generator in the console. The method of mounting is such as to minimize the transmission of vibration from the tone generator to the console.

A drive shaft, resiliently coupled to the synchronous running motor, extends the entire length of the generator. Twenty-four driving gears, two each of twelve sizes, are mounted on this shaft, and the drive shaft itself is divided into several sections connected by flexible couplings. The starting motor is mounted at the end of this drive shaft, opposite the synchronous motor. Section 7 describes the starting procedure.

The main generator proper is a long structure in which are mounted 48 rotating assemblies, each consisting of a shaft and two discs known as tone or phonic wheels. These assemblies are coupled resiliently to the drive shaft. Each of the driving gears engages two bakelite gears associated with opposite rotating assemblies (See Figure 2). These bakelite gears rotate freely on the shafts with the tone wheels, and are coupled to their respective assemblies by a pair of coil springs. There are 12 sizes of bakelite gears, corresponding to the 12 sizes of driving gears. Thus 4 of the tone wheel assemblies, each with 2 tone wheels, run at each of 12 speeds.

Each tone wheel is a steel disc about 2 inches in diameter, accurately machined with a definite number of high and low points on its edge (See Figure 3). Each high point on a tone wheel is called a tooth. The number of teeth on each of these tone or phonic wheels, in conjunction with the speed at which the tone wheel is revolving, determines the frequency of the tone generated.

Each driving gear, with its two bakelite gears and four tone wheels, runs in a separate compartment magnetically shielded from the rest by steel plates which divide the generator into a series of bins.

All four tone wheels in any one compartment run at the same speed. The individual tone wheel shafts are mounted in bearings made of a special porous bronze and each of these bearings is connected to the oiling system by a cotton thread from the oil trough. Thus, oil from the trough is carried by capillary action to all bearings, penetrating them and lubricating the actual bearing surface. The drive shaft and both motors are lubricated in a similar manner. It is very important to use the recommended grade of oil regularly, as it is essential to the proper operation of the organ that the generator be well lubricated. If oil of varying grades is used, it is likely that the generator may be sluggish in starting, and in time the threads may **gum up and prevent the proper flow of oil.**

The two spring couplings on the motor shaft, the flexible couplings between sections of the drive shaft, and the tone wheel spring couplings all contribute to absorbing variations in motor speed. The synchronous motor does not deliver absolutely steady power, but rather operates with a series of pulsations, one with each half cycle. If the tone wheels were rigidly coupled to the motor, this slight irregularity would carry extra frequencies into each tone wheel. In addition, "hunting" is suppressed by the resilient couplings and inertia members of the synchronous motor proper.

Associated with each tone wheel is a magnetized rod about 1/4 of an inch in diameter and 4 inches in length, with a coil of wire wound near one end (See Figure 3). The tip of the magnet at the coil end is ground to a sharp edge and mounted near the edge of the tone wheel. Each time a tooth passes this rod it causes a change in the magnetic field which induces a small voltage in the coil, the frequency being determined by the number of teeth and the wheel speed.

Small coils are used on the higher frequency magnets and larger coils on the lower frequencies. It is found that large pole pieces are needed on the low frequency magnets to give good frequency output, but it is necessary to use smaller ones on the high frequencies to prevent excessive iron losses.

Some of the coils have copper rings mounted on them for the purpose of reducing harmonics. As these are used only on fairly low frequency coils, the eddy current loss in such a ring is small for the fundamental frequency of that coil, but high for its harmonics. This has the effect of reducing the relative intensities of any harmonics which may be produced by irregularities in the tone wheels. The wheels are cut so to give as nearly a sine wave as possible, but the generated voltage seldom reaches that ideal condition, since even a change in the air gap will change the wave form. The tip of each magnet, as well as the edge of each tone wheel, is coated with lacquer to prevent corrosion, for, should oxidation set in, the change in tooth shape would introduce irregular frequencies.

Locations of the various magnet and coil assemblies are shown in Figure 4. They are identified by their frequency numbers, and the broken line between any two numbers indicates that these two frequencies are supplied by one tone wheel assembly.

Each magnet is set at the factory with the set screw partially loosened, while observing an output meter. Experience has shown that the magnets seldom need adjustment and that setting them without proper equipment involves danger of damaging both magnet and wheel. Therefore it is not recommended that the service man attempt this adjustment.

As a means of eliminating any vagrant harmonics that may be present, there are filters consisting of small transformers and condensers associated with certain frequencies. The transformers have a single tapped winding, and this tap is grounded, so one side, which is connected to the corresponding magnet coil through a condenser, forms a resonant circuit for the fundamental frequency of that coil. This tends to emphasize the fundamental and suppress harmonics.

Locations of these transformers are shown in Figure 5 and 6. They are also shown in schematics in section 2.

These transformers and condensers are mounted on the top of the generator assembly. The transformers are mounted at an angle, thus minimizing interference between them. The cores of the transformers are made of a special iron, and the number of laminations used is adjusted to secure the proper inductance. Wires from the magnet coils connect to the transformers, and wires from the transformers lead to the terminal strip on the generator.

This terminal strip carries the output frequencies of the generator, which are arbitrarily numbered from 1 to 91 in order of increasing frequency. This frequency numbering is continued throughout the instrument. In some models the frequencies are not in order on the terminal strip, and Figures 5 and 6 indicate the arrangement for different models. Several terminals at the right end are grounded to the generator frame and serve to ground the manuals and pedals.

Transformers and condensers are not used below frequency 44, but a length of resistance wire shunts each generator. Frequencies 44 to 48 have transformers only, while both transformers and condensers are used for frequencies 49 to 91 except in the case of Model A consoles numbered below 2179, which do not have condensers for frequencies 49 to 54 inclusive.

Two condenser values are used - 0.255 mfd for frequencies 49 to 54, and 0.165 mfd for frequencies 55 to 91. The transformers are all different. Each transformer is matched to its condenser and any replacements are supplied as matched pairs by the factory.

There are several types of generators in use and the following information will aid the service technician in identifying the console on which work is being performed.

91 Frequency Generator

Model A serial No. 1	- 2676	Model D serial No. 1	- 3143
Model B serial No. 6000	- 16,549	Model E serial No. 8000	- 8663
Model C serial No. 1	- 1247	Player consoles serial No. 9000	- 9209

The number of tone wheels on the above models is 91, and 5 blank wheels are used to maintain the balance of the rotating units. There are twelve wheels with two teeth, one to operate at each of twelve speeds, and similarly twelve have four teeth, twelve have eight teeth, twelve have sixteen, twelve have thirty-two, twelve have sixty-four, twelve have one

hundred and twenty-eight and seven have one hundred ninety-two. An assembly with a two-tooth wheel also has a thirty-two tooth wheel which generates a frequency four octaves above the other. The four and sixty-four tooth wheels go together, as do the eight and one hundred twenty-eight tooth wheels. The twelve sixteen tooth wheels are mounted with seven one hundred ninety-two tooth wheels and the five blank wheels. In this last group the high frequency is not four octaves above, but is four octaves less five semi-tones above the lower.

This arrangement gives a total of 91 frequencies that are connected to corresponding terminals on the generator, and then to the manuals and pedal switch. In all cases, as mentioned above, the generator must be used with corresponding manuals and pedal switches and other types of generators cannot be substituted.

82 Frequency Generator

Model A serial No. 2677	- 2711	Model D serial No. 3144	- 17,074
Model B serial No. 10,550	- 17,074	Model E serial No. 8664	- 8739
Model C serial No. 1248	- 17,074	Model G serial No. 4101	- 7349
Player consoles serial No. 9210 only.			

In the above consoles, frequencies #1 to 9 have been omitted from the generator, and only 82 generator terminals are used. Similarly, there are only 82 tone wheels and magnets in the generator instead of 91. Blank wheels replace the nine two-tooth tone wheels formerly used to produce frequencies 1 to 9.

This generator change accompanies a wiring revision in the manual and pedal switches which makes the frequencies from 1 to 9 unnecessary. Generators having but 82 frequencies are easily identified by a blank space on the terminal strip at the left of the ground terminals. The first terminal at the left of this space is terminal #10.

91 Frequency Generator with Complex Tone Wheels

Model BV serial No. 17075	- 29737
Model CV serial No. 17075	- 30287
Model RT serial No. 1001	- 1201
Model B-2 serial No. 35000	- 40301
Model C-2 serial No. 35001	- 40459
Model RT-2 serial No. 1390	- 2150

In the above consoles, the original two-tooth wheels in the generator have been replaced with twelve two-tooth complex tone wheels, which supply a fundamental tone that is enriched with the odd-number harmonics. Both manuals and pedal switch are wired differently and are therefore not interchangeable with earlier models.

Model B-2 serial No. 40304 and above

Model C-2 serial No. 40460 and above

Model RT-2 serial No. 2353 and above

All Models
A-100, B-3, C-3
D-100

This generator has twelve complex tone wheels and is identical to the one above except for the generator cover. Because the output terminals of this cover are not in order of frequency (See Figure 6) this type of generator is not interchangeable with the one above.

Model M Tone Generator

The generator used in Spinet Models M and M-2 has 86 tone wheels and differs from other models in several other respects. The twelve complex-tone wheels are different in shape from those used in other models, and the generator-to-manual cable connects directly to the filter transformer terminals. For details, refer to Model M or M-2 service book.

When ordering replacement generators be sure to state model and serial number of console, as generators are not interchangeable.

Note: Consoles have been made equipped with 115 volt 25 or 50 or 60 cycle and 230 volt 50 cycle generators. If the owner is contemplating moving to a location having a different frequency of current, the complete generator must be changed. Where voltage changes only are encountered, step-up or step-down transformers will be necessary.

Generator Anchoring

When a console is set up for operation the anchoring must be loosened so that the generator will float freely on its spring suspension system. No damage will result if this is not done, but the console will sound noisy, and the same is true if the anchoring is loosened but the console is not level. If the console is to be moved a long distance the anchoring should be tightened during such moves.

Several different types of anchoring have been employed and instructions for loosening and tightening the generator in any particular console are given on the instruction card contained in the bench which accompanied that console.

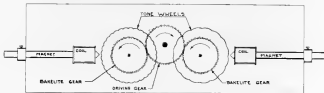

SECTION OF MAIN GENERATOR

Figure 1



TONE GENERATOR

Figure 2



RACK VIEW OF MAIN GENERATOR



FRONT VIEW OF MAIN GENERATOR

GENERATOR MAGNET LOCATIONS

Figure 4.

(Numbers shown are frequency numbers)

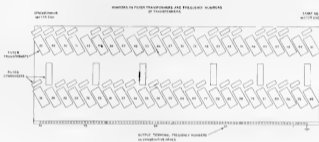

FIGURE 5 - MAIN GENERATOR COVER

WINDING END WINDING END AND START NG WINDING END
 MODEL 9-2 SERIAL NUMBER 40000 AND ABOVE
 MODEL 9-2 SERIAL NUMBER 40000 AND ABOVE
 MODEL 9-2 SERIAL NUMBER 40000 AND ABOVE



FIGURE 6 - MAIN GENERATOR COVER

WINDING END WINDING END AND ABOVE
 MODEL 9-2 SERIAL NUMBER 40000 AND ABOVE
 MODEL 9-2 SERIAL NUMBER 40000 AND ABOVE

CHORUS GENERATOR

(Used in models BC, D, E, and G)

The purpose of the chorus generator is to add a series of slightly sharp and slightly flat tones to the true tones produced by the main generator. The resulting electrical wave contains a complex series of undulations which enhance the pleasing effect of many tone qualities, notably string and full organ combinations. It should be noted that no chorus effect is produced on frequencies below 56.

The frequencies covered by the chorus generator are numbers 56 to 91 inclusive on the main generator. The difference in frequency between the main generator and either flat or sharp tone is .3% for frequencies 56 to 67 and .4% for frequencies 68 to 91. It is necessary that a lesser percentage of frequency difference be present in the higher register in order to avoid too rapid undulation.

The chorus generator assembly, like the main generator, has a drive shaft with twenty-four brass gears. Each gear drives a single assembly consisting of two tone wheels. The drive gears vary as to the number of teeth, and the tone wheels operate at twenty-four different speeds. This generator has forty-eight tone wheels, each with a separate magnet and pick-up coil. Of these tone wheels, twenty-four are single and twenty-four are double (see Figure 1). The double tone wheels consist of two discs with different numbers of teeth mounted on one brass hub. The single wheels are electrically connected in pairs, each pair being connected as to have the same effect as one double wheel.

Figure 2 is a complete wiring diagram for connections between main and chorus generators, and Figure 3 is a back view of the chorus generator indicating the frequency number of each magnet.

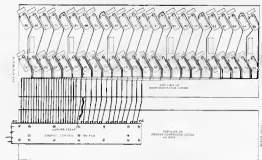

NOTE: NUMBERS SHOWN ON FILTER TRANSFORMERS ARE FREQUENCY NUMBERS.

CABLE CONNECTIONS TO CHORUS GENERATOR

Figure 2.

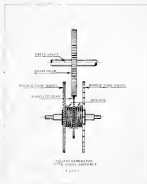

CHORUS GENERATOR MAGNET LOCATIONS

Figure 3

CONSOLE POWER WIRING (Main and Chorus Generators)

Starting and Synchronous Motors

A shaded pole induction motor is used for starting the generator and is located at the right end of the generator as viewed from the back. The rotor of this motor will slide endwise when current is supplied and engage a pinion on its shaft with a gear on the generator driving shaft, bringing the tone generator up to slightly greater than synchronous speed.

When the organ is started, the starting switch is turned on and held for about 5 seconds while the starting motor brings the system up to speed. The "run" switch is then turned on. This switch simultaneously connects the synchronous motor and introduces a resistor in series with the starting motor (Figure 1), thus reducing its driving power. With a braking action of the synchronous motor and a loss of power of the starting motor, the system slows to synchronous speed and the synchronous motor begins to carry the load. A period of about 5 seconds should be allowed for this to take place, after which the starting switch may be released. The starting switch springs back to the "off" position, and turns off the starting motor, which is disengaged from the rotating shaft by a spring.

It should be noted that the synchronous motor can supply power only at synchronous speed. Therefore, if for any reason the system fails to reach synchronous speed it will not continue to run after the starting switch is released. Failure to start properly is usually due to increased oil viscosity and may be overcome by an increase in starting time.

As the schematic diagram (Figure 1) indicates, the "run" switch in its "off" position shorts out the wirewound resistor attached to the line panel. If the "run" switch is defective in its "off" position, the generator will not start because this resistor will be permanently in series with the starting motor. Before assuming that there is anything amiss with the motors, short out this resistor and start the generator in the normal manner. If the generator operates satisfactorily, replace the "run" switch.

The "run" switch on all consoles is a two-circuit switch, but types of switches having two different terminal arrangements have been used, as shown in Figure 2. When replacing a switch, observe the wiring of the old switch and check the connections of the new switch with an ohmmeter. Note that black and blue are connected in the "on" position, and yellow and brown are connected in the "off" position, no matter which type of switch is used.

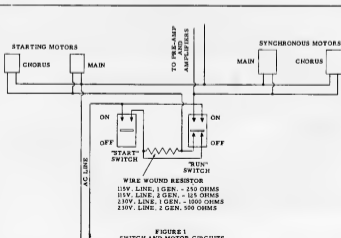

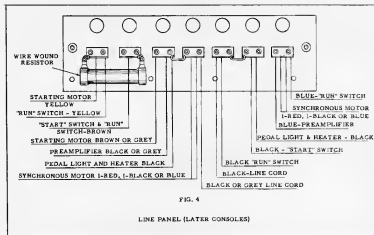
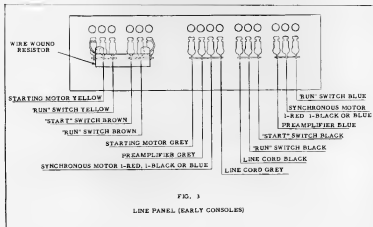
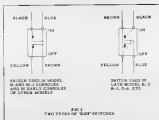

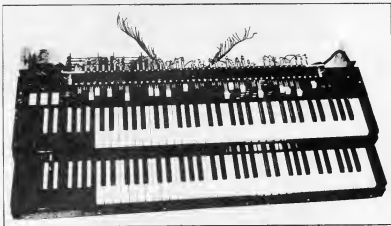

Figure 1

A TYPICAL MANUAL CHASSIS ASSEMBLY (Model B-2)
For Description of Controls See Section 2.

Manual Chassis Assembly - Models A, AV, B, BA, BC, BCV, BV, C,
CV, D, DV, G, GV, RT.

The manual chassis assembly, Fig. 1, which includes the upper and lower manuals and the preset panel, has a terminal strip under each manual made up of 82 or 91 terminals, depending on the generator being used, to accommodate the frequencies from the tone generator assembly. Each manual has 61 playing keys, 9 preset keys, and 2 adjust keys, each of which operates nine small bronze contact springs with precious metal points (See Figure 2). When a key is pressed these points make contact with nine busbars extending the entire length of the manual. The busbars also have precious metal contact surfaces.

The nine contact springs under each key carry the nine harmonics of the particular note with which they are associated (See Figure 3) and are connected by resistance wires to the proper terminals on the terminal strip. Therefore all key contacts are alive whenever the generator is running. See schematic diagram of console in Section 2.



Figure 2



Figure 3

When a playing key is pressed, its name frequencies are impressed on the nine busbars of the manual. As there are no wires connected to these busbars, a preset or adjust key must be depressed before any circuit can be completed. Each preset and adjust key has nine contacts exactly like those of the playing keys. These keys have a locking and trip mechanism which allows only one key to be in operation at one time. The key at the extreme left end of the manual is a cancel key, with no contacts, which releases any preset or adjust key that happens to be depressed. (Also see Page 15)

The adjust keys, A# and B, are connected by flexible wires, color-coded for easy identification, to the corresponding name drawbars. The drawbars slide over nine busses which are connected to taps on the matching transformer. These correspond to different intensities of sound as shown by numbers on the drawbars.

The two left groups of drawbars are associated with the upper manual, while the two right groups work in conjunction with the lower manual. In each case the A# adjust key controls the left hand group of drawbars for that manual.

The nine preset keys, from C# to A inclusive, are wired to flexible leads terminating at the preset panel in the back of the console, where the various tone colors are set up by connecting each wire to a screw terminal corresponding to the desired intensity of the harmonic. These screw terminals are located on 9 horizontal bars, each representing a certain intensity for all wires attached to that bar.

The drawbar busses and the preset panel bars are connected in parallel to taps on the primary of the matching transformer.

Manual Chassis Assembly - Models B-2, C-2 and RT-2

In these selective vibrato consoles, the individual manuals are the same as in other models but the drawbar assembly is different, having three tilting tablets ("Vibrato Swell On-Off," "Vibrato Great On-Off" and "Volume Soft-Normal") at the left of the vibrato switch knob.

The selective vibrato feature requires that the preset panel and drawbar assembly be divided and connected to two matching transformers, each serving one manual. See schematic diagram in Section 2. The Great, or lower manual, matching transformer also serves the pedal keyboard.

Continuous-contact drawbars are used in later consoles of this type. They operate more smoothly and require less accuracy of adjustment than the earlier type having nine definite positions or steps. Each one has two contacts connected together by a one ohm resistor, so that at least one of the contacts touches some bus at all times and there are no "dead spots" in the drawbar motion. The resistor avoids short-circuiting adjacent busbars.

Manual Chassis Assembly - Models B-3, C-3, RT-3, A-100 & D-100

The above description also applies to these models, but the start and run switches are relocated to provide room for four tilting tablets which control the Percussion feature, described in Section 10. All manual chassis assemblies are equipped with continuous contact drawbars.

Manual Chassis Assembly - Model E

The appearance of the upper, or swell manual, and the lower, or great manual, is the same as on other models except that numbered pistons are used instead of preset keys. These pistons operate in exactly the same manner, and produce the same effects, as do the preset keys on the other models.

The internal wiring of the manuals is to a large extent the same as in other models, but the use of two tremulants requires that the preset panel and drawbar assembly be divided, and that two matching transformers be used, each manual being connected to its own matching transformer.

Manual Busbar Shifters

The precious metal contact surfaces of the key contacts and busbars are not subject to corrosion, and the manuals are sealed to exclude dust as far as possible. In spite of these precautions an occasional particle of dust may jam on a contact and cause the note to be scratchy, noisy, or silent, and for this reason a busbar shifting mechanism is provided on each manual to slide the busbars endwise and thus provide a fresh contact surface. The busbar shifter for each manual is a slotted stud near the right end of the manual as viewed from the back of the console (see rear view of console in Section 2 for location).

If any note becomes scratchy or silent, it should first be struck 15 or 20 times in a rapid staccato manner to loosen the dirt. This will usually dislodge the particles and clear the note.

In case this procedure is not effective, the busbar shifter for that manual may be adjusted by turning the stud about two turns in either direction. It may sometimes be necessary to hold down the offending key while turning the busbar shifter, in order to wipe the contact clean.

Model A consoles below serial number 995 are not equipped with busbar shifters except in cases where the manual chassis and pedal switch have been rebuilt. Full information on this rebuilding may be obtained from the Organ Service Department of the Hammond Organ Company.

Manual Wiring - Models A, AV, B, BA, BC, BCY, BV, C, CY, D, DV, E, G, GV, RT.

Figure 4, a wiring chart for the playing manuals, will be helpful in tracing difficulties associated with the generator or manuals. All playing manuals are wired alike from drawbar 2 to drawbar 8 inclusive, but the wiring of drawbars 1 and 9 varies. Column "A" shows the wiring of drawbar 1 for consoles above serial number 17075; column "B" refers to all consoles having 12 note generators; and column "C" is the wiring used in all earlier consoles. Column "D" shows wiring of drawbar 9 for Model "A" consoles below serial number 3500 and Model "BC" console below 5078; column "E" refers to all later consoles.

These variations in wiring are designed to match the different type of generators described in the section covering tone generators, and therefore the various types are not interchangeable.

Manual Wiring - Models B-2, B-3, C-2, C-3, RT-2, RT-3, A-100 & D-100
The key circuit wiring for these models is the same as for previous consoles above serial number 17075, and so columns "A" and "E" in figure 4 apply.

Manual Wiring - Model M Series.
The frequency chart in this section does not apply to these models because they have fewer keys on each manual and have a slightly different arrangement of harmonics. Full details will be found in the service booklets covering these models.

Key Number	Note	"A" "B" "C"								"D" "E" "G"					
		(See text)								(See text)					
		Drawbar 1 Sub-Pedal	Drawbar 1 Sub-Pedal	Drawbar 1 Sub-Pedal	Drawbar 1 Sub-Pedal	Drawbar 1 Sub-Pedal	Drawbar 1 Sub-Pedal	Drawbar 1 Sub-Pedal	Drawbar 1 Sub-Pedal	Drawbar 1 Sub-Pedal	Drawbar 1 Sub-Pedal	Drawbar 1 Sub-Pedal	Drawbar 1 Sub-Pedal	Drawbar 1 Sub-Pedal	Drawbar 1 Sub-Pedal
1	C	13	13	1	20	13	13	13	27	43	44	49	48		
2	C#	14	14	2	21	14	14	14	28	45	45	50	49		
3	D	15	15	3	22	15	15	15	29	46	46	51	51		
4	D#	16	16	4	23	16	16	16	30	47	47	52	52		
5	E	17	17	5	24	17	17	17	31	48	48	53	53		
6	F	18	18	6	25	18	18	18	32	49	49	54	54		
7	F#	19	19	7	26	19	19	19	33	50	50	55	55		
8	G	20	20	8	27	20	20	20	34	51	51	56	56		
9	G#	21	21	9	28	21	21	21	35	52	52	57	57		
10	A	22	22	10	29	22	22	22	36	53	53	58	58		
11	A#	23	23	11	30	23	23	23	37	54	54	59	59		
12	B	24	24	12	31	24	24	24	38	55	55	60	60		
13	C	25	25	13	32	25	25	25	39	56	56	61	61		
14	C#	26	26	14	33	26	26	26	40	57	57	62	62		
15	D	27	27	15	34	27	27	27	41	58	58	63	63		
16	D#	28	28	16	35	28	28	28	42	59	59	64	64		
17	E	29	29	17	36	29	29	29	43	60	60	65	65		
18	F	30	30	18	37	30	30	30	44	61	61	66	66		
19	F#	31	31	19	38	31	31	31	45	62	62	67	67		
20	G	32	32	20	39	32	32	32	46	63	63	68	68		
21	G#	33	33	21	40	33	33	33	47	64	64	69	69		
22	A	34	34	22	41	34	34	34	48	65	65	70	70		
23	A#	35	35	23	42	35	35	35	49	66	66	71	71		
24	B	36	36	24	43	36	36	36	50	67	67	72	72		
25	C	37	37	25	44	37	37	37	51	68	68	73	73		
26	C#	38	38	26	45	38	38	38	52	69	69	74	74		
27	D	39	39	27	46	39	39	39	53	70	70	75	75		
28	D#	40	40	28	47	40	40	40	54	71	71	76	76		
29	E	41	41	29	48	41	41	41	55	72	72	77	77		
30	F	42	42	30	49	42	42	42	56	73	73	78	78		
31	F#	43	43	31	50	43	43	43	57	74	74	79	79		
32	G	44	44	32	51	44	44	44	58	75	75	80	80		
33	G#	45	45	33	52	45	45	45	59	76	76	81	81		
34	A	46	46	34	53	46	46	46	60	77	77	82	82		
35	A#	47	47	35	54	47	47	47	61	78	78	83	83		
36	B	48	48	36	55	48	48	48	62	79	79	84	84		
37	C	49	49	37	56	49	49	49	63	80	80	85	85		
38	C#	50	50	38	57	50	50	50	64	81	81	86	86		
39	D	51	51	39	58	51	51	51	65	82	82	87	87		
40	D#	52	52	40	59	52	52	52	66	83	83	88	88		
41	E	53	53	41	60	53	53	53	67	84	84	89	89		
42	F	54	54	42	61	54	54	54	68	85	85	90	90		
43	F#	55	55	43	62	55	55	55	69	86	86	91	91		
44	G	56	56	44	63	56	56	56	70	87	87	92	92		
45	G#	57	57	45	64	57	57	57	71	88	88	93	93		
46	A	58	58	46	65	58	58	58	72	89	89	94	94		
47	A#	59	59	47	66	59	59	59	73	90	90	95	95		
48	B	60	60	48	67	60	60	60	74	91	91	96	96		
49	C	61	61	49	68	61	61	61	75	92	92	97	97		
50	C#	62	62	50	69	62	62	62	76	93	93	98	98		
51	D	63	63	51	70	63	63	63	77	94	94	99	99		
52	D#	64	64	52	71	64	64	64	78	95	95	100	100		
53	E	65	65	53	72	65	65	65	79	96	96	101	101		
54	F	66	66	54	73	66	66	66	80	97	97	102	102		
55	F#	67	67	55	74	67	67	67	81	98	98	103	103		
56	G	68	68	56	75	68	68	68	82	99	99	104	104		
57	G#	69	69	57	76	69	69	69	83	100	100	105	105		
58	A	70	70	58	77	70	70	70	84	101	101	106	106		
59	A#	71	71	59	78	71	71	71	85	102	102	107	107		
60	B	72	72	60	79	72	72	72	86	103	103	108	108		
61	C	73	73	61	80	73	73	73	87	104	104	109	109		
62	C#	74	74	62	81	74	74	74	88	105	105	110	110		
63	D	75	75	63	82	75	75	75	89	106	106	111	111		
64	D#	76	76	64	83	76	76	76	90	107	107	112	112		
65	E	77	77	65	84	77	77	77	91	108	108	113	113		
66	F	78	78	66	85	78	78	78	92	109	109	114	114		
67	F#	79	79	67	86	79	79	79	93	110	110	115	115		
68	G	80	80	68	87	80	80	80	94	111	111	116	116		
69	G#	81	81	69	88	81	81	81	95	112	112	117	117		
70	A	82	82	70	89	82	82	82	96	113	113	118	118		
71	A#	83	83	71	90	83	83	83	97	114	114	119	119		
72	B	84	84	72	91	84	84	84	98	115	115	120	120		

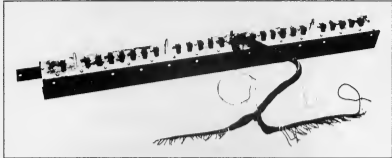

PEDAL SWITCH ASSEMBLY

Figure 5

Pedal Switch Assembly - All Models with 25 Note Pedal Keyboard

The pedal switch (shown in Figure 5) is similar in construction to the manuals except that only four busbars are included instead of nine. Each of the 25 pedals actuates a double set of contact springs, making eight contacts available for each note. Each note consists of a fundamental and number of harmonics, no sub-harmonics being used. The pedal contact springs are connected to terminals by resistance wires similar to those used in the manual assembly, and a cable connects these terminals through a wiring tube to the proper terminals on the generator terminal strip.

Four colored wires carry the pedal tones from the busbars to the pedal drawbars. In some models the wires are connected first to a resistor panel on the back of the manual assembly. A small choke coil and resistor mounted on the manual assembly are wired to the lower drawbar (see Figures 8, 9, 10, 11) and serve to filter out any higher harmonics or transients which might be present in the lower pedal frequencies.

Early consoles used only seven contacts on each pedal (see Figure 6) and were wired so that any harmonic would appear on only one pedal drawbar (Figures 8 and 9). Later consoles use all eight contacts (Figure 7) and employ a system for mixing the 16 ft. and 8 ft. tones (Figures 10 and 11). The harmonic arrangement of the contacts is also different in these later units.

Figure 13 is a wiring chart for the pedals, showing the frequency numbers appearing on each pedal contact. The variations in wiring make the pedal switches match the different types of generators described in the section covering tone generators, and therefore the various types are not interchangeable.

Specific pedal wiring of any console can be determined by obtaining the serial number and referring to Figures 6 to 11. Included in these sketches are references to Figure 13 wiring chart.

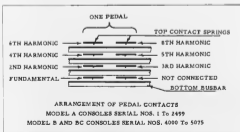

Figure 6

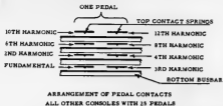

Figure 7



FIGURE 8 PEDAL CIRCUITS

MODEL A CONSOLES SERIAL NO. 1 TO 2499
MODEL B AND DC CONSOLES SERIAL NO. 4000 TO 5075

(FOR PEDAL WIRING SEE FIGURE 0, COLUMNS 1,4,5,6,7,8,9)

05 2013

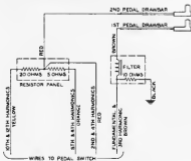

FIGURE 9 PEDAL CIRCUITS

MODEL A CONSOLES SERIAL NO. 2500 TO 3876
MODEL B AND DC CONSOLES SERIAL NO. 5076 TO 10549
MODEL BA (PLAYER) CONSOLES-ALL
MODEL C CONSOLES SERIAL NO. 1200 TO 1247
MODEL D CONSOLES SERIAL NO. 1 TO 3483

(FOR PEDAL WIRING SEE FIGURE 0, COLUMNS 1,4,5,6,8,9,10,11)

05 2014

2-21

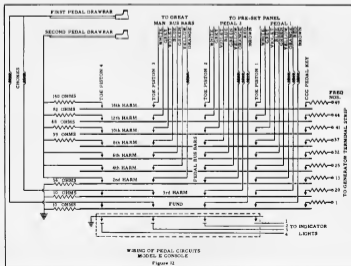
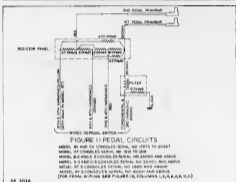
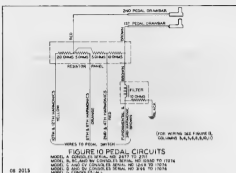



FIGURE 21

MODEL RT, RT-2, RT-3 and D-100

Pedal Switch Assembly

The pedal switch (shown in Figure 21) is similar in internal construction to the manuals (Figure 22). Each of the 32 pedals actuates a set of contact springs, making nine contacts available for each note. Each note consists of a fundamental and a number of harmonics, no sub-harmonics being used. The pedal contact springs are connected to terminals by resistance wires similar to those used in the manual assembly, and a cable connects these terminals to the proper terminals on the generator terminal strip. Only seven contacts are used for the mechanical generator notes, the other two contacts are used by the pedal solo unit as explained later in this book.

Four colored wires carry the pedal tones from the busbars to the pedal drawbars. The wires are connected first to a resistor panel on the back of the manual assembly. A small choke coil and resistor mounted on the manual assembly are wired to the lower drawbar (see Figure 23) and serve to filter out any higher harmonics or transients which might be present in the lower pedal frequencies.

Figure 24 is a wiring chart for the pedals, showing the frequency numbers appearing on each pedal contact.

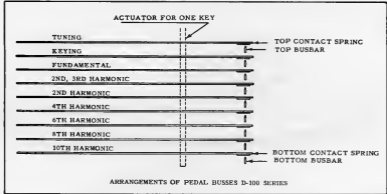

FIGURE 22

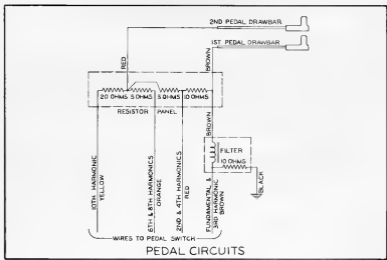

FIGURE 23

Pedal No.	Note	Fund	2nd and 3rd Harm.	2nd Harm.	4th Harm.	6th Harm.	8th Harm.	10th Harm.
1	C	1	13	13	25	32	37	41
2	C#	2	14	14	26	33	38	42
3	D	3	15	15	27	34	39	43
4	D#	4	16	16	28	35	40	44
5	E	5	17	17	29	36	41	45
6	F	6	18	18	30	37	42	46
7	F#	7	19	19	31	38	43	47
8	G	8		20	32	39	44	48
9	G#	9		21	33	40	45	49
10	A	10	No connection	22	34	41	46	50
11	A#	11		23	35	42	47	51
12	B	12		24	36	43	48	52
13	C	13	32	25	37	44	49	53
14	C#	14	33	26	38	45	50	54
15	D	15	34	27	39	46	51	55
16	D#	16	35	28	40	47	52	56
17	E	17	36	29	41	48	53	57
18	F	18	37	30	42	49	54	58
19	F#	19	38	31	43	50	55	59
20	G	20	39	32	44	51	56	60
21	G#	21	40	33	45	52	57	61
22	A	22	41	34	46	53	58	62
23	A#	23	42	35	47	54	59	63
24	B	24	43	36	48	55	60	64
25	C	25	44	37	49	56	61	65
26	C#	26	45	38	50	57	62	66
27	D	27	46	39	51	58	63	67
28	D#	28	47	40	52	59	64	68
29	E	29	48	41	53	60	65	69
30	F	30	49	42	54	61	66	70
31	F#	31	50	43	55	62	67	71
32	G	32	51	44	56	63	68	72
Frequency Number								

FREQUENCIES USED IN PEDAL SWITCH

FIGURE 24

Pedal Switch Busbar Shifters

The pedal switch is equipped with busbar shifters similar to those on the manuals. The pedal busbar shifter is a slotted stud on the rear surface of the pedal switch, near the right end as you look in at the back. It should be adjusted as described under "Manual Busbar Shifters" on a previous page.

Pedal Keyboard

Pedal keys are set at the factory for average tension, but are adjustable to fit the requirements of the individual organist. Adjustment is accomplished by removal of the top cover at the back of the pedal keyboard and setting the tension as desired.

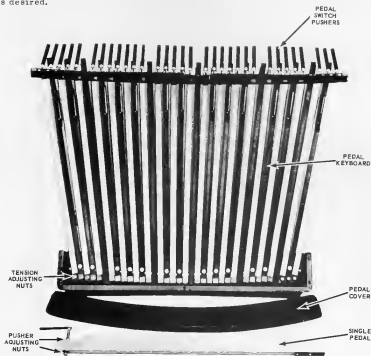

FIGURE 25

These models have a 32-note pedal switch assembly, and each note has nine contact springs which touch nine busbars. Colored wires carry the pedal tones from the busbars to the resistor panel and drawbars as shown in Figure 11. (See paragraph on "Wiring of Pedal Switch" in "Pedal Solo Unit" section of service manual).

Pedal Switch Assembly - Model E

Nine busbars are used in the Model E pedal switch assembly. Figure 12 illustrates the arrangement of these busbars and the nine contact springs of a typical pedal key. There are 32 pedal keys, and four pedal toe pistons. These pedal toe pistons, which correspond to the preset pistons of the manuals, also have nine contact springs touching the same nine busbars and have a locking arrangement by which only one piston remains in operation at one time.

Frequencies impressed on the busbars, when a pedal is played, are picked up by the contacts of the pedal piston which is in use, and go from there to the preset panel through pistons 1 or 2 or to the drawbars through piston 4. From the coupler (Piston 3) the upper seven harmonics connect to busbars in the great manual, while the lower two connect to the lower pedal drawbar and permit it to be used with the coupler. Connections from the pedals to the manual are indicated in Figure 12. A low voltage line from the pre-amplifier heater transformer operates the 2.5 volt pedal preset indicator lamps through the external contacts on the pedal switch. Several filter chokes and resistors mounted on the pedal switch are wired in series with leads from the lower pedal harmonics.

Pedal No.	Note	1	2	3	4	5	6	7	8	9	10	11	12
		Fund	2nd and 3rd Harm.	Fund and 2nd	2nd Harm.	3rd Harm.	4th Harm.	5th Harm.	6th Harm.	6th Harm.	10th Harm.	12th Harm.	16th Harm.
1	C	1	13	13	13	20	25	29	32	37	41	44	46
2	C#	2	14	14	14	21	26	30	33	38	42	45	50
3	D	3	15	15	15	22	27	31	34	39	43	46	51
4	D#	4	16	16	16	23	28	32	35	40	44	47	52
5	E	5	17	17	17	24	29	33	36	41	45	48	53
6	F	6	18	18	18	25	30	34	37	42	46	49	54
7	F#	7	19	19	19	26	31	35	38	43	47	50	55
8	G	8	20	20	20	27	32	36	39	44	48	51	56
9	G#	9	21	21	21	28	33	37	40	45	49	52	57
10	A	10	22	22	22	29	34	38	41	46	50	53	58
11	A#	11	23	23	23	30	35	39	42	47	51	54	59
12	B	12	No connection	13	13	20	25	29	32	37	41	44	46
13	C	13	32	32	32	37	41	44	49	53	56	61	65
14	C#	14	33	33	33	38	42	45	50	54	57	62	66
15	D	15	34	34	34	39	43	46	51	55	58	63	67
16	D#	16	35	35	35	40	44	47	52	56	59	64	68
17	E	17	36	36	36	41	45	48	53	57	60	65	69
18	F	18	37	37	37	42	46	49	54	58	61	66	70
19	F#	19	38	38	38	43	47	50	55	59	62	67	71
20	G	20	39	39	39	44	48	51	56	60	63	68	72
21	G#	21	40	40	40	45	49	52	57	61	64	69	73
22	A	22	41	41	41	46	50	53	58	62	65	70	74
23	A#	23	42	42	42	47	51	54	59	63	66	71	75
24	B	24	43	43	43	48	52	55	60	64	67	72	76
25	C	25	44	26	37	44	48	53	56	61	65	68	73
26	C#	26	45	38	45	50	54	59	62	67	71	74	79
27	D	27	46	39	46	51	55	60	63	68	72	75	80
28	D#	28	47	40	47	52	56	61	64	69	73	76	81
29	E	29	48	41	48	53	57	62	65	70	74	77	82
30	F	30	49	42	49	54	58	63	66	71	75	78	83
31	F#	31	50	43	50	55	59	64	67	72	76	79	84
32	G	32	51	44	51	56	60	65	68	73	77	80	85

Frequency Number

Pedals 26 to 32 Used in Model E, RT, RT-2, RT-3 & D-100 Only.
For Harmonics Used in a Given Console See Fig. 8-9-10-11-12.

FREQUENCIES USED IN PEDAL SWITCHES

Figure 12

Pedal Busbar Shifters

Pedal switches in all consoles (except Model A consoles below serial number 995) are equipped with busbar shifters similar to those on the manuals. The pedal busbar shifter is a slotted stud on the rear surface of the pedal switch, near the left end as you look in at the back. It should be adjusted as described under "Manual Busbar Shifters" on a previous page.

Pedal Keyboard

Pedal keys are set at the factory for average tension, but are adjustable to fit the requirements of the individual organist. Adjustment is accomplished by removal of the top cover at the back of the pedal keyboard and setting the tension nuts as desired.

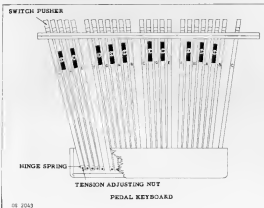

Figure 14

Preset Panel - Models A, AV, B, BA, BC, BCY, BY, C, CV, D, DV, G, GV, RT.

The tone signals from the preset keys on both manuals are carried by color-coded wires to the preset panel in the back of the console.

The preset panel is a set of nine bars, wired to the taps on the matching transformer, corresponding to different intensities of sound as shown by numbers stamped on the bars. Each preset wire, carrying a single harmonic, is fastened under a screw on the bar which represents the desired intensity of that harmonic. This is equivalent to setting a harmonic drawbar to the corresponding number.

When shipped, each organ has its presets set up as shown in the booklet, "Creating Beautiful Tone Colors with the Harmonic Drawbars," which may be obtained free on request. Preset combinations may be changed at will by removing the console back and following the directions on a card inside. This card is reproduced below. (Figure 15)

Preset Panel - Models B-2, B-3, C-2, C-3, RT-2, RT-3, A-100, D-100 & E

In these models the preset panel is divided into two sets of nine bars, each connected to a separate matching transformer. One set is used for the swell (upper) manual, and the other for the great (lower) manual and pedals. The preset panel on Model E is slightly longer than on the other models to accommodate the two pedal presets.

Directions for Making Pre-Set Panel Connections

There are 9 color-coded wires threaded through one of the lower holes for each pre-set key. Above each hole are 9 binding posts arranged in vertical order, and above the uppermost binding post is a name plate specifying the pre-set key associated with the row of wires below. The lowest binding post is that of zero strength and corresponds to a harmonic control pushed all the way in. The uppermost binding post is of 8 strength and corresponds to a harmonic control drawn all the way out. The bar-bar strips for each level are extended to the left where they are marked with their approximate strength numbers.

For example, suppose the combination 005324111 is to be set up on the D# of the upper manual. It will be found helpful, especially when setting several combinations, to use the following chart.—

Manual	Key	Brown	Red	Orange	Yellow	Green	Blue	Violet	Grey	White
Upper	D#	0	0	6	5	2	2	4	1	1
-----	-----	-----	-----	-----	-----	-----	-----	-----	-----	-----
-----	-----	-----	-----	-----	-----	-----	-----	-----	-----	-----
-----	-----	-----	-----	-----	-----	-----	-----	-----	-----	-----
-----	-----	-----	-----	-----	-----	-----	-----	-----	-----	-----
-----	-----	-----	-----	-----	-----	-----	-----	-----	-----	-----

Color Code Explanation		
Each group of 9 wires is color-coded as follows:		
Sub-Fundamental (brown drawbar)	brown wire	
Sub-3rd harmonic (brown drawbar)	red wire	
Fundamental (white drawbar)	orange wire	
2nd Harmonic (white drawbar)	yellow wire	
3rd Harmonic (black drawbar)	green wire	
4th Harmonic (white drawbar)	blue wire	
5th Harmonic (black drawbar)	violet wire	
6th Harmonic (black drawbar)	grey wire	
8th Harmonic (white drawbar)	white wire	

With a screw driver remove the connections already made on the D# "Upper Manual" row of binding posts and separate the 9 wires from each other. Referring to the chart above, the brown and red wires are twisted together and connected with the binding post on the level marked "0" (lowest level). Next, the white and grey wires are twisted together and inserted under the binding post on the level marked "1." Similarly, the green wire is connected on level "2," the blue wire on level "3," the violet wire on level "4," the yellow wire on level "5," and the orange wire on level "6." The wire used for the pre-set connections is standard "push-back" wire. The insulation is loose and should be pushed back to expose the desired length of bare wire. Never remove the insulation by skimming with pliers or a knife. After a connection has been made, push the insulation forward with the fingers as far as it will go. Be sure to twist the wires together so that there will be no stray strands connecting one bar with any other bar. The binding posts should be firmly tightened over the wires to insure good electrical contacts.

PO-2965-1

Figure 15

Matching Transformers

The matching transformer is used to match the low impedance of the generator and key circuits to the high impedance amplifier input. It serves also, through taps on its primary winding, to establish a series of intensity levels for the drawbars and preset panel.

The following types of matching transformers have been used. In most cases they are not interchangeable, and console serial numbers should be furnished when ordering replacements.

1. Large-core transformer, used in Models A, B, BA, BC, C, D, and G. These were enclosed in two sizes of shield cans at various times, but they are identical otherwise. Two transformers of this type were used to Model X.
2. Large-core transformer with taps revised. Matching transformers in organs with non-selective vibrato (Models BV, CV, DV, and RT) are slightly different from earlier models in the number of turns to the first three taps. If a transformer in an earlier organ is replaced by one of the newer type, any preset wires on preset panel bars 1, 2, and 3 should be set to the next higher bar in order to make the combination sound the same as before. For instance, combination 00 3543 111 with the old type transformer would become 00 4544 222 with the new one.
3. Small-core transformers used in selective vibrato organs Models B-2, C-2, and RT-2 having preamplifiers code A, B and C. Two transformers are used in each organ, one with large stack for the upper or swell manual, one with small stack for the lower or great manual and pedals.
4. Revised small-core transformers with smaller stack and greater number of turns. These are used in B-2 consoles serial number 42626 and above, C-2 consoles serial number 42675 and above, and RT-2 consoles serial number 2281 and above (having preamplifiers code D, E, F, G) and in B-3, C-3 and RT-3 consoles. Because differences in the preamplifier input circuits will cause irregular response, these transformers are not interchangeable with the previous type, unless the preamplifier is changed at the same time.
5. Model M uses a single small-core transformer without primary taps. Models M-2 and M-3 have two transformers, one for each manual, each transformer identical to the revised lower manual type described in paragraph 4 above.

OPERATION OF MECHANISM ON PRESET KEYS

In their basic construction the preset keys are identical to the playing keys. Each has a plastic key mounted on a metal channel, pivoted in the rear and with a guide toward the front to minimize side motion.

On the front edge of each channel of the 3 preset keys and 2 adjust keys, two flat springs are attached, one 5/8" long of rather stiff material, and another approximately 3/4" long of softer material. The softer long spring is sandwiched on top of the stiff spring, nearest to the key. The cancel key has only one heavy spring approximately 1" long.

When a preset key is depressed, the longer soft spring is forced downward and snaps under a tubular rod which is part of the cradle. The cradle is constructed of two tubes approximately 5" long and assembled 3/4" apart. One tube is used as a fulcrum, the entire assembly being mounted perpendicular to the preset keys. A spring and bumper hold the cradle at a 60° angle toward the front of the console.

Once a key has been depressed, the soft spring remains under the tube. It is backed by the short stiff spring to give it sufficient tension to hold the key down. When the next preset key is depressed, the cradle is forced down and outward, permitting the previously actuated key to come up, but again locking the one last depressed.

If two preset keys are depressed at once, both will lock down. The cancel key with its long stiff spring is then used and forces the cradle down, causing all preset keys depressed to return to their normal position. As there is no locking spring on the cancel key, it will immediately return to its normal position.

PRESET "CRADLE" RETURN SPRING

Earlier instruments had coil springs of various types to perform the function of returning the cradle assembly to its rest position, and replacement, when necessary, became rather involved.

A more durable spring has been devised, and is used on the later instruments. It can also be used for servicing the earlier consoles.

Replacement is made as follows: If it is determined that a new return spring is necessary, on either manual, the left hand end block of the manual needing the replacement should be removed. The upper or lower manual assembly will have to be raised to gain access to the wood screws holding this block. After removal of this block, the end of the cradle assembly will be visible. Also visible will be the stop felt and bracket assembly. This is a small angular bracket with a small piece of felt riveted to it, mounted in a vertical position. Remove and discard this part.

Install the new assembly so that the felt pad is above the preset cradle, and the flat spring is below the cradle, as shown in Figure 16. Clamp it in the center of the range of adjustment provided by the slot. Check all preset keys for operation, and adjust the position of the new assembly in case any keys do not operate correctly.

The new manual preset cradle return spring should be ordered under part number AO-21709-0.

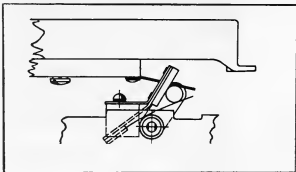

Figure 16

The tremulant sometimes called tremolo, is a periodic loudness variation, or change in intensity, which occurs at a constant frequency. It is fundamentally different from the vibrato effect, which is created by a periodic raising and lowering of pitch.

In the Hammond Organ the tremulant effect is produced and controlled principally by two components: the tremulant switch and the tremulant control.

The tremulant switch, mounted on the synchronous motor at the extreme left end of the tone generator, is in effect a variable resistor with no sliding or rubbing contacts. It consists of an eccentric, geared to the motor shaft, which advances a laminated bakelite strip so as to alternately make and break 6 contacts in order. Five resistors are connected to these contacts, ranging in value from 15,000 to 450,000 ohms, together with a length of copper wire of very little resistance. At one extreme position of the eccentric all contacts are broken and the circuit is open. At the other extreme all contacts are closed and there is practically no resistance in the circuit.

The tremulant control, a 130,000 ohm variable resistor mounted on the manual chassis assembly, is in parallel with the tremulant switch. When this control is turned to a position of no resistance, the tremulant switch is shorted out. Conversely, when the control is turned to its maximum resistance, the movement of the eccentric varies the resistance of the circuit periodically from 0 to 130,000 ohms. This parallel circuit is in series with the signal from the console, ahead of the pre-amplifier. Therefore, the signal is varied during each revolution of the eccentric by an amount depending upon the adjustment of the tremulant control.

The tremulant system is not used in console models having vibrato.

Model E

The tremulant system for Model E organ is the same as that on other models except that two switches are used. Each switch is mounted on one of the two synchronous motors that are a part of the main generator and chorus generator respectively, and each one is connected to one manual. The switch mounted on the main generator operates at 400 R.P.M. and is connected to the Great manual. The other switch operates at 348 R.P.M. and is connected to the Swell manual.

Two types of tremulant switches have been supplied, namely, the cage type and the enclosed type. These are mechanically interchangeable, but replacing the cage type with the enclosed type does require a slight change in the circuit. In the enclosed type, the condenser shown as C5 in Figure 4 is incorporated within the metal housing. Therefore, the C5 located in the rheostat box is not required and the tremulant switch red wire may be attached to terminal 6, 7, or 8.

RHEOSTAT BOX

The rheostat box contains the expression control rheostat and other components, including some terminals associated with the tremulant system. Figures 1 to 8 show various models of rheostat boxes and their circuits. The rheostat box is used only in console models with tremulant and with non-selective vibrato.

The rheostat itself is actually a variable resistor with no sliding contacts. When the expression pedal is advanced a bakelite cam moves down, opening in succession a series of 32 contacts, tipped with precious metal. The contacts are connected to fixed carbon resistors.

Resistor R2 in figures 2 and 4 forms a constant load on the matching transformer, while R4 and C4 serve to attenuate the higher frequencies. R4 and C4 were not used in Model A consoles below serial number 1231. The rheostat, in series with bass compensating condenser C2, is across the signal line, so that when its resistance is least the volume is least. Condenser C5 avoids excessive tremolo on the lower bass frequencies. It was not originally installed in Model A consoles below serial number 2311. C3 is a blocking condenser and R3 is a grid resistor for the first preamplifier tube.

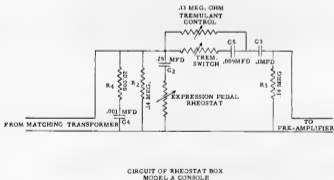
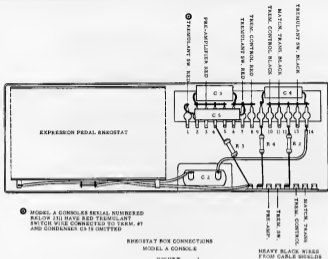
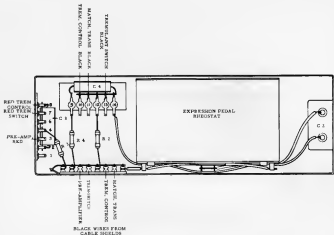
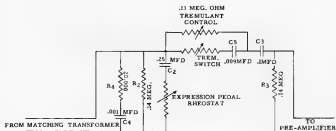

FIGURE 2



RHEOSTAT BOX CONNECTIONS
MODEL B-BA-BC-C-D-G
FIGURE 3



CIRCUIT OF RHEOSTAT BOX
MODEL B-BA-BC-C-D-G
FIGURE 4

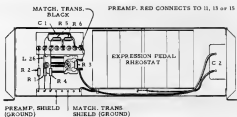

RHEOSTAT BOX CONNECTIONS
 MODELS AV-BV-BCV-CV-DV-GV-RT CONSOLES

FIGURE 5

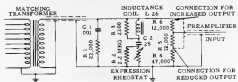

CIRCUIT OF RHEOSTAT BOX
 MODELS AV-BV-BCV-CV-DV-GV-RT CONSOLES

FIGURE 6

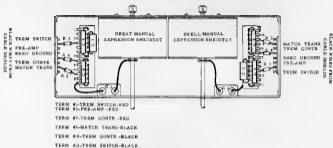

RHEOSTAT RYE CONNECTIONS
MODEL E CONSOLE

FIGURE 7

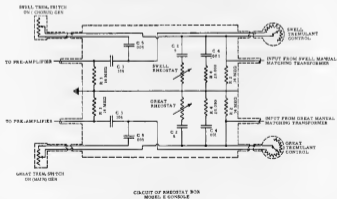

CIRCUIT OF RHEOSTAT RYE
MODEL E CONSOLE

FIGURE 8

THE HAMMOND VIBRATO

THE HAMMOND VIBRATO

Hammond Organ consoles equipped with vibrato differ from tremulant models in the omission of the tremulant switch, tremulant control, and non-vibrato preamplifier, and in the addition of the vibrato line box, scanner, vibrato switch, and vibrato preamplifier. Three degrees of vibrato are available and also a different degree of chorus or celeste effect with each of the three degrees of vibrato. Console models with the suffix "2" and "3" in their model designation have the selective vibrato feature, with tilting control tablets permitting the player to place the vibrato effect on either manual or both.

PRINCIPLE OF OPERATION

The vibrato effect is created by a periodic raising and lowering of pitch, and thus is fundamentally different from a tremolo, or loudness variation. It is comparable to the effect produced when a violinist moves his finger back and forth on a string while playing, varying the frequency while maintaining constant volume.

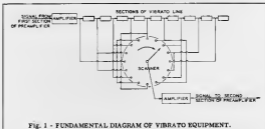

Fig. 1 - FUNDAMENTAL DIAGRAM OF VIBRATO EQUIPMENT.

The Hammond Organ vibrato equipment (see simplified block diagram, Fig. 1) varies the frequency of all tones by continuously shifting their phase. It includes a phase shift network or electrical time delay line, composed of a number of low pass filter sections, and a capacity type pickup or scanner, which is motor driven so that it scans back and forth along the line.

Electrical waves fed into the line are shifted in phase by each line section (the amount per section being proportional to frequency), so that at any tap on the line the phase is retarded relative to the previous tap.

The scanning pick-up traveling along the line will thus encounter waves increasingly retarded in phase at each successive tap, and the signal it picks up will continuously change in phase. The rate at which this phase shift occurs will depend on how many line sections are scanned each second.

Since a cycle is equivalent to 360 electrical degrees, a frequency shift of one cycle occurs for each 360 electrical degrees scanned per second. For example if the scanner passes over the line at such a rate that 3600 electrical degrees are scanned each second, there will be a frequency change of 10 cycles.

For the widest vibrato, the whole line is scanned from beginning to end in about 1/14 second, and this rate of change of phase causes about 1-1/2% decrease in frequency. Note that the frequency remains constantly 1-1/2% low as long as the moving pick-up retards the phase at a constant rate.

Since the pick-up sweeps from start to end of the line and then back, it increases the frequency by an equal percentage on its return trip, the average output frequency remaining equal to the input frequency. The exact amount of frequency shift depends not only on the amount of phase shift in the line but also on the scanning rate. This rate, however, is constant because the scanner is driven by the synchronous running motor of the organ.

The degree of vibrato (or amount of frequency shift) may be varied by a switch (not shown in Fig. 1) which causes the whole line to be scanned for #3 (wide) vibrato, about half of it for #2, and about one third for #1.

A vibrato chorus effect, similar to the effect of two or three slightly out-of-tune frequencies mixed together, is obtained when the vibrato output signal is mixed with a portion of signal without vibrato. For vibrato chorus, part of the incoming signal appears across the vibrato line and the rest across a resistor in series with the line. As the vibrato effect is applied to the part of the signal appearing across the line but not to the part appearing across the resistor, the combination produces a chorus effect. For normal vibrato, this resistor is short-circuited.

In "selective vibrato" consoles the vibrato effect can be applied to either manual separately or to both at once.

Figures 2 and 3 show different models of the vibrato line box. Each of the air core inductance coils is connected with one or more condensers to form one filter section.

Figure 4 shows the construction of a typical vibrato switch. Some models differ in wiring and number of contacts, but all are similar in mechanical arrangement.

The scanner (fig. 5) is mounted on the main generator synchronous motor and driven at 412 revolutions per minute. It is a multi-pole variable condenser with 16 sets of stationary plates and a rotor whose plates mesh with the stationary ones. In figure 5B two sets of plates have been removed to show the rotor.

Signals coming from the line through the vibrato switch appear on the stationary plates and are picked up, one at a time, by the rotor. Connection to the rotor is made by carbon brushes as shown in figure 5A. Two brushes touch the sides of the contact pin and a third presses on the end, in order to eliminate the possibility of contact failure.

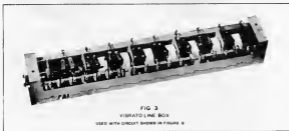

SCHEMATIC DIAGRAMS

Figures 6, 7, 8 and 9 show four different vibrato circuits which have been used in various models. As the components of different types are generally not interchangeable, it is important that model and serial number be furnished when ordering replacement parts.

Non-Selective Vibrato

Figure 6, used in all consoles with "V" in the model designation, has a 25 section vibrato line. It is wired (to minimize the number of compensated take-off points) so that the last part of the line is used for #1 vibrato. The vibrato switch has positions for three degrees of vibrato (V1, V2 and V3) with three "off" positions between them, and there is a separate vibrato chorus switch. A resistor connected to the "off" side of the chorus switch serves to maintain constant volume for the two switch positions. The switch is not intended to be left in its middle position.

The preamplifier used with this circuit is actually two separate cascaded amplifiers on one chassis, with the vibrato system connected between them. The first section drives the vibrato line, and the second section amplifies the signal picked up by the scanner. The "vibrato off" contact in the vibrato switch carries non-vibrato signal directly to the second section of the preamplifier. The complete schematic circuit of a console of this type is shown in Figure 7 of section 2, and preamplifier in Figure 8 of section 11.

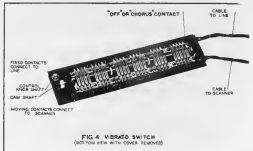

FIG 4 VIBRATO SWITCH
(BOTTOM VIEW WITH COVER REMOVED)

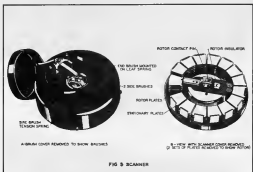

FIG 5 SCANNER

Selective Vibrato

Figure 7, used in early selective vibrato consoles, also has a 25 section line. To obtain correct phasing of the "vibrato" and "no vibrato" channels, the first part of the line is used for #1 vibrato. The vibrato switch has no "off" position, and three vibrato chorus positions (C1, C2 and C3) are included in it as well as the three vibrato positions (V1, V2 and V3). The vibrato effect is turned on and off for each manual separately by means of "vibrato swell" and "vibrato great" tablets on the manual assembly.

The preamplifier used with this circuit, as indicated in Figure 9 of section 2, has two separate channels into which signals from the "vibrato great" and "vibrato swell" tablets are fed. The "vibrato" signal goes through a preliminary amplifier, through the vibrato system, and then into additional stages of amplification. The "no vibrato" signal also has a preliminary amplifier, but by-passes the vibrato system and goes directly into the following amplifier stages. The preamplifier alone is shown in Figures 20 and 20A of section 11.

Line with Resistor Dividers

The vibrato line box of Figure 8 employs resistors for voltage dividers at the compensated pick-off points instead of condensers. Otherwise this circuit is identical with that of Figure 7. The line boxes of these two types are interchangeable, and the scanners and switches are identical.

Coupled Line

Figure 9 shows the coupled-coil type of vibrato line box. It is smaller in size and requires only 18 sections to give the same amount of vibrato effect as the 25 sections previously used. The switch has one less contact in each position, and neither the vibrato line nor the vibrato switch is interchangeable with earlier types. The preamplifiers are the same as those used with the circuits of Figures 7 and 8. The scanner has somewhat different wiring harness.

MODEL "M" VIBRATO SYSTEM

The vibrato system in the Sprint Model M Series is somewhat different from those described above. The line box is slightly smaller, the scanner is slightly different mechanically, and a completely different switching mechanism is used. A full description is given in the service books for these models.

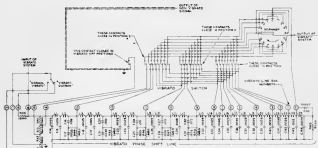

FIGURE 6 - VIBRATO SYSTEM

MODEL 100 MODEL BY BIL BULLOCK BY AIR MT CHRYSLER

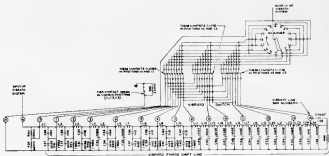

FIGURE 7 - VIBRATO SYSTEM

MODEL 100 CHRYSLER MODEL SERIAL NUMBER 1000
 MODEL 101 CHRYSLER MODEL SERIAL NUMBER 1001
 MODEL 102 CHRYSLER MODEL SERIAL NUMBER 1002

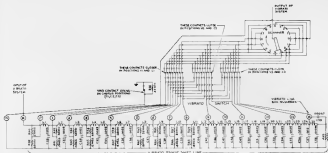

FIGURE 8 - VIBRATO SYSTEM

WHEEL 10 COMPLETES SERIAL NUMBER SEVEN TO EIGHT, AND NINE TO TEN
 WHEEL 11 COMPLETES SERIAL NUMBER SEVEN TO EIGHT
 WHEEL 12 COMPLETES SERIAL NUMBER SEVEN TO EIGHT

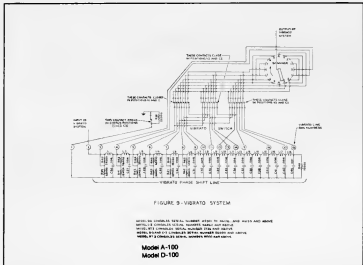

FIGURE 9 - VIBRATO SYSTEM

WHEEL 10 COMPLETES SERIAL NUMBER SEVEN TO EIGHT, AND NINE AND TEN
 WHEEL 11 COMPLETES SERIAL NUMBER SEVEN AND EIGHT
 WHEEL 12 COMPLETES SERIAL NUMBER SEVEN AND EIGHT
 WHEEL 13 COMPLETES SERIAL NUMBER SEVEN AND EIGHT
 WHEEL 14 COMPLETES SERIAL NUMBER SEVEN AND EIGHT

Model A-100
 Model D-100

Percussion tones are available only on the upper manual (with the B adjust key depressed) of all consoles with the suffix "3" in their model designation. These consoles, except for the four percussion control tablets in the upper right hand corner, look and function similar to consoles with the suffix "2" in their model designation, when the percussion effect is not in use.

1. THEORY OF OPERATION

The percussion tones are produced by borrowing the 2nd or 3rd harmonic signal from the corresponding drawbar (of the upper manual "B adjust key" drawbar group), amplifying it, returning part of it to same drawbar, and conducting the balance through push-pull control tubes, which when keyed cause the signal to fade away at a pre-determined rate.

2. GENERAL CIRCUIT OPERATION (All Reference Is To Figure 24 Section 2)

With percussion tablet "on", upper manual "B adjust key" and an upper manual playing key pressed, the 2nd or 3rd harmonic signal appearing on an upper manual busbar is conducted through "B adjust key" drawbar wire to input of percussion amplifier (terminal H) and amplified by T4 and V5. Besides providing push-pull signal for the control tube V7, the percussion input transformer T5 has a third winding which feeds the signal back to the 2nd or 3rd harmonic drawbar through equivalent key circuit resistor R50 and terminal J. Thus the signal that was borrowed from the 2nd or 3rd harmonic drawbar for the percussion amplifier is replaced.

When a key is depressed the signal first sounds loudly through the control tube, transformer T6, a high pass filter, and terminal D to the grid of V4. Immediately condenser C31 in the control tube grid circuit begins to discharge, causing the signal to fade away. Terminal K (approximately +25 volts) is connected to the 8th harmonic "B adjust key" drawbar wire which is connected to manual busbar. When an upper manual key is pressed, terminal K is grounded through the tone generator filters. This virtually grounds the plate of V6 (connected as a diode), stops conduction, and isolates cathode and control tube grid circuit. The grid then drifts from approximately +25 volts to about +15 volts, at a rate determined by the time required for C31 to discharge through R57 and R58. At the completion of this sequence the percussion signal is blocked. No further percussion effects occur until all keys of the upper manual are released and control grids can again rise to +25 volts. The rate of this rise is fixed by the time required to charge C31 to +25 volts through R55 and R56.

3. FOUR PERCUSSION CONTROL TABLETS, CUTOFF CONTROL, AND THEIR FUNCTIONS.

The Percussion On-Off Tablet when turned "on" does five things to the signals of the upper manual "B adjust key" drawbars.

- (a) It disconnects the 2nd harmonic drawbar from its signal wire.
- (b) It disconnects the 3rd harmonic drawbar from its signal wire.
- (c) It connects the 2nd or 3rd harmonic drawbar signal wire (depending on position of Harmonic Selector Tablet) to input of percussion amplifier.
- (d) It disconnects the 8th harmonic drawbar from its signal wire. This wire (connected through generator filters to ground when any key is pressed) is connected to terminal K. The 8th harmonic signal is not available on the upper

manual as long as percussion tablet is "on".

(e) It inserts resistor R1 in series with upper manual matching transformer (T2) secondary to reduce upper manual organ signal so that lower manual will musically balance with the combined upper manual organ and percussion signals.

The Preset Percussion Switch is not part of the control tablet assembly or percussion on-off tablet, but functions as an interlock with it. It is located under the upper manual "B adjust key". This switch insures that the full upper manual signal is restored by shorting out series resistor R1 introduced by the percussion "on" tablet when any other upper manual preset or adjust key is pressed.

The Volume Tablet in "soft" position shunts resistor R46 across the percussion output transformer, reducing percussion signal, and also shorts out upper manual matching transformer compensating resistor R1 thus restoring upper manual signal strength to provide proper balance between the manuals.

The Decay Tablet in "fast" position shunts resistor R57 across the slow decay resistor (R58) reducing time for decay capacitor C31 to discharge and for V7 control grids to reach cut-off. Also to preserve the same effective loudness in "fast decay" position as in "slow decay" the control tube bias is reduced by disconnecting R59 and allowing control tube grids to become more positive which increases output signal about 50%.

The Harmonic Selector Tablet does three things to the signals of the upper manual "B adjust key" drawbar group:

In "Second" Position:

- (a) It connects the 2nd harmonic signal wire to percussion amplifier input.
- (b) It connects the 3rd harmonic signal wire to the 3rd harmonic drawbar.
- (c) It connects the signal from terminal J to 2nd harmonic drawbar.

In "Third" Position:

- (a) It connects the 3rd harmonic signal wire to the percussion amplifier input.
- (b) It connects the 2nd harmonic signal to the 2nd harmonic drawbar.
- (c) It connects the signal from terminal J to 3rd harmonic drawbar.

The Percussion Cut-off Control which is located on the amplifier should be re-adjusted as follows whenever control tube V7 is replaced:

Set expression pedal wide open, both volume tablets "normal", percussion "on", percussion decay "fast", and harmonic selector in either position. Depress any key in upper half of upper manual and then adjust cut-off control exactly to the point where signal becomes inaudible.

REVERBERATION CONTROL

Reverberation control is an important feature of any Hammond Organ installation. The device is enjoying wide acceptance because it produces reverberation in variable degrees so the Hammond Organ, when installed in an acoustically "dead" enclosure, sounds very much like an organ played in a large acoustically "live" church or auditorium where organ music, enhanced by considerable reverberation sounds at its best.

Reverberation is the prolongation of sound by repeated reflections or echoes, and is measured by the time required for a sound to become inaudible after the source of sound has been stopped. It is present in some degrees in all enclosures, and music is more pleasing to the ear when accompanied by some amount of reverberation. This is particularly true of organ music.

Reverberation results from the fact that the longer path traveled by reflected sound causes a delay in hearing the reflected sound waves. This is easily realized in the case of sharp staccato sounds and a fairly distant reflecting surface, as the delayed sound is then heard separately from the direct sound and is recognized as an echo. When music is played in a large room, however, the sound echoes and re-echoes repeatedly until absorbed by the surroundings.

The Hammond reverberation control is an electro-mechanical device which introduces multiple echoes by means of reflections within a network of coil springs and thereby provides adequate reverberation in locations where the natural reverberation is not sufficient.

OPERATION OF FLUID TYPE

The fluid type reverberation unit (see figure 1), about 4 x 5 inches in cross section and about 4 feet high, is connected to a reverberation preamplifier built into the power amplifier. (In some models of tone cabinets the reverberation preamplifier is a separate unit connected to the power amplifier by cables.) The entire equipment is attached to the organ tone cabinet.

Reverberation is applied to the organ music after it leaves the console. Part of the console signal goes directly to the power amplifier and part goes into the reverberation channel, after suitable amplification.

The electrical signal fed into the reverberation unit is converted into mechanical energy by a moving coil driver unit, similar to a dynamic speaker without a cone. The mechanical waves are transmitted through coil springs, which have the property of conducting sound vibrations much more slowly than the speed of sound waves in air. In this way a spring of convenient length can introduce a delay equivalent to that obtained in a large hall.

The driver unit, at the top of figure 2, introduces up-and-down vibrations into the stirrup directly under it. The two enclosed springs under the stirrup hold it in position but permit it to move freely up and down, and the spring at the far left balances the pull of the others. These three springs are almost entirely immersed in damping fluid, as they act largely as dampers to stabilize the response of the driver and prevent undamped reflections.

A sound wave from the stirrup travels down the open spring at the far right to the crystal pickup, where an electrical signal is produced and conducted to the power amplifier. This is the "first reflected signal", delayed about 1/15 second from the part of the original signal which went directly to the power amplifier.

The same wave from the stirrup also travels down the second spring from the left, which enters the short damping tube. At the bottom of this spring the wave is reflected back along the spring, reduced in intensity by the damping action of the fluid. At the stirrup the horizontal lever transfers the wave to the right-hand spring, and it goes on to the crystal to produce a "second reflected signal" about 3/15 second after the direct signal.

Very little of the energy of each wave is absorbed by the crystal, and the rest is reflected back along the spring. The "first reflected signal" traverses the right spring, is transferred by the lever, and goes down the spring to the short damping tube.

Here it is reflected in reduced intensity, retraces the same path to the crystal, and produces a "third reflected signal" about 5/15 second after the direct signal. The "second reflected signal" is similarly repeated, and this process continues over and over, giving a series of signals about 2/15 second apart, until the vibration is dissipated by fluid friction in the short tube.

Just above the short damping tube a "reflecting pan" attached to the spring causes partial reflection of high frequencies and helps to make the over-all response more uniform.

The damper felt avoids undesirable transverse vibrations of the springs.

A greater amount of fluid in the short tube will cause increased energy loss at each reflection and thereby reduce the number of audible reflections. Adjusting the level of fluid in this tube, therefore, changes the reverberation time and simulates enclosures of different sizes.



FIG. 1

A "reverberation selector switch" in the amplifier circuit following the crystal can be adjusted to pass more or less of the reflected signal in proportion to the direct signal. While this does not actually change the reverberation time, it is a convenient way to change the amount of reverberation instantly. Generally, therefore, the fluid level in the short tube is left constant, at the position recommended on the tone cabinet instruction card, and the switch is used to select the best amount of reverberation for each installation.

The photograph of the reverberation unit (Figure 1) shows a reverberation pre-amplifier of the type used in kits for installation in some non-reverberation tone cabinets. In later reverberation type tone cabinets the power amplifier is wired so that this pre-amplifier is unnecessary.

Amplifier circuits associated with the reverberation unit are shown in the section containing amplifier diagrams.

INSTALLATION OF FLUID TYPE

In installations of tone cabinets using type F, type G, and type H power amplifiers, only a single reverberation unit is necessary for any installation, regardless of the number of tone cabinets used. The reverberation unit is connected to the first power amplifier (the one to which the console cable connects) and the reverberated signal is supplied from that amplifier to additional cabinets.

An exception occurs in the case of type MR-40, KR-40 and JR-20 tone cabinets, in which no reverberated signal is available for additional cabinets (because of the separate bass and treble channels). If reverberation is desired on several M, J, or K series cabinets, each must be equipped with a reverberation unit.

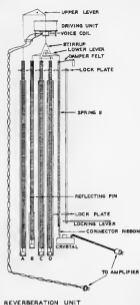

REVERBERATION UNIT

FIG. 2.

When two or more types of cabinets are used in any installation, it is preferable that any M or K series cabinets be connected to the console ahead of any cabinets having type F, type G, or type H amplifiers in order that reverberated signals may not enter the bass amplifier channel. Otherwise there may be objectionable irregularities in the response of the lower pedal notes.

Further information on the use of reverberation may be found in the section covering Acoustics.

FILLING AND ADJUSTMENT OF FLUID LEVEL

When installing a reverberation unit or tone cabinet, the damping fluid (furnished in bottles with the unit) should be added with care, following directions on the tone cabinet instruction card. The level in the three long tubes is not critical, for best damping it should be near the top, but not high enough to spill if the unit is moved. Enough fluid is furnished to fill each tube to about one inch from the top.

The short tube should be filled to exactly 3-1/4 inches from the top, using the special suction bulb supplied. This amount of fluid gives the best reverberation effect for average conditions.

If acoustic conditions are very unusual, or if an organist has a definite preference for greater or less reverberation, the level in the short tube may be set higher or lower. Lower fluid level will give longer reverberation time and higher fluid level will give shorter time. There is a temperature effect due to change in viscosity of the fluid (lower temperatures will shorten the reverberation time and higher temperatures will lengthen it) but no adjustment for this effect is necessary unless the temperature is consistently below 50° F or above 95° F.

The reverberation selector switches are set at "HI" when leaving the factory, and should be readjusted on installation to give the most desirable reverberation effect. If there is any uncertainty as to the proper adjustment, it is generally preferable to allow too much reverberation rather than too little.

OPERATIONAL ADJUSTMENTS OF FLUID TYPE

It is a well known acoustical phenomenon that audibility of some frequencies is emphasized over others in any given enclosure. Range of frequencies affected depends upon the size and type of reflecting surfaces such as walls and ceilings. Thus if a musical instrument such as an organ is played in an enclosure of almost any size, some frequencies will sound louder in one portion of the listener area than in another, and conversely some frequencies will sound weak. This can be effectively demonstrated by playing the organ in a small room with a microphone, then listening to the signal picked up by the microphone in another room. Variations in loudness will be startling especially when single frequencies are sounded.

The reverberation unit similarly produces a "response pattern" which tends to emphasize some frequencies over others to a slight degree. This is an operating phenomenon of the equipment and cannot be eliminated. This room pattern effect has not proved seriously objectionable, because as described above it stimulates an acoustical effect which is present in some degree whenever any musical instrument producing a wide range of frequencies is played in an enclosure.

If some notes on the organ sound excessively loud while others sound weak it may be traceable to the reverberation control system. In investigating this, disconnect the reverberation system by turning the switch on the reverberation preamplifier or amplifier to the "off" position. If notes then sound at equal loudness, turn reverberation system on again and make the following adjustments.

1. The two-pole plug, which is connected to wire carrying signal to the driving unit at the top of the reverberation unit, may be inserted in two positions. Reversing this plug by turning it at 90° will reverse the input signal phase, thus changing the response pattern of the reverberation system. Reversing this plug will often improve evenness of overall frequency response for a given installation.
2. Sometimes evenness of frequency response can be improved by cutting down amplitude of the reverberated signal. This is accomplished by changing the position of the reverberation switch. If switch is on "HI" move it to "Med", and if switch is on "Med" move it to "Lo."

Exact recommendation on adjustment of this switch is somewhat difficult as the purpose of the reverberation control is to compensate for lack of natural reverberation. Adjustment of it therefore should be made in cooperation with the organist, who must understand its intent. In large installations the use of two reverberation units will reduce room pattern to the point where it is negligible.

The reverberation unit appears to be a delicate device but when once set up it is very dependable and requires no further attention. When a tone cabinet is moved even a few feet, however, the reverberation unit must be locked to avoid excessive vibration of the springs. If the cabinet is to be tilted, the unit must be removed, to avoid spilling the fluid, and replaced after moving. If the unit itself cannot be kept upright while moving, the fluid must be drained and later replaced. Hammered damping fluid is a grade especially selected for this purpose, and no other kind should be used.

Failure to lock the unit when moving usually necessitates replacement of the complete driver assembly or the upper or lower lever assemblies which are a part of it. When parts are replaced, the springs must be balanced as follows:

In a complete driver assembly ordered for replacement, the wire passing through the unit from the upper lever to the stirrup is not soldered. It should be left unsoldered until this adjustment is made. Replace the driver assembly and attach all the springs, check and adjust the single damping tube, if necessary, to make the upper lever assembly level. Then solder the wire to the small tube passing through the voice coil. When only the upper or lower lever assembly is replaced, the wire need not be unsoldered, but the upper level must be made level by adjusting the single tube.



Reproduction of caution tag attached to reverberation unit

OPERATION OF DRY TYPE

A later reverberation device, Figure 3, is an improved unit which employs a dry damping means instead of the liquid previously used. It has improved driver and pickup elements and has three transmission springs instead of the one formerly used.

The device is about fourteen inches high, thirteen inches wide and two inches in depth. It is incorporated in the new PR-20, PR-40 and QR-60 tone cabinets. It is also supplied as part of a kit which is designed for installation in Spanet and Chord Organs.

In operation, an electrical signal from an amplifier is applied to the driver unit in the reverberation device which then converts the electrical signal into mechanical energy which is fed into the three springs of different lengths. The signal takes 1/22 second to traverse the shortest spring to the pickup, which reconverts part of the energy to an electrical signal and reflects most of the energy back along the spring to the driver, where again most of the signal is reflected back along the spring to the pickup. This transaction continues until the signal energy at the pickup is reduced to one millionth of its original value. This period is about two seconds in duration. The other two springs operate in a similar fashion, but their reflections occur at longer time intervals, 1/17 and 1/15 second respectively. The amount of damping for each of the three springs is so proportioned that they have a uniform decay rate.

OPERATION IN PR AND QR SERIES TONE CABINETS

The dry type reverberation device mounted in the PR and QR series tone cabinet functions as follows. Part of the console signal is applied to the reverberation driver and the resultant reverberated signal at the pickup is separated into two frequency bands, one occupying the spectrum from thirty-two to two hundred cycles, and the other from two hundred cycles to six thousand cycles. The low frequency reverberated signals are mixed with the direct console signals, amplified and fed to the low frequency speakers. The high frequency or treble reverberated signals are amplified and fed to a separate speaker system, while the treble signals from the console are also amplified and fed into another speaker system. In other words, the low frequency direct and reverberated signals are electrically mixed and the high frequency direct and reverberated signals are acoustically mixed.

Two selector switches are mounted on the side of the PR and QR series tone cabinets to provide a variation in the amount of reverberation produced. The bass reverberation switch provides increased direct output as the amount of reverberated signal is reduced. This is accomplished by introducing more or less direct signal into the bass channel as the amount of reverberation is decreased or increased. The treble reverberation switch controls the gain of the treble reverberation amplifier channel, but if the switch is turned to the "Reverberation OFF" position, the direct console treble signal is fed into this channel to provide full treble acoustic output from the cabinets.

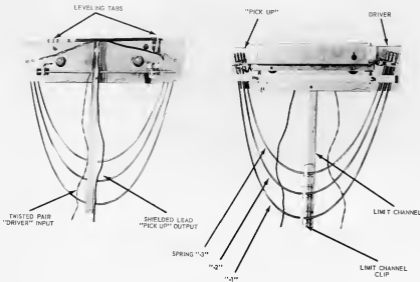

When these tone cabinets are installed the "Room Size" control on the rear of the amplifier chassis should be adjusted in accordance with the instruction card in the tone cabinet, and the reverberation device should be unlocked.

WARNING Whenever the cabinet is moved, even one or two feet, the reverberation device should be locked. Failure to do this may cause one or more springs to become unhooked from the driver or pickup assembly.

Tone cabinets embodying this reverberation unit do not provide a reverberated signal to other tone cabinets. If more than one tone cabinet of the type normally embodying this unit is used and reverberation is desired from all tone cabinets, then a reverberation unit must be included in each tone cabinet.

Kits are available which will permit turning the reverberation on and off from the console without the use of additional cables. Several different kits are available, depending upon the type of console, and the instruction sheet accompanying each kit describes the installation and operation. These kits are designed for use with PR and GR series cabinets only.

SERVICE SUGGESTIONS

Should no reverberation be evident in playing a tone cabinet equipped with this device, but a loud noise results from touching the springs, it is quite likely that the locking device has not been completely opened. Make sure that the springs of the unit are free of the clamps, which are located near the driver and pickup.

If in moving a tone cabinet a spring is disengaged from the driver or pickup, the ends can again be reinserted in the loops. For proper operation it is suggested that the reverberation unit be removed for this operation and the loose springs be allowed to hang quietly, then the end should be picked up and inserted in the loop from which it became disengaged. The purpose of this procedure is to eliminate any twist within the spring which could cause erratic noises in operation because of torque which would be transferred to the pickup portion.

REVERBERATION IN EARLIER TONE CABINETS

On previous models of tone cabinets which are installed without reverberation units and there is now a desire to add such a refinement, it is necessary that the fixed type kits be purchased. For the applicable kit, consult our D-2 Price List showing these kits. Because of mechanical and electrical considerations the later dry type can not easily be included in earlier model tone cabinets.

REVERBERATION IN SELF CONTAINED UNITS

Self contained models of the Hammond Organ (A-100, M-100, L-100) contain a somewhat similar reverberation unit, except the reverberation springs are taut and self contained. The size of this unit is approximately 17" long 4-1/2" high and 1-1/2" wide.

Reproduction is quite similar to the necklace unit. This unit does not require any locking or unlocking in movement.

All repairs and adjustments on this item must be made at the factory and no repair parts are available.

ECHO ORGAN EQUIPMENT FOR THE HAMMOND ORGAN

An echo tone cabinet (or group of cabinets) may be used with any type of Hammond Organ console. The echo cabinet is usually placed at some distance from the console and from the main cabinet; for instance, at the opposite end of a church. An echo switch mounted on the console enables the organist to play through the main cabinet alone, the echo cabinet alone, or both together. Any standard Hammond tone cabinet may be used.

The echo switch has three positions. When it is set to the left the main tone cabinet (or cabinets) will sound, and when set to the right the echo cabinet will sound. With the switch in the center both main and echo will sound simultaneously. The switch controls only the signal circuits, and all cabinets remain energized as long as the console is turned on.

Figures 1 and 3 show how the main and echo tone cabinets are connected to the console, and figure 3 is a schematic circuit of the echo system.

ECHO ORGAN KIT

The Echo kit includes all necessary parts for installation in consoles Models B, BC, BCV, BV, C, CV, D, DV, G, RT, B-3, B-3, C-3, C-3, RT-3 and RT-3, with the exception of some early B and BC consoles having no outlet box. For installing kit in a console without an outlet box, or in Model A or Model E console, see special instructions at the end of this section.

A 3-conductor cable must be ordered separately, of suitable length to reach from the console to the echo cabinet, in addition to the desired echo cabinet (or cabinets).

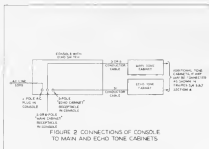
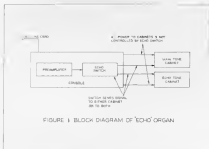

INSTRUCTIONS FOR INSTALLING KIT

1. Disconnect chorus drawbar (if console has chorus generator) from lever inside console by removing coupling pin. Detach vibrato chorus switch (if any) by removing knurled nut from front. Remove four screws in music rack end blocks and remove entire music rack assembly from console.

2. Drill holes for echo switch in music rack base as shown in figure 4. Replace music rack and other parts. Mount echo switch.

Note: Steps 3 and 4 apply only to console models having "B" in the type designation.

3. Disconnect and remove swell pedal connecting rod. If console has chorus generator, it will be necessary to unfasten preamplifier and rheostat box (leaving wires connected) and remove mounting channel.

4. Remove 4 screws from pedal switch cover panel, remove key at top of wiring tube nearest to swell pedal, raise tube a few inches, and lift pedal switch cover panel.

Note: Step 5 applies only to console models having C, D, G, or R in the type designation.

5. Remove key at top of wiring tube and raise tube a few inches to permit detaching the outlet box.

6. Unfasten outlet box from base of console, open it, knock out proper receptacle hole blank (see figure 5) and mount echo receptacle. Solder connections as indicated in figure 5. Pull twisted pair of wires up through wiring tube. Reassemble outlet box and attach it to console. Replace pedal switch cover if it was raised in step 4.

Note: For consoles not equipped with outlet box, see special instructions at end of this section.

7. Replace any other parts previously removed. Fasten echo wiring panel on top of line panel cover and connect all wires as shown in figure 5.

8. Check for proper operation. If it should happen that the echo cabinet sounds with the switch in "main" position and the main cabinet sounds with the switch in "echo" position, interchange the main and echo cable wires at the echo wiring panel.

INSTALLING KIT IN MODEL E CONSOLES

In this model the preamplifier is located so far from the line panel that the blue, green, and black wires from the echo panel must be extended to reach the preamplifier. In addition, the black and red cable wires must be extended to reach the echo panel. Otherwise the installation may be made as described above.

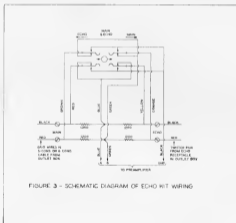

FIGURE 3 - SCHEMATIC DIAGRAM OF ECHO KIT WIRING

*Note: On consoles with start and run switches in wood end block (B-3, C-3 and RT-3) increase this dimension to 3 17/32"

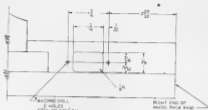

FIGURE 4-HOLES TO BE PROVIDED FOR MOUNTING ECHO SWITCH

INSTALLING KIT IN EARLY MODEL B AND BC CONSOLES WITH NO OUTLET BOX

When installing an echo kit in one of these consoles, it is preferable that an outlet box be installed at the same time.

- (a) Order from the service department of Hammond Organ Co. "one outlet box with 6-conductor receptacle, 2 conductor plug and mounting screws; one 6-conductor plug, and one plug cap," stating the model and serial number of the console.
- (b) Follow steps 1, 2, 3 and 4 above.
- (c) Mount echo receptacle in outlet box (see figure 5). Cut off 6-conductor cable to proper length to connect it to outlet box, and mount 6-conductor plug and plug cap on remaining piece of cable. Figure 6 shows connections to plug and receptacle.
- (d) Follow remaining part of step 6 and follow steps 7 and 8. Figure 7 shows position in which outlet box should be mounted on console.

INSTALLING KIT IN MODEL A CONSOLES

In this model the installation of the echo switch is complicated by the fact that the right hand wooden end block is very thick and has no flat front surface to accommodate the switch plate. Contact the service department of Hammond Organ Co. for further information. Electrically the installation is the same as for the other models.

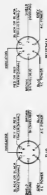

FIGURE 6 - CONNECTIONS OF CABLE TO 6-POLE PLUG AND RECEPTACLE

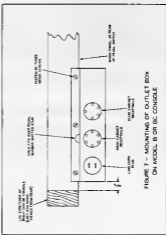

FIGURE 7 - MOUNTING OF OUTLET BOX ON MODEL B OR B.C. CONSOLE

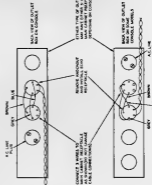
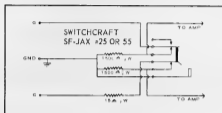

FIGURE 5 - WIRING OF ECHO KIT

MONAURAL EARPHONE CONNECTIONS

Earphones can be added to the console for practice purposes so as not to disturb others. Earphones at best cannot replace the tonal quality achieved from the instruments' own speakers but do make the organ "more available".

One method of attaching earphones is shown in the sketch below, using a reluctance type headset of good quality. Inserting the phone plugs silences the speakers in the console. Wiring is between the preamplifier terminals marked "G" and the main amplifier input.



STEREO EARPHONE CONNECTIONS

A second method of attaching earphones is given below. This will provide a stereo effect that is well worth the cost and effort expended. Koss or Jensen 4 ohm stereo phones are recommended.

1. Turn over AO-39 chassis and disconnect two black wires from the BN-BK speaker terminal inside of the amplifier. Leave output transformer lead connected. Connect the two wires removed, to the center lug of the three lug terminal strip nearest the front of the chassis and solder connections.

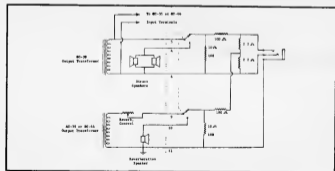

2. Replace amplifier and place a solder lug under the mounting screw nearest the output transformer.
3. Remove the brown wire from the BN-BK speaker terminal on the AO-39 and solder it to the lug just installed.
4. Remove the green wire from the GN speaker terminal on the AO-39 amplifier and splice on an additional length of wire long enough to reach the earphone jack and switch which will be mounted on the front of the console.
5. Solder a wire to the GN speaker terminal on the AO-39 long enough to reach the earphone jack.
6. Solder a wire to the BN-BK speaker terminal on the AO-39 long enough to reach the earphone jack.
7. Identify the green and black wires on the center speaker that connect to the AO-35 or AO-44 amplifier. Remove these wires and connect the green wire to the GN speaker terminal and the black wire to the BN-BK speaker terminal on the AO-39 amplifier.
8. Identify the speaker terminals on the reverberation amplifier AO-35 or AO-44. If a black wire is soldered to the left speaker terminal on the amplifier, reverse the speaker leads at the amplifier so that the gray wire is on the left lug and the black wire is on the right lug of the amplifier speaker terminals.
9. Remove the blue wire that is connected to the speaker directly above the reverberation amplifier. Splice on an additional length of wire long enough to reach the earphone jack.
10. Solder a wire to the empty lug on the speaker long enough to reach the earphone jack.
11. Solder a wire to the right speaker terminal long enough to reach the earphone jack. (This terminal is grounded inside the AO-35 or AO-44 chassis.)
12. Mount all components to the right of the dotted line shown on the diagram in a suitable box and connect as shown. Numbers shown under wires identify these leads based on the preceding steps.
13. Mount box containing switch and earphone jack at a convenient point at the front of the console.

PHONO INPUT

A microphone or record player pickup may be used through the organ if desired. The preamplifier is equipped with a standard phonograph input jack. The input impedance is approximately 1 megohm and the circuit requires a maximum input signal of about 1/2 volt. A volume control will have to be installed between the microphone or record player input and the organ inasmuch as the swell control of the organ does not affect this input.

SECTION III

LIST OF ILLUSTRATIONS AND INDEX

	PAGE		PAGE
LIST OF ILLUSTRATION AND INDEX	3-1	POWER AMPLIFIER SCHEMATICS	
Models A, B, BC, D, & E	3-2	(USED IN TONE CABINETS)	
Wiring Diagram (Figure 15)	3-2	Models A-20, A-40, B-40, C-40 (Figure 10)	3-40
Schematic (Figure 18)	3-3	Models A-20, A-40, B-40, C-40, D-20, D-20, E, EX-20 (Figure 11)	3-40
Model A-100	3-53	Models D-20, DR-20, E-40, ER-20, FR-20, F-40 (Figure 12)	3-41
Schematic (Figure 20)	3-53	Models G-20, F-40, FR-40 (Figure 13)	3-41
Wiring Diagram (Figure 21)	3-60	Models DR-20, ER-20, FR-40 (Figure 14)	3-42
Model BV, CV	3-4	Models H-40, HR-40 (Figure 15)	3-42
Wiring Diagram (Figure 17)	3-4	Models H-40, HR-40 (Figure 16)	3-43
Schematic (Figure 18)	3-6	REVERB PRE-AMPLIFIERS SCHEMATICS	
Model C-20	3-6	Models DR-20, ER-20 (Figure 17)	3-44
Wiring Diagram	3-8	Models DR-20, ER-20, FR-40 (Figure 18)	3-45
Schematic	3-7	POWER AMPLIFIER SCHEMATIC	
Models B2 & C2	3-8	(USED IN TONE CABINETS)	
Wiring Diagram (Figure 20)	3-8	MODELS H-40, HR-40 (Figure 19)	3-46
Wiring Diagram (Figure 20A)	3-8	Models X-40, HR-40 (Figure 19B)	3-47
Schematic (Figure 21)	3-10	PRE-AMPLIFIER SCHEMATICS	
Models B-3 & C-3	3-11	Models B-2, C-2, RT-2 (Figure 20)	3-47
Wiring Diagram (Figure 22)	3-11	Models B-2, D-2, RT-2 (Figure 20A)	3-47
Schematic (Figure 24)	3-12	POWER AMPLIFIERS SCHEMATICS	
Model D-100	3-69	(USED IN TONE CABINETS)	
Schematic (Figure 33)	3-69	Model JR-20 (Figure 22)	3-48
Wiring Diagram (Figure 35)	3-67	Model JR-20 (Figure 22A)	3-48
Model E	3-18	Model JR-20 (Figure 22B)	3-48
Wiring Diagram (Sheet 1)	3-18	PRE-AMPLIFIERS SCHEMATICS	
Wiring Diagram (Sheet 2)	3-19	Models B-3, C-3, RT-3 (Figure 24)	3-50
Model RT	3-13	POWER AMPLIFIERS SCHEMATICS	
Wiring Diagram (Figure 19)	3-13	(USED IN TONE CABINETS)	
Schematic (BV, BC, & RT) (Figure 18)	3-5	Models PR-40, QR-40 (Figure 26)	3-50
SEE PAGE	3-5	Models PR-20 (Figure 26)	3-51
Model RT-2	3-14	TONE CABINETS	
Wiring Diagram (Figure 22)	3-14	Models PR-40, QR-40	3-52
Wiring Diagram (Figure 22A)	3-14	Models PR-40, QR-40 (Figure 26A) Schematic	3-53
Schematic (B-3, C-2, & RT-2)	3-10	Models PR-40, QR-40 (Figure 27A) Schematic later units	3-54
SEE PAGE (Figure 21)	3-10	Models P-40, Q-40	3-55
Model RT-3	3-18	Models P-40, Q-40 (Figure 28) Schematic	3-56
Wiring Diagram (Figure 26A)	3-16	Model PR-20	3-57
Schematic (B-3, C-3, & RT-3)	3-12	Model PR-20 Schematic	3-58
SEE PAGE (Figure 24)	3-12	POWER AMPLIFIERS	
PEDAL HOLD UNIT		(USED IN CONSOLES)	
General	3-21	MODEL A-100	3-61
Wiring Diagrams	3-22	Schematic (Figure 32)	3-61
Tuning	3-23	Wiring Diagram (Figure 32)	3-62
Block Diagrams (Figure 1 & 1B)	3-24	Model D-100 (Figure 26)	3-63
Model RT Schematic	3-25	REVERBERATION AMPLIFIERS	
Model RT-2 Schematic	3-26	(USED IN CONSOLES)	
Tube Voltages	3-29	Model A-100 (Figure 24)	3-63
Service Suggestions	3-29	(Figure 25)	3-64
Removing Parts	3-30	(Figure 26A)	3-65
Parts List	3-31	TROUBLE LOCATION	3-69
Wiring Diagrams Pedal Solo Selector	3-31	Trouble Shooting	3-69
(Figure 4, 4B, & 4C)	3-32	Sectionalizing Trouble	3-75
AMPLIFICATION SYSTEM		Trouble Shooting Chart	3-80
Pre-Amplifier Schematics		Paper & Disassembly of Vibrato Scanner	3-82
Model A (Figure 1)	3-35		
Models A & B (Figure 2 & 3)	3-35		
Models A, B, C, D, Player & G (Figure 4 & 5)	3-37		
Models AV, BV, BCV, CV, DV & RT (Figure 6)	3-38		
Model E (Figure 7)	3-38		
Model E (Figure 8 & 9)	3-38		

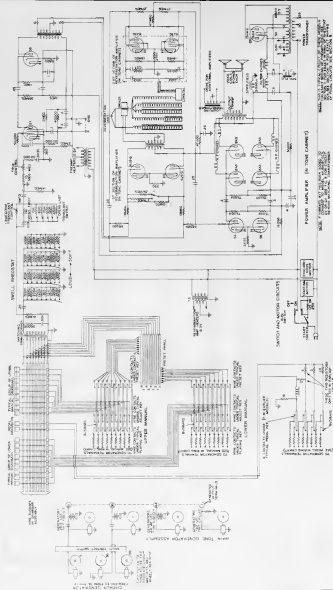
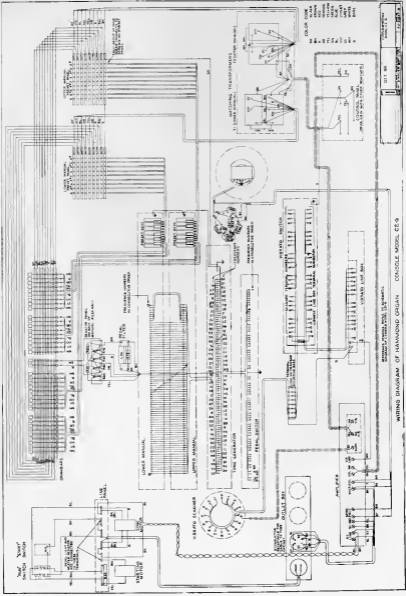
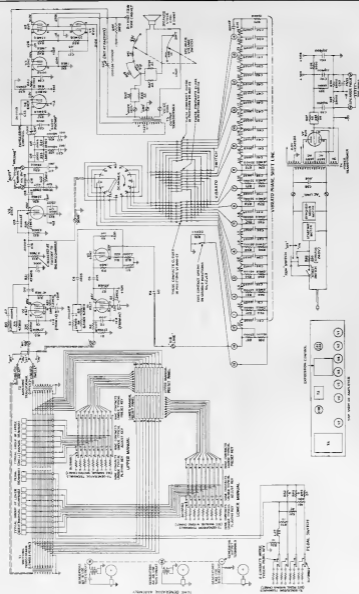

FIG 16—SCHEMATIC DIAGRAM OF VERTICAL HAMMOND ORGAN MODEL A, B, C, C D AND G WITH DR-2D OR ER-2D TONE CABINET



WIRING DIAGRAM OF HAMMOND ORGAN CONSOLE MODEL CE-9

Console Wiring Diagram



Schematic Diagram of Model C-35 Harmonic Organ

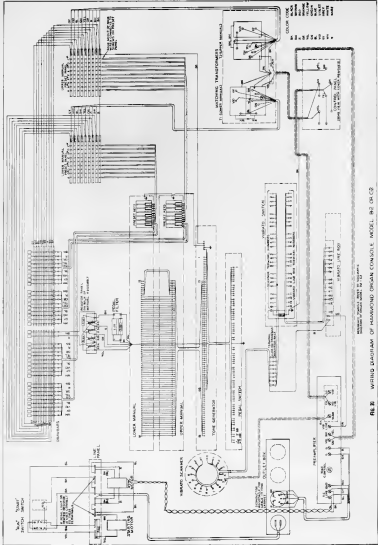

FIG. 3. WIRING DIAGRAM OF MARKOVIAN ORGAN CONSOLE, MODEL R2 CR-CB

MARKOVIAN ORGAN CONSOLE, MODEL R2 CR-CB

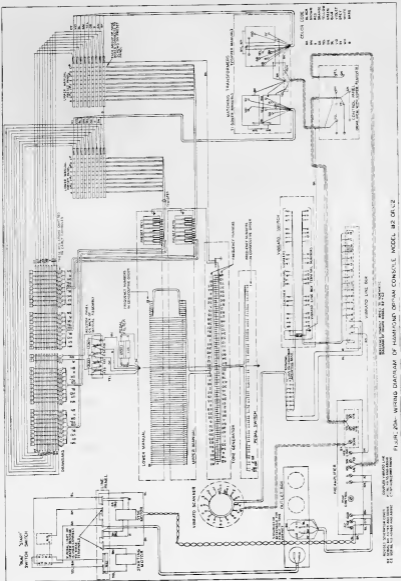

FIG. 204—WIRING DIAGRAM OF HAM-POND ORGAN CONSOLE MODEL B2 DC-2

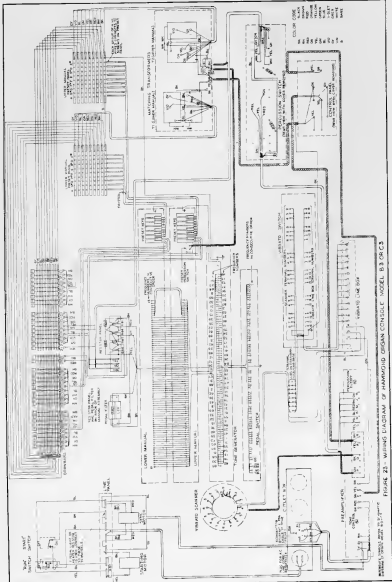

FIGURE 23 - WIRING DIAGRAM OF HAMMING ORGAN CONSOLE MODEL B-3 OR C-3

800001/800022 02-57

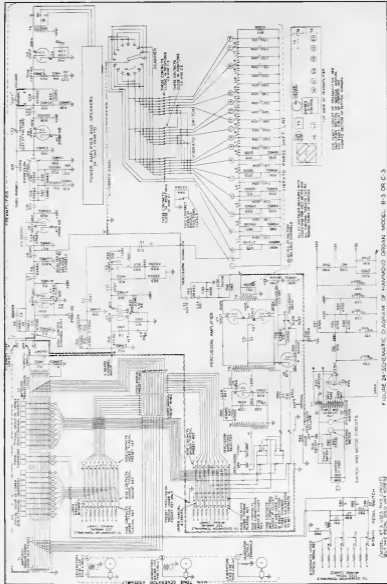

FIGURE 24—SCHEMATIC DIAGRAM OF NAVY-MD ORGAN MODEL B-3 OR C-3

(NOTES: 1. ALL COMPONENTS ARE TO BE INSTALLED IN THE ORDER SHOWN IN THIS SCHEMATIC.)

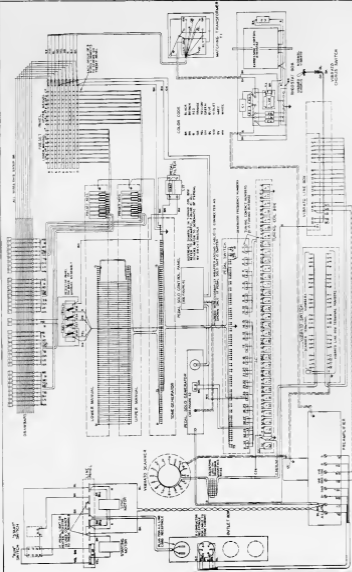

FIG. 13 WIRING DIAGRAM OF HAMMOND ORGAN CONSOLE MODEL RT

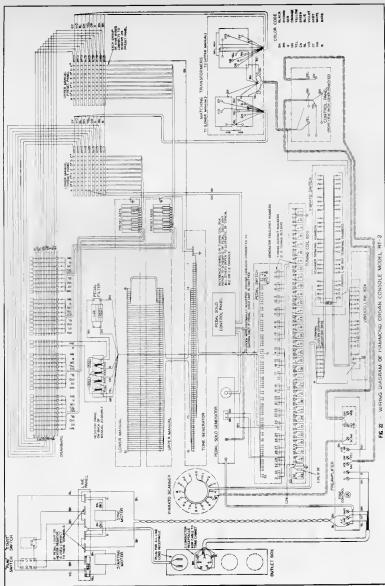

FIG. 2 - WIRING DIAGRAM OF HARBACH ORGAN CONSOLE MODEL HT-2

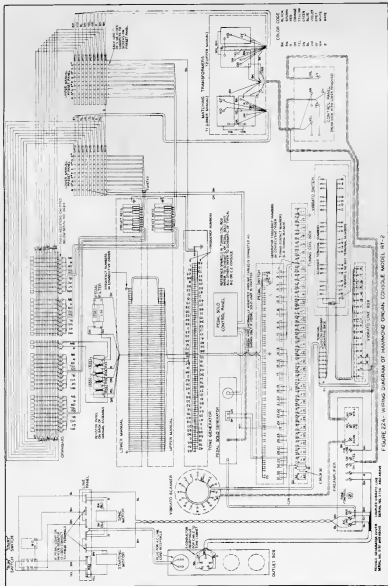
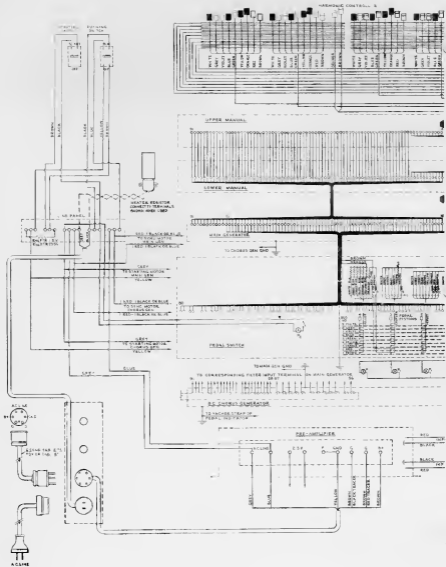
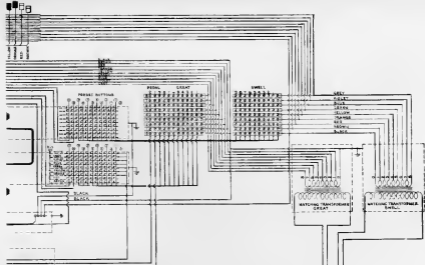

FIGURE 224—WIRING DIAGRAM OF HAMMOND ORGAN CONSOLE MODEL RT-2

31

17





WOLVES INDICATE POSITIONS OF PULSES
 FROM 12-120V 60-10W 2500V 50/60

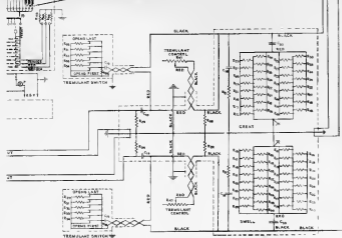

P, PILOT LAMP MANIFOLD SOCKET
 BASE: 2.5 V 40/20 W
 P, PEDAL LAMP MANIFOLD SOCKET
 12 W 150V 60-10W 2500V

C₁ CUMMERBUSS 10W/20V 100 OHMS
 C₂ CUMMERBUSS 20W/20V 100 OHMS
 C₃ CUMMERBUSS 30W/20V 100 OHMS
 C₄ CUMMERBUSS 15 W/20V 100 OHMS

R ₁	250 OHMS	1.500 OHMS
R ₂	500 OHMS	2.000 OHMS
R ₃	1000 OHMS	3.000 OHMS
R ₄	2000 OHMS	5.000 OHMS
R ₅	3000 OHMS	7.500 OHMS
R ₆	4000 OHMS	10.000 OHMS
R ₇	5000 OHMS	12.500 OHMS
R ₈	6000 OHMS	15.000 OHMS
R ₉	7000 OHMS	17.500 OHMS
R ₁₀	8000 OHMS	20.000 OHMS
R ₁₁	9000 OHMS	22.500 OHMS
R ₁₂	10000 OHMS	25.000 OHMS
R ₁₃	11000 OHMS	27.500 OHMS
R ₁₄	12000 OHMS	30.000 OHMS
R ₁₅	13000 OHMS	32.500 OHMS
R ₁₆	14000 OHMS	35.000 OHMS
R ₁₇	15000 OHMS	37.500 OHMS
R ₁₈	16000 OHMS	40.000 OHMS
R ₁₉	17000 OHMS	42.500 OHMS
R ₂₀	18000 OHMS	45.000 OHMS
R ₂₁	19000 OHMS	47.500 OHMS
R ₂₂	20000 OHMS	50.000 OHMS
R ₂₃	21000 OHMS	52.500 OHMS
R ₂₄	22000 OHMS	55.000 OHMS
R ₂₅	23000 OHMS	57.500 OHMS
R ₂₆	24000 OHMS	60.000 OHMS
R ₂₇	25000 OHMS	62.500 OHMS
R ₂₈	26000 OHMS	65.000 OHMS
R ₂₉	27000 OHMS	67.500 OHMS
R ₃₀	28000 OHMS	70.000 OHMS
R ₃₁	29000 OHMS	72.500 OHMS
R ₃₂	30000 OHMS	75.000 OHMS
R ₃₃	31000 OHMS	77.500 OHMS
R ₃₄	32000 OHMS	80.000 OHMS
R ₃₅	33000 OHMS	82.500 OHMS
R ₃₆	34000 OHMS	85.000 OHMS
R ₃₇	35000 OHMS	87.500 OHMS
R ₃₈	36000 OHMS	90.000 OHMS
R ₃₉	37000 OHMS	92.500 OHMS
R ₄₀	38000 OHMS	95.000 OHMS
R ₄₁	39000 OHMS	97.500 OHMS
R ₄₂	40000 OHMS	100.000 OHMS
R ₄₃	41000 OHMS	102.500 OHMS
R ₄₄	42000 OHMS	105.000 OHMS
R ₄₅	43000 OHMS	107.500 OHMS
R ₄₆	44000 OHMS	110.000 OHMS
R ₄₇	45000 OHMS	112.500 OHMS
R ₄₈	46000 OHMS	115.000 OHMS
R ₄₉	47000 OHMS	117.500 OHMS
R ₅₀	48000 OHMS	120.000 OHMS
R ₅₁	49000 OHMS	122.500 OHMS
R ₅₂	50000 OHMS	125.000 OHMS
R ₅₃	51000 OHMS	127.500 OHMS
R ₅₄	52000 OHMS	130.000 OHMS
R ₅₅	53000 OHMS	132.500 OHMS
R ₅₆	54000 OHMS	135.000 OHMS
R ₅₇	55000 OHMS	137.500 OHMS
R ₅₈	56000 OHMS	140.000 OHMS
R ₅₉	57000 OHMS	142.500 OHMS
R ₆₀	58000 OHMS	145.000 OHMS
R ₆₁	59000 OHMS	147.500 OHMS
R ₆₂	60000 OHMS	150.000 OHMS
R ₆₃	61000 OHMS	152.500 OHMS
R ₆₄	62000 OHMS	155.000 OHMS
R ₆₅	63000 OHMS	157.500 OHMS
R ₆₆	64000 OHMS	160.000 OHMS
R ₆₇	65000 OHMS	162.500 OHMS
R ₆₈	66000 OHMS	165.000 OHMS
R ₆₉	67000 OHMS	167.500 OHMS
R ₇₀	68000 OHMS	170.000 OHMS
R ₇₁	69000 OHMS	172.500 OHMS
R ₇₂	70000 OHMS	175.000 OHMS
R ₇₃	71000 OHMS	177.500 OHMS
R ₇₄	72000 OHMS	180.000 OHMS
R ₇₅	73000 OHMS	182.500 OHMS
R ₇₆	74000 OHMS	185.000 OHMS
R ₇₇	75000 OHMS	187.500 OHMS
R ₇₈	76000 OHMS	190.000 OHMS
R ₇₉	77000 OHMS	192.500 OHMS
R ₈₀	78000 OHMS	195.000 OHMS
R ₈₁	79000 OHMS	197.500 OHMS
R ₈₂	80000 OHMS	200.000 OHMS
R ₈₃	81000 OHMS	202.500 OHMS
R ₈₄	82000 OHMS	205.000 OHMS
R ₈₅	83000 OHMS	207.500 OHMS
R ₈₆	84000 OHMS	210.000 OHMS
R ₈₇	85000 OHMS	212.500 OHMS
R ₈₈	86000 OHMS	215.000 OHMS
R ₈₉	87000 OHMS	217.500 OHMS
R ₉₀	88000 OHMS	220.000 OHMS
R ₉₁	89000 OHMS	222.500 OHMS
R ₉₂	90000 OHMS	225.000 OHMS
R ₉₃	91000 OHMS	227.500 OHMS
R ₉₄	92000 OHMS	230.000 OHMS
R ₉₅	93000 OHMS	232.500 OHMS
R ₉₆	94000 OHMS	235.000 OHMS
R ₉₇	95000 OHMS	237.500 OHMS
R ₉₈	96000 OHMS	240.000 OHMS
R ₉₉	97000 OHMS	242.500 OHMS
R ₁₀₀	98000 OHMS	245.000 OHMS
R ₁₀₁	99000 OHMS	247.500 OHMS
R ₁₀₂	100000 OHMS	250.000 OHMS



PEDAL SOLO UNITS

CONCERT MODEL CONSOLES

The Model RT Hammond Organ console is similar electrically to the Model CV console, but differs in the following respects:

1. The console woodwork is larger and somewhat different in design.
2. The pedal keyboard is concave, with 32 pedal keys.
3. The pedal solo unit is added to provide deep and rich pedal tones desired by the concert organist.

The Model RT-2 console includes the above features and also has the selective vibrato system as used in Model C-2.

The Model RT-3 Console is similar to Model RT-2 with the addition of the percussion feature.

The Model D-100 Console is similar to Model RT-3 with the addition of a built-in power amplifier and speakers.

PEDAL SOLO UNIT

The pedal solo unit incorporated in these consoles provides a series of bright pedal solo tones in addition to the usual pedal accompaniment tones available on other models. The pedal solo tones, generated by a vacuum tube oscillator circuit, are controlled by a volume control knob and eight tilting stop tablets, of which one turns all the pedal solo tones on or off and the others provide various pitch registers and tone colors. The pedal solo unit is independent of the electromagnetic tone wheel generator and can be turned off without affecting the remainder of the organ.

Only one pedal solo note will play at a time (if two pedals are depressed at a time, only the higher one plays) but this does not affect the foundation or accompaniment tones controlled by the two pedal drawbars. It is possible, therefore, for the left foot to play a bass accompaniment note set up on the pedal drawbars, while at the same time the right foot plays a pedal solo note (the accompaniment tone on this higher note being masked by the high solo quality).

The pedal solo unit is designed as a part of these consoles, and because of mechanical limitations it is not adaptable to any other model.

NOTE: Pedal solo generators of all types have slightly different electrical circuits but are interchangeable in all RT series consoles. Type RTA was used in all Model RT and some Model RT-2 consoles. Types RTB and RTC were originally used only in Model RT-2. Types RTD and RTE have improved components - but no change in circuits.

HOW THE PEDAL SOLO UNIT WORKS

All notes of the pedal solo unit are controlled by a two-triode vacuum tube master oscillator circuit operating at audio frequencies from 525 to 3126 cycles per second, corresponding to 1 foot pitch. Thus the master oscillator operates over the full pedal keyboard range of 32 notes. Each time a pedal is depressed, its tuning contact tunes the oscillator to the pitch associated with the corresponding key in this 32 note range.

The output of the oscillator is fed into a series of five cascaded frequency dividers, each of which divides its input frequency by two and thus produces a note an octave lower than its input frequency. The five dividers thereby provide pitches of one, two, three, four, and five octaves below the pitch of the oscillator. In this way, when the oscillator is tuned to some given note, each divider produces a note in exact octave relation to the oscillator, thus forming a series of six notes having exact octave relationships. The particular frequency divider or dividers selected for sounding through the amplifier and speaker system of the organ will depend upon which of the stop tablets are used.

A control contact under each pedal causes the control tube to transmit the signal to the amplification system with a controlled rate of attack.

COMPONENTS OF THE PEDAL SOLO UNIT

Electrically the pedal solo unit is very similar in principle to the Hammond Solovox, Model L, although there are, of course, many differences. It employs tuning coils, tuning adjustment knobs, a master oscillator, and frequency dividers similar to those in the Solovox, and the stop tablets are similar in function to the register controls of the Solovox.

The pedal solo generator is a chassis which looks like an amplifier and contains the master oscillator, five frequency dividers, an amplifier, a control tube, and a power supply. It is located directly above the pedal switch assembly, near the left side of the console as viewed at the rear.

The tuning coil assembly contains 32 adjustable inductance coils, which tune the master oscillator to the frequencies of the 32 pedal notes. It is mounted above the pedal switch assembly, near the right side of the console as viewed at the rear.

The control panel, with eight stop tablets and a volume control knob, is mounted at the right end of the lower manual.

The pedal switch has nine contacts under each pedal key. One is used for tuning the pedal solo unit, the second serves to key the amplifier and make the pedal solo note sound, and the other seven carry harmonics from the main (tone wheel) generator to the pedal drawbars as in the B and C series consoles.

In studying the operation of the pedal solo unit, refer first to the block diagram (figure 1) and second to the more detailed schematic circuit (figure 2, 2B or 2C). The schematic diagram of the console, apart from the pedal solo unit, is the same as for the Model CV, C-2, or C-3 console, shown in section 2. Actual connections between the pedal solo unit and other parts of the console are shown in the wiring diagram in section 2.

The Oscillator

The 32 coils which tune the audio frequency oscillator are shown in figure 2. When the lowest "C" note is played (this pedal has no tuning contact), all 32 coils are connected in series to form the tuning inductance of the oscillator. When any other pedal is depressed, its tuning contact shorts out some of these coils (making less total inductance) and thus tunes the oscillator to the higher pitch associated with that note. If two pedals are depressed at the same time only the higher pitched of the two will sound.

Frequency Dividers

Each divider includes three triodes. One acts as a driver and pulse rectifier, supplying sharp and narrow negative pulses to actuate a symmetrical feed-back tripping circuit comprising two triodes. Either one (but only one) of these two triodes can be conducting at a time, for by drawing plate current it holds the other in a cut-off condition.

Suppose, for example, that the first triode is conducting and the second is cut off. Now a negative input pulse impressed on the grids of both triodes will not affect the second one, which is already cut off, but will cut off the first. This produces a positive pulse at the plate of the first triode, which is applied to the grid of the second

triode through its feedback connection. The second triode then suddenly conducts current, producing a negative pulse at its plate. This negative pulse, applied to the first triode grid through its feed-back connection, insures that the first triode remains cut off. The situation is now exactly reversed, with the first triode cut off and the second conducting.

The next input pulse will act on the second triode, cutting it off again and making the first conductive; and thus two input cycles are required to produce one out-pulse cycle. Each frequency divider circuit therefore divides its input frequency in half, producing an output signal one octave lower than the preceding divider. One triode plate of each divider stage furnishes a signal of rectangular wave shape to the following driver tube, and output signals are taken from the driver and divider plates as indicated in figures 2, 2-B and 2C.

This divider circuit is capable of operating satisfactorily with wide variations in voltage, input frequency, and values of components, and therefore is remarkably stable and requires no adjustments.

Stop Tablets

From the preceding, we see that whenever any one of the three G pedals, for instance, is depressed, the frequency dividers, together with the oscillator, provide a series of six G notes in exact octave relations. The particular divider whose output is to sound is selected by the stop tablets: 2' & 1', 4', 8', 16', 32' BOMBARDE and 32' BOURDON. Thus the stop tablets act as register controls to shift the pitch range of the pedal solo unit to five different positions. If two or more of these controls are turned on simultaneously, a composite tone will be heard, consisting of the output of several dividers simultaneously sounding in their octave relations. (A tablet is "on" when the white dot is visible.)

Note With Regard To The 32-foot Stops

In playing, care must be exercised by the organist in using the 32' BOURDON and 32' BOMBARDE pedal stops. They are useful in permitting the player to obtain deep bass notes in the second octave of pedals. As the player descends into the first octave of pedals, he will find that the B, A#, A, and G# pedals have a definite pitch like the higher pedals. However, below the G# pedal, it becomes difficult to ascribe a definite pitch to these 32-foot tones. When a 32-foot stop is registered in concert organ music, it will be found that the pedals required will rarely be lower than the G pedal in the first octave. Therefore, do not use the 32-foot pedal stops indiscriminately for ordinary bass purposes where the 16-foot tone is desired. The 32' BOURDON stop produces an effect which is mostly "felt" as a very low bass undulation when playing low in the first octave of pedals. The 32' BOMBARDE is always used in conjunction with other higher pitched stops. When played by itself in the lower half of the lowest octave of pedals, the effect is of such low pitch as to be of little use musically.

"MUTE"

Pressing the mute tablet shuts a small condenser across the signal circuit to reduce the intensity of the higher frequencies. This is effective on all the pedal solo stops to make the tones more mellow.

"PEDAL SOLO ON"

This tablet, connected in series with the keying contacts on the pedal switch, turns on and off any solo combination set up on the other tablets. It may thus be used as a preset control for the pedal solo unit.

Volume Control

The volume knob on the control panel is used to balance the pedal solo tones with the rest of the organ. The over-all volume of the entire organ, including the pedal solo unit, is controlled by the expression pedal.

Control Tube

The push-pull control tube, a double triode, is normally cut off by a large negative bias applied to its grid circuit. When any pedal is depressed its control contact grounds this bias circuit (if the "PEDAL SOLO ON" tablet is "on"), thereby removing the bias and causing the note to sound. A condenser and resistor, C81 and R112, make the tonal attack smooth. The control tube is connected to an output transformer whose secondary feeds the pedal solo signal through the volume control to the organ preset panel, where it is combined with the other tones of the organ.

Tuning

All notes of the pedal solo unit are simultaneously tuned by adjusting two tuning knobs located on the pedal solo generator. These change the frequency of the master oscillator by shunting small additional capacitors across the main tuning condenser.

To tune the pedal solo unit to the organ, proceed as follows:

- (a) Press only the "4", "MUTE", and "PEDAL SOLO ON" tablets and hold down the middle D# pedal. The pedal drawbars must be pushed in, and the vibrato should be off.
- (b) Pull out only the first white drawbar for either manual and press the corresponding preset key. Hold down the D# key above the middle C, with the drawbar and the volume control knob set to give approximately equal volume.
- (c) Set the "fine tuning" knob on the pedal solo generator to its center position and adjust the "rough tuning" knob to the point which brings the two notes most nearly in tune (slowest beat between them). Then adjust the "fine tuning" knob to make the beat as slow as possible. While it is generally not possible to tune exactly to zero beat, the accuracy of tuning provided will be found to be sufficient.
- (d) The organist may prefer to have the pedal solo generator tuned slightly sharp to increase the "chorus effect" between it and the main tone generator. To tune it sharp, turn the "fine tuning" switch counterclockwise one step.

Note: Never tune on the lower pitch registers (especially the 32-foot range) where the pitch acuity of the ear is insufficient for accurate tuning. If the 4-foot stop is tuned as directed above, all other registers will be in tune because they are locked by the frequency dividers to exact octave intervals.

Wiring of Pedal Switch

The nine contacts of each pedal key make contact with nine busbars extending the length of the pedal switch assembly. One set of contacts and the corresponding busbar, used for tuning the pedal solo unit, are wired to a terminal panel on top of the pedal switch, where the tuning coil cable connects. The other eight sets of contacts are wired to the main tone generator as indicated in the pedal wiring chart in the section on manuals and pedals, although only seven sets are actually used to carry tones from the main generator to the pedal drawbars.

The contacts of one set (the one marked "12th harmonic" in the wiring chart) are used as control contacts for keying the pedal solo unit. The fact that they are connected to ground through the pedal switch wiring and the tone generator wiring does not

affect their use for this purpose, since the keying circuit impedance is high by comparison. The busbar for these contacts is wired to a terminal on top of the pedal switch to which the white keying wire from the pedal solo control panel connects. These contacts are wired to the main tone generator in the usual way in order that they may supply the 12th harmonic in case special circumstances make it desirable to omit the pedal solo unit. In this case a green wire from the pedal resistor panel on the manual assembly (it will be found wrapped around the pedal switch cable) is connected to the busbar terminal on top of the pedal switch (see wiring diagram in section 2). The pedal tones will then be identical to those on the B and C series organs.

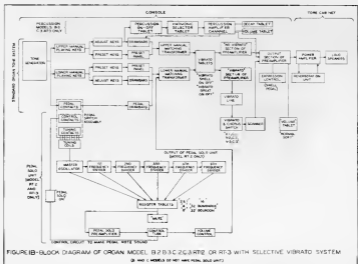
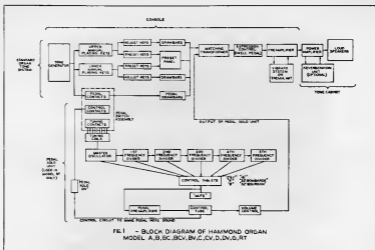

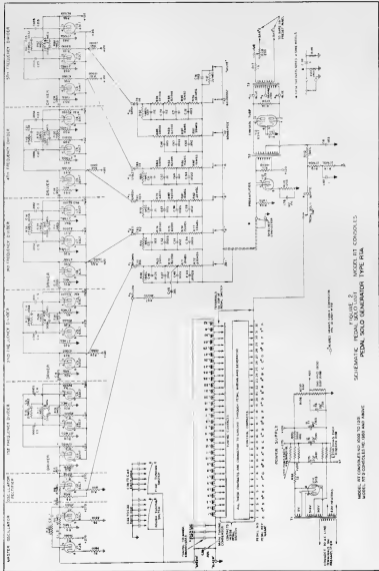

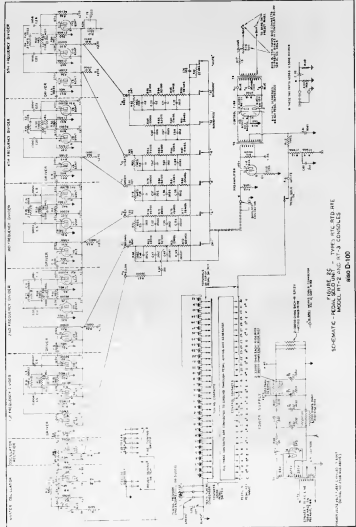

FIGURE 25 - TYPES RT-2 AND RT-3
 SCHEMATIC - RADIO SET UNIT -
 MODEL RT-2 AND RT-3 CONSOLES
 8880 D-100

TUBE SOCKET VOLTAGES
For Pedal Generator Stamped "Type RTA"

For voltages of other models see corresponding schematic diagrams.

These readings are taken with a 1000-ohms-per-volt meter having three scales of 50, 250 and 1000 volts. All voltages are taken with 117 volt line, and deviations of as much as 20 per cent may be caused by line voltage variations. The "PEDAL SOLO ON" tablet must be "on", and other tablets may be either on or off. No pedal should be depressed unless specified. The negative lead of the voltmeter is connected to ground except as noted. See figure 5 for terminal locations.

Connect Positive Voltmeter lead to:	Meter should read (volts)	Meter Scale	This shows voltage of:
+290	290	1000	1st Filter Capacitor
+270	270	1000	2nd Filter Capacitor
+120	120	250	3rd Filter Capacitor
+ 20	20	50	Divider Bias
Ground (neg. to "-37")	37	50	Control Tube Beam Supply
Tube V1 (term. #3)	180	1000	Master Oscillator Plate (1st section)
Tube V1 (term. #4)	8.5	50	Master Oscillator Cathode (1st section)
Tube V2 (term. #2)	230	1000	Master Oscillator Plate (2nd section)
Tube V2 (term. #3)	3.5	50	Master Oscillator Cathode (2nd section)
Tube V2 (term. #5)	180	1000	Oscillator Rectifier Plate
Tube V2 (term. #6)	2	50	Oscillator Rectifier Cathode
Tube V3 (term. #2)	75	250	Driver Plate
Tube V3 (term. #5), V6 (term. #3), V8 (term. #2 & #5)	95	250	Driver Plates
Tube V4, V5, V7, V9, V10 (term. #2 and #5)	55 to 75	250	Order Plates
Tube V12 (term. #3)	120	250	Preamplifier Plate
Tube V12 (term. #8)	4	50	Preamplifier Cathode
Tube V13 (term. #2 and #5)	120	250	Control Tube Plates

Connect Positive Voltmeter Lead to:	Meter Should Read (volts)	Meter Scale	This shows Voltage of:
Same, any pedal pressed	105	250	Control Tube Plates
Tube V13 (term. #3)	0	50	Control Tube Cathode
Same, any pedal pressed	3	50	Control Tube Cathode
Tube V11 (term. #8)	290	1000	Rectifier Cathode

AC VOLTAGES

Heater voltage to all tubes except V11	5 V. RMS
Rectifier tube V11 heater voltage	5 V. RMS
V11 term. #4 or #6 to "-37"	280 V. RMS
AC ripple across 1200 ohm resistors R99, R100, R101 (connect a 1/4 mfd. condenser in series with meter)	Less than 2 V. RMS
AC ripple across 5000 ohm resistor R103 (connect a 1/4 mfd. condenser in series with meter)	Less than 1 V. RMS

The following suggestions cover possible troubles in the pedal solo unit only. Suggestions for the standard organ system will be found elsewhere in the service manual.

Any trouble in the organ ahead of the matching transformer will not affect the pedal solo unit, but trouble following the transformer will affect both systems equally.

Pedal solo unit does not play. First make sure that the tubes are lighted, all controls are in playing position, and the rest of the organ plays normally. Several possible causes of trouble are listed below in order of probability.

- Tubes. The tubes are all standard radio types and can be tested in the usual way. Figure 3 shows their locations in the pedal solo generator.
- Loose cable connector. See that the 15 Pole plug and the shielded plug are inserted tightly into the pedal solo generator.
- Keying circuit. A dirty contact in the "PEDAL SOLO ON" tablet or a defective connection in any part of the keying circuit will prevent removal of the cut-off bias when a key is played. If this is the trouble, grounding pin 15 of the cable plug will make a pedal note sound. The following section, "Procedure for Removing Parts", tells how to reach and clean the tablet connections.
- Amplifier or oscillator circuit. The amplifier circuit is conventional in most respects, and voltage measurements will generally serve to identify any trouble. Failure of the master oscillator will make the pedal solo unit fail to play, and voltage readings will be helpful in this case also. Figures 4, 4A, 4B show the locations of all components, and a chart at the end of this section gives their characteristics.

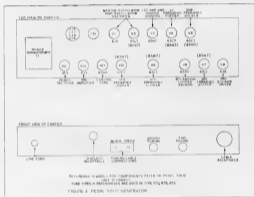

Pedal solo note does not sound on one pedal (with any combination of control tablets). The control contact of that pedal is probably dirty and can be cleaned by adjusting the pedal busbar shifter as described in the section on manuals and pedals. The same trouble may appear as an irregular spattering or crackling of a single pedal note.

This effect may also result from an open circuit in the pedal wiring, the pedal-to-main-generator cable, or the main generator wiring, since the control circuit is completed through the main generator.

All pedals fail to play on one stop tablet. If all other tablets play correctly, the signal from the oscillator or one frequency divider is not reaching the amplifier. This may be due to a loose cable plug, a broken wire, or a dirty contact on the tablet. In the latter case, refer to the following section, "Procedure for Removing Parts". The schematic diagram, figure 2, indicates which cable wire and frequency divider correspond to each tablet. Figure 5 identifies the tablets and electrical components in the control panel.

All pedals play the wrong pitch (or do not play at all) on one or more low pitched stop tablets. One frequency divider is not operating correctly, in which case all dividers below it will also fail. A cathode-ray oscilloscope connected from ground to the plate of any divider tube should show a rectangular wave, while the plate of any divider driver tube should show a very sharp and narrow negative

pulse. If electrolytic capacitor C78 is open or very low in capacity, all the dividers may fail to operate.

Key Stamps or clicks. If capacitor C 31 is open, there will be a loud thump each time a pedal is played.

Hum. An excessive 120 cycle hum in the output will result from failure of one of the filter capacitors C75, C76, C77 and C78.

Tuning of individual notes. The individual note tuning system consists of 32 small inductance coils, each of which is adjustable by moving the coil on its iron core. This tuning system is very stable because it has practically no aging effect and is very insensitive to ordinary humidity and temperature changes. However, after long use under adverse climatic conditions it is possible that some pedal solo notes may not be exactly in tune with each other.

Always tune first with the tuning knobs as indicated above. Keep in mind the fact that it is generally desirable to have the pedal solo unit slightly out-of-tune with the organ. If you are sure some notes actually require tuning, proceed as follows:

- (a) Disconnect the two cable leads from the G-G terminals on the preamplifier and ground the two wires. Connect one set of oscilloscope plates (either horizontal or vertical) to one G terminal and ground.
- (b) Connect the other set of oscilloscope plates to ground and to pin 3 of V5 through a blocking condenser.
- (c) Remove the cover of the tuning coil box at the rear of the console, exposing the numbered tuning coils. The wiring diagram shows the location of these coils. Set the fine and rough tuning knobs to their center positions.
- (d) Push in the pedal drawbars, turn the vibrator off, and turn all pedal solo tablets off. Using only the first white drawbar on either manual, hold down the second key G key from the top. Hold down the highest pedal.
- (e) Loosen the clamping screw on coil 32 and slide the coil carefully forward or backward until the note is in tune as indicated by the oscilloscope wave pattern standing still or moving no more than one cycle in two seconds. Tighten the clamping screw.
- (f) Release key and pedal and press adjacent F # key and pedal. Adjust coil 31 in same way. Repeat for all other pedals and coils in chromatic order downward. It is important to start with the highest pedal and progress downward one pedal at a time because the tuning of the lower notes is dependent upon all of the higher coils. Each pedal adds an increment of inductance in series with all coils above it, and adjusting any single note will detune all those below it.

Note: From the above you can see that tuning the individual notes is a long and tedious process and must be done with extreme care. It should not be undertaken unless you are absolutely certain that the tuning error is great enough to interfere seriously with playing the organ.

PROCEDURE FOR REMOVING PARTS

To remove Control Panel and Clean Contacts

1. Remove four screws holding music rack and place it on top of console.
2. Remove two hex head manual bolts exposed when music rack is removed.
3. Remove two large hex head manual bolts located on underside of generator shelf near rear.
4. Remove two screws passing up through right-hand chassis block of lower manual into control panel.
5. Remove one screw holding angle bracket to bottom cover of control panel.
6. Tilt upper manual upward and slide control panel assembly through opening toward back of console.
7. Remove bottom cover of control panel.
8. Remove four wood screws holding wood frame work to chassis of control panel.
9. Remove knob and loosen nut which holds volume control.
10. Tip wood frame up and slide back until rear wooden strip clears tablet identification strip.
11. Slide pivot rod out of tablet assembly and remove tablets.
12. Remove four #3 screws holding tablet assembly to chassis of control panel, and tilt assembly up. Contacts are now visible and can be cleaned by wiping gently with a cloth.

**ELECTRICAL PARTS LIST FOR PEDAL SOLO GENERATOR
CONDENSERS**

REFERENCE SYMBOL	CAPACITY	VOLTAGE	TYPE
C75	20 mfd.	400	Electrolytic
C76	20 mfd.	350	
C77	80 mfd.	150	
C78	30 mfd.	50	Electrolytic Used in Generator
C79	30 mfd.	15	
C76	40 mfd.	400	Electrolytic AD-19131-1 Not Used in Generator
C77	20 mfd.	350	
C78	20 mfd.	350	
C79	6 mfd.	200	"Type RTA"

WIRE WOUND RESISTORS

REFERENCE SYMBOL	OHMS	WATTS	PART NUMBER
R 105 Used in Generator	5000	10	626-060741
R 106 "Type RTA" only	4500	5	

VARIABLE RESISTOR

REFERENCE SYMBOL	OHMS
R 118	250

TRANSFORMERS

REFERENCE SYMBOL	FUNCTION	PART NUMBER
T 1	Power 115V. 60 cy.	005-021320-003
T 1	Power 115V. 50/60 cy.	
T 1	Power 230V. 50/60 cy.	
T 2	Auto	
T 3	Output	

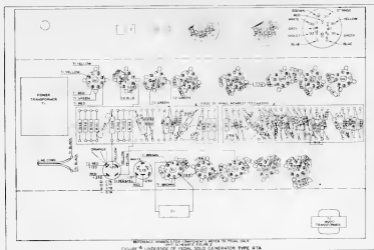

REPRODUCED FROM THE ORIGINAL DRAWING BY THE PEDAL SOLO
FIGURE 4 - UNDERSIDE OF PEDAL SOLO GENERATOR TYPE RTA

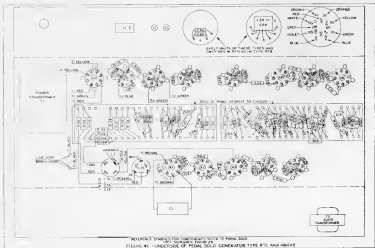
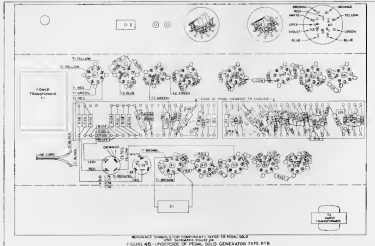

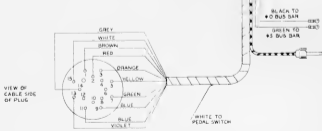
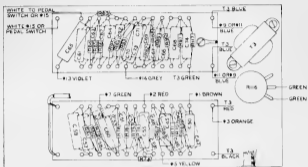

REFERENCE SYMBOLS FOR COMPONENTS REFER TO PEDAL SOLO UNIT SCHEMATIC, FIGURE 2

FIGURE -UNDERSIDE OF PEDAL SOLO CONTROL PANEL



AMPLIFICATION

THE AMPLIFICATION SYSTEM

The electrical impulses which produce the tones of the Hammond Organ are given their original amplification by a preamplifier located in the console, and are then transmitted to the power amplifiers which are located in the tone cabinets. It will be noted that no power transformer is included in the preamplifiers shown in Figures 1 through 3, the required plate current being supplied by the power amplifier in the first tone cabinet. Later models of preamplifiers have a complete power supply incorporated within them.

A tone control is included in all preamplifiers whereby the relative intensity of the high and low frequencies may be changed to suit acoustical conditions by varying the amplitude of the higher frequencies. On tremulant equipped consoles this control will be found under a screw cap located toward the right end of the chassis, while on consoles equipped with the Hammond Vibrato this tone control will be found under the cap marked "HI IMP INPUT." Selective vibrato consoles have the tone control located midway on the preamplifier chassis.

A microphone or phonograph pickup may be used with the organ if special circumstances make it desirable. On tremulant type consoles the input terminal, marked "P" on the preamplifier, goes through a screen by-pass condenser to the screen of the input tube. This terminal is normally grounded, and the input device should have an impedance of 500 ohms or less in order not to reduce the volume of the organ. A signal level of a volt or more is required to drive this point, and therefore it is suggested that the microphone or phonograph be connected through a suitable preamplifier having an output impedance of about 200 ohms.

On vibrato consoles the input terminal, located under the cap marked "HI IMP INPUT" on the preamplifier, goes to the grid of one input tube. This circuit has an input of 1 megohm impedance and requires an input signal of about 60 millivolts maximum.

Most preamplifiers used on selective vibrato type consoles are equipped with a standard phonograph input jack. The input impedance is approximately 1 megohm and the circuit requires a maximum input signal of about 1/2 volt.

The push-pull signal line from the preamplifier output transformer to the tone cabinets has a total impedance of approximately 500 ohms. As it is connected directly to the grids of the power amplifier input tubes, practically any number of power amplifiers may be connected in parallel.

The section on cables and plugs shows methods of connecting amplifiers to the console.

Replacement parts, with the exception of resistors, condensers, and tubes, which are standard items and may be purchased from a radio supplier, should always be ordered from Hammond Organ Company. When ordering, specify the type and serial number of the console or tone cabinet.

When making tube replacement, output tubes in the amplifier should be checked for similar plate current readings. If tubes have been in service for a considerable length of time it is usually advisable to change all tubes at one time rather than to try to match new tubes to the old ones.

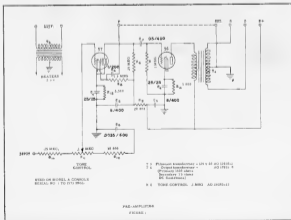

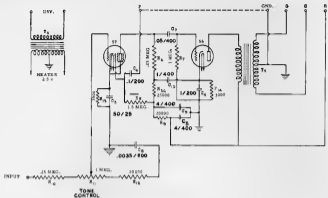

USED ON MODEL A CONSOLE
SERIAL NO. 1574 TO 2491 INCL.

USED ON MODEL B CONSOLE
SERIAL NO. 4000 TO 14151 INCL.

-PRE-AMPLIFIER-
FIGURE 1

- T 1 Filament transformer - 25 v 60 cy AD 1793-1
T 4 Output transformer - AD 1793-2
(Primary 1170 ohms)
(Secondary 15 ohms)
(DC Resistance)
- R 11 TONE CONTROL J MED AD 2095-23

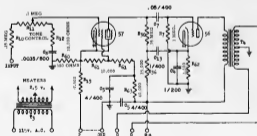

USED ON MODEL A CONSOLE
SERIAL NO. 2492 TO 2519 INCL.

USED ON MODEL B CONSOLE
SERIAL NO. 1540 TO 14151 INCL.

-PRE-AMPLIFIER-

FIGURE 1

- T 1 Filament transformer - 25 v 60 cy AD 1793-1
T 4 Output transformer - AD 1793-2
(Primary 1100 ohms,
Secondary 15 ohms,
DC Resistance)
- R 11 TONE CONTROL J MED AD 2095-13

-PRE-AMPLIFIER-

FIGURE 1

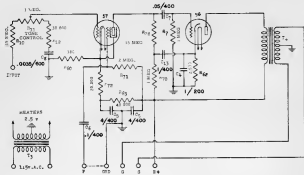

USED IN CONSOLES

MODEL A SERIAL NO. 944 TO 2446 INCL.
 MODEL B SERIAL NO. 944 TO 974 INCL.
 MODEL C SERIAL NO. 121 TO 112 INCL.
 MODEL D SERIAL NO. 1 TO 109 INCL.
 PLAYER SERIAL NO. 900 TO 921 INCL.

T 3 Filament transformer 25 - 40 cy AD 1782-4
 T 4 Output transformer AD 1783-4
 (Primary 150 ohms,
 Secondary 15 ohms
 DC Resistance)

R 2 TONE CONTROL 1 MΩ AD 20283-21

77B-AMPLIFIER
 FIGURE 4

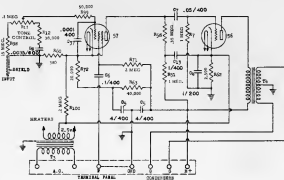

USED IN CONSOLES

MODEL A SERIAL NO. 1647 TO 271 INCL.
 MODEL B SERIAL NO. 1801 TO 2209 INCL.
 MODEL C SERIAL NO. 133 TO 179 INCL.
 MODEL D SERIAL NO. 164 TO 244 INCL.
 PLATE SERIAL NO. 514 & 520
 MODEL G - ALL

R 2 TONE CONTROL 1 MΩ AD 20283-21

T 3 Filament transformer 35 - 44 cy AD 1782-4
 T 4 Output transformer AD 1783-4

77C-AMPLIFIER

FIGURE 5

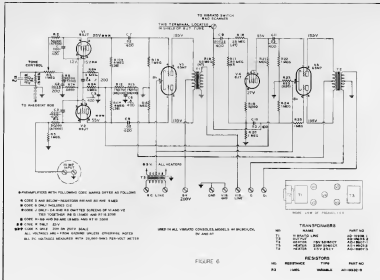
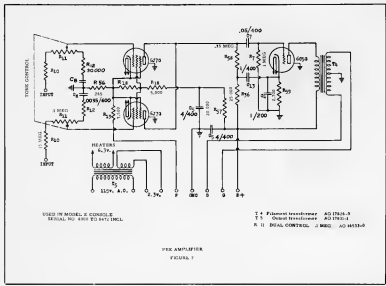
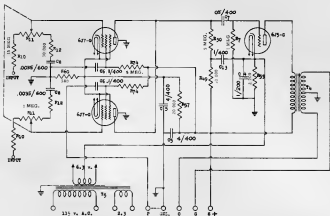

FIGURE 6



TONE CONTROL



USED IN MODEL E CONSOLE
SERIAL NUMBER 5171 TO 5441 INCL.

T 4 Output Transformer AO 1762-0
T 5 Filament Transformer AO 1762-1
K 11 Dial Control J MEG AO 18513-4

PRE AMPLIFIER
FIGURE 2

TONE CONTROL

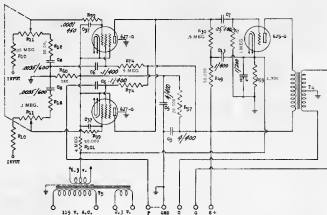

USED IN MODEL E CONSOLE
SERIAL NUMBER 5042 TO 5719 INCL.
(C 17 & 8, 93 omitted in early
[low amplitude of disc series].)

T 4 Output Transformer AO 18711-0
T 5 Filament Transformer AO 1762-1
J MEG; Dial Control AO 18513-0

PRE AMPLIFIER
FIGURE 1

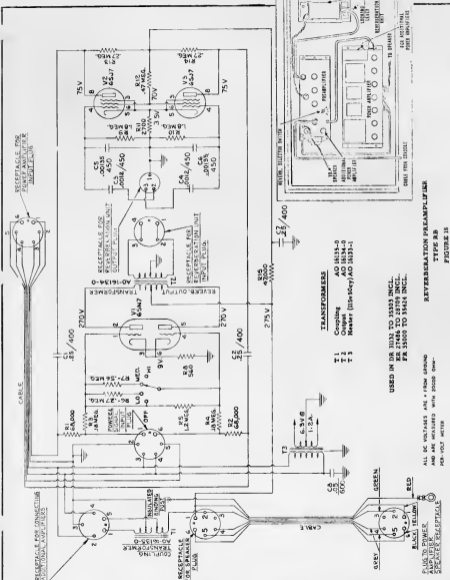

RECEPTACLE FOR CONNECTING 125TUBULAR AMPLIFIERS

RECEPTACLE FOR POWER AMPLIFIER INPUT PLUG

RECEPTACLE FOR SPEAKER SUPPLY PLUG

RECEPTACLE FOR SPEAKER SUPPLY PLUG

RECEPTACLE FOR SPEAKER SUPPLY PLUG

RECEPTACLE FOR SPEAKER SUPPLY PLUG

RECEPTACLE FOR SPEAKER SUPPLY PLUG

RECEPTACLE FOR SPEAKER SUPPLY PLUG

RECEPTACLE FOR SPEAKER SUPPLY PLUG

RECEPTACLE FOR SPEAKER SUPPLY PLUG

RECEPTACLE FOR SPEAKER SUPPLY PLUG

RECEPTACLE FOR SPEAKER SUPPLY PLUG

RECEPTACLE FOR SPEAKER SUPPLY PLUG

RECEPTACLE FOR SPEAKER SUPPLY PLUG

RECEPTACLE FOR SPEAKER SUPPLY PLUG

RECEPTACLE FOR SPEAKER SUPPLY PLUG

RECEPTACLE FOR SPEAKER SUPPLY PLUG

RECEPTACLE FOR SPEAKER SUPPLY PLUG

RECEPTACLE FOR SPEAKER SUPPLY PLUG

RECEPTACLE FOR SPEAKER SUPPLY PLUG

RECEPTACLE FOR SPEAKER SUPPLY PLUG

RECEPTACLE FOR SPEAKER SUPPLY PLUG

RECEPTACLE FOR SPEAKER SUPPLY PLUG

RECEPTACLE FOR SPEAKER SUPPLY PLUG

RECEPTACLE FOR SPEAKER SUPPLY PLUG

RECEPTACLE FOR SPEAKER SUPPLY PLUG

TRANSFORMERS

- T 1 Coupling AO 16135-0
- T 2 Output AO 16134-0
- T 3 Heater (110-10cy) AO 16133-1

USED IN DR 3132 TO 35303 INCL.
 DR 27486 TO 28709 INCL.
 PR 35500 TO 35454 INCL.

REVERBATION PRE-AMPLIFIER

TYPE RB

FIGURE 18

ALL DC VOLTAGES ARE + FROM GROUND
 AND ARE MEASURED WITH 2000 OHM-
 PER-VOLT METER

BLACK, YELLOW, GREEN, GREY
 PLUG TO POWER SUPPLY
 SPEAKER RECEPTACLE

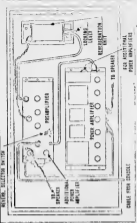

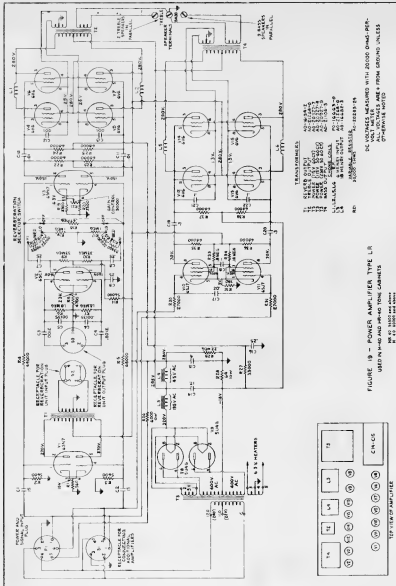

FIGURE 19 - POWER AMPLIFIER TYPE LR
USED IN M-40 AND M-40 TONE CABINETS

NO. 40 3400 and above
P. 40 3400 and above

- TRANSFORMERS**
- T1 SELECTOR OUTPUT
 - T2 DETECTOR
 - T3 MIXER
 - T4 MIXER OUTPUT
 - T5 DETECTOR
 - T6 MIXER
 - T7 MIXER
 - T8 MIXER
 - T9 MIXER
 - T10 MIXER
 - T11 MIXER
 - T12 MIXER
 - T13 MIXER
 - T14 MIXER
 - T15 MIXER
 - T16 MIXER
 - T17 MIXER
 - T18 MIXER
 - T19 MIXER
 - T20 MIXER
 - T21 MIXER
 - T22 MIXER
 - T23 MIXER
 - T24 MIXER
 - T25 MIXER
 - T26 MIXER
 - T27 MIXER
 - T28 MIXER
 - T29 MIXER
 - T30 MIXER
 - T31 MIXER
 - T32 MIXER
 - T33 MIXER
 - T34 MIXER
 - T35 MIXER
 - T36 MIXER
 - T37 MIXER
 - T38 MIXER
 - T39 MIXER
 - T40 MIXER
 - T41 MIXER
 - T42 MIXER
 - T43 MIXER
 - T44 MIXER
 - T45 MIXER
 - T46 MIXER
 - T47 MIXER
 - T48 MIXER
 - T49 MIXER
 - T50 MIXER
 - T51 MIXER
 - T52 MIXER
 - T53 MIXER
 - T54 MIXER
 - T55 MIXER
 - T56 MIXER
 - T57 MIXER
 - T58 MIXER
 - T59 MIXER
 - T60 MIXER
 - T61 MIXER
 - T62 MIXER
 - T63 MIXER
 - T64 MIXER
 - T65 MIXER
 - T66 MIXER
 - T67 MIXER
 - T68 MIXER
 - T69 MIXER
 - T70 MIXER
 - T71 MIXER
 - T72 MIXER
 - T73 MIXER
 - T74 MIXER
 - T75 MIXER
 - T76 MIXER
 - T77 MIXER
 - T78 MIXER
 - T79 MIXER
 - T80 MIXER
 - T81 MIXER
 - T82 MIXER
 - T83 MIXER
 - T84 MIXER
 - T85 MIXER
 - T86 MIXER
 - T87 MIXER
 - T88 MIXER
 - T89 MIXER
 - T90 MIXER
 - T91 MIXER
 - T92 MIXER
 - T93 MIXER
 - T94 MIXER
 - T95 MIXER
 - T96 MIXER
 - T97 MIXER
 - T98 MIXER
 - T99 MIXER
 - T100 MIXER

DC VOLTAGES MEASURED WITH 2000 OHMS-
PER-VOLT VOLTMETER ARE FROM GROUND UNLESS
OTHERWISE NOTED



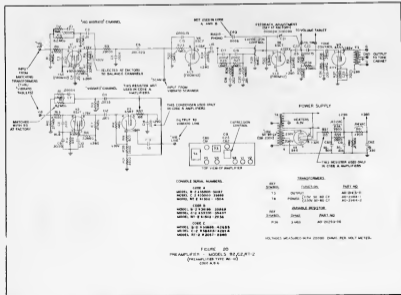
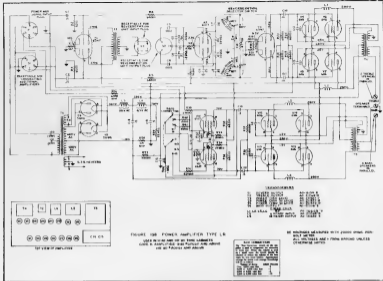

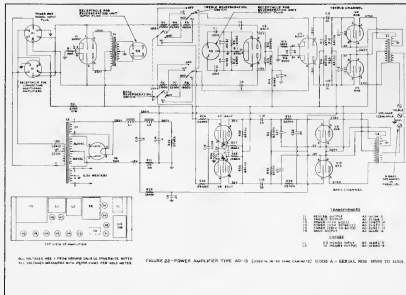
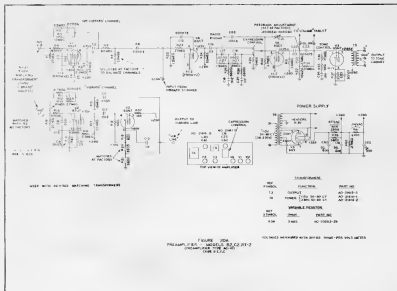

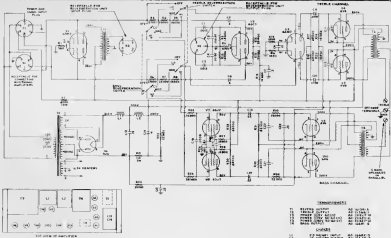

FIGURE 20A—POWER AMPLIFIER, TYPE 6D-15 (USED IN 10 OF YOUR CABLESETS)
 TYPE 2 AMPLIFIER—CHECK! SERIAL NO. 100-100-100

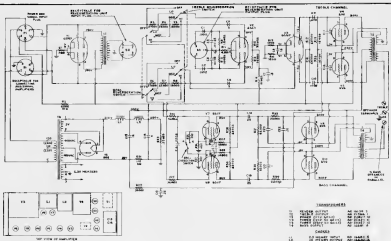
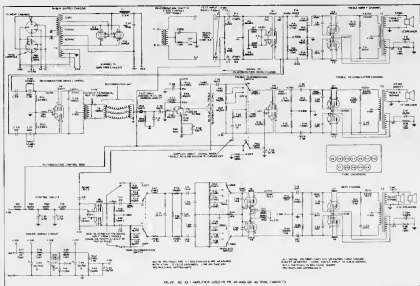
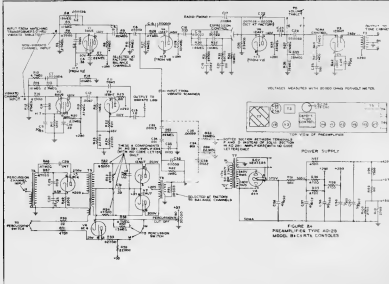
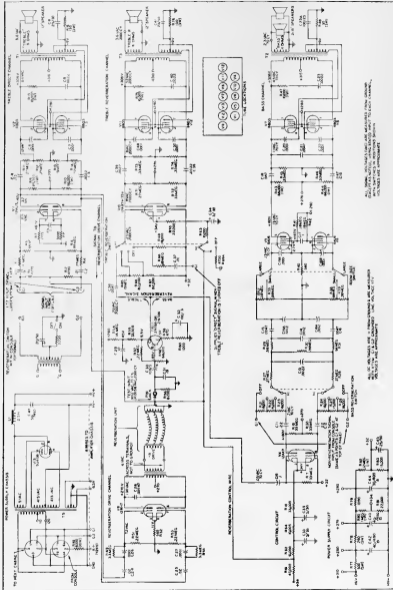

FIGURE 20B—POWER AMPLIFIER, TYPE 6D-15 (USED IN 10 OF YOUR CABLESETS)
 TYPE 2 AMPLIFIER—CHECK! SERIAL NO. 100-100-100





ALL TUBE CHARACTERISTICS ARE BASED ON DATA FROM MANUFACTURERS' LITERATURE. VALUES MAY VARY FROM THOSE SHOWN DUE TO AGE OR REPLACEMENT.

ALL DC VOLTAGES ARE - UNLESS OTHERWISE INDICATED. ALL CAPACITANCE VALUES ARE IN MICROFARADS UNLESS OTHERWISE INDICATED.

FIG. 20 AO 30-32 AMPLIFIER USED IN FM-22 TONE CABINET

40 Watt Output
INPUT WATTAGE 220

Equipped with two 15" speakers for bass tones and two 12" speakers for the treble tones. They provide three dimension amplification which creates a beautiful reverb effect in Stereo. These cabinets feature the new and improved Hammond Reverberation control for both bass and treble tones. Convenient outside controls make it easy to change the degree of reverberation for each.

DIMENSIONS: 31-3/2" Wide 37-1/2" High 18" Deep

WEIGHT: 130 Lbs.

The QR-40 is electrically similar to the PR-40 but with its utility type cabinet is only used where appearance is not a consideration, such as in tone and reverberation chambers.

PR 40 FRONT

PR 40 REAR

The treble direct speaker is normally mounted in the top. In an unusual installation where the ceiling is very low, or cabinets are stacked or reduction is otherwise restricted, it is possible to move this speaker to the hole provided in the front. The metal diffuser in front of the speaker must also be moved, and the wooden cover must be attached under the top to close the hole.

DIMENSIONS: 31" Wide 36-5/8" High 17-1/4" Deep

WEIGHT: 121 Lbs.

QR 40 FRONT

QR 40 REAR

TONE CABINET INSTRUCTIONS

MODELS PR-20 AND QR-40

Refer to card on underside of bench top for console installation and wiring instructions.

CAUTION
PACKING FOR MOVING
OR SHIPMENT

The Reverberation Unit must be locked before moving cabinet or seat, otherwise, delicate parts will be damaged because of loosening of the three coil springs when hanging free. To lock the Reverberation Unit, insert screwdriver in slot at end of lock rod "A" shown in Fig. 1 and turn 1/4 turn counterclockwise. If cabinet has star grille, an opening is provided in grille cloth to allow access to lock rod. Never remove tubes from their sockets without first turning off power to console.

INSTALLATION

Unlock Reverberation Unit by inserting screwdriver in slot at end of lock rod "A" shown in Fig. 1 and turning 1/4 turn clockwise so that slot is vertical. If cabinet has star grille, an opening is provided in grille cloth to allow access to lock rod. Cabinet must be level and must not rock. Floor must be firm to avoid vibration. Connect console-to-cabinet cable as shown in Fig. 1.

Additional tone cabinets may be connected to the unit by using a 5-conductor cabinet-to-cabinet cable connected to sockets marked "ADDITIONAL POWER AMPLIFIERS" in Fig. 1. Signal at this point comes directly from console and does not have reverberation. If additional cabinets are not Type PR or QR, inquire of your Hammond dealer or the factory Service Department or use of soldering irons. If total input wattage of all cabinets exceeds rating on console schematic, auxiliary power relay must be provided.

THREE CHANNELS

The amplifier in the tone cabinet has three channels. The bass channel drives two 15" speakers and responds only to frequencies below 200 cycles. The treble reverberation channel drives the lower 12" speaker and covers the range above 200 cycles. The treble direct channel, driving the upper 12" speaker, also covers the range above 200 cycles.

REVERBERATION SWITCHES

The relative amount of reverberation for the treble and bass channels can be selected by two mounted switches located on the side of the cabinet. Each switch has four positions. When both switches are in the "OFF" position, the reverberation effect is completely eliminated and all three channels carry the direct signal from the console.

A Reverberation Switch Kit can be obtained to turn the reverberation effect on and off from the console. Ask any Hammond dealer for details.

ROOM SIZE SWITCH

The room size control switch located on the amplifier, "B" in Fig. 1, is provided with a slot for adjustment of the bass volume to compensate for variations in room size. When used in a small room, it should be adjusted to reduce the bass volume for less total balance. Appropriate settings for rooms with average furnishings will be as follows:

MODEL PR-40

VOLUME OF ROOM	POSITION OF SWITCH
over 14,000 cu. ft.	fully counterclockwise
8000 to 14,000 cu. ft.	near to counterclockwise
4000 to 8000 cu. ft.	near to clockwise
1000 to 4000 cu. ft.	fully clockwise

MODEL PR-20

VOLUME OF ROOM	POSITION OF SWITCH
over 7000 cu. ft.	counterclockwise
1000 cu. ft. or less	clockwise

LOCATION OF TONE CABINET

The back of this tone cabinet must be at least 15" from the wall in order to provide adequate ventilation. The location of the tone cabinet in the room is of great acoustic importance. Consult a Hammond service man for recommendations.

The cabinet must always be placed at some distance from the console, not only for acoustic reasons, but also because the magnetic field from the amplifier may produce a hum in the console circuits if

the two are very close together. In case of hum, make certain that no piece of electrical apparatus having a strong magnetic field is close to the console, for example, an electric clock or a fluorescent light on the console rim, in some cases, produce a loud hum in the speakers.

NOTE - Always supply model designation and serial number when writing the factory regarding the console or the tone cabinet. This information can be obtained from the consoleplate.

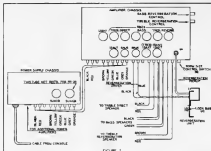

FIGURE 1

AM-32744-B

HAMMOND ORGAN COMPANY

4200 W. Diversey Ave.

Chicago 39, Illinois

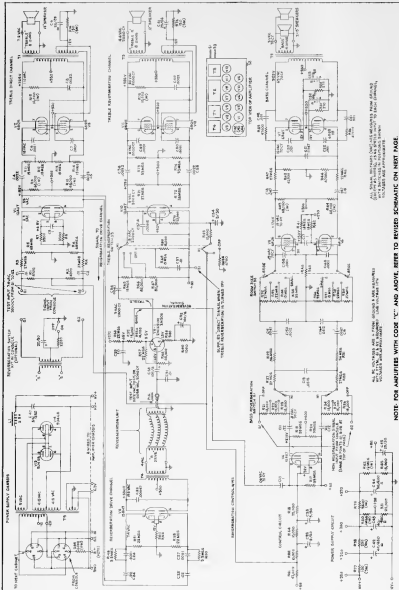

ALL VALUES UNLESS OTHERWISE SPECIFIED REFER TO EACH CHANNEL UNLESS OTHERWISE SPECIFIED.

ALL VALUES ARE IN PERCENT UNLESS OTHERWISE SPECIFIED.

NOTE: FOR AMPLIFIERS WITH CODE "C" AND ABOVE, REFER TO REVISED SCHEMATIC ON NEXT PAGE. FIG. 38A AD-33-J AMPLIFIER USED IN FR-40 AND OR-40 TONE CABINETS FOR AMPLIFIER CODE "A" & "B."

P-40, Q-40 TONE CABINET

40 Watt Output
INPUT WATTAGE

Equipped with a two channel amplifier, two 15" speakers and two 12" speakers serving the bass and treble channels respectively. This tone cabinet in conjunction with a Hammond tone cabinet with reverberation can add the additional power required for larger installation at a minimum cost. Can also be used alone where sufficient natural reverberation is evident.

DIMENSIONS: 31-1/2" Wide 37-1/2" High 18" Deep

WEIGHT 126 LBS.

The Q40 is electrical similar to the P40 but with utility type cabinet is only used where appearance is not a consideration such as tone and reverberation chambers.

The treble speakers are normally mounted in the top. In unusual installation where the ceiling is very low, or cabinets are stacked or radiation is otherwise restricted it is possible to move these speakers to the holes provided in the front. The metal diffusers in front of the speakers must also be moved and the wooden covers must be attached under the top to close the holes.

DIMENSIONS: 31" Wide 36-5/8" High 17-1/4" deep

WEIGHT 110 LBS.



P40 FRONT



Q40 FRONT



P40 REAR



Q40 REAR

tone cabinet INSTRUCTIONS
MODELS P-40 AND Q-40

IMPORTANT

When cabinet is to be shipped, or moved from room, tighten nuts at each end of spring mounted amplifier to prevent damage.

Never remove tubes from their sockets without first turning off power at console.

Always supply model designation and serial number when writing factory regarding console or tone cabinet. This information can be obtained from console/toner.

INSTALLATION

Set up cabinet for operation as follows:

1. Loosen nut at each end of amplifier and amplifier flows freely on mounting springs. Leave it in one on steel with about 1/16" clearance to chassis. Failure to loose nuts may cause heat in tone cabinet.

In case where amplifier is held down with 4 additional screws at console, these screws and 4 tapped plates under each shelf should be removed and discarded.

2. Connect console to cabinet (ask as shown in Figure 1).

3. Model Q-40 is intended for use in a reverberation or tone chamber. The two treble speakers are normally mounted in the top. In unusual installation where ceiling is very low, or cabinets are stacked or radiation from top is otherwise restricted, it is possible to move these speakers to holes provided in the front. The metal diffusers must

be moved with the speakers, and wooden covers from front holes should then be used to seal top holes.

Additional tone cabinets may be connected to the unit by using 1 conductor cabinet to cabinet cable connected to socket marked Additional Power Amplifier in Fig. 1. Signal at this point comes directly from console.

3. If total input wattage of all cabinets is used along on console sample, an extra power relay must be provided.

TREBLE AND BASS CHANNELS

The amplifier in this tone cabinet incorporates dividing networks, so that the two 15" bass speakers respond only to the frequencies below 700 cycles and the two 12" treble speakers cover the range above 700 cycles.

BASS CORRECTION

Bass Correction switch on amplifier is used to compensate for variations in room size. When cabinet is used in a small room, switch should be adjusted to reduce bass volume for best total balance. Approximate settings for rooms with average furnishings will be as follows:

(If cabinet is placed in a size that has these figures apply to size of listening room.)

VOLUME OF ROOM	SWITCH POSITION
Over 16,000 cubic feet	0
8,000 to 16,000 cubic feet	5
4,000 to 8,000 cubic feet	-5
2,000 to 4,000 cubic feet	-10

LOCATION OF TONE CABINET

The back of the tone cabinet must be at least 1/2" inches from the wall in order to provide adequate ventilation.

The location of the tone cabinet in the room is of great acoustic importance. Consult a Hammond service man for room acoustics. The cabinet must always be placed at some distance from the console, not only for acoustic reasons but also because the magnetic field from the amplifier can produce a hum in the console circuit

if the two are very close together.

In case of bass notes, certain the presence of electrical apparatus having a strong magnetic field is close to the console, for example an electric clock or a fluorescent light on the console can in some cases, produce a loud hum in the speakers.

Some hum in the bass channel may be caused by unbalanced AVX tubes. Four new tubes of same make will generally be satisfactorily balanced. Sometimes, bass level can be reduced by interchanging 6V6 tubes.

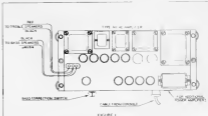

40 12344-B

HAMMOND ORGAN COMPANY

4200 W. Diverser Ave.

Chicago 39, Illinois

PR-20 TONE CABINET

20 Watt Output
INPUT VOLTAGE 115V

Equipped with two 15" speakers for bass tones and two 12" speakers for the treble tones. They provide three dimension amplification which creates a beautiful reverberation effect in Stereo. These cabinets feature the new and improved Hammond Reverberation control for both bass and treble tones. Convenient outside controls make it easy to change the degree of reverberation for each.

DIMENSIONS 31-1/2" Wide 37-1/2" High 18" Deep

WEIGHT: 118 Lbs.



PR 20 FRONT



PR 20 REAR

STONE CABINET INSTRUCTIONS

MODELS PR-20 AND PR-40

THREE CHANNELS

The amplifier in this tone cabinet has three channels. The bass channel drives two 15" speakers and responds only to frequencies below 200 cycles. The treble or reverberation channel drives the lower 12" speaker and covers the range above 200 cycles. The treble direct channel, driving the upper 12" speaker, also covers the range above 200 cycles.

REVERBERATION SWITCHES

The relative amount of reverberation for the treble and bass channels can be adjusted by two crossed switches located on the side of the cabinet. Each switch has four positions. When both switches are in the OFF position, the reverberation effect is completely eliminated and all three channels carry the direct signal from the console.

A Reverberation Switch Kit can be obtained to turn the reverberation effect on and off from the console. Ask any Hammond dealer for details.

ROOM SIZE SWITCH

The room size control switch located on the amplifier "B" in Fig. 1, is provided with a slide for adjustment of the bass volume to compensate for variations in room size. When used in a small room, it should be adjusted to reduce the bass volume for best initial balance. Approximate settings for rooms with average size ceilings will be as follows:

MODEL PR-40

VOLUME OF ROOM
 over 18,000 cu. ft. Fully across the slide
 8,000 to 18,000 cu. ft. 3/4 way to right
 4,000 to 8,000 cu. ft. 1/2 way to right
 2,000 to 4,000 cu. ft. 1/4 way to right

POSITION OF SWITCH
 Fully across the slide
 3/4 way to right
 1/2 way to right
 1/4 way to right

MODEL PR-20

VOLUME OF ROOM
 over 18,000 cu. ft. Fully across the slide
 8,000 to 18,000 cu. ft. 3/4 way to right
 4,000 to 8,000 cu. ft. 1/2 way to right
 2,000 to 4,000 cu. ft. 1/4 way to right

POSITION OF SWITCH
 Fully across the slide
 3/4 way to right
 1/2 way to right
 1/4 way to right

LOCATION OF TONE CABINET

The back of the tone cabinet must be at least 18" from the wall in order to provide adequate ventilation. The location of the tone cabinet in the room is of great acoustic importance. Consult a Hammond service man for recommendations.

The cabinet must always be placed at some distance from the console, not only for acoustic reasons, but also because the magnetic field from the amplifier may produce a hum in the console circuit if the two are very close together. In case of hum, make certain that no piece of electrical apparatus having a strong magnetic field is close to the console, for example, an electric clock or a fluorescent light on the console unit, in some cases, produce a loud hum in the speaker.

NOTE—Always supply model designation and serial number when writing the factory regarding the console on the tone cabinet. This information can be obtained from the nameplate.

NOTE—Always supply model designation and serial number when writing the factory regarding the console on the tone cabinet. This information can be obtained from the nameplate.

Refer to end of instructions of bench top for console installation and wiring instructions.

CAUTION PACKING FOR MOVING OR SHIPMENT

The Reverberation Unit must be locked before moving cabinet or unit; otherwise, different parts will be damaged because of loosening of the floor coil springs when lugging free. To lock the Reverberation Unit, insert screwdriver in slot at end of lock rod "A" shown in Fig. 1 and turn 1/4 turn clockwise. If cabinet has rear grille, an opening is provided in grille slot to allow access to lock rod. Never remove tubes from their sockets without first turning off power at console.

INSTALLATION

Unlock Reverberation Unit by turning screwdriver in slot at end of lock rod "A" shown in Fig. 1 and turning 1/4 turn clockwise so that slot is vertical. If cabinet has rear grille, an opening is provided in grille slot to allow access to lock rod.

Cabinet must be level and stand in a room that must be free to circulate air. Connect console cabinet cable as shown in Fig. 1.

Additional tone cabinets may be connected to this set by using a 4 conductor cabinet to cabinet cable connected to sockets marked "ADDITIONAL POWER AMPLIFIERS" in Fig. 1. Signal at the point comes directly from console and does not have reverberation. If additional cabinets are not Type PR or QR, require of your Hammond dealer the factory Series 50. Dependent on use of isolating transformer. If total output wattage of all cabinets exceeds rating on console name plate, standby power may be provided.

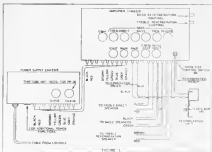

AO-12743-0

HAMMOND ORGAN COMPANY

4200 W. Diversey Ave.

Chicago 39, Illinois

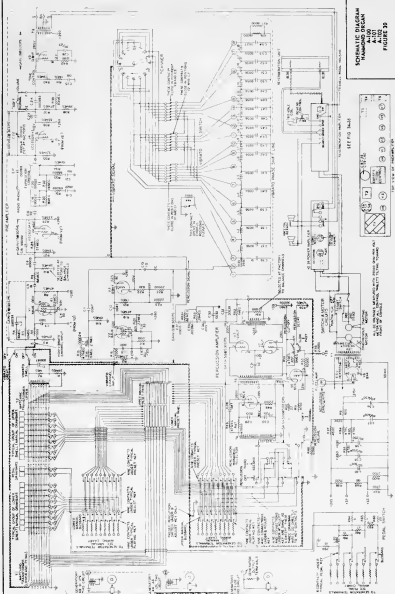

SCHEMATIC DIAGRAM
 HAND-DRAWN DECAN
 A-100
 A-101
 A-102
 A-103
 FIGURE 20



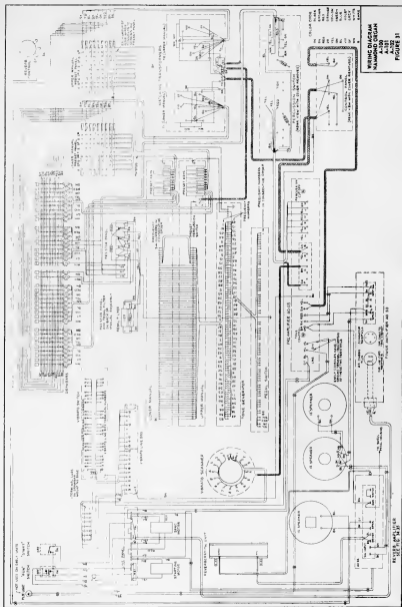

WIRING DIAGRAM
NAMMORG ORGAN
A-130
A-131
A-132
FIGURE 31

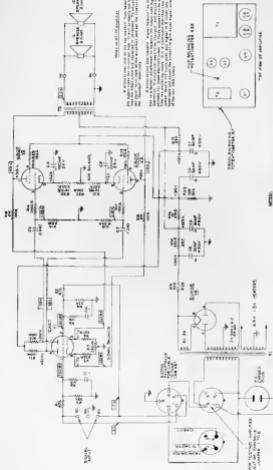

MODEL NO. 61-10-100-100-100

REPLACEMENT PARTS LIST
 1. ALL RESISTORS 0.5% TOL. 50W. UNLESS NOTED OTHERWISE
 2. ALL 500 OHMS RESISTORS W/OUT VALUE LISTED BY 1/2% TOL.
 3. 1/2% TOL. 500 OHMS RESISTORS W/OUT VALUE LISTED BY 1/2% TOL.
 4. ALL 500 OHMS RESISTORS W/OUT VALUE LISTED BY 1/2% TOL.

REPLACEMENT PARTS LIST
 1. ALL RESISTORS 0.5% TOL. 50W. UNLESS NOTED OTHERWISE
 2. ALL 500 OHMS RESISTORS W/OUT VALUE LISTED BY 1/2% TOL.
 3. 1/2% TOL. 500 OHMS RESISTORS W/OUT VALUE LISTED BY 1/2% TOL.
 4. ALL 500 OHMS RESISTORS W/OUT VALUE LISTED BY 1/2% TOL.



FOR USE WITH 6X4 TUBE

MODEL NO. 61-10-100-100-100

REPLACEMENT PARTS LIST
 1. ALL RESISTORS 0.5% TOL. 50W. UNLESS NOTED OTHERWISE
 2. ALL 500 OHMS RESISTORS W/OUT VALUE LISTED BY 1/2% TOL.
 3. 1/2% TOL. 500 OHMS RESISTORS W/OUT VALUE LISTED BY 1/2% TOL.
 4. ALL 500 OHMS RESISTORS W/OUT VALUE LISTED BY 1/2% TOL.

SCHEMATIC DIAGRAM
 ADULT POWER AMPLIFIER
 USED IN HANDBOOK ORIGIN
 61-10-100-100-100
 61-10-100-100-100
 61-10-100-100-100
 FIGURE 10

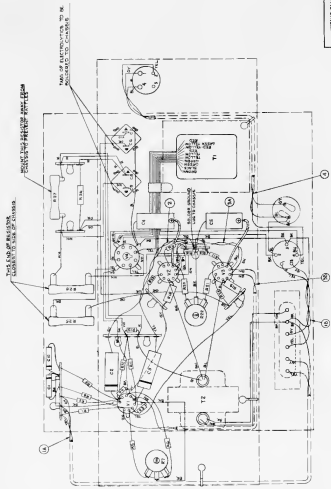

WIRING DIAGRAM
 AUDIO AMPLIFIER
 USED IN HANDING DEKAM
 A-100
 A-101
 A-102
 FIGURE 38

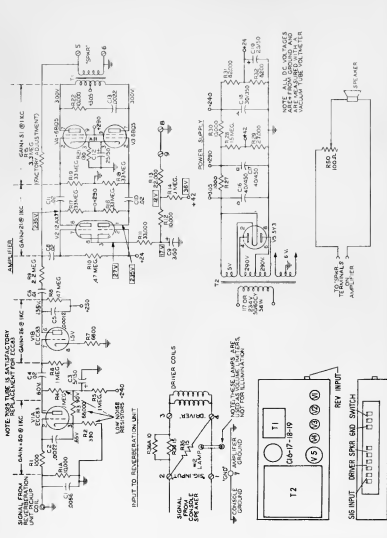
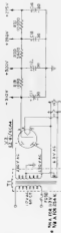
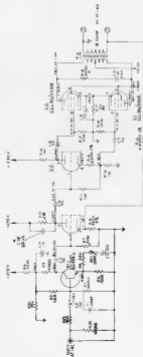

FIGURE 34 - SCHEMATIC, REVERBERATION AMPLIFIER AO 35 USED IN EARLY SERIES A-100 CONSOLES

NOTES

- 1. ALL COMPONENTS MARKED WITH A "Z" OR "E" ARE AVAILABLE WITH THE "AO-44"™ REVERBERATION AMPLIFIER.
- 2. ALL RESISTORS MARKED WITH A "Z" OR "E" ARE AVAILABLE WITH THE "AO-44"™ REVERBERATION AMPLIFIER.



These components will only be found in AO-44 amplifiers marked with Code "Z".

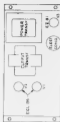
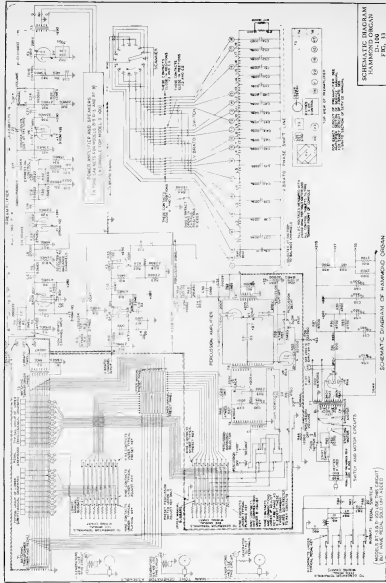
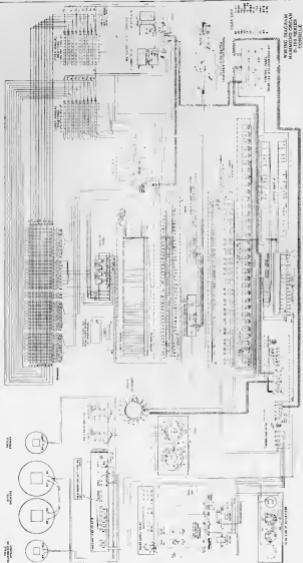

FIGURE 35A - SCHEMATIC REVERBERATION AMPLIFIER AO-44 USED IN LATER SERIES A-100 CONSOLES





WIRING DIAGRAM
PROGRAM HANDLING
SYSTEM
CONSOLE
FIG. 31

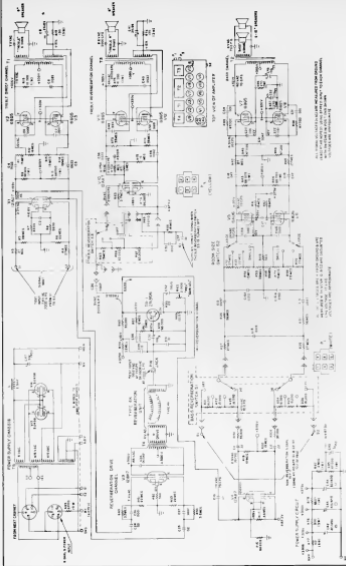

FIGURE 36—AMPLIFIER USED IN D-100 SERIES CONSOLE—A0-33-5

NOTE: THE FOLLOWING INFORMATION PERTAINS SPECIFICALLY TO THE MODELS B-3 & C-3. HOWEVER, DUE TO THE SIMILARITY OF THE CONSOLE MODELS IN THIS MANUAL, MUCH OF THE INFORMATION WILL APPLY TO THEM ALSO

TROUBLE LOCATION

3-1. TROUBLESHOOTING.

3-2. GENERAL. When troubleshooting, use all of the aids included in this handbook: block diagram (figure 3-1), overall schematic (figure 3-3), amplifier schematic (figure 5-10), illustrations of components (figures 1-4, 1-5, and 3-2),

stage (as shown in schematic, figure 3-3). Make all capacitor checks with capacitor analyzer, if available. Always disconnect capacitors before making tests; otherwise the readings will be affected by a possible shunt circuit. Replace any capacitor which shows a deviation of 20 percent or more.



Figure 3-1. Block Diagram of C-3 Console with PR-40 Tone Cabinet



Figure 3-2. Pedal Switch Assembly

and the trouble shooting chart (reference paragraph 3-28). Before starting an elaborate test procedure, make a thorough visual inspection to locate the fault. Check for defective wiring, drops of solder, faulty connections, open resistors and capacitors, jammed tone wheels, etc.

3-3. TUBE TESTING. When the trouble is traced to a specific stage, test tubes in that stage. If tubes are satisfactory, make a point-to-point voltage check in accordance with paragraph 3-4.

3-4. VOLTAGE AND RESISTANCE MEASUREMENTS. Make voltage and resistance measurements on the individual components of the

3-5. RESISTORS. Resistors used in Hammond Organs are marked with the standard EIA (Electronic Industries Association) color code, as shown in Table II. In this code, the body color or first color ring (starting from the outside edge) indicates the first digit of the resistor value. The second ring denotes the second digit, and the third ring represents the number of zeros after the second digit. Thus a resistor marked with brown, green, and yellow rings (in that order) would have a value of 150,000 ohms. Gold and silver rings represent percentage tolerance, gold indicating 5 percent tolerance and silver indicating 10 percent tolerance. Replace

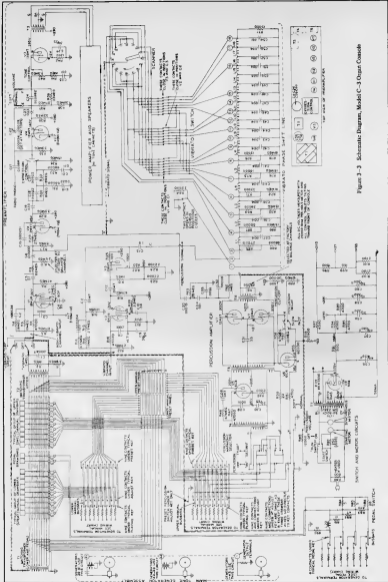

Figure 3-3 Schematic Diagram, Model C-3 Organ Console

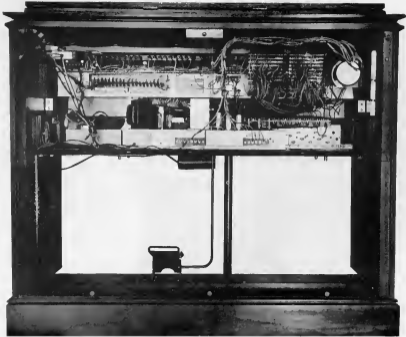

Figure 1-4. Rear View of Console

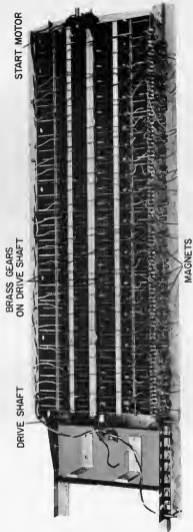

Figure 1-5. Tone Generator

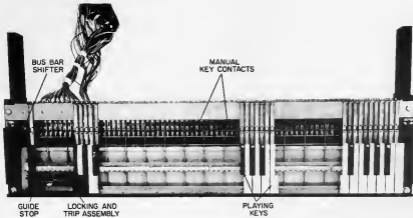

Figure 1-6. Manual Chassis Partially Disassembled

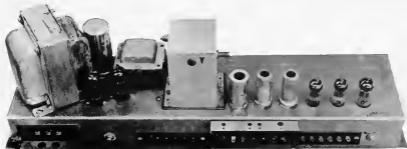

Figure 1-7. Preamplifier



resistors differing by as much as 30 percent from their rated values.

TABLE II - RESISTOR COLOR CODE

0-Black	4-Yellow	
1-Brown	5-Green	
2-Red	6-Blue	8-Gray
3-Orange	7-Violet	9-White

3-6. COIL MEASUREMENTS. For the DC (direct current) resistance value of chokes and audio transformers, refer to the appropriate circuit diagram. An open winding in the choke or transformer will be indicated by no ohmmeter indication. Check the power and filament transformers by comparing their measured voltage with the voltages given in the circuit diagram. All voltage values are given for a 117-volt (or 234-volt) AC input. If the input voltage varies, a corresponding change will be noted.

3-7. SECTIONALIZING TROUBLE

3-8. AMPLIFICATION SYSTEM TROUBLES.

3-9. Such troubles as loss of volume, poor quality, excessive hum, noisy operation, or no signal are usually traceable to the amplification system. For example, if distortion is noted in the loud speakers, connect a headset across terminals marked "G" "G" on the console preamplifier. (See figure 1-7.) If the quality is good on the headset, the cause of the distortion will be found in the amplification system following the console preamplifier. Should distortion occur at the preamplifier terminals, replace all tubes. Should distortion in the console preamplifier continue, test each preamplifier stage individually with the headset. When the defective stage is located, test each capacitor and resistor for deterioration.

CAUTION

Insert an 0.1 mfd, 400-volt DC capacitor in series with the headset to prevent DC voltage from damaging it.

3-10. HUM.

3-11. Hum in the loud speakers may indicate trouble in the reverberation spring system assembly. (Reference paragraph 3-28.) If a sustained hum or howl is heard, starting only when a low note is played at high volume, check for the following:

- Microphonic tubes in the amplifier. Replace all tubes if necessary.
- Improper grounding of all plug connections to and from the amplifier.

c. Defective bypass capacitors in the reverberation portion of the amplifier.

d. Locked spring system.

e. Improper mounting of the reverberation unit.

f. Presence of undesirable magnetic fields, such as motors, generators, supply transformers, and other equipment generating heavy magnetic field patterns.

3-12. LOCATING AND CORRECTING DEFECTIVE INDIVIDUAL TONES.

3-13. Silent or weak individual tones are usually caused by defects in the circuit ahead of the amplification system. Such defects can be traced to the tone generator and filter circuits, key circuits and board connections, and signal wiring between the manual chassis, generators, and pedal switch. Trouble occurring over the full range of tones and present at the input to the console preamplifier can usually be traced to a defect in the mixing transformer or associated circuitry.

3-14. LOCATING DEFECTIVE TONES.

3-15. Depress preset key A# on the upper manual. (See figure 1-1.)

3-16. Pull out the first (No. 1) brown drawbar only in the first set of drawbars in the left-hand group.

3-17. Start with the first key, C, (frequency No. 13) of the upper manual and strike each higher note on this manual in succession. The last note at the right end of the keyboard is C (frequency No. 61). Note the frequency numbers of all weak or dead notes. Table III indicates all key numbers and notes and the corresponding frequency numbers for each drawbar.

3-18. Return the first brown drawbar to its original position and then pull out the last white drawbar only, in the same drawbar set. (Reference paragraph 3-16.) Start at the second C note (frequency No. 61), and strike each higher note on the upper manual in succession until the second F# note from the top of the keyboard is reached. This F# note corresponds to frequency #91, the highest frequency produced by the generator. Note the frequency number of all weak or dead notes.

3-19. Repeat the procedures of paragraphs 3-15 to 3-18 inclusive, on the lower manual. Use the No. 1 brown and No. 9 white drawbars in the first set of drawbars in the right-hand drawbar group.

TABLE III - FREQUENCY NUMBERS ASSIGNED TO KEYS AND PEDALS

*Frequency number assigned to keyboard harmonics										
Key No.	Note	Drawbar 1 subfund.	Drawbar 2 Sub-3d	Drawbar 3 fund.	Drawbar 4 2d harm.	Drawbar 5 3d harm.	Drawbar 6 4th harm.	Drawbar 7 5th harm.	Drawbar 8 6th harm.	Drawbar 9 8th harm.
1	C	13	20	13	25	32	37	41	44	49
2	C#	14	21	14	26	33	38	42	45	50
3	D	15	22	15	27	34	39	43	46	51
4	D#	16	23	16	28	35	40	44	47	52
5	E	17	24	17	29	36	41	45	48	53
6	F	18	25	18	30	37	42	46	49	54
7	F#	19	26	19	31	38	43	47	50	55
8	G	20	27	20	32	39	44	48	51	56
9	G#	21	28	21	33	40	45	49	52	57
10	A	22	29	22	34	41	46	50	53	58
11	A#	23	30	23	35	42	47	51	54	59
12	B	24	31	24	36	43	48	52	55	60
13	C	13	32	25	37	44	49	53	56	61
14	C#	14	33	26	38	45	50	54	57	62
15	D	15	34	27	39	46	51	55	58	63
16	D#	16	35	28	40	47	52	56	59	64
17	E	17	36	29	41	48	53	57	60	65
18	F	18	37	30	42	49	54	58	61	66
19	F#	19	38	31	43	50	55	59	62	67
20	G	20	39	32	44	51	56	60	63	68
21	G#	21	40	33	45	52	57	61	64	69
22	A	22	41	34	46	53	58	62	65	70
23	A#	23	42	35	47	54	59	63	66	71
24	B	24	43	36	48	55	60	64	67	72
25	C	25	44	37	49	56	61	65	68	73
26	C#	26	45	38	50	57	62	66	69	74
27	D	27	46	39	51	58	63	67	70	75
28	D#	28	47	40	52	59	64	68	71	76
29	E	29	48	41	53	60	65	69	72	77
30	F	30	49	42	54	61	66	70	73	78
31	F#	31	50	43	55	62	67	71	74	79
32	G	32	51	44	56	63	68	72	75	80
33	G#	33	52	45	57	64	69	73	76	81
34	A	34	53	46	58	65	70	74	77	82
35	A#	35	54	47	59	66	71	75	78	83
36	B	36	55	48	60	67	72	76	79	84

TABLE III - FREQUENCY NUMBERS ASSIGNED TO KEYS AND PEDALS
(Continued)

*Frequency number assigned to Keyboard harmonics										
Key No.	Note	Drawbar 1 subfund.	Drawbar 2 sub-3d	Drawbar 3 fund.	Drawbar 4 2d harm.	Drawbar 5 3d harm.	Drawbar 6 4th harm.	Drawbar 7 5th harm.	Drawbar 8 6th harm.	Drawbar 9 8th harm.
37	C	37	56	49	61	68	73	77	80	85
38	C#	38	57	50	62	69	74	78	81	86
39	D	39	58	51	63	70	75	79	82	87
40	D#	40	59	52	64	71	76	80	83	88
41	E	41	60	53	65	72	77	81	84	89
42	F	42	61	54	66	73	78	82	85	90
43	F#	43	62	55	67	74	79	83	86	91
44	G	44	63	56	68	75	80	84	87	90
45	G#	45	64	57	69	76	81	85	88	91
46	A	46	65	58	70	77	82	86	89	92
47	A#	47	66	59	71	78	83	87	90	93
48	B	48	67	60	72	79	84	88	91	94
49	C	49	68	61	73	80	85	89	90	95
50	C#	50	69	62	74	81	86	90	91	96
51	D	51	70	63	75	82	87	91	92	97
52	D#	52	71	64	76	83	88	90	93	98
53	E	53	72	65	77	84	89	91	94	99
54	F	54	73	66	78	85	90	92	95	100
55	F#	55	74	67	79	86	91	93	96	101
56	G	56	75	68	80	87	90	94	97	100
57	G#	57	76	69	81	88	91	95	98	101
58	A	58	77	70	82	89	92	96	99	102
59	A#	59	78	71	83	90	93	97	100	103
60	B	60	79	72	84	91	94	98	101	104
61	C	61	80	73	85	90	95	99	100	105

TABLE III - FREQUENCY NUMBERS ASSIGNED TO KEYS AND PEDALS
(Continued)

Frequency numbers assigned to Pedal harmonics									
Pedal No.	Note	Fund.	3d harm.	2d harm.	4th harm.	6th harm.	8th harm.	10th harm.	12th harm.
1	C	1	13	13	25	32	37	41	44
2	C#	2	14	14	26	33	38	42	45
3	D	3	15	15	27	34	39	43	46
4	D#	4	16	16	28	35	40	44	47
5	E	5	17	17	29	36	41	45	48
6	F	6	18	18	30	37	42	46	49
7	F#	7	19	19	31	38	43	47	50
8	G	8	—	20	32	39	44	48	51
9	G#	9	—	21	33	40	45	49	52
10	A	10	—	22	34	41	46	50	53
11	A#	11	—	23	35	42	47	51	54
12	B	12	—	24	36	43	48	52	55
13	C	13	32	25	37	44	49	53	56
14	C#	14	33	26	38	45	50	54	57
15	D	15	34	27	39	46	51	55	58
16	D#	16	35	28	40	47	52	56	59
17	E	17	36	29	41	48	53	57	60
18	F	18	37	30	42	49	54	58	61
19	F#	19	38	31	43	50	55	59	62
20	G	20	39	32	44	51	56	60	63
21	G#	21	40	33	45	52	57	61	64
22	A	22	41	34	46	53	58	62	65
23	A#	23	42	35	47	54	59	63	66
24	B	24	43	36	48	55	60	64	67
25	C	25	44	37	49	56	61	65	68

*These frequency numbers are assigned arbitrarily for convenience and are not related to the actual frequencies.

3-20. If all notes are uniform in intensity or change evenly from note to note, the tone generators are operating normally. However, if notes are weak or absent, proceed as directed in paragraph 3-21.

3-21. CORRECTION.

3-22. A single dead or weak note which occurs on one manual but not on the other, may be caused by a fault in the key contacts. To correct this fault, adjust the bus bar shifters associated with the pedal switch and both manuals as directed in paragraphs 4-9 to 4-13 inclusive.

3-23. A single weak or dead note occurring at the same point on both manuals may be caused by a defective generator, a broken wire, or a poorly soldered joint on the terminal strip. Test

the generator for output by fastening a short length of wire to the 6th bus bar, from the bottom, on the preset panel, then touch the other end of the wire to each lug on the generator terminal strip. If all notes sound, the cable wire or soldered joint is at fault and must be repaired. If no generator output exists, either the filter circuit or the magnet pickup coil may be defective, or the tone wheel is not rotating.

3-24. Figure 3-4 illustrates the position of each filter reactor and capacitor on the generator cover. Fasten a short piece of wire to the 6th bus bar, from the bottom, on the preset panel, and test each terminal of the filter. (Reference paragraph 3-23.) If the filter is at fault, replace the defective component as described in paragraphs 5-86 and 5-87.

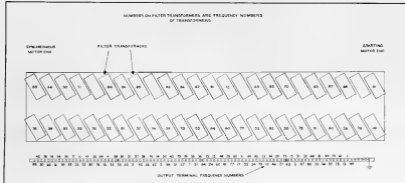

Figure 3-4. Location of Filters on Tone Generator

3-25. If there is no signal across the magnet pickup coil terminals, even with the coil disconnected, either the coil is defective or the associated tone wheel is not turning. Check the pickup coil by unsoldering its lead and, with a short piece of wire, connect the lead to the preset panel. (Reference paragraph 5-6.)

3-26. When there are two dead notes on each manual, determine which frequencies are at fault, as described in paragraphs 3-14 to 3-20 inclusive. Figure 3-5 illustrates the exact location of the magnet associated with each frequency; the dotted lines connecting the frequency num-

bers indicate that they are generated by two tone wheels on the same shaft and in the same compartment. (It should be noted that, with few exceptions, tone wheels on the same shaft differ in frequency numbers by 48.) On frequency numbers 37, 38, 39, 40, and 41, only a single active tone wheel is on each shaft. If the 2 magnets associated with the dead notes are together, 1 tone wheel is probably jammed against the magnet tip. To correct this condition, proceed as follows:

- a. Loosen the set screw on the magnet to be adjusted, then move the magnet back slightly.

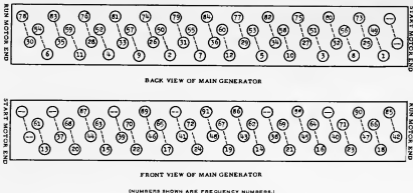

Figure 3-5. Generator Magnet Locations

Do not twist it.

b. Strike the proper playing key. The note should now sound.

c. To make the final adjustment, strike and hold down the playing key for the note being adjusted. Then tighten the magnet slightly in position and tap it gently until it moves close to the tone wheel to bring the intensity up to the intensity of the adjacent notes. Tighten the set screw so that the magnet is held firmly in position.

d. Do not remove main tone generator assembly from the console unless absolutely necessary. Should this be necessary, proceed as directed in paragraphs 5-63 to 5-71 inclusive.

3-27. TROUBLESHOOTING CHART.

3-28. The following troubleshooting chart contains general information to aid in the location of trouble. When the trouble stage is sectionalized, refer to Section V for detailed aid in identifying the trouble with a particular part.

<u>SYMPTOM</u>	<u>PROBABLE CAUSE OR REMEDIAL ACTION</u>
1. No Signal	Check the source of supply; a 117-volt, 60-cycle (or 234-volt, 50-cycle), AC power source is required. Check the power and connecting cables for secure mounting, good contact, and broken pins. Check the power supply voltage in the tone cabinet. Check all vacuum tubes. Connect output meter across the console pre-amplifier output terminals. If no output is obtained, conduct a point-to-point voltage test on the defective unit. Check the signal input to the power amplifier and compare the reading with the console pre-amplifier output reading on the output meter. These should be identical. If no output reading is obtained, conduct a point-to-point voltage test on the defective unit. Check the power amplifier output. If no output reading is obtained, conduct a point-to-point voltage test.
2. Loss of Volume, All Notes	Low voltage, source of supply. Check the console preamplifier output voltages. Check the power amplifier output voltages. Check all vacuum tubes. (Reference paragraph 3-3.) Low voltage from power supply. Conduct a point-to-point voltage test and check for defective components.
3. Loss of Volume, Single Note	Dust or accumulation of dirt on contact; make adjustment. (Reference paragraphs 4-9 to 4-13 inclusive.) Poorly soldered connection or high resistance contact in console wiring. Trace the signal intensity throughout the circuit by means of high-impedance headset (circuit to ground). As an alternative method, attach one end of an insulated test lead (48 inches long) to 6th bus bar from bottom, on preset panel, and use other lead end to trace the signal intensity throughout the manual wiring.

4. Poor Quality Use low volume, and check the console pre-amplifier output with high impedance headset. Check all vacuum tubes. Make a point-to-point voltage test. (Reference paragraph 3-4.) Check individual components for defects, especially audio bypass capacitors and frequency filters. Be sure that the voice coils are not rubbing against pole pieces.
-
5. Excessive Hum Check all connecting plugs for loose connections. Check wiring connections in cable plugs. Check for defective filter capacitors in power amplifier. Check all vacuum tubes. Replace if necessary. Remove all inductive electric or electronic equipment in the vicinity of the console cabinet. Check all bypass capacitors, particularly on cathode-to-ground circuits. Check ground connection from generator to two halves of lowest preset panel bar.
-
6. Rattle or Intermittent Operations Loose connections between cable connectors. Loose cable connections in connector plugs. Damaged speaker cone. Voice coil rubbing on pole piece. Defective vacuum tube. Check lubrication. Check the individual felt pad used on each manual key or bass pedal to absorb the striking sound. Check for intermittent resistors or capacitors by lightly tapping suspected components. Check the suspension of the reverberation spring system assembly. Adjust the bus bar shifters. (Reference paragraphs 4-9 to 4-13 inclusive.)
-
7. Miscellaneous
- a. Howl, or unwanted sustaining of tone Check reverberation unit locking lever. (Reference paragraph 2-6.)
- b. Bass pedals release sluggishly Check and increase tension of leaf springs at end of bass pedals.
- c. Preset keys fail to release properly Replace leaf bracket and associated leaf spring; replace key if necessary. (Reference paragraphs 5-73 to 5-75 inclusive and see figure 1-6.)

Technical Bulletin



HAMMOND ORGAN COMPANY

REPAIR AND DISASSEMBLY OF VIBRATO SCANNERS

- (A) Although this technical bulletin is based on scanner repair, it is not the single source of vibrato problems. Check existing switches, vibrato pre-amp. (tubes, etc), phase shift line box, and cables both to and from the scanner.

(B)

SYMPTOM	CAUSE	REPAIR
(1) Dead	(1a) Vibrato Switch (b) Vibrato pre-amp. (Tubes, etc.) (c) Open Signal Wire to Line-box (d) Open From Scanner shielded cable.	(1a) Replace Switch (b) Replace tubes or other defective components. (c) Replace wires or repair & d) connections.
(2) Chumpy Vibrato	(2a) Shorted capacitors on line-box (b) Open coils on line box (c) Oil saturated bakelite insulators which pick up impurities and short out the stationary plates to the main assembly chassis of scanner. (d) Rotor plates rubbing against the stationary plates inside scanner.	(2a) Replace defective com- & b) ponents (c) Clean Stationary and rotor plates and replace insulators, isolating the stationary plates from the main chassis. (d) Check end play and height of rotor on gear and shaft assembly.
(3) Slow Vibrato	(3a) Semi-frozen bearing on gear and shaft assembly (b) Poor tension on drive springs of the gear and shaft assembly.	(3a) Check oiling threads and for proper oiling. (b) Replace gear and shaft assembly.
(4) No Vibrato	(4) Frozen bearing on gear and shaft assembly	(4) Replace gear and shaft assembly.
(5) Squeaking Sound.	(5a) Tension springs of the carbon brushes mis-positioned causing the brushes to make a squeaking sound against the rotor contact plate. (b) Dry bearings	(5a) Heat spring connection with soldering iron and spring will fall into its proper position. (b) Check for proper oiling.

PARTS LIST

A	Syn. Motor & Scanner	
B	Oil Cup Assembly	064-016844
C	Oil Felt	
D	Felt Retainer Spring	012-002996
E	Screws (3)	
F	Screws (2)	
G	Shielded lead and Cover Assembly	066-033247 and 066-033248
H	Brush Lug & Insulator Assembly	
I	End Brush Spring Assembly	066-016821
J	Brush Assembly	066-016958
K	Screws (2)	846-040314
L	Screw (1)	
M	Housing Cover Assembly	
N	Screw (4)	
O	Cable Clip	
P	Stationary Plate (16)	066-016829
Q	Rotor Assembly	066-016828
R	Screws (16)	816-080720
S	Insulators (16)	036-016747
T	Insulators (16)	045-021942
U	Front Plate Assembly	
V	Bristol Set Screw (2)	999-002032
W	Gear Housing Assembly	
X	Screws (4)	
Y	Gear & Shaft Assembly	018-033192 and 018-033193

- (1) DETACH MOTOR AND SCANNER ASSEMBLY (A) FROM THE GENERATOR ASSEMBLY BY REMOVING FOUR (4) NUTS FROM THE SYNCHRONOUS MOTOR WHICH ANCHORS THE MOTOR TO THE "L" BRACKETS OF THE GENERATOR ASSEMBLY.
- (2) REMOVE THE CABLE CONNECTIONS IN THE ORGAN SO MOTOR AND SCANNER ASSEMBLY IS FREE FROM ORGAN.
- (3) NOTE A.C., LINE BOX, AND OUTPUT CONNECTIONS FOR REASSEMBLY.
- (4) LOCATE OIL CUP (B) AND OIL FELT (C) INSIDE CUP. THE OIL FELT MUST BE REMOVED AND THE COTTON THREADS UNWRAPPED FROM THE FELT BEFORE SEPARATING THE SCANNER AND MOTOR. REMOVE FELT RETAINER SPRING (D) AND LIFT UP ON THE FELT TO REMOVE THE THREADS. (DO THIS VERY CAREFULLY TO AVOID BREAKING THE COTTON THREADS). AFTER REMOVING THE THREADS FROM THE OIL FELT TAKE A PICK OR A PAPER CLIP AND REMOVE THE THREE THREADS FROM THE ONE SIDE OF THE OIL CUP BY PULLING THEM THROUGH THE HOLE IN THE CUP. THE THREAD FROM THE OTHER SIDE OF THE CUP NEED NOT BE REMOVED.
- (5) LOCATE SCREWS (E) WHICH HOLD THE MOTOR AND SCANNER ASSEMBLY TOGETHER. REMOVE THE SCREWS AND PULL THE MOTOR AND SCANNER ASSEMBLY APART. NOTE: THERE IS A GEAR ON THE END OF THE MOTOR SHAFT AND MUST BE GUIDED THROUGH THE HOLE OF THE SCANNER HOUSING TO SEPARATE THE MOTOR AND SCANNER.
- (6) REMOVE TWO SCREWS (F) FROM THE REAR COVER (G) OF THE SCANNER. BEFORE REMOVING THE COVER NOTE THAT THERE IS A SHIELDED WIRE ATTACHED TO THE COVER. THIS WIRE IS CONNECTED INSIDE THE SCANNER AND THERE IS VERY LITTLE SLACK IN THE WIRE. REMOVE THE COVER AND TIP IT BACK CAREFULLY SO YOU CAN SEE INSIDE. LOCATE THE CARBON BRUSH AUDIO PICK-UP ASSEMBLY (J), THE CARBON BRUSHES MUST BE REMOVED BEFORE THE MAIN HOUSING ASSEMBLY COVER (H) IS REMOVED IN ORDER TO PREVENT DAMAGE TO THE CARBON BRUSHES AND TENSION SPRINGS. LIFT END BRUSH (I) AND SLIP THE TWO CARBON BRUSHES (H) OFF THE ROTOR CONTACT PIN. (BE EXTREMELY CAREFUL OF THE ROTOR CONTACT PIN DURING DISASSEMBLY SO YOU DO NOT BEND OR BREAK THE PIN).

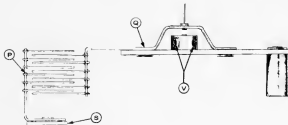
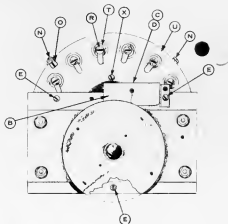
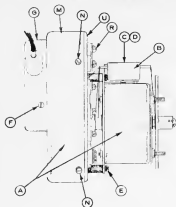

SHOULD IT BE NECESSARY TO REMOVE THE CARBON BRUSH AUDIO PICK-UP ASSEMBLY (J), DESOLDER THE AUDIO WIRE FROM THE BRUSH ASSEMBLY AND REMOVE THE TWO (2) SCREWS (K). TO REMOVE THE END BRUSH (I) REMOVE SCREW (L) AND SEPARATE FROM THE BRUSH ASSEMBLY.

- (7) REMOVE THE FOUR (4) SCREWS (N) AND SLIP THE HOUSING COVER (M) OFF THE MAIN ASSEMBLY.
NOTE: MARK THE HOUSING COVER (M) AND THE MAIN ASSEMBLY CHASSIS (U) TO INDICATE THE STARTING POINT OF THE SCANNER CABLE, ALSO MARK THE LOCATION OF THE CABLE CLIP (O).
- (8) STATIONARY PLATES (P) AND ROTOR (Q) ARE MOUNTED ON THE MAIN ASSEMBLY CHASSIS (U). REMOVE TWO (2) OF THE STATIONARY PLATES (P), BY REMOVING SCREWS (R). WHEN REMOVING THE STATIONARY PLATES FROM THE ASSEMBLY YOU WILL NOTICE THAT THERE ARE INSULATOR (S) AND (T) ON BOTH SIDES OF THE MAIN ASSEMBLY CHASSIS, INSULATING THE STATIONARY PLATES FROM THE ASSEMBLY (U). THEN REMOVE THE ROTOR ASSEMBLY (Q) BY LOOSENING THE TWO (2) BRISTOL TYPE SET SCREWS (V), TO AVOID DAMAGING THE ROTOR CONTACT PIN DURING DISASSEMBLY.
- (9) REMOVE THE REMAINING (14) STATIONARY PLATES AND INSULATORS.
- (10) CLEAN THE STATIONARY PLATES, ROTOR PLATES AND OTHER METAL PARTS USING A FREON SPRAY OR OTHER CLEANING SOLVENTS THAT DO NOT LEAVE ANY RESIDUE AFTER DRYING. AN ABSORBENT CLOTH OR SWAB CAN BE USED IN CONJUNCTION WITH THE CLEANER.
- (11) SPRAY METAL COATED PARTS WITH KYLON CORONA DOPE (CLEAR). CAUTION: DO NOT ALLOW SPRAY TO GET ON OIL THREADS OR ROTOR PICK-UP PIN.
- (12) IN MOST SCANNER REPAIR YOU NEED NOT GO FURTHER IN DISASSEMBLY THAN STEP NUMBER ELEVEN (11) BUT SHOULD CONDITIONS WARRANT FURTHER DISASSEMBLY CONTINUE WITH NUMBER (13), OTHERWISE INSTALL NEW INSULATORS AND REASSEMBLE THE SCANNER.
- (13) IN REMOVING THE GEAR HOUSING ASSEMBLY (W) THERE ARE FOUR (4) SCREWS (X) HOLDING THE ASSEMBLY ON TO THE MAIN ASSEMBLY CHASSIS (U). UPON REMOVING THE GEAR HOUSING ASSEMBLY YOU WILL NOTICE THE BAKELITE GEAR AND SHAFT ASSEMBLY (Y). THE SPRINGS ON EITHER SIDE OF THE BAKELITE GEAR ALSO INTERMESHES WITH THE METAL GEAR OF THE SYNCHRONOUS MOTOR TO DRIVE THE SCANNER.
- (14) TO REASSEMBLE THE SCANNER REVERSE THIS PROCEDURE.

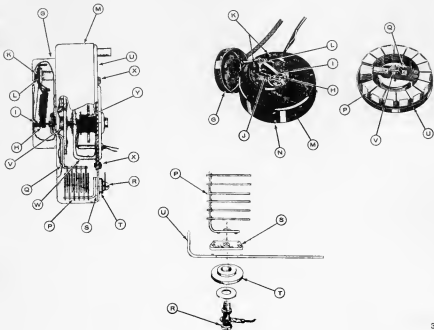



NOTE: THE FOLLOWING INFORMATION PERTAIN SPECIFICALLY TO THE MODELS B-3 & C-3 HOWEVER, DUE TO THE SIMILARITY OF THE CONSOLE MODELS IN THIS MANUAL, MUCH OF THE INFORMATION WILL APPLY TO THEM ASLO.

ALIGNMENT PROCEDURES

4-1. PRESET PANEL TONE SELECTION.

4-2. The preset keys shown in figure 1-2 are used to select the ready-mixed tone colors. Nine color-coded wires from each preset key are fastened to the bus bars of the preset panel by slotted screws. Each group of nine color-coded wires is fed through individual holes below the preset panel. The color coding of each group is identical to the color coding of the nine wires from the drawbars (above the preset panel). The drawbars can be withdrawn to numbered stops. The frequency relationship of the wire color coding is indicated below. Note that the color sequence is the same as the EIA color code for resistors.

Brown	Sub-fundamental
Red	Sub-3rd harmonic
Orange	Fundamental
Yellow	2nd harmonic
Green	3rd harmonic
Blue	4th harmonic
Violet	5th harmonic
Gray	6th harmonic
White	8th harmonic

4-3. The tone color or quality of any note, played on either the upper or lower manual, is determined by the intensity of the harmonics in relation to the fundamental note as selected either by the preset key or drawbars. The numbers of the preset panel and drawbars indicate a progressive increase in intensity, starting from 0 (drawbar fully pushed in) to 8 inclusive. Any

tone color may be identified by a number containing 9 digits, each digit representative of the intensity of the fundamental tone or 1 harmonic as selected on the drawbars or preset panel.

4-4. The Hammond Organ has its preset panel arranged to make available to the organist tonalities similar to those ordinarily found in the small church or chapel pipe organ, as well as tones for religious services and congregational singing, without the use of the adjustable drawbars. Table IV illustrates the approved preset panel arrangement for chapel organs. Remove the rear panel of the console, examine, and check the preset panel to determine that the preset panel corresponds exactly to Table IV. Change the position of any lead by loosening the slotted screw which secures it in place, removing the lead, and then securing it in correct position by means of the slotted screw provided. Refer to figure 4-1.

4-5. ALIGNMENT OF COIL ASSEMBLIES.

4-6. Each magnet and coil for each tone wheel is mounted in the tone generator as a single assembly. (See figure 5-1.) To locate and determine which coil assemblies require alignment, proceed as follows:

- Remove the console rear panel.
- Connect an output voltmeter (1,000 ohm-per-volt scale) across the two terminals marked "G".

TABLE IV - HAMMOND ORGAN PRESET DATA

UPPER MANUAL				LOWER MANUAL			
Preset Keys	Equivalent Drawbar Setting	Tone Quality	Value	Preset Keys	Equivalent Drawbar Setting	Tone Quality	Value
C		Cancel		C		Cancel	
C#	00 5320 000	Stopped Flute	pp	C#	00 4545 440	Cello	mp
D	00 4432 000	Dulciana	ppp	D	00 4423 220	Flute & String	mp
D#	00 8740 000	French Horn	mf	D#	00 7373 430	Clarinet	mf
E	00 4544 222	Sabicalonal	pp	E	00 4544 220	Diapason, Gamba and Flute	mf
F	00 5403 000	Flute 8' & 4'	p	F	00 6644 322	Great, no reeds	f
F#	00 4675 300	Oboe Horn	mf	F#	00 5642 200	Open Diapason	f
G	00 5644 320	Swell Diapason	mf	G	00 6845 433	Full Great	ff
G#	00 6876 540	Trumpet	f	G#	00 8030 000	Tibia Clausa	f
A	32 7645 222	Full Swell	ff	A	42 7866 244	Full Great with 16'	fff
A#	Adjust harmonic drawbars for 1st Group, Upper Manual			A#	Adjust harmonic drawbars for 1st Group, Lower Manual		
B	Adjust harmonic drawbars for 2nd Group, Upper Manual			B	Adjust harmonic drawbars for 2nd Group, Lower Manual		

c. Set both the vibrato controls, and all percussion tablets, to their "OFF" positions.

d. Depress the swell pedal to the position of maximum volume.

e. Disconnect tone cabinet from console.

f. Connect one end of a test lead to the 5th preset panel bus bar, from the bottom.

g. Place the organ in operation.

h. Check the AC input voltage at the console preamplifier terminal board; the voltage should be 117 volts or 234 volts. Any variation of input supply voltage will give a corresponding increase or decrease of reading, as shown in Table V.

i. Check the output voltage of each coil assembly by touching the prod end of the test lead to each terminal in turn on the main generator terminal board. The frequency numbers are not indicated. For location of exact frequency, see figure 3-4.

j. Compare each voltage obtained with the appropriate voltage listed in Table V. Do not try to adjust to these voltages unless the values deviate more than 30 percent.

4-7. If it is ascertained that the coil assemblies require alignment, proceed as follows:

a. Disconnect the generator assembly only when absolutely necessary. Make adjustments from the rear whenever possible. Do not remove the cover as this necessitates unsoldering and resoldering 91 leads, in addition to realigning all coil assemblies.

b. Refer to figure 3-5 and determine which coil assemblies require alignment.

c. Loosen the set screw which holds the coil assembly in position.

d. Compare the intensity of the note associated with the aligned coil with the intensity of adjacent notes.

e. Tap the coil assembly gently until it moves close enough to the tone wheel to bring the intensity up to the intensity of the adjacent notes; pull coil assembly back, if necessary. Do not turn magnet during this operation.

f. Tighten the set screw.

CAUTION

These coil assemblies are locked into position at the factory and seldom require adjustment. Do not pull back with a twisting motion, as damage will result.

TABLE V
GENERATOR OUTPUT VOLTAGES

Freq. No.	Output (V)	Freq. No.	Output (V)	Freq. No.	Output (V)	Freq. No.	Output (V)
1	9.8	23	15	45	2.7	67	1.2
2	11	24	14	46	2	68	1.6
3	11.5	25	11.5	47	2.5	69	2
4	12	26	12	48	2	70	1.6
5	13	27	10	49	2.25	71	2
6	14	28	11	50	3	72	1.4
7	15	29	10	51	1.5	73	1.4
8	15	30	10	52	2	74	1.2
9	16	31	11	53	1.8	75	1
10	15	32	8.5	54	1.8	76	1.2
11	16	33	10	55	1.8	77	1
12	13	34	9	56	1.8	78	1.2
13	14.5	35	10	57	2	79	0.8
14	15	36	8	58	1	80	0.6
15	14	37	9.5	59	1.8	81	0.7
16	15	38	10	60	1.5	82	0.4
17	14	39	9	61	3	83	0.6
18	15	40	10	62	3	84	0.5
19	15	41	8	63	2	85	0.7
20	16	42	9	64	2.5	86	0.5
21	15	43	9	65	2.2	87	0.3
22	13	44	2.5	66	3	88	0.4
						89	0.2
						90	0.5
						91	0.25

4-8. ADJUSTMENT OF PERCUSSION CUT-OFF CONTROL. This control, located in the preamplifier (See figure 1-7) should be readjusted whenever control tube V7 is replaced. Set expression pedal wide open, both volume tablets to "Normal", percussion tablet "ON", and harmonic selector in either position. Play any key in upper half of upper manual, hold it down at least 5 seconds, and then adjust percussion cut-off control exactly to the point where the signal becomes inaudible.

4-9. ADJUSTMENT OF INTERMITTENT OR NON-OPERATING KEYS.

4-10. Scratchy, noisy, or silent keys may result from accumulations of dust which lodge in the contacts. To correct this condition, strike the key 15 to 20 times in a rapid staccato manner to dislodge the dust particles and to clear the contacts.

4-11. If this procedure does not dislodge the dust particles, adjust the bus bar shifters. (See figures 1-4, 3-2, 4-2, and 4-3.) Bus bar shifter "A", located behind the mixing transformer, adjusts the bus bars associated with the keys of the upper manual; bus bar shifter "B" adjusts the bus bars associated with the keys of the lower manual; bus bar shifter "C" adjusts the bus bars associated with the pedal keyboard.

4-12. Turn the proper bus bar shifter about two turns in either direction. This operation permits the key contacts to strike a new position on the bus bar and should free all contacts of accumulated dust particles.

4-13. If, in extremely stubborn cases, the procedure above does not dislodge the dust particles, use a board to depress one octave of notes (7 white and 5 black keys) and then adjust the bus bar shifters while holding the keys down.

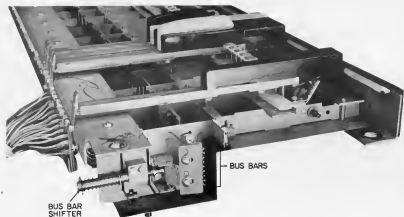

Figure 4-2. Manual Assembly, End View



Figure 4-3. Pedal Switch Assembly, Cover Removed

NOTE: THE FOLLOWING INFORMATION PERTAINS SPECIFICALLY TO THE MODELS B-3 & C-3 HOWEVER, DUE TO THE SIMILARITY OF THE CONSOLE MODELS IN THIS MANUAL, MUCH OF THE INFORMATION WILL APPLY TO THEM ALSO

STAGE DATA AND FINAL TESTING

5-1. DETAILED THEORY OF OPERATION.

5-2. MAIN TONE GENERATOR ASSEMBLY.

5-3. The main tone generator assembly consists principally of 48 rotating sub-assemblies (each subassembly consists of a shaft, 2 disks called tone wheels, and a bakelite gear), and a drive shaft which extends the entire length of the generator. This drive shaft is resiliently coupled at one end to a starting motor and at the other end to a synchronous run motor (reference paragraph 5-12), and is divided into several sections connected by semi-flexible couplings. (See figure 1-5.) A series of 24 driving gears, 2 each of 12 sizes, is mounted on this shaft.

5-4. Twenty-four of the 48 rotating subassemblies are mounted on each side of the drive shaft so that each of the driving gears engages 2 bakelite gears associated with opposite rotating sub-assemblies. These bakelite gears rotate freely with the tone wheels on separate shafts and are connected to their respective assemblies by a pair of compression-type springs. The bakelite

gears are provided in 12 different sizes corresponding to the 12 driving gears of different sizes. Consequently, 4 of the tone wheel subassemblies, each containing 2 tone wheels, operate at each of 12 different speeds. Each driving gear, with its associated bakelite gears and 4 tone wheels, is contained in a separate compartment, magnetically shielded from the rest by steel plates which divide the generator into a series of bins. (See figure 5-2.) All four tone wheels in any one compartment run at the same speed.

5-5. Each tone wheel is a steel disk about 2 inches in diameter and contains a predetermined number of high and low points on its outer edge. (See figure 5-1.) Each high point is called a tooth. There are 12 wheels with 2 teeth, 1 wheel to operate at each of the 12 speeds (reference paragraph 5-4); similarly 12 wheels each have 4 teeth, 8 teeth, 16 teeth, 32 teeth, 64 teeth, and 128 teeth; also 7 tone wheels have 192 teeth. A 2-tooth wheel and a 32-tooth wheel form an assembly, giving 2 frequencies, 4 octaves apart. The 4- and 64-tooth wheels

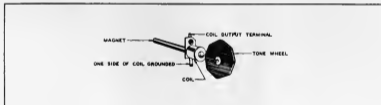

TONE GENERATOR

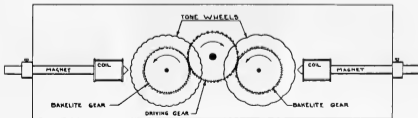

SECTION OF MAIN GENERATOR

Figure 5-1. Construction of Main Generator

are assembled together, as are the 8- and 128-tooth wheels and the 16- and 192-tooth wheels. Five 16-tooth wheels are mounted with blanks to maintain the balance of the rotating unit. (See figure 5-2.) Only 91 frequencies are required for the organ; for identification purposes these frequencies are numbered 1 to 91 inclusive.

5-6. A magnetized rod, about 4 inches long and 1/4 inch in diameter, is mounted near each tone wheel. (See figures 5-1 and 5-2.) A small coil of wire is wound near one end of the magnet. The tip of the magnet at the coil end is ground to a sharp edge and mounted near the edge of the associated tone wheel. Each time that a tooth of the wheel passes the rod, the magnetic circuit changes and a cycle of voltage is induced in the coil. The voltage is very small and is of known frequency. The frequency is predetermined by the number of teeth and the speed of the rotating tone wheel. Larger coils are used with tone wheels of lower frequencies to provide good low frequency output, but smaller coils are used with tone wheels of higher frequency to prevent excessive losses.

5-7. Copper rings are mounted on certain low frequency coils for the purpose of reducing harmonics. The eddy current loss in such a ring is small for the fundamental frequency of the coil, but is high for its harmonics. As a result, the relative intensities of any harmonics which may be produced by irregularities in the tone wheels are reduced.

5-8. The edge of each tone wheel and the tip of each magnet are coated with lacquer to prevent corrosion, for, should oxidation set in, the change in tooth shape would introduce undesirable frequencies.

5-9. Filters for eliminating spurious harmonics from the generated simple tones are located on the top of the main tone generator, and consist of filter capacitors and reactors. (See figure 3-4.) (These capacitors and reactors are tuned units and are called tone generator filters.)

5-10. The tone generator filters have a single tapped winding. This tap is grounded and one side, which is connected to the associated coil assembly through a capacitor, forms a resonant circuit for the fundamental frequency of that coil. Harmonics are suppressed. The capacitors for frequencies 49 to 54 inclusive are 0.255 mf, and the capacitors for frequencies 55 to 91 inclusive are 0.105 mf. Both capacitors and reactors are used with frequencies numbered 49 to 91 inclusive. On frequencies 44 to 48 inclusive, the capacitors are omitted, but the reactors

used have a greater number of turns. Below frequency 44, neither capacitors nor reactors are used; a length of resistance wire shunts each generator output. This resistance wire is wound on the appropriate magnet coil.

5-11. The tone generator filters are mounted on top of the generator at an angle to minimize reaction between them. Wires connect the filters to the coil assemblies and to the terminal strip on the generator. Ninety-six terminals are provided on this strip; 3 terminals are grounded to the generator frame and serve to ground the manuals and pedals, and 91 terminals carry the various frequencies.

5-12. The start motor is a shaded-pole induction motor. The synchronous run motor (used on 60 cycles) has a 2-pole field and 6-pole armature, and a synchronous speed of 1,200 rpm (revolutions per minute). For 50 cycles, a 4-pole armature is used which has a speed of 1,500 rpm. When the organ is placed into operation, the start switch is first operated to apply power to the start motor. The rotor of the start motor slides endwise and engages a pinion on its shaft which a gear on the generator drive shaft. (See figure 5-3.) When the "RUN" switch is operated, while the start switch is held in "ON" position, power is applied to the synchronous run motor and a 250-ohm resistor (1,000 ohm for 234 volts) is connected in series with the start motor, thus reducing the driving power of the start motor. Because of the braking action and the loss of power of the start motor, the system slows down to, and locks into, synchronous speed; the run motor then begins to carry the load. When the "START" switch is released and springs back into position, the start motor disengages from the drive shaft by action of a spring assembly, and stops.

5-13. The spring couplings of the motor shaft, the flexible couplings between the sections of the drive shaft, and the tone wheel spring couplings are provided to absorb the variations in motor speed. The synchronous motor operates with a series of pulsations, one each half-cycle. If the tone wheels were coupled rigidly to the motor, this irregularity would carry extra frequencies into each tone wheel. The spring suspension system for supporting the main tone generator minimizes the transmission of mechanical vibration between the console cabinet and the main generator.

5-14. VIBRATO EQUIPMENT.

5-15. The vibrato effect is created by a periodic raising and lowering of pitch, and thus is funda-

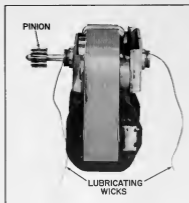

Figure 5-3. Starting Motor

mentally different from a tremolo or loudness variation. It is comparable to the effect produced when a violinist moves his finger back and forth on a string while playing, varying the frequency while maintaining constant volume.

5-16. The Hammond Organ vibrato equipment, as shown in simplified block diagram, figure 5-4, varies the frequency of all tones by continuously shifting their phase. It includes a phase shift network or electrical time delay line, composed of a number of low pass filter

sections, and a capacity type pickup or scanner, which is motor-driven so that it scans back and forth along the line.

5-17. Electrical waves fed into the line are shifted in phase by each line section (the amount per section being proportional to frequency), so that at any tap on the line, the phase is retarded relative to the previous tap.

5-18. The scanning pick-up traveling along the line will thus encounter waves increasingly re-

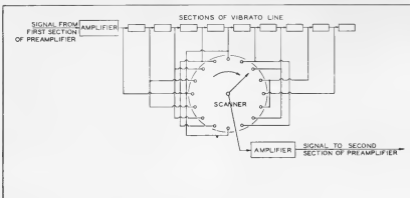

Figure 5-4. Fundamental Diagram of Vibrato System

tarded in phase at each successive tap, and the signal it picks up will continuously change in phase. The rate at which this phase shift occurs will depend on how many line sections are scanned each second.

5-19. Since a cycle is equivalent to 360 electrical degrees, a frequency shift of 1 cycle occurs for each 360 electrical degrees scanned per second. For example, if the scanner passes over the line at such a rate that 3,600 electrical degrees are scanned each second, there will be a frequency change of 10 cycles.

5-20. For the widest vibrato, the whole line is scanned from beginning to end in about 1/14 second, and this rate of change of phase causes about 1-1/2 percent decrease in frequency. Note that the frequency remains constantly 1-1/2 percent low as long as the moving pick-up retards the phase at a constant rate.

5-21. Since the pick-up sweeps from start to end of the line and then back, it increases the frequency by an equal percentage on its return trip, the average output frequency remaining equal to the input frequency. The exact amount of frequency shift depends not only on the amount of phase shift in the line but also on the scanning rate. This rate, however, is constant because the scanner is driven by the synchronous running motor of the organ.

5-22. The degree of vibrato (or amount of frequency shift) may be varied by a switch (not shown in figure 5-4) which causes the whole line to be scanned for No. 3 (wide) vibrato, about half of it for No. 2, and about one-third for No. 1.

5-23. A vibrato chorus effect, similar to the effect of 2 or 3 slightly out-of-tune frequencies mixed together, is obtained when the vibrato output signal is mixed with a portion of signal without vibrato. For vibrato chorus, part of the incoming signal appears across the vibrato line and the rest across a resistor in series with the line. As the vibrato effect is applied to the part of the signal appearing across the line, but not

to the part appearing across the resistor, the combination produces a chorus effect. For normal vibrato, this resistor is short-circuited. In the Model C-3 console the vibrato effect can be applied to either manual separately or to both at once.

5-24. Figure 5-5 shows the vibrato line box. Each of the inductance coils is connected with one or more capacitors to form one filter section.

5-25. Figure 5-7 shows the construction of the vibrato switch.

5-26. The scanner, shown in figure 5-6, is mounted on the main generator synchronous motor and driven at 412 revolutions per minute. It is a multi-pole variable capacitor with 16 sets of stationary plates and a rotor whose plates mesh with the stationary ones. In figure 5-7, Index B, two sets of plates have been removed to show the rotor.

5-27. Signals coming from the line through the vibrato switch appear on the stationary plates and are picked up, one at a time, by the rotor. Connection to the rotor is made by carbon brushes, as shown in figure 5-6, Index A. Two brushes touch the sides of the contact pin and a third presses on the end, in order to eliminate the possibility of contact failure.

5-28. Figure 5-8 shows the vibrato circuit.

5-29. The vibrato switch has no "OFF" position, and 3 vibrato chorus positions (C1, C2, and C3) are included in it as well as the 3 vibrato positions (V1, V2, and V3). The vibrato effect is turned "ON" and "OFF" for each manual separately by means of "VIBRATO SWELL" and "VIBRATO GREAT" tablets on the manual assembly.

5-30. The preamplifier used with this circuit has two separate channels into which signals from the "VIBRATO GREAT" and "VIBRATO SWELL" tablets are fed. (Reference paragraph 5-37.) The "VIBRATO" signal goes through a preliminary amplifier, through the vibrato



Figure 5-5. Vibrato Line Box

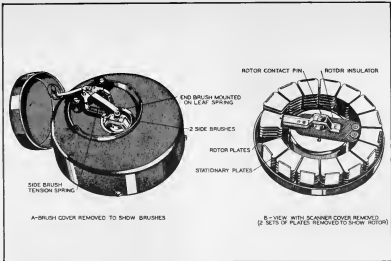

Figure 5-6. Vibrato Scanner

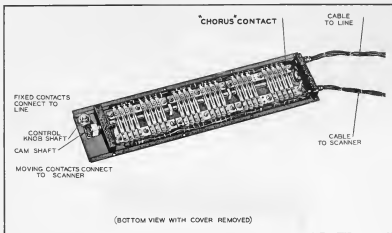

Figure 5-7. Vibrato Switch

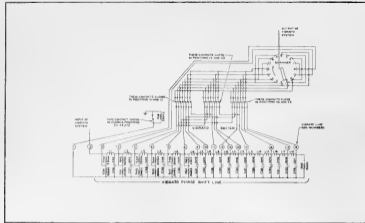

Figure 5-8. Schematic Diagram, Vibrato System

system, and then into additional stages of amplification. The "NO VIBRATO" signal also has a preliminary amplifier, but bypasses the vibrato system and goes directly into the additional amplifier stages.

5-31. MANUAL CHASSIS ASSEMBLY.

5-32. The 9 contact springs on each key are connected by resistance wires to the proper terminals on the terminal strip and carry the harmonics of the particular note with which they are associated. (Reference paragraph 1-20.) The resistance wires avoid overloading of the generators and thus allow each generator to be used independently to feed a number of key circuits. All key contacts are alive at all times. When a playing key is depressed, its 9 frequencies are impressed on the 9 bus bars of the manual. No wires are connected to these bus bars; a preset or adjust key must be depressed to complete the circuit. (See figure 3-3.) Each preset or adjust key is provided with 9 contacts identical to those on the playing keys and is further provided with a locking and tripping mechanism, the purpose of which is to permit only 1 preset or adjust key to be in operation at a time. (See figure 1-6.) The cancel key releases a depressed preset or adjust key; this cancel key has no contacts.

5-33. Flexible wires connect the 9 contacts of each adjust key (A# and B) to the 9 drawbars controlled by the key. The wires are color-coded

for identification. Each drawbar makes contact (according to the stop position to which it is drawn) with any one of 9 bus bars connected to taps on the mixing transformer. (See figure 3-3.) The bus bars correspond to different intensities of sound.

5-34. The 9 preset keys (C# to A) are connected by flexible leads to the preset panel in the back of the console. (See figure 1-4.) The preset panel consists of 2 sets of 9 bus bars which correspond to those in the drawbar assembly and which are connected to the same taps on the mixing transformers.

5-35. The mixing transformers are mounted on the manual chassis assembly as shown in figure 1-4. Shielded leads carry the signals from the secondaries of these transformers to the pre-amplifier.

5-36. PEDAL SWITCH ASSEMBLY. The pedal switch assembly is similar in operation to the manual chassis assembly (reference paragraphs 5-31 to 5-35 inclusive); the pedal switch assembly, however, contains only 4 bus bars instead of 9. A flat spring at the end of each pedal of the detachable pedal clavier depresses a small plunger, as shown in figure 3-2, on the pedal switch assembly and actuates a double set of contact springs, thus making eight contacts available for each note. The pedal contact springs are connected by decoupling resistance

wires to terminals. A cable connects these terminals through a wiring tube to the proper terminals on the main tone generator strip. The pedal switch bus bars are connected, by means of four colored wires, through a filter reactor and resistor network to the pedal drawbars. (See figure 5-9.) The reactor and resistors filter out undesirable higher harmonics and serve to balance the pedal tones.

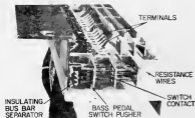

Figure 5-9. Pedal Switch Contacts

5-37. VOLUME CONTROL AND PRE-AMPLIFIER ASSEMBLY.

5-38. Typical Circuit Before Pre-amplifier.

5-39. Each voltage of predetermined frequency produced by the tone generator is connected to one or more key contacts. When the associated playing key is depressed, this voltage is impressed upon the bus bar and is carried through the preset key switch to the preset panel. The voltage is then fed to one of the several taps of the mixing transformer which is associated with the manual being played. From the high impedance secondary of the mixing transformer, this voltage (combined with others which may be fed through simultaneously) passes to one of the preamplifier input circuits. (Vibrato "ON" or "OFF" circuit).

5-40. Power to operate the preamplifier and power amplifier is supplied through the run switch circuit as shown in figure 3-3.

5-41. Preamplifier Circuit, Input.

5-42. The signal from each mixing transformer is sent to the Vibrato "ON-OFF" tablet associated with its particular manual, and is then carried to the "VIBRATO" or "NO VIBRATO" preamplifier input, depending on the position of the tablet.

5-43. The input circuits are similar, with one

extra stage of amplification in the "VIBRATO" channel to compensate for the loss that occurs through the phase shift network and associated scanner. The input tube V4 receives the signals from "VIBRATO" and "NO VIBRATO" circuits and further amplifies them. The signal then is impressed on the "LOUD" stator of the volume control, and on the "SOFT" stator through a compensating network.

5-44. Volume or Swell Control.

5-45. The volume control is activated by the swell pedal connected by an appropriate linkage. (See figure 1-4.) The volume control assembly consists of two sets of stator plates, similar to those used in the scanner assembly. (See figure 5-6.) A rotor assembly of similar size is moved by the swell pedal and is capable of meshing with either stator or a portion of each. The degree of mesh determines the strength of the entire signal.

5-46. The signal is further amplified by the second section of V4 and sent to driver tube V3 which in turn drives the 12BH7 output tube.

5-47. PERCUSSION SYSTEM. (See figure 3-3.)

5-48. The "Touch Response" percussion feature is controlled by four tilting tablets (figure 1-1). It is available only on the upper manual and only when the "B" adjust key is depressed. Percussion tones are produced by borrowing the second or third harmonic (depending on position of the "Percussion Harmonic Selector" tablet) from the corresponding drawbar of the upper manual "B" adjust key group, amplifying it, returning part of it to the same drawbar, and conducting the balance through push-pull control tubes which, when keyed, cause the signal to fade away at a pre-determined rate.

5-49. With the percussion tablet on, "B" adjust key pressed, and an upper manual playing key pressed, the second or third harmonic signal goes to percussion input terminal H on the preamplifier chassis and is amplified by T4 and T5. The percussion input transformer T5 not only provides push-pull signal for the control tube V7 but also has a third winding which feeds signal back to the 2nd or 3rd harmonic drawbar through equivalent key circuit resistor R50 and terminal "J".

5-50. When a key is depressed, the note first sounds loudly, after passing through the control tube V7, transformer T6, a high pass filter, and terminal D to the grid of V4. Immediately, capacitor C31 in the control tube grid circuit begins to discharge, causing the signal to fade away.

5-51. This circuit works as follows: Terminal K (Approximately -25 volts) is connected to the 8th harmonic "B" adjust key drawbar wire, which is connected through the adjust key contact to the manual bus bar. Pressing any upper manual key connects this bus bar to a tone generator terminal and virtually grounds terminal K through the tone generator filters. This virtually grounds the plate of V6, stops conduction, isolates the cathode of V6, and thus isolates the grid circuit of control tube V7. The grid then drifts from about -25 volts to about -15 volts, at a rate determined by the time required for C31 to discharge through R57 and R58. At the completion of this sequence, the percussion signal is blocked so that it is no longer audible.

5-52. No further percussion signal can be heard until all keys of the upper manual are released so that the control tube V7 grids can again drop to -25 volts (the rate of this drop is fixed by the time required to charge C31 to -15 volts through R55 and R56). Thus the percussion effect is heard only when keys are played in a detached manner; that is, when all keys are released before pressing the next one.

5-53. REVERBERATION UNIT. (See figure 1-10.) This device simulates musically desirable echoes in a large room. An electrical signal from the amplifier is applied to the driver coil in the reverberation unit, which converts the electrical signal into a twisting movement of 3 coil springs. This motion is transmitted along each spring to a pickup unit, where part of it is converted back to electrical energy. The remaining portion is reflected back to the driver and again back to the pickup after a time interval determined by the spring length. This reflection process continues until the signal level is reduced to about one millionth of its signal value so that it is no longer audible. The springs are different in length and thus there are 3 separate sets of echoes, each repeated a number of times. Electronic amplification circuitry associated with the reverberation unit is contained in the power amplifier, described below.

5-54. POWER AMPLIFIER. (See figure 5-10.)

5-55. This is a 3-channel amplifier with 2 treble channels (one for non-reverberated and one for reverberated signal) and a bass channel, with a cross-over point of 200 cycles. Each channel has two 6BQ5 output tubes with self-bias. Each treble channel drives a 12" speaker, and the bass channel drives two 15" speakers in parallel.

5-56. The power supply unit is a separate chassis housing the power transformer, rectifier tubes, filter, and input connections for power and signal. A 6-pin plug engages the console cable, and a 5-pin receptacle is provided for plugging in additional tone cabinets. The console cable consists of 5 conductors; 2 for AC power, 2 for push-pull signal, and ground.

5-57. The push-pull signal from the console (G1 and G2) drives treble input tube V1. Resistance-capacitance filters ahead of V1 filter out signal frequencies below 200 cycles. V1 drives output tubes V2 and V3 of the treble direct channel. It also drives double triode tube V9 which, in turn, drives the reverberation unit.

5-58. The output of the reverberation unit passes through transistor TR-1, and part of the signal goes to the treble reverberation switch. This adjusts the amount of reverberated signal going into V10, which drives output tubes V11 and V12 of the treble reverberation channel. The switch, in its "off" position, picks up signal from input terminal G1, in order to make use of the channel for non-reverberated signal when the treble reverberation is off.

5-59. Both treble channel output transformers have tertiary windings which supply inverse feedback signal to the cathodes of the output tubes.

5-60. A portion of the output of transistor TR-1 goes to double triode tube V4, which is connected as a phase splitter to drive the push-pull bass channel. The output of V4 goes to the bass reverberation switch, which is also connected to the input terminals G1 and G2. The bass channel receives a large amount of reverberated signal along with some direct signal in the "HI" position, only non-reverberated signal in the "OFF" position, and varying mixtures in the intermediate positions.

5-61. A filter network following the bass reverberation switch filters out signal frequencies above 200 cycles. Following it is a "room size" switch which can be used to provide better balance by reducing the bass volume when used in a small room. The signal then feeds push-pull tubes V5 and V6, which drive the bass output tubes V7 and V8.

5-62. REPLACEMENT OF COMPONENTS

5-63. TONE GENERATOR ASSEMBLY

5-64. Remove the four hexagonal-head bolts and their associated springs and T-washers which

secure the generator assembly to the console.

5-65. Remove the four screws from the left and right-hand side panels of the music rack. Tilt the bottom of the music rack by lifting the side panels, and remove the rack by pulling outward.

5-66. Remove the 4 chassis bolts (underneath the console) and the 2 machine screws (under the front lower manual rail) that hold the entire manual chassis in place.

5-67. Disconnect the 79 manual leads, 68 pedal leads, 4 ground wires, and the pedal filter leads. The pedal filter is located on the rear surface of the upper manual assembly.

5-68. Pull out all drawbars to position 8, and then tilt the manual chassis from the front as far as the top of the console will permit. Place suitable wedges or blocks on both sides of the manual chassis to hold it in this position. The manual chassis must be tilted to provide adequate clearance for the bolts in the corners of the main generator assembly.

5-69. Unhook the four suspension springs on which the generator assembly rides.

5-70. Lift up the generator assembly and remove it at the rear of the console.

5-71. Install a replacement generator assembly by reversing the procedure given above for removing it.

5-72. MIXING TRANSFORMER ASSEMBLY.

The Assembly of two mixing transformers is provided complete with all leads to the preset panels, and can be removed as follows:

- Remove the rear panel.
- Remove the two screws which secure the transformer cover in place.
- Label and disconnect all leads from the mixing transformers where they connect to the preset panels.
- Desolder green and yellow shielded wires at mixing transformers.
- Remove the two wood screws which secure the mixing transformer assembly to the manual chassis block.
- Secure the replacement mixing transformer assembly in place by reversing the procedures given above.

5-73. PLAYING KEY.

5-74. Replacement of playing key on upper manual will be accomplished as follows:

- Remove the four screws from the left and right-hand side panels of music rack. Tilt the bottom of the rack by lifting the side panels and then remove the rack by pulling outward.

- Remove the 2 wood screws and the 2 oval-head bolts from the ends of the drawbar base.

- Lift and block up the entire drawbar base.
- To remove a black key, loosen its key mounting screw, unhook key from screw, and lift out key.
- To remove a white key, loosen its key mounting screw and those of adjacent black keys. Unhook these keys from screws, push them back, and lift out white key.
- Insert a replacement key and install by reversing the directions given above for removal.
- Adjust the tension of the replacement playing key by comparison with the adjoining key.

5-75. Replacement of playing key on lower manual will be accomplished as follows:

- Remove the four screws from the left- and right-hand side panels of the music rack. Tilt the bottom of the rack by lifting the side panels and then remove the rack by pulling outward.
- Remove the two oval-head bolts from the ends of the stop base.
- Pull out all drawbars to position 8.
- Tilt the upper manual as far back as the top of the console will allow, and then wedge or block it in this position.
- Complete the replacement of the playing key on the lower manual by following the same procedure given above for upper manual keys.

5-76. PEDAL SWITCH ASSEMBLY.

5-77. Replacement of pedal switch assembly will be accomplished as follows:

- Remove the pedal cleaver by lifting it up in front and then pulling straight back. (See figures 1-3 and 3-1.)

CAUTION

Be careful to prevent damage to the delicately constructed pusher levers (switch pushers) at the end of each pedal.

- Unsolder the pedal cable wires from terminals on the generator.
- Disconnect the brown and black leads from the filter located on the rear surface of the upper manual assembly.
- Disconnect the orange, red, and yellow pedal signal leads from the resistor strip on the rear surface of the upper manual assembly.
- Use small wooden blocks to raise and support the entire console a few inches off the floor to provide the necessary clearance for the removal of the pedal switch assembly.
- Loosen and remove the screws which hold the wiring tube (through which the pedal wiring

cable passes to the tone generator) to the console shelf, the 3 oval-head and 1 hexagonal-head screws which hold the pedal switch in place, and the screw which holds the swell pedal rod in place.

g. Lift the cover board and remove the screws which hold the pedal switch assembly to the back rail of the console.

h. Loosen the large bolt at each end of the pedal switch assembly, then remove the nuts attached to these bolts. Drop the assembly carefully and remove it.

i. Install a replacement pedal switch assembly in place by reversing the procedures above.

5-78. MANUAL CHASSIS.

5-79. Replacement of manual chassis will be accomplished as follows:

a. Remove the rear panel of the console. (Reference paragraph 1-10.)

b. Remove the four screws on the left- and right-hand side panels of the music rack.

c. Lift the side panels to tilt the bottom of the rack, and then remove the rack by pulling outward.

d. Remove the 4 chassis bolts (under the console) and the 2 machine screws (under the front lower rail) that secure the entire manual chassis in place.

e. Disconnect all preamplifier leads.

f. Loosen set screw in expression control lever arm and detach arm from preamplifier.

g. Remove preamplifier from shelf after taking out mounting screws.

h. Unsolder (do not cut) the 79 manual leads, 2 ground leads, 3 pedal signal leads (red, orange, and yellow), and the pedal filter leads (brown and black).

i. At the power terminal panel, unsolder the five wires leading to the manual chassis start and run-motor switches. Determine these leads by tracing the leads from the switches.

j. Detach pilot lamp bracket by removing two wood screws.

k. Unsolder eight scanner wires from terminals on back of drawbar base.

l. Unsolder brown wire from vibrato line.

m. Tie the disconnected cables to the chassis to prevent damage to the other console components when the manual chassis is removed.

n. Remove the manual chassis through the rear of the console. Slide the chassis out carefully. Because of frame construction, the chassis will drop suddenly before it is entirely out of the console. Two men are required to remove the manual chassis from the console.

o. Install a replacement chassis by reversing

the procedure above. (See Figure 2-2 for cable connections).

5-80. SWITCHES FOR START AND RUN MOTORS.

5-81. The switches for the start and run motors are both mounted on the same metal plate; the following replacement instructions are equally applicable to each:

a. Remove the black bakelite switch handle by unscrewing it in a counter-clockwise direction.

b. Remove the round knurled nut which holds the switch to the metal plate.

c. Remove the four oval-head screws which hold the switch plate to the music rack.

d. Remove the rear panel of the console.

e. Unsolder the leads (from the defective switch) at the power terminal panel on the generator. (See figure 2-1.) One lead (black) is wired to the start switch. Four leads, 1 yellow, 1 black, 1 blue, and 1 brown, are wired to the run switch. (See figure 4-1.) Unscrew or unsolder jumper wire between switches.

f. Remove the tape which secures the wires together. Unbraid the wires connected to the defective switch up to the manual chassis so that the switch can be removed.

g. Pull out the switch. Note the position of the switch with respect to the color of the wires so that the replacement switch will be installed in the correct position.

h. Install the new switch in the proper position. Braid and tape the wires carefully so that they will not interfere with the operation of the generator run motor.

i. Solder the leads of the replacement switch to the power terminal panel.

j. Operate the switch to determine that it has been installed properly.

k. Replace the rear panel.

5-82. START MOTOR (See figure 5-3).

5-83. Replacement of the start motor will be accomplished as follows:

a. To make the start motor accessible, follow the procedure for removing the main tone generator. (Reference paragraph 5-63.)

b. Remove start motor capillary threads from oiling trough.

c. Disconnect the leads to the start motor at the power terminal panel on the generator.

d. Using a socket wrench, remove the two start motor mounting screws.

e. Secure a replacement start motor in position by reversing the procedures above.

5-84. RUN MOTOR AND VIBRATO SCANNER ASSEMBLY. (See figure 2-1.)

5-85. Replacement of run motor and vibrato scanner assembly will be accomplished as follows:

- a. Remove the rear panel.
- b. At the power terminal panel on the generator, unsolder the red and black wires which lead to the run motor that is to be replaced. (See figure 4-1.)
- c. Unsolder 7 scanner wires from terminals on back of stop base and 2 scanner wires from line box.
- d. Remove shielded lead attached to "SCAN" at preamplifier.
- e. The running motor is secured by four machine screws to the generator frame. Remove the nuts and lockwashers, and then disengage the flywheel coupling springs.

- f. Remove the entire motor and scanner assembly by means of a gentle pull.

- g. Secure a replacement motor and vibrato scanner assembly in place by reversing the procedures above.

5-86. TONE GENERATOR FILTERS.

5-87. Filters used for frequencies numbered 49 to 91 inclusive, as referenced in paragraphs 5-9 to 5-11 inclusive, are resonant reactor-capacitor units, and will be replaced as follows:

- a. Unsolder all leads.
- b. Remove the two screws holding the filter.
- c. Remove the component.
- d. Replace the component by reversing the procedures above.

1000

SECTION VI PARTS LIST

PARTS ORDERING INFORMATION

When ordering replacement parts from the Hammond Organ Company, the following guidelines should be observed:

- 1) Address all parts orders to:

HAMMOND ORGAN COMPANY
PARTS DEPARTMENT
4200 W. DIVERSEY
CHICAGO, IL. 60639

- 2) All orders should specify the model and serial numbers of the instrument that is being serviced. (Note: On late model instruments the model and serial numbers are printed on the tag attached to the underside of the organ keyboard.)
- 3) All orders should specify the Hammond part numbers of the desired parts.
- 4) All orders should provide a specific description of the desired parts. (For example: Power transformer, 15 volt zener diode, F through B key module, etc.)

THIS SECTION IS DIVIDED INTO THREE PARTS

- A. B-3/C-3/PR-40 Complete Parts List**
- B. Early Models Unique Parts List**
- C. Early Tone Cabinets Parts List**

NOTES:

- 1. Part A contains items common to all models, please refer to this list first.**
- 2. Assemblies not shown are no longer available.**
- 3. Items without part numbers are NLA.**
- 4. Parts listing does not insure availability.**

TABLE OF CONTENTS - A
B-3/C-3/PR-40 PARTS LIST

MAJOR ASSEMBLY	PAGE
1. CABINET PARTS (MODEL B-3)	6-5
2. TONE WHEEL GENERATOR	6-6
3. TONE BAR ASSEMBLY.	6-7
4. UPPER & LOWER KEYBOARD ASSEMBLY.	6-8
5. KEYBOARD BREAKDOWN	6-9
6. PEDAL KEYBOARD ASSEMBLY.	6-10
7. PEDAL SWITCH ASSEMBLY.	6-11
8. PREAMPLIFIER ASSEMBLY.	6-11
9. PRESET PANEL ASSEMBLY.	6-13
10. VIBRATO LINE BOX	6-13
11. START/RUN SWITCH CONTROL PANEL	6-14
12. EXPRESSION PEDAL ASSEMBLY.	6-15
13. PR 40 TONE CABINET	6-16
14. PR 40 POWER SUPPLY ASSEMBLY.	6-17
15. PR 40 POWER AMPLIFIER ASSEMBLY	6-19
16. REVERBERATION UNIT (NECKLACE TYPE)	6-20
17. CABINET PARTS (MODEL C-3).	6-21
18. C-3 PARTS CALLOUT (REAR VIEW).	6-22

(PARTS LIST FOR EARLY CONSOLES BEGINS ON PAGE 6-23)

(PARTS LIST ON EARLY HAMMOND TONE CABINETS BEGINS ON PAGE 6-31)

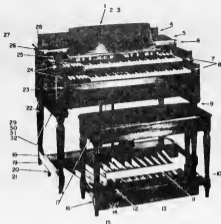

FIGURE 1
FRONT VIEW - B-3 (WALNUT)

1	MUSIC PANEL	1-0-138314	1-21	BENCH ASSEMBLY	112-009702
1-7	MUSIC PANEL KEYS	012-02048	1-14	PEDAL SWITCH COVER	210-02076
2	MUSIC PANEL HINGE SCREWS	801-02171	2-14	STRETCHER BAR	010-001409
3	FALLBOARD	010-00136	1-20	MOUNTING BLOCK	010-01100
1-5	REMOVABLE TOP PANEL	010-00191	1-21	MOUNTING BLOCK HARDWARE	
3-4	STATIONARY TOP PANEL	010-00130		Screw	801-000209
3-7	CHEEKPIECE BUSH WAD	015-02150		Nut	199-000428
3-8	ENGLOCK SCREWS	817-02194		Lockwasher	919-000191
3-9	RIGHT HAND LEG	010-00182	1-21	LEFT HAND LEG	210-001561
3-20	PEDAL CLAYTON COVER	010-00181	1-21	STATIONARY FRONT BAIL	819-00152
1-11	MUSIC REST	010-00001	1-24	LEFT HAND ENGLOCK	825-02209
1-12	MUSIC REST BRACKETS (BROWN)	015-02192	1-25	MUSIC PANEL BASE	010-01414
1-12	MUSIC REST BRACKETS (BLACK)	015-02191	1-30	TOP PANEL HINGE (LONG)	010-01236
1-13	MUSIC REST BRACKET MOUNTING HARDWARE		1-24	TOP PANEL HINGE (SHORT)	010-01237
	Wood Screw	800-02115	1-21	TOP PANEL HINGE SCREWS	801-03013
	Nylon "	919-00009	1-20	FELT DOT FOR MUSIC PANEL	0-2-13915
	Screw	818-02118	1-19	WALNUT BOLT 1/2"	42-00000
	Lockwasher	919-00012	1-10	WALNUT BOLT 3/4"	42-00001
	Nut	919-00013	1-11	WASHER 1/4 USED	91-00013
1-14	CABINET REAR COVER	010-00174	1-12	LOCKWASHER 1/4 USED	91-00013
1-15	REAR COVER THUMBSCREW (BRASS)	919-00006			
1-15	REAR COVER THUMBSCREW (BRASS)	919-00001			
1-16	PEDAL REAR COVER BUMPERS (BLACK)	021-02027			
1-16	PEDAL REAR COVER BUMPERS (BROWN)	021-02027			

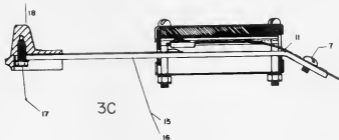
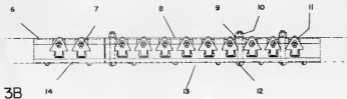

FIGURE 3

DRAWBAR ASSEMBLY COMPLETE

DRAWBAR ASSEMBLY COMPLETE	101-00000		
3-2 UPPER STOP SWITCH CHANNEL	043-011910	3-12 SCREW	838-07154
3-3 BUSBAR PANEL (22 USED)	917-020173	3-13 STOP PANEL FRONT (4)	043-02087
3-3 BUSBARS (UPPER DRAWBAR)	009-010006	3-14 STOP PANEL UPPER CENTER (3)	043-02188
3-4 BUSBARS (LOWER PEDAL)	028-010001	3-15 SLIDER WITH CONTACT	060-026403
3-5 BUSBAR INSULATORS (22 USED)	043-020176	3-16 SLIDER ONLY	028-026401
3-4 STOP PANEL (FROM CENTER (3))	043-011890	3-17 SCREW (DRAWBAR KNOB)	040-020534
3-1 SCREW	048-000224	3-18 DRAWBAR KNOB	
3-8 STOP PANEL REAR (4)	043-011888		SEE FIGURE 4 (FRONTAL VIEW)
3-9 WASHER	999-000120		
3-10 NUT	999-002213		
3-11 CONTACT	008-000176		

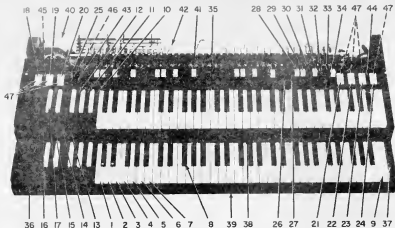

FIGURE 4

MANUAL ASSEMBLY COMPLETE

1	WHITE C KEY	1000000000	10	WIRE 2 2 1 1	311 076328
2	WHITE D KEY	1000000000	11	WIRE 2	311 076328
3	WHITE E KEY	1000000000	2 17	WIRE 1 1 1 1	311 076328
4	WHITE F KEY	1000000000	3 16	WIRE 1 1 1 1	311 076328
5	WHITE G KEY	1000000000	3 17	WIRE 1	311 076328
6	WHITE A KEY	1000000000	7 1	WIRE 37 BROWN	311 076328
7	WHITE B KEY	1000000000	3 16	LEFT HAND ENERGY	3000000000
8	BLACK SHARP A#	1000000000	3 17	RIGHT HAND ENERGY	3000000000
9	BLACK C# KEY	1000000000	3 18	FRONT STOP (RIGHT HAND)	3000000000
10	BLACK D# PRESET KEY	1000000000	3 19	FRONT STOP (LEFT HAND)	3000000000
11	BLACK E# PRESET KEY	1000000000	4 10	MANUAL WATCHING TRANSFORMER	3000000000
12	BLACK F# PRESET KEY	1000000000	4 11	SWAGE ASSEMBLY COMPLETE	3000000000
13	BLACK G# PRESET KEY	1000000000	4 12	STOP SLIDER ASSEMBLY	3000000000
14	BLACK A# PRESET KEY	1000000000	4 13	VIBRATO CHORD SWITCH PLATE	3000000000
15	BLACK B# PRESET KEY	1000000000	4 14	PERCUSSION CONTROL SWITCH ASSEMBLY	3000000000
16	WHITE SHARP PRESET KEY	1000000000	4 15	MANUAL CONTROL SWITCH ASSEMBLY	3000000000
17	SWITCH TAB MELODY	1000000000	4 16	VIBRATO SWITCH ASSEMBLY	3000000000
18	SWITCH TAB VIBRATO SHELL	1000000000	4 17	TODDLE SWING (1) LUCKY SWITCH	3000000000
19	SWITCH TAB VIBRATO BREAK	1000000000	4 18	BLANK CHORDBAR AND (BLACK)	3000000000
20	SWITCH TAB PERCUSSION ON OFF	1000000000	4 19	BLANK CHORDBAR AND (BROWN)	3000000000
21	SWITCH TAB PERCUSSION VELOCE	1000000000			
22	SWITCH TAB PERCUSSION DECAY	1000000000			
23	SWITCH TAB PERCUSSION HARMONIC	1000000000			
24	WIRE VIBRATO CHORDS	1000000000			
25	WIRE 18 BROWN	1000000000			
26	WIRE 5 2 1 1	1000000000			
27	WIRE 8	1000000000			

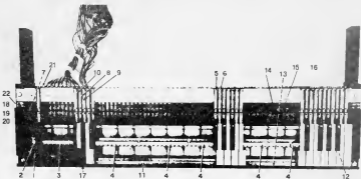

FIGURE 5

MANUAL ASSEMBLY BREAKDOWN

1	CIRCLE SPRING AND BRACKET ASSY	045-02109	14	KEY CHANNEL FELT	045-02109
2	KEY CORE ASSEMBLY (PRESSED)	017-02123A	15	SPOTEP FELT	045-02109
3	KEY CORE ASSEMBLY (PRESSED)	037-021217	16	MANUAL CONTACTS	045-02109
4	KEY CORE ASSEMBLY (MANUAL KEY)	017-02123A	17	MANUAL ACTUATOR	045-02109
5	BRACKET AND CHANNEL ASSY (STAMP)	017-02083	18	BUSHING RETAINER	045-02109
5-1	BRACKET AND CHANNEL ASSY (NATURALLY)	051-01761	19	RECURRING SWITCH GUIDER B PRESSED	045-02109
5-2	BRACKET AND CHANNEL ASSY (CANCEL)	071-02083	20	MANUAL BUSHING (RECTANGULAR)	045-02109
5-3	BRACKET AND CHANNEL ASSY (SHARP PRESSED)	071-02083A	21	MANUAL BUSHING (SQUARE) 1/4X-3/16"	045-02109
5-4	BRACKET AND CHANNEL ASSY (13 PRESSED)	013-02083	22	MANUAL BUSHING (SQUARE) 1/4X-13/16"	045-02109
5-5	BRACKET AND CHANNEL ASSY (PRESSED)	017-01183		WIRE PANEL	045-02109
6	DIAMETER FELT	042-001701		NEEDLE	045-02109
				NUMM LIST	045-02109

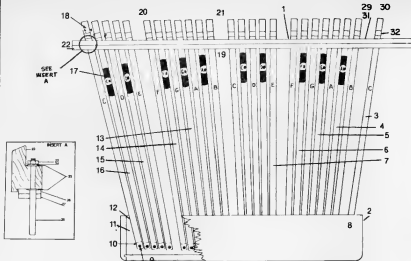

FIGURE 6

PEDAL KEYBOARD ASSEMBLY

A-305, B-3, F-100, E-300, E-300, H-100	113-00000		
4-1 SPECIAL LOCATOR NUT	999-00111	4-23 BLACK PEDAL CAP MOUNTING SCREW	422-10071A
4-1 MOUNTING SCREW	814-10371A	4-18 SWITCH PUSHER SPRING	042-001400
4-2 SLIDE	033-01490	4-18 SWITCH PUSHER SPRING SCREW	879-01121A
4-3 PEDAL KEY (C1, D1, E1, F1, G1, A1, B1, C2, D2, E2, F2, G2, A2, B2, C3)	040-0150A	4-18 STRETCHER BAR	070-009101
4-4 PEDAL KEY (A1, A2)	040-0150E	4-20 STOP SPACER	020-001142
4-1 PEDAL KEY (B1, D1)	040-0150F	4-21 RUBER BUSHING	003-004126
4-3 PEDAL KEY (C2, D2, F2, D1)	040-0150G	4-22 STOP ROLL	020-005400
4-1 PEDAL KEY (B1, D1)	040-0150H	4-23 NUT	991-00123
4-4 COVER	070-00001	4-24 LOCKWASHER	999-000732
4-4 COVER MOUNTING SCREW	043-00001A	4-25 WASHER	999-000003
4-4 COVER MOUNTING SCREW WASHER	999-000013	4-26 PEDAL FELLY (5 HOLE)	042-000104
4-9 FINE SPRING MOUNTING SCREW	043-00120A	4-27 PEDAL FELLY (7 HOLE)	042-000104
4-10 FINE SPRING	013-010040	4-27 PEDAL FELLY (2 HOLE)	042-000104
4-11 KEYBOARD BASE	070-000100	4-28 PEDAL SLIDE FOR OLD STYLE	027-001793
4-12 SHIRT PIVOT	040-011792	4-28 PEDAL SLIDE FOR NEW ROLL FEM	020-020410
4-12 MEDIUM PIVOT	040-011791	4-29 PEDAL SLIDE BUSHING	017-004120
4-12 LONG PIVOT	040-011793	4-30 WIRE SCREW	991-00151A
4-13 PEDAL KEY (C1, D1)	040-0150B	4-30 FELLY PIVOT	040-001310
4-14 PEDAL KEY (F1, D1)	040-0150C	4-31 SIDE SLIDE FELLY	042-001120
4-15 PEDAL KEY (D1, D1)	040-0150D	4-32 PEDAL DOWN STOP FELLY	043-001120
4-16 PEDAL KEY (C2, D1)	040-0150E		
4-17 BLACK PEDAL CAPS	023-001400		



FIGURE 7

PEDAL SWITCH ASSEMBLY

- 1 PEDAL SWING SWITCH
- 2 PEDAL PUSHER PLATE (25 GA.)
- 3 PEDAL PUSHER FELT (UNGLUED)

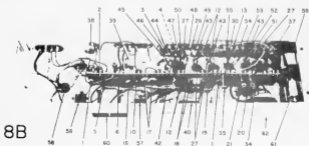
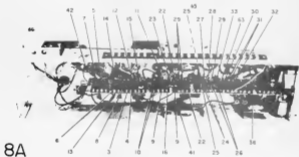

8C

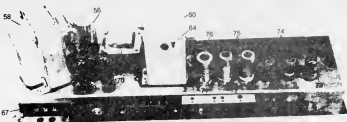

PREAMPLIFIER ASSEMBLY

7-7	CERAMIC CAP 4.7K H1 500V	400-01011	10-20	CERAMIC CAP 100 H1 500V	400-01011
7-8	RESISTOR 2.1K	400-01011	10-21	CERAMIC CAP 3.3K H1 500V	400-01011
8-1	RESISTOR 100K	400-01011	10-22	CERAMIC CAP 3.3K H1 500V	400-01011
8-2	RESISTOR 10K	400-01011	10-23	RESISTOR 2.2K	400-01011
8-3	RESISTOR 20K 1W	400-01011	10-24	CERAMIC CAP 100 H1 500V	400-01011
8-4	RESISTOR 2.7K 1W	400-01011	10-25	CERAMIC CAP 30 H1 500V	400-01011
8-5	RESISTOR 400 OHM	400-01011	10-26	CERAMIC CAP 50 H1 500V	400-01011
8-6	RESISTOR 100 OHM	400-01011	10-27	RESISTOR 2.2K	400-01011
8-7	RESISTOR 47K	400-01011	10-28	RESISTOR 20K	400-01011
8-10	RESISTOR 330K	400-01011	10-29	RESISTOR 22 OHMS	400-01011
8-11	RESISTOR 15 K	400-01011	10-30	RESISTOR 37K	400-01011
8-12	RESISTOR 270K	400-01011	10-31	RESISTOR 2.2K 1W	400-01011
8-13	RESISTOR 4.7K	400-01011	10-32	ELECT. CAP 1000V 40-100V 00100	400-01011
8-14	RESISTOR WIREWOUND 900 OHMS 30W	400-01011	10-33	ELECT. CAP 1000V 50-100V 00100	400-01011
8-15	CERAMIC CAP 10 H1 500V	400-01011	10-34	ELECT. CAP 1000V 50-100V 00100	400-01011
8-16	CERAMIC CAP 1K H1 500V	400-01011	10-35	POWER TRANSFORMER (T 1) 120V/250V	400-01011
8-17	CERAMIC CAP 20K H1 500V	400-01011	10-36	POWER TRANSFORMER (T 2) 120V/250V	400-01011
8-18	CAPACITOR 0.15 MF 400V	400-01011	10-37	PERMISSION OUTPUT TRANSFORMER (T 3)	400-01011
8-19	CERAMIC CAP 0.15 MF 500V	400-01011	10-38	OUTPUT TRANSFORMER (T 4)	400-01011
8-20	RESISTOR WIREWOUND 4.5K 10W	400-01011	10-39	PERMISSION INPUT TRANSFORMER (T 5)	400-01011
8-21	RESISTOR WIREWOUND 7.5K 10W	400-01011	10-40	CERAMIC CAP 2K H1 500V	400-01011
8-22	CERAMIC CAP 200 H1 500V	400-01011	10-41	SMALL CAPACITOR ASSEMBLY	400-01011
8-23	CERAMIC CAP 2.2K H1 500V	400-01011	10-42	COVER GROUND	400-01011
8-24	RESISTOR 470K	400-01011	10-43	COVER LENS	400-01011
8-25	RESISTOR 2.2 K	400-01011	10-44	AC TERMINAL PANEL	400-01011
8-26	RESISTOR 30 K 1W 1W	400-01011	10-45	TERMINAL PANEL (LARGE)	400-01011
8-27	RESISTOR 100K	400-01011	10-46	TERMINAL PANEL (SMALL)	400-01011
8-28	CERAMIC CAP 70 H1 500V	400-01011	10-47	6 x 4 TUBE	400-01011
8-29	RESISTOR 3.3K 1W	400-01011	10-48	TUBE SOCKET	400-01011
8-30	RESISTOR 4.7 K	400-01011	10-49	120V TUBE	400-01011
8-31	RESISTOR 2.7K 1W	400-01011	10-50	TUBE SOCKET	400-01011
8-32	RESISTOR 300 OHM	400-01011	10-51	120V TUBE	400-01011
8-33	RESISTOR 2.7 K	400-01011	10-52	TUBE SOCKET	400-01011
8-34	RESISTOR 470 K	400-01011	10-53	400A TUBE	400-01011
8-35	RESISTOR 50 K	400-01011	10-54	TUBE SOCKET	400-01011
8-36	CAPACITOR 0.047 MF 400 V	400-01011	10-55	120V TUBE	400-01011
8-37	VARIABLE PWT (PERMISSION OUTPUT) 30K	400-01011	10-56	TUBE SOCKET	400-01011
8-38	VARIABLE PWT (TONE) 300K	400-01011	10-57	40A TUBE	400-01011
8-39	CAPACITOR 1 MF 200V	400-01011	10-58	TUBE SOCKET	400-01011
8-40	ELECT. CAP 400V 25V	400-01011	10-59	TUBE SHIELD	400-01011
8-41	CAPACITOR 0.33 MF 200V	400-01011	10-60	TUBE SHIELD	400-01011
8-42	CERAMIC CAP 100 H1 500V	400-01011			
8-43	RESISTOR 2.2K	400-01011			

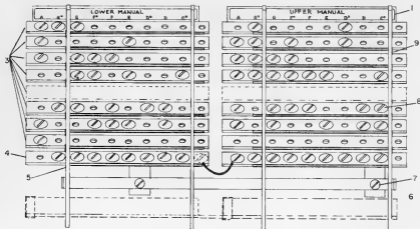
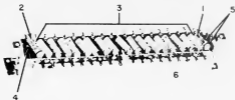

FIGURE 9

INLET PANEL ASSEMBLY

1	MARKER PLATE	038-03603			
2	MARKER PLATE	038-03603	1-4	LOWVOLT	013-03135
3	BUSBAR	009-03602	1-7	SCREW (4 USED)	016-07001A
4	BUSBAR	009-03603	1-8	SCREW (45 USED)	047-000001
5	BUSBAR INSULATOR & PFD ASSEMBLY	047-01134	1-9	LOWVOLT	013-03135



RESISTOR LINE ASSEMBLY

10-1	CAPACITOR 0.0025/100V	406-010212	10-1	RESISTOR 25K	400-42975
10-2	CAPACITOR 0.005/100V	406-010012	11-5	CR1 (EARLY MODEL) (18 USED)	003-014724-001
10-3	CAPACITOR 0.0021/100V	406-010222	11-6	CR1 (LATER MODEL) (18 USED)	003-03303
10-4	RESISTOR 25K	400-02041			

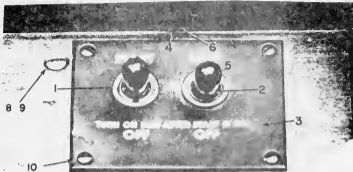

1. START TOGGLE SWITCH

2. RUN TOGGLE SWITCH

3. SWITCH PLATE

4. LIPHOLDER ASSEMBLY

5. BAT HANDLE (FOR START & RUN SWITCH)

6. WASER

7. WASER

8. WASER

9. WASER

10. WASER

11. WASER

12. WASER

13. WASER

14. WASER

15. WASER

16. WASER

17. WASER

18. WASER



12A

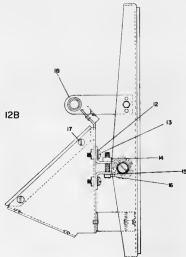
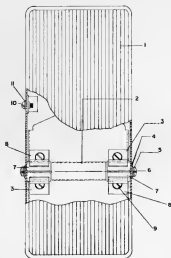

FIGURE 12

COMPRESSION PEDAL ASSEMBLY

12 - 1	RUBBER MAT	(BRN)	045-031436
12 - 2	PEDAL SHAFT	(BLACK)	043-031417
12 - 3	BEARING BRACKET		030-021775
12 - 4	WASHER		999-000095
12 - 5	LOCKWASHER		999-000710
	OLD STYLE LEARMASHER		999-031711
12 - 6	SCREW		999-000512
12 - 7	PEDAL BEARING (RETURN)		011-030431
12 - 8	RETURN BRACKET		015-030408
12 - 9	SCREW		015-030201
12 - 10	SCREW		016-000411
12 - 11	WASHER		999-000129
12 - 12	WASHER		999-000121
12 - 13	SCREW		999-000102
12 - 14	DELTA NUT		999-000343
12 - 15	LOCKWASHER		999-000729
12 - 16	SCREW		043-081113
12 - 17	SCREW		035-090216

12-18	PEDAL ARM		040-021721
	HARDWARE (BP ASSY. FOR CONNECTING ROD)		
12-19	CONNECTING ROD		040-021732
12-20	EXTENSION SPRING		013-011345
12-21	BRACKET		034-021399
12-22	SCREW		050-100114
12-23	SCREW		018-000118
12-24	NUT		999-001121
12-25	LOCKWASHER		999-000126
12-26	WASHER		999-000125
12-27	SPACER		011-020127
	HARDWARE FOR LOWER MOUNTING OF CONNECTING ROD		
12-28	SCREW		016-000413
12-29	LOCKWASHER		999-000728
12-30	THREADED WASHER		999-000149
12-31	SPRINGWASHER		999-000130

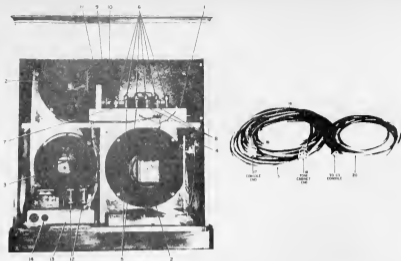

FIGURE 13

PR-40 TONE CABINET

1	AMPLIFIER ASSEMBLY	17	CONNECTOR END	19	ELECT. CONNECTOR (40-400, 40-100, 40-200)	430-04300
2	SPEAKER 1"	18	TONE CABINET END	18	WAVE TUBE	062-001301
3	SPEAKER 12"	19	POWER SUPPLY ASSY (120V/50HZ)	19	POWER SUPPLY ASSY (120V/50HZ)	117-000015
4	REGENERATION ASSEMBLY	20	RECEPTACLE CONNECTOR	19	POWER SUPPLY ASSY (250V/50HZ)	117-000017
5	RAIL TUBE	21	AC TO COMBIBLE CABLE	19	RECEPTACLE CONNECTOR	065-011141
6	4000T TUBE			19	CONSOLE TO TONE CABINET CABLE (COMPLETE)	011-076435
7	50A7N TUBE			19	WAVE CABLE ONLY (SPECIFY LENGTH)	700-000022
8	50B7N TUBE			19	CONNECTOR ONLY (CONSOLE END)	005-006015
9	50B7N TUBE			19	CONNECTOR ONLY (TONE CABINET END)	005-011541
10	TRANSFORMER			19	CONNECTOR CAPS (4 BAYONET)	018-03590
				19	AC TO COMBIBLE CABLE	011-031710

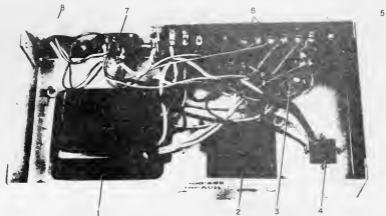

FIGURE 14

POWER SUPPLY ASSEMBLY

177-00011

1 POWER TRANSFORMER (225 VOLT/50HZ)

003-01417

2 POWER TRANSFORMER (220 VOLT/50HZ)

003-01417

3 FILTER DISK

003-03604

4 RESISTOR- WIRE WOUND 44- 30W

324-01017

5 ELECT. CAPACITOR 50V450

430-01007

6 TERMINAL PANEL COVER

341-01854

7 10K SUB

470-00120

8 FEMALE CONNECTOR

363-01170

9 8 PIN NALF PLUG

4-04874

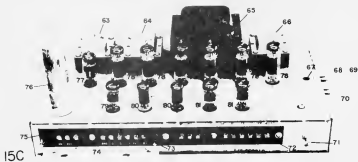
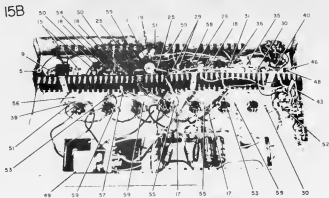
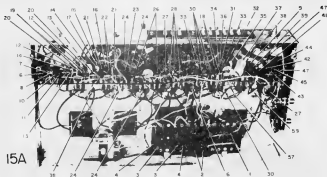

POWER SUPPLY/TEST ASSEMBLY

138-00019

13-1	CAPACITOR 30,000 μ F	425-01872	13-47	RESISTOR 20K	400-02843
13-2	CAPACITOR FILM 0.22 μ 400V	403-02043	13-48	WASHER	001-02102
13-3	RESISTOR 270 OHM 1/4	403-02052	13-49	ELECT. CAP 100V25 100V25 25/25 25/25	430-04902
13-4	RESISTOR 150 OHM 1/4	403-02061	13-50	ELECT. CAP 3.3K	400-02042
13-5	RESISTOR 100 OHM 1/4	403-04010	13-51	ELECT. CAP 100K	400-02043
13-6	RESISTOR 20K	400-02042	13-52	RESISTOR VARIABLE 1K	434-00020
13-7	RESISTOR 150K 1/4	400-02071	13-53	RESISTOR 50K 1/4	400-02030
13-8	RESISTOR 250 OHM 1/4	403-00006	13-54	CAPACITOR FILM 10,000 μ F	423-02043
13-9	RESISTOR 35K	400-02071	13-55	CERAMIC CAP 3,000 μ F	423-02003
13-10	RESISTOR 3.3K 1/4	400-02071	13-56	CERAMIC CAP 470 μ F	423-02012
13-11	RESISTOR 320K 1/4	400-02090	13-57	CERAMIC CAP 2000 μ F	423-02043
13-12	CERAMIC CAP 20,000 μ F	423-02073	13-58	CERAMIC CAP 220 μ F	423-02020
13-13	RESISTOR 1.2 M Ω	400-02120	13-59	CERAMIC CAP 220 μ F	423-02025
13-14	CERAMIC CAP 100 μ F	423-02073	13-60	CAP AND RESISTOR PANEL ASSY.	063-02042
13-15	CERAMIC CAP 220K	400-02012	13-61	CAP AND RESISTOR PANEL ASSY.	063-02030
13-16	CERAMIC CAP 4.7K	400-02040	13-62	CAP AND RESISTOR PANEL ASSY.	063-02031
13-17	CERAMIC CAP 47K	400-02000	13-63	REVERSE BIAS TRANSFORMER T1	003-02023
13-18	CERAMIC CAP 220K	400-02070	13-64	TRIPLE OUTPUT TRANSFORMER T1	003-02100
13-19	RESISTOR 40K 1/4	400-02050	13-65	HALF OUTPUT TRANSFORMER T2	003-02100
13-20	CAPACITOR CERAMIC 2200 μ F	423-02050	13-66	TRIPLE OUTPUT TRANSFORMER T3	003-02100
13-21	CAPACITOR FILM .005/200V	403-02043	13-67	POTENTIOMETER	034-02020
13-22	RESISTOR 400K	400-02120	13-68	NET CONTROL knob	023-02003
13-23	CAPACITOR FILM 0.10/200V	403-02033	13-69	TRIPLE REVERSE SWITCH	004-02030
13-24	RESISTOR 100K	400-02100	13-70	HALF REVERSE SWITCH	004-02030
13-25	RESISTOR 30K	400-02100	13-71	ROCK SLIDE SWITCH	004-02142
13-26	RESISTOR 400K	400-02100	13-72	TERMINAL PANEL	004-02274
13-27	RESISTOR 50K	400-02090	13-73	POST	004-02044
13-28	ELECT. CAP 1/200V	401-00017	13-74	TERMINAL COVER	004-02000
13-29	ELECT. CAP 10K	400-02030	13-75	TERMINAL PANEL	004-02123
13-30	ELECT. CAP 330K	400-02090	13-76	FILTER CAPACITOR	430-04040
13-31	ELECT. CAP 300K	400-02100	13-77	LEAKY TUBE	000-02100
13-32	RESISTOR 2.7 M Ω	400-02120	13-78	TUBE SOCKET	004-02100
13-33	CERAMIC CAP 2000 μ F	423-02040	13-79	AMPS TUBE	000-02100
13-34	CERAMIC CAP 1000 μ F	423-02040	13-80	TUBE SOCKET	000-02100
13-35	CERAMIC CAP 1000 μ F	423-02050	13-81	DIAMTA TUBE	000-02100
13-36	CERAMIC CAP 4700 μ F	423-02043	13-82	TUBE SOCKET	000-02100
13-37	CAPACITOR FILM 0.10/150V	430-01813	13-83	AMPS TUBE	000-02100
13-38	CAPACITOR 200K	400-02100	13-84	TUBE SOCKET	000-02100
13-39	CAPACITOR FILM 0.1/100V	404-02043	13-85	DIAMTA TUBE	000-02100
13-40	CAPACITOR FILM .0047/200V	404-02043	13-86	TUBE SOCKET	004-02000
13-41	RESISTOR 1.2 M Ω	400-02120			
13-42	RESISTOR 40K	400-02030			
13-43	ELECT. CAP 100V	401-02070			
13-44	CAPACITOR FILM 4700 μ F	423-02043			
13-45	RESISTOR 10K	400-02070			
13-46	RESISTOR 270 OHM	400-02030			

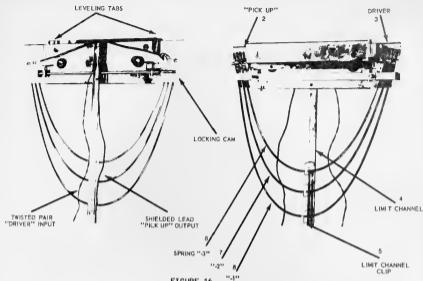

FIGURE 16

- | | | | | | | | |
|---|---------------------------|---|-----------------|---|-------------------|----|------------------|
| 1 | ROVERBORTON UNIT ASSEMBLY | 4 | LOCKING CAM | 7 | SPRING 1 (FLANGE) | 10 | WIRE 1 (PICK UP) |
| 2 | SUSPENSION SPRING | 5 | WIRE 2 (DRIVER) | 8 | SPRING 2 (SHIELD) | 11 | WIRE 2 (DRIVER) |
| 3 | PICK UP COIL ASSEMBLY | 6 | WIRE 3 (LIMIT) | 9 | SPRING 3 (SHIRT) | 12 | WIRE 3 (LIMIT) |
| 4 | DRIVER COIL ASSEMBLY | 7 | WIRE 4 (CLIP) | | | 13 | WIRE 4 (CLIP) |
| 5 | LIMIT CHANNEL | 8 | WIRE 5 (CLIP) | | | 14 | WIRE 5 (CLIP) |
| 6 | LIMIT CHANNEL CLIP | | | | | 15 | WIRE 5 (CLIP) |

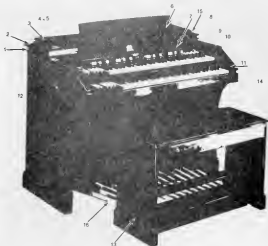

FIGURE 17

C-3 CASE ASSEMBLY

- 1 1 STATIONARY TOP
- 2 1 REVERSIBLE TOP ASSEMBLY
- 3 1 FALLBOARD ASSEMBLY
- 4 12 HAMMERS (12 USED)
- 5 14 HAMMERS (14 USED)
- 6 1 MUSIC PANEL
- 7 1 MUSIC PANEL BASE
- 8 1 BLOWER
- 9 1 MUSIC PANEL HINGE
- 10 1 MUSIC PANEL HINGE SCREW

KEY ROLLERS

- 11 12 CARROLL
- 12 12 CARROLL
- 13 12 CARROLL
- 14 12 CARROLL
- 15 12 CARROLL
- 16 12 CARROLL
- 17 12 CARROLL
- 18 12 CARROLL
- 19 12 CARROLL
- 20 12 CARROLL
- 21 12 CARROLL
- 22 12 CARROLL
- 23 12 CARROLL
- 24 12 CARROLL
- 25 12 CARROLL
- 26 12 CARROLL
- 27 12 CARROLL
- 28 12 CARROLL
- 29 12 CARROLL
- 30 12 CARROLL
- 31 12 CARROLL
- 32 12 CARROLL
- 33 12 CARROLL
- 34 12 CARROLL
- 35 12 CARROLL
- 36 12 CARROLL
- 37 12 CARROLL
- 38 12 CARROLL
- 39 12 CARROLL
- 40 12 CARROLL
- 41 12 CARROLL
- 42 12 CARROLL
- 43 12 CARROLL
- 44 12 CARROLL
- 45 12 CARROLL
- 46 12 CARROLL
- 47 12 CARROLL
- 48 12 CARROLL
- 49 12 CARROLL
- 50 12 CARROLL
- 51 12 CARROLL
- 52 12 CARROLL
- 53 12 CARROLL
- 54 12 CARROLL
- 55 12 CARROLL
- 56 12 CARROLL
- 57 12 CARROLL
- 58 12 CARROLL
- 59 12 CARROLL
- 60 12 CARROLL
- 61 12 CARROLL
- 62 12 CARROLL
- 63 12 CARROLL
- 64 12 CARROLL
- 65 12 CARROLL
- 66 12 CARROLL
- 67 12 CARROLL
- 68 12 CARROLL
- 69 12 CARROLL
- 70 12 CARROLL
- 71 12 CARROLL
- 72 12 CARROLL
- 73 12 CARROLL
- 74 12 CARROLL
- 75 12 CARROLL
- 76 12 CARROLL
- 77 12 CARROLL
- 78 12 CARROLL
- 79 12 CARROLL
- 80 12 CARROLL
- 81 12 CARROLL
- 82 12 CARROLL
- 83 12 CARROLL
- 84 12 CARROLL
- 85 12 CARROLL
- 86 12 CARROLL
- 87 12 CARROLL
- 88 12 CARROLL
- 89 12 CARROLL
- 90 12 CARROLL
- 91 12 CARROLL
- 92 12 CARROLL
- 93 12 CARROLL
- 94 12 CARROLL
- 95 12 CARROLL
- 96 12 CARROLL
- 97 12 CARROLL
- 98 12 CARROLL
- 99 12 CARROLL
- 100 12 CARROLL

- 1 11 WITH PLATE
- 1 11 BACK PANEL
- 1 11 BOND
- 1 11 LOCK KEY (OLD)
- 1 11 LOCK KEY (LATE)
- 1 11 LOCK KEY (BENT RECEIPT)
- 1 11 LOCK ASSEMBLY (FLUSH)
- 1 11 PINK CLIPPER ASST. (FOR PINK SIZE KEY - BREAKDOWN)

- 033-81571
- 036-80919
- 137-00018
- 032-80049
- 136-81838
- 035-84740
- 032-81833
- 131-00000

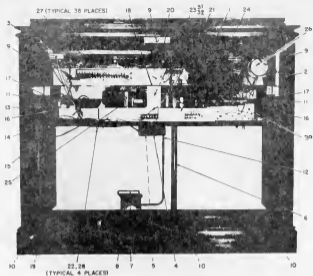

FIGURE 18

CONSOLE REAR VIEW - C-3

1	PROTECTOR ASSEMBLY	11	WRENCH
2	PROTECTOR ASSEMBLY	12	WRENCH
3	SOLE RUBBER MAT	13	WRENCH
4	LAMP ENCLOSURE	14	WRENCH
5	FLUORESCENT LIGHTING	15	WRENCH
6	LAMP ENCLOSURE	16	WRENCH
7	TUBE MOUNTING	17	WRENCH
8	NET RUBBER	18	WRENCH
9	SWELL PEDAL ASSEMBLY	19	WRENCH
10	TRANSFORMER FOR REAR PANEL	20	WRENCH
11	SHOULDER REST	21	WRENCH
12	BUT PLATE 1/2" x 3/4"	22	WRENCH
13	CONNECTOR ROD ASSEMBLY	23	WRENCH
14	SYNCHRONOUS MOTOR & SCANNER (220V/50HZ)	24	WRENCH
15	SYNCHRONOUS MOTOR & SCANNER (220V/50HZ)	25	WRENCH
16	COVER LINE PANEL	26	WRENCH
17	LINE PANEL ASSEMBLY	27	WRENCH
18	SPRING, HELICAL EXTENSION	28	WRENCH
19	WRENCH		
20	WRENCH		
21	WRENCH		
22	WRENCH		
23	WRENCH		
24	WRENCH		
25	WRENCH		
26	WRENCH		
27	WRENCH		
28	WRENCH		

TABLE OF CONTENTS - B
EARLY HAMMOND CONSOLES

MAJOR ASSEMBLY	PAGE
FRONT & REAR VIEWS OF MODEL RT3.	6-24
REAR VIEWS OF MODEL A100 & D100.	6-25
REAR VIEW OF MODELS WITH TREMULANT	6-26
REAR VIEW OF MODELS WITH VIBRATO	6-26
①. TONEBAR ASSEMBLY	6-27
②. UPPER AND LOWER KEYBOARD ASSEMBLY.	6-27
③. PEDAL SOLO END BLOCK	6-27
④. PEDAL KEYBOARD ASSEMBLY.	6-27
⑤. MATCHING TRANSFORMER	6-27
⑥. PRESET PANEL	6-27
⑦. GENERATOR.	6-27
⑧. PREAMPLIFIER	6-28
⑨. PEDAL SWITCH ASSEMBLY.	6-28
⑩. AMPLIFIERS	6-28
⑪. REVERB AMPLIFIER	6-29
⑫. REVERB UNIT.	6-29
⑬. POWER SUPPLY	6-29
⑭. SPEAKERS	6-29
⑮. PEDAL SOLO GENERATOR	6-30
⑯. PEDAL SOLO TUNER	6-30
⑰. VIBRATO LINE BOX	6-30
⑱. VOLUME CONTROL ASSEMBLY (RHEOSTAT BOX)	6-30
⑲. EXPRESSION PEDAL	6-30

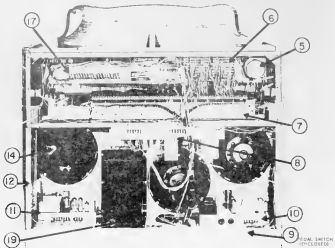

FRONT VIEW MODEL 10100

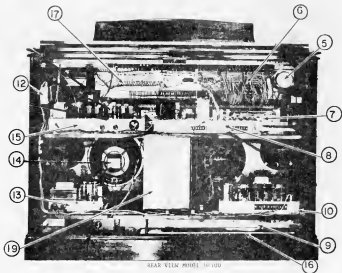

REAR VIEW MODEL 10100

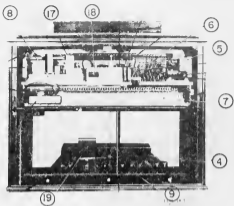

FIGURE 1. WINDOW FRAME ASSEMBLY (TOP VIEW)

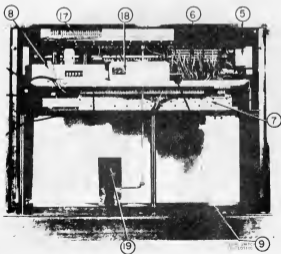

FIGURE 2. WINDOW FRAME ASSEMBLY (SIDE VIEW)

1. TONEBAR ASSEMBLY
- | | | |
|------------------|------------|------------|
| 1. TONEBAR KNOBS | BLACK..... | 025-035570 |
| | IVORY | 025-035571 |
| | BROWN | 025-035572 |
- NOTE: PARTS FOR EARLY "RATCHET" -
"CLICK" TYPE TONEBAR ASSEMBLY
ARE NO LONGER AVAILABLE. FOR
PART # INFORMATION ON LATER
SERIES TONEBAR ASSEMBLY, SEE
PAGE 6-7 OF B-3/C-3 PARTS LIST.
2. UPPER & LOWER KEYBOARD ASSEMBLY
- | | | |
|---------------------------------------------|---------------|------------|
| 1. VIBRATO-CHORUS SWITCH MODEL BV,CV,RT.... | 008-016988 | |
| 2. FRONT STRIP ASSEMBLY (LOWER) | | |
| | MODEL RT,D100 | 061-035813 |
- NOTE: MOST PARTS ARE SIMILAR TO PARTS
USED IN THE UKB & LKB OF THE
MODEL B-3 OR C-3. FOR PART #
INFORMATION, SEE PAGES 6-8 AND
6-9 OF THE B-3/C-3 PARTS LIST.
3. PEDAL SOLO ENDBLOCK
- | | | |
|---------------------------|--------------|------------|
| 1. POTENTIOMETER (VOLUME) | 500 OHM..... | 676-000221 |
| 2. OUTPUT TRANSFORMER | | 003-025348 |
4. PEDAL KEYBOARD ASSEMBLY (32 PEDAL)
- | | | |
|------------------------------------------------------------|----------|------------|
| 1. PEDAL CAPS (BLACK) | | 025-002664 |
| 2. SWITCH PUSHER SPRING (LONG)..... | | 012-035754 |
| | (SHORT) | |
| 3. WHITE PEDAL ASSEMBLY (ALL EXCEPT L & C,
D,H I E,F,C) | | 050-035756 |
| 4. DOWNSTOP FELT (4 HOLE) | 2 USED | |
| | (6 HOLE) | 6 USED |
| | (8 HOLE) | 4 USED |
- (PARTS INFORMATION ON 25 PEDAL KEYBOARD
IS FOUND ON PAGE 6-10 OF B-3/C-3 PARTS LIST.)
5. MATCHING TRANSFORMER
- | | |
|----------------------------|------------|
| MODEL A100, D100, RT3..... | 003-022020 |
|----------------------------|------------|
6. PRESET PANEL
(SEE PAGE 6-13 OF B-3/C-3 PARTS LIST.)
7. GENERATOR
- | | |
|--------------------------------------|------------|
| 1. FLYWHEEL COUPLING SPRING (2 USED) | 012-002345 |
| 2. GEARS COUPLING SPRING | 012-031463 |
| 3. COUPLING DRIVE SHAFT..... | 064-035768 |
- (SEE PAGES 6-6 AND 6-22 OF THE B-3/C-3
PARTS LIST FOR ADDITIONAL
INFORMATION.)

8. PREAMPLIFIER

NOTE: PARTS INFORMATION FOR THE PREAMPLIFIER
USED ON MODELS A100, D100 AND RT3 IS
FOUND ON PAGES 6-11 AND 6-12 OF THE B-3/C-3
PARTS LIST.

1. VIBRATO LINE TRANSFORMER MODEL BV,CV,RT 003-016906-001
2. VIBRATO OUTPUT TRANSFORMER BV,CV,RT 003-016906-002
3. HEATER TRANSFORMER
MODEL BV,CV,RT.....003-016907-001
MODEL E 003-017831-001
FOR 56-57 PREAMP
4. OUTPUT TRANSFORMER
MODEL E OR 56-57 PREAMP.....003-017826
MODEL AV,BV,BCV,CV,DV,RT 003-016906-002
MODEL B2,C2,RT2 003-024895
5. POWER TRANSFORMER MODEL B2,C2,RT2.....003-021414-001
6. POTENTIOMETERS (TONE CONTROL)
MODEL A,B,C,D,G,BV,CV,RT 1MEG
MODEL E DUAL 100K
MODEL B2,C2,RT2 300K.....676-000126
7. VACUUM TUBES #56
#57
6SJ7.....002-006302
6SN7 002-006306
6SC7 002-006305
6J7.....T000-000000-6J7
6J5
8. SWELL LEVER & BUSHING ASSEMBLY
MODEL A100,D100,RT3.....060-029990
B2,C2,RT2 060-021406
9. TRIMMER CAP (ALL).....499-021468

9. PEDAL SWITCH ASSEMBLY (32PEDAL)

MODELS D100 AND RT SERIES

1. PEDAL SIGNAL CONTACTS.....012-033530
2. BUSBAR CONTACTS
3. PUSHER PINS 017-001746
4. ACTUATORS
5. PEDAL FELT STRIP.....042-030749
(INFORMATION ON (25 PEDAL) PEDAL SWITCH
ASSEMBLY IS FOUND ON PAGE 6-11).

10. AMPLIFIERS

MODEL A-100 (AO-39)

MODEL D-100 (AO-33-5)

1. POWER TRANSFORMER AO-39
DOMESTIC 120V/60CY
EXPORT 234V/50-60CY....003-036754
2. OUTPUT TRANSFORMER
AO-39 003-024897
AO-33-5 TREBLE T1,T3 003-025349
BASS T2.....003-025346
3. FILTER CAPACITOR
AO-39 DUAL 30MFD/450V
AO-33-5 40/40/30MFD/450V....450-040200

4.	ROOM SIZE SWITCH AO-33-5	
5.	POTENTIOMETER AO-33-5 (REV GAIN) 2K...676-000107	
	AO-39 (HUM BALANCE) 100 OHM	
	AO-39 (SIGNAL BALANCE) 250 OHM	
6.	AC PLUG (2 PRONG) AO-39	
7.	3 PIN RECEPTACLE AO-39.....005-020790	
8.	4 PIN RECEPTACLE AO-39	005-020864
9.	VACUUM TUBES	
	12AX7/ECC83	002-012301
	6BQ5.....002-006700	
	5U4/5Y3	002-005201
	12AU7	002-012300
	12BH7.....002-012302	
10.	TRANSISTOR AO 33-5	001-021070

11. REVERB AMPLIFIER
 MODEL A100 (AO-35) (EARLY SERIES).....126-000111-007
 (AO-44) (LATER SERIES)

1.	POWER TRANSFORMER	
	AO-35	
	AO-44 DOMESTIC 120V/60CY....003-024956	
	EXPORT 220V/50CY	003-036756
2.	OUTPUT TRANSFORMER AO-35	
	AO-44.....003-036552	
3.	FILTER CAPACITOR AO-35	450-040200
	AO-44	
4.	MINIATURE LAMP GE #12 6.3V/.15A	016-022885
5.	LAMP HOLDER	
6.	POTENTIOMETER AO-44 R27 2K	
7.	TRANSISTOR AO-44.....001-021260	
8.	FUSE AO-44 ONLY DOMESTIC 3/4A	016-039512
	EXPORT 3/8A	
9.	VACUUM TUBES	
	5U4/5Y3.....002-005201	
	ECC83/12AX7	002-012301
	6BQ5	002-006700
	E281/6CA4.....002-006200	
	ECL86/6GM8	002-006401

12. REVERB UNIT MODEL A100 & D100.....121-000046

13. POWER SUPPLY MODEL D100

NOTE: THE POWER SUPPLY OF THE D100 IS
 SIMILAR TO THE POWER SUPPLY USED
 ON THE MODEL PR-40 TONE CABINET.
 FOR PART # INFORMATION, REFER TO
 PAGE 6-17 OF THE B-3/C-3 PARTS
 LIST.

14. SPEAKERS

	MODEL A100 REVERB 12" 8 OHM.....014-024676	
	ORGAN 12" 8 OHM (2 USED)	014-023232
	MODEL D100 REVERB & TREBLE 8" 8 OHM	014-025397
	BASS 12" 8 OHM (2 USED).....014-021270	

- (15) PEDAL SOLO GENERATOR
 D100
 RT SERIES.....114-000002
- | | | |
|----|-----------------------------------|-----------------|
| 1. | POWER TRANSFORMER T1 | |
| 2. | AUDIO TRANSFORMER T2 | |
| 3. | FILTER CAPACITOR 40/20/20MFD/400V | 450-040200 |
| | 20MFD/400V | |
| 4. | MULTI CONNECTOR (FEMALE)..... | 005-019113 |
| 5. | MULTI CONNECTOR (MALE) | 005-019081 |
| 6. | TUBE SOCKET (13 USED) | 004-018934 |
| 7. | VACUUM TUBES | |
| | 6J5 | |
| | 6SL7..... | T000-000006-SL7 |
| | 6SN7 | 002-006306 |
| | 6SC7 | 002-006305 |
- (16) PEDAL SOLO TUNER ASSEMBLY MODEL D100 & RT
 NOTE: PARTS FOR PEDAL TUNER ARE NO
 LONGER AVAILABLE.
- (17) VIBRATO LINE BOX
 MODEL BV,CV,RT
 B2,C2,RT2.....121-021860-001
 A100,D100,RT3 121-000083
- | | | |
|----|--------------------------------|----------------|
| 1. | COIL MODEL B2,C2,RT2 | 003-021842-003 |
| | EARLY MODEL A100,D100,RT3..... | 003-016924-001 |
| | LATER MODEL A100,D100,RT3 | 003-033303 |
- (18) VOLUME CONTROL ASSEMBLY (RHEOSTAT BOX)
 1 CAM RHEOSTAT.....045-002013
- (19) EXPRESSION PEDAL
 MODEL B2,RT2 123-000009
 MODEL C2,A100,D100,RT3.....123-000010
 (FOR ADDITIONAL INFORMATION, SEE PAGE
 6-15 OF B-3/C-3 PARTS LIST.)

TABLE OF CONTENTS - C
EARLY HAMMOND TONE CABINETS

MAJOR ASSEMBLY	PAGE
TONE CABINET CROSS REFERENCE	6-32
①. POWER AMPLIFIER.	6-33
②. SPEAKERS	6-34
③. TUBES.	6-34
④. REVERB AMPLIFIER	6-34
⑤. PLUGS AND RECEPTACLES.	6-35
⑥. CABLES AND CONNECTORS.	6-35

NOTE: THE PART INFORMATION FOR TONE CABINETS IS BROKEN DOWN BY AMPLIFIER TYPE. PLEASE REFER TO THE CROSS REFERENCE ON BACK OF THIS PAGE TO DETERMINE THE AMPLIFIER TYPE BEFORE PROCEEDING.

TONE CABINET CROSS REFERENCE

MODEL	SERIAL #	AMPLIFIER TYPE
A-20	1000 & ABOVE	F
A-40	2400 & ABOVE	F
B-40	2400 to 19841 INCL.	F
C-40	2400 & ABOVE	F
D-20	4348 to 25109 INCL. 25110 to 26968 INCL. 26969 & ABOVE	F G H-1-A
DR-20	15007 to 22399 INCL. 22400 to 35303 35304 & ABOVE	F G HR-1
DX-20	ALL	F
ER-20	27001 to 28709	G
F-40	37001 to 37659 37660 & ABOVE	G H-1-A
FR-40	35001 to 35623 INCL. 35624 & ABOVE	G HR-1 H-1-A
G	ALL	F
H-40	55002 to 59999 INCL. 50002 to 59999 INCL. 6000 & ABOVE 60660 & ABOVE	JR K LR LR CODE "B"
HR-40	55002 to 56499 INCL. 50002 to 56499 INCL. 56500 & ABOVE 80061 & ABOVE	JR K LR LR CODE "B"
JR-20	30500 to 32015 32016 & ABOVE 75877 & ABOVE	A0-15 A0-15 CODE "B" A0-15 CODE "C"
P-40	ALL	A0-40
Q-40	ALL	A0-40

FOR PARTS INFORMATION ON THE MODELS PR40,
QR40 AND PR20 TONE CABINETS, REFER TO PAGE
6-16 OF B-3/C-3 PARTS LIST.

- ①. POWER AMPLIFIERS
- TYPE "F"
1. POWER TRANSFORMER AO-16670-1..003-016670-002
 2. OUTPUT TRANSFORMER AO-16681-1 003-016681-001
 3. FILTER CHOKE AO-16682-1
- TYPE "G"
1. POWER TRANSFORMER 115V/60Hz AO-16670-5..003-016670-002
115V/50-60Hz AO-16670-6
230V/50Hz AO-16670-7
 2. OUTPUT TRANSFORMER AO-16681-2
 3. FILTER CHOKE L1,L2 (40 OHM) AO-16682-1
- TYPE H-1-A
1. POWER TRANSFORMER 115V/60Hz AO-20927-1..003-036899
115V/50-60Hz AO-20927-2
230V/50Hz AO-20927-3
 2. OUTPUT TRANSFORMER AO-16681-4
 3. FILTER CHOKE L1,L4 (40 OHM) AO-16682-2
- TYPE HR-1
1. POWER TRANSFORMER 115V/60Hz AO-20927-1..003-036899
115V/50-60Hz AO-20927-2
230V/50-60Hz AO-20927-3
 2. OUTPUT TRANSFORMER AO-16681-3..003-016681-003
 3. FILTER CHOKES (40 OHM) AO-16682-2
 4. REVERB TRANSFORMER AO-16134-1 003-016134-003
- TYPE JR
1. POWER TRANSFORMER 115V/60Hz AO-20927-1..003-036899
115V/50-60Hz AO-20927-2
230V/50-60Hz AO-20927-3
 2. OUTPUT TRANSFORMER AO-16681-5
 3. FILTER CHOKES (40 OHM) AO-16682-2
 4. REVERB TRANSFORMER AO-16134-1..003-016134-003
- TYPE K
1. POWER TRANSFORMER 115V/60Hz AO-20927-4 003-036899
115V/50-60Hz AO-20927-5
230V/50-60Hz AO-20927-6
 2. OUTPUT TRANSFORMER AO-21106-1
 3. FILTER CHOKES (40 OHM) AO-16682-2
- TYPE LR
1. POWER TRANSFORMER 115V/60Hz AO-20927-7..003-036899
115V/50-60Hz AO-20927-8
230V/50-60Hz AO-20927-9
 2. OUTPUT TRANSFORMER (TREBLE) AO-21264-0
(BASS) AO-21106-3..003-021106-003
 3. FILTER CHOKES 6 HENRY AO-21268-0
18 HENRY AO-16682-3
 4. REVERB TRANSFORMER AO-16134-2..003-016134-003

TYPE AO-15

- POWER TRANSFORMER 115V/60Hz AO-20927-10
115V/50-60Hz AO-20927-11
230V/50-60Hz AO-20927-12
- OUTPUT TRANSFORMER (TREBLE) AO-21566-1 .003-021566-001
(BASS) AO-16681-6 003-016681-006
- FILTER CHOKES 2.5 HENRY AO-16682-5
15 HENRY AO-16682-4 .003-016682-004
- REVERB TRANSFORMER AO-16134-3 003-016134-003

TYPE AO-40

- POWER TRANSFORMER 115V/60Hz AO-23514-1 .003-023514-001
115V/50-60Hz AO-23514-2
230V/50-60Hz AO-23514-3
- OUTPUT TRANSFORMER (TREBLE) AO-21264
(BASS) AO-21106-6
- FILTER CHOKES 6 HENRY AO-21268-1
18 HENRY AO-16682-3

2. SPEAKERS

NOTE: ELECTRO DYNAMIC SPEAKERS ARE
NO LONGER AVAILABLE. USE PART #
014-021270 AS A REPLACEMENT
ALONG WITH 250 OHM 10 WATT
RESISTOR, FOR THE FIELD COIL.
SEE PAGE 6-36 FOR MORE DETAILS.

MODEL JR20,HR40,KR40,H40,K40

10" 6-8 OHM.....014-021075

12" 8 OHM 014-021270

MODEL PR20

15" 4 OHM 014-028933

12" 8 OHM.....014-021270

MODEL PR40,QR40,P40,Q40

15" 4 OHM 014-023421

12" 8 OHM.....014-021270

3. TUBES

#56

2A3

6J5

6V6.....002-006703

5U4 002-005201

6SN7 002-006306

6SC7.....002-006305

6SJ7 002-006502

4. REVERB AMPLIFIER

(USED IN MODELS DR,ER,FR,TONE CABINETS)

- OUTPUT TRANSFORMER AO-16134...003-016134
- COUPLING TRANSFORMER AO-16135
- HEATER TRANSFORMER AO-16133-1
- TUBES

6J5

6J7.....T000-000000-6J7

6SN7 002-006306

6SJ7 002-006502

5. PLUGS AND RECEPTACLES
- | | | |
|----|------------------------------------|------------|
| 1. | 5 PIN PLUG..... | 005-016018 |
| 2. | 5 PIN RECEPTACLE | 005-016032 |
| 3. | 6 PIN PLUG | 005-016156 |
| 4. | 6 PIN RECEPTACLE (WAFER TYPE)..... | 005-020757 |
| 5. | 6 PIN CONNECTOR (WAFER TYPE) | 005-020758 |
| 6. | 7 PIN PLUG | 005-016121 |
| 7. | 7 PIN RECEPTACLE..... | 005-016126 |

6. CABLES AND CONNECTORS
- | | | |
|----|---------------------------------------------------|----------------|
| 1. | 5 CONDUCTOR CABLE COMPLETE..... | 011-036408 |
| 2. | BULK CABLE (5 CONDUCTOR)
(SPECIFY LENGTH) | 200-000022 |
| a. | CONNECTOR (CONSOLE END)..... | 005-016018 |
| b. | CONNECTOR (TONE CABINET END) | 005-016032 |
| c. | CONNECTOR CAPS (4 USED) | 060-020560 |
| 3. | 6. CONDUCTOR CABLE (NOT SHIELDED) | |
| | 30'..... | 511-017277 |
| | 50' | 511-017277-050 |
| | 100' | 511-017277-100 |
| 4. | BULK CABLE (6 CONDUCTOR)
(SPECIFY LENGTH)..... | 511-010298 |
| a. | CONNECTOR PLUG | 505-061721 |
| b. | CONNECTOR SOCKET | 504-029546 |
| c. | CONNECTOR CAP PACKAGE (2 USED)... | 505-137457 |
| 5. | AC LINE CORD
(CONSOLE TO WALL OUTLET) | 011-035752 |

SPEAKER REPLACEMENT IN EARLY TONE CABINETS USING ELECTRODYNAMIC SPEAKERS

Electrodynamic speakers are no longer being manufactured. They can be replaced with Permanent Magnet (PM) speakers in early Hammond tone cabinets. Good results will be achieved, if the instructions below are followed.

Order two speakers, or four speakers as related to tone cabinet, #014-021270.

1. Remove speaker plugs from amplifier and remove both speakers from tone cabinet.
2. Clip all 4 wires from both speakers as close to speaker as possible.
3. Discard both speakers.
4. Remove wires from pins 1 and 6 of the 6 pole plug. Remove these wires from cable.
5. Remove wires from pins 1 and 5 of the 5 pole plug. Remove these wires from cable.
6. Install a 250 ohm 20 watt resistor across pins 1 and 5 of the 5 pole plug. Use sleeving over lead connected to pin 5.
7. Solder 2 remaining wires in each speaker cable to the new PM speakers. Solder wire with solder lug to the left hand speaker terminal as viewed with the speaker terminal strip facing up. Solder wire from speaker plug to right hand terminal.
8. Mount new speakers in cabinet and insert plugs into amplifier. Attach leads with solder lug to upper binding post.
9. Dress 250 ohm resistor away from any speaker leads or other objects to assure adequate heat dissipation.

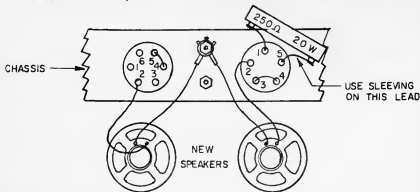

WORLDWIDE

TRAVEL

WORLDWIDE