

# Hinges Furniture



**MI-109**  
Soft Closing Hinge  
With Cam Adjustment  
(50,000 Opening Cycles)



**MI-119**  
Soft Closing Hinge  
(30,000 Opening Cycles)



**HYB-5/8**  
Short Arm  
Soft Closing Hinge



**SHG2-09/SPG - 09**  
Soft Closing  
Diameter 26mm, 35mm  
Glass Hinge



**SP02-09**  
SUS 304 Stainless Steel  
Soft Closing Hinge



**EH-001S**  
Soft Closing  
Easy on Hinge



**EH-001**  
Easy-on Hinge



**CD-09/0mm (Full overlay)**  
**CD-08/18mm (Half overlay)**  
**CD-07/15mm (Insert)**  
105° Concealed Hinge



**CIG-09 / CNG-09**  
ø26mm & ø35mm  
Glass Door Hinge  
Nickel Plated

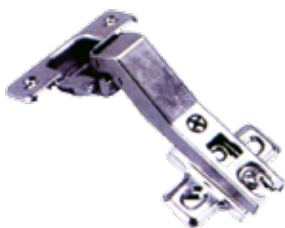

**SH-002**  
Special Angled Hinges  
45° M80/45°



**a)SH-003**  
90° Special Angled Hinge  
**b)SSH-003**  
90° Soft Closing Special  
Angled Hinge



**SH-005**  
30° Special Corner  
Hinge



**CM-09**  
40mm Cup  
Hinges For Thick Doors



# Hinges Furniture



**FGV 51MS15050005033**

Slide-on 110°  
Crank 0  
Cup Diameter: 35mm



**FGV 51MS150508050A2**

Slide-on 110°  
Crank 8  
Cup Diameter: 35mm



**FGV 51MS15051515033**

Slide-on 110°  
Crank 15  
Cup Diameter: 35mm



**FGV 51MW150500050A2**

Slide-on 175°  
Crank 0  
Cup Diameter: 35mm



**FGV 5MS830535**

Side-on 135°  
Corner Hinge  
Cup Diameter: 35mm



**FGV 51MZF5MI205550**

Slide-on  
Short Arm Hinge  
Cup Diameter: 35mm



**FGV 51AS25050005032**

2-Way Slide-on 110°  
Crank 0, 8, 15mm  
Cup Diameter: 35mm (Soft closing)  
(With Detachable Base Plate)



**FGV 51ASH500T5034**

2-Way Click-on 110° 2D  
Crank 0  
Cup Diameter: 35mm  
(Soft closing)



**FGV 51AWH50500050L2**

Click-on 175° 3D  
Crank 0  
Cup Diameter: 35mm  
(Soft closing)



**FGV 51AS45050005032**

Diameter: 40mm  
Soft closing Hinges



**FGV 51. MN57. R5. 00000**

Slide-on 95°  
Flap Hinge



**FGV 51MS15P500000+520201M5021R000**

UP Spring Push Open Hinge  
Cup Diameter: 35mm

## LAMP Heavy duty concealed hinge, J-95



- J-95 hinge supports a full height door up to 800mm wide of up to 25kgs on two hinges.
- It is fitted into a 40mm hole which gives it a better grip on larger doors than the standard 35mm used on other hinges.
- Clip-on feature allows easy door installation/removal.
- 3-way adjustment function allows vertical, horizontal, and depth adjustment after hinge installed.

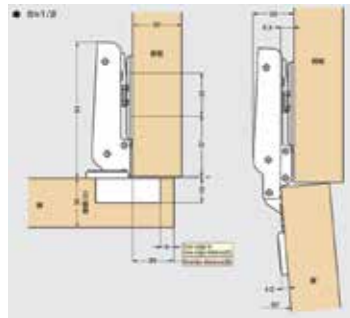
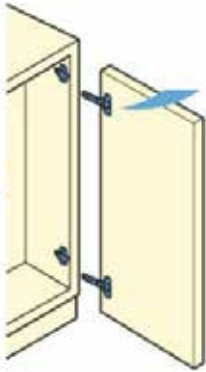

Vertical adjustment	± 3mm
Horizontal adjustment	+0/-4mm
Depth adjustment	+1.5/-2.5mm

Item code	Item name	Type	Overlay distance (C = 8mm)	Door thickness	Door weight	Material	Carton
160-026-731	J95-C24/25T	Self-closing	21~25mm	18~30mm	Max. 25kg/2 pcs	Steel/ZDC	100 pcs
160-026-732	J95-P6T	Clip-on	-	18~30mm	-	Steel/ZDC	100 pcs

## Series 3000: New easy clip Institutional Furniture Hinge



### Features:

- Unique 3D adjustment
- Elegant design
- Outstanding stability and longevity
- Gap 4 mm resp. 6mm for full, half and twin overlay applications.
- Gap 3 mm for inset application
- All variants certified in accordance with ANSI
- Opening 270°

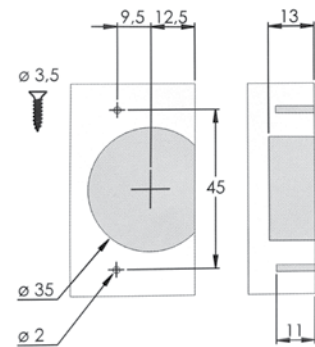

No.			
3820 C 91 N			
3640 C 91 N			
3650 C 91 N			
3660 C 91 N			

# Hinges Furniture



## MonoFlat LIN-X hinge™



	LAMP LIN-X450	LAMP LIN-X600
Door Width	400-500mm	550-650mm
Door Height	600-2400mm	600-2400mm
Door Thickness	15-24mm	15-24mm
Door Weight	7-17kg/Door	9-24kg/Door

\*Max door weight will vary depending on number of hinges used.



- **Lateral Swing Mechanism**  
Allows to swing out laterally in small radius, ideal for tight front space application.
- **Full access to cabinet**  
Door will not get in the way when fully opened providing full access to the cabinet.
- **Free swing & soft-close.**
- **Easy Installation.**
- **4-way Adjustable.**
- **Various Applications -** Corner use, double door use & overlapped door use.

\* Please note handle position on other doors before installation, so that hinges will not interfere with the handles.

### LAMP LIN-X1000

#### Monoflat Lin-X Hinge (Heavy Duty)



Door Width	750 - 1100 mm
Door Height	Max. 2980 mm
Door Thickness	24 - 40 mm
Door Weight	Max. 90 kg / Door

#### Features

- **Unique Design & Easy Installation.**
- **Lateral Swing Mechanism**  
Allows doors to swing out laterally in a small radius, ideal for tight front space application.
- **Full Access to Cabinet**  
Door will not get in the way when fully opened providing full access to the cabinet.
- **Smooth Movement**  
Handle can be installed in any position of door.
- **Free Stop & Soft-close**  
Door can be stopped in any position and closes softly.
- **4-Way Adjustable**  
Adjustment in vertical ( $\pm 7$  mm), horizontal ( $\pm 7$  mm), depth ( $\pm 5$  mm) and parallel ( $\pm 3^\circ$ ).

#### Parts Included

- Truss head tapping screw 6x25 (16 pieces)

#### Applicable Door Load Capacity

Open/Close cycles	Door sagging	
	3mm	5mm
60,000	70kg	90kg
80,000	50kg	80kg
100,000	40kg	70kg

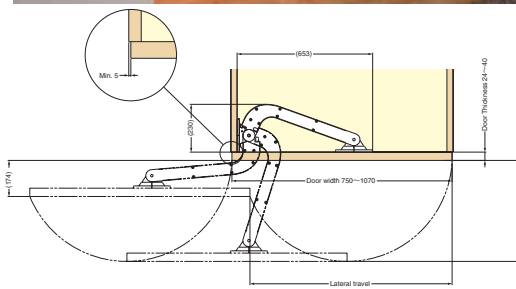

## Mirror Lid Door

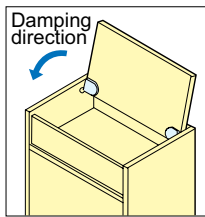
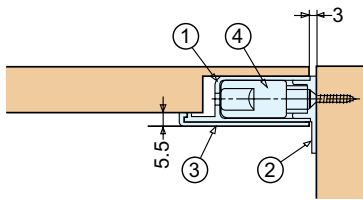

Ideal for shallow box or any compartments

## LAMP Soft Closing Damper Hinge

- Hinge with built-in damper to keep lid from slamming shut.
- Mortise mount type.
- Ideal for small size lid.
- Sold in pairs.

### Medium Duty

Item No.	Part Name	Colour	Torque per pair (kgf.cm)
HG-JHM 16-34	Body	Black	20~34 (17.4~29.5 lbs.in)
HG-JHM 16-50			34~50(29.5~43.4 lbs.in)

### Heavy Duty

Item No.	Cover Plate	Torque per pair (kgf.cm)
HG-JHN20-80BL	Black	60~80
HG-JHM20-80WT	White	

### Criterion of Door Weight

Door Height D	Door Weight M	
	HG-JHM16-34	HG-JHM16-50
250	2.19~3.73 kg	3.73 ~ 5.48 kg
300	1.73 ~ 2.94 kg	2.94~ 4.32 kg
350	1.43 ~2.42 kg	2.42 ~ 3.57 kg
400	1.21 ~ 2.06kg	2.06 ~ 3.03 kg
450	1.06 ~ 1.80 kg	1.80 ~ 2.64 kg

### Criterion of Door Weight - HG - JHM20

Door Height D	Door Weight M
50	5.58 ~ 8.77 kg
300	5.18 ~ 6.91kg
350	4.28 ~5.70 kg
400	3.64 ~ 4.86kg
450	3.17 ~ 4.23kg

## LAMP Damper Hinge HG-JHM20T

### Surface Mount Type PAT

- Our newest addition: surface mount, no cut-out required
- A compact damper hinge with one UDH-Series lapcon Damper included
- For soft closing and smooth opening
- Upper-Lid inset type
- With cover to hide mounting screws

### Remarks:

- Sold as one set (left/right) only
- Torque values calculated with one set (left/right) used
- \* Please use within the designated torque values
- Install evenly using a level
- The dampers works work when opened above 60°, below that functionality cannot be guaranteed

Lid thickness	Standard		Chamfered Edge	
	A	Minimum gap	A	Minimum gap
16	36	4	38	2
18			37	3
20			-	-

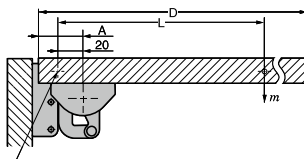

Calculation of Maximum Torque Moment  
(if using uniform materials)



Set - Black

Sold as one set (left/right) only

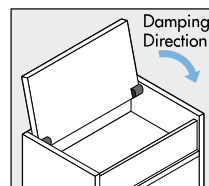

### Front View

When lid is closed

When lid is opened 90°

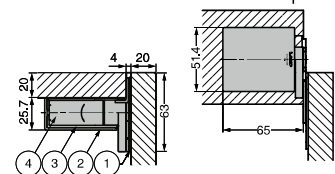

# Hinges Architectural

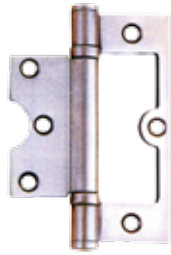

**A01-030**  
3", 3.5", 4"  
Stainless Steel  
BT-Fold Hinge



**ST-C118**  
Suitable for doors  
from 600 to 1000mm  
width and up to  
2700mm height  
with a minimal door  
thickness of 40mm.  
Load capacity 80kgs.  
*\*We recommend always 3  
hinges installed!*



**MI-016**  
Aluminium Frame Cranked Hinge  
4"x3"x2.0mm  
SUS 304 Stainless Steel



**Stainless Steel Hinge**  
2" x 1.2mm  
2.5" x 1.2mm  
3" x 1.5mm  
4" x 3" x 2mm  
4" x 3" x 3mm  
5" x 3.5" x 3mm  
*\* 6" x 3.5" x 3mm  
\* Other sizes upon request  
\* Available in SS304 & SS316*



**A104**  
Aluminium Alloy Spring Hinge  
(with speed adjustment)  
180 x 80 x 4mm  
*(\*For single & Double Action opening doors)*



**DAS-001**  
SUS 304 Stainless Steel  
Double Action Hinge  
3", 4", 5", 6"



**A01-014**  
Cranked Hinge 4" x 3" x m33  
SUS 304 Stainless Steel

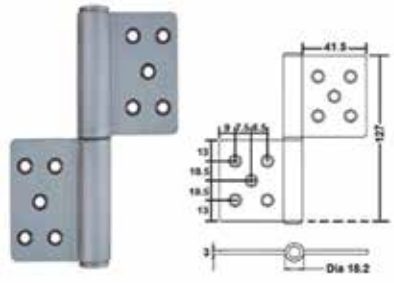

**A01-028**  
125 x 102 x 3mm  
SUS 304 Stainless Steel Flag Hinge



**MI-316**  
SUS 304 Stainless Steel 360°  
Centre Pivot Hinge  
Size : 75mm, 102mm



**ST-C122**  
PIVOT Hinge (Adjustable)  
- Door Thickness : 29 - 40mm  
- Max. Door Height : 2200mm  
- Max. Door Width : 900mm  
- Max. Door Weight : 45kgs

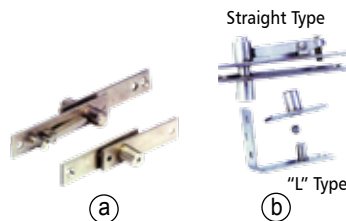

**a) C-117 b) C-117-B**  
SUS 304 Stainless Steel  
Pivot Door Hinge  
Max. Door Weight : 80 kgs



**ST-C121**  
Pivot Hinge with Auto Closer &  
90° Hold Open,  
Max. Door Weight: 45kgs



Hydraulic Auto Spring Hinge

Made in Korea

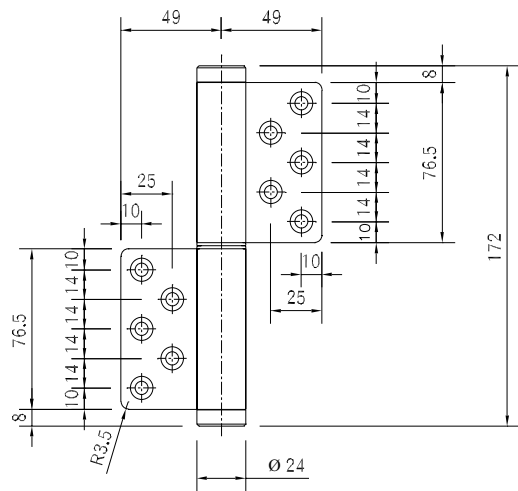

Series	Product Code	Closing Force (N.m)	Size (Φ/mm)	Weight (g)	Max Opening Degree	Hold Open Degree	Material	Coating	Installation	Function
F	F	50M	Φ24X172X98	600	180°	80° ~180°	AL St'l	Liquid	Mortise	Multi
		50S				-				Spring
		50E		-		400				0°~180°



FSG-50 Glass Door Hinge

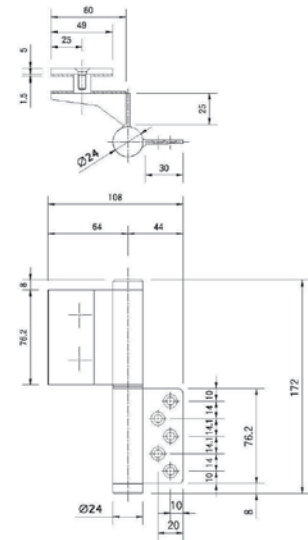
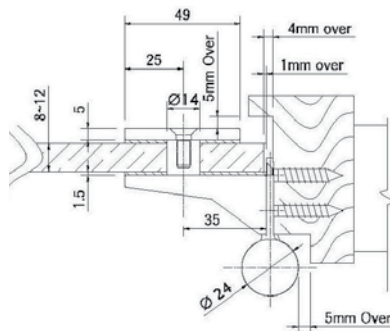

LAMP PH-01 (2 Way Adjustable Pivot Hinge)

- Vertically and laterally adjustable after installed.
- Sold in pairs (top and bottom), non-handed.
- Supplied with wood screw 4x30.
- Separate body and bracket for easy installation.
- Door Height: Max. 2300mm (90-34/64")
- Door Width: Max. 850mm (33-15/32")
- Door Weight: Max. 35kg (77lbs)
- Door Thickness: 33-45mm (1-19/64" - 25/32")

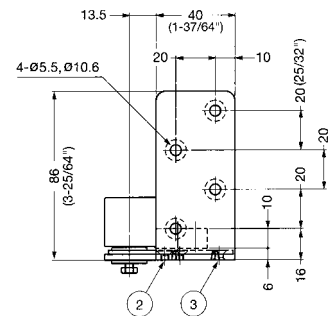
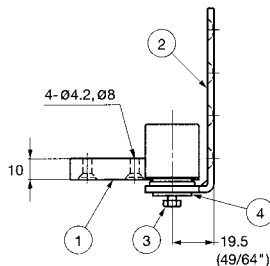
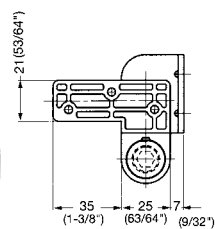



# Hinges Architectural

## LAMP HES3D-120

3-Way Adjustable Concealed Hinge

- 3 WAY adjustment function allows vertical, horizontal, and depth adjustment after hinge installed.
- Easy installation and adjustment.
- Successfully passed 300,000 open/close private cycle tests.
- Supplied with steel flat head screw.
- Cover hides all screw heads for clean appearance.
- Door weight: Max. 30kg/2pcs, 40kg/3pcs
- Door Thickness: Min. 29mm
- Max. Door Size: H 2400mm × W 900mm



HES3D-120DN



HES3D-120DC

\* Black colour available upon request

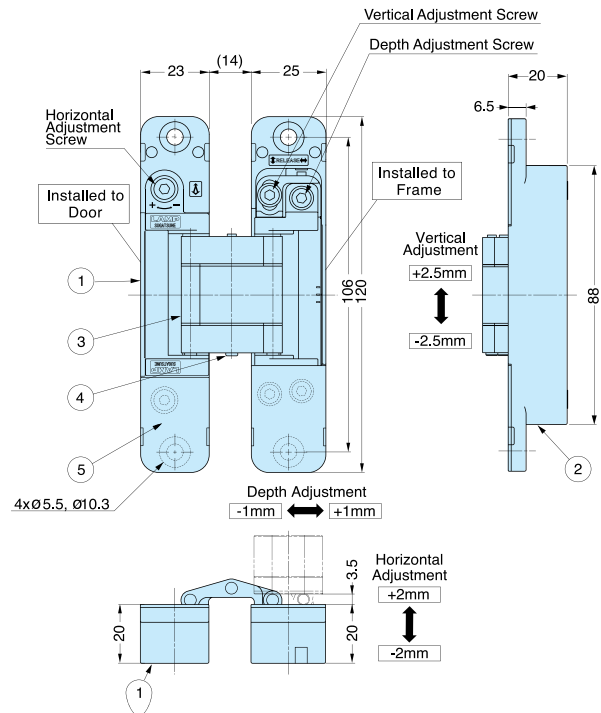

## LAMP HES3D-E190

3-Way Adjustable Concealed Hinge

- 3 WAY adjustment function allows vertical, horizontal, and depth adjustment after hinge installed.
- Easy installation and adjustment.
- Successfully passed 300,000 open/close private cycle tests.
- Supplied with steel flat head screw.
- Cover hides all screw heads for clean appearance.
- Door weight: Max. 100kg/2pcs, 125kg/3pcs
- Door Thickness: Min. 38mm
- Max. Door Size: H 2400mm × W 900mm



HES3D-E190 DN



HES3D-E190 DC



HES3D-E190 BK

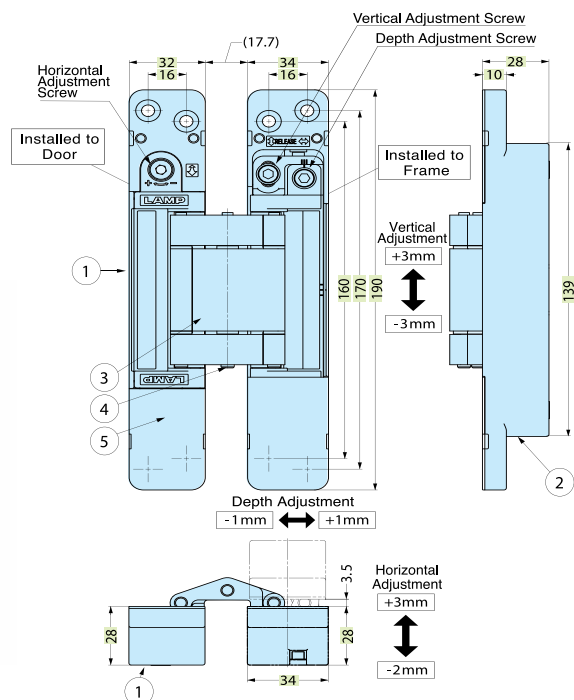

## KUBICA K7200

Made in Italy



<p>Realizzazione Version</p> <p>ZAMA</p>	<p>Finitura Finishing</p>	<p>Regolazioni Adjustments</p>	<p>min. 40 mm</p>	<p>Viti per fissaggio Fixing screws</p>
<p>200 kg 2 cerniere - hinges</p>	<p>COVER</p>	<p>180°</p>		

## HERCULE

\* Indent

**HIDDEN INTO THE DOOR FRAME:  
prevent from damages !**

### INVISIBLE DOOR-CLOSER For Metal Gate

Item Nr.	Designation
25310 D 25310 G	Pivot working in simple action, integrable in tubular tracks starting at Ø 35. For doors up to 80 kg. Entirely hidden system avoiding any damages. 25310 D : opening on the right 25310 G : opening on the left
25314 D 25314 G	Dito starting at Ø 40. For doors up to 130 kg 25314 D : opening on the right 25314 G : opening on the left
25318 D 25318 G	Dito starting at Ø 50. For doors up to 200 kg 25318 D : opening on the right 25318 G : opening on the left

Choice of the opening direction

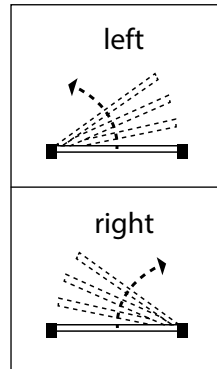

**Detailed view of the access trap**



### GATES MOUNTED ON PIVOTS

#### UTILIZATION FOR GATE

It is recommended to place a pivot in the upper part :  
Item Nr 25051 H : Welding version  
Item Nr 25052 H : Screwing version

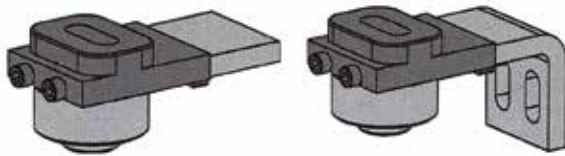

#### UTILIZATION FOR DOOR

A special upper pivot for door is supplied with our door-closer.

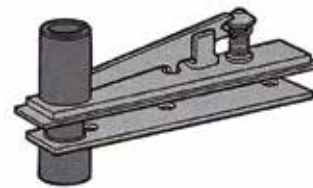

### MI-D80-5

Non-Digging Floor Hinge

#### Features

- Bottom patch and floor spring function combined, no need to dig the ground, easy installation and saving labor.
- Unique base design, 5mm backward and forward, 7mm left and right, 5° alignment adjustment.
- Opening angle of 140° double action, 90° hold-open (optional), 2 speeds adjustable No. 1 closing speed: 85° - 40° No. 2 soft closing speed: 40°-0°.
- Life Span: 50,000 cycles.

Suitable door width (mm)	Max. load capacity (kg)	Dimension (cover plate not included) (mm)	Glass Thickness
≤ 1200	80	173 x 52 x 95	10-15mm

Glass door cutout dimension

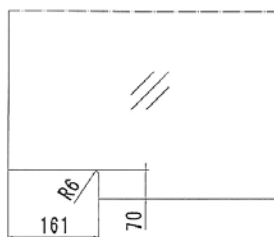

Dimension

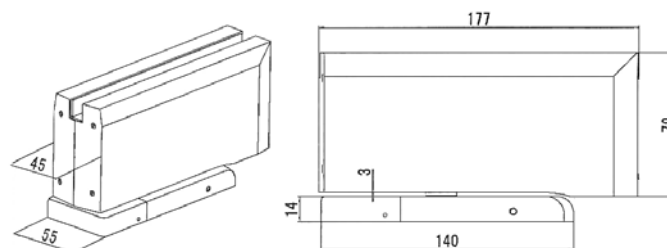

# Hinges Architectural



**MI-1101**  
90° Series Shower Hinges  
Chrome



**MI-1103**  
135° Series Shower Hinges  
Chrome



**MI-1104**  
180° Series Shower Hinges  
Chrome



**LAMP GH-34/8**  
Lamp  
Glass Door Hinge  
Chrome Plated



**GH-02, GH-03**  
Glass Hinge  
for 5mm - 8mm Glass  
Chrome Plated



**3619HG8IN**  
6-12mm Glass Thickness  
13mm Overlay  
SUS316 Stainless Steel

270° Opening



**B0076**  
SN  
Glass Pull  
Glass Thickness: 5mm-6mm



**B0074**  
SN  
Glass Hinge  
Glass Thickness: 5mm-6mm



**B0075**  
SN  
Glass Center Hinge  
Glass Thickness 5mm-6mm



**(a) MI-049/(b)MI-059**  
Stainless Steel Hi-Fi Hinges  
(a) 6-8mm, (b) 10-12mm

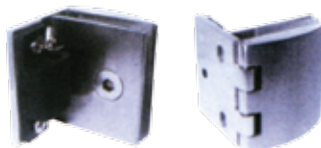

**CM 860-S / CM 861-L**  
Glass Hinge  
For 6-8mm glass  
Satin Nickel



**AM 3010**  
Non-Bore-Hole Showcase  
Display Glass Door Hinge



## LAMP J95-Heavy Duty Concealed Hinge (for glass doors)

- 3 way adjustment:  
Horizontal : -4 - +0mm  
Vertical : -3 - +3mm  
Depth : -2.5 - +1.5mm

Glass Thickness	8mm	10mm
Door Weight	Max. 25kg / 2pcs Max. 35kg / 3pcs	
Door Width	Max. 800mm	Max. 700mm / 2pcs Max. 800mm / 3pcs
Door Height	Max. 1850mm / 2pcs Max. 2000mm / 3pcs	



Safety Cover (Optional)



## LAMP Glass Showcase Hardware

- Hinges, Locks and Sliding door hardware with same design concept.
- Swing and Sliding Doors can be operated with a single key.
- Key hole is located on the side for clean appearance.
- 5~8mm Glass Thickness
- Door size: W500 x H1200mm(max)
- Load capacity : 12kg/Door
- Chrome Finish

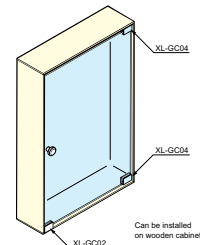
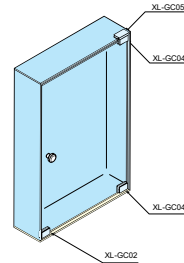

**XL-GC01 CR**  
Glass Lock  
Double Door

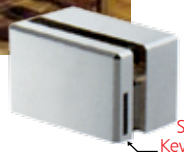

**XL-GC02 CR**  
Glass Lock  
Single Door



**XL-GC04 CR**  
Glass Hinge



**XL-GC05 CR**  
Bracket For  
Glass Panel



**XL-GC09 CR**  
Magnet Catch  
Set



## Glass / glass hinge 5 - 8 mm thickness

- Glass on glass application
- For inset and overlay doors
- New 3D adjustment

No.			
<b>334GG81 N</b>		270°	3
<b>336GG81 N</b>		220°	3



## Glass / wood hinge 5 - 8 mm thickness

- Glass on wood application for wood and steel furniture
- For inset and overlay doors
- New: 3D adjustment

No.			
<b>334HG81 N</b>		230°	3
<b>336HG81 N</b>		180°	3