

## Termination Products

Acromag provides a broad selection of hardware accessories to simplify the use of our I/O boards. This collection of panels, cables, and adapters facilitate field wiring and cable connections between boards within the card cage.

Model #	Description	Page
<b>Termination Panels</b>		
5025-288	DIN rail-mount, 68 screw terminals, SCSI-3 cable connection	<a href="#">.GO</a>
5025-552	DIN rail-mount, 50 screw terminals, 50-pin header cable connection	<a href="#">.GO</a>
5028-378	DIN rail-mount, 50 screw terminals, SCSI-2 cable connection	<a href="#">.GO</a>
<b>Cables</b>		
5025-275	Flat cable, unshielded, 50-pin female and P2 connectors	<a href="#">.GO</a>
5025-550	Flat cable, unshielded, 50-pin female connectors at both ends	<a href="#">.GO</a>
5025-551	Flat cable, shielded 50-pin female connectors at both ends	<a href="#">.GO</a>
5028-372	Round cable, shielded, CHAMP and SCSI-2 connectors	<a href="#">.GO</a>
5028-432	Round cable, shielded, 68-pin SCSI-3 connectors	<a href="#">.GO</a>
5028-438	Round cable, shielded, 50-pin SCSI-2 connectors	<a href="#">.GO</a>
<b>Transition Modules</b>		
TRANS-200	Transition module, 6U, VME64	<a href="#">.GO</a>
TRANS-C100	Transition module, 3U, cPCI	<a href="#">.GO</a>
TRANS-C200	Transition module, 6U, cPCI	<a href="#">.GO</a>
TRANS-GP	Transition module, 6U, VME	<a href="#">.GO</a>
<b>Technical Illustrations</b>		
	Termination panels	<a href="#">.GO</a>
	Signal cables	<a href="#">.GO</a>
	Transition modules	<a href="#">.GO</a>

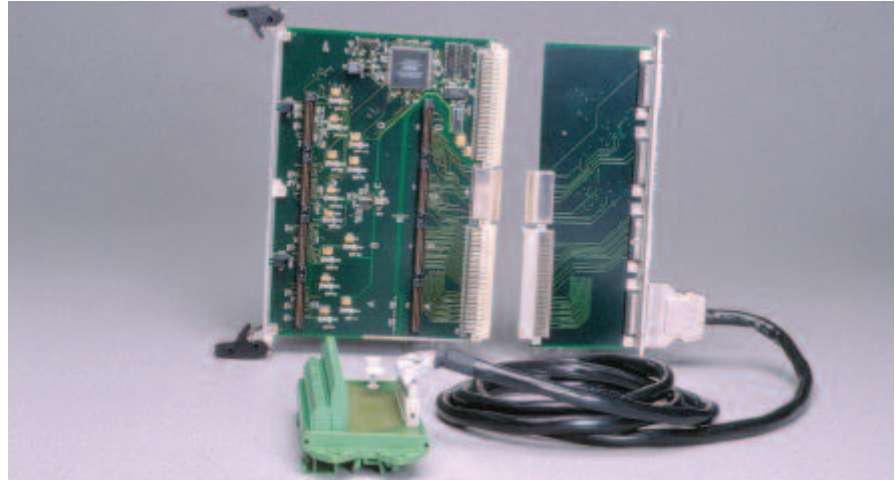

### Termination Panels

Termination panels provide screw terminals for easy field signal wiring. A cable connector provides a clean interface to the I/O board or mezzanine module. Many termination panels have a compact footprint and mount neatly on a DIN rail strip. Other panels are designed for mounting directly onto a standard 19-inch computer rack.

All of Acromag's I/O boards have a corresponding termination panel. This convenience saves you the time and hassle of finding a compatible panel or crafting your own.

### Cables

Acromag also provides a large selection of signal cables to complete the connection of the field wiring on the termination panel to the I/O board. We offer you a wide assortment of ribbon cables to accommodate the various pin and connector configurations. Cables range from simple 50-pin headers (shielded or unshielded) to high-speed SCSI cables. Cable support is available for all of Acromag's analog I/O, digital I/O and serial communication boards.

### Transition Modules

These adapters provide a solution for controlling the location of your cabling within the card cage. Transition modules repeat field I/O connections on Acromag's VME, VME64, and cPCI carrier boards for front or rear exit from the card cage. They can only be used with crates specifically designed for the use of 80mm transition modules.

All trademarks are the property of their respective owners.

## Industry Pack Accessories

Models	Description	PCI Carrier Cards		CompactPCI Carrier Cards			VME Carrier Cards					Notes
		APC8620	APC8621	AcPC8625	AcPC8630	AcPC8635	AVME9630	AVME9660	AVME9668	AVME9670	AVME9675	
5025-550	Ribbon Cable	R	R			R	R	R				
5025-551	Ribbon Cable	R	R			R	R	R				Shielded (analog Industry Packs).
5028-372	SCSI-2 to Champ Cable				R							Shielded.
5028-438	SCSI-2 to SCSI-2 Cable			R					R	R	R	Shielded.
TRANS-GP	Transition							A				
TRANS-200	Modules									R	R	
TRANS-C100						R						
TRANS-C200				R								
5025-552	Termination	R	R			R	R	R				
5028-378	Panels			R	R				R	R	R	

### Chart Legend

R = Recommended for use with carrier.      A = Available.

## PMC Accessories

Models	Description	Cables		Termination Panels	
		5028-432	5028-438	5025-288	5028-378
PMC230			•		•
PMC330			•		•
PMC341			•		•
PMC408			•		•
PMC424		•		•	
PMC440			•		•
PMC464		•		•	
PMC48x		•		•	
PMC520		•		•	
PMC521		•		•	
PMC730		•		•	
PMC-DXxxx		•		•	

## CompactPCI Accessories

Models	Description	Cables		Termination Panels	
		5028-432	5028-438	5025-288	5028-378
AcPC330	cPCI Boards		•		•
AcPC341			•		•
AcPC424		•		•	
AcPC464		•		•	
AcPC482		•		•	
AcPC483		•		•	
AcPC484		•		•	
AcPC730		•		•	

## PCI Accessories

Models	Description	Cables		Termination Panels	
		5028-432	5028-438	5025-288	5028-378
APC330	PCI Boards		•		•
APC341			•		•
APC424		•		•	
APC464		•		•	
APC482		•		•	
APC483		•		•	
APC484		•		•	
APC730		•		•	

All trademarks are the property of their respective owners.

## Ordering Information

### Termination Panels

For technical illustrations see [documentation](#).

#### 5025-288

DIN rail-mount panel with 68 screw terminals for field I/O connections and SCSI-3 connector for I/O board connections.

#### 5025-552

DIN rail-mount panel with 50 screw terminals for field I/O connections and 50-pin connector for I/O board connections.

#### 5028-378

DIN rail-mount panel with 50 screw terminals for field I/O connections and SCSI-2 connector for I/O board connections.

### Cables

(specify x = length in feet, 12 feet max. Three standard lengths -4, -7, and -10 which are available from stock. Custom lengths are available but will require extra lead time)

For technical illustrations see [documentation](#).

#### 5025-550-x

Flat cable, unshielded, 50-pin female connectors at both ends. Recommended for digital I/O applications.

#### 5025-551-x

Same as 5025-550 above except shielded. Recommended for best performance with analog I/O applications.

#### 5028-372

Round cable, shielded, 6 ft. long, SCSI-3 68-pin connector at both ends.

#### 5028-432

Round cable, shielded, 6 ft. long, SCSI-2 connector at one end and CHAMP 0.8mm connector at other end.

#### 5028-438

Round cable, shielded, 6 ft. long, SCSI-2 50-pin connector at both ends.

### Transition Modules

For technical illustrations see [documentation](#).

#### TRANS-200

80mm VME64 transition module for AVME967x IP carriers. Brings 200 I/O points from backplane out four 50-pin SCSI-2 connectors at rear of card cage.

#### TRANS-C100

80mm cPCI transition module for AcPC8635 carrier. Brings 100 I/O points from backplane to two 50-pin SCSI-2 connectors at the rear of the card cage.

#### TRANS-C200

80mm cPCI transition module for AcPC8625 carrier. Brings 200 I/O points from backplane to four 50-pin SCSI-2 connectors at the rear of the card cage.

#### TRANS-GP

80mm VME transition module for use with Motorola MVME162 or Acromag AVME9660. Enables I/O connections to a termination panel from front or rear of the card cage. Does not connect to backplane.



Acromag offers a variety of cables to complete your system.

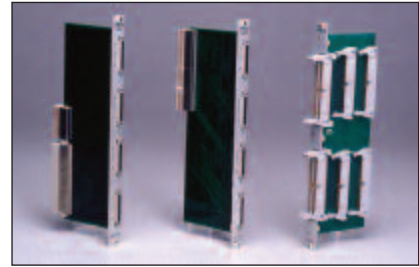

Transition modules simplify I/O connections in the rear of a card cage. From left: TRANS-200, TRANS-C200, TRANS-GP

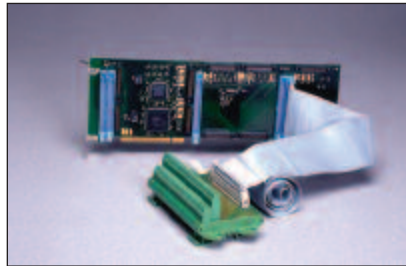

The 5025-552 termination panel and 5025-550 signal cable make field I/O connections to the APC8620 carrier easy.



AVME9670 with TRANS-200, 5028-438, and 5028-378.

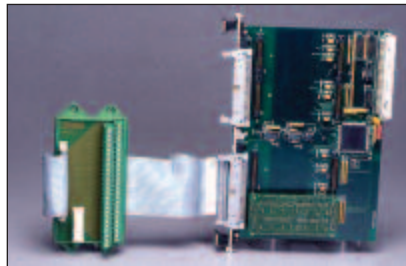

Attach up to four 5025-552 panels and 5025-550 cables to bring I/O connections out the front of an AVME9660 carrier.



AcPC8625 with TRANS-C200, 5028-438, and 5028-378.

All trademarks are the property of their respective owners.

## 5025-288 Termination Panel

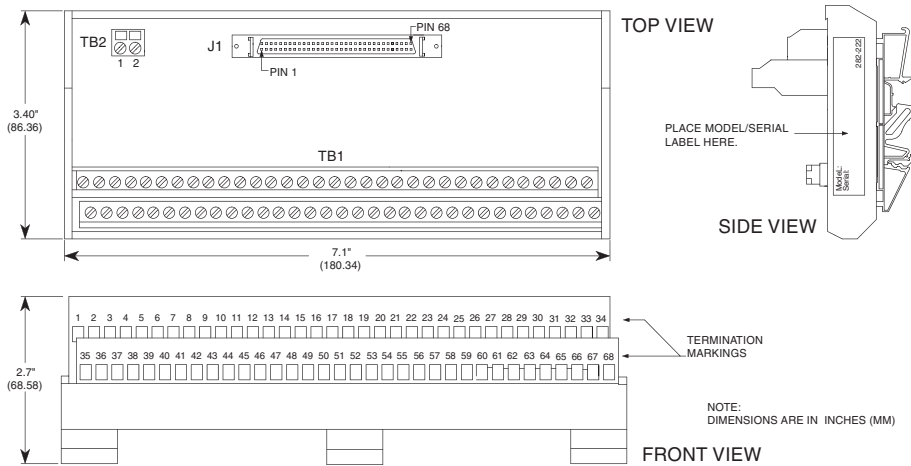

## 5025-552 Termination Panel

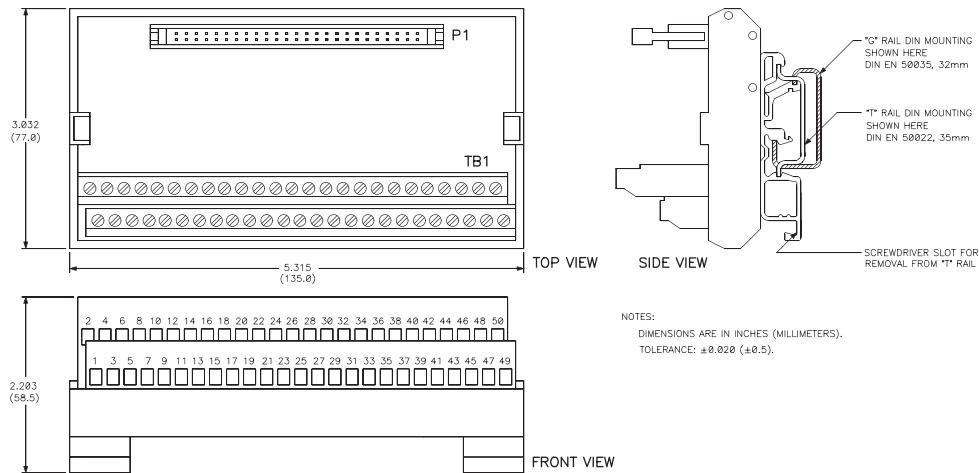

## 5028-378 Termination Panel

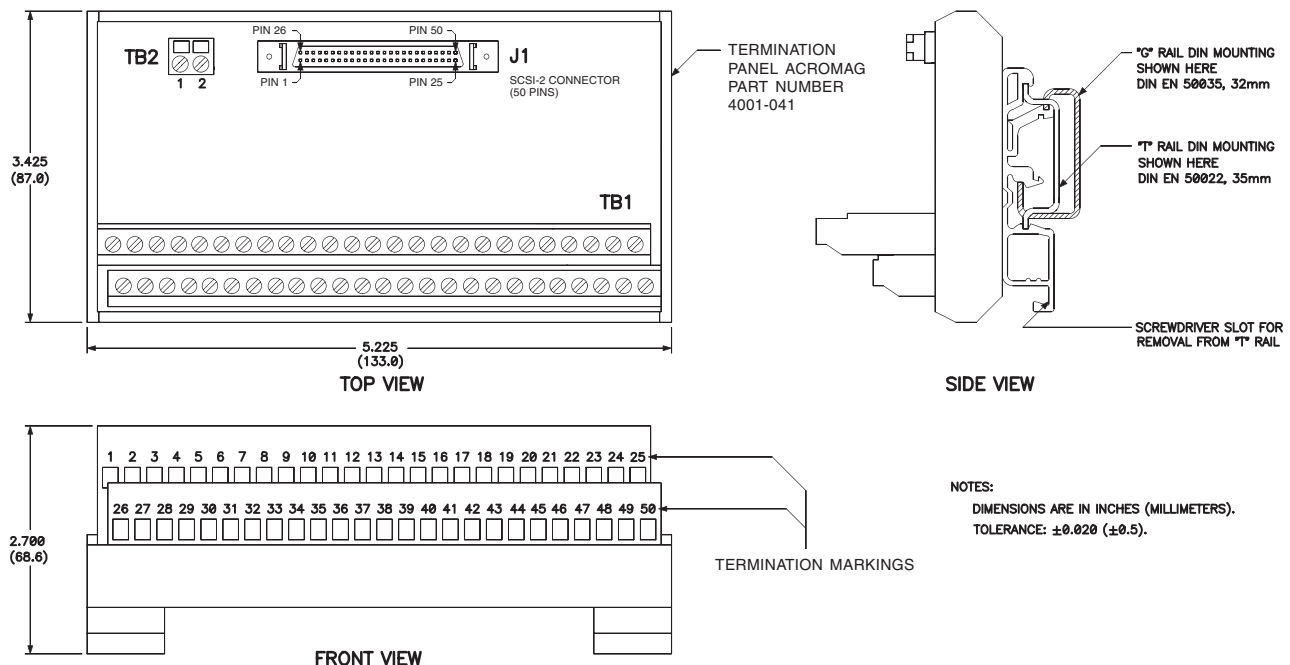

## 5025-550/551 Cable

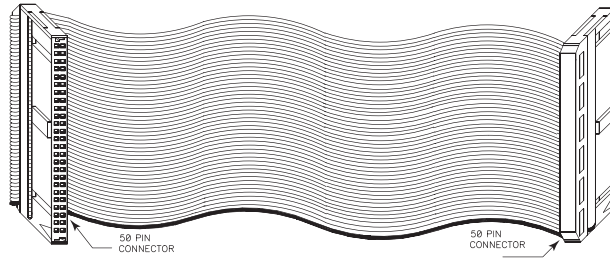

## 5028-372 Cable

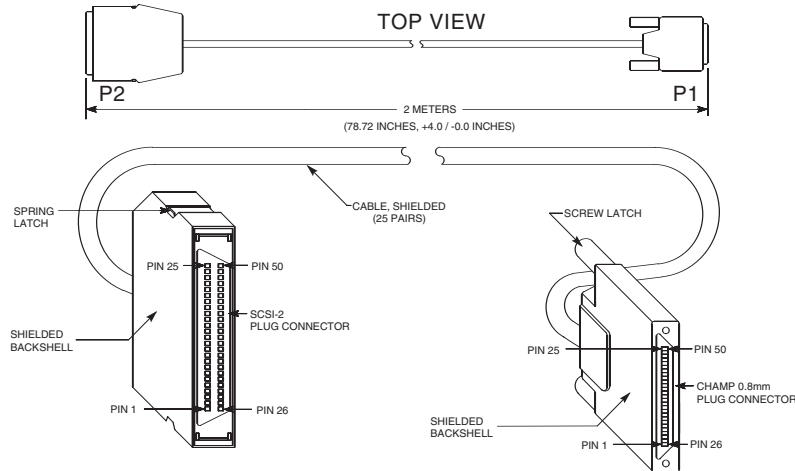

## 5028-432 Cable

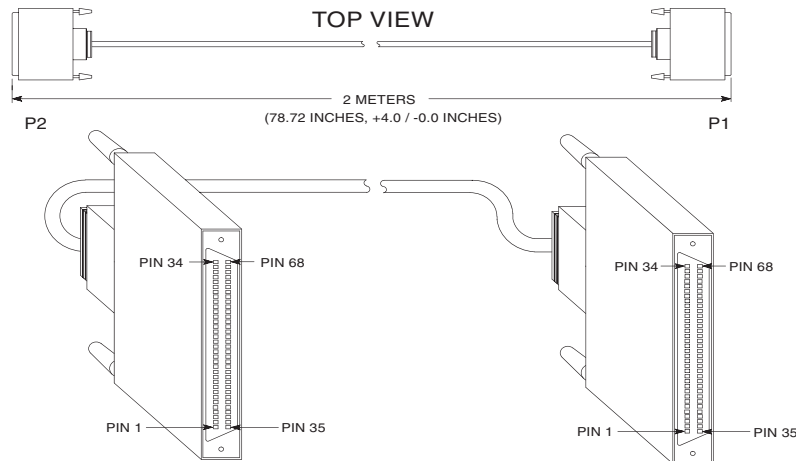

## 5028-438 Cable

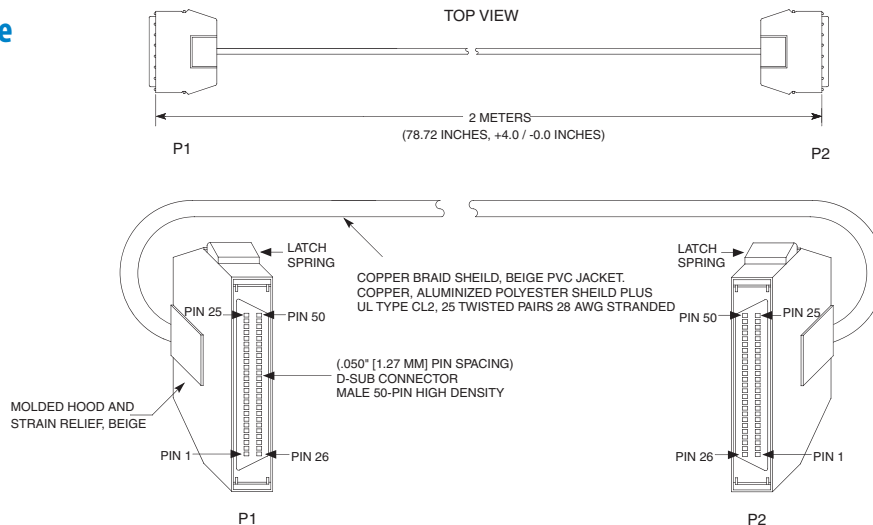

## TRANS-200 Transition Module

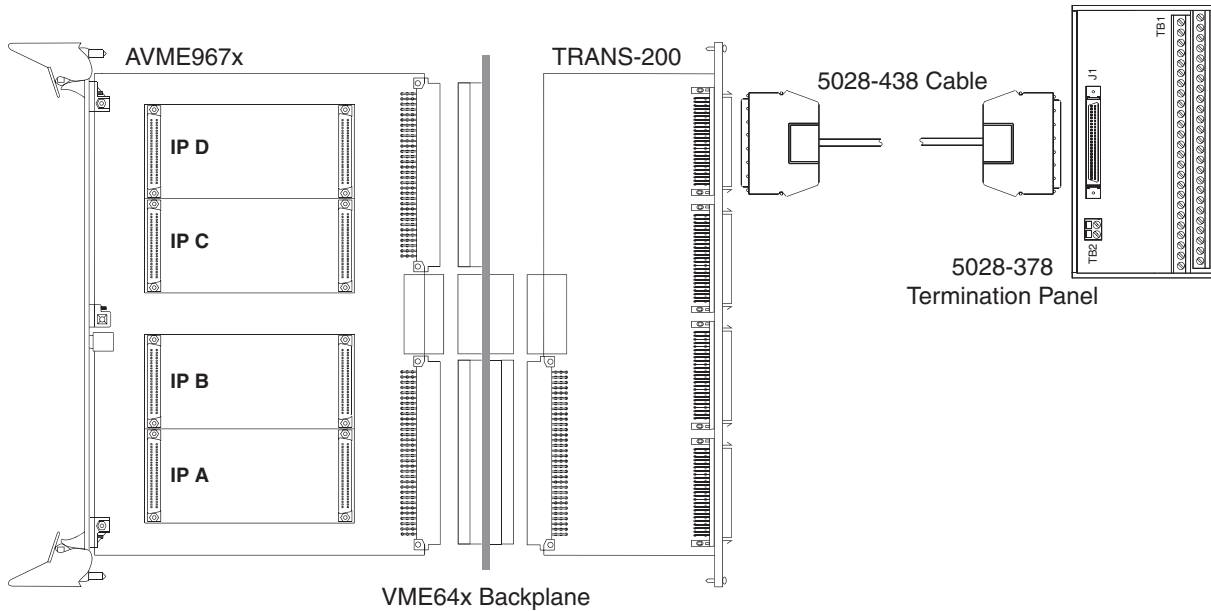
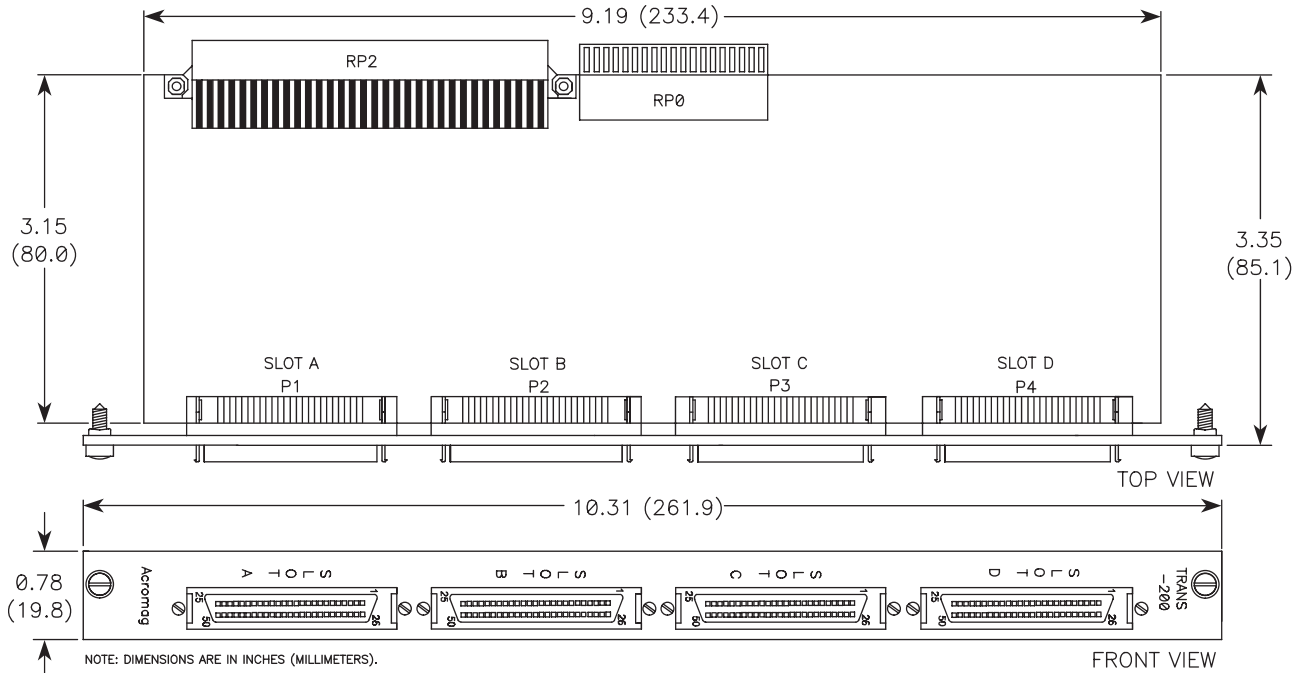

## TRANS-C200 Transition Module

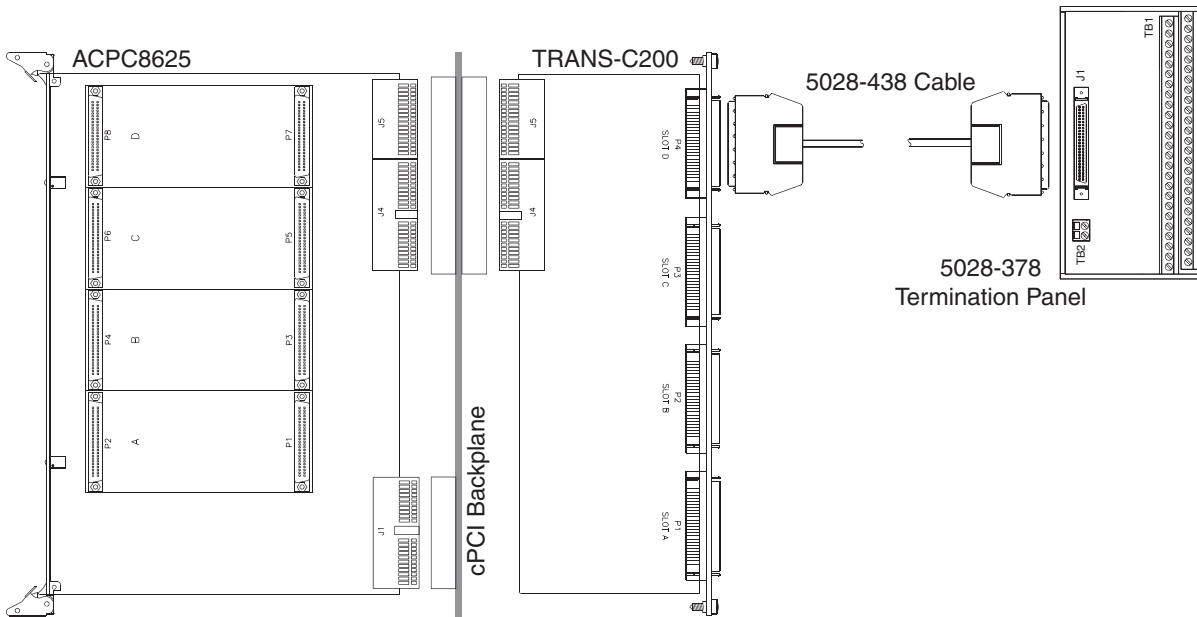
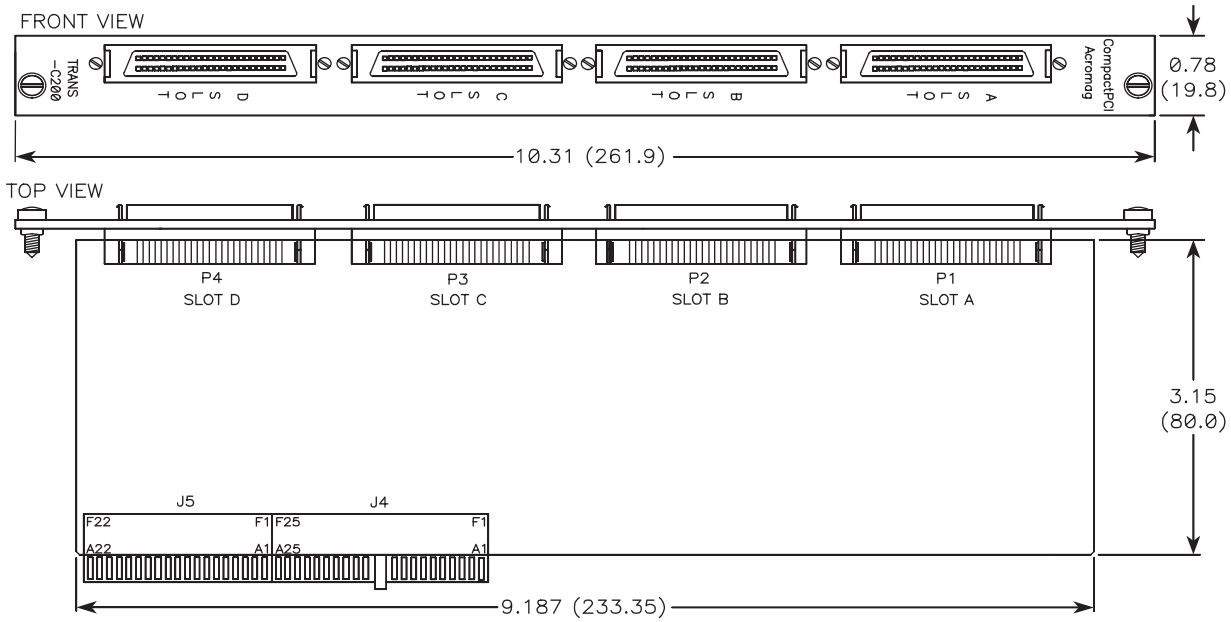

All trademarks are the property of their respective owners.

## Model TRANS-C100

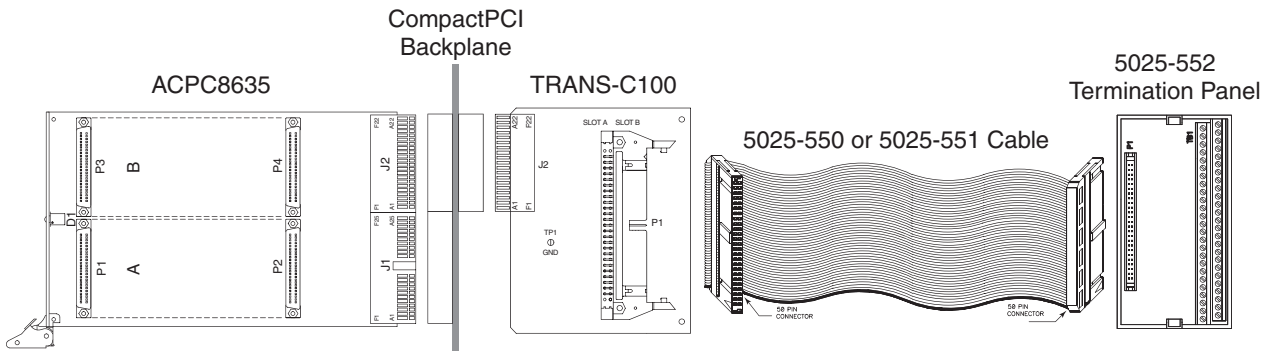
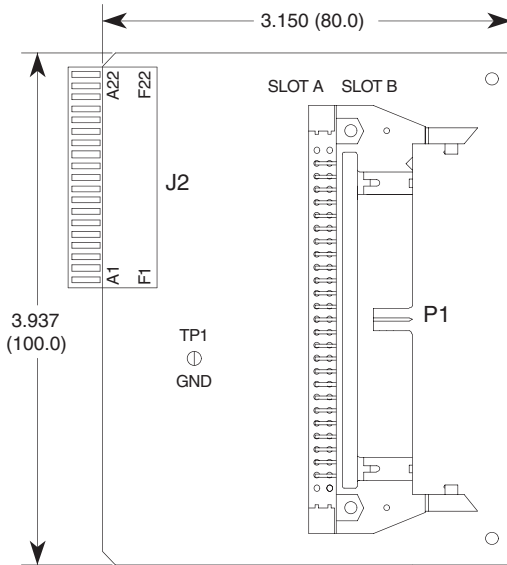



## TRANS-GP Transition Module

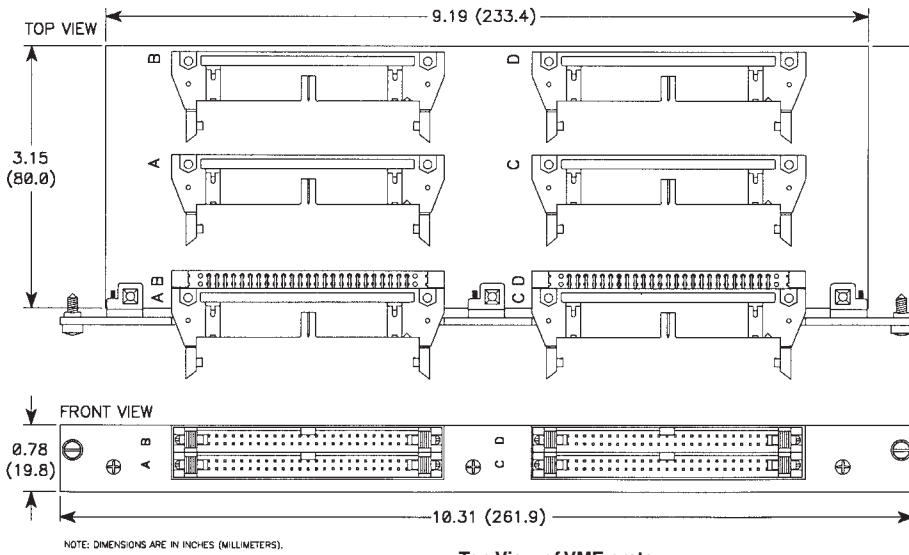

Front View of Card Cage

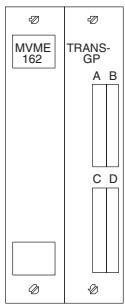

Top View of Card Cage

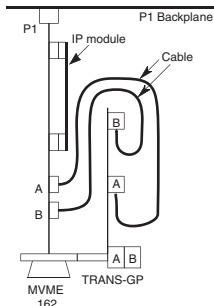

Top View of VME crate

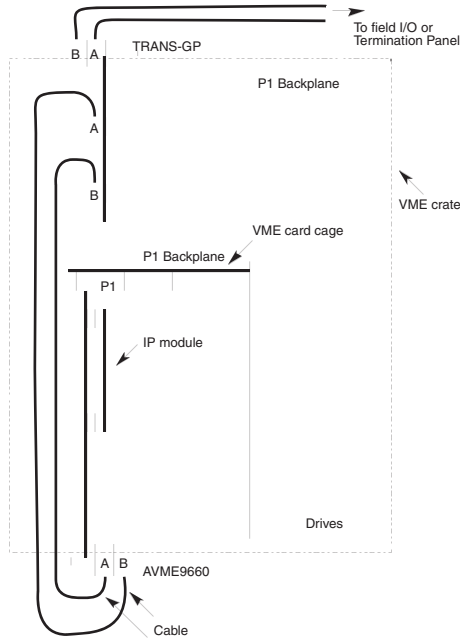

## Models PMC330, PMC341, PMC424, PMC464, PMC48x, PMC520, PMC521, PMC730, PMC-AXxxx, PMC-DXxxx

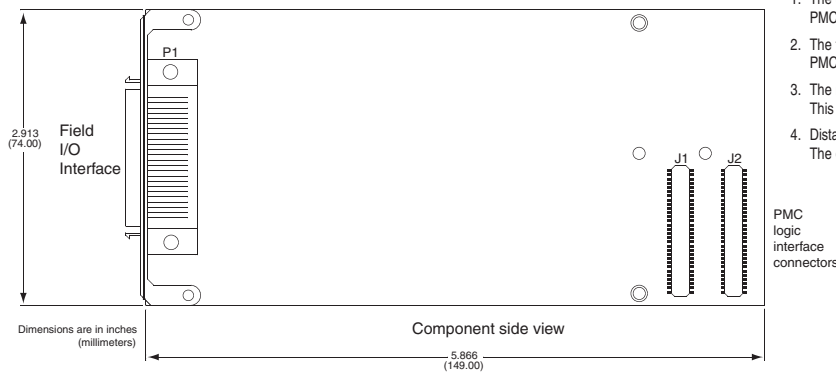
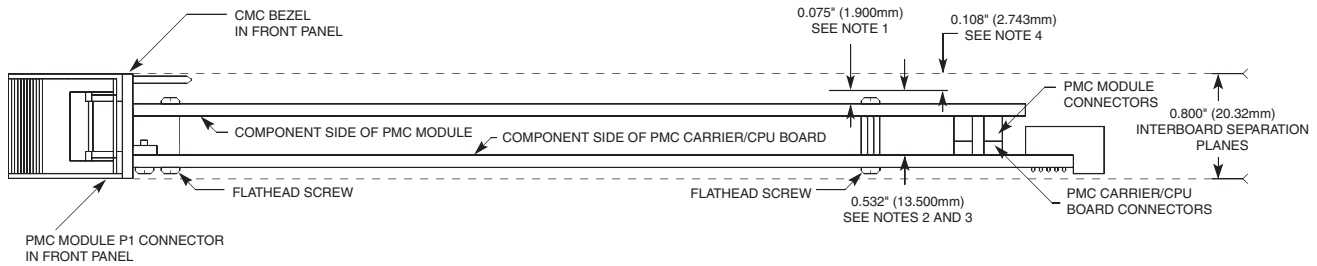

1. The usable space on the solder side of the PMC module is 0.075" (1.900mm) per PMC Mechanical Standard P1386.1. This PMC module is within limits.
2. The total height off the PMC carrier/CPU board is 0.532" (13.500mm) per PMC Mechanical Standard P1386.1. This PMC module is within limits.
3. The maximum component height for VME and CompactPCI is 0.540" (13.720mm). This PMC module is within limits.
4. Distance to interboard separation plane is 0.108" (2.743mm). The desired spacing is 0.100" (2.540mm) for VME and CompactPCI.

## Models PMC230, PMC408, PMC440

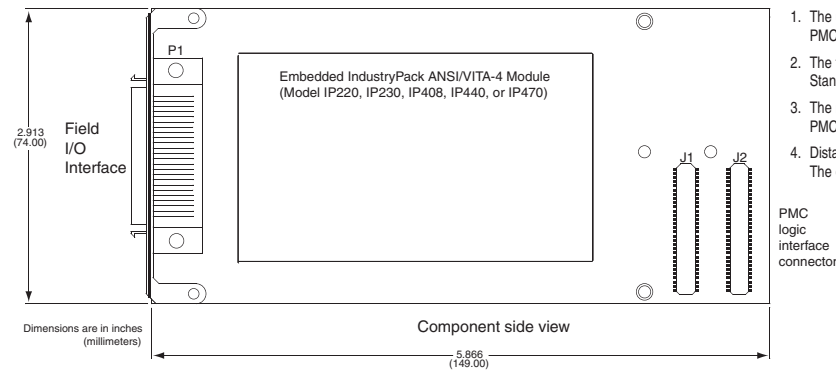
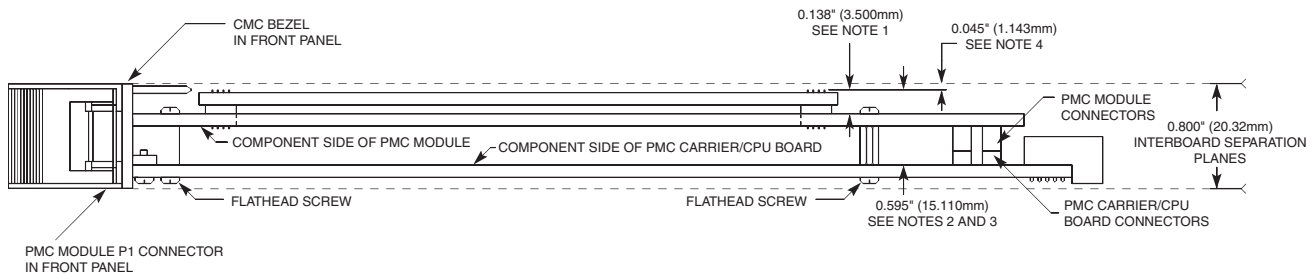

1. The usable space on the solder side of the PMC module is 0.075" (1.900mm) per PMC Mechanical Standard P1386.1. This PMC module exceeds this by 0.063" (1.600mm).
  2. The total height off the PMC carrier/CPU board is 0.532" (13.500mm) per PMC Mechanical Standard P1386.1. This PMC module exceeds this by 0.063" (1.600mm).
  3. The maximum component height for VME and CompactPCI is 0.540" (13.720mm). This PMC module exceeds this by 0.055" (1.400mm).\*
  4. Distance to interboard separation plane is 0.045" (1.143mm). The desired spacing is 0.100" (2.540mm) for VME and CompactPCI.
- \* Adequate clearance must be determined for the application.

All trademarks are the property of their respective owners.