



HATSAN
ARMS COMPANY

Serious. Solid. Impact.



HATSAN BLITZ PCP AIR RIFLE

INSTRUCTION MANUAL

PLEASE READ THIS MANUAL BEFORE USING YOUR AIR GUN

| CONTENTS | PAGE |
|------------------------------|-------------|
| SPECIFICATIONS | 3 |
| BASIC PARTS OF YOUR GUN | 4 |
| MANUAL SAFETY | 4 |
| REAR SIGHT ADJUSTMENT | 4 |
| COMFORT ADJUSTMENTS | 5 |
| OPERATING INSTRUCTIONS | 5 |
| LOADING THE RIFLE & SHOOTING | 6 |
| MAINTENANCE | 8 |
| SAFETY MEASURES & WARNINGS | 9 |

Thank you for choosing HATSAN Blitz PCP air rifle!

Always use caution when operating this air rifle. Learn and obey the laws of your local municipality, state, and/or country. Demonstrate responsibility while using this air rifle. Please read the entire manual very carefully before use. Any damage or injury resulting from misuse or incorrect handling is the sole responsibility of the owner.

This rifle allows you to fire multiple pellets and makes shooting a lot more fun giving you more chances to hit your target. This air rifle is cocked and reloaded all at once upon the pulling of the trigger. Squeezing the trigger not only opens the air valve to fire the loaded pellet, it also automatically loads the next round and resets the air valve. This enables you to shoot pellets one after another as quickly as you are able to pull the trigger and not have to reload until the rotatory clip is empty.

Warning!

- Each Hatsan PCP air rifle contains pressurized air and should only be dismantled by a competent gunsmith. Otherwise serious damage/injury/death may be caused to you or others. The air rifle may also become damaged. Never attempt to dismantle the air bottle or air gauge when the air bottle is fully or partially charged. Serious injury/death/damage may result if these instructions are ignored.
- Use only factory manufactured pellets that are no longer than the thickness of the rifle's magazine. Do not use BB ammunition with your rifle.
- Hatsan PCP air rifles are designed specifically for use with dry compressed air. NO OTHER GAS OR GAS COMBINATION CAN BE USED.

The rifle may be filled from a diver's bottle or a suitable compressor, MAXIMUM SAFE WORKING PRESSURE (SWP): 250 BAR

Section I. SPECIFICATIONS

| Model | | Blitz | | |
|--|--------|--|-----------------|-----------------|
| Caliber | | 5.5mm / .22cal | 6.35mm / .25cal | 7.62mm / .30cal |
| Max. Muzzle Velocity (*) | | 320m/s(1050fps) | 295m/s(970fps) | 221m/s(730fps) |
| Energy (*) | Joules | 49 | 56 | 71.8 |
| | ft.lbs | 36 | 41 | 53 |
| Magazine Capacity | | 21 | 19 | 16 |
| Air Tube Volume | | 580cc | | |
| Fill Pressure | | 250 BAR | | |
| Number of Semi Auto or Full Auto Shots at Optimal Velocity | | 130 | 110 | 100 |
| Stock | | Tactical Synthetic Stock. Ergonomic Pistol Grip. Elevation adjustable Cheek-Rest. | | |
| Overall Length | | 1150mm (45.2") | | |
| Barrel Length | | 585mm (23") | | |
| Weight | | 4kg (8.8lbs) | | |

* Velocity results may vary as much as 20% due to pellet weight, pellet shape, temperature, elevation, as well as other factors.

** Minimum 100 bar pressure necessary for full auto or semi auto action.

Section II. BASIC PARTS OF YOUR GUN

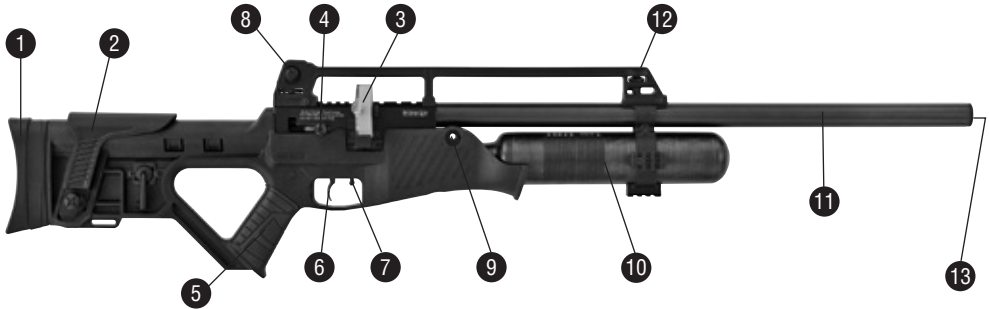

- | | | |
|--------------------|--------------------------|------------------------|
| 1. Butt Pad | 6. Trigger | 11. Barrel with Shroud |
| 2. Adjustable Comb | 7. Safety | 12. Front Sight |
| 3. Magazine | 8. Adjustable Rear Sight | 13. Muzzle |
| 4. Bolt Lever | 9. Filling Hole | |
| 5. Grip | 10. Air Bottle | |

Section III. MANUAL SAFETY



Fig. 1



Fig. 2

Safety lever can be set to 'ON' and 'OFF' position manually.

To set the safety to 'ON', pull safety lever to the rear. In this position, the trigger cannot be pulled and the gun cannot be fired. (Fig. 1)

To remove the safety to 'OFF', push safety lever forward. In this position, the gun is ready to shoot. (Fig. 2)

CAUTION: Until you are actually ready to shoot, keep the safety button in the "ON" position (Fig. 1).

Section IV. REAR SIGHT & FRONT SIGHT ADJUSTMENT

Rear Sight Windage adjustment - (Fig. 3-A)

If the shot is left of the target, turn the **KNOB#1** clockwise.

If the shot is right of the target, turn the **KNOB#1** counter-clockwise.

Rear Sight Elevation adjustment

If the shot is too high, turn **KNOB#2** counter-clockwise.

If the shot is too low, turn **KNOB #2** clockwise.

Front Sight Elevation adjustment - (Fig. 3-B)

If the shot is too high, turn **KNOB #3** clockwise.

If the shot is too low, turn **KNOB #3** screw counter-clockwise.

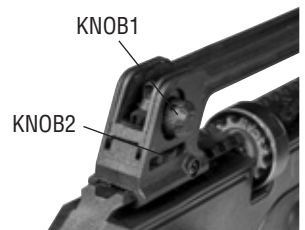

Fig. 3A

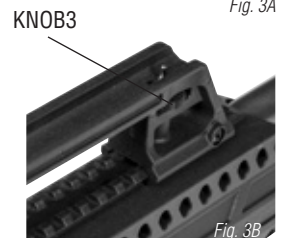

Fig. 3B

Section V. COMFORT ADJUSTMENTS

Comb Adjustment: Hatsan Blitz is equipped with an adjustable height comb. Loosen the comb adjustment knob (Fig. 4), and set your desired height before tightening. On the Hatsan BullMaster, depress the comb adjustment button and set your desired height before releasing the button.

Butt Pad Adjustment: The butt pad is adjustable for height and it rotates slightly, providing you the perfect height and angle of the butt pad. In order to adjust the butt pad, simply loosen the bolt in the butt pad with a suitable hex wrench; and raise or lower it according to shooting preference. Then tighten the bolt. (Fig. 4)



Fig. 4

Section VI. OPERATING INSTRUCTIONS:

Warning!

- Use caution when operating the Blitz series from the left handed shooting position. The bolt located on the right hand side of the rifle cycles with each shot fired and may cause injury if operated left handed.
- Before filling the air cylinder; make sure the safety is in the ON position, no pellets are loaded in the air rifle and/or barrel and magazine is not mounted in the gun. If the air bottle is completely empty; fill in air bottle after cocking the gun and keeping the cocking handle/bolt lever open at the rear.
- Take all safety measures before filling the air bottle. It is compulsory for the user and bystanders to wear eye & ear protection when filling the air bottle.
- While filling in the air bottle; the pressure in it must be monitored from the air gauge of the hand pump or scuba charging kit. Do not look at the air gauge on the air rifle during filling process. Instead, reference the gauge on your fill device.

Pull the bolt lever backwards until it stops and locks at the back. Keep the bolt lever locked at the rear. (Fig. 5)

THIS OPERATION COCKS THE TRIGGER MECHANISM/HAMMER ASSEMBLY

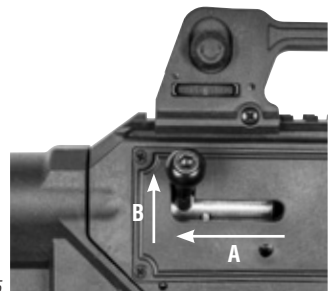
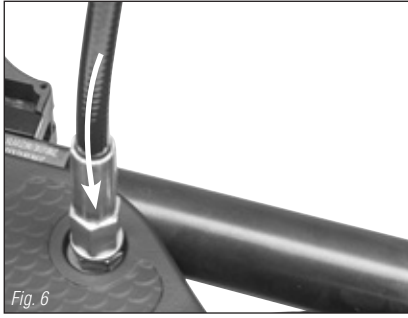

Fig. 5



Fit the filler nozzle to the air-line of the charging equipment, which must incorporate a pressure gauge. Ensure both filler nozzle and rifle filler hole are clear from dirt and gently push the nozzle into the filler hole. **(Fig. 6)** Fill the air tube up pressure quoted previously in this manual. Do not exceed the maximum fill pressure as this will reduce the muzzle velocity of the pellets and may damage pistol components which may cause danger to you and others around you. When using the diver's bottle, refill the rifle slowly to prevent the heat created by the filling process from damaging the rifle's components. Undo the bleeder valve on the hose before disconnecting the fill nozzle from the rifle.



Fig. 7A



Fig. 7B

Selectable Firing Mode Switch (only in countries where allowed)

- For semi auto action, rotate selector switch to **SEMI** position. (Fig.7A)
- For full auto action, rotate selector switch to **FULL** position. (Fig.7B)

Loading the Rifle and Shooting

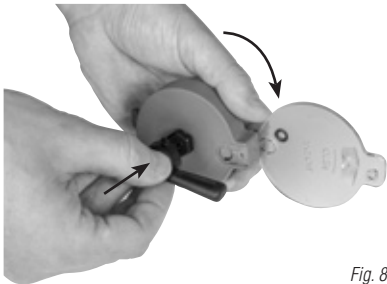

Fig. 8

1. The magazine is composed of a rear side (clear cover) and a front side. The magazine is designed to be allowed to fit only one way into the rifle.
2. Swing the clear cover counter-clockwise and open it. Place the winding tool onto the hexagonal hub on the back of the magazine. **(Fig. 8)**
3. With your thumb, twist the winding tool counter clockwise and hold it. With your other hand load one pellet (with its skirt upwards) in the magazine, inline with the opening of the magazine body. This will hold the magazine in the wound position. **(Fig. 9A)**
4. Load the remaining pellets into the other open locations in the magazine **(Fig.9B)** and return the magazine cover to the fully-closed position. Be sure that the protrusion on the

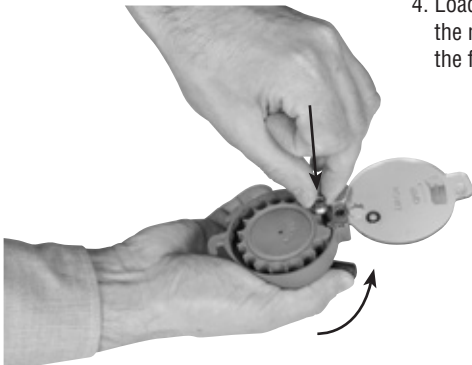

Fig. 9A

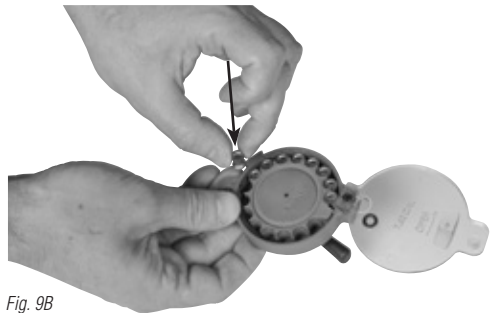

Fig. 9B

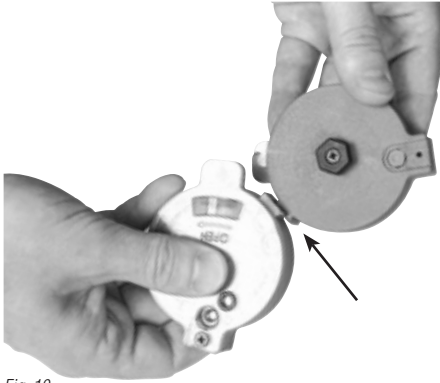

Fig. 10

In the full auto firing mode, the rifle will continue shooting all the pellets in the magazine or until you release the trigger. In the semi auto firing mode, pulling the trigger will re-cock the bolt at the same time and you can shoot the next round by releasing and pulling the trigger again.

cover seats fully into the slot of the magazine body.
 5. If you would like, you can load a second magazine and attach to magazines to each other as shown in (Fig. 10)

6. With the clear cover facing the butt of the rifle insert the magazine from the right side of the rifle and push it inwards all the way in until it's fully in place. (Fig. 11A & 11B)

DO NOT RELEASE THE BOLT LEVER UNTIL YOU ARE READY TO FIRE.

7. Once you are ready to fire, release the bolt lever and move it all the way forward. (Fig. 12)

8. Aim at your intended target, disengage the safety and get ready to shoot.

9. Pull the trigger and the rifle will fire. In the full auto firing mode, the rifle will continue shooting all the pellets in the magazine or until you release the trigger. In the semi auto firing mode, pulling the trigger will re-cock the bolt at the same time and you can shoot the next round by releasing and pulling the trigger again.



Fig. 11A

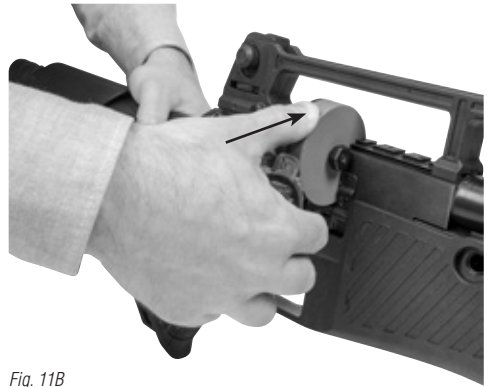

Fig. 11B



Fig. 12

Warning!

- Your rifle is able to shoot as a semi-automatic rifle or a full-automatic rifle as long as the pressure inside the air bottle is above 100 bars.
- Make sure the bolt lever is closed fully before you shoot.
- In case of a malfunction, pull the bolt lever, remove the magazine and squeeze the trigger aiming your rifle in a safe direction. Then insert the magazine again.
- Never re-cock your rifle without shooting. Each time you re-cock the bolt lever without firing, it will feed a pellet into the barrel, which will lead to a pellet accumulation inside the barrel.
- If shooting does not happen after squeezing the trigger, immediately remove the magazine and pull the trigger pointing your rifle in a safe direction. Otherwise you may accidentally leave a pellet in the barrel.

Section VII. MAINTENANCE

Warning!

Never attempt to disassemble this rifle. Never fire the rifle when the air in the cylinder is removed. Failure to obey this instruction could result in damage to your rifle.

Never lubricate inside the barrel as this will affect the accuracy & grouping of the rifle in negative manner. Occasionally apply proper mineral based oils sparingly to the following parts:

- The trigger mechanism
- The pellet probe
- The cocking lever sliding surface

DO NOT OVER-LUBRICATE THE RIFLE!

- It is recommended to clean the barrel with a cleaning rod every 500-1000 shots. Never lubricate inside the barrel.
- Before you begin oiling or cleaning your air gun, always check to make sure it is unloaded.
- Always be sure your gun barrel is clean and not blocked.
- After cleaning ensure that no cleaning patch or other obstruction remains in the barrel.
- Annually, take your air gun to a gunsmith even if it seems to be working well, since some issues in your gun may not be apparent from external examination.
- Take your air gun to a gunsmith if water, sand, etc. enters the internal mechanism of the air gun, for complete cleaning.
- Dangerous conditions may occur if you do not keep your air gun clean and working properly.

QUICK FILL NOZZLE O-RINGS REPLACEMENT

- After a period of time, the O-rings on the fill nozzle will need to be replaced. The need for the replacement will become noticeable if air is heard leaking from the nozzle or the nozzle is ejected from the port while charging the rifle. Always replace both O-rings.

Safety Measures & Warnings

- This air gun will fire if cocked, loaded, safety disengaged and trigger pulled.
- Air guns are not toys. Never let young children use an air gun unsupervised. Adult supervision is strictly required during use. Misuse or careless use may cause serious injury or death.
- This is a high-powered airgun for use by those 16 years of age or older.
- Learn how your air gun operates and practice safe gun handling procedures before loading and using it.
- **ALWAYS USE EYE & HEARING PROTECTION AND MAKE BYSTANDERS USE THE SAME.** Failure to do so may result in eye injuries and permanent hearing loss.
- Do not point at anything you do not intend to shoot even though the gun is unloaded. Always keep the gun pointed in a safe direction.
- Never pull a gun toward you by the muzzle.
- Always aim at a safe target, taking care that it does not conceal any other object.
- Before you fire, consider where the pellet will travel should you miss your intended target, thus ensuring no damage or harm could result.
- Be sure of your target before you pull the trigger. Never shoot at sounds.
- When shooting, always have a safe shooting range, that is; have a safe area for shooting, a safe distance between you and the target, and a safe backstop to trap the pellets and hold the target.
- Do not fire at a target, which allows ricochets or deflections. Do not fire into or at water.
- Do not fire at or near power lines or insulators. Be especially careful in wooded areas where power lines may not be as visible.
- Do not load the gun until you are ready to shoot.
- Always keep your fingers away from the trigger & muzzle during cocking and handling.
- Do not walk, run or jump when carrying a loaded or cocked air gun. A loaded or a cocked gun should never be carried inside a vehicle, house, camp or public place. Never climb a tree or fence or jump a ditch with a loaded gun. In such a case, first unload it and hand the gun to a friend or place it on the ground on the other side of the obstacle before crossing yourself.
- When transporting the gun, keep it unloaded and 'on safe'.
- Always keep the gun 'on safe' until you are ready to shoot even if the gun is unloaded.
- Do not put the gun away loaded and unattended.
- Always check to see if the gun is 'on safe' and unloaded when getting it from

another person or from storage.

- Always keep the air gun and/or pellets out of the reach of children. Keep the air gun and pellets in separate places, better if under lock and key.
- Do not attempt to disassemble or tamper with your gun. Use a competent gunsmith. Many air guns contain powerful springs or high pressure air cylinders which can cause serious injury if released in an uncontrolled manner.
- Always handle and treat your gun as though it were loaded.
- Improper use or handling of air guns is not the responsibility of the manufacturer or distributor, under any circumstances. The user is responsible for any harm, which may be caused.
- Think first, fire second. Don't rely on any mechanical safety. Half safe is not safe.
- Be safe not sorry. Respect other's property.
- Air guns should never be used under the influences of alcohol or drugs.
- Do not brandish or display this product in public – it could confuse people and may be a crime.
- Do not change the coloration and markings to make it look more like a firearm.



Serious. Solid. Impact.

HATSAN

ARMS COMPANY

Kemalpasa O.S.B. Mah. Ansizca Sanayi Sitesi No: 303 Ic Kapi No: 1, 35170
Kemalpasa - Izmir - TURKEY
Tel: +90 (232) 878 91 00 • Fax: +90 (232) 878 91 02
www.hatsan.com.tr info@hatsan.com.tr