

Name: \_\_\_\_\_

School held a school supply sale. Jeannie sold 6 pencil cases. Sal sold 9 marker sets. Fred sold 4 boxes of crayons.

How many items did the friends sell in all?

Who sold the most items?

How many more items did Jeannie sell than Fred?

Name: \_\_\_\_\_

$\begin{array}{r} 7 \\ - 5 \\ \hline \end{array}$	$\begin{array}{r} 9 \\ - 2 \\ \hline \end{array}$	$\begin{array}{r} 9 \\ + 8 \\ \hline \end{array}$	$\begin{array}{r} 7 \\ + 3 \\ \hline \end{array}$	$\begin{array}{r} 7 \\ - 7 \\ \hline \end{array}$	$\begin{array}{r} 8 \\ + 7 \\ \hline \end{array}$	$\begin{array}{r} 3 \\ - 2 \\ \hline \end{array}$	$\begin{array}{r} 5 \\ - 3 \\ \hline \end{array}$	$\begin{array}{r} 9 \\ + 6 \\ \hline \end{array}$
---	---	---	---	---	---	---	---	---

$\begin{array}{r} 4 \\ - 4 \\ \hline \end{array}$	$\begin{array}{r} 8 \\ + 7 \\ \hline \end{array}$	$\begin{array}{r} 8 \\ - 5 \\ \hline \end{array}$	$\begin{array}{r} 4 \\ + 8 \\ \hline \end{array}$	$\begin{array}{r} 3 \\ + 6 \\ \hline \end{array}$	$\begin{array}{r} 4 \\ + 5 \\ \hline \end{array}$	$\begin{array}{r} 7 \\ + 9 \\ \hline \end{array}$	$\begin{array}{r} 5 \\ + 2 \\ \hline \end{array}$	$\begin{array}{r} 9 \\ - 2 \\ \hline \end{array}$
---	---	---	---	---	---	---	---	---

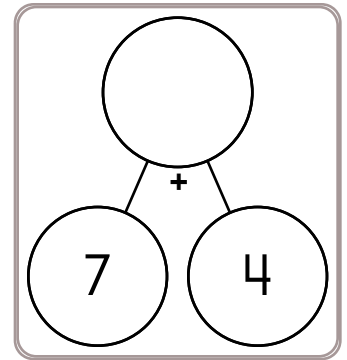
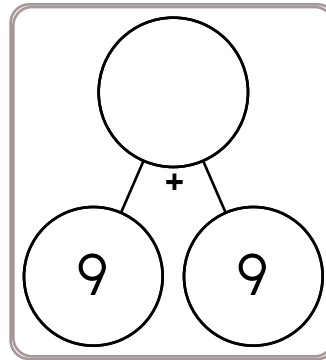
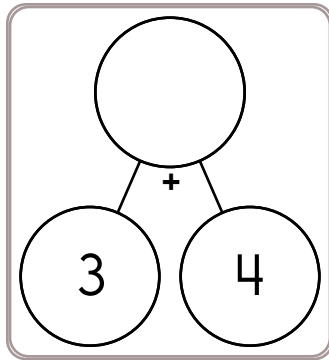
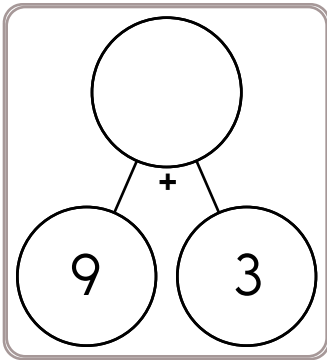
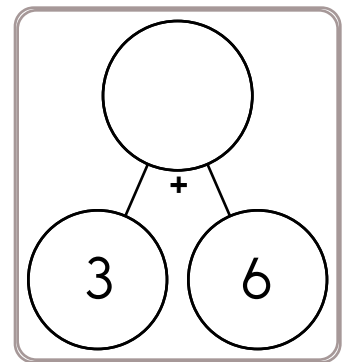
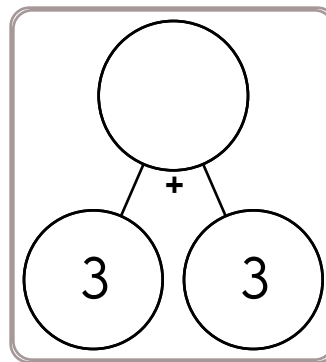
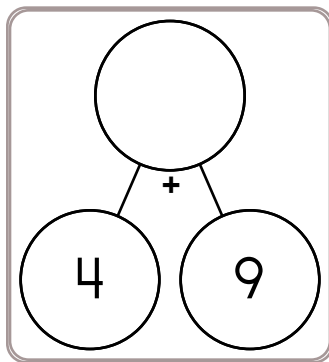
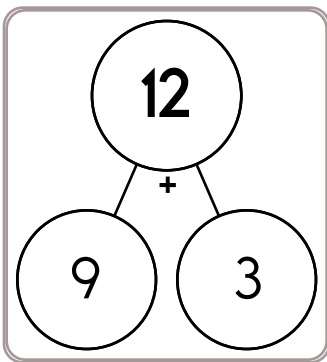

$5 - 4 =$

$5 - 3 =$

$9 - 6 =$

$7 - 4 =$

$8 - 4 =$

$7 - 5 =$

$8 - 2 =$

$4 - 3 =$

$7 - 2 =$

$9 - 7 =$

$9 - 6 =$

$7 - 4 =$

Name: \_\_\_\_\_

There were five bowls on the table. Maria put three popcorn balls in each bowl. How many popcorn balls were there in all?

Peter hit the ball 14 times. Eric hit the ball 11 times. How many times did they hit the ball in all?

It is very hot today. Robert drank seven cups of water. Adam drank two cups of tea. Gavin drank six cups of water. Max drank four cups of water. How many cups of water did the boys drink?

Dee has 7 games. Mike has 10 games. How many games do they have in all?

Write the missing days of the week.

Thursday, \_\_\_\_\_, Saturday

Wednesday, \_\_\_\_\_, Friday

Tuesday, \_\_\_\_\_, Thursday

Saturday, \_\_\_\_\_, Monday

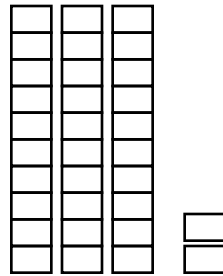

\_\_\_ tens \_\_\_ ones

Number = \_\_\_\_\_

p d e c y u  
b p h m e a  
c w m g s m  
l t m a k e

make

4 + 8 =

Count by 4s.

17

21

\_\_\_\_\_

4 + 4 =

5 + 6 =

6 + 8 =

2 + 2 =

Name: \_\_\_\_\_



$9 - \underline{\quad} = 5$

$\underline{\quad} - 5 = 3$

$7 - \underline{\quad} = 3$

$\underline{\quad} - 4 = 1$

$4 - \underline{\quad} = 1$

$\underline{\quad} - 5 = 1$

$\underline{\quad} - 2 = 6$

$6 - \underline{\quad} = 3$

$\underline{\quad} - 5 = 2$

$6 - \underline{\quad} = 2$

$\underline{\quad} - 2 = 1$

$8 - \underline{\quad} = 6$

$$\begin{array}{r} 8 \\ + 8 \\ \hline \end{array}$$

$$\begin{array}{r} 5 \\ - 4 \\ \hline \end{array}$$

$$\begin{array}{r} 6 \\ - 4 \\ \hline \end{array}$$

$$\begin{array}{r} 3 \\ + 2 \\ \hline \end{array}$$

$$\begin{array}{r} 9 \\ - 4 \\ \hline \end{array}$$

$$\begin{array}{r} 6 \\ - 3 \\ \hline \end{array}$$

$$\begin{array}{r} 4 \\ + 7 \\ \hline \end{array}$$

$$\begin{array}{r} 7 \\ + 9 \\ \hline \end{array}$$

$$\begin{array}{r} 8 \\ + 4 \\ \hline \end{array}$$

$$\begin{array}{r} 4 \\ + 2 \\ \hline \end{array}$$

$$\begin{array}{r} 5 \\ - 4 \\ \hline \end{array}$$

$$\begin{array}{r} 4 \\ + 4 \\ \hline \end{array}$$

$$\begin{array}{r} 4 \\ + 3 \\ \hline \end{array}$$

$$\begin{array}{r} 8 \\ - 2 \\ \hline \end{array}$$

$$\begin{array}{r} 8 \\ + 5 \\ \hline \end{array}$$

$$\begin{array}{r} 5 \\ + 7 \\ \hline \end{array}$$

$$\begin{array}{r} 6 \\ + 4 \\ \hline \end{array}$$

$$\begin{array}{r} 2 \\ + 7 \\ \hline \end{array}$$

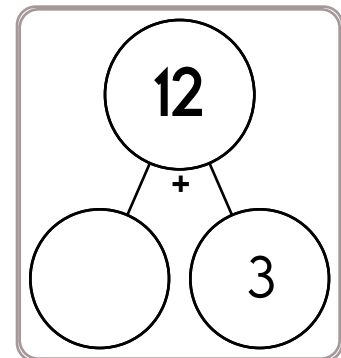
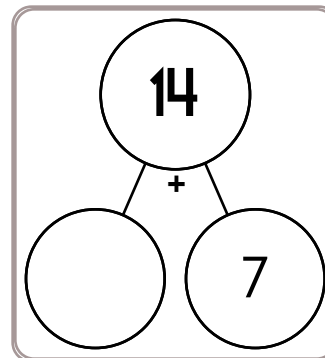
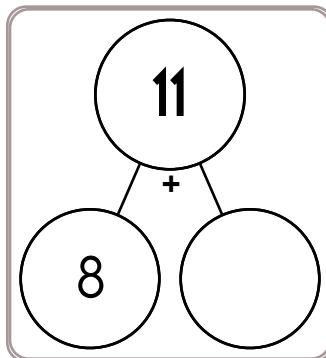
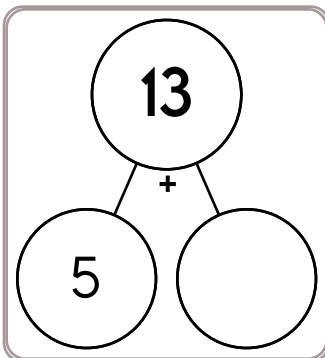
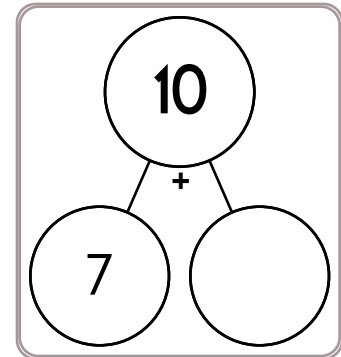
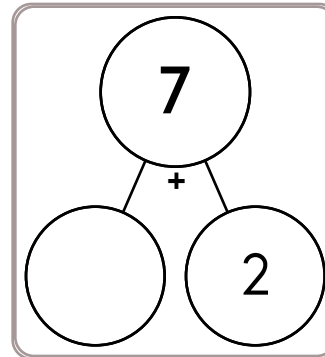
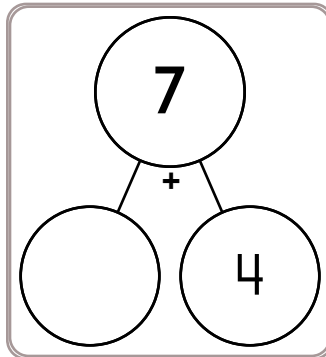
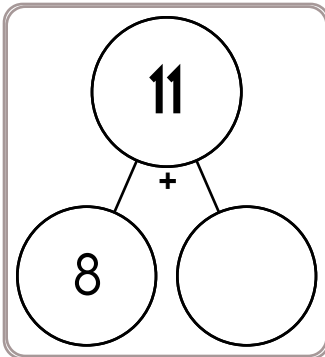



Name: \_\_\_\_\_

$$\begin{array}{r} 9 \\ + 1 \\ \hline \end{array}$$

$$\begin{array}{r} 5 \\ + 2 \\ \hline \end{array}$$

$$\begin{array}{r} 2 \\ + 1 \\ \hline \end{array}$$

$$\begin{array}{r} 2 \\ + 3 \\ \hline \end{array}$$

$$\begin{array}{r} 2 \\ + 7 \\ \hline \end{array}$$

$$\begin{array}{r} 9 \\ + 3 \\ \hline \end{array}$$

$$\begin{array}{r} 5 \\ + 6 \\ \hline \end{array}$$

$$\begin{array}{r} 8 \\ + 5 \\ \hline \end{array}$$

$$\begin{array}{r} 8 \\ + 9 \\ \hline \end{array}$$

$$\begin{array}{r} 4 \\ + 4 \\ \hline \end{array}$$

$$\begin{array}{r} 5 \\ + 3 \\ \hline \end{array}$$

$$\begin{array}{r} 6 \\ + 6 \\ \hline \end{array}$$

$$\begin{array}{r} 9 \\ + 7 \\ \hline \end{array}$$

$$\begin{array}{r} 6 \\ + 5 \\ \hline \end{array}$$

$$\begin{array}{r} 3 \\ + 8 \\ \hline \end{array}$$

$$\begin{array}{r} 3 \\ + 1 \\ \hline \end{array}$$

$$\begin{array}{r} 9 \\ + 9 \\ \hline \end{array}$$

$$\begin{array}{r} 3 \\ + 9 \\ \hline \end{array}$$

$$\begin{array}{r} \square \\ + 3 \\ \hline 7 \end{array}$$

$$\begin{array}{r} 3 \\ + \square \\ \hline 8 \end{array}$$

$$\begin{array}{r} \square \\ + 7 \\ \hline 1 \end{array}$$

$$\begin{array}{r} \square \\ + 1 \\ \hline 5 \end{array}$$

$$\begin{array}{r} \square \\ + 2 \\ \hline 1 \end{array}$$

$$\begin{array}{r} 6 \\ + 2 \\ \hline \square \end{array}$$

$$\begin{array}{r} 2 \\ + \square \\ \hline 7 \end{array}$$

$$\begin{array}{r} \square \\ + 3 \\ \hline 1 \end{array}$$

$$\begin{array}{r} 6 \\ + 7 \\ \hline \square \end{array}$$

$$\begin{array}{r} \square \\ + 7 \\ \hline 1 \end{array}$$

$$\begin{array}{r} 4 \\ + \square \\ \hline 1 \end{array}$$

$$\begin{array}{r} 5 \\ + 5 \\ \hline \square \end{array}$$

$$\begin{array}{r} \square \\ + 2 \\ \hline 9 \end{array}$$

$$\begin{array}{r} 5 \\ + \square \\ \hline 1 \end{array}$$

$$\begin{array}{r} 9 \\ + \square \\ \hline 1 \end{array}$$

$$\begin{array}{r} \square \\ + 2 \\ \hline 3 \end{array}$$

$$\begin{array}{r} 9 \\ + \square \\ \hline 1 \end{array}$$

$$\begin{array}{r} 1 \\ + 1 \\ \hline \square \end{array}$$

$$\begin{array}{r} 6 \\ + \square \\ \hline 1 \end{array}$$

$$\begin{array}{r} \square \\ + 9 \\ \hline 1 \end{array}$$

$$\begin{array}{r} 7 \\ + \square \\ \hline 1 \end{array}$$

$$\begin{array}{r} 9 \\ + 8 \\ \hline \square \end{array}$$

$$\begin{array}{r} 6 \\ + 9 \\ \hline \square \end{array}$$

$$\begin{array}{r} 9 \\ + \square \\ \hline 1 \end{array}$$

$$\begin{array}{r} 5 \\ + 4 \\ \hline \square \end{array}$$

$$\begin{array}{r} 3 \\ + 7 \\ \hline \square \end{array}$$

$$\begin{array}{r} 1 \\ + \square \\ \hline 5 \end{array}$$

$$\begin{array}{r} 7 \\ + \square \\ \hline 1 \end{array}$$

$$\begin{array}{r} 3 \\ + \square \\ \hline 6 \end{array}$$

$$\begin{array}{r} \square \\ + 5 \\ \hline 9 \end{array}$$

$$\begin{array}{r} 7 \\ + \square \\ \hline 1 \end{array}$$

$$\begin{array}{r} 6 \\ + \square \\ \hline 1 \end{array}$$

$$\begin{array}{r} 1 \\ + 5 \\ \hline \square \end{array}$$

$$\begin{array}{r} \square \\ + 4 \\ \hline 6 \end{array}$$

$$\begin{array}{r} \square \\ + 8 \\ \hline 1 \end{array}$$

$$\begin{array}{r} 2 \\ + 8 \\ \hline \square \end{array}$$

Name: \_\_\_\_\_

Write the distance (in units) for each line segment on the coordinate grid.

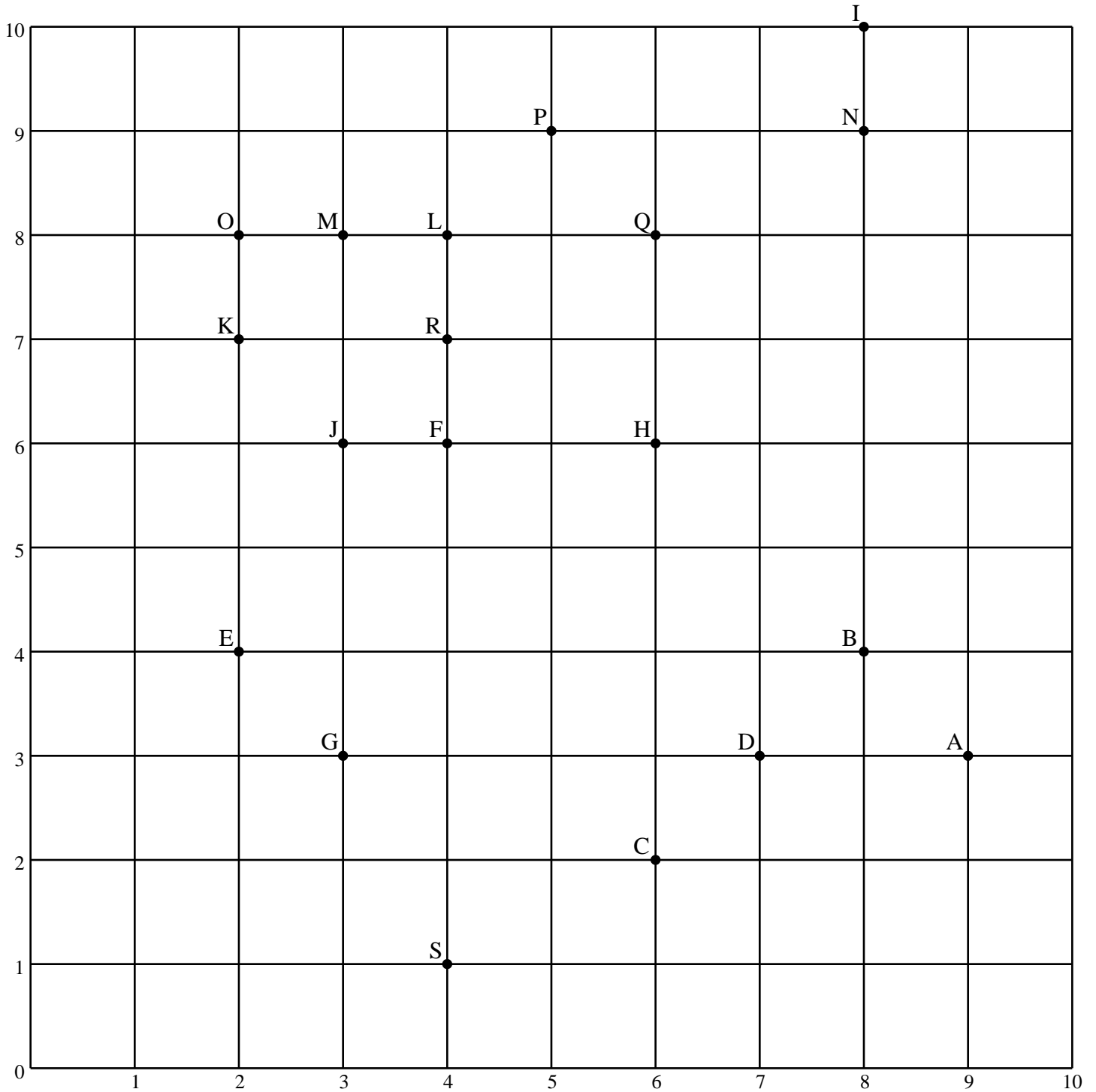

$\overline{MO}$    1  

$\overline{DA}$  \_\_\_\_\_

$\overline{SR}$  \_\_\_\_\_

$\overline{KE}$  \_\_\_\_\_

$\overline{JG}$  \_\_\_\_\_

$\overline{FH}$  \_\_\_\_\_

Name: \_\_\_\_\_

# More and Less

10 more  
25  
10 less  
15

5 less  
20  
5 more

2 more  
38  
2 less

100 more  
200  
100 less

50 less  
350  
50 more

5 ●  
*Connect  
the Dots*

6 ●  
7 ●  
13 ●  
12 ●  
1 ●

4 ●  
9 ●

3 ●  
10 ●

8 ●  
11 ●  
2 ●



Graph the  
Supplies

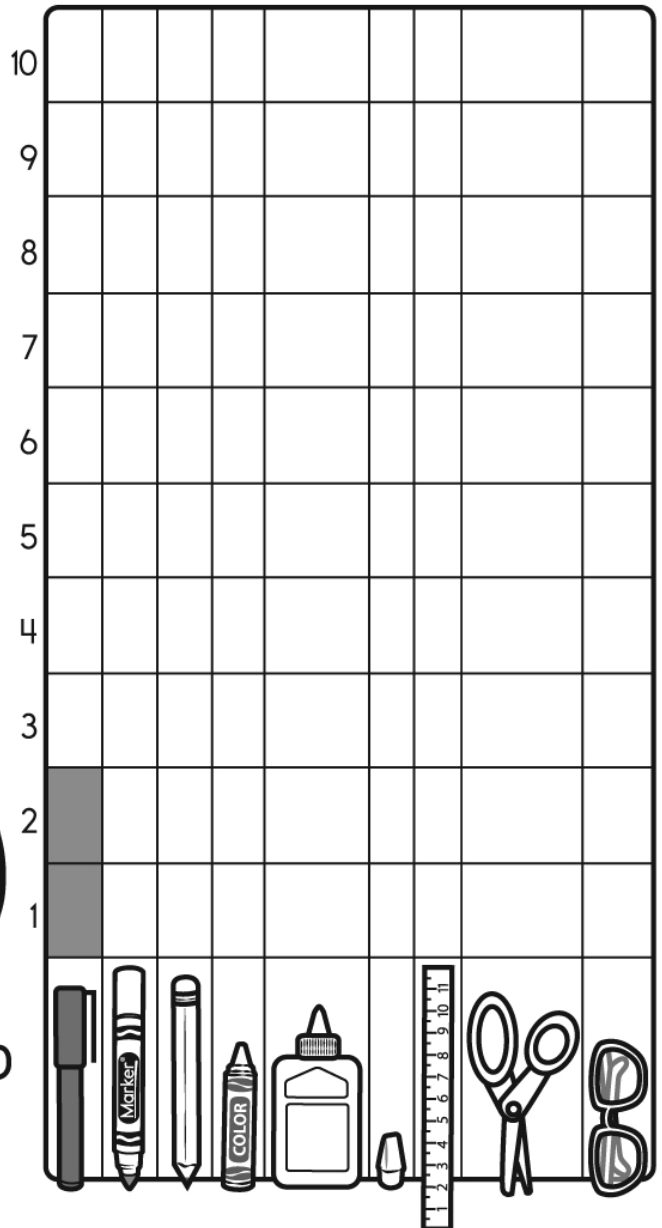





Name: \_\_\_\_\_

Each row, column, and box must have the numbers 1 through 4. The first box is done.

2	4		
1	3	2	4
3			
			2

Each row, column, and box must have 4 different pictures.

			 3
	 4		
 2			
		 1	

Name: \_\_\_\_\_



How many times  
do you need to spin?

I needed to spin \_\_\_\_\_  
time(s) to finish the page.

Spin fidget spinner. Quick!

I needed to spin \_\_\_\_\_ time(s) to finish.

— —  
five tens

— —  
78 ones

— —  
eight tens

— — —  
45 tens

— —  
six tens

— — —  
23 tens

— —  
seven tens

— — —  
82 tens

— —  
four tens

— —  
10 ones

— —  
nine tens

— —  
59 ones

— —  
three tens

— — — —  
36 hundreds

— —  
two tens

— — —  
62 tens

— — — —  
97 hundreds

— — —  
29 tens

Name: \_\_\_\_\_



Circle the answer.

The long hand shows...

Minutes

Hours

Count forward and put in the missing numbers.

50

\_\_\_\_\_

\_\_\_\_\_

\_\_\_\_\_

\_\_\_\_\_

55

\_\_\_\_\_

\_\_\_\_\_

58

\_\_\_\_\_

60

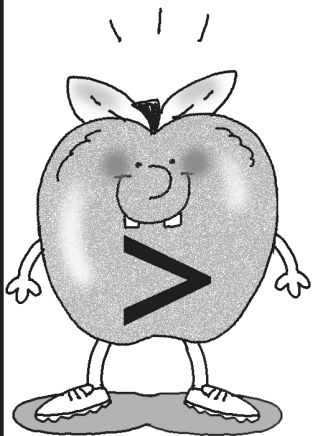

Put in this &gt;

symbol to show numbers  
that are greater than.

9 \_\_\_\_\_ 7

19 \_\_\_\_\_ 18

20 \_\_\_\_\_ 11

6 \_\_\_\_\_ 5

A penny  
is worth \_\_\_\_\_¢A nickel  
is worth \_\_\_\_\_¢A dime  
is worth \_\_\_\_\_¢

Name: \_\_\_\_\_

Count by twos.

2, 4, \_\_\_\_\_, 8,  
 10, \_\_\_\_\_, 14,  
 16, 18, \_\_\_\_\_

At the fair Jodi won three ribbons and then three more. How many ribbons did she win in all?

Addition Problem	Answer
------------------	--------

How much money is here in all?

\_\_\_\_\_¢

Circle the answer.

The short hand shows...

Minutes      Hours



Where can I get more of this great stuff?

More math!

More ~~spelleng~~ spelling!

It's NO PREP at edHelper.

More history!

# edHelper.com!

New online math games!

More things for the classroom!

More science!

More puzzles!

New ideas!



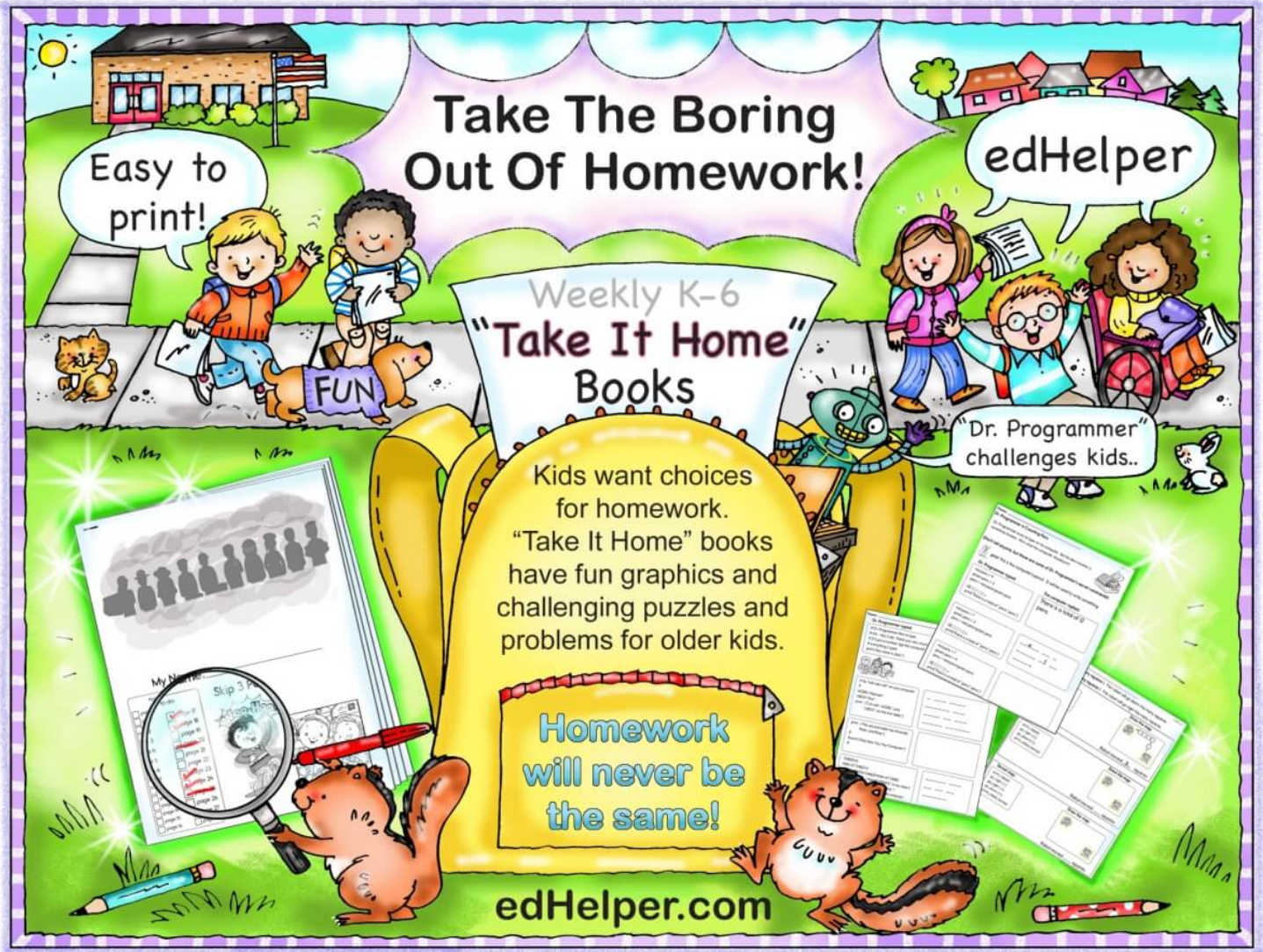

# Take The Boring Out Of Homework!

Easy to print!

edHelper

Weekly K-6  
"Take It Home"  
Books

Kids want choices for homework. "Take It Home" books have fun graphics and challenging puzzles and problems for older kids.

"Dr. Programmer" challenges kids..

Homework will never be the same!

edHelper.com

Name: \_\_\_\_\_

Count by 5s.

5 , \_\_\_\_\_ , \_\_\_\_\_ , \_\_\_\_\_ , \_\_\_\_\_ , \_\_\_\_\_ , \_\_\_\_\_ , \_\_\_\_\_ , \_\_\_\_\_

Count by 5 minutes.

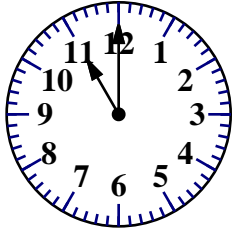

11:00

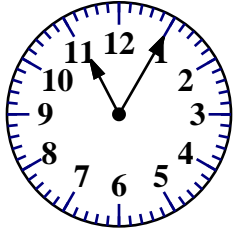

11:05

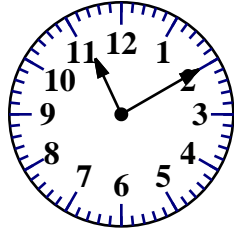

\_\_\_\_\_

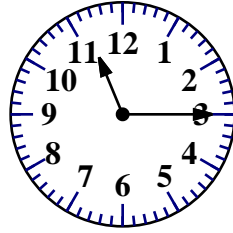

\_\_\_\_\_

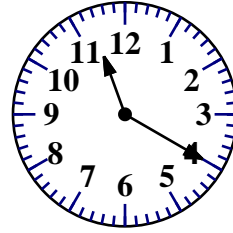

\_\_\_\_\_

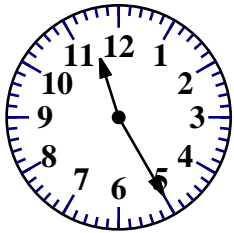

\_\_\_\_\_

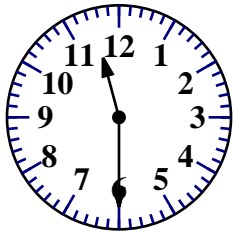

\_\_\_\_\_

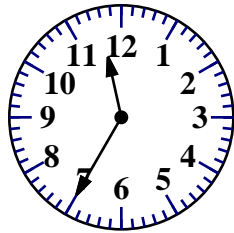

\_\_\_\_\_

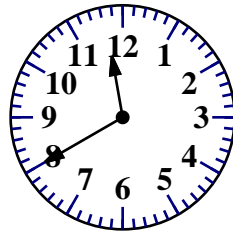

\_\_\_\_\_

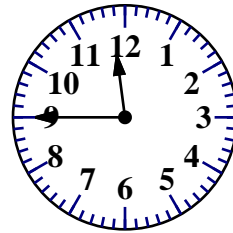

\_\_\_\_\_

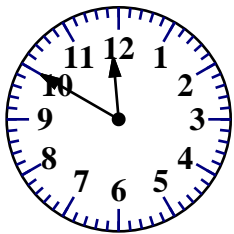

\_\_\_\_\_

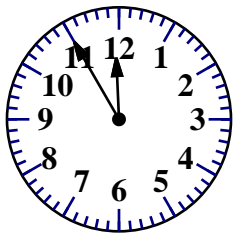

\_\_\_\_\_

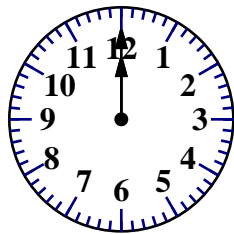

\_\_\_\_\_

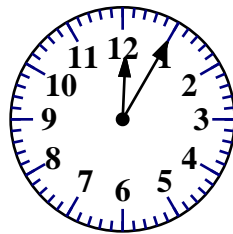

\_\_\_\_\_

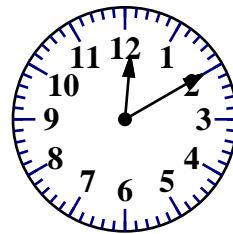

\_\_\_\_\_

The clocks have been mixed up. Write the time.

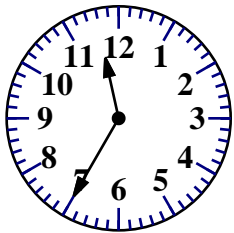

\_\_\_\_\_

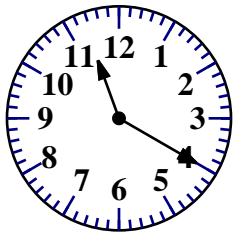

\_\_\_\_\_

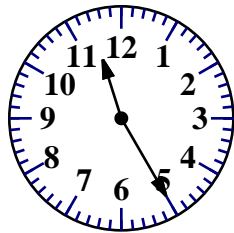

\_\_\_\_\_

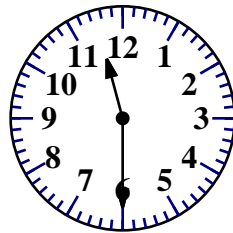

\_\_\_\_\_

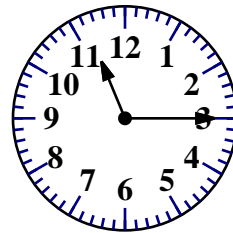

\_\_\_\_\_

Name: \_\_\_\_\_

Complete each pattern, using the same rule. Write what the rule is.

119, 102, 85, 68, 51, 34, \_\_\_\_\_

\_\_\_\_\_, \_\_\_\_\_, 153, 136, \_\_\_\_\_, \_\_\_\_\_, 85, 68

272, 255, \_\_\_\_\_, 221, 204, 187, \_\_\_\_\_









204, \_\_\_\_\_, \_\_\_\_\_, \_\_\_\_\_, \_\_\_\_\_, 119, 102, 85

Complete each pattern, using the same rule. Write what the rule is.

84, 72, 60, 48, \_\_\_\_\_, 24, 12

192, \_\_\_\_\_, \_\_\_\_\_, \_\_\_\_\_, \_\_\_\_\_, 132, 120

Name: \_\_\_\_\_

		
 + 	 + 	 + 

## Science Day



5				
4				
3				
2				
1				



Look at a calendar. How many days does this month have?

\_\_\_\_\_ days

Circle the shapes with 5 sides.

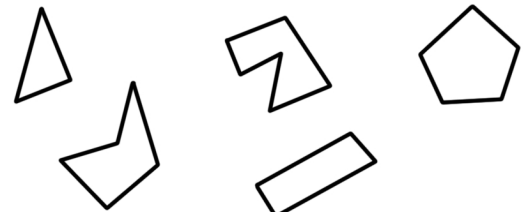

©edHelper.com

Name: \_\_\_\_\_

Cross off the number that does NOT belong.

4, 4, 3, 3, 4, 4, 3, 3, 4, 3, 4, 3, 3

Why does \_\_\_\_\_ not belong in the pattern?

Cross off the number that does NOT belong.

8, 16, 24, 25, 32, 40, 48, 56

Why does \_\_\_\_\_ not belong in the pattern?

Name: \_\_\_\_\_

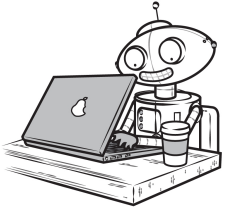

Dr. Programmer is good friends with Simon.

Dr. Programmer has a playdate with Simon.

Dr. Programmer is showing Simon his computer.

Dr. Programmer typed:

```
print ( "Hello" )
```

The computer replied:

H e l l o

```
print ( "My name is  
Doctor Programmer." )
```

\_\_\_\_\_

\_\_\_\_\_

\_\_\_\_\_

```
print ( "I also like first grade." )
```

\_\_\_\_\_

\_\_\_\_\_

\_\_\_\_\_

$0 + 1 = \underline{\quad}$

1       11       13

two

2       4       0

$14 - 8 = \underline{\quad}$

6       4       5

Name: \_\_\_\_\_

Fill in the missing numbers and fractions.

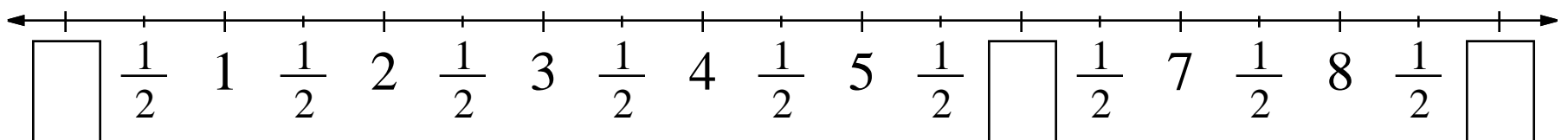
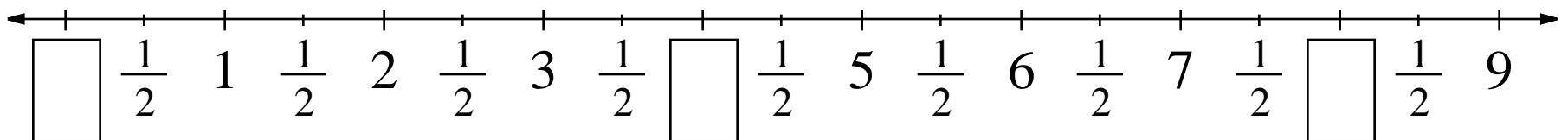
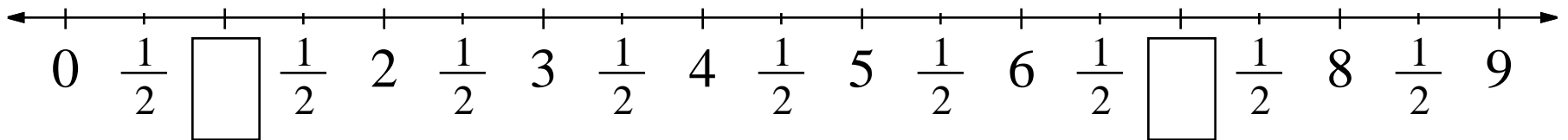
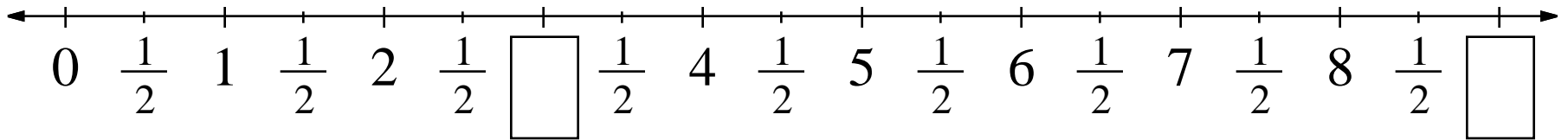
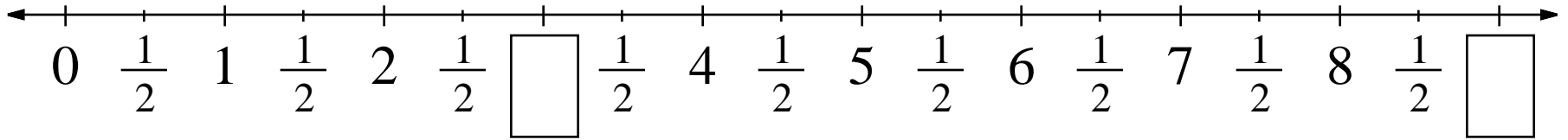
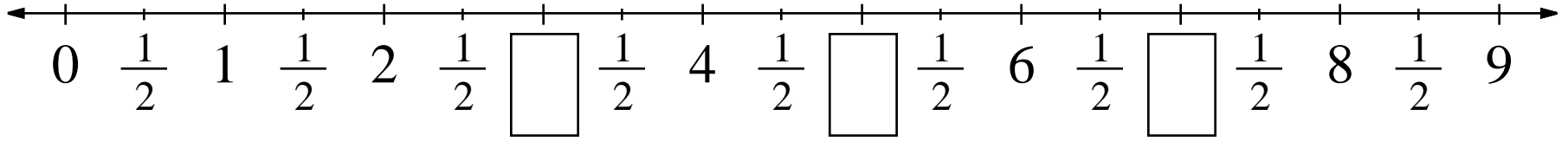

Name: \_\_\_\_\_

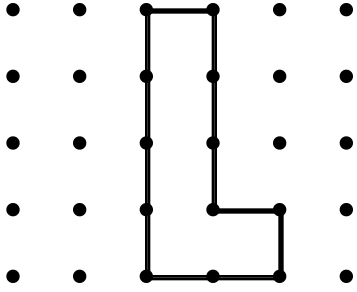

Perimeter =

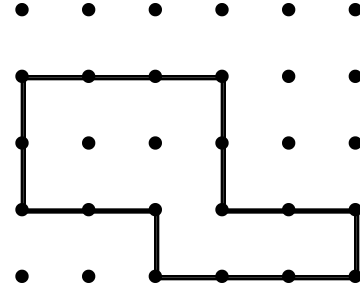
**12**

Perimeter =

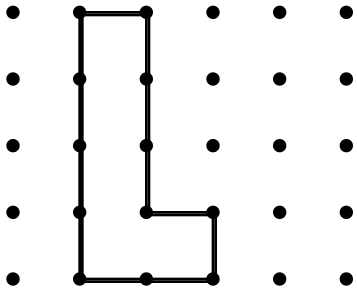

Perimeter =

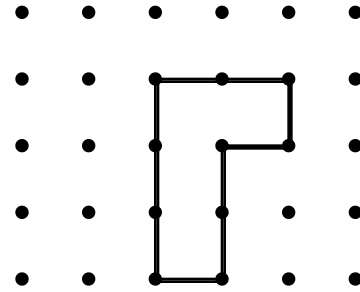

Perimeter =

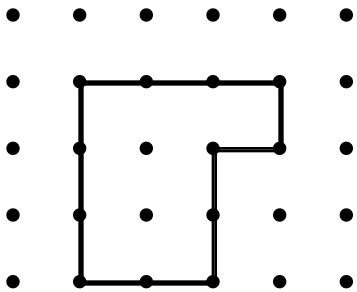

Perimeter =

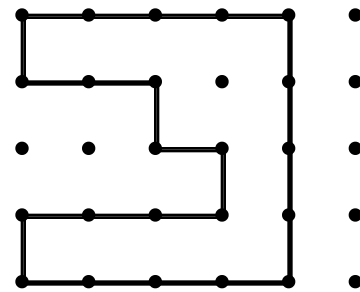

Perimeter =



Name: \_\_\_\_\_

2	+1		+3			-3		-1	
									+2
	-2		+3			+2		+3	
-1									
	-3		+2	5	+1			-2	7

4	+2				-1		+2		+2
			-3		-3				
					8				-1
+2			+1		+1		-3	6	-1
					7				
+3			-3		+1		-3		+2
									2

Write the missing sign.

$$9 \text{ \_\_\_ } 8 = 1$$

Name: \_\_\_\_\_

$\begin{array}{r} 4 \\ + 1 \\ \hline \end{array}$	$\begin{array}{r} 1 \\ + 2 \\ \hline \end{array}$	$\begin{array}{r} 1 \\ + 7 \\ \hline \end{array}$	$\begin{array}{r} 3 \\ + 4 \\ \hline \end{array}$	$\begin{array}{r} 8 \\ + 1 \\ \hline \end{array}$	$\begin{array}{r} 8 \\ + 2 \\ \hline \end{array}$	$\begin{array}{r} 7 \\ + 9 \\ \hline \end{array}$	$\begin{array}{r} 9 \\ + 8 \\ \hline \end{array}$	$\begin{array}{r} 6 \\ + 5 \\ \hline \end{array}$
---	---	---	---	---	---	---	---	---

$\begin{array}{r} 5 \\ + 9 \\ \hline \end{array}$	$\begin{array}{r} 2 \\ + 5 \\ \hline \end{array}$	$\begin{array}{r} 1 \\ + 9 \\ \hline \end{array}$	$\begin{array}{r} 5 \\ + 3 \\ \hline \end{array}$	$\begin{array}{r} 6 \\ + 7 \\ \hline \end{array}$	$\begin{array}{r} 5 \\ + 8 \\ \hline \end{array}$	$\begin{array}{r} 7 \\ + 8 \\ \hline \end{array}$	$\begin{array}{r} 3 \\ + 1 \\ \hline \end{array}$	$\begin{array}{r} 3 \\ + 6 \\ \hline \end{array}$
---	---	---	---	---	---	---	---	---

$\begin{array}{r} \square \\ + 5 \\ \hline 1 \end{array}$	$\begin{array}{r} 8 \\ + \square \\ \hline 1 \end{array}$	$\begin{array}{r} 9 \\ + \square \\ \hline 1 \end{array}$	$\begin{array}{r} \square \\ + 7 \\ \hline 1 \end{array}$	$\begin{array}{r} \square \\ + 9 \\ \hline 1 \end{array}$	$\begin{array}{r} \square \\ + 9 \\ \hline 1 \end{array}$	$\begin{array}{r} 2 \\ + 1 \\ \hline \square \end{array}$	$\begin{array}{r} \square \\ + 1 \\ \hline 8 \end{array}$	$\begin{array}{r} 1 \\ + 3 \\ \hline \square \end{array}$
---	---	---	---	---	---	---	---	---









$\begin{array}{r} 6 \\ + \square \\ \hline 9 \end{array}$	$\begin{array}{r} \square \\ + 2 \\ \hline 6 \end{array}$	$\begin{array}{r} 9 \\ + \square \\ \hline 1 \end{array}$	$\begin{array}{r} \square \\ + 4 \\ \hline 8 \end{array}$	$\begin{array}{r} 9 \\ + \square \\ \hline 1 \end{array}$	$\begin{array}{r} \square \\ + 4 \\ \hline 9 \end{array}$	$\begin{array}{r} 5 \\ + 2 \\ \hline \square \end{array}$	$\begin{array}{r} 6 \\ + \square \\ \hline 1 \end{array}$	$\begin{array}{r} 9 \\ + 4 \\ \hline \square \end{array}$
---	---	---	---	---	---	---	---	---

$\begin{array}{r} \square \\ + 7 \\ \hline 1 \end{array}$	$\begin{array}{r} \square \\ + 2 \\ \hline 5 \end{array}$	$\begin{array}{r} \square \\ + 8 \\ \hline 1 \end{array}$	$\begin{array}{r} \square \\ + 8 \\ \hline 1 \end{array}$	$\begin{array}{r} 2 \\ + \square \\ \hline 1 \end{array}$	$\begin{array}{r} \square \\ + 7 \\ \hline 1 \end{array}$	$\begin{array}{r} 2 \\ + 4 \\ \hline \square \end{array}$	$\begin{array}{r} 2 \\ + \square \\ \hline 1 \end{array}$	$\begin{array}{r} \square \\ + 9 \\ \hline 1 \end{array}$
---	---	---	---	---	---	---	---	---









$\begin{array}{r} 8 \\ + 3 \\ \hline \square \end{array}$	$\begin{array}{r} \square \\ + 6 \\ \hline 7 \end{array}$	$\begin{array}{r} \square \\ + 6 \\ \hline 1 \end{array}$	$\begin{array}{r} \square \\ + 2 \\ \hline 4 \end{array}$	$\begin{array}{r} 2 \\ + \square \\ \hline 9 \end{array}$	$\begin{array}{r} 8 \\ + \square \\ \hline 1 \end{array}$	$\begin{array}{r} \square \\ + 5 \\ \hline 1 \end{array}$	$\begin{array}{r} 5 \\ + 1 \\ \hline \square \end{array}$	$\begin{array}{r} 2 \\ + 3 \\ \hline \square \end{array}$
---	---	---	---	---	---	---	---	---









Name: \_\_\_\_\_

Draw lines to put the numbers in order.

Two lines are drawn from the first two empty boxes to the number 17 in the second row.

Name: \_\_\_\_\_

Puzzle:

	#	3
#	4	5
3	5	+

Work Area:





		3
	4	5
3	5	+

The sum for each column and row is given.

 = \_\_\_\_\_

# = \_\_\_\_\_

Puzzle:

		6
		14
11	9	+

Work Area:

		6
		14
11	9	+

The sum for each column and row is given.

 = \_\_\_\_\_

 = \_\_\_\_\_

 = \_\_\_\_\_

How many?



How much is this?

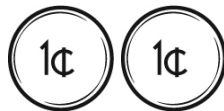

Circle the third letter.

F, 5, F, B, 8, 2, 3, 2, 3, D,  
B, B, 5, B, B, 6, 7, B, F

Name: \_\_\_\_\_

**Color Squares Puzzle**

Color in the number of consecutive boxes in each row and column. Double check when you are done!

	A	B	C	D	E	F	G	H	I	J
	1	3	5	1	1	0	0	0	0	0
K	1	/								
L	1	/		/	/					
M	2			/				/		
N	3							/	/	
O	4							/		

CLUE A: Color in 1 box.

CLUE B: Color in 3 consecutive boxes.

CLUE C: Color in all the boxes in this column.

CLUE D: Color in 1 box.

CLUE E: Color in 1 box.

CLUE F: Do not color in any boxes in this column.

CLUE G: Do not color in any boxes in this column.

CLUE H: Do not color in any boxes in this column.

CLUE I: Do not color in any boxes in this column.

CLUE J: Do not color in any boxes in this column.

CLUE K: Color in 1 box.

CLUE L: Color in 1 box.

CLUE M: Color in 2 consecutive boxes.

CLUE N: Color in 3 consecutive boxes.

CLUE O: Color in 4 consecutive boxes.

Name: \_\_\_\_\_

There were five bags of cotton candy on the table. Then four more bags were put on the table. How many bags were on the table then?

Peter liked to ride his bike. It made him very happy. One day he rode 5 miles. The next day he rode 4 miles. The next day he rode 2 more miles. How many miles did he ride in all?

Max found 10 dimes and 4 nickels. How many coins did he find in all?

Rose picked 12 apples. Emily picked 5 apples. How many apples did they pick in all?

$\begin{array}{r} 3 \\ + 8 \\ \hline \end{array}$	$\begin{array}{r} 9 \\ + 6 \\ \hline \end{array}$	$\begin{array}{r} 7 \\ + 1 \\ \hline \end{array}$	$\begin{array}{r} 2 \\ + 9 \\ \hline \end{array}$	$\begin{array}{r} 6 \\ + 3 \\ \hline \end{array}$	$\begin{array}{r} 4 \\ + 7 \\ \hline \end{array}$	$\begin{array}{r} 5 \\ + 5 \\ \hline \end{array}$	$\begin{array}{r} 6 \\ + 7 \\ \hline \end{array}$	$\begin{array}{r} 9 \\ + 8 \\ \hline \end{array}$
---	---	---	---	---	---	---	---	---

Count by 5s.



= 5 ¢



How much?

6 + 1

\_\_\_\_\_ ¢

Name: \_\_\_\_\_

$\begin{array}{r} 4 \\ + 3 \\ \hline \end{array}$	$\begin{array}{r} 8 \\ + 1 \\ \hline \end{array}$	$\begin{array}{r} 9 \\ + 3 \\ \hline \end{array}$	$\begin{array}{r} 8 \\ + 7 \\ \hline \end{array}$	$\begin{array}{r} 8 \\ + 8 \\ \hline \end{array}$	$\begin{array}{r} 9 \\ + 5 \\ \hline \end{array}$	$\begin{array}{r} 3 \\ + 3 \\ \hline \end{array}$	$\begin{array}{r} 2 \\ + 2 \\ \hline \end{array}$	$\begin{array}{r} 7 \\ + 6 \\ \hline \end{array}$
---	---	---	---	---	---	---	---	---

$\begin{array}{r} 3 \\ + 8 \\ \hline \end{array}$	$\begin{array}{r} 8 \\ + 5 \\ \hline \end{array}$	$\begin{array}{r} 6 \\ + 1 \\ \hline \end{array}$	$\begin{array}{r} 4 \\ + 4 \\ \hline \end{array}$	$\begin{array}{r} 7 \\ + 9 \\ \hline \end{array}$	$\begin{array}{r} 1 \\ + 5 \\ \hline \end{array}$	$\begin{array}{r} 9 \\ + 2 \\ \hline \end{array}$	$\begin{array}{r} 6 \\ + 8 \\ \hline \end{array}$	$\begin{array}{r} 2 \\ + 3 \\ \hline \end{array}$
---	---	---	---	---	---	---	---	---

$\begin{array}{r} 5 \\ + \square \\ \hline 6 \end{array}$	$\begin{array}{r} \square \\ + 2 \\ \hline 1 \end{array}$	$\begin{array}{r} 5 \\ + \square \\ \hline 1 \end{array}$	$\begin{array}{r} \square \\ + 3 \\ \hline 4 \end{array}$	$\begin{array}{r} \square \\ + 4 \\ \hline 7 \end{array}$	$\begin{array}{r} 1 \\ + \square \\ \hline 9 \end{array}$	$\begin{array}{r} \square \\ + 2 \\ \hline 6 \end{array}$	$\begin{array}{r} 4 \\ + \square \\ \hline 9 \end{array}$	$\begin{array}{r} \square \\ + 7 \\ \hline 1 \end{array}$
---	---	---	---	---	---	---	---	---

$\begin{array}{r} 5 \\ + 2 \\ \hline \square \end{array}$	$\begin{array}{r} 3 \\ + \square \\ \hline 1 \end{array}$	$\begin{array}{r} 6 \\ + \square \\ \hline 1 \end{array}$	$\begin{array}{r} 4 \\ + \square \\ \hline 1 \end{array}$	$\begin{array}{r} 8 \\ + 9 \\ \hline \square \end{array}$	$\begin{array}{r} \square \\ + 1 \\ \hline 2 \end{array}$	$\begin{array}{r} 2 \\ + \square \\ \hline 3 \end{array}$	$\begin{array}{r} 1 \\ + \square \\ \hline 1 \end{array}$	$\begin{array}{r} \square \\ + 6 \\ \hline 7 \end{array}$
---	---	---	---	---	---	---	---	---

$\begin{array}{r} 3 \\ + 2 \\ \hline \square \end{array}$	$\begin{array}{r} 8 \\ + 6 \\ \hline \square \end{array}$	$\begin{array}{r} 4 \\ + 9 \\ \hline \square \end{array}$	$\begin{array}{r} \square \\ + 4 \\ \hline 5 \end{array}$	$\begin{array}{r} 7 \\ + \square \\ \hline 8 \end{array}$	$\begin{array}{r} \square \\ + 9 \\ \hline 1 \end{array}$	$\begin{array}{r} 6 \\ + 9 \\ \hline \square \end{array}$	$\begin{array}{r} 5 \\ + \square \\ \hline 9 \end{array}$	$\begin{array}{r} 6 \\ + 4 \\ \hline \square \end{array}$
---	---	---	---	---	---	---	---	---

$\begin{array}{r} \square \\ + 4 \\ \hline 1 \end{array}$	$\begin{array}{r} 6 \\ + \square \\ \hline 1 \end{array}$	$\begin{array}{r} 9 \\ + \square \\ \hline 1 \end{array}$	$\begin{array}{r} \square \\ + 5 \\ \hline 1 \end{array}$	$\begin{array}{r} 4 \\ + 1 \\ \hline \square \end{array}$	$\begin{array}{r} \square \\ + 7 \\ \hline 1 \end{array}$	$\begin{array}{r} 8 \\ + 3 \\ \hline \square \end{array}$	$\begin{array}{r} 3 \\ + \square \\ \hline 9 \end{array}$	$\begin{array}{r} \square \\ + 6 \\ \hline 8 \end{array}$
---	---	---	---	---	---	---	---	---

Name: \_\_\_\_\_

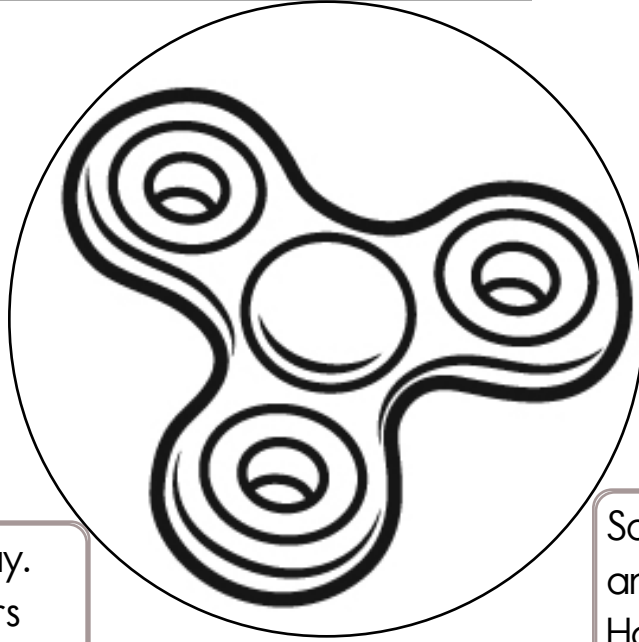

How many times  
do you need to spin?

I needed to spin \_\_\_\_\_  
time(s) to finish the page.

It was Teddy Bear Day.  
Sue had 3 teddy bears  
on her bed. Sue had 6  
teddy bears on her shelf.  
How many teddy bears  
did Sue have in all?

There were 8 apples in a  
bowl. Mario ate 1 apple.  
How many apples were  
left?

Sam had 4 red apples  
and 2 green apples.  
How many apples did he  
have in all?

Evan grilled 5 hot dogs.  
There was 1 hot dog left.  
How many hot dogs  
were eaten?

It was Teddy Bear Day.  
Holly had 4 teddy bears  
on her dresser. She had  
1 teddy bear on her bed.  
How many more teddy  
bears were on Holly's  
dresser than on her bed?

Fay had 6 new crayons.  
She lost 2 crayons. How  
many new crayons did  
Fay have left?

Jeb had 9 red apples  
and 4 green apples.  
How many more red  
apples than green apples  
did Jeb have?

Jim ate 2 hot dogs and 1  
hamburger. How many  
things did Jim eat in all?

Kelly read for 10 minutes  
on the first day of school.  
She read for 7 minutes  
on the second day of  
school. How many more  
minutes did Kelly read on  
the first day than on the  
second day?



Name: \_\_\_\_\_

Spin the fidget spinner again until you finish THIS page. I needed to spin \_\_\_\_\_ time(s) to finish.

John had 1 green backpack and 1 blue backpack. How many backpacks did he have in all?

Alex won 3 games of checkers and lost 2 games of checkers. How many games of checkers did Alex play in all?

It was Read a Book Day. Mrs. Jones read 1 book to the class in the morning and 2 books to the class in the afternoon. How many books did she read to the class in all?

Ben took out 5 books on elephants. Ken took out 3 books on elephants. How many more books did Ben take out than Ken?

Nell ate 4 star cookies at the barbecue. She ate 3 sun cookies at the barbecue. How many cookies did Nell eat in all?

It was Make a Hat Day. Josh made 1 brown hat and 2 black hats. How many hats did Josh make in all?

Sid took out 4 library books about elephants. Cathy took out 4 library books about elephants, too. How many books about elephants were taken out in all?

Joe won 4 games of checkers and lost 1 game of checkers. How many more games of checkers did Joe win than lose?

Mike played 3 soccer games on Saturday. He played 1 soccer game on Sunday. How many more soccer games did Mike play on Saturday than on Sunday?

Bob had 4 new pencils and 1 new pen for the first day of school. How many more pencils did Bob have than pens?

Phil picked 6 apples from the tree on Monday and 3 apples from the tree on Tuesday. How many apples did Phil pick from the tree in all?

Jan had 5 pens and 3 pencils. How many pens and pencils did she have in all?

Name: \_\_\_\_\_

Some blocks are missing. Draw blocks so that the scale picture makes sense.

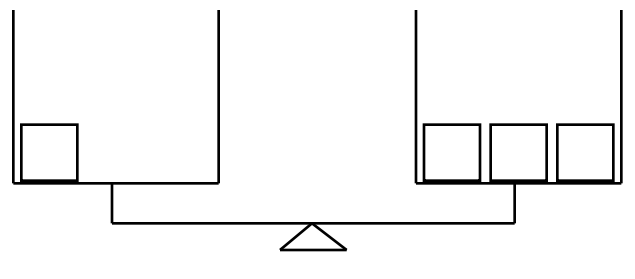
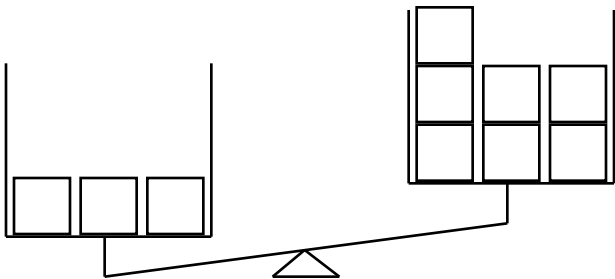
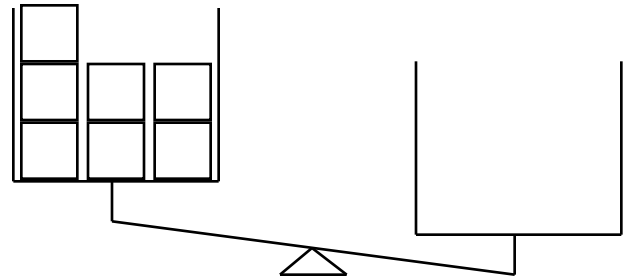
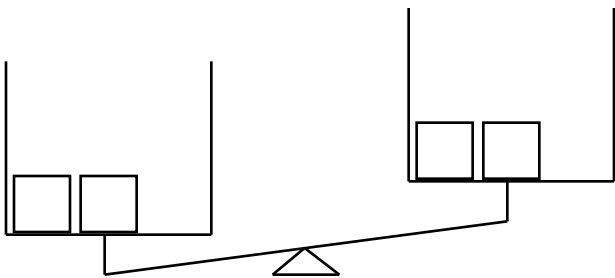
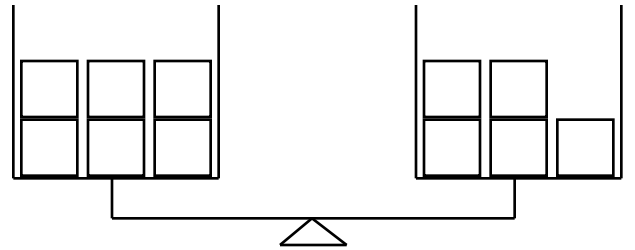
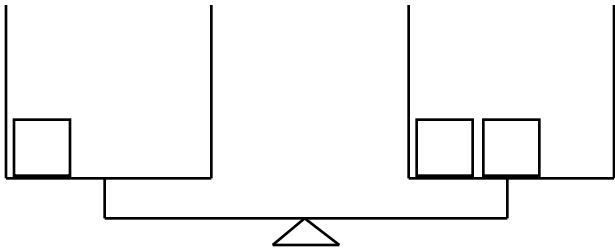
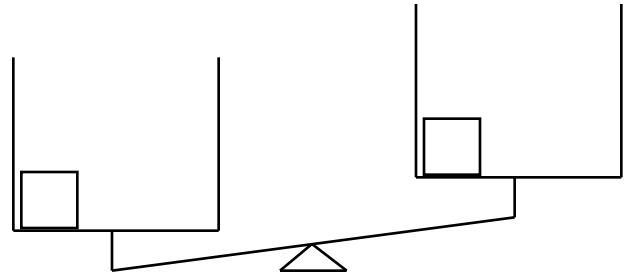
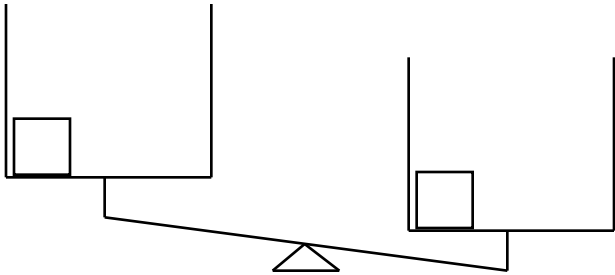

Name: \_\_\_\_\_



$3 + 3 =$

$6 + 2 =$

$1 + 5 =$

$8 + 1 =$

$1 + 5 =$

$0 + 0 =$

$$\begin{array}{r} 0 \\ + 10 \\ \hline \end{array}$$

$$\begin{array}{r} 1 \\ + 2 \\ \hline \end{array}$$

$$\begin{array}{r} 9 \\ + 0 \\ \hline \end{array}$$

$$\begin{array}{r} 6 \\ + 4 \\ \hline \end{array}$$

$$\begin{array}{r} 6 \\ + 3 \\ \hline \end{array}$$

$$\begin{array}{r} 0 \\ + 2 \\ \hline \end{array}$$

$$\begin{array}{r} 2 \\ + 6 \\ \hline \end{array}$$

$$\begin{array}{r} 5 \\ + 5 \\ \hline \end{array}$$

$$\begin{array}{r} 9 \\ + 0 \\ \hline \end{array}$$

$$\begin{array}{r} 5 \\ + 1 \\ \hline \end{array}$$

$$\begin{array}{r} 5 \\ + 0 \\ \hline \end{array}$$

$$\begin{array}{r} 5 \\ + 4 \\ \hline \end{array}$$

$$\begin{array}{r} 4 \\ + 4 \\ \hline \end{array}$$

$$\begin{array}{r} 2 \\ + 7 \\ \hline \end{array}$$

$$\begin{array}{r} 0 \\ + 7 \\ \hline \end{array}$$

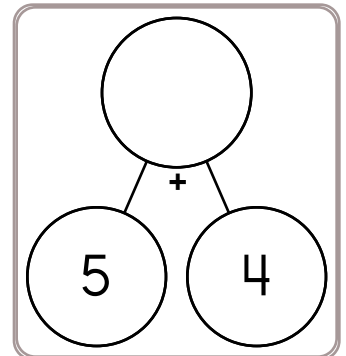
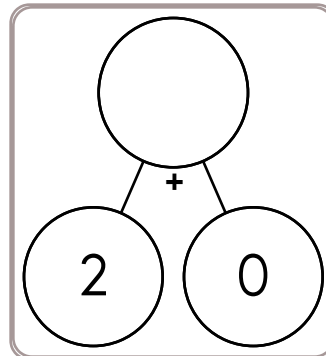
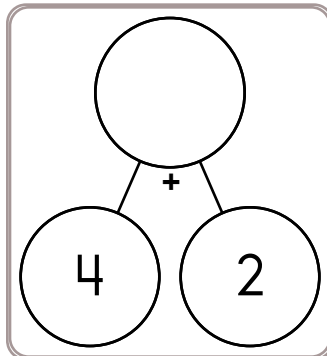
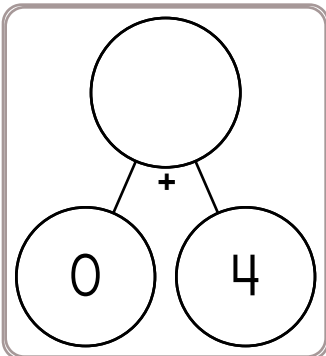
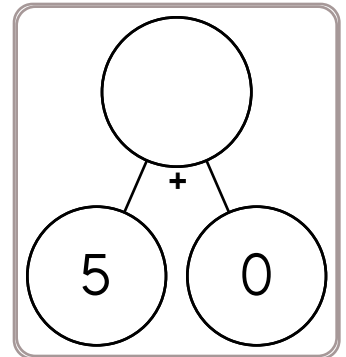
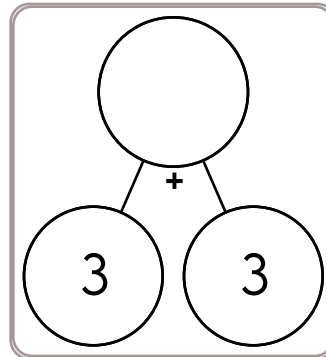
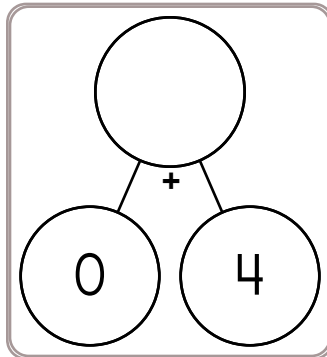
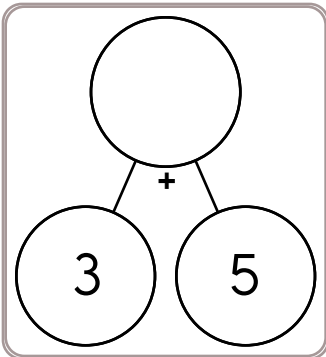

Name: \_\_\_\_\_

This clock shows...



1:00      12:00

Put in this &lt; symbol to show numbers that are less than.

8 \_\_\_\_\_ 15

16 \_\_\_\_\_ 18

7 \_\_\_\_\_ 9

12 \_\_\_\_\_ 20

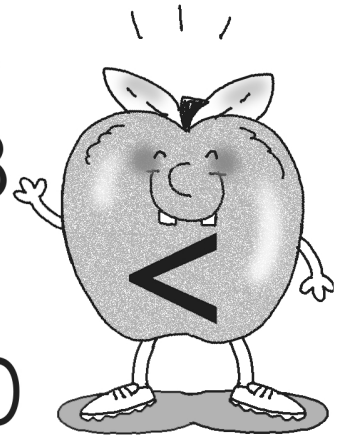

Count backward and put in the missing numbers.

60

\_\_\_\_\_

55



\_\_\_\_\_

50

Put in the &gt; (greater than) or &lt; (less than) symbols.

10 \_\_\_\_\_ 9

19 \_\_\_\_\_ 20

8 \_\_\_\_\_ 17

15 \_\_\_\_\_ 13

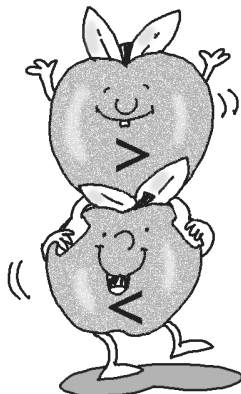

16 \_\_\_\_\_ 18

11 \_\_\_\_\_ 14

20 \_\_\_\_\_ 12

9 \_\_\_\_\_ 13

Name: \_\_\_\_\_

Wendy has ten books. Four books have red covers. How many books do not have red covers?

Connor went to the beach. He played in the sand. His father gave him 20¢ to buy a drink. He has 7¢ left. How much did he spend?

Maria has 3 coins. They equal 75¢. What coins does Maria have?

Mr. Robinson buys a pin every time he visits a new state. He puts them on his jacket. He has 13 pins now. He will go to 3 states this summer. How many pins will he have then?

Maria has 2 pairs of shoes. Her sister has 5 pairs of shoes. How many pairs do they have in all?

5 is more than

4       6       5

$7 - 5$

$8 + 6$

Count by 10s.

38      \_\_\_\_\_      58

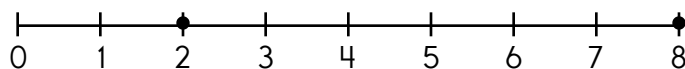

$8 - \underline{\quad} = 2$

Write the missing letter to spell over.

ov\_r      o\_er      \_ver



Name: \_\_\_\_\_

Use any of these digits. Cross off a digit after you use it.

9      4      1      4      3      6      3      7      8

Write the smallest 5-digit number that you can with 8 in the thousands place.

36, \_\_\_\_\_, \_\_\_\_\_, 39, \_\_\_\_\_, 41

13, 15, 17, 19, 21,

\_\_\_\_\_, 25, 27

What is ten more than 62?

Write the numbers.

one \_\_\_\_\_

seven \_\_\_\_\_

two \_\_\_\_\_

eight \_\_\_\_\_

eleven \_\_\_\_\_

Write these numbers in  
order from smallest to  
largest.

9, 3, 15

\_\_\_\_\_, \_\_\_\_\_, \_\_\_\_\_

Write these numbers in  
order from largest to  
smallest.

8, 4, 14

\_\_\_\_\_, \_\_\_\_\_, \_\_\_\_\_

$3 + 0 = \underline{\hspace{2cm}}$

○ 8      ○ 9      ○ 3



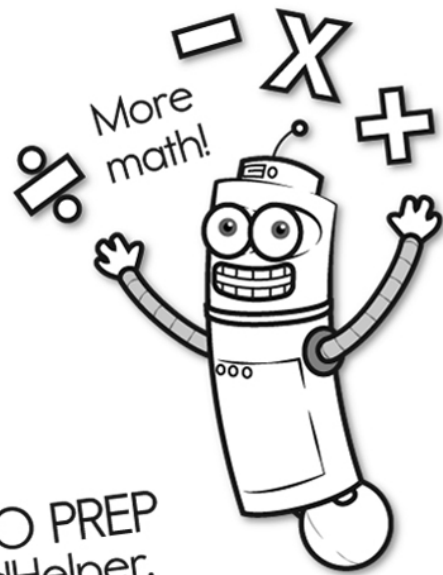
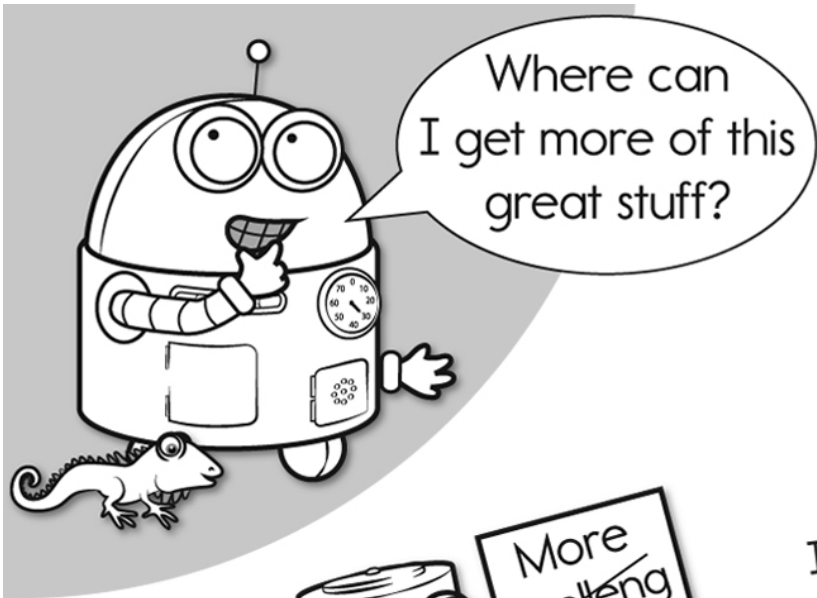

It's NO PREP at edHelper.

More history!

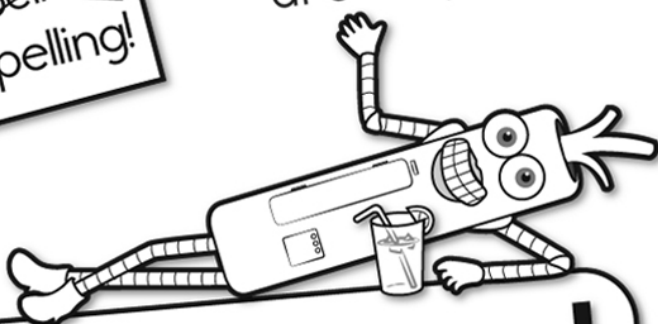

# edHelper.com!

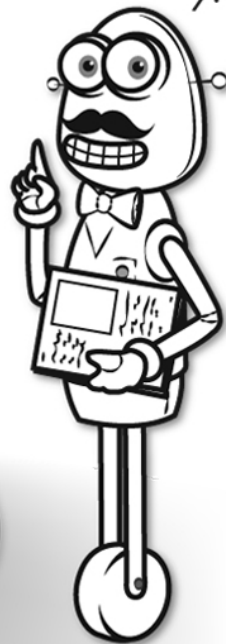

New online math games!



More things for the classroom!

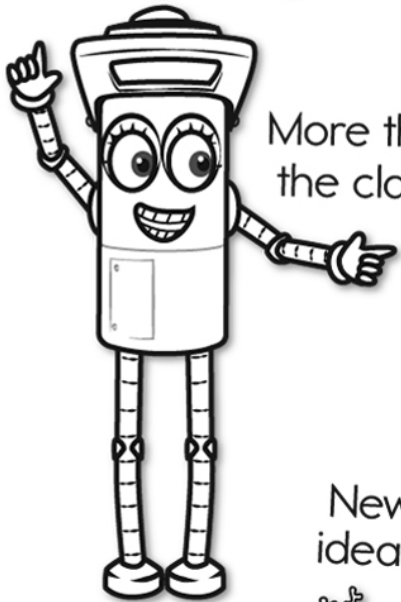

More science!



New ideas!

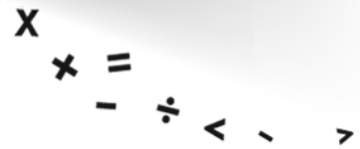

More puzzles!

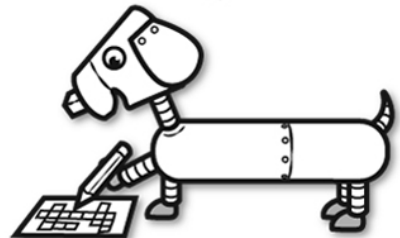



# Take The Boring Out Of Homework!

Easy to  
print!

edHelper

## Weekly K-6 "Take It Home" Books

Kids want choices  
for homework.  
"Take It Home" books  
have fun graphics and  
challenging puzzles and  
problems for older kids.

"Dr. Programmer"  
challenges kids..

Homework  
will never be  
the same!

edHelper.com

