

Health and Safety Manual

Civil and Environmental Engineering Dept.

**More Hall
2015**



Building and Fire Safety
Environmental Health and
Safety
University of Washington
Box 354400
Seattle, WA. 98195-4400
Phone: (206) 543-0465
Fax: (206) 616-3360

Introduction – How to Use This Manual

The Health and Safety Manual of the Civil and Environmental Engineering Department is intended to provide general guidelines and knowledge to maintain safety for students, staff, faculty, and visitors. This manual is maintained by the department, and acts as a general guide to information and additional resources as put forth by governing entities, both internal and external to the university. As such, this manual is superceded by any procedures, guidelines, and authority put forth by University of Washington Environmental Health & Safety, the College of Engineering, UW Police, Seattle Fire Department, and any other university, state, or federal entity with jurisdiction over university departments.

Unless otherwise noted, all phone numbers in this manual utilize area code 206.

Contents

<i>Introduction – How to Use This Manual</i>	0
1.1 Shop and Lab Safety Introduction	10
1.2 More Hall and Harris Hydraulics Machine Shop Safety	11
<i>SHOP SAFETY and CHECK IN</i>	11
1.3 GENERAL SHOP SAFETY RULES	12
<i>DRILL PRESS SAFETY RULES</i>	13
<i>LATHE SAFETY RULES</i>	14
<i>MILLING MACHINE SAFETY RULES</i>	15
<i>GRINDING SAFETY RULES</i>	16
<i>BAND SAW SAFETY RULES</i>	16
<i>TABLE SAW SAFETY RULES</i>	17
<i>POWER HAND (SKILL) SAW SAFETY RULES</i>	17
<i>DISC AND BELT SANDER SAFETY RULES</i>	18
<i>WELDING SAFETY RULES</i>	18
<i>SAFETY RULES FOR WORKING WITH SOLVENTS AND RESINS</i>	19
<i>SAFETY RULES FOR HEAVY SANDING OF WOOD AND FOAM</i>	20
<i>BEFORE LEAVING THIS SHOP</i>	20
1.4 Structures Laboratory	21
<i>BEFORE LEAVING THE LAB</i>	22
1.5 Materials Laboratory	23
1.6 Hydraulics Laboratory	25
1.7 Geotechnical Eng. Teaching Lab (More 124)	26
1.8 Geosynthetics and Soil Dynamics Lab	28
<i>Specific rules and hazards associated with these labs are:</i>	28
1.9 Geotechnical Engineering Research Lab	31
<i>Use of this area by students must be authorized by a Geotechnical faculty member or Mr. Yiming Liu.</i> 31	
<i>Specific rules and hazards associated with this lab are:</i>	31
1.10 Air Quality Laboratory Safety Program	33
1.11 Environmental Teaching Laboratory Safety Program	35
1.12 Environmental Research Laboratories	38
<i>Failure to abide by laboratory rules may result in loss of laboratory privileges.</i>	39
1.13 General Laboratory Safety	39
1.14 Biological Laboratories Safety	42
2.1 New Employee Safety Orientation	59

2.2 Office Safety	66
2.3 Lockout and Tagout.....	87
<i>Policy.....</i>	<i>87</i>
<i>Scope.....</i>	<i>87</i>
2.4 Electricity at Work	97
2.5 Storing Materials	106
<i>Flammable Storage Cabinets</i>	<i>107</i>
<i>Acid Storage Cabinets</i>	<i>108</i>
3.1 Fall Protection	110
3.2 Back – Lifting Safety	117
3.3 Hand and Portable Powered Tools	119
3.4 Vibration Hazardous	126
3.5 Machinery	128
3.6 Band Saw	132
3.7 Overhead and Gantry Cranes	134
3.8 Forklift Safety.....	138
3.9 Scaffold Safety.....	146
3.10 Welding, Cutting and Brazing.....	152
3.11 Personal Protective Equipment.....	155
3.12 General safety requirements for compressed air.....	160
<i>Safety Requirements for Operating & Maintaining Compressed Air Machinery:.....</i>	<i>161</i>
3.13 Confined Space.....	165
3.14 Temperature Stairways, Ladders and Portable Ladders	176
3.15 Chemical Storage	183
<i>Storage Requirements for Peroxidizable Chemicals</i>	<i>191</i>
3.16 Chemical Fume Hoods.....	196
3.17 Respiratory Protection	198
3.18 Hearing Conservation.....	208
3.19 Hazardous Waste Disposal.....	213
<i>Some things you should know-</i>	<i>213</i>
Individuals handling hazardous waste must:	213
4.1 Chemical Storage	216

4.2 Hazardous Materials Transportation Program.....	229
4.3 Hazardous Waste Disposal.....	241
Individuals handling hazardous waste must.....	241
Waste Minimization.....	242
4.4 Chemical and Physical Hazards Monitoring	243
4.5 Hazard Reporting and Investigation	247
4.6 Incident Report and Investigation	248
4.7 Personal Protective Equipment	249
4.8 Hazard Communication	255
4.9 Chemical Hygiene	260
4.10 Chemical Inventories	269
4.11 Hazardous Materials Management.....	270
4.12 Chemical Fume Hoods.....	272
4.13 Gas Cylinder Safety	275
4.14 Autoclave Safety	279
<i>Modes of Operation.....</i>	<i>279</i>
5.1 Chemical Storage	282
5.2 Hazardous Materials Transportation Program.....	295
5.3 Hazardous Waste Disposal.....	307
Individuals handling hazardous waste must.....	308
5.4 Chemical and Physical Hazards Monitoring	310
5.5 Hazard Reporting and Investigation	314
5.6 Incident Report and Investigation	315
5.7 Personal Protective Equipment	316
5.8 Hazard Communication	323
5.9 Chemical Hygiene	328
5.10 Chemical Inventories	337
5.11 Hazardous Materials Management.....	339
5.12 Chemical Fume Hoods.....	341
5.13 Gas Cylinder Safety	343
5.14 Autoclave Safety	347

<i>Modes of Operation</i>	348
6.1 Biohazardous Spill Response	351
6.2 Classification of Biohazardous Agents	354
6.3 Laboratory Security and Emergency Response Guidance for Laboratories Working with Select Agents	364
6.4 Definitions	366
6.5 Risk Assessment	367
6.6 Registration of Experimentation Involving Biohazardous Agents	373
6.7 Biological Safety Cabinets	374
6.8 Class II Biohazard Cabinetry Selection and Use Guide	376
6.9 Biosafety Level Laboratory Design Criteria	382
6.10 Chemical Disinfectants	386
6.11 Infectious Agent Transport Procedures	389
6.12 Procedures for Importing Etiologic Agents	399
6.13 Blood Borne Pathogens Exposure Control	402
6.14 Disposal of Biohazardous Waste	414
Autoclave Safety	417
Chemical Fume Hoods	419
Centrifuge Safety	422
7.1 Radiation Safety Training and Reference	426
<i>Radiation Safety Manual</i>	426
<i>Radiation Safety Office</i>	426
RADIATION FUNDAMENTALS	426
<i>Radioactive Decay</i>	427
<i>Characteristics of Radioactive Decay</i>	428
INTERACTION OF RADIATION WITH MATTER	429
<i>Energy Absorption</i>	429
<i>Alpha Particles</i>	429
<i>Beta Particles</i>	429
<i>Photons</i>	430
<i>Secondary Ionizations</i>	430
ACTIVITY, EXPOSURE, AND DOSE	430
<i>Definitions</i>	430
<i>Units</i>	431

<i>Calculation of Activities</i>	431
<i>Calculation of Exposure Rates</i>	432
<i>Inverse Square Law</i>	432
<i>Beta Dose Rates</i>	433
<i>Skin Dose</i>	433
BIOLOGICAL EFFECTS OF IONIZING RADIATION	433
<i>Radiation Hazards</i>	433
<i>Mechanisms of Damage</i>	434
<i>Tissue Sensitivity</i>	434
<i>Effects of Acute High Radiation Dose</i>	434
<i>Effects of Low Radiation Dose</i>	434
RADIATION DOSIMETRY PROGRAM	435
<i>External Dosimetry</i>	435
<i>Internal Dosimetry</i>	437
7.2 RADIOACTIVE MATERIAL HANDLING AND LABORATORY SAFETY	437
<i>Reduction of Dose to Personnel</i>	437
<i>TVL & HVL</i>	438
<i>Shielding Concerns</i>	438
<i>Handling Precautions</i>	438
<i>P-32 Information</i>	439
<i>S-35 Information</i>	440
<i>I-125 Information</i>	440
<i>H-3 (Tritium) Information</i>	441
<i>C-14 Information</i>	442
RADIATION SURVEY METERS	442
<i>Introduction</i>	442
<i>GEIGER-MUELLER DETECTOR</i>	442
<i>SCINTILLATION DETECTOR</i>	443
<i>ION CHAMBER</i>	443
<i>CALIBRATION</i>	444
7.3 RADIOACTIVE WASTE DISPOSAL	444
<i>Waste Minimization</i>	444
<i>Segregation by Half-Life</i>	445
<i>Disposal by Tags</i>	445
<i>Prohibited Items</i>	445
<i>LEAD PIGS/SHIELDING</i>	446
<i>GELS</i>	446

DISPOSAL PROCEDURES	446
7.4 RADIATION SAFETY FOR X-RAY UNITS.....	446
<i>Nature of Analytical X-Rays</i>	446
<i>X-Ray Hazards and Biological Effects</i>	446
<i>Sources of Ionizing Radiation</i>	447
<i>Safety Precautions and Notes</i>	447
EYE PROTECTION	448
FLUORESCENT SCREENS.....	448
TUBE STATUS INDICATORS	448
SAFETY DEVICES	448
7.5 ACCELERATOR SAFETY	449
APPENDICES	450
7.6 DOSE CONCEPTS.....	450
<i>Introduction</i>	450
<i>Total Dose Concept</i>	450
<i>Organ Dose</i>	451
<i>Definitions</i>	451
<i>Example Dose Calculations</i>	452
<i>Embryo/Fetus Dose</i>	452
<i>Dose Reporting</i>	453
<i>Dose Limits</i>	453
7.7 RADIATION RULES OF THUMB	454
<i>Alpha Particles</i>	454
<i>Beta Particles</i>	454
<i>Gammas and X-Rays</i>	454
SI UNITS AND CONVERSION FACTORS.....	455
<i>Exposure and Exposure Rate</i>	456
<i>Absorbed Dose</i>	456
<i>Dose Equivalent</i>	456
CONVERSION TABLE FOR RADIOACTIVITY.....	457
<i>SI Units</i>	457
7.8 GLOSSARY OF TERMS.....	458
REFERENCES.....	464
7.9 Emergency Procedures for Radioisotope Users.....	465
7.10 Supplies and Equipment	469
7.11 Physical Security of Radioactive Materials.....	469

7.12 Personnel Monitoring	471
7.13 Laboratory Surveys	473
7.14 Classification of Radioactive Wastes	476
8.1 Before You Leave.....	480
8.2 Medical Care and First Aid	481
Concerned Parties.....	482
Pests	482
Black Widow Brown Recluse	483
8.3 Other Environmental Hazards.....	484
8.4 Requirements for Reasonable Care	485
8.5 Responsibilities and Procedures.....	486
Resources	486
8.6 Safe Boating Policy	487
<i>Equipment Requirements - PFD</i>	<i>487</i>
<i>Personal Flotation Devices.....</i>	<i>487</i>
<i>PFD Flotation</i>	<i>489</i>
8.7 Vehicle Safety Handbook and Policy	491
8.8 Defensive Driving Techniques	494
Bicycles & Pedestrians.....	495
Seasonal Driving Recommendations	495
<i>Summer Driving.....</i>	<i>495</i>
<i>Winter Driving</i>	<i>496</i>
<i>Rain Hazards</i>	<i>497</i>
<i>Slippery Roads (wet or icy).....</i>	<i>497</i>
<i>Poor Visibility.....</i>	<i>497</i>
8.9 15-Passenger Vans safety	497
UW Fleet Services no longer offers 8, 12, or 15 passenger vans.	497
NHTSA Consumer Advisory.....	497
2001 Focus Group	498
Current Policies.....	498
<i>DRIVE SAFELY!</i>	<i>498</i>
Van Characteristics.....	498
8.10 Confined Space Program	499
9.1 Fire Protection and Prevention	512

9.2 Welding, Cutting and Brazing.....	515
9.3 Electricity.....	518
9.4 Fire Resistive Rating for Furniture, Scenery and Decorations.....	518
9.5 Fire Detection Systems	521
9.6 Portable Fire Extinguishers	523
9.7 Fixed Fire Suppression Systems	527
9.8 Fire Safety Procedure.....	539
Fire Wardens.....	540
Plan and Run a Fire Drill.....	541
<i>A Step By Step Guideline</i>	<i>541</i>
9.9 Fire Safety Review Program.....	542
10.1 Laser Safety Manual.....	546
10.2 Emergency procedures for laser equipment	546
<i>EMERGENCIES OR INCIDENTS INVOLVING LASERS</i>	<i>546</i>
10.3 Laser classification.....	547
LASER CLASSIFICATION.....	547
<i>CLASS 1</i>	<i>547</i>
<i>CLASS 2</i>	<i>547</i>
<i>CLASS 2a.....</i>	<i>547</i>
<i>CLASS 3a.....</i>	<i>547</i>
<i>CLASS 3b.....</i>	<i>547</i>
<i>CLASS 4.....</i>	<i>547</i>
<i>EMBEDDED LASERS.....</i>	<i>547</i>
10.4 Laser Associated Hazards	549
LASER HAZARDS.....	549
<i>EYE.....</i>	<i>549</i>
<i>SKIN</i>	<i>549</i>
<i>ELECTRICAL.....</i>	<i>550</i>
<i>FIRE</i>	<i>550</i>
<i>HAZARDOUS MATERIALS</i>	<i>550</i>
10.5 Laser Hazards Prevention.....	553
<i>GENERAL.....</i>	<i>553</i>
<i>BEAM CONTROL.....</i>	<i>553</i>
<i>REFLECTIONS</i>	<i>553</i>
<i>POWER LEVEL.....</i>	<i>554</i>

<i>SIGNS AND LABELS</i>	554
<i>WARNING DEVICES</i>	554
<i>CONTROL OF AREA</i>	554
<i>INTERLOCKS</i>	554
<i>PERSONAL PROTECTIVE EQUIPMENT</i>	554
Responsibilities (laser)	555
Medical surveillance	556
11.1 Inspection by Authorities	559
11.2 University of Washington EH&S Department	559
11.3 CEE Department Administration	560
11.4 Laboratory Safety Review Program	561
11.5 LAB SAFETY CHECKLIST	561
11.6 Biosafety Checklist	566
11.7 LABORATORY SAFETY CHECKLIST FOR EARTHQUAKES	571
11.8 Office Safety Checklist	573

Section 1: Shop and Lab Safety

1.1 Shop and Lab Safety Introduction

This section provides a summary of basic safety training required for work in different areas of the University of Washington Civil and Environmental Engineering department. The nature of a research environment here is one of change in operations and work procedures driven by changing technology. The goal of this document is to provide a basic understanding of safety procedures used in routine operations. It is our hope an understanding of routine safety procedures will provide a basis for development of appropriate safety guidelines to cover unique, non-routine procedures. This manual is structured to accommodate changing conditions, but is not a comprehensive training list covering all potential hazards in this facility.

Safety procedures in this manual are divided into sections. Sections cover practices related to various types of hazardous operations. This section contains a list of work and research areas in the department. Routine hazards expected in each area are given and references made to operation procedures in other parts of this manual. Review of safety sections appropriate for an area is required prior to starting work. In some cases appropriate hands-on or off-site training by Environmental Health and Safety or outside providers may be required. In some instances it may be necessary to complete off-site safety training after starting work.

In summary, before starting work:

- Review summaries in this section for your work area;
- Read safety procedures and detailed sections listed for your work area;
- Perform hands-on safety training;
- Register and perform off-site safety training as soon as possible.

1.2 More Hall and Harris Hydraulics Machine Shop Safety

Use of this machine shop is by authorized personnel only. Restrictions apply to the use of equipment in this area. Check with *Vince Chaijaroen* at 543-7433 (vchaijar@uw.edu) or *Yiming Liu* at 543-4060 (yiming@uw.edu) for training and authorization.

SHOP SAFETY and CHECK IN

The first step in preventing personal injury or machine damage in the shop is to make sure that you are familiar with and know how to correctly operate the equipment you will be using. If you don't know ask the area supervisor or call *Yiming Liu* at 543-4064 (yiming@uw.edu).

How do accidents happen?

Accidents are caused by inattention, taking chances, horseplay, bad judgment, fatigue, uncooperativeness, improper clothing, defective tools, etc.

How do we help to avoid accidents?

By strictly following the safety rules given in the following pages and **by cooperating with, and following any additional instructions**, the area supervisor might have.

Please read over this manual carefully and follow the rules described.

If you have any questions about the operation of any machine or tool ask *Yiming Liu* at 543-4064 (yiming@uw.edu).

BEFORE STARTING WORK, YOU MUST CHECK IN WITH:

Yiming Liu at 543-4064 (yiming@uw.edu)

Sign-in and out:

All shop users are required to log in before beginning work (when signing in, indicate the student number and instructor's name)! The logbook is located by the safety cabinet. Sign out after cleaning up.

1.3 GENERAL SHOP SAFETY RULES

1. Safety glasses, cover goggles, or face shields are required when in any shop area, whether working or not!!
2. Shoes must be worn in any shop area. No one **wearing sandals** will be allowed to enter any shop area. The minimum footwear must cover the entire foot.
3. Do not operate any item of equipment unless you are familiar with its operation and have been authorized to operate it. If you have any questions regarding the use of equipment ask *Yiming Liu* at 543-4064 (yiming@uw.edu).
4. No work may be performed using power tools unless at least two people are in the shop area and can see each other.
5. Avoid excessive use of compressed air to blow dirt or chips from machinery to avoid scattering chips. Never use compressed air guns to clean clothing, hair, or aim at another person.
6. In case of injury, no matter how slight, report it to *Yiming Liu* at 543-4064 (yiming@uw.edu). The campus emergency phone number is 9-911.
7. Do not attempt to remove foreign objects from the eye or body. Report to the Hall Health for medical treatment. If chemicals get in the eye(s), wash eye(s) for 15 minutes in an open flow of water before proceeding for medical treatment. Notify campus rescue at **9-911**.
8. Machines must be shut off when cleaning, repairing, or oiling.
9. Do not wear ties, loose clothing, jewelry, gloves, etc. around moving or rotating machinery. Long hair must be tied back or covered to keep it away from moving machinery. Hand protection in the form of suitable gloves should be used for handling hot objects, glass or sharp-edged items.
10. Never wear gloves when sawing, grinding or around moving machinery. The gloves/glove could get caught and drag your hands/hand in.
11. Wear appropriate clothing for the job (i.e. do not wear short sleeve shirts or short pants when welding).
12. Do not work in the shop if tired, or in a hurry.
13. Never indulge in horseplay in the shop areas.
14. All machines must be operated with all required guards and shields in place.
15. Keep fingers clear of the point of operation of machines by using special tools or devices, such as, push sticks, hooks, pliers, etc. *Never use a rag near moving machinery.*
16. A hard hammer should not be used to strike a hardened tool or any machine part. Use a soft-faced hammer.
17. Practice cleanliness and orderliness in the shop areas.
18. A brush, hook, or special tool is preferred for removal of chips, shavings, etc. from machinery. Keep the floor around machines clean, dry and free from trip hazards. Do not allow chips to accumulate.

19. Think through the entire job before starting.
20. Before starting a machine, always check it for correct setup and always check to see if machine is clear by operating it manually, if possible.
21. Do not drink alcoholic beverages before or during work in the machine shop area. Do not bring food/snacks into the shop.
22. **Don't rush or take chances. Obey all safety rules.**
23. If you have not worked with a particular material before, check the hazardous materials data sheets book for any specific precautions to be taken while working with the material. Also, ask *Yiming Liu* at 543-4064 (yiming@uw.edu) before cutting any unusual material.
24. Heavy sanding and painting should only be done in well-ventilated areas, preferably on the patio.
25. Follow all appropriate precautions when working with solvents, paints, adhesives or other chemicals. Use appropriate protective equipment.
26. Safety procedures for most shop operations are described in the *Health and Safety Procedures Notebook* located by the safety cabinet.
27. Check the power cords and plugs on portable tools before using them.
28. Always store oily rags in an approved metal container.

DRILL PRESS SAFETY RULES

1. Run drill at correct RPM for diameter of drill bit and material. Ask *Yiming* (6-4064) for the correct RPM.
2. **Always** hold work in a vise or clamp to the drill table.
3. Use a correctly ground drill bit for the material being drilled. Shop personnel can help select the correct bit.
4. Use the proper cutting fluid for the material being drilled. Ask *Yiming* (6-4064) about the appropriate fluid for the material you are machining.
5. Remove chips with a brush. **Never** by hand.
6. Ease up on drilling pressure as the drill starts to break through the bottom of the material.
7. Don't use a dull or cracked drill. Inspect the drill before using. If dull or chipped, return to *Yiming* for sharpening.
8. Don't drill with too much pressure.
9. Always try to support part on parallels or a backing board when drilling thru material.
10. **Never** place taper shank tools such as large diameter drills or tapered shank reamers in a drill chuck. Only straight shank tools such as standard drills can be clamped in chucks.
11. Always clean drill shank and/or drill sleeve, and, spindle hole before mounting.
12. Remove taper shank tools from spindle or sleeve with a drill drift and hammer.
13. **Never** try to loosen the drill chuck while the power is on.

14. Lower the drill spindle close to the table when releasing the drill chuck or taper shank drill to reduce the chance of damage in the event they fall onto the table.
15. **Never clean the machine while it is in motion!!**
16. If the drill binds in a hole, stop the machine and turn the spindle backwards by hand to release the bit.
17. **When drilling a deep hole withdraw the drill bit frequently to clear chips.**
18. Always remove the drill chuck key or the drill drift from the spindle **immediately** after using.
19. Wear safety eye protection while drilling.
20. Let the spindle stop of its own accord after turning the power off. Never try to stop the spindle with your hand.
21. Plexiglas and other brittle plastics can be difficult to drill. Ask the shop superintendent for advice on drill and coolant selection when drilling these materials.

LATHE SAFETY RULES

1. Make sure that the chuck, drive plate, or, faceplate is securely tightened onto the lathe spindle.
2. When removing the chuck, drive plate, or faceplate **turn off machine power.**
3. When installing the chuck, drive plate, or faceplate **turn off machine power.**
4. Move the tool bit a safe distance from the cullet or chuck when inserting or removing work.
5. Don't run the machine faster than the proper cutting speed.
6. In setting up the tool holder place it to the **left side of the compound slide** to prevent the compound slide from running into the chuck or spindle attachments.
7. Always clamp the tool bit as short as possible in the tool holder to prevent it from breaking or chattering.
8. Always make sure that the tool bit is sharp and has the proper clearance. Ask for assistance making adjustments.
9. If any filing is done on work revolving in the lathe, file left handed to prevent slipping into the chuck. **Never use a file without a handle.**
10. If work is turned between centers, make sure that proper adjustment is made between centers and that the tailstock is locked in place.
11. If work is being turned between centers and expands due to heat generated from cutting, readjust centers to avoid excessive friction.
12. **Do not** grasp or touch chips or turnings with your fingers, but get rid of them using a blunt instrument. It is safer to turn off the lathe before clearing chips then to leave it running.
13. Set the tool bit on centerline of work to prevent work from climbing over tool or cutting above center and dragging.
14. Don't cut work completely through when turning between centers.

15. Remove chuck key from chuck **immediately** after using.
16. Turn chuck or faceplate through by hand before turning on the power to be sure there is no binding or clearance problem.
17. Stop the machine before taking measurements.
18. **Before cleaning** the lathe remove tools from the tool post and tailstock.

MILLING MACHINE SAFETY RULES

1. Work must be clamped securely in a vise and vise clamped tightly to the table, or, work must be clamped securely to the table.
2. Do not take climb-milling cuts on the shop's mills unless instructed to do so.
3. Make sure cutter is rotating in the proper direction before cutting material.
4. Before running machine the spindle should be rotated by hand to make sure it is clear for cutting.
5. Make sure the power is off before changing cutters.
6. Always use the proper cutting fluid for the material being cut.
7. Never run the machine faster than the correct cutting speed.
8. Make sure that the machine is fully stopped before taking any measurements.
9. Always use cutters which are sharp and in good condition.
10. Don't place anything on the milling machine table such as wrenches, hammers, or tools.
11. Always stay at the machine while it is running.
12. Don't take too heavy a cut or use too rapid a feed.
13. **Remove the cullet-tightening wrench immediately after using it.**
14. If at all feasible rig a guard or shield to prevent chips from hitting other people.
15. Use the milling machine spindle brake to stop the spindle after the power has been turned off.
16. **Before cleaning** the mill remove cutting tools from the spindle to avoid cutting yourself.

GRINDING SAFETY RULES

1. Abrasive wheel machinery shall not be operated without the appropriate guards in place.
2. Tool rests on bench or pedestal grinders shall be set no more than **1/8 inch** from the wheel.
3. Never use a wheel that has been dropped or received a heavy blow, even though there may be no apparent damage. Such wheels may be weakened or unbalanced enough to fly apart on startup.
4. **Stand to one side when starting machine.**
5. Do not grind on side of wheel unless wheel is specifically designed for such use.
6. Do not use excessive pressure while grinding. On surface grinder do not exceed *.0005-inch* down feed at any time.
7. Report to the area supervisor immediately any cracked, broken or otherwise defective wheels.
8. Have the area supervisor mount and balance new wheels.
9. Keep the grinding wheel dressed. Dressing a small amount frequently is better than having to dress a lot later and will allow the wheel to cut faster, cooler and with a better surface finish. Dressing is cleaning and smoothing the surface of the grinding wheel.
10. Hold work securely while grinding, use the tool rest to support the work when off-hand grinding on bench or pedestal grinders.
11. Do not grind aluminum. Aluminum dust is explosive. Check with *Yiming* for safety instructions if aluminum must be ground.
12. Wear goggles over safety glasses when grinding on bench or pedestal grinders.
13. If a magnetic chuck is being used, on the surface grinder, make sure it is holding the work securely before starting to grind.

BAND SAW SAFETY RULES

1. The upper guide and guard should be set as close to the work as possible, at least within **1/4 inch**.
2. Never wear gloves or loose clothing and always use a push stick.
3. If the band breaks, immediately shut off the power and stand clear until the machine has stopped.
4. Examine blade before installing to see if it is cracked, do not install a cracked blade.
5. Use the proper pitch blade for the thickness of the material to be cut. There should be at least 2 teeth in the material when cutting aluminum and three teeth when cutting steel.
6. **Do not run** the band saw at a higher speed than recommended for the material being cut.
7. If the saw stalls in a cut, turn the power off and reverse the blade by hand to free it.

TABLE SAW SAFETY RULES

1. Stand to one side, never directly in line with, of work being fed through the saw.
2. Use the proper blade for the material and type of cut. Do not use a rip blade for cross cutting, or, a crosscut blade for rip sawing. Do not use a plywood blade for anything but plywood.
3. Inspect the blade before using it, to make sure it is the proper blade and is sharp and free from cracks.
4. **Never** allow your fingers to get near the blade when sawing. Use a pusher stick to rip narrow pieces of stock. Don't use pusher stick to remove scrap. For scrap removal, shut off machine and wait until blade stops, then remove scraps.
5. Do not wear gloves or loose clothing.
6. **Appropriate guards must be in place at all times.** Never remove the guard. Ask one of the shop personnel for help if you think the guard is in the way.
7. If the piece of material you are cutting is large, get someone to assist in tailing-off for you. Never try to do it alone. Tailing off refers to supporting a large work piece by supporting it underneath with your hands.
8. If you are tailing-off for someone else let them guide the work through the saw. You should just support the work without influencing the cut.
9. Never reach over the saw to obtain something from the other side.
10. When shutting off the power, never attempt to stop the saw quickly by shoving anything against the blade. Make sure the saw has stopped before leaving it.
11. Never make any adjustments to the saw while it is running. Turn off the power and make sure the saw is completely stopped before attempting to adjust it.
12. Do not allow material to collect on or around the saw table. **Sweep up sawdust and material scraps regularly** while working to minimize chances of slipping or stumbling.
13. Make sure that you clean up thoroughly around the saw before leaving the area. If you don't you could be the cause of someone else having an accident.
14. The circular blade of the table saw should be set **to 1/8 inch above the work.**
15. Get shop staff approval before using a saw. A key is needed to turn on the power.

POWER HAND (SKILL) SAW SAFETY RULES

1. Before using any power tool, inspect it to make sure the cord is not damaged in any way, that the ground pin is intact, and that the blade is sharp and undamaged.
2. Do not use the saw in a wet area.
3. Do not run the extension cord across walkways where people might trip over it or where the cord may be run over and damaged.
4. Keep your head out of the path of particles thrown out by the blade. Wear eye protection.
5. *Never allow any part of your body to get behind the saw.*

6. Disconnect the power cord before cleaning, changing blades, or making any adjustments to the saw.
7. When it is necessary to raise the guard for certain types of cuts, use the guard lever.
8. **Never** wedge, wire, or otherwise jam the guard to prevent it from working. **This is a particularly dangerous practice and will cause your permission to work in the machine shop to be revoked immediately!!!**
9. Wait until the saw stops before lifting it from a cut.
10. Before setting the saw down, make sure the guard is closed, as the blade may still be turning.
11. Don't carry the saw with your fingers on the switch trigger.
12. Don't pull the saw backwards in a cut if you can avoid it.
13. Use the proper blade for the type of cut to be made.
14. Do not use the cord to move or drag the saw.
15. Do not use the power hand saw for cuts if you cannot keep a firm and secure grip on the saw and the material being cut. A handsaw is still the best for some kinds of work and often faster.
16. Before cutting small work pieces shop personnel should be consulted.

DISC AND BELT SANDER SAFETY RULES

1. Do not operate sanders without the guards in place.
2. On the disc sander always use the downward motion side of the disc to sand. Never use the upward motion side as this can throw your part upwards with tremendous force.
3. Always attempt to place your work against the rest on the disc and belt sanders.
4. On the horizontal belt sander, always sand, so that the belt motion is away from you.
5. Do not operate machines with torn or ripped belts or disks.
6. Do not sand any material that will give off a dangerous dust. Such materials as beryllium or copper beryllium alloys must not be sanded or filed. Asbestos must not be sanded. Asbestos is an ingredient of brake shoes and pads.
7. Never attempt to grind or sand the edge of sheet metal.

WELDING SAFETY RULES

*Shop staff approval is required before using any welding equipment.

1. Welders, assistants, and anyone else in the welding area shall wear glasses or shields of recommended shades during welding operations.
2. A screen shall be erected around the welding area to protect other personnel in the shop from injury.
3. Inspect all welding equipment to be used, prior to each use, for possible damage.

4. Avoid handling oxygen bottles with greasy hands, gloves or rags. Fatal explosions have resulted from this cause.
5. Always strap tanks to a welding cart or a fixed object. Never allow a gas cylinder to be free standing. Replace the safety cap on all cylinders when not in use.
6. When arc welding, make sure work and/or work table is properly grounded.
7. Do not arc weld in a wet area.
8. Be alert to possible fire hazards. Move the object to be welded to a safe location, or, **remove all flammable materials from the work area.**
9. Never weld in the same area where degreasing or other cleaning operations are performed.
10. Keep suitable fire extinguishing equipment nearby and know how to operate it.
11. Shut off the cylinder valves when the job is completed, release pressure from the regulators by opening the torch valves momentarily and back out regulator adjusting valves. Never leave the torch unattended with pressure in the hoses.
12. Utilize all protective equipment and clothing. Do not arc weld with any part of the body uncovered, the arc light is actinic light (excessive ultraviolet) and will cause burns similar to severe sunburn.
13. Never weld inside drums or enclosed spaces without adequate ventilation, or, the use of airline respirators or self-contained breathing apparatus.
14. Check the ventilation system before starting to weld and periodically thereafter to insure adequate performance. **Welding fumes should not be allowed to get into the rest of the shop working areas.**
15. Never cut or weld any container that has held explosive or flammable materials. Use prescribed methods for cleaning or flooding.
16. Never use wrenches or tools except those provided or approved by the gas cylinder manufacturer to open valves. **Never** use a hammer to open or close valves.
17. Abide by any other safety measures required for each particular type of welding.
18. Allow for proper ventilation when brazing or soldering. The fluxes are acidic and toxic.
19. **Do not** weld on **painted, galvanized or greasy, oily metals**. Not only can the fumes be toxic, but also the welds will not be satisfactory and will fail in use.

SAFETY RULES FOR WORKING WITH SOLVENTS AND RESINS

1. Avoid skin contact. Wear latex gloves.
2. Work in a fume hood if possible. Respirators are available when necessary.
3. Avoid using solvents around hot metal surfaces and flames.
4. Do not smoke or light flames in areas where solvents are used and stored.
5. Report and clean up any spills immediately. Call EH&S at 543-0467.
6. Do not work with solvents in confined, unventilated areas.

7. **Do not** drink alcoholic beverages or take medications containing alcohol before or during working with solvents. Alcohol in the bloodstream sometimes causes synergistic reactions with various solvents that can lead to loss of consciousness, and even possibly, **death**.
8. Report any ill effects and skin disorders to *Yiming Liu* at 543-4064 (yiming@uw.edu).
9. Develop and maintain good personal hygiene habits. Remove protective equipment and wash thoroughly after contact with solvents.
10. Fumes from paints, solvents, adhesives, and the abrasive cut-off saw used on the patio can drift into the shop. Work with staff to minimize these problems.
11. Mix resins in small batches.

SAFETY RULES FOR HEAVY SANDING OF WOOD AND FOAM

1. Sand in a well-ventilated area; away from other machines (preferably on the patio).
2. Use a vacuum or a dust collector to collect dust **while** sanding to prevent the dispersal over a large area.
3. A dust mask may be worn if desired. They are stored in the safety cabinet.
4. Safety glasses must be worn.

BEFORE LEAVING THIS SHOP

1. Turn Off:
 - Gas
 - Water
 - Power Supplies
 - Vacuum Lines
 - Compression Lines
 - Heating Apparatus
 - Lights
2. Identify and Package Waste, dispose properly
3. Lock/out and Tag/out Defective Equipment
4. Decontaminate Work Surface and Equipment
5. Return Unused Equipment, Apparatus, Materials, etc.
6. Leave Personal Protective Equipment in the Lab
7. Wash
8. Close and Lock Doors

1.4 Structures Laboratory

Use of this lab is restricted to authorize personnel only. Restrictions apply to the use of equipment in this area. Check with Area Supervisor for training and authorization.

SPECIFIC RULES FOR STRUCTURES LAB:

Personal Protective Equipment:

- Eye, ear, respiratory, hand and foot protection must be worn where there is a danger of injury. In some cases the use of protective shields is adequate.
- This is a HARDHAT AREA. Hardhats must be worn when crane is in operation.
- Safety footwear is mandatory.
- See details in the Department Safety Manual under Personal Protective Equipment – Section 4.10.

Housekeeping/storage of materials:

- Scrap material must be removed as soon as possible.
- Stowed materials must be placed safely and securely to eliminate potential tripping and puncturing hazards. If necessary use barricades and tapes to cordon off hazardous areas.
- See details in the Department Safety Manual under Housekeeping Hazards – Section 3.6 and Stack of Stored Materials -- Section 3.4.

Hoists and cranes:

- Only authorized persons who have been adequately trained shall operate hoisting equipment. A maintenance and training log is kept. Training and authorization can be arranged with supervisory staff.
- Working load must never be exceeded.
- Hardhats must be worn when crane is operating. Do not operate over or near workers not involved in the procedure. Clear area or reschedule if necessary.
- For more information please see Department Safety Manual under Overhead and Gantry Cranes – Section 4.6.

Operation of machinery/tools:

- Must be by qualified and authorized personnel only.
- Training logs are maintained for operator qualification. Training and authorization must be arranged with supervisor and noted in log.
- All tools must be inspected before use and any defects reported immediately to *Vince Chaijaroen*; return promptly to their correct location after used.
- For more information please read the Department Safety Manual under Machinery – Section 4.5, Hand or Portable Power Tools – Section 4.3 and Vibration from Tools/Machinery – Section 4.4.

Hazardous Materials:

- Chemical must be properly labeled and stored safely. Material safety data sheets must be referred to before using controlled products.
- See details in the Department Safety Manual under Hazard Communication Program – Section 5.8 and Hazardous Materials Management – Section 5.12.

Ladders/mobile ladders:

- Ladders must be in good condition and be used and stored safely. Check for broken or missing steps and report to *Vince Chaijaroen*. If used in doorways or passageways they must be protected from being bumped or knocked over.
- Mobile ladders must be locked to prevent movement when in use.
- No worker is to remain on a rolling ladder while it is being moved.
- Remove all tools from the platform before moving a mobile ladder.
- See the Department Safety Manual under Temporary Stairways, Ladders and Portable Ladders -- Section 4.13 for more information.

Arc welding:

- By qualified personnel only.
- Must not be carried out unless all workers exposed to radiation from the arc wear suitable eye protection or are protected by adequate fire resistant screens, curtains or partitions.
- All welding work areas must be kept tidy to eliminate slipping or tripping hazards.
- See details in the Department Safety Manual under Welding, Cutting and Brazing – Section 4.9.

Gas welding:

- When transporting gas cylinders, valve protective caps must be in place and cylinders must be secured to dolly.
- Cylinders must be stored upright and secured to the cart or wall.
- Wear gloves and goggles for eye protection.
- Ensure that all hoses, regulators, gauges and torches are in perfect condition before using.
- Make sure there is sufficient general ventilation.
- See details in the Department Safety Manual under Welding, Cutting and Brazing – Section 4.9

Ventilation:

See the Department Safety Manual under Respiratory Protection Program – Section 4.16.

Compressed Air:

See details in the Department Safety Manual under Compressed Air and Equipment – Section 4.11.

BEFORE LEAVING THE LAB

1. Turn Off:
 - Gas
 - Water
 - Power Supplies
 - Vacuum Lines

- Compression Lines
 - Heating Apparatus
 - Lights
 - Power of Testing Machine(s) (except on going Tests)
2. Identify and Package Waste, dispose properly
 3. Lock/out and Tag/out Defective Equipment
 4. Decontaminate Work Surface and Equipment
 5. Return Unused Equipment, Apparatus, Materials, etc.
 6. Leave Personal Protective Equipment in the Lab
 7. Properly secure Forklifts and Cranes
 8. Wash
 9. Close and Lock Doors

1.5 Materials Laboratory

Specific rules and dangers associated with this lab are:

Personal Protective Equipment:

- Eye, ear, respiratory, hand and foot protection must be worn where there is danger of injury.
- Safety footwear is mandatory when handling concrete or other heavy items.
- Ear protection must be used when noise-generating equipment is in operation. All personnel in the immediate area must be warned and provided with ear protection prior to equipment use.
- When work with sand, gravel, silica or grinding residues produces air borne contaminants, all those exposed must be wearing personal protective equipment: eye goggles and dust respirators. Adequate ventilation must be provided; attempts must be made to prevent dust from entering hallways and office/equipment areas.
- Fume hood must be used for concrete cylinder capping.
- See details in the Department Safety Manual under Personal Protective Equipment – Section 4.10.

Housekeeping/Storage of materials:

- Waste material must be removed immediately.
- Minimize all tripping hazards, keep aisles and passageways as clear as possible.
- Stowed materials must be placed safely and securely to eliminate potential tripping and puncturing hazards. If necessary apply barricades and tapes to cordon off hazardous areas.
- Keep fire extinguishers accessible at all times.
- Keep exit paths clear at all times.
- See details in the Department Safety Manual under Housekeeping Hazards – Section 3.6 and Stack of Stored Materials -- Section 3.4.

Ladders/mobile ladders:

- Ladders must be in good condition and be used and stored safely. Check for broken or missing steps and report to supervisor. If used in doorways or passageways they must be protected from being bumped or knocked over.
- Mobile ladders must be locked to prevent movement when in use.
- No worker is to remain on a rolling ladder while it is being moved.
- Remove all tools from the platform before moving a mobile ladder.
- See the Department Safety Manual under Temporary Stairways, Ladders and Portable Ladders -- Section 4.13 for more information.

Chemicals:

- All chemical containers must be legibly labeled and include description of hazards.
- Chemicals must not be used without first referring to product Material Safety Data Sheet (i.e. Cilcap, acid, sodium hydroxide)
- See details in the Department Safety Manual under Hazard Communication Program – Section 5.8 and Hazardous Materials Management – Section 5.12.

Ventilation:

- See the Department Safety Manual under Respiratory Protection Program – Section 4.16.

Compressed Air:

- See details in the Department Safety Manual under Compressed Air and Equipment – Section 4.11.

Safe Lifting and Cement Burn:

- See hand out and Department Safety Manual under Lifting > 20 lbs. – Section 4.2.

BEFORE LEAVING THIS LAB

1. Turn Off:
 - Gas
 - Water
 - Power Supplies
 - Vacuum Lines
 - Compression Lines
 - Heating Apparatus
 - Lights
 - Power of Testing Machine(s) (except on going Tests)
2. Identify and Package Waste, dispose properly
3. Lock/out and Tag/out Defective Equipment
4. Decontaminate Work Surface and Equipment
5. Return Unused Equipment, Apparatus, Materials, etc.
6. Leave Personal Protective Equipment in the Lab
7. Properly secure Fork lifts and Cranes

8. Wash
9. Close and Lock Door

1.6 Hydraulics Laboratory

Specific rules and dangers associated with this lab are:

Personal Protective Equipment:

- Eye, ear, respiratory, hand and foot protection must be worn where there is danger of injury.
- Safety footwear is mandatory (no sandals or similar footwear).
- Confine long hair securely when you working or studying around the water pump.
- See details in the Department Safety Manual under Personal Protective Equipment – Section 4.10.

Housekeeping/Storage of materials:

- Waste material must be removed immediately.
- Minimize all tripping hazards; keep aisles and passageways as clear as possible.
- Stowed materials must be placed safely and securely to eliminate potential tripping and puncturing hazards. If necessary apply barricades and tapes to cordon off hazardous areas.
- Keep fire extinguishers accessible at all times.
- Keep exit paths clear at all times.
- See details in the Department Safety Manual under Housekeeping Hazards – section 3.6 and Stacks of Stored Materials – Section 3.4.

Hazardous Materials:

- All chemical containers must be legibly labeled and include description of hazards.
- Chemicals must not be used without first referring to product Material Safety Data Sheet.
- See details in the Department Safety Manual under Hazard Communication Program – Section 5.8 and Hazardous Materials Management – Section 5.12.

Ventilation:

- See the Department Safety Manual under Air contaminants, Dusts, Inert Gases and Vapors – Section 4.16.

Compressed Air:

- See details in the Department Safety Manual under Compressed Gas and Equipment – Section 4.11.

BEFORE LEAVING THIS LAB:

1. Turn off:
 - Gas

- Water
 - Power Supplies
 - Vacuum Lines
 - Compression Lines
 - Heating Apparatus
 - Lights
 - Power of Testing Machine(s) (except on going Tests)
2. Identify and Package Waste, dispose properly
 3. Lock/out and Tag/out Defective Equipment
 4. Decontaminate Work Surface and Equipment
 5. Return Unused Equipment, Apparatus, Materials, etc.
 6. Leave Personal Protective Equipment in the Lab
 7. Properly secure Fork lifts and Cranes
 8. Wash
 9. Close and Lock Doors

1.7 Geotechnical Eng. Teaching Lab (More 124)

Use of this area by students must be authorized by a geotechnical faculty member or *Yiming Liu*.

Specific rules and hazards associated with this lab are:

Equipment

- All research apparatus must have a readily visible sign giving – details of specific hazards and shutdown procedures as well as the researcher's name and phone number and name of major professor/supervisor.
- Defective equipment must not be used and must be reported immediately to *Yiming Liu* (yiming@uw.edu).

Personal Protective Equipment for all the personnel working in these labs:

- Eye, ear, respiratory, hand and foot protection must be worn where there is danger of injury.
- See details in the Department Safety Manual under Personal Protective Equipment – Section 4.10.

Housekeeping/Storage of materials:

- Review Sect. 3.6 on Housekeeping Hazards in the Department Safety Manual.
- Waste soils must be cleaned up as soon as possible at the end of each experiment. Laboratory tables should be dusted and wiped clean.

- Waste soils and paper materials must be disposed of in the appropriate containers at the north end of Room 124, or according to the laboratory instructor's directions.
- Stored materials must be placed safely and securely to eliminate potential hazards or equipment damage.
- Protection against falling materials: Items in storage areas and on shelves must be placed securely, to prevent possibility of falling.

Hazardous Material:

- All chemical containers must be properly labeled, potential hazards indicated, and stored safely. Material safety data sheets must be referred to before using controlled products.

Ventilation:

- See the Department Safety Manual Section 4.16

Ladders:

- Ladders must be in good condition and be used and stored safely. Check for broken or missing steps and parts. If anything be found unusual, report to *Yiming Liu* (yiming@uw.edu) or by phone at 543-4064). If used in doorways or passageways, they must be protected from being bumped or knocked over.
- Mobile ladders must be locked to prevent movement when in use.
- No worker is to remain on a rolling ladder while it is being moved.
- Remove all tools from the platform before moving a mobile ladder.
- See the Department Safety Manual under Temporary Stairways, Ladders and Portable Ladders -- Section 4.13 for more information.

Compressed Air:

- There are two sources of compressed air used in this laboratory: house and compressed gas tanks.

House lines supply air at a pressure of 90 psi or greater, depending on the time of day and other usage in the building. Tubes connected to the house airline valves must be properly fitted and attached safely. Avoid downstream chambers or containers with large volumes of compressed air. If they must be used for some reason, then be sure the container is pressure tested to a level at least two times the anticipate working pressure. Be sure tubing lines are securely attached to avoid sudden whipping of the tubing.

We use house air to provide a source of vacuum for deairing water and other purposes. Be sure connections to these vacuum devices are secure.

Compressed gas cylinders are especially hazardous, and a special precaution must be taken. Review Sect 5.14 on Compressed Gas Cylinder Safety before using any cylinders. A few pointers:

Be sure all cylinders are properly transported to the laboratory.

All cylinders must be securely attached to a laboratory bench with a tank vice and web belt. Be sure the set screws on the tank vise very tight, and that be bench is heavy enough to prevent accidental shifting or movement.

Microwave and Ovens:

- Take care in placing items in hot ovens.
- Do not leave your items in an oven over a week and use the log sheet to track your samples.
- Use tongs and or heat resistant gloves to remove items from a hot oven.
- Do not turn on microwave when it is empty.
- See details in the Department Safety Manual under Microwave and Oven Safety – Section 3.18.

BEFORE LEAVING THIS LAB:

1. Turn Off:
 - Gas
 - Water
 - Power Supplies
 - Compression Lines
 - Heating Apparatus
 - Lights
 - Power of Testing Machine(s) (except on going Tests)
2. Identify and Package Waste, dispose properly
3. Lock/out and Tag/out Defective Equipment and Report to Yiming at 3-4064
4. Decontaminate Work Surface and Equipment
5. Return Unused Equipment, Apparatus, Materials (Using the log Sheet), etc.
6. Leave Personal Protective Equipment in the Lab
7. Wash
8. Close and Lock Doors

1.8 Geosynthetics and Soil Dynamics Lab

Read Sections 2.6 and 2.8 of this manual. Follow all appropriate recommendations in these laboratories.

Use of this area by students must be authorized by a geotechnical faculty member or Mr. Yiming Liu.

Specific rules and hazards associated with these labs are:

Equipment:

- *All research apparatus must have a readily visible sign giving – details of specific hazards and shutdown procedures as well as the researcher’s name and phone number and name of major professor/supervisor.*

- *Defective equipment must not be used and must be reported immediately to Yiming Liu (yiming@uw.edu).*

Personal Protective Equipment for all the personnel working in these labs:

- Eye, ear, respiratory, hand and foot protection must be worn where there is danger of injury.
- See details in the Department Safety Manual under Personal Protective Equipment – Section 4.10.

Housekeeping/Storage of materials:

- Review Sect. 3.6 on Housekeeping Hazards in the Department Safety Manual.
- Waste soils must be cleaned up as soon as possible at the end of each experiment. Laboratory tables should be dusted and wiped clean.
- Waste soils and paper materials must be disposed of in the appropriate containers at the north end of Room 124, or according to the laboratory instructor's directions.
- Stored materials must be placed safely and securely to eliminate potential hazards or equipment damage.
- Protection against falling materials: Items in storage areas and on shelves must be placed securely, to prevent possibility of falling.

Hazardous Material:

- All chemical containers must be properly labeled, potential hazards indicated, and stored safely. Material safety data sheets must be referred to before using controlled products.

Ventilation:

- See the Department Safety Manual under Respiratory Protection Program – Section 4.16.

Hoists:

- Only authorized persons who have been adequately trained shall operate hoisting equipment. A maintenance and training log is kept. Training and authorization can be arranged with supervisory staff.
- Working load must never be exceeded.
- Do not operate over or near workers not involved in the procedure. Clear area or reschedule if necessary.
- For using a shop crane, see the safety label attached on the machine.

Compressed Air:

There are two sources of compressed air used in this laboratory: house and compressed gas tanks.

House lines supply air at a pressure of 90 psi or greater, depending on the time of day and other usage in the building. Tubes connected to the house airline valves must be properly fitted and attached safely. Avoid downstream chambers or containers with large volumes of compressed air. If they must be used for some reason, then be sure the container is pressure tested to a level at least two times

the anticipate working pressure. Be sure tubing lines are securely attached to avoid sudden whipping of the tubing.

We use house air to provide a source of vacuum for deairing water and other purposes. Be sure connections to these vacuum devices are secure.

Compressed gas cylinders are especially hazardous, and a special precaution must be taken. Review Sect 5.14 on Compressed Gas Cylinder Safety before using any cylinders. A few pointers:

Be sure all cylinders are properly transported to the laboratory.

All cylinders must be securely attached to a laboratory bench with a tank vice and web belt. Be sure the set screws on the tank vise very tight, and that the bench is heavy enough to prevent accidental shifting or movement.

Ladders/Mobile Ladders:

- Ladders must be in good condition and be used and stored safely. Check for broken or missing steps and parts. If anything be found unusual, report to *Yiming Liu* (yiming@uw.edu or by phone at 543-4064). If used in doorways or passageways, they must be protected from being bumped or knocked over.
- Mobile ladders must be locked to prevent movement when in use.
- No worker is to remain on a rolling ladder while it is being moved.
- Remove all tools from the platform before moving a mobile ladder.
- See the Department Safety Manual under Temporary Stairways, Ladders and Portable Ladders -- Section 4.13 for more information.

Microwave and Ovens:

- Take care in placing items in hot ovens.
- Do not leave your items in an oven over a week and use the log sheet to track your samples.
- Use tongs and or heat resistant gloves to remove items from a hot oven.
- Do not turn on microwave when it is empty.
- See details in the Department Safety Manual under Microwave and Oven Safety – Section 3.18.

BEFORE LEAVING THIS LAB

1. Turn Off:
 - Gas
 - Water
 - Power Supplies
 - Compression Lines
 - Heating Apparatus

- Lights
 - Power of Testing Machine(s) (except on going Tests)
2. Identify and Package Waste, dispose properly
 3. Lock/out and Tag/out Defective Equipment and Report to Yiming at 3-4064
 4. Decontaminate Work Surface and Equipment
 5. Return Unused Equipment, Apparatus, Materials (Using the log Sheet), etc.
 6. Leave Personal Protective Equipment in the Lab
 7. Wash
 8. Close and Lock Doors

1.9 Geotechnical Engineering Research Lab

More Hall Room 122

Use of this area by students must be authorized by a Geotechnical faculty member or Mr. Yiming Liu.

Specific rules and hazards associated with this lab are:

Equipment:

- *All research apparatus must have a readily visible sign giving – details of specific hazards and shutdown procedures as well as the researcher’s name and phone number and name of major professor/supervisor.*
- *Borrow equipment or apparatus must sign on the log sheet.*
- *Defective equipment must not be used and must be reported immediately to Yiming Liu at 3-4064 (yiming@uw.edu).*

Personal Protective Equipment:

- Eye, ear, respiratory, hand and foot protection must be worn where there is danger of injury.
- See details in the Department Safety Manual under Personal Protective Equipment – Section 4.10.

Housekeeping/Storage of materials:

- Waste material must be removed immediately at end of each experiment or according to the lab instructions directions.
- Minimize all tripping hazards; keep aisles and passageways as clear as possible.
- Materials and oil spills must be cleaned up as soon as possible.
- Stored materials or equipment must be placed safely and securely to eliminate potential hazards or equipment damage.

- Protection against falling materials: Items stored in storage areas and on shelves must be placed securely, to prevent possibility of falling.
- See details in the Department Safety Manual under Housekeeping Hazards – Section 3.6 and Stack of Stored Materials -- Section 3.4.
- Keep fire extinguishers accessible at all times.
- Keep exit paths clear at all times.
- See details in the Department Safety Manual under Housekeeping Hazards – section 3.6 and Stacks of Stored Materials – Section 3.4.

Hazardous Material:

- All chemical containers must be properly labeled, potential hazards indicated, and stored safely. Material safety data sheets must be referred to before using controlled products.

Ventilation:

- See the Department Safety Manual Section 4.16.

Compressed Air:

- See details in the Department Safety Manual under Compressed Gas and Equipment – Section 4.11.
- There are two sources of compressed air used in this laboratory: house and compressed gas tanks.
- House lines supply air at a pressure of 90 psi or slightly greater, depending on the time of day and other usage in the building. Tubes connected to the house air line valves must be properly fitted and attached safely. Avoid downstream chambers or containers with large volumes of compressed air. If they must be used for some reason, then be sure the container is pressure tested to a level at least two times the anticipated working pressure. Be sure tubing lines are securely attached to avoid sudden whipping of the tubing.
- We use house air to provide a source of vacuum for deairing water and other purposes. Be sure connections to these vacuum devices are secure.
- Compressed gas cylinders are especially hazardous, and a special precaution must be taken. Review Sect 5.14 on Compressed Gas Cylinder Safety before using any cylinders. A few pointers:
 - Be sure all cylinders are properly transported to the laboratory.
 - All cylinders must be securely attached to a laboratory bench with a tank vice and web belt. Be sure the set screws on the tank vice are very tight, and that the bench is heavy enough to prevent accidental shifting or movement.

Ladders/Mobile Ladders:

- Ladders must be in good condition and be used and stored safely. Check for broken or missing steps and parts. If anything is found unusual, report to *Yiming Liu* (yiming@uw.edu or by phone at 543-4064). If used in doorways or passageways, they must be protected from being bumped or knocked over.
- Mobile ladders must be locked to prevent movement when in use.

- No worker is to remain on a rolling ladder while it is being moved.
- Remove all tools from the platform before moving a mobile ladder.
- See the Department Safety Manual under Temporary Stairways, Ladders and Portable Ladders -- Section 4.13 for more information.

Before Leaving This Lab

1. Turn Off:
 - Gas
 - Water
 - Power Supplies
 - Compression Lines
 - Heating Apparatus
 - Lights
 - Power of Testing Machine(s) (except on going Tests)
2. Identify and Package Waste, dispose properly
3. Lock/out and Tag/out Defective Equipment and Report to Yiming at 3-4064
4. Decontaminate Work Surface and Equipment
5. Return Unused Equipment, Apparatus, Materials (Using the log Sheet), etc.
6. Leave Personal Protective Equipment in the Lab
7. Wash
8. Close and Lock Doors

1.10 Air Quality Laboratory Safety Program

Use of this Laboratory is by authorized personnel only. Restrictions apply to the use of equipment in this area. Check with Tim Gould 3-8195 (tgould@u.washington.edu) for training and authorization.

Specific rules and dangers associated with this lab are:

Personal Protective Equipment:

- Eye, ear, respiratory, hand and foot protection must be worn where there is danger of injury.
- Safety footwear is mandatory (no sandals or similar footwear).
- See details in the Department Safety Manual under Personal Protective Equipment – Section 4.10.

Housekeeping/Storage of materials:

- Waste material must be removed immediately.
- Minimize all tripping hazards; keep aisles and passageways as clear as possible.
- Stowed materials must be placed safely and securely to eliminate potential tripping and puncturing hazards. If necessary apply barricades and tapes to cordon off hazardous areas.

- Keep fire extinguishers accessible at all times.
- Keep exit paths clear at all times.
- See details in the Department Safety Manual under Housekeeping Hazards – section 3.6 and Stacks of Stored Materials – Section 3.4.

Hazardous Materials:

- All chemical containers must be legibly labeled and include description of hazards.
- Chemicals must not be used without first referring to product Material Safety Data Sheet.
- See details in the Department Safety Manual under Hazard Communication Program – Section 5.8 and Hazardous Materials Management – Section 5.12.

Ventilation:

- See the Department Safety Manual under Air contaminants, Dusts, Inert Gases and Vapors – Section 4.16.

Compressed Air:

- See details in the Department Safety Manual under Compressed Gas and Equipment – Section 4.11.

Before You Leave This Lab:

1. Turn Off:
 - Gas
 - Water
 - Power Supplies
 - Vacuum Lines
 - Compression Lines
 - Heating Apparatus
 - Lights
 - Power of Testing Machine(s) (except on going Tests)
2. Identify and Package Waste, dispose properly
3. Lock/out and Tag/out Defective Equipment
3. Decontaminate Work Surface and Equipment
4. Return Unused Equipment, Apparatus, Materials, etc.
5. Leave Personal Protective Equipment in the Lab
6. Properly secure Fork lifts and Cranes
7. Wash
8. Close and Lock Doors

1.11 Environmental Teaching Laboratory Safety Program

Safety Facts and Disclaimer Form

In order to avoid personal injuries and injuries to fellow students while performing experiments in your Chemistry Laboratory Courses, please read the following information. Once you understand the contents, sign this form and return it to your teaching assistant by the end of the lab period.

1. Approved safety goggles (NOT safety glasses) are to be worn continuously while you are in the laboratory. Safety goggles will protect your eyes against impact and splashes. These goggles are available in lab by entrances. Wearing contact lenses in a chemistry laboratory can be harmful to your visual health. Contact lenses should be replaced by prescription glasses except in the rare cases where this is not possible. Contact lens wearers must report this to the teaching assistant at the beginning of the semester. In any event, wearers of contacts or prescription glasses must protect their eyes with safety goggles.

If you get a chemical into your eyes, notify your teaching assistant immediately and wash with flowing water from the eyewash for 15-20 minutes.

2. Students, teaching assistants and other staff members are to be appropriately clothed in the laboratory at all times, including checkout. Appropriate clothing includes:
 - Clothing that protects the individual's body from the neck to below the knees. Sleeveless shirts, tank tops or other clothing that do not cover the shoulders or abdominal area are not acceptable clothing to be worn in the teaching laboratories. Shorts or skirts that do not cover the individual's knees when sitting on a lab stool are not acceptable clothing to be worn in the teaching laboratories. You may opt to wear a lab coat that covers from the neck to below the knees. The lab coat must cover the knees when sitting on a lab stool and must remain buttoned while in labs!
 - Footwear that covers the entire foot. Open toed and/or open heeled shoes, including clogs and sandals, etc. are not acceptable footwear to be worn in the teaching laboratories.
3. Perform no unauthorized experiments.
4. Never use an open flame when working with organic solvents.
5. In case of fire or accident, notify your teaching assistant at once. (Note location of fire extinguisher and safety shower before they are needed. Wet towels are very effective for smothering fires.)
6. Take special care when working with strong acids or strong bases. Contact with these materials can cause severe chemical burns.
7. Do not touch hot glassware or hot hardware. Think before you act.

8. The Department will seek medical assistance for you if you are injured in lab. Transportation will be supplied for you to a medical facility, as needed. You are responsible for all costs incurred!
9. Do not taste anything in the laboratories. (This applies to food as well as chemicals. Do not use the laboratories as an eating place and do not eat or drink from laboratory glassware.)
10. Exercise great care in noting the odor of vapors and, whenever possible, avoid breathing vapors of any kind.
11. Always use a suction bulb when filling a pipette. Never suction by mouth!
12. Don't force glass tubing into rubber stoppers.
13. Confine long hair securely when in the laboratories.
14. When working with electrical equipment, observe caution in handling loose wires and make sure that all equipment is electrically grounded before touching it.
15. Never work alone in the laboratories!

Before Leaving This Lab

1. Turn Off:
 - Gas
 - Water
 - Power Supplies
 - Vacuum Lines
 - Compression Lines
 - Heating Apparatus
 - Power of Testing Machine(s) (except on going Tests)
 - Lights
2. Identify and Package Waste, dispose properly
3. Lock/out and Tag/out Defective Equipment and Report to TA and Lab Supervisor.
4. Decontaminate Work Surface and Equipment
5. Return Unused Equipment, Apparatus, Materials, etc.
6. Leave Personal Protective Equipment in the Lab
7. Wash
8. Close and Lock Doors

Special Note Dealing with Wearing Safety Goggles in the Environmental Teaching Laboratories

Safety is a very serious issue. Protect your eyes at all times, because unforeseen accidents do take place and eyes cannot be replaced! Students and teaching assistants must continuously wear approved safety goggles (not safety glasses) while in the Environmental laboratories. This includes the entire time spent in the laboratory during checkout!

Students who do not follow this requirement during any experiment will be given a score of zero "0" for the experiment and told to leave the laboratory.

Students, who do not follow this requirement during checkout, will be told to leave and assessed a fee for failure to checkout, plus any cost for unacceptable equipment. I have read and understood the policy regarding safety facts and rules found on both side of this page.

YOUR NAME (please print) - _____

STUDENT ID # - _____

LAB ROOM # - _____

SIGNATURE - _____ DATE - _____

DAY LAB MEETS - M T W Th F (circle one)

TIME OF LAB:

RETURN THIS FORM TO YOUR TEACHING ASSISTANT

BEFORE LEAVING THE LAB.

1.12 Environmental Research Laboratories

A little bit about the lab:

The labs are located on the third floor of More Hall, primarily in rooms 314, 319, and 324.

What is here:

- The lab is equipped with instrumentation such as gas chromatographs, liquid chromatographs, inductively coupled plasma mass spectrometer, carbon analyzer, particle size analyzer, etc.
- Typical analyses: organic constituents (PCB, PAH, VFA, etc.), cations (metals -macro and trace), anions (ie chloride, sulphate), halides, nutrients (phosphorus and nitrogen forms), oxygen demand (biological and chemical), bacteriology, physical analysis (ie alkalinity, turbidity, colour, conductivity hardness, oil & grease, pH, turbidity, solids)
- Purpose: The laboratory exists to support research. Space is available to set up bench-scale treatment of ie landfill leachate, sewage, pulp and paper waste or to provide workspace for students, Profs involved in fieldwork, ie river/lake/harbor sediment or water.

Rules of Conduct:

- Use common sense.
- Do not bring food or drink into the lab.
- Know the location and use of all safety equipment in the lab. This includes personal protective equipment, safety shower, eyewash, first-aid kit, fire extinguisher and blanket.
- Wear a laboratory coat and protective glasses for all laboratory work. Wear shoes - no sandals permitted.
- Clear bench of all unnecessary materials such as packs, books, clothing before starting your work.
- Before beginning experiment, research or analysis provide technical staff with details and obtain training, if required and authorization before proceeding.
- Material Safety Data Sheets must be read for each chemical that you plan to use - before you use it.
- Do not use any laboratory equipment before receiving instruction from technical staff - not from other students.
- Laboratory and balance room must be kept as clean and neat as possible at all times. Spilled chemicals, solutions and broken glass must be cleaned up immediately. If you don't know how to proceed ask for assistance. Wash bench tops and glassware before leaving. Do not put writing utensils in your mouth if they have been on benches even if you think the bench is clean.

- All equipment and supplies are ordered by the lab manager, who maintains inventories. Please do not initiate orders through the office unless authorized by lab manager.
- All vessels (beakers, bottles, flasks) must be clearly marked with description of contents, hazardous properties if applicable, name (both) and date (including year). Samples must have description, name and date. Any samples left out on benches or in coolers that do not have identification will be discarded.
- Report all malfunctioning equipment to lab manager or other technical staff.
- If you use most of any material or notice that supplies are low, be sure to entire item on the order list by the office.
- Reference books and manuals are for use in the lab by technical staff and graduate students. Do not remove any book without authorization and return it as soon as possible. Do not take methods manuals/books to benches - transcribe information or photocopy information required.

Failure to abide by laboratory rules may result in loss of laboratory privileges.

1.13 General Laboratory Safety

CEE Laboratory Safety

Being safe in a laboratory is very important. There are many things that can easily go wrong if the proper precautions are not taken prior to and during work in a laboratory. The following are the main topics that are covered during the lab safety class.

Housekeeping

- Clear lab counter of all unnecessary materials (books, clothing, etc.) prior to beginning of your work.
- Lab tables & counter tops should be kept clean & free of unnecessary materials.
- Fume hoods are not to be used for the storage of chemicals.
- Keep all aisles and walkways in the lab clear to provide a safe walking path and an unobstructed exit.
- Do not exceed allowable quantities of chemicals.
- Do not block access to emergency equipment & utility controls.
- Inspect all equipment before use.
- Do not leave experiments unattended.
- Keep lab floor dry at all times.
- Tag all machinery under repair.
- All compressed gas cylinders must be secured and labeled. Secured with chains or straps.
- When discarding used chemicals, carefully follow the instructions provided.

- If necessary, clean equipment after use to avoid the possibility of contaminating the next person who needs to use it.
- Return all equipment, chemicals, and personal protective equipment to their designated locations.

Safety Guidelines

Before starting any work in the lab, make it a point to become familiar with the procedures and equipment that are to be used.

Inspect all equipment before use.

If you don't understand something, ask.

Do not operate equipment unless properly trained.

Avoid unnecessary movement and talk in the lab.

No food or drink in the lab.

Do not do dangerous experiments alone.

Confine long hair, and be aware of dangling jewelry.

Wear all personal protective equipment.

Do not wear contact lens in the lab.

Check chemical labels twice to ensure accuracy.

Be aware of hazard classification.

Wash your hands frequently.

Do not wear personal protective equipment outside the lab in common areas.

Do not smell or taste chemicals.

Never point the open end of a test tube toward yourself or your neighbor.

Know the location and use of:

Safety shower

First-aid kit

Exit doors

Telephones

Fire pull station

Material Safety Data Sheets (MSDS)

Never look directly down into a test tube; view contents from the side.

Vent apparatus, which may discharge toxic chemicals into local, fume hoods.

Always dispose of chemicals properly.

Before leaving the lab, ensure gas lines and water faucets are off.

Do not cover the windows of lab doors.

Maintain a clear pathway to all the safety equipment.







Fire Prevention

- Be aware of ignition sources.
- Store flammable liquids in appropriate containers and cabinets.
- Do not store incompatible materials together.
- Keep all sprinklers clear. 18 inches below must be clear.

Emergency Procedures

- CALL 911 IMMEDIATELY!
- Be familiar with evacuation plans.
- Clean up small spills.
- Immediately report all lab accidents.
- In case of chemical spill on your skin and clothing, rinse the area with plenty of water.
- If the eyes become affected by a chemical, immediately use the eye wash station and continue for 10-15 minutes, or until professional assistance is obtained.
- Minor skin burns should be placed under cold water.

UAF Hazard Color Code System

COLOR	HAZARD TYPE	STORAGE
BLUE 	Health hazard	Store in a secure poison area.
RED 	Flammable hazard	Store in a flammable liquid storage area. (Approved flammable storage cabinets.)
YELLOW 	Reactivity hazard	Store separately and away from flammable or combustible materials.
WHITE 	Contact hazard	Store in a corrosion proof area. Note: Acids and bases should be stored separately.
ORANGE 	Substances with no rating higher than two in any hazard category.	Store in a general chemical storage area.
STRIPED 	Incompatible materials of the same color class have stripped labels	Proper storage must be individually assessed.

Before Leaving This Lab

1. Turn Off:
 - Gas
 - Water
 - Power Supplies
 - Vacuum Lines
 - Compression Lines
 - Heating Apparatus
 - Lights
 - Power of Testing Machine(s) (except on going Tests)

2. Identify and Package Waste, dispose properly
3. Lock/out and Tag/out Defective Equipment
4. Decontaminate Work Surface and Equipment
5. Return Unused Equipment, Apparatus, Materials, etc.
6. Leave Personal Protective Equipment in the Lab
7. Wash
8. Close and Lock Doors

1.14 Biological Laboratories Safety

Biological hazard (biohazard) refers to plants, animals, or their products that may present a potential risk to the health and well being of humans or animals and the environment. Infectious biological agents can be bacterial, viral, rickettsial, fungal, or parasitic.

Before any work is undertaken using biological agents, a determination of the potential hazard must be made and reviewed by the Biosafety Committee. It may be necessary to develop a written Chemical Hygiene Safety Plan (Section 5.9), which includes the standard microbiology procedures and practices to be followed; special facilities and equipment needed; and safe handling, transportation, storage, and treatment procedures. An emergency action plan should be developed to cover fire, spills, accidents, injuries, illness, aerosol releases, equipment shut down procedures, etc. Also, bioresearch labs may require special placarding on their entrance doors including the universal biohazard symbol.

Bloodborne Pathogens

The University of Washington has adopted the OSHA 1910.1030 Bloodborne Pathogen Standard to protect workers who may be exposed to blood from microorganisms that can cause disease in humans. Such pathogens include the hepatitis B virus (HBV) and the human immunodeficiency virus (HIV), which causes AIDS.

Since exposure to blood could potentially be fatal, the standard covers employees who may be reasonably anticipated to come into contact with human blood and other potentially infectious materials in order to perform their jobs. "Good Samaritan" acts such as assisting a co-worker who has a nosebleed would not be covered.

The program must cover, at a minimum, the standard and an explanation of its contents; epidemiology and symptoms of bloodborne diseases; modes of transmission of bloodborne pathogens; the employer's written exposure control plan; methods of recognizing tasks that may involve exposure; methods for engineering controls and practices; the types, use, location, handling, selection, removal, decontamination, and disposal of personal protective equipment and clothing; information on the availability of the hepatitis B vaccination; measures to take and individuals to contact in the case of an emergency; steps to take in case of exposures; post-exposure evaluation and follow-up; signs, labels and/or color-coding of blood or other potentially infectious materials; and procedures for disposal of contaminated sharps and hazardous wastes.

Accurate medical records must be established and maintained for each covered employee for the length of employment plus 30 years. These records should include the name and social security

number of the employee, all hepatitis B vaccination records and medical reports, a copy of all examinations, medical testing and follow-up procedures, a copy of the health care professional's written opinions, and a copy of information provided to health care professionals.

Training records must include the dates and content of training sessions, the names and qualifications of persons conducting the training, and the names and job titles of all attendees. These must be kept for three years from the date of each training session.

EH&S has copies of the complete 1910.1030 regulations, training videos, pamphlets and sample program guides / control plans to help you develop specific compliance protocols for your areas.

Infectious Material and Waste Disposal

The terms infectious, pathological, biomedical, biohazardous, toxic, and medically hazardous have all been used to describe infectious waste. EPA and Colorado Department of Health & the Environment regulations state that for a waste to be "infectious" it must contain pathogens of sufficient virulence and quantity so that exposure to the waste by a susceptible host could result in an infectious disease. EH&S has classified biological waste into two categories:

Biohazardous - involves the presence of organisms containing recombinant DNA or any other organisms hazardous to human or animal health, including human clinical materials and materials contaminated with radioactive or Federal/State listed hazardous wastes.

Non-hazardous Biological Waste - includes plates, culture vessels, or similar materials that have an appearance similar to biohazardous materials, but are not biohazardous.

All generators of "infectious waste" must identify their waste types and either treat it on site to render the material non-infectious, or make arrangements with an EH&S approved authorized company or agency to treat their waste off-site. Please refer to Animal Carcass Disposal Policy (Appendix 12.8), Policy & Procedures For The Management Of Hazardous Material/Waste" (Appendix 12.14), and the "Interim Standard Operating Procedure For The Disposal Of Biological Waste" (Appendix 12.17).

Important factors that need to be followed for safe handling and disposal of infectious and nonhazardous biological materials are:

A. Designate, separate and specify types of infectious, chemical and radioactive wastes.

B. Segregate, collect and package at the point of generation in approved leak-proof containers which are compatible with the material and the intended treatment, and clearly identify and distinguish these receptacles from other wastes.

C. Use acceptable methods, which render the waste non-infectious (e.g., autoclaving, decontamination, chemical disinfections, sterilization by other pre-approved methods).

D. Transportation and storage must be in sealed containers (see A. & B. above) so that a release of untreated infectious waste will be prevented. Nuisance conditions and health exposures shall be controlled by temporary storage at low temperatures before deactivation or shipment.

E. Placard all infectious waste receptacles using the universal biological hazard symbol (infectious waste) and place in biohazard plastic autoclave bags.

F. Contingency planning should be provided for emergency situations such as: accidents, injuries, spills, container rupture, equipment failure, etc. (see Emergency Action Plan, Appendix 12.2).

G. Training should be provided to all applicable staff, regarding aspects of safe use, handling, storage, transportation, contingency plans, documentation, and record keeping. Training should also be given to custodial staff to help prevent injury and exposure.

H. If the materials are **non-infectious**, but have an appearance similar to biohazardous materials, place materials in a non-leaking autoclave bag and follow the Interim Standard Operating Procedure For The Disposal Of Biological Waste (Appendix 12.17).

I. If the materials are **infectious only**, place materials in non-leaking autoclavable bags which have an indicator that the bag has been autoclaved. These materials can also be rendered non-infectious by chemical disinfections. Please follow the Interim Standard Operating Procedure For The Disposal Of Biological Waste (Appendix 12.17).

J. If the materials are **infectious and contaminated with hazardous wastes**, place materials in non-leaking autoclavable bags which have an indicator that the bag has been autoclaved. These materials can also be rendered non-infectious by chemical disinfections. After materials have been rendered non-infectious, they must be removed from the autoclave bag and placed in an appropriate container that conforms to the most current Policy & Procedures For The Management Of Hazardous Material/Waste (Appendix 12.14).

K. If the materials are **infectious and contaminated with radioactive materials**, place materials in non-leaking autoclavable bags which have an indicator that the bag has been autoclaved. These materials can also be rendered non-infectious by chemical disinfections. After materials have been rendered non-infectious, please contact the EH&S Health Physics group at 492-6523 for instructions on how to dispose of these radioactive materials.

L. If the materials are **infectious and contaminated with both radioactive materials and hazardous wastes**, place materials in non-leaking autoclavable bags which have an indicator that the bag has been autoclaved. These materials can also be rendered non-infectious by chemical disinfections. After materials have been rendered non-infectious, contact the EH&S Health Physics group at 492-6523 for instructions on how to dispose of materials which are still contaminated with radioactive and hazardous wastes.

Carcinogens, Mutagens, and Teratogens

CAUTION: These materials may have adverse effects on the human reproductive system and fetus. Women of childbearing age should exercise extra caution to avoid contact. For additional information contact EH&S.

It is University policy that when any known or suspected carcinogen, mutagen, or teratogen is used, appropriate health and safety procedures, such as those specified by MSDS, the National Institute of Health, OSHA, NIOSH, the Department of EH&S, and other agencies, are followed.

Responsibility and Compliance

The principal investigator or the supervisor of the work activity is responsible for assuring that proper written safety principles and practices are followed.

The Department of EH&S is available for interpreting this information, providing workers with general testing of ventilation and containment, identifying suspected carcinogens, mutagens, and teratogens, disseminating pertinent information, and providing assistance that will aid in protecting faculty, staff, and students from exposure.

The investigator, supervisor, laboratory researcher and safety liaison should also be alert to new developments that indicate certain substances are carcinogenic. See Responsibility for Laboratory Safety (Section 10.1) and Chemical Hygiene Safety Plan (Section 10.2).

Medical Surveillance

EH&S recommends that a preassigned physical exam should be conducted at the department's expense to establish a baseline for comparison to subsequent findings. Examinations should cover hematologic, urinary, and hepatic parameters. Where methods are available for monitoring exposure to specific carcinogens, they should be used for personnel who will be working with those agents. Periodic examinations should be performed on a regular basis (as recommended by the attending physician) after evidence of exposure and before termination of employment (see Chemical Hygiene Safety Plan, Section 10.2).

Probability of Human Intake or Contact

There are many factors that affect the likelihood that a material will be contacted by or taken into a person's body. Materials with high vapor pressures and low boiling points are likely to become airborne. A highly reactive material may react vigorously or explode and be dispersed into the atmosphere of the work area. Work requiring complex reactions, distillations, or vacuum or pressure systems can also create loss of containment and material dispersion. Proper precautions and restrictions including engineering controls (ventilated enclosures, etc.) should be observed if, during its use, the material will be dissolved, separated, divided, or acted on chemically in a way which may cause it to become available for skin contact or bodily intake. Whenever possible, substitute non-carcinogenic materials and as with all chemical procedures, minimize the quantities purchased, used and stored.

Handling Chemical Carcinogens

Carcinogens are to be used and handled in a regulated area where entry and exit are controlled. Regulated areas must be maintained at negative pressure with respect to non-regulated areas. Entrance to these areas should be posted with signs bearing the legend(s):

CAUTION; SUSPECT OR KNOWN CANCER AGENT EXPOSED IN THIS AREA; PERSONAL PROTECTIVE EQUIPMENT REQUIRED; AUTHORIZED PERSONNEL ONLY

Also, entrances to storage areas (cabinets, freezers, hoods, etc.) where carcinogens are stored should be marked: **CAUTION: CANCER AGENTS STORED IN THIS AREA.** Doors to storage areas should be locked at all times.

All containers should be labeled identifying the contents and responsible persons, dated, and bear yellow tape with the proper warning: **CAUTION - CANCER CAUSING AGENT.**

Any equipment, material, or other items taken into or removed from a regulated area should be done in a manner that does not cause contamination of non-regulated areas or the external environment. Decontamination procedures should be established and implemented to remove carcinogens from surfaces of materials, equipment, and the facility. *Dry sweeping and dry mopping are prohibited.*

Only those persons who have been trained in the procedures contained herein are to be permitted in the restricted area. The supervisor or responsible investigator should frequently inspect and survey the facility to ascertain that each worker is following proper laboratory instructions and procedures.

Prior to exiting a regulated area, employees should be required to remove and leave protective clothing for purpose of decontamination or disposal and follow proper personal washing procedures.

Separate change rooms, toilets, washing and shower facilities should be provided for the use of workers in an area between the regulated and clean areas to prevent human contamination with carcinogens or spread of carcinogens to other persons in non-regulated areas. Workers should wash hands immediately after working with carcinogens and immediately after exposure (shower if appropriate).

BLOODBORNE PATHOGEN STANDARD

Purpose

The purpose of the Bloodborne Pathogens Standard is to limit occupational exposure to blood and other potentially infectious materials since exposure could result in transmission of bloodborne

pathogens, which could lead to disease or death. (A copy of the regulations may be obtained by [clicking here](#))

Scope

1. This standard covers all employees who could be "reasonably anticipated"

As the result performing their job duties to face contact with blood and other potentially infectious materials. OSHA has not attempted to list all occupations where exposures could occur. "Good Samaritan" acts such as assisting a co-worker with a nosebleed would not be considered occupational exposure

2. Infectious materials include semen, vaginal secretions, cerebrospinal fluid, synovial fluid, pleural fluid, pericardial fluid, peritoneal fluid, amniotic fluid, saliva in dental procedures, any body fluid visibly contaminated with blood and all body fluids in situations where it is difficult or impossible to differentiate between body fluids. They also include any unfixed tissue or organ other than intact skin from a human (living or dead) and human immunodeficiency virus (HIV)-containing cell or tissue cultures, organ cultures and HIV or hepatitis B (HBV)-containing culture or medium or other solutions as well as blood, organs or other tissues from experimental animals infected with HIV or HBV.

Since there is no population that is risk free for HIV or HBV infectivity, any employee who has occupational exposure to blood or other potentially infectious material will be included within the scope of this standard. Although a list is included below of a number of job classifications that may be associated with tasks that have occupational exposure to blood and other potentially infectious materials, the scope of this standard is in no way limited to employees in these jobs. The hazard of exposure to infectious materials affects employees in many types of employment and is not restricted to the health care industry.

At the same time, employees in the following jobs are not automatically covered unless they have occupational exposure:

Physicians, physician's assistants, nurses, nurse practitioners, and other health care employees in clinics and physicians' offices;

Employees of clinical and diagnostic laboratories;

Housekeepers in health care facilities;

Personnel in hospital laundries or commercial laundries that service health care or public safety institutions;

Tissue bank personnel;

Employees in blood banks and plasma centers who collect, transport, and test blood;

Freestanding clinic employees (e.g., hemodialysis clinics, urgent care clinics, health maintenance organization (HMO) clinics, and family planning clinics);

Employees in clinics in industrial, educational, and correctional facilities (e.g., those who collect blood, and clean and dress wounds);

Employees assigned to provide emergency first aid;

Dentists, dental hygienists, dental assistants and dental laboratory technicians;

Staff of institutions for the developmentally disabled;

Hospice employees;

Home health care workers;

Staff of nursing homes and long-term care facilities;

Employees of funeral homes and mortuaries;

HIV and HBV research laboratory and production facility workers;

Employees handling regulated waste;

Medical equipment service and repair personnel;

Emergency medical technicians, paramedics, and other emergency medical service providers; and

Fire fighters, law enforcement personnel, and correctional officers (employees the private sector, and federal government, or a state or local government in a state that has an OSHA-approved state plan).

Other Criteria

Part-time, temporary, and health care workers known as "per diem" employees are covered by this standard.

If an employee is trained in first aid and designated by the employer as responsible for rendering medical assistance as part of his/her job duties, that employee is covered by the standard. This definition does not cover "good Samaritan" acts that result in exposure to blood or other potentially infectious materials from assisting a fellow employee, although OSHA encourages employers to offer follow-up procedures in such cases.

"Other Potentially Infectious Materials" (OPIM) coverage extends to blood and tissues of animals that are deliberately infected with HIV or HBV.

Employees in the construction and maritime industries who have occupational exposure to blood or OPIM are covered by the standard.

"Parenteral" includes human bites that break the skin, which are most likely to occur in violent situations such as may be encountered by prison personnel and police and in emergency rooms or psychiatric wards.

Infection Control Plan

Requires employers to *identify, in writing* tasks and procedures as well as job classifications *where occupational exposure to blood occurs*-- without regard to personal protective clothing and equipment. It must also set forth the *schedule for implementing other provisions* of the standard and specify the procedure for evaluating circumstances surrounding exposure incidents. The plan must be accessible to employees and available to OSHA. Employers must review and update it at least annually--more often if necessary to accommodate workplace changes. A **model infection/exposure control plan** can be found in the Appendices

Methods of Compliance

1. Mandates universal precautions, (treating body fluids/materials as if infectious) emphasizing engineering and work practice controls. The standard stresses hand washing and requires employers to provide facilities and ensure that employees use them following exposure to blood. It sets forth procedures to minimize needle sticks, minimize splashing and spraying of blood, ensure appropriate packaging of specimens and regulated wastes and decontaminate equipment or label it as contaminated before shipping to servicing facilities.
2. Employers must provide, at no cost, and require employees to use appropriate personal protective equipment such as gloves, gowns, masks, mouthpieces and resuscitation bags and must clean, repair and replace these when necessary. Gloves are not necessarily required for routine phlebotomies in volunteer blood donation centers but must be made available to employees who want them.
3. The standard requires a written schedule for cleaning, identifying the method of decontamination to be used, in addition to cleaning following contact with blood or other potentially infectious materials. It specifies methods for disposing of contaminated sharps and sets forth standards for containers for these items and other regulated waste. Further, the standard includes provisions for handling contaminated laundry to minimize exposures.

HIV and HBV Research Laboratories and Production Facilities

Calls for these facilities to follow standard microbiological practices and specifies additional practices intended to minimize exposures of employees working with concentrated viruses and reduce the risk of accidental exposure for other employees at the facility. These facilities must include required containment equipment and an autoclave for decontamination of regulated waste and must be constructed to limit risks and enable easy clean up. *Additional training and experience requirements apply to workers in these facilities.*

Hepatitis B Vaccination

Requires vaccinations to be made available to all employees who have occupational exposure to blood within 10 working days of assignment, at no cost, at a reasonable time and place, under the supervision of licensed physician/licensed healthcare professional and according to the latest

recommendations of the U.S. Public Health Service (USPHS). Prescreening may not be required as a condition of receiving the vaccine. Employees must sign a declination form if they choose not to be vaccinated, but may later opt to receive the vaccine at no cost to the employee. Should booster doses later be recommended by the USPHS, employees must be offered them.

Post-Exposure Evaluation and Follow-up

Specifies procedures to be made available to all employees who have had an exposure incident plus any laboratory tests that must be conducted by an accredited laboratory at no cost to the employee. Follow-up must include confidential medical evaluation documenting the circumstances of exposure, identifying and testing the source individual if feasible, testing the exposed employee's blood if he/she consents, post-exposure prophylaxis, counseling and evaluation of reported illnesses. Healthcare professionals must be provided specified information to facilitate the evaluation and their written opinion on the need for hepatitis B vaccine must be supplied to the employer. All diagnoses must remain confidential.

Hazard Communication

The Hazard Communication Standard (Right-to-know law) requires warning labels including the orange or orange-red biohazard symbol affixed to containers of regulated waste, refrigerators and freezers and other containers, which are used to store or transport blood or other potentially infectious materials. Red bags or containers may be used instead of labeling.

When a facility uses universal precautions in its handling of all specimens, labeling is not required within the facility. Likewise, when all laundry is handled with universal precautions, the laundry need not be labeled. Blood that has been tested and found free of HIV or HBV and released for clinical use, and regulated waste which has been decontaminated, need not be labeled. Signs must be used to identify restricted areas in HIV and HBV research laboratories and production facilities.

Information and Training

Mandates training within 90 days of effective date, initially upon assignment and annually--employees who have received appropriate training within the past year need only receive additional training in items not previously covered. Training must include making accessible a copy of the regulatory text of the standard and explanation of its contents, general discussion on bloodborne diseases and their transmission, exposure control plan, engineering and work practice controls, personal protective equipment, hepatitis B vaccine, response to emergencies involving blood, how to handle exposure incidents, the post-exposure evaluation and follow-up program, signs/labels/color-coding. There must be opportunity for questions and answers, and the trainer must be knowledgeable in the subject matter. **Laboratory and production facility workers must receive additional specialized initial training.**

Record keeping

Calls for medical records to be kept for each employee with occupational exposure for the duration of employment plus 30 years, must be confidential and must include name and social security number; hepatitis B vaccination status

(including dates); results of any examinations, medical testing and follow-up procedures; a copy of the healthcare professional's written opinion; and a copy of information provided to the healthcare professional. Training records must be maintained for three years and must include dates, contents of the training program or a summary, trainer's name and qualifications, names and job titles of all persons attending the sessions. Medical records must be made available to the subject employee, anyone with written consent of the employee, OSHA and NIOSH--they are not available to the employer. Disposal of records must be in accord with OSHA's standard covering access to records.

Dates

Effective Date: March 6, 1992. Exposure Control Plan: May 5, 1992.

Information and Training Requirements and Record keeping: June 4, 1992.

And the following other provisions take effect on July 6, 1992: engineering and work practice controls, personal protective equipment, housekeeping, special provisions covering HIV and HBV research laboratories and production facilities, hepatitis B vaccination and post-exposure evaluation and follow-up and labels.

BIOSAFETY IN MICROBIOLOGICAL LABORATORIES

The general hazards associated with microorganisms are

1. Exposure of people to the toxic byproducts of the organisms
2. Infection of people or other living beings (which might later function as disease carriers) with hazardous microorganisms, which initiate disease (pathogens).

The Center for Disease Control and National Institutes of Health (CDC/NIH) provide guidance for selection of an appropriate biosafety level and specific information on laboratory hazards associated with a particular agent or animal study and recommendations regarding practical safeguards that can significantly reduce the risk of laboratory-associated diseases. Selection of a biosafety level depends upon a number of factors including: the virulence, pathogenicity, biological stability, route of spread, and communicability of the agent; the nature or function of the laboratory; the procedures and manipulations involving the agent; the endemicity of the agent; and the availability of effective vaccines or therapeutic measures.

Risk assessments and biosafety levels recommended presuppose a population of immunocompetent individuals. Persons with altered immunocompetence may be at an increased risk when exposed to infectious agents. The laboratory director/supervisor is responsible for appropriate risk assessment, designation of biosafety level, and supervisor for providing appropriate training of personnel and assuring utilization of appropriate proactive, containment equipment, and facilities for infectious agents or infected animals.

General criteria for determining the laboratory Biosafety Level (BSL) are taken verbatim from CDC/NIH guidelines. For more specific information on agents, practices and techniques, safety

equipment and laboratory facilities see Biosafety in Microbiological and Biomedical Laboratories.

Biosafety Level 1 practices, safety equipment, and facilities are appropriate for undergraduate and secondary educational training and teaching laboratories, and for other facilities in which work is done with defined and characterized strains of viable microorganisms not known to cause disease in healthy adult humans. *Bacillus subtilis*, *Naegleria gruberi*, and infectious canine hepatitis virus are representative of those microorganisms meeting these criteria. Many agents not ordinarily associated with disease processes in humans, are, however, opportunistic pathogens and may cause infection in the young, the aged, and immunodeficient or immunosuppressed individuals. Vaccine strains which have undergone multiple *in vivo* passages should not be considered a virulent simply because they are vaccine strains.

Biosafety Level 1 represents a basic level of containment that relies on standard microbiological practices with no special primary or secondary barriers recommended, other than a sink for handwashing.

Biosafety Level 2 practices, equipment, and facilities are applicable to clinical, diagnostic, teaching and other facilities in which work is done with the broad spectrum of indigenous moderate-risk agents present in the community and associated with human disease of varying severity. With good microbiological techniques, these agents can be used safely in activities conducted on the open bench, provided the potential for producing splashes or aerosols is low. Hepatitis B virus, the salmonellae, and *Toxoplasma* spp. are representative of microorganism assigned to this contaminated level. Biosafety Level 2 is appropriate when work is done with any human-derived blood, body fluids, or tissues where the presence of an infectious agent may be unknown. (Laboratory personnel working with human-derived materials should refer to the Bloodborne Pathogen Standard 187 for specific, required precautions).

Primary hazards to personnel working with these agents relate to accidental percutaneous or mucous membrane exposures, or ingestion of infectious materials. Extreme precaution with contaminated needles or sharp instruments must be emphasized. Even though organisms routinely manipulated at BSL2 are not known to be transmissible by the aerosol route, procedures with aerosol or high splash potential that may increase the risk of such personnel exposure must be conducted in primary containment equipment, or devices such as a biosafety cabinet or safety centrifuge cups. Other primary barriers should be used as appropriate, such as splash shields, face protection, gowns, and gloves.

Secondary barriers such as handwashing and waste decontamination facilities must be available to reduce potential environmental contamination.

Biosafety Level 3 practices, safety equipment, and facilities are applicable to clinical, diagnostic, teaching, research, or production facilities in which work is done with indigenous or exotic agents with a potential for respiratory transmission, and which may cause serious and potentially lethal infection. *Mycobacterium tuberculosis*, St. Louis encephalitis virus, and *Coxiella burnetii* are representative of microorganisms assigned to this level. Primary hazards to personnel working with these agents relate to autoinoculation, ingestion, and exposure to infectious aerosols.

At BSL 3, more emphasis is placed on primary and secondary barriers to protect personnel in contiguous areas, the community, and the environment from exposure to potentially infectious aerosols. For example, all laboratory manipulations should be performed in biosafety cabinet or

other enclosed equipment, such as a gas-tight aerosol generation chamber. Secondary barriers for this level include controlled access to the laboratory and a specialized ventilation system that minimizes the release of infectious aerosols from the laboratory.

Biosafety Level 4 practices, safety equipment, and facilities are applicable for work with dangerous and exotic agents that pose a high individual risk of life-threatening disease, which may be transmitted via the aerosol route, and for which there is no available vaccine or therapy. Additionally, agents with a close or identical antigenic relationship to BSL 4 agents should also be handled at this level. When sufficient data are obtained, work with these agents may continue at this level or at a lower level. Viruses such as Marburg or Congo-Crimean hemorrhagic fever are manipulated at BSL 4.

The primary hazards to personnel working with BSL 4 agents are respiratory exposure to infectious aerosols, mucous membrane exposure to infectious droplets, and autoinoculation. All manipulations of potentially infectious diagnostic materials, isolates, and naturally or experimentally infected animals pose a high risk of exposure and infection to laboratory personnel, the community, and the environment.

Laboratory Biosafety Level Criteria

The essential elements of the four biosafety levels for activities involving infectious microorganisms and laboratory animals are summarized in Tables 3.1 and 3.2. The levels are designated in ascending order, by degree of protection provided to personnel, the environment, and the community.

Table 3.1 Summary of recommended biosafety levels for infectious agents.

BSL	Agents	Practices	Safety Equipment (Primary Barriers)	Facilities (Secondary Barriers)
1	Not known to cause disease in healthy adults	Standard Microbiological Practices	None required	Open bench top Sink required
2	Associated with human disease. Hazard: percutaneous exposure, ingestion, mucous membrane exposure.	BSL - I practice plus: •Limited access •Biohazard warning sign •"Sharps" Precautions •Biosafety manual defining any needed waste decontamination or medical surveillance policies	Primary barriers = Class I or II BSCs or other physical containment devices used for all manipulations of agent that cause splashes or aerosols of infectious materials. PPE: laboratory coats; gloves; face protection as needed	BSL - 1 Plus: Autoclave available
3	Indigenous or exotic agents with potential for aerosol transmission; disease may have serious or lethal consequences	BSL - 2 practice plus: •Controlled access •Decontamination of all waste •Decontamination of lab clothing before laundering •Baseline serum	Primary barriers - Class I or II BSCs or other physical containment devices used for all manipulations of agents. PPE: protective lab clothing; gloves; respiratory protection as needed	BSL - 2 plus: •Physical separation from access corridors •Self-closing, double door access •Exhausted air not recirculated •Negative airflow into laboratory
4	Dangerous/exotic agents which pose high risk of life threatening disease, aerosol-transmitted lab infections, or related agents with unknown risk of transmission	BSL - 3 practices plus: •Clothing change before entering •Shower on exit •All material decontaminated on exit from facility	Primary barriers = All procedures conducted in Class III BSCs or Class I or II BSCs <u>in combination with full body, air-supplied, positive pressure suit</u>	BSL - 3 plus: •Separate building or isolated zone •Dedicated supply/exhaust, vacuum, and decon systems •Other requirements outlined in the text

BSL = Biosafety level BSC = Biosafety cabinet PPE = Personal protective equipment

Table 3.2 Summary of recommended biosafety levels for activities in which experimentally or naturally infected vertebrate animals are used.

ABSL	Agents	Practices	Safety Equipment (Primary Barriers)	Facilities (Secondary Barriers)
1	Not known to cause disease in healthy human adults	Standard animal care and management practices, including appropriate medical surveillance programs	As required for normal care of each species.	Standard animal facility <ul style="list-style-type: none"> • Non recirculation of exhaust air • Directional air flow recommended
2	Associated with human disease. Hazard: Percutaneous exposure, ingestion, mucous membrane exposure.	ABSL -1 practices plus: <ul style="list-style-type: none"> • Limited access • Biohazard warning signs • Sharps precautions • Biosafety manual • Decontamination of all infectious wastes and of animal cages prior to washing 	ABSL -1 plus primary barriers: containment equipment appropriate for animal species. ppe: laboratory coats, gloves, face and respiratory protection as needed	ASBL -1 plus: <ul style="list-style-type: none"> • Autoclave available • Handwashing sink available in the animal room.
3	Indigenous or exotic agents with potential for aerosol transmission; disease may have serious health effects.	ABSL -2 practices plus: <ul style="list-style-type: none"> • Controlled access • Decontamination of clothing before laundering • cages decontaminated before bedding removed • Disinfectant foot bath as needed 	ABSL -2, equipment plus: <ul style="list-style-type: none"> • Containment equipment for housing animals and cage dumping activities • Class I or II BSCs available for manipulative procedures (inoculation, necropsy) that may create infectious aerosols. ppe: appropriate respiratory protection 	ABSL -2 facility plus: <ul style="list-style-type: none"> • Physical separation from access corridors • Self-closing, double door access • Sealed penetrations, sealed windows • Autoclave available in facility
4	Dangerous exotic agents which pose high risk of life threatening disease;	ABSL -3 practices plus: <ul style="list-style-type: none"> • Entrance through change room where personal clothing is 	ABSL -3 equipment plus: <ul style="list-style-type: none"> • Maximum containment equipment (i.e. Class III BSC or partial 	ABSL -3 facility plus: <ul style="list-style-type: none"> • Separate building or isolated zone.

	Aerosol transmission or related agents with unknown risk of transmission.	removed and laboratory clothing is put on; shower on exiting; <ul style="list-style-type: none"> • All wastes are decontaminated before removal from the facility 	containment equipment in combination with full body, air-supplied positive-pressure personnel suit) used for all procedures and activities	<ul style="list-style-type: none"> •Dedicated supply/exhaust, vacuum, and decon systems • Other requirement outlined in the text.
--	---	---	--	---

ABSL = Animal Biosafety Level BSC = Biosafety Cabinet PPE = Personal Protective Equipment

Biohazard Symbol.145 (E)(4)

The biological hazard warning shall be used to signify the actual or potential presence of a biohazard and to identify equipment, containers, rooms, materials, experimental animals, or combinations thereof, which contain, or are contaminated with, viable hazardous agents.

The symbol design for biological hazard tags shall conform to the design shown below, in the following colors:

"BIOLOGICAL HAZARD" -- Florescent orange or orange-red, or predominantly so, with lettering or symbols in a contrasting color.

BIOSAFETY IN RECOMBINANT DNA EXPERIMENTS

It was realized during the early development of genetic engineering techniques that potential risks to the safety of laboratory personnel, the general public, and the environment were possible. Meetings of scientists and administrators from governmental agencies, educational institutions and industrial laboratories led to the development of safety regulations and guidelines. The guidelines are now published and issued by the National Institute of Health (NIH).*

Institutional Biosafety Committee

The NIH guidelines direct the establishment of a local Institutional Biosafety Committee (IBC) to "review, approve, and oversee" genetic engineering research projects on this campus. The IBC is composed of laboratory scientists, others with experience and expertise in recombinant DNA technology, and members of the community. This committee has the responsibility to assess the safety of recombinant DNA experiments and potential risks to public health or environment caused by such experiments. This group is committed to adherence to the NIH guidelines, and if necessary and appropriate, the development of any special procedures, or physical or biological barriers, which enhance the safety practices, presented in those guidelines. The committee, the principal investigators, the laboratory technical personnel, and the administration of New Mexico State University will take precautions to ensure that genetic engineering research at New Mexico State University is carefully monitored and controlled according to the NIH guidelines in order to ensure safety to all concerned.

Administrative procedures to facilitate IBC project review are established with the Office of Sponsored Programs. An assessment of the required containment levels and adequacy of local facilities will be made considering proposed procedures, laboratory practices, and the training and expertise of personnel involved in the project. The review will also evaluate emergency plans

covering accidental spills and personnel contamination resulting from the research. The principal investigator and the institution will be notified in writing of the results of the review.

Liaison will be maintained between the committee and the principal investigator for the duration of the project. The IBC will maintain a current inventory of principal investigators, technicians and students engaged in recombinant DNA projects, including a description of the research and where it is being conducted. This will be accomplished by means of an administrative form which will be completed semi-annually by those concerned. This form shall also be completed by personnel involved before any new research may commence and the materials for this research (organisms, plasmids, or viruses) may be received by the laboratory.

Principal investigators

It is understood that the principal investigators, regardless of the funding source for their research, are responsible for complying fully with the NIH guidelines pertaining to recombinant DNA research. They should notify the IBC of all projects involving recombinant DNA. It is important that they be aware of potential hazards of their research program and that appropriate safety precautions be taken. This includes the safety training of laboratory associates and technicians. Principal investigators are also responsible for reporting hazards, spills and accidents that may occur to the institution Safety Office (Environmental Health and Safety).

NIH guidelines

The NIH guidelines provide standards for evaluating the conceivable danger of particular experiments involving recombinant DNA molecules by providing containment, or safeguard, levels which are dependent on the assessed possible dangers of the experiment. In the absence of evidence of any hazard actually occurring, these standards are based on relevant current knowledge. Certain experiments that have potential for extreme hazard are prohibited.

The safeguards in the NIH guidelines require the use of procedures and physical containment systems to protect laboratory workers and the environment from exposure to potentially harmful organisms. These requirements include procedures, equipment, special features of laboratory and building construction, and appropriate training of workers. The systems are grouped into four "biosafety levels" of containment -- BL1, BL2, BL3, and BL4. Each category provides a level of containment more restrictive than the one preceding it. The level of containment chosen is based on an assessment of the degree of hazard involved considering the combinations of vectors and recombinant DNA hosts and the potential of escape and survival of the host-vector combination.

The NIH guidelines are available on microfiche at the Government Documents section of the NMSU Branson Library or, a copy may be "checked out" from the IBC chair for the purpose of duplication by principal investigators for their own files.

BIOLOGICAL WASTE MANAGEMENT

All laboratories must segregate ordinary autoclaved waste (**Biosafety Level 1**) from infectious waste (**Biosafety Level 2**). Waste generated from laboratories designated as Biosafety Level 3 or 4 must be handled with individual special consideration. New Mexico Solid Waste Management

Regulations regarding landfill disposal of biohazard waste applies without regard to the quantity of infectious waste produced by each laboratory. The *NMSU Procedure for Laboratory Microbiological Wastes*, Appendix IV, **must be posted or distributed** within each laboratory generating autoclaved microbiological wastes.

Procedures for disposal of preserved biological wastes can be found in this Manual, Disposal of Biohazardous Waste - Section 6.12. Fresh biological material can be disposed of via landfill and is the responsibility of the laboratory director/supervisor.

Before Leaving This Lab

1. Turn Off:
 - Gas
 - Water
 - Power Supplies
 - Vacuum Lines
 - Compression Lines
 - Heating Apparatus
 - Lights
 - Power of Testing Machine(s) (except on going Tests)
2. Identify and Package Waste, dispose properly
3. Lock/out and Tag/out Defective Equipment and Report to TA and Lab Supervisor
4. Decontaminate Work Surface and Equipment
5. Return Unused Equipment, Apparatus, Materials, etc.
6. Leave Personal Protective Equipment in the Lab
7. Wash
8. Close and Lock Doors

Section 2: Safety Checklists

2.1 New Employee Safety Orientation

Employee Name: _____

Job Title: _____ SSN: _____

Topics 1-4 are contained in the departmental Emergency Operations Plan. Reviewing this plan during the orientation will more than meet the requirements of these first few topics.

1. Reporting Emergencies

Tell and show the new employee(s) the police, medical, and fire emergency reporting number(s) for their work area.

<i>General Campus</i>	<i>Police - Medical - Fire</i>	<i>9-911</i>
<i>UW Medical Center</i>	<i>Police - Medical</i>	<i>9-911</i>

The emergency number should be posted on all telephones.

<i>Your dept., div., unit, worksite, etc. Name</i>		
<i>Location</i>	<i>Emergency Service(s)</i>	<i>Phone #</i>

2. Emergency Evacuation

Walk new employees through the appropriate emergency evacuation route for their work area. Also point out the secondary emergency evacuation route to be used if the primary route is blocked. Show them where to assemble after evacuation. Discuss special evacuation needs and plans with disabled employees. (Campus building evacuation floor plans are available from EH&S, call 3-0465.)

□ **3. Local Fire Alarm Signaling System**

Show new employees where fire alarm pull stations are and instruct them in their use. Let them know that activating the pull station sounds an alarm in the building to alert other occupants to evacuate. Describe what the alarm in your building sounds like (a bell, chimes, a slow whoop).

- Tell your new employees that they must leave the building immediately upon hearing the alarm, closing doors behind them.
- When employees discover a fire they should first, pull the nearest fire alarm pull station and then exit the alarmed area. If possible, employees should follow up with a telephone call from a safe location to provide more details.
- **On Campus:** The activation of a fire alarm pull station also sends a signal to the UW Police and Seattle Fire Department showing the location of the emergency.

□ **4. Portable Fire Extinguishers**

Show the employee(s) where portable fire extinguishers are located. Tell them to use a portable fire extinguisher only if:

- they have been trained to use them,
- the fire alarm has been sounded first,
- the fire is small (waste basket size), and
- they have a clear evacuation route.

□ **5. Department Reporting Procedures**

Tell your new employee(s) to immediately report accidents, incidents, near misses, motor vehicle accidents and any unsafe conditions or acts to:

Name:	Phone:
Location:	Room:

Usually their supervisor

☐ **a. Reporting Accidents and Incidents**

Explain that after they immediately report on-the-job accidents, they have to fill out a University accident incident report form.

<i>Work Location</i>	<i>Form</i>
<i>University</i>	<i>UoW 1428</i>
<i>UW Medical Center</i>	<i>UH0266</i>
<i>Harborview Medical Center</i>	<i>UH0266</i>
<i>Dental School</i>	<i>UoW 1119</i>

<i>Your report form name</i>	
<i>Report form #</i>	
<i>Request form from</i>	

Explain the form and tell them where the forms are located. All accidents or near accidents (incidents) must be reported on this form even if no personal injury was sustained.

Reporting all accidents and incidents helps the University and the employing department initiates effective safety programs and accident prevention measures.

☐ **b. Reporting Motor Vehicle Accidents**

All automobile accidents in University-owned vehicles must also be reported to the University Police Department (9-911) immediately, whether or not there appears to be personal injury or property damage.

☐ **c. Reporting Unsafe Conditions and Acts**

Along with immediately reporting unsafe conditions and acts to their supervisors or the person noted above, employees may report safety problems to Environmental Health and Safety.

Explain that employees should take responsibility for correcting unsafe conditions when feasible, e.g., wiping up small, nontoxic spills and removing tripping hazards.

❑ **6. Workers' Compensation and Industrial Insurance**

Tell employees that work-related injuries or illnesses resulting in medical expenses or time loss are covered by Washington State's Workers' Compensation. To establish a Workers' Compensation claim, employees must fill out a State Department of Labor and Industries (L&I) Report of Industrial Injury or Occupational Disease at their medical provider's office when they receive medical care for a work-related injury or illness. Explain, also, that prompt reporting of accidents to you, the supervisor, will make the claims process easier and may allow you to find them modified work during their recovery.

❑ **7. First Aid**

Tell new employees where first aid kits are located. If your department is required to have first aid certified employees on staff, (UW OPS D 10.5) tell new employees who they are and how to contact them. Explain what actions employees should take if they or others are injured. If safety showers or eye wash stations are located in your department, show new employees where they are and instruct them in their use.

❑ **8. Hazard Communication (Chemical Safety)**

(Worker Right-to-Know, HazCom)

❑ **a. General** (all employees)

- Tell new employees where hazardous materials are used or stored in their work area.
- Explain the labeling system for these materials.
- Show employees where material safety data sheets (MSDSs) are located or explain how they can obtain an MSDS.
- If new employees will be working with hazardous materials, tell them they will receive training in the safe handling of these materials or conduct the training at this time, if appropriate.

Hazard Communication training is conducted by supervisors or a designated departmental trainer.

- Inform new employees that hazardous materials emergencies, such as spills or releases too big for them to clean up, are to be reported to:

	Who	Phone
Small Spills		
Large Spills or releases		

*Report large spills or releases to (General Campus 9-911)
(UW Medical Center 9-911)
(Harborview Medical Center 3000)
(Department protocol for off campus
locations)*

- Explain the hazardous materials waste disposal procedures that apply in your area.

□ **b. Specific Worksites**

Office Staff

For staff whose only chemical exposures are in an office environment.

- Provide a copy of the brochure "Hazard Communication Information and Training for Office Staff."
- Discuss hazard information and protection measures for products they will work with.
- Explain an MSDS and tell employees where they are located or how to obtain them.

Laboratory Staff

Laboratory staff may be sent to the EH&S course "Chemical Safety in the Laboratory" for an introduction to chemical safety regulations and procedures. The laboratory supervisor or principal investigator must provide additional training, specific to the chemicals in the laboratory. See the UW Laboratory Safety Manual (5/00 rev.), Section 7 Safety Training.

Non-Laboratory Hazardous Chemicals

Employees who work with chemicals in non laboratory environments must receive detailed hazard communication training from their supervisor or designated departmental HazCom trainer. (Employees who fall into this category include maintenance, custodial/housekeeping, food service and printing and copy/duplicating employees.)

□ **9. Worksite Warning Signs and Labels**

Explain to all new employees the meaning of warning signs, tags, and labels used in their work area.

□ 10. Personal Protective Equipment (PPE)

Check the personal protective equipment needed for this job.

<input type="checkbox"/>	Gloves	<input type="checkbox"/>	Hard Hats
<input type="checkbox"/>	Safety Glasses, Goggles, Face Shields	<input type="checkbox"/>	Hearing Protectors
<input type="checkbox"/>	Personal Protective Clothing	<input type="checkbox"/>	Fall Protection
<input type="checkbox"/>	Orange Safety Vest	<input type="checkbox"/>	Safety Shoes
<input type="checkbox"/>	Respirator	<input type="checkbox"/>	

Explain precisely the use, care, cleaning, and storage of any personal protective equipment the new employee will be required to use on the job. Stress the need for strict adherence to department, division, unit, and/or lab policy on the use of PPE.

□ 11. Employee Safety and Health Training

Use the following list to indicate the safety and health training classes the new employee will be required to take for their job. Recommended classes could also be marked but priority must be given to arranging the required health and safety training classes.

- ***Please register new employees in EH&S courses as soon as you are aware of their start date since many required courses fill early.***

Environmental Health and Safety courses are general and must often be supplemented with specific training by the department or supervisor.

Employee Safety and Health Training Check List

Mark training/courses the employee needs to take. Retain documents verifying that the training requirements have been met.

Course	Provided by	Course	Provided by
ALL NEW DEPARTMENT EMPLOYEES			
General Orientation	T&D	Departmental/Supervisor New Employee Orientation	Department
Campus New Employee Orientation	T&D	Hazard Communication (Worker Right to Know)	Department
New Employee Benefits Orientation	Benefits Office		
AS REQUIRED BY JOB			
Asbestos Awareness	EH&S	Laboratory Fire Safety	EH&S
Bloodborne Pathogen Exposure Control	EH&S	Laboratory Safety System (LSS)	EH&S
Chemical Safety in the Laboratory	EH&S	Lead Awareness	EH&S
Chemical Spills Clean-up	EH&S	Lifting Training - Back Protection Program	EH&S
Chemical Waste Disposal	EH&S	Lockout Safety - (Energy Control)	EH&S
Confined Space Entry	EH&S	Motorized/Powered Personnel Lifts	Mfg/Supplier
Compressed Gas Safety	EH&S	Office Ergonomics	EH&S
CPR	EH&S	Powder Activated Tools	Mfg/Supplier
Fire Extinguisher Training	EH&S	Radiation Safety Training	EH&S
First Aid / CPR	EH&S	Respiratory Protection and Mask Fitting	EH&S
Forklift Operator Safety Certification	EH&S	Scaffolds	Mfg/Supplier
Hearing (Protection) Conservation	EH&S	Shipping and Transporting Hazardous Materials	EH&S
		Traffic Control and Flagging	Outside agent
OTHER DEPARTMENTAL REQUIRED / RECOMMENDED COURSES			

- **12. Safety and Health Committee(s) and/or Safety Meetings**
 Tell new employees about the Organizational and University-wide Health and Safety Committees and about the departmental health and safety committee and safety meetings, if applicable. Tell them who their safety committee representatives are and how to contact them.
- **13. Safety Bulletin Board**
 Point out the departmental safety bulletin board and tell them what items can be found on the board.
The bulletin board must display the following posters:-

 - *UW HazCom Poster*
 - *State Labor and Industries Posters*
"Job Safety and Health Protection"
"Notice to Employees"
"Your Rights as a Worker"
 - *Other safety notices, newsletters, safety and health committee minutes, etc. should be posted here also.*
- **14. Departmental/Worksite Safety Practices and Rules**
 Conduct an on-the-job review of the practices necessary to perform the initial job assignments in a safe manner. Employees should understand that supervisors will provide job safety instruction and inspection on a continuing basis. Review safety rules for your department (e.g., non-smoking areas, working alone, safe use of chemicals, biohazards, radioactive materials, etc).
- **15. Tour Department/Facility Reviewing Worksite Hazards**
 Encourage your employees to ask questions and to develop a sense of safety consciousness.

2.2 Office Safety

I. Office-Related Illness and Injury

Changes have occurred in the American workplace as a result of the new office technology and automation of office equipment. As with all new technology, these changes bring with it a set of health and safety concerns. In addition to obvious hazards such as slippery floors or an open file drawer, a modern office may also contain hazards such as, poor lighting, noise, poorly designed furniture, and equipment and machines that emit gases and vapors when properly maintained. Even the nature of office work itself has produced a whole host of stress-related symptoms and muscular skeletal strains. For example, long hours at a poorly designed computer workstation can cause pains in the neck and back, shoulders, lower extremities, arms, wrists, hands, eyestrain, and a general feeling of tension and irritability. The leading types of disabling accidents that occur

within the office are the result of falls, strains and overexertion, falling objects, striking against objects, and being caught in or between objects.

A. Falls

Falls are the most common office accident, accounting for the greatest number of disabling injuries. The disabling injury rate of falls among office workers is 2 to 2.5 times higher than the rate for non-office employees. A fall occurs when you lose your balance and footing. One of the most common causes of office falls is tripping over an open desk or file drawer. Bending while seated in an unstable chair and tripping over electrical cords or wires are other common hazards. Office falls are frequently caused by using a chair or stack of boxes in place of a ladder and by slipping on wet floors. Loose carpeting, objects stored in halls or walkways, and inadequate lighting are other hazards that invite accidental falls. Fortunately, all of these fall hazards are preventable. The following checklist can help stop a fall before it happens.

- Be sure the pathway is clear before you walk.
- Close drawers completely after every use.
- Avoid excessive bending, twisting, and leaning backward while seated.
- Secure electrical cords and wires away from walkways.
- Always use a stepladder for overhead reaching. Chairs should never be used as ladders.
- Clean up spills immediately.
- Pick up objects co-workers may have left on the floor.
- Report loose carpeting or damaged flooring.
- Never carry anything that obscures your vision.
- Wear stable shoes with non-slip soles.

If you find yourself heading for a fall, remember - **roll, don't reach**. By letting your body crumple and roll, you are more likely to absorb the impact and momentum of a fall without injury. Reaching an arm or leg out to break your fall may result in a broken limb instead.

B. Strains and Overexertion

Although a typical office job may not involve lifting large or especially heavy objects, it's important to follow the principles of safe lifting. Small, light loads (i.e., stacks of files, boxes of computer paper, books) can wreak havoc on your back, neck, and shoulders if you use your body incorrectly when you lift them. Backs are especially vulnerable; most back injuries result from improper lifting. Before you pick up a carton or load, ask yourself these questions:

- Is this too heavy for me to lift and carry alone?
- How high do I have to lift it?
- How far do I have to carry it?
- Am I trying to impress anyone by lifting this?

If you feel that the lift is beyond your ability, contact your supervisor or ask another employee to assist you.

Safe Lifting Steps

- (a) Take a balanced stance; feet placed shoulder-width apart. When lifting something from the floor, squat close to the load.
- (b) Keep your back in its neutral or straight position. Tuck in your chin so your head and neck continue the straight back line.
- (c) Grip the object with your whole hand, rather than only with your fingers. Draw the object close to you, holding your elbows close to your body to keep the load and your body weight centered.
- (d) Lift by straightening your legs. Let your leg muscles, not your back muscles, do the work. Tighten your stomach muscles to help support your back. Maintain your neutral back position as you lift.

- (e) Never twist when lifting. When you must turn with a load, turn your whole body, feet first.
- (f) Never carry a load that blocks your vision.
- (g) To set something down, use the same body mechanics designed for lifting.

Lifting from A Seated Position

Bending from a seated position and coming back up places tremendous strain on your back. Also, your chair could be unstable and slip out from under you. Instead, stand and move your chair out of the way. Squat and stand whenever you have to retrieve something from the floor.

Ergonomic Solutions to Backbreaking Tasks

If you are doing a lot of twisting while lifting, try to rearrange the space to avoid this. People who have to twist under a load are more likely to suffer back injury.

Rotate through tasks so that periods of standing alternate with moving or sitting. Ask for stools or footrests for stationary jobs.

Store materials at knee level whenever possible instead of on the floor. Make shelves shallower (12-18") so one does not have to reach forward to lift the object. Break up loads so each weighs less.

If you must carry a heavy object some distance, consider storing it closer, request a table to rest it on, or try to use a hand truck or cart to transport it.

Struck By or Striking Objects

Striking against objects is another cause of office injuries. Incidents of this type include:

- Bumping into doors, desks, file cabinets, and open drawers.
- Bumping into other people while walking.
- Striking open file drawers while bending down or straightening up.

- Striking against sharp objects such as office machines, spindle files, staples, and pins.

Pay attention to where you are walking at all times, properly store materials in your work area and never carry objects that prevent you from seeing ahead of you:

- Objects striking employees occur as a result of:
- Office supplies sliding from shelves or cabinet tops.
- Overbalanced file cabinets in which two or more drawers were opened at the same time or in which the file drawer was pulled out too far.
- Machines, such as typewriters that were dropped on feet.
- Doors that were opened suddenly from the other side.
- Proper material storage and use of storage devices can avoid these accidents.

C. Caught In or Between Objects

The last category of leading disabling incidents occurs as a result of office workers who get their fingers or articles of clothing caught in or between objects. Office workers may be injured as a result of:

- Fingers caught in a drawer, door, or window.
- Fingers, hair or articles of clothing and jewelry caught in office machines.
- Fingers caught under the knife-edge of a paper cutter.

While working on office equipment, concentrate on what you are doing.

D. Material Storage

Office materials that are improperly stored can lead to objects falling on workers, poor visibility, and create a fire hazard. A good housekeeping program will reduce or eliminate hazards

associated with improper storage of materials. Examples of improper storage include - disorderly piling, piling materials too high, and obstructing doors, aisles, fire exits and fire-fighting equipment. The following are good storage practices:

- Boxes, papers, and other materials should not be stored on top of lockers or file cabinets because they can cause landslide problems. Boxes and cartons should all be of uniform size in any pile or stack. Always stack material in such a way that it will not fall over.
- Store heavy objects on lower shelves.
- Try to store materials inside cabinets, files, and lockers.
- Office equipment such as typewriters, index files, lights or calculators should not be placed on the edges of a desk, filing cabinet, or table
- Aisles, corners, and passageways must remain unobstructed. There should be no stacking of materials in these areas.
- Storage areas should be designated and used only for that purpose. Store heavy materials so you do not have to reach across something to retrieve them.
- Fire equipment, extinguishers, fire door exits, and sprinkler heads should remain unobstructed. Materials should be at least 18 inches minimum away from sprinkler heads.

II. Workstation Ergonomics

Ergonomics means fitting the workplace to the workers by modifying or redesigning the job, workstation, tool or environment. Workstation design can have a big impact on office workers health and well-being. There are a multitude of discomforts, which can result from ergonomically incorrect computer workstation setups. The most common complaints relate to the neck, shoulders, and back. Others concern the arms and hands and occasionally the eyes. For

example, poor chairs and/or bad postures can cause lower back strain; or a chair that is too high can cause circulation loss in legs and feet.

Certain common characteristics of VDT jobs have been identified and associated with increased risk of musculoskeletal problems. These include:

- Design of the workstation
- Nature of the task
- Repetitiveness of the job
- Degree of postural constraint
- Work pace
- Work/rest schedules
- Personal attributes of individual workers

The key to comfort is in maintaining the body in a relaxed, neutral position. The ideal work position is to have the arms hanging relaxed from the shoulders. If a keyboard is used, arms should be bent at right angles at the elbow, with the hands held in a straight line with forearms and elbows close to the body. The head should be in line with the body and slightly forward.

Arranging Your Workstation to Fit You

- Adjust the height of the chair's seat such that the thighs are horizontal while the feet are flat on the floor.
- Adjust the seat pan depth such that your back is supported by the chair backrest while the back of the knee is comfortable relative to the front of the seat.
- Adjust the backrest vertically so that it supports/fits the curvature of your lower back.
- With the arms at your sides and the elbow joint approximately 90 degrees, adjust the height/position of the chair armrests to support the forearms.
- Adjust the height of the keyboard such that the fingers rest on the keyboard home row

when the arm is to the side, elbow at 90 degrees, and the wrist straight.

- Place the mouse, trackball, or special keypads, next to the keyboard tray. Keep the wrist in a neutral position with the arm and hand close to the body.
- Adjust the height of the monitor such that the top of the screen is at eye level. If bifocals/trifocals are used, place the monitor at a height that allows easy viewing without tipping the head back.
- Place reference documents on a document holder close to the screen and at the same distance from the eye.
- A footrest may be necessary if the operator cannot rest his/her feet comfortably on the floor.

Applying Good Work Practices

The way a task is performed and the workstation environment it is performed in can influence the risk of injury and general work productivity. Good technique can make a job easy and safe to accomplish

- Adjusting the drapes or blinds
- Moving the monitor away from sources of glare or direct light.
- Tipping the monitor slightly downward
- Using diffusers on overhead lighting
- Placing an anti-glare filter on the screen
- Clean the monitor screen on a regular basis
- Avoid cradling the telephone between the head and shoulder. Hold the phone with your hand; use the speakerphone, or a headset.

- Keep frequently used items like the telephone, reference materials, and pens/pencils within easy reach.
- Position the monitor directly in front of the user.
- Move between different postures regularly
- Apply task lighting as to your needs.
- Use the minimum force necessary to strike the keyboard/ten-key keys.
- Use the minimum force necessary to activate the hole punch and stapler.
- Vary your tasks to avoid a long period of one activity.
- Take mini-breaks to rest the eyes and muscles. A break does not have to be a stop of work duties. However, it should be a different style of physical activity such as changing from keyboarding to using the telephone or filing.
- Neutralize distracting noise by using earplugs, playing soft music, or turning on a fan.
- Maintain a comfortable workplace temperature by using layers of clothing or a fan.

III. Indoor Air Quality and Ventilation

Indoor air quality (IAQ) is an increasingly important issue in the work environment. The study of indoor air quality and pollutant levels within office environments is a complex problem. The complexity of studying and measuring the quality of office environments arises from various factors including:

- Office building floor plans are frequently changing to accommodate increasingly more employees and reorganization.

- Office buildings frequently undergo building renovations such as installation of new carpet, modular office partitions and freestanding offices, and painting.
- Many of the health symptoms appearing are vague and common both to the office and home environment.
- Guidelines or standards for permissible personal exposure limits to pollutants within office buildings are very limited.

Many times odors are associated with chemical contaminants from inside or outside the office space, or from the building fabric. This is particularly noticeable following building renovation or installation of new carpeting. Out-gassing from such things as paints, adhesives, sealants, office furniture, carpeting, and vinyl wall coverings is the source of a variety of irritant compounds. In most cases, these chemical contaminants can be measured at levels above ambient (normal background) but far below any existing occupational evaluation criteria.

NIOSH has conducted hundreds of building studies which indicate that the most likely sources of this problem are - poor ventilation, poor thermal conditions, too high or low humidity, emissions from office machines, copiers and other building contaminants and poor ergonomic layout of workstations.

Overview of Ventilation Design

Air enters office buildings or spaces through both mechanical ventilation systems as well as naturally through leaks around windows, doors, etc. Newer, larger buildings, which are highly energy efficient due to sealed windows and heavy insulation primarily, depend on mechanical ventilation. Older, small, and low occupancy office buildings can be adequately ventilated through natural sources which include air leakage through opened windows and doors, as well as through cracks in the windows and walls, and other openings.

In a modern office building, the heating ventilation and air conditioning system (HVAC) is designed to keep occupants comfortable and healthy by controlling the amount of outside air that is added to the building atmosphere, filtering both incoming and recirculated air to remove particulates and controlling the temperature. The HVAC system includes all heating, cooling, and ventilation equipment serving a building: furnaces or boilers, chillers, cooling towers, air handling units,

exhaust fans, ductwork, filters, steam (or heating water) piping. A ventilation system consists of a blower to move the air, ductwork to deliver air to the room, and vents to distribute the air. A good ventilation design will distribute supply air uniformly to each area and especially areas with office machines. An effectively designed area will not have the supply and exhaust vent too close together because fresh air may be removed before it is adequately distributed throughout the area. Exhaust fans are often located a significant distance away from supply vents. A simple way to determine if the ventilation system is running or if a vent is a supply to exhaust is by holding a tissue near the vent. If the tissue moves, the air is being circulated and the direction the tissue is blown will determine the type of vent.

The American Society of Heating, Refrigeration, and Air Conditioning Engineers (ASHRAE) has established a general guideline of 20 cubic feet of outside air per minute/per person for an office environment. This is a sufficient amount of air to dilute building contaminants and maintain a healthy environment. Indoor air quality complaints increase significantly in offices that are not supplied sufficient outside air.

Environmental Parameters

A ventilation system should provide for a comfortable environment with respect to humidity and temperature. The overall goal of climate control is to provide an environment that is not too cold, hot, dry or humid, and that is free from drafts and odors. Humidity refers to the amount of moisture in the air and extremes in humidification levels can influence how comfortable you may be. When the air is too humid, it makes people feel uncomfortable (wet, clammy) and can promote mold growth. On the other hand, low humidity conditions (which typically occur in the winter months) dry out the nasal and respiratory passages. Low humidity may be associated with an increased susceptibility to upper respiratory infections. Static electricity problems (affecting hair and clothes, particularly synthetic fibers) are good indicators of an office with low relative humidity.

Excessively high or low temperatures in an office area can also lead to symptoms in building occupants and reduce productivity. High temperatures have been associated with fatigue, lassitude, irritability, headache and decrease in performance, coordination and alertness. A number of factors interact to determine whether people are comfortable with the

temperature of the indoor air. The activity level, age, and physiology of each person affect the thermal comfort requirements of that individual. Extreme heat, which is unlikely to be found in an office environment, can result in heat rash, exhaustion, and fainting. Workers who may be less alert or fatigued from a high temperature environment may be more prone to accidents. Likewise, if the environment is too cold, flexibility, dexterity, and judgment may be impaired and therefore accidents may increase.

The American Society of Heating, Refrigeration and Air Conditioning Engineers (ASHRAE) has published guidelines for maintaining comfortable and productive work environments. According to ASHRAE, these temperature ranges represent the environmental conditions which 80% of the building occupants consider comfortable. ASHRAE recommends the following temperature and humidity ranges for office work:

Relative Humidity	Winter Temperature Range	Summer Temperature Range
30%	68.5 - 76.0 F	74.0 - 80.0 F
40%	68.5 - 75.5 F	73.5 - 79.5 F
50%	68.5 - 74.5 F	73.0 - 79.0 F
60%	68.0 - 74.0 F	72.5 - 78.0 F

Note: Relative humidity above 50% is not recommended because it can promote mold growth.

Indoor Air Pollution

An inadequately ventilated office environment or a poorly designed ventilation system can lead to the buildup of a variety of indoor air pollutants. Air pollutants can originate within the building or be drawn in from outdoors. Examples of sources that originate outside a building include: (1) pollen, dust and fungal spores; (2) general vehicle exhaust; (3) odors from dumpsters; and (4) re-entrained exhaust from the building itself or from neighboring buildings. Examples of sources that originate from within the building include: (1) building components and furnishings; (2) smoking; (3) maintenance or remodeling activities (painting, etc.); (4) housekeeping

activities; (5) unsanitary conditions (standing water from clogged drains or dry traps) and water damage; and (6) emissions from office equipment or special use areas (print shops, laboratories, or food preparation areas).

Controls to Prevent Indoor Air Pollution

The following recommendations and guidelines are useful in preventing indoor air quality problems:

- HVAC systems should receive periodic cleaning and filters should be changed on a regular basis on all ventilation systems.
- The ventilation system should introduce an adequate supply of fresh outside air into the office and capture and vent point air pollutant sources to the outside.
- Office machinery should be operated in well-ventilated areas. Most office machinery does not require local exhaust ventilation in areas that are already provided with 7-10 air changes per hour. Photocopiers should be placed away from workers' desks. Workers should vary work tasks to avoid using machines excessively.
- Office equipment should be cleaned/maintained according to the manufacturer's recommendations. Properly maintained equipment will not generate unhealthy levels of pollutants.
- Special attention should be given to special operations that may generate air contaminants (such as painting, pesticide spraying, and heavy cleaning). Provisions for adequate ventilation must be made during these operations or other procedures, such as performing work off-hours or removing employees from the immediate area, utilized.

Evaluation

In order to determine if a possible relationship between any adverse health symptoms and indoor air quality exist, the

Industrial Hygiene Section, OHS, will conduct an indoor air quality survey. This survey will consist of an evaluation of potential sources of pollutants, a measurement program that involves selecting appropriate instrumentation and designing the monitoring effort, and, finally, an interpretation of the data gathered. In many situations, the cause of the inadequate indoor air quality can be recognized and certain mitigation measures suggested and/or implemented. To request an indoor air quality investigation, contact the Occupational Health and Safety Office, UW, at 206-543-7388.

Lighting

Lighting is one of the most important factors affecting personal comfort on the job. The best lighting system is one in which the light level is geared to the task, where brightness ratios are controlled (no intensely bright or dark areas in one field of vision) and where ceilings, walls, and floors are carefully chosen to minimize glare. Glare is defined as a harsh, uncomfortable bright light that shines directly in the eyes. Glare may be direct, coming from lights or sunshine, or indirect, coming from a reflected surface.

Different tasks require different levels of lighting. Areas in which intricate work is performed, for example, require greater illumination than warehouses. Lighting needs vary from time to time and person to person as well. One approach is to use adjustable task lighting that can provide needed illumination without increasing general lighting.

Vision problems are one of the leading sources of complaints among office workers. Poor office lighting can cause eyestrain and irritation, fatigue, double vision, watering and reddening of the eyelids, and a decrease in the power of focus and visual acuity. Headaches as well as neck and back pains may occur as a result of workers straining to see small or detailed items. Poor lighting in the workplace is also associated with an increase in accidents. Direct and reflected glare and shadows as well as delayed eye adaptation when moving from bright surroundings into dark ones (or vice versa) may prevent an employee from seeing tripping and other similar hazards.

There are a number of measures that can be used to prevent and control poor lighting conditions in the work environment:

- Regular maintenance of the lighting system should be carried out to clean

or replace old bulbs and faulty lamp circuits.

- The Illuminating Engineering Society recommends a light-colored matte finish on walls, ceilings, and floors to reduce glare.
- Whenever possible, office workers should not face windows, unshielded lamps, or other sources of glare.
- Adjustable shades should be used if workers face a window.
- Diffuse light will help reduce shadows. Indirect lighting and task lighting are recommended, especially when dividers separate workspaces.
- Task lamps are very effective in supplementing general office lighting for those who require or prefer additional lighting. Some task lamps permit several light levels.

IV. Noise

Noise can be defined very simply as unwanted sound. Office workers are subjected to many noise sources including video display terminals, high-speed printers, telephones, fax machines, and human voices. Noise can produce tension and stress as well as damage to hearing at high noise levels. For noise levels in offices, the most common effects are interference with speech communication, annoyance, and distraction from mental activities. The annoying effect of noise can decrease performance or increase errors in some task situations. If the tasks require a great deal of mental concentration, noise can be detrimental to performance.

Government standards have set limits for exposure to noise to prevent hearing loss in employees. The level of noise one can safely be exposed to is dependent on the intensity of the noise as well as the duration of exposure. In an office setting OSHA noise standards are rarely approached or exceeded. However, problems could arise in areas with a high concentration of noisy machines, such as high-speed printers or Xerox machines.

When employees are subjected to sound levels exceeding OSHA standards, feasible administrative or engineering controls must be utilized. If such controls

fail to reduce sound levels, personal protective equipment must be provided and used to reduce sound levels.

For many of the annoying sounds in the office environment, the following measures are useful for reducing the level of noise or its effects:

- Select the quietest equipment if possible. When there is a choice between two or more products, sound levels should be included as a consideration for purchase and use.
- Provide for proper maintenance of equipment, such as lubrication and tightening of loose parts that can cause noise.
- Locate loud equipment in areas where its effects are less detrimental. For example, place impact printers away from areas where people must use the phone.
- Use barrier walls or dividers to isolate noise sources. Use of buffers or acoustically treated materials can absorb noise that might otherwise travel further. Rubber pads to insulate vibrating equipment can also help to reduce noise.
- Enclose equipment, such as printers, with acoustical covers or housings.
- Schedule noisy tasks at times when it will have less of an effect on the other tasks in the office.

V. Office Electrical Safety

Electricity is essential to the operations of a modern automated office as a source of power. Electrical equipment used in an office is potentially hazardous and can cause serious shock and burn injuries if improperly used or maintained.

Electricity travels through electrical conductors, which may be in the form of wires or parts of the human body. Most metals and moist skin offer very little resistance to the flow of electrical

current and can easily conduct electricity. Other substances such as dry wood, porcelain, or pottery offer a high resistance and can be used to prevent the flow of electrical current. If a part of the body comes in contact with the electrical circuit, a shock will occur. The electrical current will enter the body at one point and leave at another. The passage of electricity through the body can cause great pain, burns, destruction of tissue, nerves, and muscles and even death. Factors influencing the effects of electrical shock include the type of current, voltage, resistance, amperage, pathway through body, and the duration of contact. The longer the current flows through the body, the more serious the injury. Injuries are less severe when the current does not pass through or near nerve centers and vital organs. Electrical accidents usually occur as a result of faulty or defective equipment, unsafe installation, or misuse of equipment on the part of office workers.

Types of electrical hazards found in an office environment include the following:

Ungrounded Equipment

Grounding is a method of protecting employees from electric shock. By grounding an electrical system, a low-resistance path to earth through a ground connection is intentionally created. When properly done, this path offers sufficiently low resistance and has sufficient current-carrying capacity to prevent the build-up of hazardous voltages. Most fixed equipment such as large, stationary machines must be grounded. Cord and plug connected equipment must be grounded if it is located in hazardous or wet locations, if operated at more than 150 volts to ground, or if it is of a certain type of equipment (such as refrigerators and air conditioners). Smaller office equipment, such as typewriters and coffee pots, would generally not fall into these categories and therefore would not have to be grounded. However much of the newer office equipment is manufactured with grounded plugs as a precaution (three prong plugs). In such cases, the equipment should be used in accordance with the manufacturer's instructions. In any case, never remove the third (grounding) prong from any three-prong piece of equipment.

Overloaded Outlets

Insufficient or overloading of electrical outlets should be avoided. A sufficient number of outlets will eliminate the need for extension cords. Overloading electrical circuits and extension cords can result in a fire. Floor mounted outlets should be carefully placed to prevent tripping hazards.

Unsafe/Non-Approved Equipment

The use of poorly maintained or unsafe, poor quality, non-approved (by national testing laboratory) coffee makers, radios, lamps, etc. (often provided by or used by employees) should be discarded. Such appliances can develop electrical shorts creating fire and/or shock hazards. Equipment and cords should be inspected regularly, and a qualified individual should make repairs.

Defective, frayed or improperly installed cords for electrically-operated office equipment

When the outer jacket of a cord is damaged, the cord may no longer be water-resistant. The insulation can absorb moisture, which may then result in a short circuit or excessive current leakage to ground. If wires are exposed, they may cause a shock to a worker who contacts them. These cords should be replaced. Electric cords should be examined on a routine basis for fraying and exposed wiring.

Improper Placement of Cords

A cord should not be pulled or dragged over nails, hooks, or other sharp objects that may cause cuts in the insulation. In addition, cords should never be placed on radiators, steam pipes, walls, and windows. Particular attention should be placed on connections behind furniture, since files and bookcases may be pushed tightly against electric outlets, severely bending the cord at the plug.

Electrical Cords across Walkways and Work Areas

An adequate number of outlet sockets should be provided. Extension cords should only be used in situations where fixed wiring is not feasible. However, if it is necessary to use an extension cord, never run it across walkways or aisles due to the potential tripping hazard. If you must run a cord across a walkway, either tape it down or purchase a cord runner.

Live Parts Unguarded

Wall receptacles should be designed and installed so that no current-carrying parts will be exposed, and outlet plates should be kept tight to eliminate the possibility of shock.

Pulling of Plugs to Shut Off Power

Switches to turn on and off equipment should be provided, either in the equipment or in the cords, so that it is not necessary to pull the plugs to shut off the power. To remove a

plug from an outlet, take a firm grip on and pull the plug itself. Never pull a plug out by the cord.

Working on "Live Equipment"

Disconnect electrical machines before cleaning, adjusting, or applying flammable solutions. If a guard is removed to clean or repair parts, replace it before testing the equipment and returning the machine to service.

Blocking Electrical Panel Doors

If an electrical malfunction should occur, the panel door, and anything else in front of the door will become very hot.

Electrical panel doors should always be kept closed, to prevent "electrical flashover" in the event of an electrical malfunction.

VI. Office Fire Prevention Strategies

The best time to think about fire safety is before a fire starts. Learn the location of fire escape routes and how to activate the fire alarm. Participate in practice fire drills on a regular basis. Become familiar with stairway exits - elevators may not function during a fire, or may expose passengers to heat, gas and smoke.

- Heat-producing equipment - copiers, work processors, coffee makers and hot plates - are often overlooked as a potential fire hazard. Keep them away from anything that might burn.
- Electrical appliances can be fire hazards. Be sure to turn off all appliances at the end of the day. Use only grounded appliances plugged into grounded outlets (three prong plug).
- If electrical equipment malfunctions or gives off a strange odor, disconnect it and call the appropriate maintenance personnel. Promptly disconnect and replace cracked, frayed, or broken electrical cords.
- Keep extension cords clear of doorways and other areas where they can be stepped on or chafed and never plug one extension cord into another.
- Do not allow combustible material (boxes, paper, etc.) to build up in inappropriate storage locations (near sources of ignition).

Through a program of scheduled inspections, unsafe conditions can be recognized and corrected before they lead to serious injuries. Take a few moments each day to walk through your work area. Look for items previously pointed out, such as objects protruding into walkways, file cabinets that are weighted toward the top or frayed electrical cords. Advise personnel in the area of the hazards and set about correcting them.

Emergency Preparedness

One result of the recent trend toward open office environments is that smoke from office fires is not contained or isolated as effectively as in less open designs. Open office designs allow smoke to spread quickly and the incorporation of many synthetic and other combustible material in office fixtures (such as furniture, rugs, drapes, plastic wastebaskets, and vinyl covered walls) often makes "smoky" fires. In addition to being smoky, many synthetic materials can emit toxic materials during a fire. For example, cyanide can be emitted from urethane, which is commonly used in upholstery stuffing. Most burning materials can emit carbon monoxide. Inhalation of these toxic materials can severely hamper an office worker's chances of getting out of a fire in time. This makes it imperative for office workers to recognize the signal to evacuate their work area and know how to exit in an expedient manner.

The local emergency action plan will address potential emergencies that can be expected in your work area. For emergency evacuation, the use of floor plans or workplace maps that clearly show the emergency escape routes and safe or refuge areas should be included in the plan. All employees must understand what actions they are to take in the work area and assemble in a safe zone. All new employees should discuss how they should respond to emergencies with their supervisors shortly after starting work and whenever their responsibilities under the plan change. This orientation should include:

- Identifying the individuals responsible for various aspects of the plan (chain of command) so that in an emergency confusion will be minimized and employees will have no doubt about who has authority for making decisions.
- Identifying the method of communication that will be used to alert employees that an evacuation or some other action is required as well as how employees can report

emergencies (such as manual pull stations, public address systems, or telephones).

- Identifying the evacuation routes from the building and locations where employees will gather.

General guidance for fires and related emergencies includes:

If you discover a fire or see/smell smoke, immediately follow these procedures:

- Notify the local Fire Department
- Notify CDC Physical Security or Building Security Force
- Activate the building alarm (fire pull station). If not available or operational, verbally notify people in the building.
- Isolate the area by closing windows and doors and evacuate the building, if you can do so safely.
- Shut down equipment in the immediate area, if possible.
- If possible and if you have received appropriate training, use a portable fire extinguisher to:
 - Assist one to evacuate;
 - Assist another to evacuate; and
 - Control a small fire.
- Do not collect personal or official items; leave the area of the fire immediately and walk, do not run to the exit and designated gathering area.
- You should provide the fire/police teams with the details of the problem upon their arrival. Special hazard information you might know is essential for the safety of the emergency responders. You should not re-

enter the building until directed to do so. Follow any special procedures established for your unit.

- If the fire alarms are ringing in your building, you must evacuate the building and stay out until notified to return. Move to your designated meeting location or upwind from the building staying clear of streets, driveways, sidewalks, and other access ways to the building. If you are a supervisor, try to account for your employees, keep them together and report any missing persons to the emergency personnel at the scene.

If an individual is overexposed to smoke or chemical vapors, remove the person to an uncontaminated area and treat for shock. Do not enter the area if you suspect that a life threatening condition still exists (such as heavy smoke or toxic gases). If CPR certified, follow standard CPR protocols. Get medical attention promptly.

If your or another person's clothing catches fire, extinguish the burning clothing by using the drop-and-roll technique, wrap victim in a fire blanket or douse victim with cold water (use an emergency shower if it is immediately available). Carefully remove contaminated clothing; however, avoid further damage to the burned area. Cover injured person to prevent shock. Get medical attention promptly.

2.3 Lockout and Tagout

Please note that this program has a glossary. The glossary contains the definitions for various terms used in the program. These terms are highlighted in bold print the first time they appear in the body of the program.

Policy

Machines and equipment capable of causing injury due to unexpected energization or start up of the machinery and equipment, or the release of stored energy during servicing and maintenance shall be locked out/tagged out in accordance with this policy and procedure.

Scope

This policy and procedure only applies to the control of energy during **servicing and/or maintenance** of machines and equipment. **Normal production operations** are not covered by this policy and procedure unless an employee is required to remove or bypass a guard or other safety device or is required to place any part of his or her body into a point of operation or where an associated danger zone exists during a machine operating cycle. *Exception:* Minor tool changes and adjustments, and other minor servicing activities, which take place during normal production operations are not covered if they are routine, repetitive, and integral to the use of the equipment for production, provided that the work is performed using alternative measures which provide effective protection.

This policy does **NOT** apply to the following:

1. Work on cord and plug connected electric equipment for which exposure to the hazards of unexpected energization or start up of the equipment is controlled by unplugging the equipment from the **energy source** and the plug remains under the exclusive control of the employee performing the servicing or maintenance; and
2. **Hot tap** operations involving transmission and distribution systems for substances such as gas, steam, water or petroleum products when they are performed on pressurized pipelines that the employer demonstrates that continuity of service is essential; shutdown of the system is impractical; and documented procedures are followed, and special equipment is used which will provide proven effective protection for employees.

Energy Sources

The potential sources of energy from equipment and process include, but are not limited to, the following:

- Electricity;
- Pneumatic and hydraulic lines in the machinery;
- Spring tension or compression;
- Compressed air;
- Steam and condensate lines under pressure;
- Suspended parts;
- Chemical;
- Nuclear;
- Thermal;
- Gas;
- Water; and
- Vacuum.

Authority and Responsibility

Department with employees affected by this program shall be responsible for:

1. Designating a **Departmental Program Coordinator** who will be responsible for all phases of the **lockout/tagout** program at the departmental level;

2. Inspecting all facilities to develop an inventory of equipment and energy sources for which lockout protection is necessary;
3. Developing equipment specific **energy control procedures** as needed;
4. Maintaining, revising, and updating these procedures;
5. Conducting annual lockout/tagout audits;
6. Coordinating lockout/tagout training for employees; and
7. Maintaining any pertinent records (e.g., audits).

Environmental Health and Safety Office shall be responsible for:

1. Reviewing the overall Lockout/Tagout program;
2. Participating in the development of equipment specific procedures at the departmental level;
3. Conducting initial lockout/tagout training and retraining as required; and
4. Maintaining all training records.

Employees are responsible for:

1. Complying with all aspects of this program and any departmental specific energy control procedures developed as a result of program implementation;
2. Applying energy control procedures during equipment/ machinery servicing and maintenance;
3. Reporting any necessary changes to an existing energy control procedure or the need to develop a new procedure; and
4. Reporting any deviations of this program to his/her immediate supervisor.

Protective Materials and Hardware

Locks, tags, chains, wedges, key blocks, adapter pins, self-locking fasteners, devices, or other hardware shall be provided at no cost to each employee from his/her department for the purpose of isolating, securing or blocking of machines or equipment from energy sources.

Lockout/Tagout devices shall be singularly identified; shall be the only devices(s) used for controlling energy; shall NOT be used for other purposes and shall be approved by Environmental Health & Safety to ensure all devices meet the requirements of the standard.

Tags are not required if locks are otherwise indelibly marked so as to identify the person(s) to whom the lock belongs.

Specific Equipment Energy Control Procedures

The Department Program Coordinator shall inspect all facilities and consult with employees and supervisors assigned to service and maintain equipment/machinery in order to generate a list of equipment and energy sources for which lockout protection is necessary in accordance with Appendix C - Machine/Equipment Inventory & Energy Audit Checklist.

Equipment specific energy control procedures shall be developed, documented and utilized for the control of potentially hazardous energy in accordance with Appendix D - Energy Control Procedures.

Exception: A specific equipment procedure for a particular machine or equipment is not necessary when all of the following elements exist:

1. The machine or equipment has no potential for stored or residual energy or reaccumulation of stored energy after shut down which could endanger employees;
2. The machine or equipment has a single energy source which can be readily identified and isolated;
3. The isolation and locking out of that energy source will completely deenergize and deactivate the machine or equipment;
4. The machine or equipment is isolated from that energy source and locked out during servicing or maintenance;
5. A single lockout device will achieve a locked-out condition;
6. The lockout device is under the exclusive control of the **authorized employee** performing the servicing or maintenance;
7. The servicing or maintenance does not create hazards for other employees;
AND
8. The employer, initializing this exception, does not have any accidents involving the unexpected activation or reenergization of the machine or equipment during servicing or maintenance.

One energy control procedure may be used for similar machines and/or equipment if the procedure adequately addresses the unexpected energization hazards related to each machine and/or equipment.

General Lockout Procedures

The following general procedure establishes the minimum requirements for the lockout of **energy isolating devices** whenever maintenance or servicing is done on machines or equipment. It shall be used to ensure that the machine or equipment is stopped, isolated from all potentially hazardous energy sources and locked out before employees perform any servicing or maintenance where the unexpected energization or start up of the machine or equipment or release of stored energy could cause injury.

All employees are required to comply with the restrictions and limitations imposed upon them during the use of lockout. The authorized employee(s) is required to perform the lockout in accordance with this general procedure or departmental equipment specific procedure. All employees, upon observing a machine or piece of equipment, which is locked out to perform servicing, or maintenance shall not attempt to start, energize, or use that machine or equipment. Compliance enforcement for violation of these procedures shall be determined and enforced by the appropriate department.

Sequence of Lockout

1. Notify all **affected employees** that servicing or maintenance is required on a machine or equipment and that the machine or equipment must be shut down and locked out to perform the servicing or maintenance.
2. The authorized employee shall refer to the department procedure to identify the type and magnitude of the energy that the machine or equipment utilizes, shall understand the hazards of the energy, and shall know the methods to control the energy.
3. If the machine or equipment is operating, shut it down by the normal stopping procedure (e.g., depress the stop button, open switch, close valve).
4. De-activate the energy isolating device(s) so that the machine or equipment is isolated from the energy source(s).
5. Lock out the energy isolating device(s) with assigned individual lock(s).
6. Dissipate or restrain stored or residual energy (e.g., capacitors, springs, elevated machine members, rotating flywheels, hydraulic systems, and air, gas, steam, or water pressure) using methods such as grounding, repositioning, blocking or bleeding down.
7. Ensure that the equipment is disconnected from the energy source(s) by first checking that no personnel are exposed, then verify the isolation of the equipment by operating the push button or other normal operating control(s) or by testing to make certain the equipment will not operate. **CAUTION:** Return operating control(s) to neutral or "off" position after verifying the isolation of the equipment.
8. The machine or equipment is now locked out.

Restoring Machines or Equipment to Normal Production Operations

1. Check the machine or equipment and the immediate area around the machine to ensure that nonessential items have been removed and that the machine or equipment components are operationally intact.
2. Check the work area to ensure that all employees have been safely positioned or removed from the area.
3. Verify that the controls are in neutral.
4. Remove the lockout devices and reenergize the machine or equipment. **Note:** The removal of some forms of blocking may require reenergization of the machine before safe removal.
5. Notify affected employees that the servicing or maintenance is completed and the machine or equipment is ready for use.

Testing or Positioning of Machines, Equipment or Components

In situations in which lockout or tagout devices must be temporarily removed from the energy isolating device and the machine or equipment **energized** to test or position the machine, equipment or component thereof, the following sequence of actions shall be followed:

1. Clear the machine or equipment of tools and materials;
2. Remove employees from the machine or equipment area;

3. Remove the lockout or tagout device;
4. Energize and proceed with testing or positioning; and
5. Deenergize all systems and apply energy control measures.

Lockout Log Book

Long-term, after hour or overnight lockouts shall be documented in a logbook utilizing Appendix A - Lockout Log Book. The logbook shall be reviewed during all facility inspections addressing lockout and shall be made available upon request to the Program Coordinator and/or representatives from Environmental Health & Safety.

Tagout Procedures

A tagout system shall ONLY be used under very rare circumstances and its use is dependent upon the approval of Environmental Health & Safety. The only time a tagout system shall be considered for use is when an energy-isolating device is not **capable of being locked out**.

When a tag is used without a lock, it shall be supplemented by at least one additional safety measure that provides a level of safety equivalent to that obtained by using a lock. Additional safety measures include the removal of an isolating circuit element, blocking of a controlling switch, opening of an extra disconnecting device, or the removal of a valve handle to reduce the likelihood of inadvertent energization.

Obsolete/Abandoned Equipment

All obsolete/abandoned equipment that still has the ability to function shall be locked out and tagged with a condemned equipment tag. All power sources for this equipment shall be disconnected and the equipment removed from the facility within a reasonable time frame.

Refitting Equipment

All machinery, equipment and processes must be capable of being locked out. An energy-isolating device is capable of being locked out if it has a hasp or other means of attachment to which, or through which, a lock can be affixed, or it has a locking mechanism built into it. Other energy isolating devices are capable of being locked out, if lockout can be achieved without the need to dismantle, rebuild, or replace the energy-isolating device or permanently alter its energy control capability.

Whenever replacement or major repair, renovation or modification of a machine or equipment is performed, and whenever new machines or equipment are installed, energy isolating devices for such machine or equipment shall be designed to accept a lockout device.

Removing Abandoned Locks/Tags

Each lockout or tagout device shall ONLY be removed from each energy-isolating device by the employee who applied the device.

Exception: When the authorized employee who applied the lockout or tagout device is not available to remove it, that device may be removed by the employee's immediate supervisor under the approval of Environmental Health & Safety. Prior to contacting Environmental Health & Safety for approval, the supervisor shall verify that the employee who applied the device is not at the facility by:

1. Visually inspecting the area, machine, equipment or process to ensure the employee has left the facility;
2. Check the time card or other record to determine if the employee has left the facility;
3. Contact fellow workers (pager, telephone, radio) to determine whether the employee is still in the facility;
4. Physically attempt to locate the employee; and
5. Attempt to make contact with the employee at home.

When the employee still CANNOT be located:

1. Contact Environmental Health & Safety for approval to remove the lockout or tagout device;
2. Continue to make all reasonable efforts to contact the employee to inform him/her that his/her lockout or tagout device has been removed;
3. Ensure the authorized employee has this knowledge before he/she resumes work at the facility prior to his/her next scheduled shift; and
4. The employee shall not be permitted to undertake any future lockout task until permission is granted from his/her immediate supervisor.

Outside Contractors

Whenever outside servicing personnel are to be engaged in activities covered by the scope and application of this policy, departmental supervisors and outside contractors shall inform each other of their respective lockout/tagout procedures.

Departmental supervisors shall ensure that his/her employees understand and comply with the restrictions and prohibitions of the outside employer's energy control program.

Group Lockout

When servicing and/or maintenance is performed by a crew, craft, department or other group, they shall utilize a procedure which affords the employees a level of protection equivalent to that provided by the implementation of a personal lockout or tagout device.

Group lockout devices shall be used in accordance with the general procedures listed in this policy and include the following specific requirements:

1. One authorized employee will be designated as responsible for the group lockout/tagout device;

2. The hazardous energy control procedure will be reviewed with each group member;
3. If more than one crew, craft, or department is involved, one authorized employee will coordinate the lockout/tagout to ensure that all control measures are applied and there is continuity of protection for the group; and
4. Each authorized employee shall affix a personal lockout or tagout device to the group lockout device, group lockbox, or comparable mechanism when he or she begins work, and shall remove those devices when he or she stops working on the machine or equipment being serviced or maintained.

Shift Changes

When lockout intends to run past the end of an assigned work shift, the appropriate supervisor shall be notified as soon as possible. The supervisor will then relay this information to the oncoming supervisor or lead man. If necessary, the previous employee initiating the lockout will remove his/her lock. If the equipment must still be locked out, the individual responsible from the oncoming shift will ensure an employee from the new shift applies his/her lockout device on the unit after the person from the previous shift has removed his/her lock.

Facility Inspections

The Departmental Program Coordinator shall designate an authorized employee (e.g., supervisors) other than the one(s) utilizing the energy control procedure being inspected to conduct periodic inspections of the energy control procedure at least annually to ensure that the procedure and the requirements of this policy and procedure are being followed.

This inspection shall be conducted utilizing Appendix B - Lockout/Tagout Periodic Inspection - Checklist and Certification.

This inspection shall be utilized to correct any deviations or inadequacies identified and shall include a review between the inspector and each authorized and affected employee.

Training

Environmental Health & Safety shall conduct all training to ensure that the purpose and function of the energy control program are understood by employees and that the knowledge and skills required for the safe application, usage, and removal of the energy controls are acquired by employees.

This training shall utilize the "Lockout/Tagout" training booklet generated by Environmental Health & Safety, which shall be updated to ensure consistency with changes in protective equipment and work processes.

Each authorized employee shall receive training in the following:

- Recognition of applicable hazardous energy sources;
- Type and magnitude of the energy available in the workplace;
- Purpose and use of the energy control procedure;

- Methods and means necessary for energy isolation and control; and
- Nature and limitations of tags.

All other employees whose work operations are or may be in an area where energy control procedures may be utilized, shall be instructed about the procedure, and about the prohibition relating to attempts to restart or reenergize machines or equipment which are locked or tagged out.

Each authorized and affected employee will receive initial training prior to his/her first assignment to a job involving exposure. Retraining shall be provided whenever there is a change in an employee's job assignment(s), a change in machines, equipment or processes that present a new hazard, or when there is a change in the energy control procedures.

Additional retraining shall also be conducted whenever a periodic inspection reveals, or whenever Environmental Health & Safety has reason to believe that there are deviations from or inadequacies in the employee's knowledge or use of the energy control procedures.

Environmental Health & Safety shall maintain all training records.

Lockout/Tagout Program Glossary

Affected Employee: An employee who performs the duties of his or her job in an area in which the energy control procedure is implemented and servicing or maintenance operations are performed. An authorized employee and an affected employee may be the same person when the affected employee's duties also involve performing maintenance or service on a machine or equipment that must be locked or a tagout system implemented. An affected employee does NOT perform servicing or maintenance on machines or equipment and, consequently, is not responsible for implementing the energy control procedure. An affected employee becomes an "authorized" employee whenever he or she performs servicing or maintenance functions on machines or equipment that must be locked or tagged.

Authorized Employee: An employee who performs servicing or maintenance on machines and equipment. Lockout or tagout is used by these employees for their self-protection.

Capable of Being Locked Out: An energy-isolating device is considered capable of being locked out if it meets one of the following requirements:

- It is designed with a hasp to which a lock can be attached;
- It is designed with any other integral part through which a lock can be affixed;
- It has a locking mechanism built into it; or

- It can be locked without dismantling, rebuilding, or replacing the energy-isolating device or permanently altering its energy control capability.

Department Program Coordinator: Departmental employee responsible for all aspects of the lockout/tagout program in areas affected by this policy and procedure.

Energized: Machines and equipment are energized when they are connected to an energy source or they contain residual or stored energy.

Energy-Isolating Device: Any mechanical device that physically prevents the transmission or release of energy. These include, but are not limited to, manually operated electrical circuit breakers, disconnect switches, line valves, and blocks.

Energy Source: Any source of electrical, mechanical, hydraulic, pneumatic, chemical, thermal, or other energy.

Energy Control Procedure: A written document that contains those items of information an authorized employee needs to know in order to safely control hazardous energy during servicing or maintenance of machines or equipment.

Energy Control Program: A program intended to prevent the unexpected energizing or the release of stored energy in machines or equipment. The program consists of energy control procedure(s), an employee-training program, and periodic inspections.

Hot Tap: A procedure used in the repair maintenance and service activities, which involves welding on a piece of equipment (pipelines, vessels or tanks) under pressure, in order to install connections or appurtenances. It is commonly used to replace or add sections of pipeline without the interruption of service for air, gas, water, steam, and petrochemical distribution systems.

Lockout: The placement of a lockout device on an energy-isolating device, in accordance with an established procedure, ensuring that the energy-isolating device and the equipment being controlled cannot be operated until the lockout device is removed.

Lockout Device: Any device that uses positive means such as a lock, either key or combination type, to hold an energy-isolating device in a safe position, thereby preventing the energizing of machinery or equipment. When properly installed, a blank flange or bolted slip blind are considered equivalent to lockout devices.

Normal Production Operations: The utilization of a machine or equipment to perform its intended production function.

Servicing and/or Maintenance: Workplace activities such as constructing, installing, setting-up, adjusting, inspecting, modifying, and maintaining and/or servicing machines or equipment. These activities include lubrication, cleaning or

unjamming of machines or equipment and making adjustments or tool changes, where the employee may be exposed to the unexpected energization or start up of the equipment or release of hazardous energy.

Setting-up: Any work performed to prepare a machine or equipment to perform its normal production operation.

Tagout: The placement of a tagout device on an energy-isolating device, in accordance with an established procedure, to indicate that the energy-isolating device and the equipment being controlled may NOT be operated until the tagout device is removed.

Tagout Device: Any prominent warning device, such as a tag and a means of attachment that can be securely fastened to an energy-isolating device in accordance with established procedures. The tag indicates that the machine or equipment to which it is attached is not to be operated until the tagout device is removed in accordance with the energy control procedure.

2.4 Electricity at Work

UNDER NO CIRCUMSTANCES SHOULD A PERSON USE ELECTRICAL APPARATUS ABOUT WHICH THEY HAVE ANY DOUBTS AS TO ITS SAFETY.

Responsibilities - The Physical Plant and Environmental Health & Safety have responsibility for:

The University sub-stations;

Distribution facilities e.g. isolators, circuit breakers, fuse boxes, socket outlets etc up to the service itself;

All permanent and emergency lighting;

Fire alarm systems;

- a. All plant concerned with building services, both that distributed throughout local sites and that concentrated in plant rooms.

Department is itself responsible for the electrical arrangements and equipment fed from the sockets and for departmental equipment fed from fixed outlets.

Electrical Hazards

Injury to persons - there are several ways in which personal injury may be caused:

1. **Shock** Electric shock is the effect produced on the body, particularly its nervous system, by an electrical current passing through it, and its effect depends on the current strength which in turn depends on the voltage, the path the current takes through the body, the surface resistance of the skin (much reduced when wet) and several other factors. A voltage as low as 15 V can produce discernible shock effects and 70 V has been known to cause death. Generally speaking, however, those fatalities that occur from this cause involve normal domestic and industrial voltages of 240 V ac and above, causing currents of greater than 30 milliamps to flow through the body for longer than 40 milliseconds. The most common cause of death from shock is suffocation and accordingly it is highly desirable that those dealing with electricity should be trained in resuscitation. Minor shocks in themselves may not be serious but they can lead to serious consequences; for example, the associated muscle contraction may lead to falls from working platform or ladders.
2. **Burns** These are caused by the passage of heavy current through the body or by direct contact with an electrically heated surface. They may also be caused by the intense heat generated by arcing from a short circuit. Electrical burns are a very unpleasant form of burn and require immediate attention.
3. **Explosion** The main causes of electrically-induced explosions are listed below:
 - a) In situations where flammable gases or vapors are present so that a spark could ignite an event. In such environments all electrical equipment should be flame proof.
 - b) Where electric arcing takes place in a confined space causing intense local heating with a consequent bursting of the enclosure by the expansion of trapped air.
 - c) Rechargeable batteries emitting hydrogen when being charged, giving rise to an explosive atmosphere. Such operations should therefore be carried out in a well-ventilated area, the temperature of which should not exceed 18 degrees C.
4. **Eye injuries** These can be caused by exposure to the strong ultraviolet rays of an electric arc, where the eyes become inflamed and painful after a lapse of several hours, and there may indeed be a temporary loss of sight. Although very painful, the condition usually passes off within 24 hours. Precautions to protect the eyes must always be taken by persons working with or near electric arc welding. Also permanent injury to the eyes can arise from the energy propagated in microwave apparatus: no one should look along the wave-guide when it is in use or examine a highly directional radiator at close quarters.

Precautions also need to be taken with lasers to prevent eye injury (*see separate section*).

5. **Body injuries from radio-frequency (rf) energy and induction heaters** The energy in microwave and rf apparatus can damage the body, especially those parts with a low blood supply. Operators should never be exposed to an energy level exceeding 10 mill watts per sq cm. If personnel have had bones pinned with metal at any time, they must be careful not to expose themselves to these sorts of energy propagation as they may cause substantial internal damage before the operator is aware he is in danger. Similarly, induction heaters can cause rapid heating in any circuit brought within say 1m and consequently personnel using such equipment should remove any metallic objects from their person and those with pinned bones etc should avoid them altogether.
6. **Fires** A large percentage of fires are of an electrical origin, caused by one or more of the following:

Sparks A spark arises from a sudden discharge through the air between two conductors, or from one conductor to earth. The current produced is usually small so that serious fires are unlikely unless explosive gases or vapors are present, or highly flammable material is in contact with the conductor.

(ii) **Arcs** An arc is a much larger and brighter discharge where the current flow may be hundreds of amps. It usually arises when a circuit is broken or when a conductor melts or fractures leaving a gap across which current continues to flow. When an arc is established, the air in the vicinity becomes ionized and forms a conductor, which may allow current to flow to a nearby metal framework. Any combustible material in the vicinity could therefore lead to a fire.

(iii) **Short circuits** A short circuit is formed when the current finds a path from the outward conductor wire to the return wire other than through the equipment to which it is connected. The current flow may be large because of the low resistance of the leads, and arcing often occurs at the contact between the conductors. Insulation may therefore be burned and set fire to adjacent flammable material. Batteries have a low internal resistance and can give rise to very large currents under short circuit conditions, causing a large arc from which molten metal may be splashed.

(iv) **Overloading and old wiring** Wiring must not be overloaded, otherwise it will overheat and the insulation will be damaged. This can lead to a short circuit at some point in the length of the conductor, or more likely at connection points. The insulation of

wiring, which has been in use for a number of years, tends to become brittle and, where alterations and additions are required, the cable must always be checked by a competent electrician and replaced completely if there are indications of failure of the insulation. Installations should be protected against overloading and short circuits by fuses or circuit breakers.

Safety Measures

Cables Cables must be of sufficient size to carry the current, which flows through them under normal conditions and must be adequately insulated to allow handling with safety. Under fault conditions, they must be able to withstand excessive currents for the time taken for the supply to be disconnected by a fuse or circuit breaker. Those cables, which provide the basic services within a building, are normally housed in conduits or troughs but where apparatus is wired up from socket outlets, no such permanent protection is available and hence particular care is required. Such cable must be sufficiently robust to withstand the wear and tear of laboratory use and fully waterproof where water may come within the vicinity of the apparatus.

Fuses These devices will open a circuit when an excessive current flows.

Circuit breakers These are a form of switch which open automatically if the current in the controlled circuit becomes excessive. It may operate on either thermal or magnetic principle. It is essential to select the correct size of the fuse or circuit breaker for any particular circuit, especially those in series, so that the correct disconnection is made i.e. the faulty circuit and only the faulty circuit is isolated and not a whole subgroup of services, whilst they must allow normal operation of the equipment without random tripping.

Residual current device (RCD) These devices should be used in areas of hazard, eg where water is being used near electrical equipment as a back-up protective device. They are sensitive to earth currents and are designed to isolate the supply before the user of equipment is subject to serious harm. (Plug-in RCD's must be manufactured to BS7071.)

Isolation Means must be provided of disconnecting cables or apparatus from the source of supply in an emergency or when maintenance is to be carried out and safeguards instituted to prevent the supply being remade whilst the apparatus is being worked on.

Should it be necessary for an isolating switch to be remote from the apparatus, fuses should be drawn when the switch is in the 'off' position or if the switch is lockable, it should be locked off. The operator directly concerned should then retain the key or fuses. Appropriate notices should be displayed so that all persons may be aware of the situation.

Earthing Any conducting part of a system, which could conceivably become live, say under fault conditions, and yet to be handled, e.g. the external metal casing of electrical apparatus, must be earthed as a legal requirement. The reasons for this are:

- a) To prevent the accessible metal parts rising to a dangerous voltage under fault conditions such as a short circuit between the live conductors and casing;
- b) To ensure that a faulty circuit is automatically disconnected from the supply by drawing sufficient current to blow the fuse or operate the circuit breaker or residual current device.

All new Class 1 equipment (ie all equipment designed with an earth) must be tested to ensure that it is in fact properly earthed before putting it into use. Bad joints, rust or paint can cause the resistance to increase to a dangerous level. Where the earth connection of a chassis is made with a nut and bolt, a shakeproof washer should be used adjacent to the chassis to ensure good contact is maintained in use.

Low voltage supplies (<1000V) Portable tools and hand inspection lamps can be a source of danger because:

- a) they are subjected to abnormal wear and tear.
- b) they are liable to be used in conditions where dampness has reduced the body's resistance.

Where conditions are particularly dangerous, eg when working in interiors of metal enclosures or where water is continuously present, mains voltage equipment should not be used. A double-wound transformer with the secondary centre tapped to earth to give 110 V should be used, thereby ensuring that no part of the equipment will be at a voltage greater than 55 V relative to earth.

The availability of cordless power tools has had a great impact on increasing convenience and reducing the risk of injury. Operating at extra-low voltage the potential for electric shock has been dramatically reduced, although care must be taken with the charging unit. There are no power cords to tangle with, trip over or cut through, and temporary supplies are not required for electrical work. These tools are a highly recommended way of reducing the risk of injury, and consideration should be given to their purchase in place of standard 240 V tools.

Insulation Double insulation apparatus and tools are now made which require no earthing - such equipment has the 'double square' logo and is categorised as Class 2 equipment.

'Double Insulated' implies the use of two layers of insulation on all live parts, each layer of insulation being adequate to insulate the conductor but together

ensure an improbability of danger arising from insulation failure. This arrangement avoids the need for any external metal work to be connected to earth. Such apparatus and tools, which are not earthed, should be stored in a dry environment and tested to ensure that the insulation is effective.

Space The circulation space in laboratories and workshops must be kept clear to prevent the risk of tripping and hence accidental contact with live electrical conductors.

Plug connections In all instances the connection of equipment to the mains must be correctly made by a competent person.

Extension arrangements

If there is a shortage of sockets to supply the increasing number of portable electrical appliances being used, it is permissible to feed **one** four-way extension block from one power point provided the block feeds only low power equipment (ie less than 500 W or 2 amps current rating). Kettles, microwaves, and heaters etc, which consume much greater power, must be fed from an installed socket point. Flexible cables should be run in such a way as not to present a tripping hazard. In some instances four-way extensions have overheated and caused fires due to poor connections by the fuse link. Four-way extensions are thus preferred unswitched and unfused, saved for the 13-amp fuse in its plug, which provides adequate electrical protection. If a fused four-way extension becomes warm around the fuse link, immediately take out of service and replace.

Electrical Testing

The law requires that all electrical equipment and systems are not only designed to be safe to operate but should be maintained in as safe conditions as is reasonably practicable. To ensure the latter a testing is required at regular intervals and records kept of results.

Equipment fitted with 13 A plugs There are four basic safety tests in addition to regular visual tests by the user:

1. Visual inspection of mains plugs, cables and earthing arrangements. Fuses in plugs and equipment should be checked to establish that they are correctly rated. If a plug incorporates an RCD, the latter should be functionally tested.
2. Measurement of insulation resistance between the live parts and earth, using 500 V dc.
3. Measurement of the earth loop resistance (not applicable for double insulated equipment), using a high current, usually 25 amperes
4. Flash test (a higher voltage insulation test) for double insulated equipment, using 3kV ac. ***NB: Do not subject electronic equipment (eg computers) to the flash test.***

Portable Appliance Testers (PATs) are available to carry out the checks at 2, 3 and 4 quickly and reliably, and the Safety Section holds instruments, which can be borrowed for the purpose should Departments, have insufficient equipment to justify the purchase of their own. The testing may be carried out in-house if a member of staff is competent to do so, or Estates or external contractors may undertake the testing.

Equipment permanently wired into the supply The tests and standards are in general the same as above (except no plug is involved) but the use of PATs is not possible and Meggers and earth loop testers will be required instead. As it will be necessary to isolate supplies while the test is being carried out, the involvement or co-operation of the Estates Department will be necessary. Similarly, 415 V equipment, even if fitted with plugs, may require Estates Department involvement, as again PATs cannot be used.

Fixed Installations There are three classes of safety tests, namely:

1. Earth loop measurements;
2. Insulation checks;
3. Operation times of circuit breakers, residual current devices etc.

The procedures for testing and the acceptable tolerances for fixed installations are contained in the IEE Wiring Regulations for Electrical Installations, Sixteenth Edition, copies of which can be obtained from the Safety Office.

The periodicity of the tests is not definitively laid down by regulation and should be determined according to circumstances. (Refer to the HSE pamphlet *'Maintaining Portable Electrical Equipment in Offices and other Low Risk Environments'*.) The period between tests will vary depending on the use and the risks posed by the equipment. A formal visual inspection every 2 years with a full electrical test every 5 years will suffice for low-risk office equipment such as computers. However, equipment such as kettles used daily and posing a much higher risk, would be visually inspected every 6 months and fully tested annually. Appliances such as hand tools used outside in all weathers (eg on a construction site) would be tested as often perhaps as fortnightly. The best way to judge the frequency of testing would be to check the failure rate of appliances to see if many were damaged in the interval between testing and adjust the interval accordingly.

For fixed installations, a periodicity of 5 years is recommended with earth loops and residual current devices being checked annually. Records of results should be retained for a period covering at least three consecutive inspections to enable signs of progressive deterioration to be detected. For portable equipment, the use of stickers to indicate whether equipment is 'in date' can be used for record purposes, provided departments have instructed their staff not to use equipment that has lapsed. If practical, a central record should be kept as well.

Statutory Testing In addition, there are a number of installations which have special statutory testing requirements, e.g. fire alarm systems and electrical installations in flammable stores, lifts etc. These are the responsibility of the Estates and the requirements are not detailed here.

Experimental Work in Laboratories requiring Special Precautions

Live Working Experiments may call for the use of electrical equipment, which has to be altered or improved whilst power is 'on'. Such situations need to be justified and authorized by the Safety Liaison Officer or supervisor as appropriate and in any event the following precautions would need to be taken:

- a) Only insulated test prods and tools are to be used.
- b) Where live working is likely to be a continuous requirement consideration should be given to making the appropriate work bench and surrounding area as 'earth free' as far as is reasonably practicable with the main supply being fed through a 1:1 isolating transformer.
- c) The power switch (i.e. on/off) must be within easy reach of the operator.
- d) Another person must be within earshot who is cognizant of the potential hazards and who is trained in artificial respiration.
- e) Workspaces should be tidy and floors clear of debris to remove the hazard of tripping.
- f) Consideration should be given to the fitting of a residual current device (RCD) in the supply circuit to the equipment.

High voltage (*ie greater than 1kV*)

Normal electrical safety precautions of earthing and isolation are inadequate to prevent injury to persons operating equipment in the vicinity of high voltages and consequently experiments using such voltages need additional specific safety measures to be adopted.

Precautions to be taken when undertaking experiments involving high voltage are as follows:

- a) No internal adjustments or modifications are to be made whilst the equipment is live, ie no live working.
- b) Measurements must be taken with permanently connected instruments.
- c) Any part of the equipment which is at a voltage of or greater than 240 V is to be made inaccessible to human contact when the equipment is live by the provision of appropriate insulation, protective barriers or other means.
- d) Sufficient electrode spacing must be provided to prevent flashovers.
- e) The voltage source must be capable of rapid isolation by the person in charge of the experiment in case of an emergency.
- f) Equipment is only to be operated when there is at least one other person within earshot, in order that assistance can be given should the operator receive an injury from the equipment.

- g) Capacitor banks should be discharged after the equipment has been switched off and bleed resistors incorporated into the design so that any remaining capacitor energy is dissipated.
- h) Before making adjustments to the de-energized equipment, measurements must be taken to ensure that there are no dangerous voltages present, having first carried out the capacitor discharge routine, as appropriate.
- i) To prevent inadvertent contact by casual visitors, the apparatus must be guarded by insulating screens or barriers placed at an adequate distance from any exposed live part and warning notices must be displayed. Adequate distances are considered to be:

Up to 50 kV	3 meters
50 kV - 100 kV	4 meters
150 kV - 250 kV	5 meters

Unattended Operation of Electrical Equipment

Because of the danger of fire, electrical equipment should be switched off when unattended, wherever possible. In cases where switching off is impractical, precautions should be taken to reduce the possibility of a fire occurring in the first place and should one start, to contain its subsequent spread, namely:

- a) Fuses, circuit breakers, residual current devices etc (ie devices which will automatically disconnect the supply under fault conditions) are correctly rated and in good order.
- b) Flammable material in the neighborhood of the equipment is removed.
- c) Fire detection and fire extinguishing equipment is working satisfactorily. In some cases, the fitting of additional detection devices (either heat or smoke) may be justifiable where high value equipment or buildings are at risk.
- d) For experimental equipment, authorization should be obtained from a supervisor or other suitable responsible person and the Security Office informed.
- e) A warning notice should be displayed near the equipment being run giving salient details to enable safe action to be taken by a member of the emergency services should a hazardous situation arise.

The above particularly applies to experimental equipment being run out of normal working hours as opposed to proprietary equipment such as refrigerators, drying ovens etc. Nevertheless, the Safety Office should be contacted for advice where doubtful or especially difficult cases arise.

REFERENCES

1. Electricity at Work Regulations, 1989 (HMSO)
2. Electrical Safety in High Voltage and Pulsed Power Laboratories, 1986 (Sowerby Research Center)

3. BS EN60825: 1992 Radiation Safety of Laser Products, Equipment Classification, Requirements and User's Guide (BSI)
4. Safety in Universities, Notes of Guidance Part 2.1 Lasers, Revised 1992 (CVCP)

2.5 Storing Materials

Material Storage

All unnecessary accumulation of materials and supplies in the shop area shall be avoided. The presence of unnecessary material in the shop could cause such incidents as tripping, falling, or slipping. This could be especially hazardous around equipment that is in operation. The only material in the shop area shall be that actually in work. The only places that materials should accumulate in quantity are in storerooms and material holding areas.

1. The storage of materials shall not, of itself, create a hazard. Materials stored in tiers shall be stacked, strapped, blocked or interlocked, and limited in height so they are stable and secure against sliding or collapse. Storage racks shall have sufficient capacity to bear the loads imposed on them.
2. Stored materials shall not obstruct fire extinguishers, alarm boxes, sprinkler system controls, electrical switch boxes, machine operations, emergency lighting, first aid or emergency equipment, or exits.
3. Heavy materials and equipment should be stored low and close to the ground or floor to reduce the possibility of injury during handling.
4. All passageways and storerooms shall be maintained clean, unobstructed, dry, and in sanitary condition. Spills will be promptly removed.
5. Where mechanical handling equipment, such as lift trucks are used, safety clearance shall be provided for aisles at loading docks, through doorways, and wherever turns or passages must be made. No obstructions that could create a hazard are permitted in aisles.

Laboratory Chemical Storage

Store all chemicals by their hazard class and not in alphabetical order. Storing chemicals by alphabetical order will often result in the placement of incompatible chemicals being next to one another. Only within the segregation groups can chemicals be stored in alphabetical order. If a chemical exhibits more than one hazard, segregate by using the characteristic that exhibits the primary hazard.

1. Do not store chemicals near heat sources such as ovens or steam pipes. Also, do not store chemicals in direct sunlight.
2. Date chemicals when received and first opened. This will assist you in using the oldest chemicals first, which will also decrease the amount of chemicals for disposal. If a particular chemical can become unsafe while in storage, e.g., diethyl ether, then an expiration date should also be included. Keep in mind that expiration dates set by the manufacturer do not necessarily imply that the chemical is *safe* to use up to that date.
3. Do not use lab benches as permanent storage for chemicals. In these locations, the chemicals can easily be knocked over, incompatible chemicals can be stored alongside one another, and the chemicals are unprotected in the event of a fire. Each chemical must have a proper designated storage location and be returned there after use.
4. Inspect your chemicals routinely for any signs of deterioration and for the integrity of the label. State law requires that ***all*** chemicals must be clearly labeled. Another benefit of labeling is to prevent chemicals from becoming "unknowns."
5. Do not store any chemicals in glass containers on the floor.
6. Do not use fume hoods as a permanent storage location for chemicals, with the exception of particularly odorous chemicals that may require ventilation. The more containers, boxes, equipment, and other items that are stored in a fume hood, the greater the likelihood of having chemical vapors being drawn back into the room. Some chemical fume hoods have ventilated storage cabinets underneath for storage of frequently used chemicals that require ventilation.
7. Promptly contact the EH&S for the disposal of any old, outdated, or unused chemicals.
8. Chemicals that require refrigeration must be sealed with tight-fitting caps and kept in lab safe refrigerators. Lab safe refrigerators/freezers must be used for cold storage of flammables.
9. Do not store chemicals above eye level. If the container breaks, the contents can fall onto your face and upper body.
10. Do not store excessive amounts of chemicals in the lab. Buying chemicals in large quantities creates a serious fire hazard and limits work space. The disposal costs far exceed any cost savings from large quantity purchasing.

Storage Cabinets

Specific types of storage cabinets must be specified in laboratories in order to separate incompatible chemicals from one another and to safely store all chemicals. All chemicals must be stored in a secure container, preferably within enclosed cabinets.

Flammable Storage Cabinets

Flammables not in active use must be stored in safe containers inside fire resistant storage cabinets specially designed to hold them. Flammable storage cabinets must be specified for all labs that use flammable chemicals. The cabinet must meet NFPA 30 & OSHA 1910.106 standards. Flammable storage cabinets are designed to protect the contents from the heat and flames of external fire rather than to confine burning liquids within. They can perform their protective function only if used and maintained properly. Cabinets are generally designed with double-walled construction and doors, which are two inches above the base (the cabinet is liquid-proof up to that point).

Acid Storage Cabinets

Acids should be kept in acid storage cabinets specially designed to hold them. Such cabinets have the same construction features of a flammable storage cabinet, but are coated with an epoxy enamel to guard against chemical attack, and use polyethylene trays to collect small spills and provide additional protection from corrosion for the shelves. Periodically check shelves and supports for corrosion. Nitric acid should always be stored by itself or in a separate acid cabinet compartment.

Compressed Gas Cylinder Cabinets

Cylinders containing the compressed gases listed below must be kept in a continuously, mechanically ventilated enclosure. Full size cylinders must be stored in a gas cylinder cabinet. No more than two small cylinders can be stored in a chemical fume hood, a storage cabinet under the fume hood (if properly ventilated into fume hood exhaust), or some other ventilated enclosure. Cylinders stored in compressed gas cylinder cabinets or other ventilated enclosures must be secured at all times. When stored in a cabinet or hood, small cylinders must be positioned and secured so that they will not fall out.

Acetylene	Fluorine
Ammonia	Formaldehyde
Arsenic Pentafluoride	Germane
Arsine	Hydrogen Chloride, anhydrous
Boron Trifluoride	Hydrogen Cyanide
1,3 - Butadiene	Hydrogen Fluoride
Carbon Monoxide	Hydrogen Selenide
Carbon Oxysulfide	Hydrogen Sulfide
Chlorine	Methylamine
Chlorine Monoxide	Methyl Bromide
Chlorine Trifluoride	Methyl Chloride
Chloroethane	Methyl Mercaptan
Cyanogen	Nitrogen Oxides
Diborane	Phosgene

Dichloroborane
Dichlorosilane
Dimethylamine
Ethane
Ethylamine
Ethylene
Ethylene Oxide

Phosphine
Silane
Silicon Tetrafluoride
Stibine
Trimethylamine
Vinyl Chloride

Recognizing that because of age or physical constraints, as determined by The University's Physical Plant, a facility may not be able to comply with these requirements, notification of non-compliance, the associated explanation, and a copy of the Physical Plant determination must be sent to Environmental Health & Safety as well as to the Department Chair and College Dean. As modifications can be made to the building, labs will be brought into compliance. In the interim, compressed gases listed above must be used in quantities, which will fit into existing ventilated enclosures, or justification must be provided explaining why this is not possible. These justifications must also be submitted to the office listed above.

Section 3: Injury Prevention

3.1 Fall Protection

Please note that this program has a glossary. The glossary contains the definitions for various terms used in the program. These terms are highlighted in bold print the first time they appear in the body of the program.

Policy

All University employees working six feet or more above a lower level shall be protected from fall hazards and falling objects in accordance with this policy.

Scope

The following systems and procedures have been designed to prevent employees from falling off, onto or through working levels. Areas covered by this policy include, but are not limited to:

- **Controlled access zones;**
- Ramps, runways and other walkways;
- **Holes;**
- **Leading edge** work;
- **Unprotected sides and edges;**
- Roofing work;
- Wall **openings;** and
- Other **walking/working surfaces.**

Authority and Responsibility

Environmental Health and Safety Department is responsible for:

1. Developing, implementing and updating the University's fall protection program;
2. Reporting all questionable conditions discovered to the responsible departments;
and
3. Ensuring all affected employees are trained in accordance with this policy.

CEE Department is responsible for:

1. Ensuring all affected employees follow the described practices within this policy;
2. Purchasing all appropriate fall protection equipment and related safety devices;
and
3. Ensuring all inspection and maintenance practices for fall protection equipment are followed in accordance with this policy.

Employees are responsible for complying with the practices within the Fall Protection Policy.

General Requirements

This standard, 29 CFR 1926.500-503, describes the duty to provide fall protection, sets the criteria and practices for all fall protection systems and the required training. It covers hazard assessment, fall protection and safety monitoring systems. Also addressed are controlled access zones and **guardrails**, personal fall arrest, **warning line system** and **positioning device systems**.

Controlled Access Zones

Controlled access zones, when created to limit entrance to areas where leading edge work and other operations are taking place, shall be defined by a controlling line or other means that restricts access. Control lines shall consist of ropes, wires, tapes or equivalent material, supporting stanchions and each shall:

- Be flagged or otherwise clearly marked at not more than six foot intervals with high visibility material;
- Be rigged and supported in such a way that the lowest point (including sag) is not less than 39 inches from the walking/working surface and the highest point is not more than 50 inches;
- Be strong enough to sustain stress of not less than 200 pounds;
- Extend along the entire length of the unprotected leading edge and shall be parallel to the unprotected or leading edge; and
- Be connected on each side to a guardrail system or wall.

When control lines are used they shall be erected not less than six feet and no more than 25 feet from the unprotected or leading edge, except when precast concrete members are being erected. In the latter case, the control line shall be erected not less than six feet and no more than 60 feet or half the length of the member being erected, whichever is less, from the leading edge.

Controlled access zones when used to determine access to areas where overhand plastering and related work are taking place shall be defined by a control line erected not less than 10 feet and no more than 15 feet from the working edge. Additional control lines shall be erected at each end to enclose the controlled access zone. Only employees engaged in overhand bricklaying or related work are permitted in these zones.

On floors and roofs where guardrail systems are not in place prior to the start of overhand bricklaying operations, controlled access zones shall be enlarged as necessary to enclose all points of access, material handling areas and storage areas.

On floors and roofs where guardrail systems are in place, but need to be removed to allow leading edge work to take place, only the portion of the guardrail necessary to accomplish that day's work shall be removed.

Excavations

Each employee at the edge of an excavation six feet deep or more shall be protected from falling by a guardrail system, fence barricade or cover. Where walkways are provided to permit employees to cross over excavations, guardrails are required on the walkway.

Guardrail Systems

If a guardrail system is used to protect employees from falls, the system shall meet the following criteria:

- Top rails and midrails of guardrail systems shall be at least one quarter inch in diameter;
- If wire rope is used for top rails, it shall be marked every six feet with highly visible material;
- Steel or plastic banding material shall not be used as top rails or midrails;
- Manila, plastic or synthetic rope used for top rails or midrails shall be inspected frequently to ensure strength and stability;
- The top edge height of top rails or guardrails shall be 42 inches plus or minus three inches above the walking level;
- When workers are using stilts, the top edge height of the top rail or equivalent shall be increased equal to the height of the stilts;
- Screens, midrails, mesh, intermediate vertical members or equivalent intermediate structural members shall be installed between the top edge of the guardrail system and the walking/working surface when there are no walls or parapet walls at least 21 inches high;
- When midrails are used, they shall be installed at a height midway between the top edge of the guardrail system and the walking/working level;
- When screens and mesh are used they shall extend from the top rail to the walking/working level and along the entire opening between top rail supports;
- Intermediate members, such as balusters, when used between posts, shall not be more than 19 inches apart;
- Other structural members, such as additional midrails and panels, shall be installed so that there are no openings larger than 19 inches;
- The guardrail system shall be capable of withstanding a force of at least 200 pounds;
- Midrails, screens, mesh, intermediate vertical members, solid panels and equivalent structural members shall be capable of withstanding a force of at least 150 pounds;
- Guardrail systems shall have smooth surfaces to protect employees from punctures or lacerations and prevent clothing from snagging;
- The ends of top rails and midrails shall not overhang terminal posts, except where such overhang does not constitute a projection hazard;
- A chain gate or removable guardrail section shall be placed across the access opening between guardrail sections when hoisting operations are not taking place;
- At holes, six feet or more in depth, guardrail systems shall be set up on all unprotected sides or edges and all holes shall be covered when not in use;

- Guardrail systems with a gate shall be used around holes that are access points to prevent employees from falling into these holes; and
- If guardrail systems are used at the sides or edges of ramps and runways, they shall be erected on each side or edge.

Personal Fall Arrest Systems

The use of a **body belt** for fall protection is prohibited.

All personal fall arrest systems shall be inspected by the user prior to each use. The inspection shall include examination for wear, damage and other deterioration. If during the inspection the user discovers defects or damage, the user shall immediately remove the component from service.

Dee-rings and **snap-hooks** shall have a minimum tensile strength of 5,000 pounds without cracking, breaking or suffering permanent deformation. Snap hooks shall be sized to be compatible with the member to whom they will be connected, or shall be of a locking configuration.

Snap hooks that are not of the locking type and designed for the following connections shall not be engaged directly to:

1. Webbing, rope or wire rope;
2. To each other;
3. To a dee-ring to which another snap hook or other connector is attached;
4. To a horizontal **lifeline**; or
5. To any object incompatible in shape or dimension relative to the snap hook, thereby causing the connected object to depress the snap hook keeper and release unintentionally.

A hook is considered to be compatible when the diameter of the dee-ring to which the snap hook is greater than the inside length of the snap hook when measured from the bottom (hinged-end) of the snap hook keeper to the inside curve of the top of the snap hook. Thus, no matter how the dee-ring is positioned or moved with the snap hook attached, the dee-ring cannot touch the outside of the keeper, thus depressing it open. The use of non-locking dee-rings is prohibited.

On suspended scaffolds or similar work platforms with horizontal lifelines that may become vertical lifelines, the devices used to connect to a horizontal lifeline shall be capable of locking in both directions on the lifeline.

Horizontal lifelines shall be designed, installed and used under the supervision of a **qualified person**, as part of a complete fall arrest system that maintains a safety factor of at least two. Lifelines shall be protected against being cut or abraded.

Self-retracting lifelines and lanyards that automatically limit free fall distance to two feet or less shall be capable of sustaining a minimum tensile load of 3,000 pounds applied to the device with the lifeline or lanyard in the fully extended position.

Self-retracting lifelines and lanyards that do not limit free fall distance to two feet or less, rip stitch lanyards, and tearing and deforming lanyards shall be capable of sustaining a minimum tensile load of 5,000 pounds applied to the device with the lifeline or lanyard in the fully extended position.

Ropes and straps used in lanyards, lifelines and strength components of body belts and body harnesses shall be made of synthetic fibers.

Anchorage shall be designed, installed and used under the supervision of a qualified person. Anchorage used to attach personal fall arrest systems shall be independent of any anchorage being used to support or suspend platforms and shall be capable of supporting at least 5,000 pounds per person attached.

Lanyard and vertical lifelines shall have a minimum breaking strength of 5,000 pounds.

Personal Positioning Device

Body harness systems shall be set up so that a worker can free fall no more than two feet. All belts or harnesses shall be secured to an anchorage capable of supporting at least twice the potential impact load of an employee's fall or 3,000 pounds, whichever is greater.

Warning Line Systems

Warning line systems used on roofs shall consist of ropes, wires or chains, and supporting stanchions. The warning lines shall be constructed as follows:

- Flagged at not more than six foot intervals with high visibility material;
- Rigged and supported so that the lowest point including sag is no less than 34 inches from the walking/working surface and its highest point is no more than 39 inches from the walking/working surface;
- **Stanchions**, after being rigged with warning lines, shall be capable of resisting, without tipping over, a force of at least 16 pounds applied horizontally against the stanchion, 30 inches above the walking/working surface, perpendicular to the warning line and in the direction of the floor, roof or platform edge;
- The rope, wire or chain shall have a minimum tensile strength of 500 pounds and after being attached to the stanchions, shall support without breaking the load applied to the stanchions as prescribed above; and
- Shall be attached to each stanchion in such a way that pulling on one section of the line between stanchions will not result in slack being taken up in the adjacent section before the stanchion tips over.

When mechanical equipment is being used, the warning line shall be erected not less than six feet from the roof edge parallel to the direction of mechanical equipment operation, and not less than 10 feet from the roof edge perpendicular to the direction of mechanical equipment operation.

When mechanical equipment is not being used, the warning line shall be erected not less than six feet from the roof edge.

Hoist Areas

All employees in a **hoist area** shall be protected from falling six feet or more by guardrail systems or personal fall arrest systems. If guardrail systems or portions thereof must be removed to facilitate hoisting operations, as during the landing of materials, and a worker must lean through the access opening to receive or guide equipment and materials, that employee shall be protected by a personal fall arrest system.

Holes, Openings, Ramps, Runways and Other Walkways

All holes, openings, ramps, **runways**, and other walkways crossing or covering openings six feet or more, shall be protected with a guardrail system.

Wall Openings

All employees working on, at or near wall openings where the bottom edge of the wall opening is six feet or more and the inside bottom edge of the wall opening is less than 39 inches above the walking/working surface, shall be protected by use of either a guardrail system or a personal fall arrest system.

Covers

Covers used over openings in the roadways and vehicular aisles shall meet the following criteria:

- Support twice the maximum axle weight of the largest vehicle the cover might be subjected;
- Support twice the weight of employees, equipment and materials that may be imposed on the cover at anytime;
- Be secured at all times; and
- Be identified with markings indicating “HOLE” or “COVER”.

Roofs

Low-Sloped Roofs

All employees working on **low-sloped roofs** with unprotected sides and edges six feet or more above the lower levels shall be protected from falling by guardrail systems or a combination warning line system and personal fall arrest system, or a combination warning line system and a safety monitoring system.

Roofs that are 50 feet or less in width can use a safety monitoring system without a warning line system.

Steep Roofs

All employees on a **steep roof** with unprotected sides and edges six feet or more above the lower levels shall be protected by either guardrail systems with toe boards or a personal fall arrest system.

Protection from Falling Objects

When guardrail systems are used to prevent materials from falling from one level to another, any opening shall be small enough to prevent passage of potential falling objects. No materials or equipment, except masonry or mortar shall be stored within four feet of working edges. Excess mortar, broken or scattered masonry, and all other materials and debris shall be kept clear of the working area by removal at regular intervals.

During roofing work, materials and equipment shall not be stored within six feet of a roof edge unless guardrails are erected at the edge, and materials piled, grouped, or stacked near a roof edge shall be stable and self-supporting.

Canopies

When **canopies** are used as protection from falling objects they shall be constructed strong enough to prevent collapse and to prevent penetration by any objects that fall onto them.

Toe boards

When **toe boards** are used as protection from falling objects, they shall be erected along the edges of the overhead walking or working surface for a distance sufficient to protect persons working below. Toe boards shall be capable of withstanding a force of at least 50 pounds applied in any downward or outward direction at any point along the toe board. Toe boards shall be a minimum of three and one half inches tall from their top edge to the level of the walking/working surface, have no more than 0.25 inches clearance above the walking/working surface, and be solid or have openings no larger than one inch in size.

Where tools, equipment, or materials are piled higher than the top edge of a toe board, paneling or screening shall be erected from the walking/working surface or toe board to the top of a guardrail system's top rail or midrail, for a distance sufficient to protect persons below.

Safety Monitoring Systems

If no fall protection, including personal fall arrest systems, warning line systems, controlled access zones or guardrail system can be implemented, then a safety monitoring system shall be established. The responsible department shall designate a safety monitor to monitor the safety of the workers. The safety monitor shall:

- Be competent in the recognition of fall hazards;
- Be capable of warning workers of fall hazard dangers;
- Detect unsafe work practices as in accordance with this policy;
- Work on the same surface as the workers and maintain visual contact of all employees;
- Be close enough to the work operations to communicate orally with the workers; and
- Have no other duties that will interfere or distract from the monitoring function.

Mechanical equipment shall not be used or stored in areas where safety-monitoring systems are being used to monitor employees engaged in roofing operations on low-sloped roofs.

No worker, other than one engaged in work on low-sloped roofs, or covered by a personal fall arrest system, shall be allowed in an area where the employee is being protected by a safety monitoring system.

All workers in a controlled access zone shall be instructed to promptly comply with all fall warnings issued by the safety monitors.

Training

All employees that are exposed to fall hazards shall be trained in the recognition and minimization of such hazards. Training shall be arranged through Facilities Services – Safety and Environmental Affairs. The employee shall be trained in the following areas:

- Nature of fall hazards in the work area;
- The correct procedures for erecting, maintaining, disassembling and inspecting fall protection systems;
- The use and operation of controlled access zones and guardrail, personal fall arrest and warning lines;
- The limitations on the use of mechanical equipment during the performance of roofing work on low-slope roofs;
- The correct procedures for equipment and materials handling and storage and the erection of overhead protection; and
- The employee's role in fall protection plans.

3.2 Back – Lifting Safety

Planning

Proper lifting technique is critical to back safety, but perhaps more important is proper planning.

Before you lift that box, or tool, or piece of equipment, takes a moment to consider your action:

- Do you need to lift the item manually?
- How heavy is it?
- Where are you moving the item?
- Where does it have to go?
- What route do you have to follow?

Many times the item you are moving could be moved with a piece of equipment - a dolly, a hand truck, a forklift. Consider using mechanical help wherever possible. If the item needs to be moved manually, and it is heavy, or ungainly, ask for help.

When using mechanical help, remember to push, not pull - you'll have more control, and greater leverage. Fasten the load to the equipment, so sudden stops or vibration doesn't jar it off.

When moving an item from a hard-to-reach place, be sure to position yourself as close to the load as possible. Slide it out to get it closer, and be sure that you have adequate room for your hands and arms. Be aware of adjacent obstructions, on either side or above the load.

Think about where the item will be placed once you've lifted it - will it be overhead? Under an overhang? In a narrow spot? Try to allow yourself as much room as possible to set the load down. You can always shift it slightly later.

Check your path from place to place - remove tripping hazards, protect openings, set up a well wheel or a bucket and line if you need to get materials up a ladder. Make sure that the lighting is sufficient to see where you are going. Stabilize uneven or loose ground, or choose an alternate route. The shortest way isn't always the fastest, or the safest.

Balance

As in life in general, moderation and balance are important considerations in care and maintenance of your back. You need the correct proportions of strength, flexibility, and overall quality of life to eliminate or minimize back injuries.

You need to exercise, eat right, and stretch as often as possible to help prevent injuries, and to recover more quickly if injured. In addition, a reduction in stress levels can help to relieve the muscle tension that can contribute to injuries. Remember that most back injuries can be attributed to one of these five causes:

- Posture
- Body Mechanics/Work Habits
- Stressful Living
- Loss of Flexibility
- Poor Conditioning

Also consider that not all back injuries are a result of sudden trauma - most are of a cumulative type, where a repeated minor injury has flared up, or continued use of a heavy tool in the same position has caused pain, or a great deal of time is spent in the same position.

Remember that 80% of back injuries occur in people between the ages of 30 and 50 ... with expected life span in America reaching nearly 80 years, that is a long time to live in pain, or with limited mobility.

Technique

- Stand Close to the Load

- Grip Firmly
- Bring the Load Close to your Body
- Lift Head and Shoulders First, and With Your Back Straight, Use the Strength of Your Legs to Slowly and Smoothly Push Up
- Make Sure That You Can See Over the Load
- DON'T TWIST YOUR BODY. Torque Action Can Be Especially Dangerous. Move Your Feet First to Change Direction
- Bend Your Knees to Lower the Load
- Keep Your Fingers from Under the Load
- Lower Slowly and Smoothly
- When in Doubt, ASK FOR HELP!

Conclusion

Care and maintenance of your back is every bit as important as the care and maintenance of your vehicle, your home, or your tools, but this most important asset of our physical being is commonly overlooked or neglected.

Your back is the foundation and the structure upon which the rest of your body relies for balance and support. Used improperly, or unsafely, your back can suffer injuries that can literally change the way you live.

Care of your back is a lifelong endeavor that requires commitment, intelligence, and common sense. Remember that back care isn't just about lifting properly; it is also about proper diet, exercise, reducing stress, eliminating hazards where possible. Just as the health of your back can affect your lifestyle, your lifestyle and work habits can affect the health of your back.

3.3 Hand and Portable Powered Tools

Hazard Recognition

Tools are such a common part of our lives that it is difficult to remember that they may pose hazards. All tools are manufactured with safety in mind but, tragically, a serious accident often occurs before steps are taken to search out and avoid or eliminate tool-related hazards.

In the process of removing or avoiding the hazards, workers must learn to recognize the hazards associated with the different types of tools and the safety precautions necessary to prevent those hazards.

Hand Tools

Hand tools are non-powered. They include anything from axes to wrenches. The greatest hazards posed by hand tools result from misuse and improper maintenance.

Some examples:

- Using a screwdriver as a chisel may cause the tip of the screwdriver to break and fly, hitting the user or other employees.
- If a wooden handle on a tool such as a hammer or an axe is loose, splintered, or cracked, the head of the tool may fly off and strike the user or another worker.
- A wrench must not be used if its jaws are sprung, because it might slip.
- Impact tools such as chisels, wedges, or drift pins are unsafe if they have mushroomed heads. The heads might shatter on impact, sending sharp fragments flying.

The employer is responsible for the safe condition of tools and equipment used by employees but the employees have the responsibility for properly using and maintaining tools.

Employers should caution employees that saw blades, knives, or other tools be directed away from aisle areas and other employees working in close proximity. Knives and scissors must be sharp. Dull tools can be more hazardous than sharp ones.

Appropriate personal protective equipment, e.g., safety goggles, gloves, etc., should be worn due to hazards that may be encountered while using portable power tools and hand tools.

Safety requires that floors be kept as clean and dry as possible to prevent accidental slips with or around dangerous hand tools.

Around flammable substances, sparks produced by iron and steel hand tools can be a dangerous ignition source. Where this hazard exists, spark-resistant tools made from brass, plastic, aluminum, or wood will provide for safety.

Power Tool Precautions

Power tools can be hazardous when improperly used. There are several types of power tools, based on the power source they use: electric, pneumatic, liquid fuel, hydraulic, and powder-actuated.

Employees should be trained in the use of all tools - not just power tools. They should understand the potential hazards as well as the safety precautions to prevent those hazards from occurring.

The following general precautions should be observed by power tool users:

- Never carry a tool by the cord or hose.
- Never yank the cord or the hose to disconnect it from the receptacle.
- Keep cords and hoses away from heat, oil, and sharp edges.

- Disconnect tools when not in use, before servicing, and when changing accessories such as blades, bits and cutters.
- All observers should be kept at a safe distance away from the work area.
- Secure work with clamps or a vise, freeing both hands to operate the tool.
- Avoid accidental starting. The worker should not hold a finger on the switch button while carrying a plugged-in tool.
- Tools should be maintained with care. They should be kept sharp and clean for the best performance. Follow instructions in the user's manual for lubricating and changing accessories.
- Be sure to keep good footing and maintain good balance.
- The proper apparel should be worn. Loose clothing, ties, or jewelry can become caught in moving parts.
- All portable electric tools that are damaged shall be removed from use and tagged "Do Not Use."

Guards

Hazardous moving parts of a power tool need to be safeguarded. For example, belts, gears, shafts, pulleys, sprockets, spindles, drums, fly wheels, chains, or other reciprocating, rotating, or moving parts of equipment must be guarded if such parts are exposed to contact by employees.

Guards, as necessary, should be provided to protect the operator and others from the following:

- Point of operation,
- In-running nip points,
- Rotating parts, and
- Flying chips and sparks.

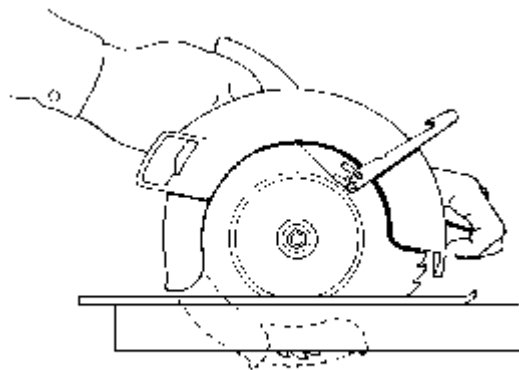

Safety guards must never be removed when a tool is being used. For example, portable circular saws must be equipped with guards. An upper guard must cover the entire blade of the saw. A retractable lower guard must cover the teeth of the saw, except when it makes contact with the work material. The lower guard must automatically return to the covering position when the tool is withdrawn from the work.

Safety Switches

The following hand-held powered tools must be equipped with a momentary contact "on-off" control switch: drills, tapers, fastener drivers, horizontal, vertical and angle grinders with wheels larger than 2 inches in diameter, disc and belt sanders, reciprocating saws, saber saws, and other similar tools. These tools also may be equipped with a lock-on control provided that turnoff can be accomplished by a single motion of the same finger or fingers that turn it on.

The following hand-held powered tools may be equipped with only a positive "on-off" control switch: platen sanders, disc sanders with discs 2 inches or less in diameter; grinders with wheels 2 inches or less in diameter; routers, planers, laminate trimmers, nibblers, shears, scroll saws and jigsaws with blade shanks ¼-inch wide or less.

Other hand-held powered tools such as circular saws having a blade diameter greater than 2 inches, chain saws, and percussion tools without positive accessory holding means must be equipped with a constant pressure switch that will shut off the power when the pressure is released.

Electric Tools

Employees using electric tools must be aware of several dangers; the most serious is the possibility of electrocution.

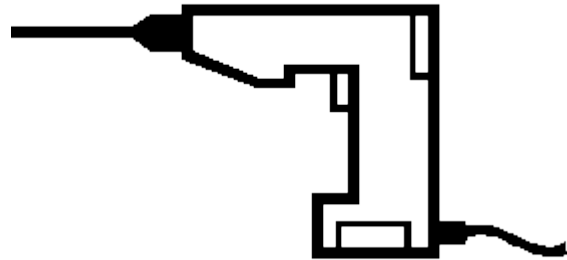

Among the chief hazards of electric-powered tools are burns and slight shocks, which can lead to injuries or even heart failure. Under certain conditions, even a small amount of current can result in fibrillation of the heart and eventual death. A shock also can cause the user to fall off a ladder or other elevated work surface.

To protect the user from shock, tools must either have a three-wire cord with ground and be grounded, be double insulated, or be powered by a low-voltage isolation transformer. Three-wire cords contain two current-carrying conductors and a grounding conductor. One end of the grounding conductor connects to the tool's metal housing. The other end is grounded through a prong on the plug. Anytime an adapter is used to accommodate a two-hole receptacle, the adapter wire must be attached to a known ground. The third prong should never be removed from the plug.

Double insulation is more convenient. The user and the tools are protected in two ways: by normal insulation on the wires inside, and by a housing that cannot conduct electricity to the operator in the event of a malfunction.

These general practices should be followed when using electric tools:

- Electric tools should be operated within their design limitations.
- Gloves and safety footwear are recommended during use of electric tools.
- When not in use, tools should be stored in a dry place.
- Electric tools should not be used in damp or wet locations.
- Work areas should be well lighted.

Powered Abrasive Wheel Tools

Powered abrasive grinding, cutting, polishing, and wire buffing wheels create special safety problems because they may throw off flying fragments.

Before an abrasive wheel is mounted, it should be inspected closely and sound- or ring-tested to be sure that it is free from cracks or defects. To test, wheels should be tapped gently with a light non-metallic instrument. If they sound cracked or dead, they could fly apart in operation and so must not be used. A sound and undamaged wheel will give a clear metallic tone or "ring."

To prevent the wheel from cracking, the user should be sure it fits freely on the spindle. The spindle nut must be tightened enough to hold the wheel in place, without distorting the flange. Follow the manufacturer's recommendations. Care must be taken to assure that the spindle wheel will not exceed the abrasive wheel specifications.

Due to the possibility of a wheel disintegrating (exploding) during start-up, the employee should never stand directly in front of the wheel as it accelerates to full operating speed.

Portable grinding tools need to be equipped with safety guards to protect workers not only from the moving wheel surface, but also from flying fragments in case of breakage.

In addition, when using a powered grinder:

- Always use eye protection.
- Turn off the power when not in use.
- Never clamp a hand-held grinder in a vise.

Pneumatic Tools

Pneumatic tools are powered by compressed air and include chippers, drills, hammers, and sanders.

There are several dangers encountered in the use of pneumatic tools. The main one is the danger of getting hit by one of the tool's attachments or by some kind of fastener the worker is using with the tool.

Eye protection is required and face protection is recommended for employees working with pneumatic tools.

Noise is another hazard. Working with noisy tools such as jackhammers requires proper, effective use of hearing protection.

When using pneumatic tools, employees must check to see that they are fastened securely to the hose to prevent them from becoming disconnected. A short wire or positive locking device attaching the air hose to the tool will serve as an added safeguard.

A safety clip or retainer must be installed to prevent attachments, such as chisels on a chipping hammer, from being unintentionally shot from the barrel.

Screens must be set up to protect nearby workers from being struck by flying fragments around chippers, riveting guns, staplers, or air drills.

Compressed air guns should never be pointed toward anyone. Users should never "dead-end" it against themselves or anyone else.

Powder-Actuated Tools

Powder-actuated tools operate like a loaded gun and should be treated with the same respect and precautions. In fact, they are so dangerous that they must be operated only by specially trained employees.

Safety precautions to remember include the following:

- These tools should not be used in an explosive or flammable atmosphere.
- Before using the tool, the worker should inspect it to determine that it is clean, that all moving parts operate freely, and that the barrel is free from obstructions.
- The tool should never be pointed at anybody.
- The tool should not be loaded unless it is to be used immediately. A loaded tool should not be left unattended, especially where it would be available to unauthorized persons.
- Hands should be kept clear of the barrel end. To prevent the tool from firing accidentally, two separate motions are required for firing: one to bring the tool into position, and another to pull the trigger. The tools must not be able to operate until they are pressed against the work surface with a force of at least 5 pounds greater than the total weight of the tool.

If a powder-actuated tool misfires, the employee should wait at least 30 seconds, then try firing it again. If it still will not fire, the user should wait another 30 seconds so that the faulty cartridge is less likely to explode, than carefully remove the load. The bad cartridge should be put in water.

Suitable eye and face protection are essential when using a powder-actuated tool.

The muzzle end of the tool must have a protective shield or guard centered perpendicularly on the barrel to confine any flying fragments or particles that might otherwise create a hazard when the tool is fired. The tool must be designed so that it will not fire unless it has this kind of safety device.

All powder-actuated tools must be designed for varying powder charges so that the user can select a powder level necessary to do the work without excessive force.

If the tool develops a defect during use it should be tagged and taken out of service immediately until it is properly repaired.

Fasteners

When using powder-actuated tools to apply fasteners, there are some precautions to consider. Fasteners must not be fired into material that would let them pass through to the other side. The fastener must not be driven into materials like brick or concrete any closer

than 3 inches to an edge or corner. In steel, the fastener must not come any closer than one-half inch from a corner or edge. Fasteners must not be driven into very hard or brittle materials, which might chip or splatter, or make the fastener ricochet.

An alignment guide must be used when shooting a fastener into an existing hole. A fastener must not be driven into a spalled area caused by an unsatisfactory fastening.

Hydraulic Power Tools

The fluid used in hydraulic power tools must be an approved fire-resistant fluid and must retain its operating characteristics at the most extreme temperatures to which it will be exposed.

The manufacturer's recommended safe operating pressure for hoses, valves, pipes, filters, and other fittings must not be exceeded.

Jacks

All jacks - lever and ratchet jacks, screw jacks, and hydraulic jacks - must have a device that stops them from jacking up too high. Also, the manufacturer's load limit must be permanently marked in a prominent place on the jack and should not be exceeded.

A jack should never be used to support a lifted load. Once the load has been lifted, it must immediately be blocked up.

Use wooden blocking under the base if necessary to make the jack level and secure. If the lift surface is metal, place a 1-inch-thick hardwood block or equivalent between it and the metal jack head to reduce the danger of slippage.

To set up a jack, make certain of the following:

- The base rests on a firm level surface,
- The jack is correctly centered,
- The jack head bears against a level surface, and
- The lift force is applied evenly.

Proper maintenance of jacks is essential for safety. All jacks must be inspected before each use and lubricated regularly. If a jack is subjected to an abnormal load or shock, it should be thoroughly examined to make sure it has not been damaged.

Hydraulic jacks exposed to freezing temperatures must be filled with an adequate antifreeze liquid.

General Safety Precautions

Employees who use hand and power tools and who are exposed to the hazards of falling, flying, abrasive and splashing objects, or exposed to harmful dusts, fumes, mists, vapors, or gases must be provided with the particular personal equipment necessary to protect them from the hazard.

All hazards involved in the use of power tools can be prevented by following five basic safety rules:

- Keep all tools in good condition with regular maintenance.
- Use the right tool for the job.
- Examine each tool for damage before use.
- Operate according to the manufacturer's instructions.
- Provide and use the proper protective equipment.
- Employees and employers have a responsibility to work together to establish safe working procedures. If a hazardous situation is encountered, it should be brought to the attention of the proper individual immediately.

3.4 Vibration Hazardous

A “caution zone job” is a job where an employee’s typical work activities include any of the specific physical risk factors listed below. Typical work activities are those that a regular and foreseeable part of the job and **occur on more than one day per week, and more frequently than one week per year.**

Moderate to High Hand-Arm Vibration

- Using impact wrenches, carpet strippers, chain saws, percussive tools (jack hammers, scalers, riveting or chipping hammers) or other hand tools that typically have high vibration levels more than **30 minutes total per day**
- Using grinders, sanders, jig saws or other hand tools that typically have moderate vibration levels more than **2 hours total per day**

A complete assessment of exposure to vibration requires the measurement of acceleration in well-defined directions, frequencies and duration of exposure. How hard a person grips a tool affects the amount of vibration energy entering the hands; therefore, handgrip force is another important factor in the exposure assessment.

Most jurisdictions and agencies use acceleration as a measure of vibration exposure for the following reasons:

- Several types of instruments are available for measuring acceleration, the rate of change of velocity in speed or direction per unit time (e.g., per second).
- Measuring acceleration can also give information about velocity and amplitude of vibration.
- The degree of harm is related to the magnitude of acceleration.

Protecting workers from the effects of vibration usually requires a combination of appropriate tool selection, the use of appropriate vibration-absorbing materials (in gloves, for example), good work practices, and education programs.

Anti-Vibration Gloves

Conventional protective gloves (e.g., cotton, leather), commonly used by workers, do not reduce the vibration that is transferred to workers' hands when they are using vibrating tools or equipment. Anti-vibration gloves are made using a layer of viscoelastic material. Actual measurements have shown that such gloves have limited effectiveness in absorbing low-frequency vibration, the major contributor to vibration-related disorders. Therefore, they offer little protection against developing vibration-induced white finger syndrome. However, gloves do provide protection from typical industrial hazards (e.g., cuts, abrasions) and from cold temperatures that, in turn, may reduce the initial sensation of white finger attacks.

Safe Work Practices

Along with using anti-vibration tools and gloves, workers can reduce the risk of hand-arm vibration syndrome (HAVS) by following work practices:

- Employ a minimum handgrip consistent with safe operation of the tool or process.
- Wear sufficient clothing, including gloves, to keep warm.
- Avoid continuous exposure by taking rest periods.
- Rest the tool on the work piece whenever practical.
- Refrain from using faulty tools.
- Maintain properly sharpened cutting tools.
- Consult a doctor at the first sign of vibration disease and ask about the possibility of changing to a job with less exposure.

Employee Education

Training programs are an effective means of heightening the awareness of HAVS in the workplace. Training should include proper use and maintain vibrating tools to avoid unnecessary exposure to vibration. Vibrating machines and equipment often produce loud noise as well. Therefore, training and education in controlling vibration should also address concerns about noise control.

Whole-Body Vibration

The following precautions help to reduce whole-body vibration exposure:

- Limit the time spent by workers on a vibrating surface.
- Mechanically isolate the vibrating source or surface to reduce exposure.
- Ensure that equipment is well maintained to avoid excessive vibration.
- Install vibration-damping seats.

The vibration control design is an intricate engineering problem and must be set up by qualified professionals. Many factors specific to the individual workstation govern the choice of the vibration isolation material and the machine mounting methods.

The American Conference of Governmental Industrial Hygienists (ACGIH) has developed Threshold Limit Values (TLVs) for vibration exposure from hand-held tools.

The exposure limits are given as frequency-weighted acceleration that represents a single number measure of the vibration exposure level. The frequency weighting is based on a scheme recommended in the international standard ISO 5349. Vibration-measuring instruments have a frequency-weighting network as an option for vibration measurement. Table 1 lists acceleration levels and exposure durations to which, ACGIH has determined, most workers may be exposed repeatedly without severe damage to fingers. ACGIH advises that these guidelines be applied in conjunction with other protective measures including vibration control.

Table 1 The ACGIH Threshold Limit Values (TLVs) for exposure of the hand to vibration in X, Y, or Z direction*	
Total Daily Exposure Duration (hours)	Maximum value of frequency weighted acceleration (m/s²) in any direction*
4 to less than 8 hours	4
2 to less than 4 hours	6
1 to less than 2 hours	8
Less than 1 hour	12

Directions of axes in the three-dimensional system

3.5 Machinery

All mechanical motion is potentially hazardous. Motion hazards, such as rotating devices, cutting or shearing blades, in-running nip points, reciprocating parts, linear moving belts and pulleys, meshing gears, and uncontrolled movement of failing parts, are examples of motion and peculiar to any one machine or job operation. Personnel working within areas where they are exposed to machinery or equipment hazards must be aware of the potential accidents. Machine operators and others are exposed to moving parts and can get clothing or body parts caught in the machinery.

A. General

1. Personnel Training

- a. Personnel should be trained to safely operate each machine they will be required to use;
- b. To recognize potential accident producing situations; and
- c. To know what to do when hazards are discovered.

Only personnel who have been thoroughly trained, or those who are undergoing supervised on-the-job training on the equipment, will be permitted to operate machinery.

2. Personal Protective Equipment

- a. All personnel within areas where machines are operated must wear eye protection or face shields.
- b. Machine operators or their helpers will not wear loose fitting clothing, neckties, rings, bracelets, or other apparel that may become entangled in moving machinery.
- c. Hairnets or caps will be worn to keep long hair away from moving machinery.
- d. Gloves will not be worn where there is a chance of them being caught in machinery.
- e. Earplugs or muffs will be used when required for worker protection.
- f. The Office of Health and Safety should be contacted to assist supervisors in determining personnel protective equipment needs.

3. Environmental

- a. Machines designed for fixed locations will normally be securely fastened to the floor or other suitable foundation to eliminate all movement or "walking." Machines equipped with rubber feet, non-skid foot pads, or similar vibration dampening materials will be installed according to the manufacturer's recommendations. Machines that have the potential of tipping or falling over will be firmly secured.
- b. Machines that develop fine dust and fumes will be equipped with effective exhaust hoods, connected to an effective exhaust system. An interlocking device should be installed to link the machine's power supply and the exhaust system to prevent the operation of machines without the exhaust system operating.
- c. Machines will never be left unattended with the power on unless the worker is operating more than one machine in a battery of machines. In this latter instance, the clear zone will be appropriately marked to include all machines in the group.
- d. No attempt will be made to clean any part of a machine until the moving parts have come to a complete stop. Chips will not be removed from machinery by hand. Hand brushes should be used but compressed air may be used when reduced

- to less than 30 psi and then only with effective chip guarding and personal protective equipment.
- e. Brushes, swabs, lubricating rolls, and automatic or manual pressure guns will be used by operators to lubricate material, punches, or dies. This equipment will be used so that operators are not required to reach into the point of operation or other hazardous area.
 - f. Housekeeping
 - 1) Floors will be kept in good repair and free of chips, dust, metal scraps, and other slipping and tripping hazards.
 - 2) Waste containers will be emptied daily or more often, if necessary, to prevent excessive waste accumulations.
 - 3) All materials, including usable scrap, will be stored so that they will not present a hazard.
 - 4) Drip pans will be used whenever equipment must be oiled. Machinery will not be in motion when being lubricated unless lubrication is automatic or a long gravity flow spout is used, enabling the oiler to remain in the clear while performing this task.
 - 5) Material Handling
 - a) Trucks used for scrap disposal will not be overloaded, and scrap will not extend beyond the ends or sides of trucks.
 - b) When materials are of a weight or size, which makes manual lifting hazardous, mechanical handling equipment will be used.
 - 6) Maintenance/Repair
 - a) When maintenance or repair is needed, machines will be completely shut down and the control switch(es) locked and tagged in the "OFF" position.
 - b) Cutting tools will be kept sharp and forming tools well dressed and free from accumulations of chips, dust, and other foreign matter. Where two or more cutting tools are used in one cutting head, they will be properly adjusted and balanced.
 - c) Damaged cutting tools will be removed from service and will not be used until repaired.
 - 7) Usage

a) Machines will be used only for work within the rated capacity specified by the machine manufacturer.

b) Machines will be maintained so that while running at full or idle speed, with the largest cutting tool attached, they are free of excessive vibration.

c) Machines will be completely stopped before attempting to clear jammed work or debris.

d) No saw blade, cutter head, or tool collar will be placed or mounted on a machine arbor, unless it has been accurately sized and shaped to fit the arbor.

8) Electrical Safeguards

a) The motor "START" button will be protected against accidental/inadvertent operation. "START" buttons will not be wedged for continuous operation.

b) The wiring and grounding of machinery will be in accordance with the National Electric Code.

c) Each machine will have a positive electrical disconnect or isolation switch which can be locked out.

d) Electrically driven machines will be equipped with under voltage protective systems to preclude automatic restart after either a power failure or other under voltage condition.

9) Controls

a) Foot pedal mechanisms will be located and guarded so that they cannot be activated by falling objects or other accidental means. A pad with a non-slip contact area will be firmly attached to the pedal.

b) Controls will be available to the workers at their operating positions so that they do not reach over moving parts of the equipment. Control functions will be identified by printed words and color-coding. Controls will not be wedged for continuous operation.

c) Power controls must have a way of locking out electrical power. Disconnecting or isolating switches will be mounted on a visible side of, or near, the machine and will be used to lock out power to the machine during repairs or adjustments. When the power is locked out, the isolating switch will be tagged.

B. Guards

Many accidents are caused by machinery that is improperly guarded or not guarded at all. Important factor that must be kept in mind relative to machinery guarding is that no mechanical motion that threatens a worker's safety should be left without a safeguard.

The following areas of machinery will be provided with barriers and/or enclosures that will effectively prevent personnel from coming in contact with moving components:

1. Point of operation exposures such as blades, knives and cutting heads.
2. Power transmission exposures such as belts, pulleys, shaft, gears, etc.
3. Top, bottom and backside exposures, such as the underside of table saws and the wheels on band saws.
4. When a point-of-operation guard cannot be used because of unusual shapes or cuts, jigs or fixtures, which will provide equal safety for the operator, will be used. Upon completion of an unusual operation, the guard will be immediately replaced.
5. Whenever a guard is removed for other than an operational requirement, the machine will be shut down and the control switch(es) locked and tagged in the "OFF" position.
6. Guards will be affixed to the machine. Where possible, they will be of the hinged type to enhance maintenance or adjustments.

3.6 Band Saw

What should you do before using a band saw?

A band saw can be dangerous if not used properly.

- Read the owner's manual carefully.
- Make sure you understand the instructions before attempting to use any tool or machine.
- Learn the applications and limitations before use.
- Securely anchor the band saw to the floor (or a workbench of appropriate height) to reduce vibration.
- Refer to [Woodworking Machines - General Safety Tips](#) for general safety precautions.

What safety procedures should you follow when using a band saw?

- Wear safety glasses or a face shield.
- Wear hearing protection that is suitable for the level and frequency of the noise you are exposed to in the woodworking area.

- Make sure all guards are in place and properly adjusted. Ensure all band wheels are enclosed.
- Adjust blade guard height to about 3 mm or 1/8 inch above the top of the material being cut.
- Ensure the blade is tracking correctly and runs freely in and against the upper and lower guide rollers.
- Ensure the blade is under proper tension. A band saw equipped with automatic tension control is desirable.
- Use band saw blades that are sharp, properly set and otherwise suitable for the job (e.g., the right tooth pitch; tooth form; blade width).
- Hold stock firmly and flat on the table to prevent the stock from turning and drawing your fingers against the blade. Keep hands braced against the table.
- Use a push stick when you remove cut pieces from between the fence and saw blade or when your hands are close to the blade. Keep your hands on either side of the blade - not in line with the cutting line and the blade. See Woodworking Machines - Push Sticks for more information on push stick design.
- Make release (relief) cuts before tight curves when doing intricate scroll-type work.
- Keep the floor around a band saw clean and free of obstructions or clutter.
- Keep the machine properly oiled and serviced.
- Provide adequate lighting at the machine table. A light fixture with a flexible connection can provide essential lighting.

What should you avoid when working with a band saw?

- Do not use excessive force when pushing the wood past the blade.
- Do not back the stock away from the blade while the saw is in motion if the work piece binds or pinches on the blade.
- Do not stop a band saw by thrusting stock against the cutting edge or the side of a blade immediately after the power has been shut off.
- Do not remove sawdust or cuttings from the table by hand or with compressed air. Use a stick or brush.
- Do not leave a saw running unattended. Turn off the power and make sure the machine has stopped running before leaving the area.

3.7 Overhead and Gantry Cranes

Please note that this program has a glossary. The glossary contains the definitions for various terms used in the program. These terms are highlighted in bold print the first time they appear in the body of the program.

Policy

Overhead and **gantry cranes** shall be operated and maintained in accordance with any and all applicable regulations and as recommended by the manufacturer.

Scope

This policy applies to overhead and gantry **cranes**, including semi gantry, cantilever gantry, wall cranes, storage bridge cranes and other hoisting equipment that have the same fundamental characteristics.

Procedures

Operations

The operator of the aforementioned devices shall perform his/her duties as follows:

1. Equipment shall be operated by a qualified operator or trainee that is under the direct supervision of the qualified operator. *Exception:* Maintenance and test personnel and inspectors, when in the performance of their duties, shall be allowed access only after permission has been granted by the operator;
2. The operator, when operating the equipment, shall maintain full attention on the task being performed (e.g., no use of headsets, music);
3. The operator shall ensure that hand signals used during the lift are understood and followed by all involved;
4. No load in excess of the rated capacity shall be lifted, unless for test purposes, and the test shall be an **engineered lift**;
5. Before leaving the crane or carrier unattended, the operator shall land any load, place the controls or master switch in the off position and open the main line device of the specific crane or carrier;
6. The **main line disconnect** shall not be closed until the operator has made sure that no one is on or adjacent to the crane or carrier;
7. If the crane or carrier has been locked out or tagged out, the operator shall not remove the lock or tag, unless the lock or tag has been placed there by the operator. To remove someone else's lock or tag refer to the Lockout/Tagout program, section 3.2 of the CEE Department Safety Manual;
8. For cab-operated equipment, make sure that all controls are in the "off" position prior to closing the line disconnect;

9. During use of cab-operated equipment, if the power should fail, the operator shall turn off all controllers. Before restarting, the operator shall check the motion controls for proper direction to ensure controls are in the neutral position; and
10. Persons boarding or leaving cab-operated equipment shall do so at the designated point of access or egress.

Attaching the Load

1. Hoist chains or ropes shall be free of kinks or twists.
2. Hoist chains or ropes shall not be wrapped around the load.
3. The load shall be attached to the **load block**.
4. Prior to lifting the load, the operator shall make certain that the load; sling, attachments, lifting devices and the load block are unobstructed.

Moving the Load

1. The person responsible for directing the lift shall make sure that the load is properly secured, balanced and positioned in the sling or other lifting device.
2. The person responsible for directing the lift shall make another visual inspection of the hoist chain or rope to make sure there are no kinks or twists.
3. The load block shall be brought over the load in a manner that will prevent swinging when lifting the load.
4. The chain or rope shall be inspected to ensure that it is properly seated in the **chain sprocket or drum groove**.
5. Lift equipment shall not be used for side pulls.
6. The operator shall not lift, travel or lower a load while someone is on the load or hook.
7. The operator shall avoid lifting the load over people.
8. If the load being lifted approaches the rated load to be handled, the operator shall test the brakes by lifting the load a few inches and applying the brakes.
9. The load shall not be lowered below the point where there is less than two wraps of rope on the hoisting drum, unless a lower limit device is provided. If a lower limit device is provided, no less than one wrap shall remain.

Parking the Load

1. The operator shall not leave a suspended load unattended.
2. The load block of the hoist shall be raised above head level when not in use.

Hand Signals

Hand signals shall be used unless the participants of the lift are equipped with telephones, radios or other equivalent means of communication.

Inspection Procedure

Cranes in Periodic Use

A crane or overhead gantry that has not been used for a period of one month or more shall be inspected before each use and the focus for such an inspection is as follows:

1. Inspect all functional operating mechanisms;
2. Check for damage to or leaks from lines, tanks, valves, drain pumps, and air or hydraulic systems;
3. Check the load hook for deformities or cracks;
4. Check all hoist chains for excessive wear, including end connectors.
5. Check all chains for kinks, twists and distorted links and stretches that are beyond what is recommended by the manufacturer; and
6. Inspect the rope for damage such as kinks, cracks, cutting, bending, broken wires, unraveling, corroded or improperly connected end connections.

Regardless of how often a crane or overhead gantry is used, the unit shall be inspected annually. The inspection shall be performed by an outside contractor qualified to inspect the unit and the contractor shall document and provide the owner with a copy of the findings.

Maintenance

Preventive maintenance shall be performed as prescribed by the manufacturer as detailed in the owner's manual. Maintenance of the units shall be performed by an outside contractor qualified to perform maintenance.

Adjustments and Repair

Any unsafe condition noted during the inspection of the crane shall be repaired before the crane is used.

Training

Employees required to operate **overhead cranes** shall be required to participate in and successfully complete the curriculum of a training program before assuming their responsibilities. Training shall be arranged for by Facilities Services - Safety and Environmental Affairs.

Curriculum

The curriculum of the training program must, at a minimum, address the following topics:

1. Wire rope;
2. Slings;
3. Occupational Safety and Health Administration (OSHA) and American National Standards Institute (ANSI) standards;
4. Hoisting equipment manual and power;
5. Operation and safety awareness (including lock and tag procedures);
6. Basic rigging;

7. Field training and trials; and
8. Inspection procedures.

Retraining

Employees shall be required to participate in annual refresher training. Retraining may also be deemed necessary when it has been documented that the operator has failed to operate the crane in a safe and appropriate manner as directed by this policy and according to OSHA and ANSI regulations.

Curriculum for retraining shall cover the same topics as the initial training.

Glossary

Cantilever Gantry Crane: A gantry or semi gantry crane in which the bridge girders extend transversely beyond the crane runway on both sides.

Chain Sprocket or Drum Groove: Grooved or notched wheel that the hoist rope or chain is seated.

Crane: A machine used to raise, lower or move a load horizontally.

Engineered Lift: A test load that has been identified and evaluated for use in determining the lifting capacity of the hoisting equipment.

Gantry Crane: Similar to an overhead crane, except that the bridge for carrying the trolley or trolleys is rigidly supported on two or more legs running on fixed rolls or other runway.

Load Block: The assembly of hook, shackle, swivel, bearing, sheaves, pins, and frame suspended by the hoisting rope and used to attach the load to the hoisting cable or chain.

Main Line Disconnect: The controller used to isolate power to the hoisting equipment.

Overhead Crane: A crane with a movable bridge carrying a movable or fixed hoisting device that travels on a fixed runway.

Semi gantry Crane: A gantry crane with one end of the bridge rigidly supported on one or more legs that run along a fixed rail or runway, the other end of the bridge supported by a truck running on an elevated runway or rail.

3.8 Forklift Safety

General

Material handling is a significant safety concern. During the movement of products and materials there are numerous opportunities for personal injury and property damage if proper procedures and caution are not used. This document applies to all powered industrial trucks, hoists & lifting gear. The information in this document shall be used to train prospective industrial truck operators and provide the basis for refresher and annual retraining. OSHA reference for Powered Industrial Trucks is 1910.178.

Department is responsible for ensuring that the employee has been properly trained in the use of the forklift(s) they will be operating. It is the intent of the Department of Environmental Health and Safety to assist departments in understanding what the regulations require and how best to comply with them. EHS is available to assist departments in the implementation of these regulations. Please call 543-7201 to schedule a training session.

The procedures in the forklift safety program establish uniform recommendations designed to ensure that forklift safety training, operation, and maintenance practices are communicated to and understood by the affected employees.

The forklift safety program was developed to act as a reference for university employees and outside contractors who's duties require them to become a certified forklift operator. The program informs of general driving and operating procedures as well as precautions that should be taken.

Pre-Qualifications for Powered Industrial Truck (PIT) Operators

All candidates for PIT operators must meet the following basic requirements prior to starting initial or annual training:

- Must have no adverse vision problems that cannot be corrected by glasses or contacts
- No adverse hearing loss that cannot be corrected with hearing aids
- No physical impairments that would impair safe operation of the PIT
- No neurological disorders that affect balance or consciousness
- Not taking any medication that affects perception, vision, or physical abilities

Training

Training for Powered Industrial Truck (PIT) Operators shall be conducted by an experienced operator, selected by department. All operational training shall be conducted under close supervision. All training and evaluation must be completed before an operator is permitted to use a Powered Industrial Truck (forklift, etc) without continual & close supervision. Training consists of:

Trainees may operate a powered industrial truck only:

- Under the direct supervision of persons, selected by management, who have the knowledge, training, and experience to train operators and evaluate their competence; and
- Where such operation does not endanger the trainee or other employees.

Training Content

Training consists of a combination of formal instruction, practical training (demonstrations performed by the trainer and practical exercises performed by the trainee), and evaluation of the operator's performance in the workplace.

Initial Training: Powered industrial truck operators shall receive initial training in the following topics:

Truck-related training topics:

1. Operating instructions, warnings, and precautions for the types of truck the operator will be authorized to operate
2. Differences between the truck and the automobile
3. Truck controls and instrumentation: where they are located, what they do, and how they work
4. Engine or motor operation
5. Steering and maneuvering
6. Visibility (including restrictions due to loading)
7. Fork and attachment adaptation, operation, and use limitations
8. Vehicle capacity
9. Vehicle stability
10. Any vehicle inspection and maintenance that the operator will be required to perform
11. Refueling and/or charging and recharging of batteries
12. Operating limitations
13. Any other operating instructions, warnings, or precautions listed in the operator's manual for the types of vehicle that the employee is being trained to operate.

Workplace-related topics:

1. Surface conditions where the vehicle will be operated
2. Composition of loads to be carried and load stability
3. Load manipulation, stacking, and unstacking
4. Pedestrian traffic in areas where the vehicle will be operated
5. Narrow aisles and other restricted places where the vehicle will be operated
6. Hazardous (classified) locations where the vehicle will be operated

7. Ramps and other sloped surfaces that could affect the vehicle's stability
8. Closed environments and other areas where insufficient ventilation or poor vehicle maintenance could cause a buildup of carbon monoxide or diesel exhaust
9. Other unique or potentially hazardous environmental conditions in the workplace that could affect safe operation

Refresher training and evaluation Refresher training, including an evaluation of the effectiveness of that training, shall be conducted to ensure that the operator has the knowledge and skills needed to operate the powered industrial truck safely. Refresher training in relevant topics shall be provided to the operator when:

1. The operator has been observed to operate the vehicle in an unsafe manner
2. The operator has been involved in an accident or near-miss incident
3. The operator has received an evaluation that reveals that the operator is not operating the truck safely
4. The operator is assigned to drive a different type of truck
5. A condition in the workplace changes in a manner that could affect safe operation of the truck
6. Once every 3 years an evaluation will be conducted of each powered industrial truck operator's performance.

Safe Operating Procedures (SOP) & Rules

- Only authorized and trained personnel will operate PITs.
- All PITs will be equipped with a headache rack, fire extinguisher, rotating beacon, back-up alarm and seat belts. Seat belts will be worn at all times by the operator.
- The operator will perform daily pre- and post-trip inspections.
- Any safety defects (such as hydraulic fluid leaks; defective brakes, steering, lights, or horn; and/or missing fire extinguisher, lights, seat belt, or back-up alarm) will be reported for immediate repair or have the PIT taken "Out of Service".
- Operators will follow the proper recharging or refueling safety procedures.
- Loads will be tilted back and carried no more than 6 inches from the ground. Loads that restrict the operator's vision will be transported backwards.
- PITs will travel no faster than 5 mph or faster than a normal walk.
- PIT operators in high lift areas must wear hard hats.
- Operator will sound horn and use extreme caution when meeting pedestrians, making turns and cornering.
- Passengers may not ride on any portion of a PIT. Only the operator will ride PITs. "NO PASSENGERS" decals will be affixed on all PITs.

- If PITs are used as a man lift, an appropriate man lift platform (cage with standard rails and toe boards) will be used.
- Aisle will be maintained free from obstructions, marked and wide enough (six foot minimum) for vehicle operation.
- Lift capacity will be marked on all PITs. Operator will assure load does not exceed rated weight limits.
- When un-attended, PITs will be turned off, forks lowered to the ground and parking brake applied.
- All PITs (with exception of pallet jacks) will be equipped with a multi-purpose dry chemical fire extinguisher. (Minimum rating; 2A10BC)
- Operators are instructed to report all accidents, regardless of fault and severity, to Management. Management will conduct an accident investigation.
- When loading rail cars and trailers, dock plates will be used. Operators will assure dock plates are in good condition and will store on edge when not in use.
- Rail cars and trailers will be parked squarely to the loading area and have wheels chocked in place. Operators will follow established Docking/Undocking Procedures.

Changing and Charging Storage Batteries

- Battery charging installations shall be located in areas designated for that purpose.
- Facilities shall be provided for flushing and neutralizing spilled electrolyte, for fire protection, for protecting charging apparatus from damage by trucks, and for adequate ventilation for dispersal of fumes from gassing batteries.
- A conveyor, overhead hoist, or equivalent material handling equipment shall be provided for handling batteries.
- Reinstalled batteries shall be properly positioned and secured in the truck.
- A carboy tilter or siphon shall be provided for handling electrolyte.
- When charging batteries, acid shall be poured into water; water shall not be poured into acid.
- Trucks shall be properly positioned and brake applied before attempting to change or charge batteries.
- Care shall be taken to assure that vent caps are functioning. The battery (or compartment) cover(s) shall be open to dissipate heat.
- Smoking is prohibited in the charging area.
- Precautions shall be taken to prevent open flames, sparks, or electric arcs in battery charging areas.
- Tools and other metallic objects shall be kept away from the top of uncovered batteries.

Trucks and Railroad Cars

- The flooring of trucks, trailers, and railroad cars shall be checked for breaks and weakness before they are driven onto.
- The brakes of highway trucks shall be set and wheel chocks placed under the rear wheels to prevent the trucks from rolling while they are boarded with powered industrial trucks.
- Wheel stops or other recognized positive protection should be provided to prevent railroad cars from moving during loading or unloading operations.
- Fixed jacks may be necessary to support a semi-trailer and prevent upending during the loading or unloading when the trailer is not coupled to a tractor.
- Positive protection shall be provided to prevent railroad cars from being moved while dock boards or bridge plates are in position.

Operations

- If at any time a powered industrial truck is found to be in need of repair, defective, or in any way unsafe, the truck shall be taken out of service until it has been restored to safe operating condition.
- Trucks shall not be driven up to anyone standing in front of a bench or other fixed object.
- No person shall be allowed to stand or pass under the elevated portion of any truck, whether loaded or empty.
- Unauthorized personnel shall not be permitted to ride on powered industrial trucks.
- Arms or Legs shall not be placed between the uprights of the mast or outside the running lines of the truck.
- When a powered industrial truck is left unattended, load engaging means shall be fully lowered, controls shall be neutralized, power shall be shut off, and brakes set. Wheels shall be blocked if the truck is parked on an incline.
- A safe distance shall be maintained from the edge of ramps or platforms while on any elevated dock, or platform or freight car. Trucks shall not be used for opening or closing freight doors.
- There shall be sufficient headroom under overhead installations, lights, pipes, sprinkler system, etc.
- An overhead guard shall be used as protection against falling objects. It should be noted that an overhead guard is intended to offer protection from the impact of small packages, boxes, bagged material, etc., representative of the job application, but not to withstand the impact of a falling capacity load.
- A load backrest extension shall be used whenever necessary to minimize the possibility of the load or part of it from falling rearward.
- Trucks shall not be parked so as to block fire aisles, access to stairways, or fire equipment.

Traveling

- All traffic regulations shall be observed, including authorized speed limits. A safe distance shall be maintained approximately three truck lengths from the truck ahead, and the truck shall be kept under control at all times.
- The right of way shall be yielded to ambulances, fire trucks, or other vehicles in emergency situations.
- Other trucks traveling in the same direction at intersections, blind spots, or other dangerous locations shall not be passed.
- The driver shall be required to slow down and sound the horn at cross aisles and other locations where vision is obstructed. If the load being carried obstructs forward view, the driver shall be required to travel with the load trailing.
- Railroad tracks shall be crossed diagonally wherever possible. Parking closer than 8 feet from the center of railroad tracks is prohibited.
- The driver shall be required to look in the direction of, and keep a clear view of the path of travel.
- Grades shall be ascended or descended slowly. When ascending or descending grades in excess of 10 percent, loaded trucks shall be driven with the load upgrade. On all grades the load and load engaging means shall be tilted back if applicable, and raised only as far as necessary to clear the road surface.
- Under all travel conditions the truck shall be operated at a speed that will permit it to be brought to a stop in a safe manner.
- Stunt driving and horseplay shall not be permitted.
- The driver shall be required to slow down for wet and slippery floors.
- Dockboards or bridge plates shall be properly secured before they are driven over. Dock boards or bridge plates shall be driven over carefully and slowly and their rated capacity never exceeded.
- Running over loose objects on the roadway surface shall be avoided.
- While negotiating turns, speed shall be reduced to a safe level by means of turning the hand steering wheel in a smooth, sweeping motion. Except when maneuvering at a very low speed, the hand steering wheel shall be turned at a moderate, even rate.

Loading

- Only stable or safely arranged loads shall be handled. Caution shall be exercised when handling off-center loads that cannot be centered.
- Only loads within the rated capacity of the truck shall be handled.
- The long or high (including multiple-tiered) loads that may affect capacity shall be adjusted.
- Trucks equipped with attachments shall be operated as partially loaded trucks when not handling a load.
- A load engaging means shall be placed under the load as far as possible; the mast shall be carefully tilted backward to stabilize the load.

- Extreme care shall be used when tilting the load forward or backward, particularly when high tiering. Tilting forward with load engaging means elevated shall be prohibited except to pick up a load. An elevated load shall not be tilted forward except when the load is in a deposit position over a rack or stack. When stacking or tiering, only enough backward tilt to stabilize the load shall be used.

Fueling Safety

- Fuel tanks shall not be filled while the engine is running. Spillage shall be avoided.
- Spillage of oil or fuel shall be carefully washed away or completely evaporated and the fuel tank cap replaced before restarting engine.
- No truck shall be operated with a leak in the fuel system until the leak has been corrected.
- Open flames shall not be used for checking electrolyte level in storage batteries or gasoline level in fuel tanks.

Maintenance of Powered Industrial Trucks

- Any power-operated industrial truck not in safe operating condition shall be removed from service. All repairs shall be made by authorized personnel.
- Those repairs to the fuel and ignition systems of industrial trucks that involve fire hazards shall be conducted only in locations designated for such repairs.
- Trucks in need of repairs to the electrical system shall have the battery disconnected prior to such repairs.
- All parts of any such industrial truck requiring replacement shall be replaced only by parts equivalent as to safety with those used in the original design.
- Industrial trucks shall not be altered so that the relative positions of the various parts are different from what they were when originally received from the manufacturer, nor shall they be altered either by the addition of extra parts not provided by the manufacturer or by the elimination of any parts. Additional counter-weighting of fork trucks shall not be done unless approved by the truck manufacturer.
- Industrial trucks shall be examined before being placed in service, and shall not be placed in service if the examination shows any condition adversely affecting the safety of the vehicle. Such examination shall be made at least daily. Where industrial trucks are used on a round-the-clock basis, they shall be examined prior to use each shift. Defects when found shall be immediately reported and corrected.
- When the temperature of any part of any truck is found to be in excess of its normal operating temperature, thus creating a hazardous condition, the vehicle shall be removed from service and not returned to service until the cause for such overheating has been eliminated.
- Industrial trucks shall be kept in a clean condition, free of lint, excess oil, and grease. Noncombustible agents should be used for cleaning trucks. Low flash

point (below 100 deg. F.) solvents shall not be used. High flash point (at or above 100 deg. F.) solvents may be used.

Safe Operation Procedure for Charging LPG Tank

1. No Smoking.
2. Move LPG PIT outside for refueling.
3. Turn off PIT.
4. LPG tanks will be removed in the following order:
 - 1) Shut off service valve
 - 2) Disconnect tank from hose
 - 3) Unbuckle and remove tank from bracket
5. LPG tanks will be replaced in to following order:
 - 1) Place tank in bracket and re-buckle
 - 2) Reconnect hose to tank and tighten firmly
 - 3) Open valve slowly and assure proper seal

NOTE: Federal Law Prohibits dispensing an improper fuel type into any vehicle or into a non-approved fuel container.

In Case of LPG Leaks or Tank Rupture

1. DO NOT start or move the PIT.
2. If fuel hose is leaking, close valve immediately and place PIT "Out of Service" until repaired.
3. If tank ruptures, warn others, immediately leave the area (at least 50 feet) and notify Management. Do not re-enter the area until cleared by Management.

Powered Industrial Truck Pre-Use Checklist

A check of the following items (as applicable) is to be conducted by the operator prior to use each shift.

- Lights
- Horn
- Brakes
- Leaks
- Warning Beacon
- Backup Warning Alarm
- Fire Extinguisher

If any deficiencies are noted, the unit is to be placed OUT OF SERVICE until the problem has been corrected. Additionally, it is the operator's responsibility to notify the immediate supervisor and fill out a maintenance request.

3.9 Scaffold Safety

Please note that this program has a glossary. The glossary contains the definitions for various terms used in the program. These terms are highlighted in bold print the first time they appear in the body of the program.

Policy

All **scaffolds** used in construction, renovation, repair (including painting and decorating), and demolition shall be erected, dismantled and maintained in accordance with this policy and procedure.

Authority and Responsibility

Environmental Health and Safety Department is responsible for:

- Reviewing this policy to ensure compliance with current regulations;
- Reporting any questionable conditions that are discovered to the responsible department; and
- Ensuring all affected employees are trained in accordance with this policy.

CEE Departments is responsible for:

- Ensuring all affected employees follow the prescribed practices within this policy; and
- Designating a **qualified person** to design and supervise during the erection, use and disassembling of scaffolding; and
- Ensuring all inspection and maintenance practices for scaffolds are conducted by a **competent person** in accordance with this policy and procedure.

Employees affected by this policy are responsible for complying with the practices within the Scaffold Safety policy.

The *competent person* shall be responsible for:

- Directing employees who erect, dismantle, move or alter scaffolding;
- Determining if it is safe for employees to work from a scaffold during storms or high winds, and ensure that a personal fall arrest system is in place;
- Training employees involved in erecting, disassembling, moving, operating, repairing, maintaining, or inspecting scaffolding to recognize associated work hazards;
- Inspecting scaffolds and scaffold components for visible defects before each work shift, and after any occurrence which could affect the structural integrity, and to authorize prompt corrective action;
- Inspecting ropes on suspended scaffolds prior to each work shift and after every occurrence which could affect the structural integrity, and to authorize prompt corrective actions;
- For suspension scaffolds evaluating direct connections to support the load to be imposed;
- For erectors and dismantler's, determining the feasibility and safety of providing fall protection and access; and
- For scaffold components:
 - Determining if a scaffold will be structurally sound when intermixing components from different manufacturers'; and
 - Determining if galvanic action has affected the capacity when using components of dissimilar metals.

Qualified persons shall be responsible for:

- Designing and loading scaffolds in accordance with design specifications;
- Training employees working on the scaffolds to recognize the associated hazards and understand procedures to control or minimize those hazards; and
- For suspension scaffolds;
 - Designing platforms on two-point adjustable suspension types that are less than 36 inches wide to prevent instability;
 - Making swaged attachments and spliced eyes on wire suspension ropes; and
 - Designing components in accordance with design specifications.

General Requirements for Scaffolds

Capacity/Loads

A qualified person must design all scaffolding in accordance with the Occupational Safety and Health Administration (OSHA) 29 CFR 1926.451 "General Requirements for Scaffolds" and 29 CFR 1926.452 "Additional Requirements Applicable to Specific Types of Scaffolds".

Stationary scaffolds over 125 feet in height and rolling scaffolds over 60 feet in height shall be designed by a **professional engineer**. All equipment shall be inspected to see

that it is in good condition and is serviceable. Damaged or deteriorated equipment shall not be used.

All scaffolds and their components must support without failure its own weight and at least four times the maximum intended load applied or transmitted to the scaffold.

Platforms

Platforms shall be constructed as follows:

- Platforms shall be entirely planked and decked with space not more than one inch wide between the platforms and uprights;
- The platform shall not deflect more than 1/60 of the span when loaded;
- All platforms shall be kept clear of debris or other obstructions that may hinder the working clearance on the platform;
- Wood planks shall be inspected to see that there are graded for scaffold use, are sound and in good condition, straight grained, free from saw cuts, splits and holes;
- Platforms and walkways shall be at least 18 inches in width. When the work area is less than 18 inches wide, **guardrails** and/or personal fall arrest systems shall be used;
- Where platforms are overlapped to create a long platform, the overlap shall occur only over supports, and shall not be less than 12 inches unless the platforms are nailed;
- A platform greater than 10 feet in length shall not extend over its support more than 18 inches, unless it is designed and installed so that the cantilevered portion of the platform is able to support employees without tipping, or has guardrails which block employee access to the cantilevered end;
- Wood surface shall not be covered with opaque finishes, other than the edges for making identification;
- Platforms may be coated periodically with wood preservatives, fire-retardant finishes, and slip-resistant finishes; however, the coating shall not obscure the top or bottom wood surfaces; and
- Each end of the platform, unless cleated or otherwise restrained by hooks or equivalent means, shall extend over the centerline of its support at least six inches.

Scaffold components manufactured by different manufacturers shall not be intermixed unless the components fit together without force and the scaffold's structural integrity is maintained. Scaffold components made of dissimilar metals shall not be used together unless a competent person has determined that **galvanic action** will not reduce the strength of any component.

Guardrails

All scaffolds more than six feet above the lower level shall protect employees with guardrails on each open side of the scaffold. Guardrails shall be installed along the open

sides and ends before releasing the scaffold for use by the employees, other than erection or dismantling crews.

Guardrails are not required when:

- The front end of all platforms are less than 14 inches from the face of the work; and
- When employees are plastering and lathing 18 inches or less from the front edge.

Materials such as steel or plastic banding shall not be used for top rails or midrails.

Erection of Scaffolds

Prior to Erection – All Scaffold Assemblies

All jobsites and work areas shall be inspected prior to the erection of scaffolds to determine the site's ability to support structure, and for location of electric power lines, overhead obstructions, wind conditions, and the need for overhead protection or weather protection coverings.

Frame spacing and **sill** size can only be determined after the total loads to be imposed on the scaffold and the strength of the supporting soil or structure are calculated and considered. Special consideration is required when scaffolding is to be erected on fill, soft or frozen ground. Sills shall be level and in full contact with the supporting surface. A qualified person must do this analysis. Load carrying information on components is available from the scaffold manufacturer.

Wood planks used for **platforms** on scaffolding shall be specifically graded for scaffold use by an approved grading agency.

Erection of Fixed Scaffold

Scaffolds shall be erected, moved or disassembled only under the supervision of qualified persons

Base plates or **screw jacks** shall be in firm contact with both the sills and the legs of the scaffolding. Screw jacks with base plates shall be used to compensate for uneven ground. Do not use unstable objects such as loose bricks, blocks of wood or concrete to shore up the uneven surface.

All scaffolding shall be plumb and level. **Tying, guying, or bracing** may be needed to assure a safe and stable scaffold assembly. Do not force members to fit. Be sure scaffolding stays level and plumb as erection progresses. The height of the scaffold in relation to the minimum base width, wind loads, the use of brackets or cantilevered platforms and imposed scaffold load determines the need for stability bracing.

Access Requirements

Access shall be provided when scaffold platforms are more than 24 inches above or below the point of access. Direct access is acceptable when the scaffold is not more than 14 inches horizontally and not more than 24 inches vertically from the other surfaces. Cross braces shall not be used as a means of access.

Type of accesses, which are permitted:

- Portable ladders;
- Hook-on ladders;
- Attachable ladders
- Stairways;
- Stair towers;
- Ramps and walkways; or
- Integral prefabricated frames.

When erecting or dismantling supported scaffolds, a safe means of access shall be provided when a competent person has determined the feasibility and analyzed the site conditions.

Use Requirements

The use of **shore scaffolds** and **lean-to-scaffolds** is strictly prohibited. All employees are prohibited from working on scaffolds covered with snow, ice or other slippery materials.

Clearance Distances Between Scaffolds and Power lines

The following table provides the clearance distances between scaffolds and power lines, or any other conductive material, while being erected, used, dismantled, altered or moved.

<u>Insulated Lines</u> <u>Voltage</u>	<u>Minimum Distance</u>	<u>Alternatives</u>
Less than 300 volts 300 to 50 kv More than 50 kv	3 feet 10 feet 10 feet <i>General Rule: 0.4 inches for each 1 kv over 50 kv</i>	Two times the length of the line insulator, but never less than 10 feet
<u>Uninsulated Lines</u> <u>Voltage</u>	<u>Minimum Distance</u>	<u>Alternatives</u>
Less than 50 kv More than 50 kv	10 feet 10 feet plus <i>General Rule: 0.4 inches for each 1 kv over 50 kv</i>	Two times the length of the line insulator, but never less than 10 feet

EXCEPTION: Scaffolds and materials may be closer to power lines than specified where such clearance is necessary for performance of work and only after the utility company or electrical system operator has de-energized or relocated the lines.

Scaffold Requirements

The following are the requirements for specific types of scaffolds:

- Fabricated frame scaffolds (tubular welded frame scaffolds) - Appendix A;
- Form scaffolds and carpenter's bracket scaffolds - Appendix B;
- Pump jack scaffolds - Appendix C;
- Ladder jack scaffolds - Appendix D;
- Crawling boards (chicken ladders) - Appendix E;
- Two-point adjustable suspension scaffolds - Appendix F;
- Multi-level suspended scaffolds - Appendix G;
- Mobile scaffolds - Appendix H; and
- Aerial lifts - Appendix I.

Stilts

All employees using stilts shall:

- Wear the stilts on surfaces that are flat and free of holes, pits, and obstructions, such as debris or other tripping and falling hazards; and
- Properly maintain the stilts. The manufacturer must approve alterations to stilts.

Scaffolds Prohibited for Use

The following types of scaffolds are prohibited for use on University property:

- Window jack scaffolds;
- Catenary's scaffolds;
- Float scaffolds;
- Needle beam scaffolds;
- Pole scaffolds;
- Tube and coupler scaffolds;
- Plasterers, decorators and large area scaffolds;
- Horse scaffolds;
- Outrigger scaffolds;
- Interior hung scaffolds;
- Step, platform and trestle ladder scaffolds; and
- Single-point adjustable suspension scaffolds.

Fall Protection

All employees working on scaffolds six feet or more above ground/floor level shall use fall protection in accordance with the CEE Safety Manual Fall Protection Program, section 4.1.

All scaffolding shall have toe boards, screens, a guardrail system and/or debris nets as determined by a competent person.

Training

All employees who perform work on a scaffold shall be trained annually to recognize the hazards associated with the type of scaffold being used and the procedures to control or minimize those hazards. Employees shall be trained to demonstrate competency in the following areas:

- Nature of electrical, fall hazards and falling object hazards in the work area;
- Proper use of scaffolds;
- Proper handling of materials on scaffolds;
- Proper erecting, maintaining and disassembling of fall protection systems;
- Proper construction, use, placement and care in handling of scaffolds; and
- Maximum intended load and load-carrying capacities of scaffolds used.

3.10 Welding, Cutting and Brazing

Please note that this program has a glossary. The glossary contains the definitions for various terms used in the program. These terms are highlighted in bold print the first time they appear in the body of the program.

Policy

No **employee** of the University, contractor hired by the University or subcontractor hired by the contractor shall perform any **welding, cutting or brazing** unless a Hot Work Permit is obtained.

Authority and Responsibility

Environmental Health and Safety Department is responsible for:

1. Responding to requests for permits in a timely manner;
2. Reviewing the Welding, Cutting and Brazing policy to assure compliance; and
3. Assisting in training of affected employees.

Supervisors are responsible for:

1. Notifying all employees to the purpose and intent of the Welding, Cutting and Brazing policy;
2. Making periodic inspections of areas where the welding, cutting and brazing procedures are being used; and
3. Assuring that all employees are trained in the procedures.

Employees are responsible for complying with these procedures.

Contractors and sub-contractors are responsible for complying with these procedures.

**** THIS POLICY DOES NOT PERTAIN TO SOLDERING OPERATIONS ****

Procedure

Prior to starting a project that requires **hot work**, the supervisor for the welder or in certain cases the welder himself/herself shall obtain a Hot Work Permit from Facilities Services - Safety and Environmental Affairs.

The supervisor shall maintain copies of the permit on site for periodic review by a representative from Environmental Health and Safety as part of the annual fire/safety review.

Notification

To have a representative from Environmental Health and Safety issue a Hot Work Permit, contact the office at 543-7262 at least 24 hours prior to the start of the project.

Inspection

Prior to the issuance of the Hot Work Permit, a representative from Environmental Health and Safety or designee shall inspect the site to ensure that the operator is trained, the apparatus used for the work is operational, fire-fighting equipment is available and that the welder is protected.

Inspections shall be performed by using the checklist contained within the Hot Work Permit.

If the representative determines that the welder is not properly equipped for the project, or the project as proposed could jeopardize the health of the operator or others or create a fire condition, then a permit shall not be issued until all concerns are corrected.

Permit Posting

A permit shall be brought to the project site by a representative from Environmental Health and Safety. The form is in duplicate with the top copy going to Environmental Health and Safety and the second copy being secured to the welding, cutting or brazing apparatus.

Prohibitions

Welding, cutting or brazing shall not be permitted in the following areas until the conditions prohibiting "Hot Work" have been modified:

1. In the presence of explosive atmospheres, or in situations where explosive atmospheres may develop inside contaminated or improperly prepared tanks or equipment which previously contained flammable liquids;
2. In areas with an accumulation of combustible dust;

3. In areas near the storage of large quantities of exposed, readily ignitable materials such as combustibles;
4. On a container such as a barrel, drum or tank that contained materials that will emit toxic fumes when heated; and
5. In a confined space, until the space has been inspected and determined to be safe. Refer to the Confined Space Program policy, section 4.12 of the CEE Department Safety Manual.

Protective Equipment

The welder shall be equipped with the following protective devices and/or apparel as indicated on the permit or as listed below:

1. Portable and or mechanical ventilation capable of keeping the levels of fumes, dust and gases below the thresholds established in the Occupational Safety and Health Administration Permissible Exposure Limits found in Section 5.9, the Chemical Hygiene Plan, within this manual. If portable or mechanical ventilation is not available and fume, dust and gas generation is high, respirators shall be used;
2. Gloves, apron and/or jacket that are made of a material that is an insulator from heat and electricity;
3. Welders helmets equipped with proper filter plate and cover lenses;
4. Fire blanket;
5. Respiratory protection;
6. Screens to protect persons not properly protected from the visual effects of viewing arc welding or cutting and during gas or oxygen cutting or welding; and
7. Lifelines and harnesses for work in confined spaces (refer to the Confined Space Program, Section 4.12, within this Manual).

Storage of Equipment

Equipment and supplies shall be stored in a manner that will prevent the creation of hazardous conditions.

Education/Training

Employees shall be trained on all aspects of this policy.

Respirators

No employee shall be issued or required to use a respirator until that employee has satisfied the criteria set forth in the Respiratory Protection Program, Section 4.16.

Injuries/Exposures

If during the performance of assigned duties the welder becomes injured or suspects an occupational exposure occurred, then such situations shall be reported in accordance with the Incident Reporting and Investigation Program, Section 3.14.

Glossary

Brazing: A process in which one would solder with a nonferrous alloy that melts at a lower temperature than that of the metals being joined.

Cutting: A process used in dividing metal into individual pieces.

Employee: Any person hired by the University of Washington regardless of the person's job description (e.g., faculty, plant personnel, principle investigators, contractors and subcontractors hired by the contractors) that may be required to or have the need to perform welding, cutting and brazing.

Hot Work: Any welding, cutting or brazing that requires the use of electric or gas cutting equipment.

Welding: A process used to unite by heating and allowing the metals to flow together without previous heating.

3.11 Personal Protective Equipment

Policy

Personal protective equipment including those for eyes, face, head, and extremities, protective clothing, respiratory devices, protective shields and barriers shall be provided, utilized and maintained in a sanitary and reliable condition whenever deemed necessary by reason of hazards, processes or environment.

Scope

This policy applies to all employees who by nature of their job function have the potential to be exposed or come into contact with chemical, physical, radiological or biological hazards which by this exposure can cause illness, injury or impairment in the function of any part of the body.

Authority and Responsibility

Immediate Supervisors are responsible for:

1. Ensuring personal protective equipment is available and providing personal protective equipment as required or upon request to all employees; and
2. Ensuring personal protective equipment is being used by each affected employee during all job tasks, which require such protection.

Environmental Health and Safety and *Departmental Administration* are responsible for:

1. Assessing the workplace to determine if hazards are present, or are likely to be present, which necessitate the use of personal protective equipment;
2. Communicating selection decisions to each affected employee;

3. Selecting personal protective equipment that properly fits each affected employee; and
4. Documenting aforementioned hazard assessment components utilizing Appendix A - Personal Protective Equipment Assessment.

Employees are responsible for:

1. Wearing personal protective equipment upon the direction of their immediate supervisor; and
2. Participating in training.

Considerations

Personal protective equipment devices alone shall not be relied on to provide protection against hazards, but shall be used in conjunction with guards, engineering controls, administration controls and sound manufacturing practices.

When selecting personal protective equipment, utilize the following considerations as a basic directive.

- Application: What part of the body is being protected?
- Chemical Resistance: Will material maintain its structural integrity and protective qualities?
- Strength: Is the material resistant to punctures, tears, and abrasions?
- Flexibility: Do gloves provide the necessary dexterity?
- Thermal Limits: Does clothing maintain its mobility and protective capacity in temperature extremes?
- Cleanable: Can material be easily cleaned and reused?
- Longevity: Will clothing resist aging?

Contact Environmental Health and Safety at 543-7262 for personal protective equipment product recommendations.

Hand Protection

Hand protection shall be worn when hands are exposed to hazards such as those from skin absorption of harmful substances, severe cuts or lacerations, severe abrasions, punctures, chemical burns, thermal burns and harmful temperature extremes.

The type of hand protection used shall be based on the performance characteristics of the hand protection relative to the task(s) to be performed, conditions present, duration of use, and the hazards and potential hazards identified.

With respect to selection of gloves for protection against chemical hazards:

1. The toxic properties of the chemical(s) must be determined; in particular, the ability of the chemical to cause local effects on the skin and/or to pass through the skin and cause systemic effects;

2. Generally, any "chemical resistant" glove can be used for dry powders;
3. For mixtures and formulated products (unless specific test data are available), a glove shall be selected on the basis of the chemical component with the shortest breakthrough time, since it is possible for solvents to carry active ingredients through polymeric materials; and
4. Employees shall be able to remove the gloves in such a manner as to prevent skin contamination.

Head Protection

Head protection shall be worn in areas where there is a potential for injury to the head from impact, flying or falling objects (e.g., working below other workers who are using tools and materials which could fall through grates), or electrical shock and burns.

Helmets for protection against impact and penetration of falling objects shall comply with the "American National Standard for Personal Protection - Protective Headwear for Industrial Workers Requirements" (ANSI) Z89.1. Helmets for protection against electrical shock and burns shall comply with ANSI Z89.2-1971.

Eye/Face Protection

Suitable eye protection or face protection shall be worn when there is the potential for exposure to the eyes or face from flying particles, molten metal, liquid chemicals, acid or caustic liquids, chemical gases or vapors or potentially injurious light radiation. Side protection is required when there is a hazard potential from flying objects. Detachable side protectors (e.g., clip-on or slide-on shields) meeting the pertinent requirements are acceptable.

Eye protection shall be durable, comfortable and easy to clean. Persons whose vision requires the use of corrective lenses and whom by nature of their job duties require eye protection shall wear goggles or a full-face shield that can be worn over the prescription lenses.

There are four general classes of eye and face protection: safety glasses, face shields, goggles and welding helmets. The type of protection required shall be determined by the type and degree of the hazard and shall comply with ANSI Z87.1-1989 "American National Standard Practice for Occupational and Educational Eye and Face Protection".

Safety glasses shall be worn at all times in the following locations:

- Academic and research laboratories;
- Facilities Services Shops (e.g., welding, carpentry, automotive);
- All areas where airborne materials are present; and
- Clinics where invasive patient related tasks are conducted.

Foot Protection

Foot protection shall be worn when there is the potential for injury to the feet from falling or rolling objects, objects piercing the sole of the foot, electrical hazards, hot surfaces and slippery surfaces.

Foot protection shall comply with ANSI Z-1991 "American National Standard for Personal Protection - Protective Footwear".

Respirators

Use of respirators shall be done in accordance with the Respiratory Protection Program, section 4.16.

Body Protection

Full body protection shall be worn when there is a potential for contamination or exposure to other parts of the body (e.g., legs, arms, back, chest) from heat, splashes from hot metals and liquids, impacts, cuts, chemicals and radiation.

Body protection includes the following:

- Lab coats;
- Boot covers;
- Aprons;
- Bouffant caps;
- Tyvek suits; and
- Coveralls.

Electrical Protective Devices

Rubber insulating equipment shall be used/worn to protect employees from shocks/burns while working on "live" electrical systems.

Rubber insulating equipment shall comply with the following American Society for Testing and Materials (ASTM) standards:

- Specification for Rubber Insulating Gloves (D120-87s);
- Specification for Rubber Insulating Matting (ASTM D178-93 or D178-88);
- Specification for Rubber Insulating Blankets (ASTM D1048-93 or D1048-88a);
- Specification for Rubber Insulating Covers (ASTM D1049-93 or D1049-88);
- Specification for Rubber Insulating Line Hose (ASTM D1050-90); and
- Specification for Rubber Insulating Sleeves (ASTM D1051-87).

All electrical protective equipment shall be subjected to periodic electrical tests conducted in accordance with appropriate voltages identified by ASTM standards to reliably indicate whether the insulating equipment can withstand the voltage involved. Insulating equipment failing to pass inspections or electrical tests shall NOT be used by employees.

Rubber insulating equipment test intervals shall occur as follows:

- Rubber insulating line hoses shall be tested upon indication that the insulating valve is suspect;
- Rubber insulating covers shall be tested upon indication that the insulating valve is suspect;
- Rubber insulating blankets shall be tested before first issue and every twelve months thereafter;
- Rubber insulating gloves shall be tested before first issue and every six months thereafter; and
- Rubber insulating sleeves shall be tested before first issue and every twelve months thereafter.

Note: If the insulating equipment has been electrically tested but not issued for service, it shall not be placed into service unless it has been electrically tested within the previous twelve months.

All departments using rubber-insulating equipment shall make the appropriate arrangements for testing of such equipment.

Maintenance Schedules

Personal protective equipment shall be inspected, cleaned and maintained at regular intervals so that the personal protective equipment can be discarded, changed and/or decontaminated as deemed necessary. At a minimum, all personal protective equipment shall be discarded when it has become contaminated, worn, torn or has other integrity problems.

Personal protective equipment provides the requisite protection. It is important to ensure that contaminated personal protective equipment which cannot be decontaminated is disposed in a manner that protects employees from exposure to hazards.

Note: Inspect personal protective equipment before each use for tears, punctures, holes, cuts, cracks, embedded foreign objects and texture changes (e.g., swelling, softening, hardening, becoming sticky or inelastic).

Training

Initial Training

Initial training shall be provided by Facilities Services - Safety and Environmental Affairs or the appropriate department for each employee who is required to use personal protective equipment. This training shall utilize the "Personal Protective Equipment" training booklet generated by Facilities Services - Safety and Environmental Affairs, which shall be updated to ensure consistency with changes in protective equipment and work processes. Each employee shall be trained in at least the following:

- When personal protective equipment is necessary;
- What personal protective equipment is necessary;

- How to properly don, doff, adjust, and wear personal protective equipment;
- The limitations of the personal protective equipment; and
- The proper care, maintenance, useful life and disposal of the personal protective equipment.

Each affected employee shall demonstrate an understanding of the aforementioned training and the ability to use personal protective equipment properly before being allowed to perform work requiring the use of personal protective equipment.

Retraining

When there is reason to believe that any affected employee who has already been trained does not have the understanding and skill as required above, Facilities Services - Safety and Environmental Affairs or the affected department shall retrain each such employee. Circumstances where retraining is required include, but are not limited to, situations where:

- Changes in the workplace render previous training obsolete;
- Changes in the types of personal protective equipment to be used render previous training obsolete; or
- Inadequacies in an affected employee's knowledge or use of assigned personal protective equipment indicate that the employee has not retained the requisite understanding or skill.

Record keeping

Environmental Health and Safety shall verify that each affected employee has received and understood the required training through a written certification containing the name of each employee trained, the date(s) of training and the subject of the certification.

3.12 General safety requirements for compressed air

The following precautions pertain to the use of compressed air in machine shops:

1. All pipes, hoses, and fittings must have a rating of the maximum pressure of the compressor. Compressed air pipelines should be identified (psi) as to maximum working pressure.
2. Air supply shutoff valves should be located (as near as possible) at the point-of-operation.
3. Air hoses should be kept free of grease and oil to reduce the possibility of deterioration.
4. Hoses should not be strung across floors or aisles where they are liable to cause personnel to trip and fall. When possible, air supply hoses should be suspended overhead, or otherwise located to afford efficient access and protection against damage.
5. Hose ends must be secured to prevent whipping if an accidental cut or break occurs.

6. Pneumatic impact tools, such as riveting guns, should never be pointed at a person.
7. Before a pneumatic tool is disconnected (unless it has quick disconnect plugs), the air supply must be turned off at the control valve and the tool bled.
8. Compressed air must not be used under any circumstances to clean dirt and dust from clothing or off a person's skin. Shop air used for cleaning should be regulated to 15 psi unless equipped with diffuser nozzles to provide lesser pressure.
9. Personnel using compressed air for cleaning equipment must wear goggles, face shields or other eye protection.
10. Static electricity can be generated through the use of pneumatic tools. This type of equipment must be grounded or bonded if it is used where fuel, flammable vapors or explosive atmospheres are present.

Safety Requirements for Operating & Maintaining Compressed Air Machinery:

All components of compressed air systems should be inspected regularly by qualified and trained employees. Maintenance superintendents should check with state and/or insurance companies to determine if they require their own inspection of this equipment. Operators need to be aware of the following:

Air receivers:

The maximum allowable working pressures of air receivers should never be exceeded except when being tested. Only hydrostatically tested and approved tanks shall be used as air receivers.

1. Air tanks and receivers should be equipped with inspection openings, and tanks over 36 inches in diameter should have a manhole. Pipe lug openings should be provided on tanks with volumes of less than five cubic feet.
2. The intake and exhaust pipes of small tanks, similar to those used in garages should be made removable for interior inspections.
3. No tank or receiver should be altered or modified by unauthorized persons.
4. Air receivers should be fitted with a drain cock that is located at the bottom of the receiver.
5. Receivers should be drained frequently to prevent accumulation of liquid inside the unit. Receivers having automatic drain systems are exempt from this Requirement.
6. Air tanks should be located so that the entire outside surfaces can be easily inspected. Air tanks should not be buried or placed where they cannot be seen for frequent inspection.
7. Each air receiver shall be equipped with at least one pressure gauge and an ASME safety valve of the proper design.
8. A safety (spring loaded) release valve shall be installed to prevent the receiver from exceeding the maximum allowable working pressure.
9. Only qualified personnel should be permitted to repair air tanks, and all work must be done according to established safety standards.

Air Distribution Lines:

1. Air lines should be made of high quality materials, fitted with secure connections.
2. Only standard fittings should be used on air lines.
3. Operators should avoid bending or kinking air hoses.
4. Air hoses should not be placed where they will create tripping hazards.
5. Hoses should be checked to make sure they are properly connected to pipe outlets before use.
6. Air lines should be inspected frequently for defects, and any defective equipment repaired or replaced immediately.
7. Compressed air lines should be identified as to maximum working pressures (psi), by tagging or marking pipeline outlets.

Pressure regulation Devices:

1. Only qualified personnel should be allowed to repair or adjust pressure-regulating equipment.
2. Valves, gauges and other regulating devices should be installed on compressor equipment in such a way that cannot be made inoperative.
3. Air tank safety valves should be set no less than 15 psi or 10 percent (whichever is greater) above the operating pressure of the compressor but never higher than the maximum allowable working pressure of the air receiver.
4. Air lines between the compressor and receiver should usually not be equipped with stop valves. Where stop valves are necessary and authorized, ASME safety valves should be installed between the stop valves and the compressor.
5. The Safety valves should be set to blow at pressures slightly above those necessary to pop the receiver safety valves.
6. Blow off valves should be located on the equipment and shielded so sudden blow offs will not cause personnel injuries or equipment damage.
7. Case iron seat or disk safety valves should be ASME approved and stamped for intended service application.
8. If the design of a safety or a relief valve is such that liquid can collect on the discharge side of the disk, the valve should be equipped with a drain at the lowest point where liquid can collect.
9. Safety valves exposed to freezing temperatures should be located so water cannot collect in the valves. Frozen valves must be thawed and drained before operating the compressor.

Air Compressor Operation:

1. Only authorized and trained personnel should operate air compressor equipment.
2. The air intake should be from a clean, outside, fresh air source. Screens or filters can be used to clean the air.
3. Air compressors should never be operated at speeds faster than the manufacturers recommendation.
4. Equipment should not become overheated.

5. Moving parts, such as compressor flywheels, pulleys, and belts that could be hazardous should be effectively guarded.

Compressed Air Equipment Maintenance:

1. Only authorized and trained personnel should service and maintain air compressor equipment.
2. Exposed, non current-carrying, metal parts of compressor should be effectively grounded.
3. High flash point lubricants should not be used on compressors because of its high operating temperatures that could cause a fire or explosion.
4. Equipment should not be over lubricated.
5. Gasoline or diesel fuel powered compressors shall not be used indoors.
6. Equipment placed outside but near buildings should have the exhausts directed away from doors, windows and fresh air intakes.
7. Soapy water or lye solutions can be used to clean compressor parts of carbon deposits, but kerosene or other flammable substances should not be used. Frequent cleaning is necessary to keep compressors in good working condition.
8. The air systems should be completely purged after each cleaning.
9. During maintenance work, the switches of electrically operated compressors should be locked open and tagged to prevent accidental starting.
10. . Portable electric compressors should be disconnected from the power supply before performing maintenance.

Use of Compressed Air Sources

1. Compressed air has the appearance of a relatively harmless gas. However, to avoid accidents, compressed air must be used correctly. The improper or inadvertent connection of items not designed for shop air pressure, i.e., equipment, storage vessels, or containers, to a shop air supply may cause serious personal injury and more than likely will damage the item being connected.
2. The maximum air pressure approved for general use in the shops and laboratories is 30 psi (pounds per square inch). This pressure is sufficient for most shop and laboratory operations and is not significantly hazardous. Use discretion and good judgment when using compressed air, even at this low pressure.
3. The following rules and practices are suggested to avoid personal injury, equipment damage, and potential environmental impact:
 - a) All personnel assigned to shops with air compressors shall be familiar with compressor operating and maintenance instructions.
 - b) Compressed air is not to be used to blow dirt, chips, or dust from clothing.

- c) Air compressors shall be maintained strictly in accordance with the manufacturer's instructions.
- d) Do not use compressed air to transfer materials from containers when there is a possibility of exceeding the safe maximum allowable working pressure of the container.
- e) The maximum working pressure of compressed air lines shall be identified in psi. Pipeline outlets shall be tagged or marked showing maximum working pressure immediately adjacent to the outlet.
- f) Do not use compressed air to transfer materials from standard 55-gallon drums. Use a siphon with a bulk aspirator on a pump.

Warning

1. It is dangerous to pressurize any container not designed for that purpose.
2. Never use compressed air where particles can be accelerated by the air stream.
3. Do not use compressed air to clean machinery or parts unless absolutely necessary. Where possible, use a brush. If necessary, use a minimum pressure and provide barriers or clean the area of personnel. Wear goggles to protect your eyes.
4. Never apply compressed air to any part of a person's body.
5. Do not use a compressed air line that does not have a pressure regulator for reducing the line pressure.
6. Keep the hose length between tool housing and the air source as short as possible.
7. Where possible, attach a short length of light chain between the hose and the housing on air-operated tools. This keeps the hose from whipping should the hose-tool coupling separate.
8. Inspect air supply and tool hoses before using. Discard and label unfit hoses. Repair hoses where applicable.
9. Turn valve off and vent pressure from a line before connecting or disconnecting it. Never work on a pressurized line.
10. Do not connect air supply respirators or supplied-air suits to the compressed air supply system of any building. Such compressed air is unsafe to breathe.
11. Do not attach pneumatic tools, process, or control instruments to breathing airlines. The potential contamination to personnel and systems is hazardous.

3.13 Confined Space

Please note that this program has a glossary. The glossary contains the definitions for various terms used in the program. These terms are highlighted in bold print the first time they appear in the body of the program.

Policy

All **confined spaces** located at the University of Seattle shall be identified, investigated, and access shall be denied until the location has been cleared for **entry** in accordance with this policy.

Authority and Responsibility

Environmental Health and Safety Department is responsible for the following:

1. Investigating all known and suspected confined spaces;
2. Completing a confined space profile (Appendix A) for all confined spaces;
3. Designating confined spaces as **permit-required confined spaces** or **non-permit confined spaces**;
4. Implementing the measures necessary to prevent unauthorized entry into a permit-required confined space by posting warning signs or other equally effective means;
5. Determining if a permit-required confined space can be reclassified as a non-permit confined space;
6. Developing, implementing and annually reviewing the corporate policy for permit-required confined spaces;
7. Initially reviewing and approving all departmental policies for specific permit-required confined spaces prior to implementation;
8. Providing **entry supervisors** for all confined space entry procedures;
9. Providing a means of training employees involved with permit-required confined space entry; and
10. Coordinating with the department supervisor and contractor's entry supervisor to ensure proper procedures are followed prior to entry, during entry operations, and after entry into permit-required confined space(s).

Departments with authority over a permit-required confined space(s) are responsible for the following:

1. Developing and implementing departmental policies specific to each identified confined space;
2. Providing **authorized entrants** and **attendants** to perform assigned tasks in permit-required confined spaces;

3. Ensuring that affected employees participate in training programs as prescribed by this policy; and
4. Providing necessary equipment to control permit-required confined space atmospheres at levels that will permit occupancy.

The *contractor* shall be responsible for the following:

1. Utilizing any available information from the University of Washington regarding the permit-required confined space hazards and entry operations prior to entry;
2. Informing the University of Seattle of the permit-required confined space program to be followed by the contractor during the aforementioned initial meeting; and
3. If the contractor does not have an entry supervisor, a representative from Environmental Health and Safety Department shall assume the role of entry supervisor.

Employees are responsible for complying with University and departmental policies for permit-required confined spaces.

Profiling Confined Spaces

Notification

To report a known or suspected confined space, Environmental Health and Safety Department shall be contacted at 543-7262.

Response

To ensure that confined spaces are properly evaluated and designated as permit-required confined spaces or non-permit confined spaces, Environmental Health and Safety Department shall conduct a visual inspection of the area to determine if:

- The area is large enough and so configured that an employee can enter and perform assigned work;
- The area has limited or restricted means for entry or exit;
- The area is not designed for continuous employee occupancy;
- The space contains a material that has the potential for engulfing an entrant;
- The space has an internal configuration such that an entrant could be trapped or asphyxiated by inwardly converging walls or by a floor which slopes downward and tapers to a smaller cross-section; and
- The space contains any other recognized serious safety or health hazard which includes, but is not limited to:
 - Airborne dust;
 - Grinding/Mulching;
 - Agitators;
 - Other moving parts;
 - Steam;
 - Electrical hazards;
 - Falling/Tripping hazards;
 - Rodents/Snakes/Spiders; or

- Wind/Weather;
- Atmospheric monitoring to determine if the space contains or has the potential to contain a **hazardous atmosphere** according to the following procedure (Note: All atmospheric levels shall not exceed established permissible exposure limits and in the absence of permissible exposure limits, exposure levels shall fall below published guidelines as available in literature and reference materials such as material safety data sheets, threshold limit values, etc.);
- Environmental Health and Safety Department shall conduct initial monitoring of all confined spaces using a calibrated direct-reading device that measures oxygen, combustible gases and vapors, and toxic gases and vapors respectively;
- Monitoring in vertical confined spaces shall be done every two feet within the confined space beginning at the top of the confined space and gradually moving down using a sampling pump and attached polycarbonate wand which pulls air from the confined space into the monitoring device;
- Monitoring in horizontal confined spaces shall be done every two feet within the confined space beginning at the entrance of the confined space and gradually moving along the ceiling towards the opposite end and then gradually moving along the floor and back to the entrance using a sampling pump and attached polycarbonate wand which pulls air from the confined space into the monitoring device;
- If an initial entry of the permit space is necessary to obtain the required monitoring and inspection data, the entry shall be performed under the "General Requirements for Permit-Required Confined Spaces" section of this document (including the completion of a Confined Space **Entry Permit** (Appendix B) and the presence of an attendant);
- All initial monitoring results shall be documented on the confined space profile; and
- All confined space profiles shall be maintained by Environmental Health and Safety Department.

Upon completion of the aforementioned evaluation, Environmental Health and Safety Department shall designate each confined space as a permit-required confined space or non-permit required confined space and thus document the status of each space on the confined space profile.

Note: Activities such as chemical processes can result in a change in the atmosphere of a confined space. If these activities are to be performed within a confined space designated as a non-permit confined space, Environmental Health and Safety Department shall be contacted at 543-7262, Monday-Friday 8:00 a.m. - 4:30 p.m. or contact the "On-Call" Safety Officer by calling the University Police (before/after working hours, weekends, or holidays) for a re-evaluation of the space. Refer to the "Reclassifying Confined Spaces" section of this document.

Posting Hazard Warning Signs

If a permit-required confined space is located on University of Seattle property, Environmental Health and Safety Department shall inform employees of the existence of such a space by posting a warning sign, which reads:

DANGER
Permit-Required Confined Space
DO NOT ENTER

When posting of warning signs is not feasible (e.g., sewers, pits), as determined by Environmental Health and Safety Department, permit-required confined spaces shall be identified by other equally effective means (e.g., training).

Permit-Required Confined Spaces Requirements

General

Entry into a permit-required confined space is prohibited at any time until the appropriate visual evaluation and atmospheric monitoring of the space is performed by Environmental Health and Safety Office.

Notification

Environmental Health and Safety Department shall be contacted at 543-7262 at least the day prior to the anticipated entry into a permit-required confined space so that the appropriate visual evaluation and atmospheric monitoring of the space can be performed.

EXCEPTION: Environmental Health and Safety Department shall be notified immediately during an **emergency** situation involving the anticipated entry into a permit-required confined space to perform the appropriate evaluations of the space.

Response

1. The **entry supervisor** from Environmental Health and Safety Department shall perform a visual inspection of the permit-required confined space and document the general purpose of entry and nature of hazards within the permit-required confined space on the entry permit.
2. Environmental Health and Safety Department shall conduct pre-entry monitoring to determine if the space contains or has the potential to contain a hazardous atmosphere according to the following procedure (Note: All atmospheric levels shall not exceed established permissible exposure limits and in the absence of permissible exposure limits, exposure levels shall fall below published guidelines as available in literature and reference materials such as material safety data sheets, threshold limit values, etc.):
 - Environmental Health and Safety Department shall conduct pre-entry monitoring in all permit-required confined spaces using a calibrated direct-reading device that measures oxygen, combustible gases and vapors, and toxic gases and vapors respectively;

- Monitoring in vertical confined spaces shall be done every two feet within the confined space beginning at the top of the confined space and gradually moving down using a sampling pump and an attached polycarbonate wand which pulls air from the confined space into the monitoring device;
 - Monitoring in horizontal confined spaces shall be done every two feet within the confined space beginning at the entrance of the confined space and gradually moving along the ceiling towards the opposite end and then gradually moving along the floor and back to the entrance using a sampling pump and an attached polycarbonate wand which pulls air from the confined space into the monitoring device;
 - If an initial entry of the permit space is necessary to obtain the required monitoring and inspection data, the entry shall be performed under the "Permit-Required Confined Spaces Requirements" section of this document (including the completion of a Confined Space Entry Permit and the presence of an attendant); and
3. All pre-entry monitoring results shall be documented on the confined space permit.
 4. If the permit-required confined space is determined by Environmental Health and Safety Department as safe for entry, then a permit will be issued. If a permit is denied, a representative of Environmental Health and Safety Department will identify the measures to be taken in order for a permit to be awarded and entry into the permit-required confined space shall be prohibited until Environmental Health and Safety Department deems the space safe for entry and issues a permit. In some cases, Environmental Health and Safety Department may utilize alternate entry procedures (Appendix C).
 5. If an entry permit is awarded, Environmental Health and Safety Department shall complete and post the entry permit at the entry portal of the permit-required confined space.
 6. Only the assigned tasks or activities identified on the permit shall be conducted within the permit-required space and the duration of the permit may not exceed the time required to complete those assigned tasks or activities. If the assigned work goes beyond the planned time period or work tasks/activities other than those identified on the permit become necessary, the entrant shall leave the space and inform the supervisor of the expiration of the permit or of the newly proposed work tasks or activities. The department supervisor shall contact Environmental Health and Safety Department immediately for a re-evaluation of the space in regard to the proposed work task or activity.
 7. The entry supervisor shall supervise the entry team's implementation of the means, procedures, and practices necessary for safe entry operations which include, but are not limited to, the following:
 - Isolating the permit space by **blanking** or blinding; misaligning or removing sections of lines, pipes, or ducts; using a **double block and bleed** system; using lockout or tagout procedures; or blocking or disconnecting all mechanical linkages;

- Purging, **inerting**, flushing, or ventilating the permit-required confined space as necessary to eliminate or control atmospheric hazards; and
 - Providing pedestrian, vehicle, or other barriers (i.e., barricades or tape) to protect entrants from external hazards whenever a permit-required space is entered.
8. If necessary as determined by pre-entry evaluation of a permit-required space, employees will be appropriately equipped with the following:
- Mechanical ventilation;
 - Safe means of communications;
 - Personal Protective Equipment;
 - Lighting;
 - Barriers;
 - Equipment (e.g., ladder) for safe entry/exit by entrants; and
 - External **retrieval systems**.

Retrieval equipment shall be provided by Environmental Health and Safety Department unless it is determined that the equipment would increase the overall risk of injury upon entry or would not contribute to the possible rescue of an entrant (e.g., internal configurations of the permit-required space). The Entry Supervisor for a permit-required confined space shall ensure the following retrieval systems or methods are in place before entry:

1. A chest or full body harness, with a retrieval line attached to the center of the entrant's back, near shoulder level or above the head; and
2. The other end of the retrieval line shall be attached to a mechanical device or fixed point outside the permit space. *Note:* A mechanical device must be available to retrieve personnel from a vertical permit- required confined space, which is five feet or more in depth.

Reclassifying Confined Spaces

Non-Permit Confined Space

Environmental Health and Safety Department shall be contacted at 543-7262 for a re-evaluation of the space and, if necessary, reclassification.

All signage on permit-required confined spaces, which are reclassified to non-permit confined spaces, shall be removed.

If Environmental Health and Safety Department reclassifies a space, this shall be documented on the Confined Space Profile under the "Status" section and the date of reclassification shall be identified.

Conditions that may cause the reclassification of confined space or a permit-required confined space are as follows:

1. Conditions employees should be aware of include a change in work activities which could result in a change in the atmosphere (e.g., chemical usage), contents of the space begin to re-enter or any other hazards; and
2. If while employees are working within a permit-required confined space and the conditions change, employees should exit the space immediately and contact Environmental Health and Safety Department Office for a re-evaluation of the space.

Termination of Work

Individual departments shall contact the entry supervisor to terminate entry and cancel the permit when the work covered by the entry permit has been completed and/or a condition that is not allowed under the entry permit arises in or near the space.

Contractors

If an outside contractor is hired to perform work within a permit-required confined space at the University of Seattle, the department supervisor shall contact Environmental Health and Safety Department 72 hours prior to beginning the work.

The entry supervisor from Environmental Health and Safety Department and the department supervisor shall coordinate entry operations with the entry supervisor of the outside contractor when employees from the University and the Contractor will be working together in or near permit-required confined space(s).

The entry supervisor from Environmental Health and Safety Department and the department supervisor shall be responsible for the following:

1. Informing the contractor that the area in question is a permit-required confined space;
2. Reviewing the permit-required confined space program followed by the contractor;
3. Informing the contractor of the hazards identified within the space and any past experience with the space;
4. Informing the contractor of any precautions or procedures that have been implemented for the protection of employees in the permit-required confined space where contractor personnel will be working; and
5. Debriefing the contractor at the end of the work to identify hazards discovered or created in the permit-required confined space during operations.

Rescue and Emergency Services

The Seattle Fire Department shall perform permit-required confined space rescue in accordance with 29 CFR 1910.146 (k) (1).

If in the course of his/her duties outside a permit-required confined space an attendant becomes aware that an entrant needs assistance in escaping from the space, the attendant shall summon rescue and other emergency services and begin non-entry rescue procedures by pulling up the retrieval line attached to the entrant. Attendants shall never enter the space to attempt a rescue and shall always remain outside the permit-required confined space during entry operations until relieved by another attendant.

The entry supervisor shall inform the Seattle Fire Department of the hazards they may confront when called upon to perform a permit-required confined space rescue.

Training

Requirements

Environmental Health and Safety Department shall be responsible for providing appropriate training. This training is provided to each employee serving as authorized entrant, attendant, and entry supervisor during any type of confined space operation. The purpose of this training is to equip the individual with an understanding, knowledge and the skills necessary for the safe entry into a permit-required confined space.

Curriculum

All employees serving as authorized entrants, attendants, or entry supervisors shall be trained to understand the following:

1. What is a confined space, non-permit confined space and permit-required confined space;
2. When a permit-required confined space may be re-classified and procedures for declassification;
3. How to obtain and/or cancel a permit in order to enter a permit- required confined space;
4. The hazards that may be faced during entry including information on the mode of exposure, signs or symptoms, and consequences of exposure;
5. Equipment and methodologies used to determine if safe entry into a permit-required confined space is possible;
6. How to recognize warning signs or symptoms of exposure to a dangerous situation;
7. The importance of communication between the entrant and attendant including methods used to continuously maintain an accurate count of authorized entrants within the permit-required confined space, the methods of communication to determine entrant status and when to alert the attendant;
8. How to properly use personal protective equipment and any other applicable equipment including: ventilating equipment, communication equipment, lighting equipment, barriers and shields, ingress/egress equipment, rescue and emergency equipment used for non-entry and any other equipment necessary for safe entry into and rescue from permit spaces;
9. How and when to evacuate a permit-required confined space. All entrants should exit from a permit required confined space as quickly as possible whenever:
 - An order to evacuate is given by the attendant or the entry supervisor;

- The entrant recognizes any warning signs or symptoms of exposure to a dangerous situation; and
 - The entrant detects a **prohibited condition**;
10. Methods used to monitor the activities inside and outside the space to determine if it is safe for entrants to remain in the space;
 11. Methods used to summon rescue and other emergency services; and
 12. Methods used to handle unauthorized persons who approach or attempt to enter a permit-required confined space. These methods include the following:
 - Warn the unauthorized persons that they must stay away from the permit space;
 - Advise the unauthorized persons that they must exit immediately if they have entered the permit space; and
 - Inform the authorized entrants and the entry supervisor that unauthorized persons have entered the permit space by contacting Environmental Health and Safety Department at 543-7262 or contact the "On-Call" Safety Officer through the University Police, after work hours, weekends and holidays.

Frequency

Training shall be provided as follows:

1. Before an employee is assigned to a duty involving entry into a permit- required confined space;
2. Before there is a change in assigned duties (e.g., attendant becomes an entrant);
3. Whenever there is a change in confined space operations that presents a hazard that an employee has not been previously trained on; or
4. Whenever there are deviations from the entry procedures or inadequacies in the employee's knowledge or use of entry procedures as identified by the Environmental Health and Safety Department during entry procedures.

Record keeping

Training programs shall establish employee proficiency in the duties required of authorized entrants, attendants, and entry supervisors. Training programs and records shall be maintained by Environmental Health and Safety Department for three years subsequent to the initial training period and will include the following:

1. Dates of the training sessions;
2. Contents or summary of the training sessions;
3. Names and qualifications of persons conducting the training;
4. Names and job titles of all persons attending the training sessions; and
5. Results of the learning measurement exercise.

Glossary

Agitator: A device or apparatus for stirring or shaking.

Attendant: An individual stationed outside one or more permit-required confined spaces that monitors the authorized entrants and performs assigned attendant duties.

Authorized Entrant: An employee who is authorized by the employer to enter a permit-required confined space.

Confined Space: A space that:

- Is large enough and so configured that an employee can bodily enter and perform assigned work;
- Has limited or restricted means for entry or exit (e.g., tanks, vessels, silos, storage bins, hoppers, vaults, and pits); and
- Is not designed for continuous employee occupancy.

Blanking (Blinding): The absolute closure of a pipe, line, or duct by the fastening of a solid plate that completely covers the bore and is capable of withstanding the maximum pressure of the contents within the pipe, line, or duct with no leakage beyond the plate.

Emergency: Any occurrence or event internal or external to the permit-required confined space that could endanger entrants.

Entry: The action by which a person passes through an opening into a permit-required confined space. Entry is considered to have occurred as soon as any part of the entrant's body breaks the plane of an opening into the space.

Entry Permit (Permit): The written or printed document that is provided by the employer to allow and control entry into a permit-required confined space.

Entry Supervisor: A representative from Environmental Health and Safety Department who shall be responsible for the following: determining if acceptable entry conditions are present at a permit-required confined space where entry is planned; authorizing entry; overseeing entry operations; and terminating entry as required.

Grinding: To wear down, polish, or sharpen by friction.

Hazardous Atmosphere: An atmosphere that may expose employees to the risk of death, incapacitation, impairment or acute illness from one or more of the following causes:

- Flammable gas, vapor, or mist in excess of ten percent of its lower flammable limit;

- Airborne combustible dust at a concentration that meets or exceeds its lower flammable limit (dust obscures vision at a distance of five feet or less);
- Atmospheric oxygen concentration below 19.5 percent or above 23.5 percent;
- Atmospheric concentration of any substance for which a dose or a permissible exposure limit is published and which could result in employee exposure in excess of its dose or permissible exposure limit; and/or
- Any other atmospheric condition that is immediately dangerous to life or health.

Inerting: The displacement of the atmosphere in a permit-required confined space by a non-combustible gas (e.g., nitrogen) to such an extent that the resulting atmosphere is non-combustible.

Non-Permit Confined Space: A confined space that does not contain or, with respect to atmospheric hazards, have the potential to contain any hazard capable of causing death or serious physical harm.

Permit-Required Confined Space (Permit Space): A confined space that has one or more of the following characteristics:

- Contains or has a potential to contain a hazardous atmosphere (e.g., dependent upon work activities - cleaning with solvents, using degreasers);
- Contains a material that has the potential for engulfing an entrant;
- Has an internal configuration such that an entrant could be trapped or asphyxiated by inwardly converging walls or by a floor which slopes downward and tapers to a smaller cross-section; or
- Contains any other recognized serious safety or health hazard (i.e., excessive noise levels, moving parts, electrical hazards, fall/trip hazards).

Prohibited Condition: Any condition in a permit-required confined space that is not allowed by the permit during the period when entry is authorized.

Retrieval System: The equipment used for non-entry rescue of persons from permit-required confined spaces.

3.14 Temperature Stairways, Ladders and Portable Ladders

Please note that this program has a glossary. The glossary contains the definitions for various terms used in the program. These terms are highlighted in bold print the first time they appear in the body of the program.

Policy

All **temporary stairways, ladders** and portable ladders used in construction, renovation, repair (including painting and decorating) and demolition shall be constructed, erected and used in accordance with this policy.

Exception: This policy does not apply to ladders, which are specifically manufactured for scaffold access and egress and stairways not used by University employees for theatrical performances.

Authority and Responsibility

Environmental Health and Safety Department is responsible for:

- Reviewing this policy to assure compliance with current regulations;
- Reporting any questionable conditions that are discovered to the responsible department; and
- Ensuring all affected employees are trained in accordance with this policy.

Department affected by this policy are responsible for:

- Ensuring all affected employees follow the prescribed practices within this policy; and
- Ensuring all inspection and maintenance practices for stairs and ladders are followed in accordance with this policy.

Employees affected by this policy are responsible for complying with the practices within the Temporary Stairway, Ladder and Portable Ladder policy.

Egress and Access Requirements

All work areas shall meet the requirements for egress and access. Whenever a worker's **point of access** is broken in elevation by 19 inches or more and no ramp, egress, embankment or personal hoist is provided, a stairway or ladder shall be provided.

When there is only one point of access or egress between levels, this shall remain clear from obstruction to permit free passage by workers. If the passage becomes obstructed, then a second point of access or egress shall be provided and used. Where there are more than one point of access or egress between levels, at least one point shall be kept clear.

Stairways

All stairways used during the process of construction, renovation or repair, which are not part of the **permanent structure**, shall be constructed in accordance with the following:

- Landings at least 30 inches deep and 22 inches wide at every 12 feet or less of vertical rise;
- Stairways shall be installed at an angle of not less than 30 degrees and no more than 50 degrees horizontally.
- Variations in **riser height** or **stair tread** depth shall not exceed 1/4 inch in any stairway system, including any foundation structure used as one or more treads of the stair;
- When doors or gates open directly onto a stairway, a **platform** that extends at least 20 inches beyond the swing of the door shall be provided;
- When metal pan landings and metal pan treads are used, they shall be secured in place before filling;
- The stairway shall be free from all dangerous projections;
- Slippery conditions on stairways shall be corrected; and
- Spiral stairways are prohibited, unless they are part of the permanent structure.
- Except during construction of the actual stairway, stairways with metal pan landings and treads shall not be used where the treads and/or landings have not been filled in with concrete or other materials, unless the pans of the stairs and/or landings are temporarily filled in with wood or other materials;
- All treads and landings shall be replaced when worn below the top edge of the pan;
- Except during the construction of the actual stairway, skeleton metal frame structures and steps shall not be used (where treads and/or landings will be installed later) unless the stairs are filled with secured temporary treads and landings; and
- Temporary treads shall be made of wood or other solid materials and installed the full width and depth of the stair.

Stair rails and Handrails

Handrails are required on stairways having four or more risers, or rising more than 30 inches in heights, whichever is less. A **stair rail** shall be installed along each unprotected side or edge. When the top edge of a stair rail system also serves as a handrail, the height of the top edge shall be no more than 37 inches nor less than 30 inches from the upper surface of the stair rail to the surface of the tread, as shown in Figure 3.16A. When required, stair rails and **midrails** shall be constructed as follows:

- On winding or spiral stairways, a handrail shall be provided where the tread width is less than six inches;
- Midrails, screens, mesh, intermediate vertical members or equivalent intermediate structural members shall be provided between the top rail and stairway steps to the stair rail system;
- Midrails, when used, shall be located midway between the top of the stairway step and along the opening between top rail supports;

- Intermediate vertical members, such as balusters, when used, shall not be more than 19 inches apart;
- Other intermediate structural members, when used, shall be installed so that there are no openings of more than 19 inches wide;
- Handrails and the top rails of stair rail systems shall be able to withstand, without failure, at least 200 pounds of weight applied within two inches of the top edge in any downward or outward direction, at any point along the top edge;
- The height of handrails shall not be more than 37 inches nor less than 30 inches from the upper surface of the handrail to the surface of the tread;
- Stair rail systems and handrails shall be smooth surfaced to prevent injuries such as punctures or lacerations and to keep clothing from snagging;
- Handrails shall provide adequate handhold for employees to grasp to prevent falls;
- Temporary handrails shall have a minimum clearance of three inches between the handrail and walls, stair rail systems and other objects; and
- Unprotected sides and edges of stairway landings shall be provided with standard 42-inch guardrail system.

Ladders

All ladders constructed on site, including job-made ladders, shall meet the following requirements:

- A **double-cleated ladder** or two or more ladders shall be provided when ladders are the only way to enter or exit a work area having 25 or more employees, or when a ladder serves simultaneous two-way traffic;
- Ladder **rungs, cleats** and steps shall be parallel, level and uniformly spaced when the ladder is in position for use;
- Rungs, cleats and steps of portable and fixed ladders shall not be spaced less than ten inches apart, nor more than 14 inches apart, along the ladder's side rails;
- Rungs, cleats and steps of step stools shall not be less than eight inches apart, nor more than 12 inches apart, between center lines of the rungs, cleats and steps;
- Ladders shall not be tied or fastened together to create longer sections unless they are specifically designed for such use;
- A metal spreader or locking device shall be provided on each step ladder to hold the front and back sections in an open position when the ladder is being used;
- When splicing side rails, the resulting side rail shall be equivalent in strength to a one-piece side rail made of the same material;
- Two or more separate ladders used to reach an elevated work area shall be offset with a platform or landing between the ladders, except when portable ladders are used to gain access to fixed ladders;
- Ladder components shall be smooth surfaced to prevent injury from punctures or lacerations and prevent snagging of clothing; and
- Wood ladders shall not be coated with any opaque covering, except for identification or warning labels, which may be placed only on one face of a side rail.

Portable Ladders

- Non-self supporting and self-supporting portable ladders shall support at least four times the maximum intended load;
- Extra heavy duty type 1A metal or plastic ladders shall sustain 3.3 times the maximum intended load;
- The maximum clear distance between side rails for all portable ladders shall be 11.5 inches; and
- The rungs of portable metal ladders shall be corrugated, knurled, dimpled, coated with skid-resistant material or treated to minimize slipping.

Fixed Ladders

- A **fixed ladder** shall be able to support at least two loads of 250 pounds each, concentrated between any two consecutive attachments;
- Individual rung/step ladders shall extend at least 42 inches above an access level or landing platform either by the continuation of the rung spacing as horizontal grab bars or by providing vertical grab bars that shall have the same lateral spacing as the vertical legs of the ladder rails;
- Each step or rung of a fixed ladder shall be able to support a load of at least 250 pounds applied in the middle of the step or rung;
- The minimum clear distance between the sides of individual rung or step ladders and between the side rails of other fixed ladders shall be 16 inches;
- The rungs and steps of fixed metal ladders shall be corrugated, knurled, dimpled, coated with skid-resistant material or treated to minimize slipping;
- The minimum perpendicular clearance between fixed ladder rungs, cleats and any obstruction behind the ladders shall be seven inches, except that the clearance for an elevator pit ladder shall be four and one-half inches;
- The minimum perpendicular clearance between the centerline of fixed ladder rungs, cleats and steps and any obstruction on the climbing side of the ladder shall be 30 inches. If obstructions are unavoidable, clearance may be reduced to 24 inches, provided a deflection device is installed to guide workers around the obstruction;
- The step-across distance between the center of the steps and rungs of fixed ladders and the nearest edge of a landing area shall be no less than seven inches and no more than 12 inches. A landing platform shall be provided if the step-across distance exceeds 12 inches;
- Fixed ladders without cages or wells shall have at least a 15 inch clearance width to the nearest permanent object on each side of the centerline of the ladder;
- Steps or rungs for through-fixed ladder extensions shall be omitted from the extension and the extension of side rails shall be flared to provide between 24 and 30 inches clearance between side rails; and
- When safety devices are provided, the maximum clearance distance between side rail extensions shall not exceed 36 inches.

Safety Practices When Using Ladders

When using ladders, whether they are fixed or portable, there are several safety practices that shall be followed before and during use.

- When portable ladders are used for access to an upper landing surface, the side rails shall extend at least three feet above the upper landing surface. When such an extension is not possible, the ladder shall be secured and a grasping device such as a grab rail shall be provided to assist workers in mounting and dismounting the ladder;
- Ladders shall be maintained free of oil, grease and other slipping hazards;
- Ladders shall not be loaded beyond the maximum intended load as identified on the specification label found on the side rail of the ladder;
- Ladders shall only be used for the purpose for which they were designed;
- Non-self supporting ladders shall be used at an angle where the horizontal distance from the top support to the foot of the ladders is approximately one quarter of the working length of the ladder, as shown in Figure 3.16B. Wood job-made ladders with spliced side rails shall be used at an angle where the horizontal distance is one-eighth the working length of the ladder;
- Fixed ladders shall be used at a pitch no greater than 90 degrees from the horizontal measured from the backside of the ladder;
- Ladders shall be used only on stable and level surfaces unless secured to prevent accidental movement;
- Ladders shall not be used on slippery surfaces unless secured or provided with slip-resistant feet to prevent accidental movement. Slip-resistant feet shall not be used as a substitute for the care in placing, lashing or holding a ladder upon slippery surfaces;
- Ladders placed in areas such as passageways, doorways, driveways, or where they can be displaced by workplace activities or traffic shall be secured to prevent accidental movement or a barricade shall be used to keep traffic or activities away from the ladder;
- The area around the top and bottom of the ladders shall be kept clear;
- The top of a non-self supporting ladders shall be placed with two rails supported equally unless it is equipped with a single support attachment;
- Ladders shall not be moved, shifted or extended while in use;
- Ladders shall have nonconductive side rails if they are used where the worker or the ladder could contact exposed energized electrical equipment;
- The top or top step of a stepladders shall not be used as a step;
- Cross bracing on the rear section of stepladders shall not be used for climbing unless the ladders are designed and provided with steps for climbing on both front and rear sections;
- Single-rail ladders shall not be used;
- When ascending or descending a ladder, the workers shall face the ladder; and
- A worker on a ladder shall not carry any object or load that could cause him/her to lose balance and fall.

Cages, Wells and Safety Devices for Fixed Ladders

Fixed ladders shall be provided with cages, wells, ladder safety devices or self-retracting lifelines where the length of climb is less than 24 feet but the top of the ladder is at a distance greater than 24 feet above lower levels.

Cages for Fixed Ladders

- Horizontal bands shall be fastened to the side of rail ladders or directly to the structure, building or equipment for individual rung ladders;
- Vertical bars shall be on the inside of the horizontal bands and be fastened to them;
- **Cages** shall not extend less than 27 inches or more than 30 inches from the centerline of the step or rung and shall not be less than 27 inches wide;
- The inside of the cage shall be clear of projections;
- Horizontal bands shall be spaced at intervals not more than four feet apart measured from centerline to centerline;
- Vertical bars shall be spaced at intervals not more than 9.5 inches measured centerline to centerline;
- The bottom of the cage shall be between seven and eight feet above the point of access to the bottom of the ladder. The bottom of the cage shall be flared not less than four inches between the bottom horizontal band and the next higher band; and
- The top of the cage shall be a minimum of 42 inches above the top of the platform or the point of access at the top of the ladder. Provisions shall be made for access to the platform or other point of access.

Wells for Fixed Ladders

- **Wells** shall completely encircle the ladder;
- Wells shall be free of projections;
- The inside face of the well on the climbing side of the ladder shall extend between 27 and 30 inches from the centerline of the step or rung;
- The inside width of the well shall be at least 30 inches; and
- The bottom of the well above the point of access to the bottom of the ladders shall be between seven and eight feet.

Ladder Safety devices and Related Support Systems for Fixed Ladders

- All **safety devices** shall be able to withstand, without failure, a drop test consisting of a 500 pound weight dropping 18 inches;
- All safety devices shall permit the worker to ascend or descend without continually having got hold, push or pull any part of the device leaving both hands free for climbing;
- All safety devices shall be activated within two feet after a fall occurs and limit the descending velocity of an employee to seven feet per second or less; and

- The connection between the carrier or lifeline and the point of attachment to the body belt or harness shall not exceed nine inches in length.

Mounting Ladder Safety Devices for Fixed Ladders

- Mounting for rigid carriers shall be attached at each end of the carrier, with intermediate mounting, spaced along the entire length of the carrier, to provide the necessary strength to stop worker falls;
- Mountings for flexible carriers shall be attached at each end of the carrier. Cable guides for flexible carriers shall be installed with a spacing between 25 and 40 feet along the entire length of the carrier to prevent wind damage to the system;
- The design and installation of mounting and cable guides shall not reduce the strength of the ladder; and
- Side rails and steps or rungs for side-step fixed ladders shall be continuous in extension.

Inspection

Ladders shall be inspected by a department supervisor or designee for visible defects on a semi-annual basis and after any incident that could affect their safe use. The person performing the inspection shall use the Appendix A - Ladder Inspection Checklist. The department shall forward a copy to Environmental Health and Safety Department and maintain a copy of the report their records.

Portable ladders with structural defects such as broken or missing rungs, cleats, or steps, broken or split rails, corroded components, or other faulty or defective components shall immediately be marked defective or tagged with “Do Not Use”, and withdrawn from service until repaired. Fixed ladders with structural defects such as broken or missing rungs, cleats or steps, broken or split rails, or corroded components shall be withdrawn from service until repaired.

Defective fixed ladders are considered withdrawn from use immediately when they are:

1. Tagged with “Do Not Use” or similar language;
2. Marked in a manner that identifies them as defective;
3. Blocked such as with a plywood attachment that spans several rungs.

A contractor or company who will certify that the portable or fixed ladder meets original specifications shall complete all repairs of the ladder before the ladder is returned to use.

Training

All employees using or constructing ladders and stairways shall be trained annually to recognize hazards related to ladders and stairways and to use proper procedures to minimize these hazards. Employees shall be trained to demonstrate competency in the following areas:

- The nature of fall hazards in the work area;

- The correct procedures for erecting, maintaining and disassembling the fall protection systems to be used;
- The proper construction, use, placement and care in handling of all stairways and ladders; and
- The maximum intended load-carrying capacities of ladders used.

3.15 Chemical Storage

This program contains requirements for practices designed and implemented to protect University employees, students, visitors and the environment from the risks of hazardous chemicals that are stored on University property.

Scope

This program is applicable to all University students, faculty and staff that are required by the nature of their job to handle hazardous chemicals.

Definitions

Flammable chemicals - Solid, liquid or gaseous chemicals that readily catch fire and burn in the presence of oxygen.

CLASSIFICATION TERM FLASH POINT TEMPERATURE

Flammable Liquid Class I Below 100°F (37.8°C)

Flammable Liquid Class I A Below 73°F (22.8°C) and Boiling Point below 100°F (37.8°C)

Flammable Liquid Class I B Below 73°F (22.8°C) and Boiling Point at or above 100°F (37.8°C)

Flammable Liquid Class I C Below 100°F (37.8°C) and Boiling Point at or above 73°F (22.8°C)

Combustible chemicals - Solid, liquid or gaseous materials that burn in the presence of oxygen.

CLASSIFICATION TERM FLASH POINT TEMPERATURE

Combustible Liquid Class II Below 140°F (60°C) or at or above 100°F (37.8°C)

Combustible Liquid Class III At or above 140°F (60°C)

Combustible Liquid Class III A Below 200°F (93.4°C) or at or above 140°F (60°C)

Combustible Liquid Class III B At or above 200°F (93.4°C)

NOTE: Ignitable liquids, regulated as wastes by the Environmental Protection Agency (EPA) under the Resource Conservation and Recovery Act, include Class I flammable liquids and Class II combustible liquids.

Corrosive chemicals - Any solid, liquid or gaseous chemicals that burn, irritate or destructively attack organic tissues, most commonly the skin.

Material Safety Data Sheet (MSDS) - Written or printed material prepared by the manufacturer of a hazardous chemical that contains information about the hazards of the chemical and the appropriate work practices required for use.

NFPA-approved - Approved by the National Fire Protection Association.

Oxidizing chemicals - Any solid, liquid or gaseous chemicals that may cause or enhance the combustion of other materials or readily react to oxidize combustible materials, generally by yielding oxygen or some other oxidizing gas.

Pyrophoric chemicals - Any liquid or solid chemicals that will ignite spontaneously in air below 130°F (54.4°C).

Reactive chemicals - Any solid, liquid or gaseous chemicals that react violently with water, or are normally unstable and readily undergo violent changes without detonating, or form potentially explosive mixtures with water, or generate toxic gases when mixed with water or corrosive chemicals, or are capable of detonation or an explosive reaction.

Toxic chemicals - Any solid, liquid or gaseous chemicals that can cause damage to living tissue, impairment of the central nervous system, severe illness or in extreme cases, death when ingested, inhaled or absorbed by the skin.

General Storage Requirements for All Chemicals

1. Label all chemical containers appropriately. If transferring chemicals out of their original container to another container or if the original container label is illegible, follow the chemical labeling guidelines as detailed within this Manual - Hazard Communication, Section 5.8.
2. Be knowledgeable of the procedures contained in EH&S's Chemical Spill Response Program to prepare yourself and others in the event that any chemical container leaks or is spilled.
3. Follow all precautions regarding the storage of incompatible chemicals. Consult the label and Material Safety Data Sheet (MSDS) for each chemical to ensure that you are familiar with the chemical and how it should be handled, stored and disposed. **Separate all chemicals into compatible groups and store alphabetically within stored groups.**
4. Provide a definite storage place for each chemical and return the chemical to that same location after each use.

5. Avoid storing chemicals in laboratory fume hoods or on bench tops, except for those chemicals intended to be used by the end of the day.
6. Store volatile toxic chemicals and odorous chemicals in a ventilated cabinet, if possible. The cabinet's associated electrical components must be explosion-proof if flammable materials are being ventilated. If located in a laboratory, locate the cabinet near the fume hood. Store other chemicals inside a closable cabinet or on a shelf that has a lip to prevent containers from sliding off in the event of a fire or other serious accident.
7. Do not expose stored chemicals to heat, direct sunlight or freezing conditions.
8. Store all containers of liquids on compatible plastic trays that are capable of holding the contents of the container if it leaks, or at least 10% of the total volume stored within the tray. Store liquids on lower shelves, if possible.
9. Seal all chemical containers well to minimize the escape of flammable, corrosive, irritating or toxic vapors or gases.
10. Ventilation is required for chemicals that may release dangerous or damaging quantities of vapors or gases, which may be flammable, corrosive, irritating or toxic.
11. For every chemical storage area, there should be evacuation and emergency procedures to be followed and fire extinguishers available in the case of personal exposure or a leak, spill or fire within the room.

Storage Requirements for Flammable and Combustible Chemicals

1. The storage area should be separated and protected so that a fire or spill in the storage area is not likely to spread beyond the storage area.
2. If containers of flammable and combustible liquids are larger than five (5) gallons in size, special provisions are necessary to prevent liquid from flowing out of the storage area in the event of a spill or leak. Contact EH&S at 543-7262 for further details.
3. When possible, store quantities of flammable liquids greater than one (1) gallon in NFPA-approved safety cans. Store all flammable liquids and solids in NFPA-approved storage cabinets. EH&S will provide these cabinets to you at no cost.
4. Do not store flammable chemicals in any refrigerator unless it has been designed for that purpose. Ordinary refrigerators contain spark sources that can ignite flammable vapors. If refrigerated storage is needed inside of a flammable storage room, an explosion-proof refrigerator must be used. Use chemical storage refrigerators only for storing chemicals, never food or drink. Label these refrigerators with the following signage:

NO FOOD OR DRINK TO BE STORED IN THIS REFRIGERATOR

5. Maximum Container Sizes for Flammable and Combustible Liquids

The following container sizes, **in liters**, are the maximum allowable unless otherwise specified:

Flammable Liquids Combustible Liquids

Quantity for Storage, Liters

Container	Class IA	Class IB	Class IC	Class II	Class IIIA
Glass	0.5	1	4	4	4
Metal or approved Plastic	4	20	20	20	20
Safety Cans	7.5	0	20	20	20

NOTE: Glass containers as large as one (1) gallon can be used, if needed, and if the required purity would be adversely affected by storage in a metal or approved plastic container, or if the liquid would cause excessive corrosion or degradation of a metal or approved plastic container.

6. Storage Limits for Flammable and Combustible Liquids

The following limits apply to all Class B Occupancies with sprinkler systems and is the maximum allowable. Contact EH&S for clarification if you have questions.

Liquid Class Flash Point (°F) Amount Allowable (per 100 sq. ft.)

Class I Flammable Below 100° 4 gallons

Class II Combustible 100° - 139° 4 gallons

Class IIIA Combustible 140° - 200° 12 gallons

Class IIIB Combustible Above 200° Unlimited

7. Safety Equipment for Storage of Flammable Liquids

Safety Cans: Safety cans are containers that have built-in safety features for protecting flammable liquids from exposure to a fire situation. In a fire situation, a safety can is exposed to extremely high temperatures. This heat is transmitted to the contents, which in turn boil and produce a large vapor pressure. Every safety can is fitted with a spring-loaded cap that vents these vapors safely without bursting the can. The other safety feature of a safety can is the flame arrestor that consists of a cylindrical wire screen. Vapors emitted from a safety can will ignite when exposed to the flames of a fire. Since flames usually flash back to the source of liquid, the flame arrestor serves as a heat dissipater. The temperature in the space above the liquids in a safety can is lowered below the ignition temperature and ignition of the contents is eliminated.

Flammable Liquid Storage Cabinets: Flammable liquid storage cabinets are designed to maintain the temperature at the top of the cabinet interior below 325°F when subjected to a 10-minute fire test. Cabinets built to withstand the temperature rating during the 10-minute fire test are acceptable by OSHA standards if: (a) the maximum capacity of Class I and II liquids is not more than 60 gallons (or more than 120 gallons for Class II liquids); and (b) the cabinet is labeled with conspicuous lettering, such as Flammable-Keep Fire Away. All storage cabinets must have self-closing doors that will close the latch automatically when released. These doors must not be blocked open.

Special Refrigerators: Special refrigerators that can safely store flammable liquids have a spark-free interior such that all wiring and thermostat controls have been removed from the interior. Two types of these refrigerators are commercially available: a "flammable liquid storage" model and an "explosion-proof" model. A "flammable liquid storage" model is normally used in a non-explosive area where no flammable vapors are present. Such a refrigerator is normally powered through a standard three-wire cord plugged into an electrical outlet. An "explosion-proof" refrigerator is required when the area in which the refrigerator will be located has the potential for ignition of flammable vapors. An explosion-proof refrigerator is supplied with a "pigtail" cord that must be wired directly to a power source using metal conduit as specified by local electrical codes. Choosing the appropriate refrigerator will depend on the area in which it will be located.

8. **Flammable and Combustible Liquid Storage Rooms**

- a) Large quantities of liquids that need to be stored in specially designed storage rooms include those with flash point temperatures at or below 200°F (93.4°C) and include all liquids identified as flammable liquids, ignitable liquids or combustible liquids in Class II or IIIA.
- b) An inside storage room that does not exceed 150 sq. ft. in floor area is permitted to contain up to two (2) gallons per sq. ft. of floor area within the room, if the room is separated from the building by construction having at least one (1) hour fire resistance, and all openings between the room and the building are protected by assemblies having a one (1) hour fire-resistance rating. If it is desirable to increase the allowable storage capacity of such a room, the capacity can be increased to five (5) gallons per sq. ft. by providing the room with an automatic fire extinguishing system.
- c) An inside storage room needs to be ventilated to prevent possible accumulation of flammable concentrations of vapors from container leaks and spills. Recommended ventilation is from floor level with a capacity of one (1) cubic foot per minute of exhaust for each square foot of floor area in the room, with a minimum exhaust of 150 cubic foot per minute.
- d) If there is dispensing in the room, there should be provisions for ventilating the dispensing operation close to the points at which vapors are being emitted.

- e) If storage room containers of flammable and combustible liquids are larger than five (5) gallons in size, it is necessary to provide barriers to prevent spills in the room from migrating outside the room. If these containers hold Class I or Class II liquids, curbs or ramps are needed as barriers.
- f) Wiring and electrical fixtures located inside storage rooms must be suitable for the hazards. Explosion-proof (National Electric Code Class I, Division 2) electrical equipment is required for prevention of explosions if large quantities of flammable liquids (Class I) are being stored or dispensed. If only combustible liquids are being stored or dispensed, general use wire is acceptable.
- g) If an inside storage room has an exterior wall, it is classified by the NFPA flammable and combustible liquids code as a "cut-off room" for which there are two additional requirements: (a) Exterior walls are required to provide ready accessibility for fire fighting; and (b) if Class IA or Class IB liquids are dispensed or if Class IA liquids are stored in containers larger than one (1) gallon, the exterior wall or roof is required by the NFPA to be designed to provide explosion venting.
- h) There is no need for explosion venting in a small room used only for storage or in a room used for dispensing if adequate ventilation is provided.

E. STORAGE REQUIREMENTS FOR REACTIVE CHEMICALS

1. Consider the storage requirements of each reactive chemical prior to purchasing.
2. Consult the label and MSDS in making decisions about storage of reactive chemicals.
3. Use and store only the quantities of material you will need for immediate use.
4. Cyanides and sulfides should be stored in a location separate from acids or protected from contact with acids.
5. All acids should be stored separately from all alkaline materials (bases).
6. Date all highly reactive materials as soon as received and make sure the label states:

DANGER! HIGHLY REACTIVE MATERIAL

1. Do not open a container of highly reactive material that is past its expiration date. Call EH&S at 543-7262 for assistance.
2. Dispose of highly reactive material through EH&S prior to the expiration date.
3. Segregate the following materials:
 - a) Oxidizing agents from reducing agents and combustibles
 - b) Powerful reducing agents from readily reducible substrates
 - c) Pyrophoric compounds from flammables
 - d) Perchloric acid from reducing agents and combustibles

10. Store reactive liquids in trays constructed of compatible materials, which are large enough to contain the contents of the bottles. Store perchloric acid bottles in glass or ceramic trays.
11. Store materials that react vigorously with water away from any possible contact with water. If chemicals are to be stored that are reactive if exposed to the air or water, they can safely be stored in sprinkle red areas where sprinkler discharge would serve to prevent rupture of the outer container.
12. Temperature control or refrigeration must be provided, as needed, for chemicals that deteriorate or react if their temperatures exceed safe limits recommended by the manufacturer or person synthesizing the chemical. Store thermally unstable materials in a refrigerator with the following safety features: all spark-producing controls are on the outside, a magnetic locked door, an alarm to warn when the temperature is too high.
13. Assign responsibility for the storage areas utilized for highly reactive materials to one (1) primary person and a backup person. Review this responsibility at least twice yearly.
14. Some highly reactive shock/heat sensitive materials are:
 - Ammonium perchlorate Dibenzoyl peroxide
 - Ammonium permanganate Diisopropyl peroxydicarbonate
 - Anhydrous perchloric acid Dinitrobenzene (ortho)
 - Butyl hydroperoxide Ethyl methyl ketone peroxide
 - Butyl perbenzoate Ethyl nitrate
 - *t*-Butyl peroxyacetate Hydroxylamine
 - *t*-Butyl peroxyvalate Peroxyacetic acid
 - 1-Chloro-2, 4-dinitrobenzene Picric acid (<10% water content)
 - Cumene hydroperoxide Trinitrobenzene
 - Diacetyl peroxide Trinitrotoluene

Storage Requirements for Oxidizers

Oxidizing agents such as chlorates, perchlorates, peroxides, nitric acid, nitrates, nitrites and permanganates represent a significant hazard because of their propensity under certain conditions to undergo vigorous reactions when they come into contact with easily oxidized material such as metal powders and organic materials like wood, paper and other combustible material. Mineral acids such as perchloric acid, sulfuric acid and nitric acid, as well as other oxidizers, should be stored separate from flammables and combustibles, by separate rooms, cabinets or break resistant containers. If large bottles must be stored in proximity of combustible materials, acid resistant trays must be used to prevent the oxidation of wood or corrosion of metal shelves.

1. Class I Oxidizer

Class I oxidizers will cause an increase of the burning rate of combustible material with which it comes in contact. Some examples are:

Hydrogen peroxide (8-28%) Magnesium perchlorate

Nitric acid (70% or less) Silver nitrate

Perchloric acid solutions (less than 60% wt/wt)

2. Class II Oxidizer

Class II oxidizers will cause an increase of the burning rate or may cause spontaneous ignition of combustible material with which it comes in contact.

Some examples are:

Calcium hypochlorite (50% or less wt/wt) Chromic acid

Hydrogen peroxide (28-52% wt/wt) Sodium peroxide

Contact EH&S if quantities are stored in excess of 1,000 lbs.

3. Class III Oxidizers

Class III oxidizers will cause a severe increase in the burning rate of combustible material with which they come in contact, or will undergo vigorous self-sustained decomposition when catalyzed or exposed to heat. Regulated quantities are permitted to be stored only on the ground floor of a building with no basement. Some examples are:

Ammonium dichromate Perchloric acid solutions (60-73%)

Hydrogen peroxide (52-91% wt/wt) Sodium chlorate

Contact EH&S if quantities are stored in excess of 200 lbs.

4. Class IV Oxidizer

Class IV oxidizers can undergo an explosive reaction when catalyzed or exposed to heat, shock, or friction. Regulated quantities are permitted to be stored only in detached storage. Storage areas for Class IV oxidizers must be provided with a means to vent fumes in any type of emergency. Some examples are:

Ammonium perchlorate Perchloric acid solutions

Ammonium permanganate (greater than 72.5%)

Hydrogen peroxide (greater than 91% wt/wt) Potassium super oxide

Contact EH&S if quantities are stored in excess of 10 lbs.

Storage Requirements for Toxic Chemicals

1. Store chemicals known to be highly toxic, including carcinogens, in ventilated storage in unbreakable, chemically resistant secondary containers.

Keep quantities on hand at an absolute minimum.

Label storage areas with appropriate warning signs, such as:

CAUTION! REPRODUCTIVE TOXIN STORAGE

-or-

CAUTION! CANCER-SUSPECT AGENT STORAGE

and limit access to these areas.

2. Storage areas for pesticides and other toxic chemicals should be secured when the storage areas are not supervised by a responsible person so that unauthorized personnel are kept out.

Storage Requirements for Peroxidizable Chemicals

1. Some chemicals can form significant quantities of unstable peroxides after prolonged exposure to air and light. Certain peroxides may detonate with extreme violence when they become concentrated by evaporation or distillation, when combined with other compounds to yield a detonable mixture or when simply disturbed by unusual heat, shock or friction.

The following is a representative list of those compounds, which form peroxides:

PEROXIDE HAZARD IN STORAGE. These compounds form peroxides that may explode even without being concentrated

- Isopropyl ether Divinyl ether Potassium metal
- Potassium amide Sodium amide (sodamide) Vinylidene chloride

2. ***PEROXIDE HAZARD ON CONCENTRATION.*** These compounds may form peroxides as a result of distillation or most likely evaporation.

Dioxane Ethyl ether

Tetrahydrofuran Acetal

Cumene Cyclohexane

Dicyclopentadiene Diacetylene

Furan Ethylene glycol dimethyl ether

Methylcyclopentane Methyl acetylene

Tetrahydronaphthalene Vinyl ethers

3. **HAZARDS DUE TO PEROXIDE INITIATION OF POLYMERIZATION.**

When stored as a liquid, the peroxide forming potential increases and certain of these monomers, especially butadiene, chloroprene and tetrafluoroethylene, should be considered as a peroxide hazard in storage.

Butadiene Chlorobutadiene (Chloroprene) Vinyl pyridine

Chlorotrifluoroethylene Styrene

Tetrafluoroethylene Vinyl acetate

Vinyl acetylene Vinyl chloride

Storage and handling procedures:

Each person responsible for a laboratory must develop and maintain an inventory of the peroxidizable materials in the laboratory. The inventory should be reviewed every three (3) months, at which time samples from List I, three (3) months or older, and List II and List III samples twelve (12) months or older would either be tested for peroxides or disposed of through EH&S. Quantities of peroxidizable compounds should be purchased according to short-term needs to ensure that peroxide buildup, which may accompany long-term storage, is minimized. Purchase in container sizes corresponding to use requirements to minimize exposure to air from multiple openings of the container.

4. Use the following labeling formats for all peroxide-forming liquids:

<p style="text-align: center;">List I Peroxidizable Compound</p> <p>Date received Date opened _____</p> <p>Dispose of or test within 3 months after opening!</p> <p>Disposal Date _____</p> <p>Contact EH&S at 543-7262 for disposal.</p>
--

List II/III Peroxidizable Compound

Date received Date opened _____

Discard or test within 12 months after opening!

Disposal Date _____

Contact EH&S at 543-7262 for disposal.

All peroxidizable compounds should be stored away from heat and light. Sunlight is an especially good promoter of peroxidation. Protection from physical damage and ignition sources during storage is also essential. Particular care should be given to ensure tight closure on storage containers. Loose or leaky closures may permit evaporation of storage material, leaving a hazardous concentration of peroxides in the container. Most common container materials, such as steel, stainless steel, copper, nickel, aluminum, baked phenolic linings and ceramics, are suitable for containers; however, they must be clean and free of metal oxides because iron or copper oxides may actually promote peroxide formation.

The use of oxidation inhibitors is especially important in the safe handling of peroxidizable materials. Hydroquinone, alkyl phenols, aromatic amines or similar materials are recommended by the manufacturers as being effective in preventing peroxide formation during storage. Compounds that are suspected of having very high peroxide levels because of visual observation of unusual viscosity or crystal formation or because of age should be considered extremely dangerous. The precautions taken for disposal of these materials should be the same as for any material that can be detonated by friction or shock. **IT IS OF THE UTMOST IMPORTANCE THAT THE CONTAINER NOT BE OPENED.** The act of opening the container **COULD DETONATE PEROXIDE CRYSTALS** under the container cap or other closure. Peroxidization in a chemical process may not only be a serious hazard because of the explosion potential, but also may affect lower yield and produce unwanted impurities.

I. CHEMICAL INCOMPATIBILITY CHART

NUMBER CHEMICAL GROUP DO NOT STORE WITH GROUP

NUMBERS

- 1. Inorganic Acids 2-8, 10, 11, 13, 14, 16-19, 21-23**
- 2. Organic Acids 1, 3, 4, 7, 14, 16-19, 22**
- 3. Caustics 1, 2, 5, 7, 8, 13-18, 20, 22, 23**

4. Amines and alkanolamines 1, 2, 5, 7, 8, 13-18, 23
5. Halogenated compounds 1, 3, 4, 11, 14, 17
6. Alcohols, glycols, glycol ethers 1, 7, 14, 16, 20, 23
7. Aldehydes 1-4, 6, 8, 15-17, 19, 20, 23
8. Ketones 1, 3, 4, 7, 19, 20
9. Saturated hydrocarbons 20
10. Aromatic hydrocarbons 1, 20
11. Olefins 1, 5, 20
12. Petroleum oils 20
13. Esters 1, 3, 4, 19, 20
14. Monomers, polymerizable esters 1-6, 15, 16, 19-21, 23
15. Phenols 3, 4, 7, 14, 16, 19, 20
16. Alkylene oxides 1-4, 6, 7, 14, 15, 17-19, 23
17. Cyanohydrins 1-5, 7, 16, 19, 23
18. Nitriles 1-4, 16, 23
19. Ammonia 1-2, 7, 8, 13-17, 20, 23
20. Halogens 3, 6-15, 19, 21, 22
21. Ethers 1, 14, 20
22. Elemental phosphorus 1-3, 20
23. Acid anhydrides 1, 3, 4, 6, 7, 14, 16-19

J. CHEMICAL COMPATIBILITY CHART

RELATED AND COMPATIBLE STORAGE GROUPS

ORGANIC FAMILY

Acids, anhydrides, peracids

Alcohols, glycols, amines, amides, imines, imides

Hydrocarbons, esters, aldehydes

Ethers, ketones, ketenes, halogenated hydrocarbons, ethylene oxide

Epoxy compounds, isocyanates

Peroxides, hydroperoxides, azides

Sulfides, polysulfides, sulfoxides, nitrites

Phenols, cresols

INORGANIC FAMILY

Metals, hydrides

Halides, sulfates, sulfites, thiosulfates, phosphates, halogens

Amides, nitrates (except ammonium nitrates, azides)

Hydroxides, oxides, silicates, carbonates, carbon

Sulfides, selenides, phosphides, carbides, nitrides

Chlorates, perchlorates, perchloric acid, chlorites, hypochlorites, peroxides, hydrogen peroxide

Arsenates, cyanides, cyanates

Borates, chromates, manganates, permanganates

Nitric acid, other inorganic acids

Sulfur, phosphorus, arsenic, phosphorus pentoxide

3.16 Chemical Fume Hoods

Policy

Department of Environmental Health and Safety shall assist with certifying and maintaining all chemical and horizontal/vertical laminar flow hoods and provide assistance in purchasing and system design of new hoods. Refer to Section 6.5 for biological safety cabinet requirements and procedures.

Fume Hood Requirements

Velocity Requirements

A standardized face velocity for hoods has not been established, but a common recommendation has been in place for over 25 years. The recommended face velocities used at the University of Chicago are listed based on the type of materials used within the hood.

Minimum Face Velocity Based on Material Used:

- Low Toxicity Levels 100 feet per minute (fpm);
- Average Level Toxins 100 fpm;
- Low level radioactive tracer materials with normal toxic hazards 100 fpm;
- Significant chemical toxicity levels and moderate radioactive materials 100 fpm; and
- Higher levels of toxicity and highly radioactive materials 100 fpm.

Hoods shall ventilate by a dedicated exhaust fan with ducts leading directly from the hood to the roof. Horizontal ducts shall be pitched down to prevent accumulations of vapors in low spots. Duct velocities shall be maintained high enough to minimize the trapping of vapors in the exhaust system. Terminal exhaust points shall be located at least 25 feet from any possible air intake (e.g., air intake grills, doors, operable windows) and positioned at a height that allows adequate dispersion of fumes.

General Information

A newly installed or modified hood exhausting vapors from a continuing process that is left unattended shall have an air flow switch connected to a visible and audible warning device.

Appropriate safeguards shall be provided for flammable and explosive agents vented through the hood (e.g., explosion-proof motors and control, scrubber units, biohazard filters).

NOTE: The use of perchloric acid is prohibited unless the hood has been designed for its specific use and manipulation.

Certification

All fume hoods shall be inspected and certified annually to determine a proper face velocity of 100 fpm. The airflow into and within the hood shall not be excessively

turbulent (200 fpm). These hoods shall be checked by representatives from Facilities Services - Safety and Environmental Affairs on an annual basis during laboratory reviews. All hoods functioning properly shall have a certification label affixed to the sash height at which the hood was certified.

Hood Usage

When using a fume hood, the following considerations shall apply:

1. Fume hoods shall not be used to store chemicals or other materials;
2. Avoid potential exposures by not putting any part of your body with the exception of hands and forearms into the hood;
3. During manipulation and operation within the hood, sashes shall be kept at or below the certification sticker height to ensure proper air flow and protection of the use;
4. Filters shall be maintained as recommended by the manufacturer;
5. If any hood is suspected of not operating properly, discontinue use of the hood and contact Department of Environmental Health and Safety at 543-6991 to arrange for testing of the hood(s);
6. Do not use hoods, which have not been certified. To have a hood certified, contact Department of Environmental Health and Safety;
7. If the hood is covered with materials to protect light sensitive substances, then an opening not less than that which can be considered safe for operation shall be maintained; and
8. Hoods equipped with automatic alarms shall be inspected by the user more frequently than once per year and the frequency of this testing should be based on hood usage.

Inspection Process

A two-step process shall be used when inspecting a hood to validate proper working condition.

Step 1. Inspection of Hood

A complete inspection both inside and outside the hood shall be performed by the inspector evaluating the following:

1. Use of proper materials designed for that hood;
2. Excessive storage of any materials inside hood;
3. Physical damage to the hood;
4. Items that should not be inside the hood;
5. The ability of the sash to open, close and stay in a stationary position; and
6. Proper function of the hood flow indicator and alarm, if present.

Step 2. Determination of the Hood's Face Velocity

The face velocity of the hood shall be determined by using a velocity meter or other approved device using the low setting or low probe setting. The fume hood must first be emptied to facilitate access.

When using a velocity meter to determine face velocity, the unit shall be placed at a nine-point schematic in order to determine the average flow rate of the hood.

This shall be done with the sash in its fullest raised position. (Refer to diagram 1.1 below.)

Diagram 1.1

1 2 3
4 5 6
7 8 9

If the hood fails to meet the required face velocity with the sash open to its fullest position, the sash shall be lowered and the hood re-tested. This process shall be performed until the hood meets the required feet per minute rating.

Note: The sash cannot be lowered to a point less than 12 inches from the base of the sash opening.

Once inspection is completed, a certification sticker indicating the date of inspection and face velocity in feet per minute shall be placed at the point the sash was adjusted to reach certification.

If a hood fails certification, a warning sign shall be placed at a prominent location on the sash of the hood.

This sign shall **ONLY** be removed by Environmental Health and Safety once the hood has passed certification requirements.

3.17 Respiratory Protection

Please note that this program has a glossary. The glossary contains the definitions for various terms used in the program. These terms are highlighted in bold print the first time they appear in the body of the program.

Permissible Practice

In the control of those occupational diseases caused by breathing air contaminated with harmful dusts, fogs, fumes, mists, gases, smokes, sprays or vapors, the primary objective shall be to prevent atmospheric contamination. This shall be accomplished as far as feasible by accepted engineering control measures (e.g., enclosure or confinement of the

operation, general and local ventilation) or administrative control measures (e.g., substitution of less toxic materials). When effective engineering and/or administrative controls are not feasible, or while they are being instituted, appropriate respirators shall be provided and used pursuant with this policy when such equipment is necessary to protect the health of the employee.

Authority and Responsibility

Environmental Health and Safety Department is responsible for:

1. Acting as the administrator of the Respiratory Protection Program;
2. Validating the need for respiratory protection devices;
3. Determining the adequate level of protection and identifying the appropriate cartridges necessary for the task;
4. Ensuring employees are physically able to perform the work and use the respirator by obtaining medical clearance from a **physician**;
5. Providing training in the proper use and care of the respiratory protection devices;
6. Conducting all **fit testing**;
7. Maintaining all medical clearance forms and fit test records; and
8. Conducting a program evaluation.

Departments are responsible for:

1. Contacting Environmental Health and Safety Department to have a hazard assessment conducted to validate the need of respiratory protection devices;
2. Funding the medical screening portion of the program;
3. Purchasing and maintaining an inventory of respiratory protection devices and cartridges;
4. Making arrangements for employee training and fit testing with Environmental Health and Safety Department; and
5. Ensuring employees are wearing respiratory protection devices in conjunction with the requirements of this policy (e.g., no facial hair).

Employees are responsible for:

1. Completing the mandatory medical questionnaire and any medical evaluation requirements deemed necessary by the evaluating physician;
2. Wearing respiratory protection devices in conjunction with all requirements of this policy (e.g., no facial hair);
3. Attending annual respirator training and fit testing; and
4. Maintaining, cleaning and inspecting respiratory protection devices in accordance with this policy.

Volunteer Use of Respirators

Where respirator use is not required, respirators shall be provided at the request of employees or employees shall be permitted to use their own respirators provided Environmental Health and Safety Department determines that such respirator use will not

in itself create a hazard. If Environmental Health and Safety Department determines that voluntary respirator use is permissible, a copy of "Appendix A - Voluntary Respirator Use Information" shall be provided to the employee.

Each employee using a respirator voluntarily shall still meet the medical criteria of this policy to ensure he/she is medically able to use the respirator. The employee shall also follow all cleaning, storage and maintenance requirements in this policy to ensure that the respirator use does not present a health hazard to the user.

Exception: This does not apply to the voluntary use of **filtering face pieces (dust masks)**.

Respirator Selection

Environmental Health and Safety Department shall identify and evaluate respiratory hazard(s) in the workplace. This evaluation shall include a reasonable estimate of **employee exposures** to respiratory hazard(s) and an identification of the contaminant's chemical state and physical form. Where employee exposure cannot be identified or reasonably estimated, the atmosphere shall be considered to be **immediately dangerous to life and health (IDLH)**.

Environmental Health and Safety Department shall recommend an appropriate National Institute for Occupational Safety and Health (NIOSH) certified respirator based on the respiratory hazard(s) to which the worker is exposed and workplace and user factors that affect respirator performance and reliability. The respirator shall be adequate to protect the health of the employee and ensure compliance with all other OSHA requirements under routine and reasonably foreseeable **emergency situations**.

IDLH Protection

For protection from IDLH atmospheres, one of the following respirators shall be provided:

- A full facepiece **pressure demand self contained breathing apparatus (SCBA)** certified by NIOSH for a minimum service life of thirty minutes; or
- A combination full facepiece pressure demand **supplied-air respirator (SAR)** with auxiliary self-contained air supply.

Respirators provided only for escape from IDLH atmospheres shall be NIOSH-certified for escape from the atmosphere in which they will be used.

All **oxygen deficient atmospheres** shall be considered IDLH.

Gas and Vapor Protection

For protection against gases and vapors, one of the following respirators shall be provided:

- An atmosphere-supplying respirator; or

- An **air-purifying respirator**, provided that the respirator is equipped with an **end-of-service-life indicator (ESLI)** certified by NIOSH for the contaminant or when there is no ESLI appropriate for conditions in the workplace Environmental Health and Safety Department shall implement a change schedule for canisters and cartridges that is based on objective information or data from the respirator manufacturer that will ensure that **canisters and cartridges** are changed before the end of their **service life**.

Particulate Protection

For protection against particulates, one of the following respirators shall be provided:

- An atmosphere-supplying respirator; or
- An air-purifying respirator equipped with a filter certified by NIOSH under 30 CFR part 11 as a **high efficiency particulate air (HEPA)** filter, or an air-purifying respirator equipped with a filter certified for particulates by NIOSH under 42 CFR part 84; or
- For contaminants consisting primarily of particles with mass median aerodynamic diameters (MMAD) of at least two micrometers, an air-purifying respirator equipped with any filter certified for particulates by NIOSH.

Medical Evaluation

Using a respirator may place a physiological burden on employees that vary with the type of respirator worn, the job and workplace conditions in which the respirator is used and the medical status of the employee.

General

A medical evaluation to determine the employee's ability to use a respirator shall be provided prior to the employee being fit tested or required to use a respirator in the workplace. All medical evaluations shall be discontinued when the employee is no longer required to use a respirator.

Medical Evaluation Procedures

Employees shall obtain and complete a medical questionnaire available from Environmental Health and Safety Department. All completed questionnaires shall be sealed in the "confidential" envelope and submitted to a representative from Environmental Health and Safety Department.

Environmental Health and Safety Department shall forward all questionnaires to UW Health Center for review.

Environmental Health and Safety Department shall provide the following information to UW Health Center prior to the clinic making a recommendation concerning an employee's ability to use a respirator:

- The type and weight of the respirator to be used by the employee;
- The duration and frequency of respirator use (including use for rescue and escape);
- The expected physical work effort;
- Additional protective clothing and equipment to be worn;
- Temperature and humidity extremes that may be encountered;
- A copy of this Respiratory Protection Program; and
- A copy of OSHA's Respiratory Protection Standard.

Additional Medical Evaluations

At a minimum, additional medical evaluations shall be required if:

- An employee reports medical signs or symptoms that are related to the ability to use a respirator;
- The physician, supervisor or representative from Environmental Health and Safety Department recommends a reevaluation;
- Information from the respiratory protection program, including observations made during fit testing and program evaluation, indicates a need for employee reevaluation; or
- A change occurs in workplace conditions (e.g., physical work effort, protective clothing, temperature) that may result in substantial increase in the physiological burden placed on an employee.

Fit Testing Procedures

Before an employee may be required to use any respirator with a **negative or positive pressure tight-fitting facepiece**, the employee shall be fit tested with the same make, model, style and size of respirator that will be used.

Environmental Health and Safety Department shall conduct and ensure employees pass an appropriate **qualitative fit test (QLFT)**. Fit testing shall be conducted prior to initial use of the respirator, whenever a different respirator facepiece (e.g., size, style, model, make) is used and at least annually thereafter.

An additional fit test shall be conducted whenever any of the following occurs:

- Significant weight change (20 pounds or more);
- Significant facial scarring in the area of the facepiece seal;
- Significant dental changes;
- Reconstructive or cosmetic surgery; or
- Other conditions that may interfere with the facepiece seal.

If after passing a QLFT, the employee subsequently notifies Environmental Health and Safety Department that the fit of the respirator is unacceptable, the employee shall be given a reasonable opportunity to select a different respirator facepiece and be retested.

All fit tests shall be administered by Environmental Health and Safety Department.

Respirator Use

Facepiece Seal Protection

Respirators with tight-fitting face pieces shall not be worn by employees who have:

- Facial hair that comes between the sealing surface of the facepiece and the face or that interferes with valve function; or
- Any condition that interferes with the face-to-facepiece seal or valve function.

If an employee wears corrective glasses or goggles or other personal protective equipment, it shall be worn in a manner that does not interfere with the seal of the facepiece to the face seal of the user.

Routine and Emergency Use Procedures

Employees shall leave the respirator use area for the following reasons:

- To wash their faces and respirator facepieces as necessary to prevent eye or skin irritation associated with respirator use;
- If they detect vapor or gas breakthrough, changes in breathing resistance or leakage of the facepiece; or
- To replace the respirator or the filter, cartridge or canister elements.

If the employee detects vapor or gas breakthrough, changes in breathing resistance or leakage of the facepiece, the respirator shall be replaced or repaired prior to returning to the work area.

IDLH Atmospheres

For all IDLH atmospheres:

- One employee, or when needed, more than one employee shall be located outside the IDLH atmosphere;
- Visual, voice or signal line communication shall be maintained between the employee(s) inside and outside of the IDLH atmosphere; and
- The Seattle Fire Department shall be contacted prior to entry into IDLH atmospheres to provide entry assistance, back-up assistance and/or emergency rescue (Refer to the Hazardous Materials Response, Section 1.7 of this Safety Manual).

Maintenance and Care of Respirators

Cleaning and Disinfecting

All respirators provided to employees shall be clean, sanitary and in good working order. Respirators shall be cleaned and disinfected using the procedures in "Appendix D - Respirator Cleaning Procedure" at the following intervals:

- As often as necessary to be maintained in a sanitary condition when used exclusively by one employee;
- After each use when issued to more than one employee; and
- After each use when used for fit testing and training purposes.

Storage

All respirators shall be stored to protect them from damage, contamination, dust, sunlight, extreme temperatures, excessive moisture and damaging chemicals, and they shall be packed or stored to prevent deformation of the facepiece and exhalation valve.

Emergency respirators shall be kept accessible to the work area, stored in compartments or covers clearly marked as containing emergency respirators and stored in accordance with any applicable manufacturer instructions.

Inspection

Respirators used on a routine basis shall be inspected before each use and during cleaning.

Emergency use respirators shall be inspected before and after each use and at least monthly otherwise.

Emergency **escape-only respirators** shall be inspected before being carried into the workplace for use.

Respirator inspections shall include the following:

- A check of respirator function, tightness of connections and the condition of the various parts including, but not limited to, the facepiece, head straps, valves, connecting tube and cartridges, canisters or filters; and
- A check of elastomeric parts for pliability and signs of deterioration.

Inspections of respirators maintained for emergency use shall be certified by documenting the date the inspection was performed, the name of the person who made the inspection, the findings, required remedial action and a serial number or other means of identifying the inspected respirator. This information shall be kept with the respirator and maintained until replaced with a subsequent certification.

Repairs

Respirators failing inspections or otherwise found to be defective shall be removed from service and discarded, repaired or adjusted only by persons appropriately trained to

perform such operations using only the respirator manufacturer's NIOSH-approved parts designed for the respirator.

Contact Environmental Health and Safety Department for guidance on obtaining replacement parts and/or repair information or service.

All compressed breathing air shall meet the requirements for Grade D breathing air described in American National Standards Institute (ANSI)/Compressed Gas Association Commodity Specification for Air, G-7.1-1989.

Training and Information

Environmental Health and Safety shall conduct training prior to requiring any employee to use a respirator in the workplace. This training shall utilize the "Respiratory Protection" training booklet generated by Environmental Health and Safety Department. This training booklet shall be revised to include provisions of the revised standard, as revisions to the standard are published.

Environmental Health and Safety Department shall ensure that each employee attending training is able to demonstrate knowledge of at least the following:

- Why the respirator is necessary and how improper fit, usage or maintenance can compromise the protective effect of the respirator;
- What the limitations and capabilities of the respirator are;
- How to use the respirator effectively in emergency situations, including situations in which the respirator malfunctions;
- How to inspect, put on and remove, use and check the seals of the respirator;
- What the procedures are for maintenance and storage of the respirator;
- How to recognize medical signs and symptoms that may limit or prevent the effective use of respirators; and
- The general requirements of the standard.

Retraining

Retraining shall be administered annually and when the following situation occurs:

- Changes in the workplace or the type of respirator render previous training obsolete;
- Inadequacies in the employee's knowledge or use of the respirator indicate that the employee has not retained the requisite understanding or skill; or
- Any other situation arises in which retraining appears necessary to ensure safe respirator use.

Program Evaluation

Environmental Health and Safety Department shall conduct evaluations of the workplace to ensure this program is being properly implemented.

Environmental Health and Safety Department shall regularly consult employees required to use respirators to assess the employees' views on program effectiveness and to identify any problems. Any problems identified during this assessment shall be corrected. Factors to be assessed include, but are not limited to, the following:

- Respirator fit (including the ability to use the respirator without interfering with effective workplace performance);
- Appropriate respirator selection for the hazards to which the employee is exposed;
- Proper respirator use under the workplace conditions the employee encounters; and
- Proper respirator maintenance.

Record keeping

Medical Evaluations

Environmental Health and Safety Department shall retain records of medical evaluations for the duration of employment and 30 years thereafter.

Fit Test Records

Environmental Health and Safety Department shall maintain all copies of "Appendix E - Fit Test Record" until the next fit test is administered.

Glossary

Air-purifying respirator: A respirator with an air-purifying filter, cartridge or canister that removes specific air contaminants by passing ambient air through the air-purifying element.

Canister or Cartridge: A container with a filter, sorbent, or catalyst, or combination of these items, which removes specific contaminants from the air passed through the container.

Emergency Situation: Any occurrence such as, but not limited to, equipment failure, rupture of containers, or failure of control equipment that may or does result in an uncontrolled significant release of an airborne contaminant.

Employee Exposure: Exposure to a concentration of an airborne contaminant that would occur if the employee were not using respiratory protection.

End-of-Service-Life Indication (ESLI): A system that warns the respirator user of the approach of the end of adequate respiratory protection, for example, that the sorbent is approaching saturation or is no longer effective.

Escape-only Respirator: A respirator intended to be used only for emergency exit.

Filter or Air Purifying Element: A component used in respirators to remove solid or liquid aerosols from the inspired air.

Filtering Face piece (Dust Mask): A negative pressure particulate respirator with a filter as an integral part of the face piece or with the entire face piece composed of the filtering medium.

Fit Test: The use of a protocol to qualitatively or quantitatively evaluate the fit of a respirator on an individual.

High Efficiency Particulate Air (HEPA) Filter: A filter that is at least 99.97% efficient in removing monodisperse particles of 0.3 micrometers in diameter. The equivalent NIOSH 42 CFR 84 particulate filters are the N100, R100 and P100 filters.

Immediately Dangerous to Life or Health (IDLH): An atmosphere that poses an immediate threat to life, would cause irreversible adverse health effects, or would impair an individual's ability to escape from a dangerous atmosphere.

Negative Pressure Respirator: A respirator in which the air pressure inside the face piece is negative during inhalation with respect to the ambient air pressure outside the respirator.

Oxygen Deficient Atmosphere: An atmosphere with oxygen content below 19.5% by volume.

Physician or Other Licensed Health Care Professional (PLHCP): An individual whose legally permitted scope of practice (e.g., license, registration or certification) allows him or her to independently provide, some or all of the health care services required by the standard.

Positive Pressure Respirator: A respirator in which the pressure inside the respiratory inlet covering exceeds the ambient air pressure outside the respirator.

Powered Air-purifying Respirator (PAPR): An air-purifying respirator that uses a blower to force the ambient air through air-purifying elements to the inlet covering.

Pressure Demand Respirator: A positive pressure atmosphere-supplying respirator that admits breathing air to the facepiece when the positive pressure is reduced inside the facepiece by inhalation.

Qualitative Fit Test (QLFT): A pass/fail fit test to assess the adequacy of respiratory fit that relies on the individual's response to the test agent.

Self-Contained Breathing Apparatus (SCBA): An atmosphere supplying respirator for which the breathing air source is designed to be carried by the user.

Service Life: The period of time that a respirator, filter or sorbent, or other respiratory equipment provides adequate protection to the wearer.

Supplied Air Respirator (SAR) or Airline Respirator: An atmosphere-supplying respirator for which the source of breathing air is not designed to be carried by the user.

User Seal Check: An action conducted by the respirator user to determine if the respirator is properly seated to the face.

3.18 Hearing Conservation

Please note that this program has a glossary. The glossary contains the definitions for various terms used in the program. These terms are highlighted in bold print the first time they appear in the body of the program.

Policy

Environmental Health and Safety Department shall ensure that no employee is subjected to noise that produces **sound levels** in excess of those established by the Occupational Safety and Health Administration (OSHA) without approved hearing protection.

Authority and Responsibility

Departments shall be responsible for:

1. Contacting Environmental Health and Safety Department of any potential overexposures;
2. Implementing engineering and/or administrative controls as deemed necessary;
3. Arranging audiometric evaluations for employees;
4. Maintaining all audiometric test records;
5. Providing hearing protection to employees; and
6. Supervising and ensuring the correct use of hearing protection devices.

Environmental Health and Safety Department shall be responsible for:

1. Conducting all personal and/or area noise monitoring;
2. Notifying all employees exposed at or above an 8-hour **time weighted average (TWA)** of 85 **decibels** (dB) of the monitoring results;
3. Ensuring proper initial fitting of all hearing protection devices;
4. Conducting annual training for employees included in the Hearing Conservation Program; and
5. Maintaining all exposure measurement records.

Employees shall be responsible for:

1. Using hearing protection as required;
2. Participating in annual **audiograms**;

3. Participating in annual training;
4. Inspecting and maintaining hearing protection devices; and
5. Seeking replacement or repair of hearing protection devices when necessary.

Sound Surveys and Exposure Monitoring

Employee and/or area monitoring shall be performed when exposure is suspect of being at or above the **action level** of an 8-hour TWA of 85 dB.

Factors, which suggest that noise exposures in the workplace may be at or above 85 dB, include employee complaints about the loudness of noise, indications that employees are losing their hearing, or noisy conditions which make normal conversation difficult.

All **continuous, intermittent** and **impulsive/impact** sound levels from 80 dB to 130 dB shall be incorporated into the noise measurement survey.

The degree of noise reduction required shall be determined by comparing the measured levels with acceptable noise levels as presented in Table 1.

Monitoring shall be repeated whenever a change in processes, production, equipment or controls increases noise exposure to the extent that additional employees may be exposed at or above the action level or the **attenuation** provided by hearing protection devices being used by employees may be rendered inadequate.

Affected employees or their representatives shall be provided an opportunity to observe any noise measurements.

Employees shall be removed from the Hearing Conservation Program once noise levels have been measured and determined to be at acceptable levels.

Table 1 indicates OSHA's permissible noise exposure limits.

Table 1: Permissible Noise Exposures

<u>Duration</u> <u>(hours)</u>	<u>Sound Level dBA (Slow</u> <u>Response)</u>
8	90
6	92
4	95
3	97
2	100
1-1/2	102
1	105
1/2	110

Note: Exposures to impulsive/impact noise shall not exceed 140 dB peak sound pressure level.

Control Measures

When employees are subjected to sound exceeding those levels listed in Table 1, feasible engineering and administrative controls shall be utilized as the first step in noise control. If these controls fail to reduce sound to acceptable levels, hearing protection devices shall be used. During the implementation of administrative and/or engineering controls, affected employees shall be provided with hearing protection devices and trained in accordance with this program.

Administrative Controls

Administrative controls normally involve a change in work schedules or operations, which reduce noise exposures. Examples include operating a noisy machine on the second or third shift when fewer people are exposed or shifting an employee to a less noisy job once a hazardous daily noise dose has been reached.

Engineering Controls

Engineering controls shall be used when any modification or replacement of equipment, or related physical change at the noise source or along the transmission path can be altered which reduces the noise level to the employee's ear.

Typical engineering controls may involve the following:

1. Reducing noise at the source;
2. Interrupting the noise path;
3. Reducing reverberation;
4. Reducing structure-borne vibration;
5. Employee/equipment isolation; and
6. Equipment/process substitution.

Hearing Protection Devices

Hearing protection devices shall be made available to all employees exposed to an 8-hour TWA of 85 dB or greater at no cost to the employees. Hearing protection devices shall be replaced as necessary.

Hearing protection devices shall be worn by employees required to wear personal protective equipment and by any employee who is exposed to an 8-hour TWA of 85 dB or greater, and who has not yet had a baseline audiogram or has experienced a **standard threshold shift**.

Employees shall be given the opportunity to select their hearing protection from a variety of suitable hearing protection devices.

Audiometric Evaluations

Audiometric evaluations shall be made available at no cost to all University employees whose exposure equals or exceeds an 8-hour TWA of 85 dB.

Baseline Audiograms

Baseline audiograms shall be performed within six months of an employee's first measured exposure at or above the action level to compare subsequent audiograms.

Exception: Where mobile test vans are used to meet the audiometric testing obligation, the employer shall obtain a valid baseline audiogram within one year of an employee's first exposure at or above the action level. Where baseline audiograms are obtained more than six months after the employee's first exposure at or above the action level, employees shall wear hearing protection devices for any period exceeding six months after first exposure until the baseline audiogram is obtained.

Prior to the audiogram, employees shall be informed to avoid high levels of non-occupational noise exposure during the 14-hour period immediately preceding the audiometric examination.

Annual Audiograms

Audiograms shall be performed at least annually after obtaining the baseline audiogram for each employee exposed at or above the 8-hour TWA of 85 dB. Each employee's annual audiogram shall be compared to his/her baseline audiogram to determine if the audiogram is valid and if a standard threshold shift has occurred. If the annual audiogram shows that an employee has suffered a standard threshold shift, the employee may obtain a retest within 30 days and the retest results may be considered the annual audiogram. If a comparison of the annual audiogram to the baseline indicates a standard threshold shift, the employee shall be informed of this in writing within 21 days of the determination.

All audiometric tests and equipment calibration shall be performed in accordance with the criteria established by "OSHA's Occupational Noise Exposure" Standard 29 CFR 1910.95.

Information and Training

Employees who are exposed to noise at or above an 8-hour TWA of 85 dB shall receive training on the following:

1. Effects of noise on hearing;
2. Purpose of hearing protection devices;
3. Advantages and disadvantages of hearing protection devices;
4. Attenuation of various types of hearing protection devices;
5. Instructions on selection, fitting, use and care of hearing protection devices; and
6. The purpose of audiometric testing including an explanation of the test procedure.

Environmental Health and Safety Department shall conduct annual training for all employees included in the University's Hearing Conservation Program. This training

shall utilize the "Hearing Conservation" training booklet generated by Environmental Health and Safety Department, which shall be updated to ensure consistency with changes in protective equipment and work processes.

Copies of OSHA's "Occupational Noise Exposure" Standard 29 CFR 1910.95 are available upon request by contacting Environmental Health and Safety Department.

Record keeping

Exposure Measurements

Environmental Health and Safety Department shall maintain an accurate record of all employee exposure measurements for a period of two years.

Audiometric Tests

Records of all employee audiometric tests shall be retained for the duration of the affected employee's employment and thirty years from the date of termination. These records shall include:

1. Name and job classification of the employee;
2. Date of the audiogram;
3. The examiner's name;
4. Date of last acoustic or exhaustive calibration of the audiometer;
5. Employee's most recent noise exposure assessment; and
6. Background sound pressure level measurements in audiometric test rooms.

All records shall be made available upon written request to the employee or designee at any time without regard to employment status.

Glossary

Attenuation: The noise reducing capacity of hearing protection devices.

Action Level: An 8-hour time-weighted average of 85 decibels measured on the A-scale, slow response, or equivalently, a dose of fifty percent.

Audiogram: A chart, graph or table resulting from an audiometric test showing an individual's hearing threshold levels as a function of frequency.

Baseline Audiogram: The audiogram against which future audiograms are compared.

Continuous Noise: Noise intervals of one second or less.

Decibel (dB): Unit of measurement of sound level.

Hertz (Hz): Unit of measurement of frequency, numerically equal to cycles per second.

Intermittent Noise: Broadband sound pressure level exposure several times throughout the day.

Impulsive/Impact: Sharp burst of noise.

Sound Level: Ten times the common logarithm of the ratio of the square of the measured A-weighted sound pressure to the square of the standard reference pressure of 20 micropascals. Unit: decibels (dB).

Standard Threshold Shift (STS): A change in hearing threshold relative to the baseline audiogram of an average of 10 dB or more at 2000, 3000 and 4000 hertz in either ear.

3.19 Hazardous Waste Disposal

Some things you should know-

Individuals handling hazardous waste must:

- Attend hazardous waste training.
- Follow the established hazard waste handling procedures.
- Ensure the waste materials are properly managed in the lab.
- Complete and mail pick-up request forms.

Containers holding hazardous wastes must be:

- Filled to no more than 95% capacity to provide sufficient head space for changes in ambient temperatures.
- Securely sealed with an appropriate cap.
- Free of spilled waste materials on exterior.
- Properly tagged to identify contents by chemical name and percent concentration.
- Stored in a secondary container, e.g., cabinet or tub.
- Placed in a secure area, i.e., supervised lab (when no one is present, the area **must be locked**).

Additional Procedures:

- All hazardous waste materials must be picked up by EH&S (5-2848).
- All full containers of hazardous waste must be submitted for pickup on a chemical waste pickup form for immediate removal from the lab or work area.
- To prevent spillage, breakage, or accidents and to coincide with quarterly vendor waste shipments, containers should be sized appropriately so that they may be removed within 90 days.
- To conform to regulatory requirements, however, all containers regardless of fullness must be submitted for pickup on chemical waste pickup forms and removed within 9 months.

- Liquid or solid waste may not be disposed of in the trash or poured down the drain unless they are properly screened as no hazardous materials using the “Hazardous Waste Guidelines.”
- Incompatible chemical wastes must be segregated in storage and in secondary containment.
- Waste containing carcinogens (e.g., syringes and needles, nutrient media, etc.) must be collected by EH&S.
- Chemically contaminated glassware and broken glassware must be placed in a lined “Fisher” glass box before disposal. Tightly seal the bag by tying or taping and then tape the box lid in place to avoid discharge of materials should the box be inverted; also, securely tape the bottom of large glass boxes to prevent similar incidents.

Special Waste:

- Water reactive, pyrophoric, outdated organic peroxides, or other unstable materials must be handled on a case-by-case basis; tag and identify on a chemical waste pickup form.
- Picric acid and their derivatives require special handling arrangements; complete tagging and chem. form requirements.
- Compressed gas cylinders must be returned to the vendor; if vendor is unknown or cylinder is unacceptable to vendor, contact EH&S.
- Empty containers as defined in the Hazardous Waste Guidelines may be placed in the trash, provided labels are defaced; empty containers of extremely hazardous materials (LD50 \leq 50 mg/kg) must be submitted to EH&S for disposal (see Hazardous Waste Guidelines).

Rejection Criteria:

Your waste may be rejected for pick-up for any of the following reasons.

Please note that this list is not exhaustive:

- Waste container not identified on pickup form.
- Container not tagged or tag not secure.
- Information on tag incorrect or not properly completed.
- Description on tag not consistent with pickup form.
- Exterior of container contaminated.
- Item number on tag missing or not consistent with pickup form.
- Container type inconsistent with pickup form or incorrectly specified.
- Waste containers are not accessible or cannot be safely moved due to physical storage conditions, chemical contamination in the surrounding environment, etc.

For further information call:

616-0587 (UW upper campus waste collection)

Waste Minimization

Waste Minimization is any type of reduction in the quantity of hazardous wastes achieved through a conscientious application of innovative or alternative procedures. Simple adjustments to a process producing wastes (e.g. a teaching lab experiment, a vehicle cleaning operation, etc.) may be the only requirement to achieve some results. However, looking at the broader picture in the University environment, it is often difficult to recognize waste reductions due to the complex and changing growth patterns within the campus community. Reductions are often offset by increased staff and student growth and/or building construction.

Waste minimization often results in cost minimization. However, it is not uncommon to devise techniques to minimize costs without a corresponding reduction in waste quantities. For example, proper segregation of wastes will reduce disposal fees but only because these quantities are reassigned to more appropriate waste streams for cost effective disposal/treatment off site. While this is not technically waste minimization, it is still a beneficial process.

Waste Minimization Suggestions

- Substitute less hazardous chemicals or ingredients for ones you are using now.
- Order only the chemicals needed for the short term. You will spend more to dispose of larger amounts of chemicals than you will save by purchasing large orders to get quantity discounts.
- If you're dealing with common household chemicals, call the County Hotline for the latest updates on recommended and available substitutes.
- Test your ideas on the smallest scale practical to minimize disposal costs.
- Keep your wastes segregated by compatibility and type; avoid cross contamination as much as possible.

Start your waste minimization thought process by following the proper campus hazardous waste procedures.

- Review your inventory periodically to remove unwanted or unusable chemical stocks.
- Ensure proper identification is on all chemical containers.
- Attach a properly completed yellow hazardous waste tag to each chemical waste container.
- Complete your waste inventory for EH&S submittal with a Chemical Waste Pickup form.

Call EH&S at 543-7262 if you have any specific questions or need help with your project.

Section 4: Hazardous Materials Protocol

4.1 Chemical Storage

This program contains requirements for practices designed and implemented to protect University employees, students, visitors and the environment from the risks of hazardous chemicals that are stored on University property.

Scope

This program is applicable to all University students, faculty and staff that are required by the nature of their job to handle hazardous chemicals.

Definitions

Flammable chemicals - Solid, liquid or gaseous chemicals that readily catch fire and burn in the presence of oxygen.

CLASSIFICATION TERM FLASH POINT TEMPERATURE

Flammable Liquid Class I Below 100°F (37.8°C)

Flammable Liquid Class I A Below 73°F (22.8°C) and Boiling Point below 100°F (37.8°C)

Flammable Liquid Class I B Below 73°F (22.8°C) and Boiling Point at or above 100°F (37.8°C)

Flammable Liquid Class I C Below 100°F (37.8°C) and Boiling Point at or above 73°F (22.8°C)

Combustible chemicals - Solid, liquid or gaseous materials that burn in the presence of oxygen.

CLASSIFICATION TERM FLASH POINT TEMPERATURE

Combustible Liquid Class II Below 140°F (60°C) or at or above 100°F (37.8°C)

Combustible Liquid Class III At or above 140°F (60°C)

Combustible Liquid Class III A Below 200°F (93.4°C) or at or above 140°F (60°C)

Combustible Liquid Class III B At or above 200°F (93.4°C)

NOTE: Ignitable liquids, regulated as wastes by the Environmental Protection Agency (EPA) under the Resource Conservation and Recovery Act, include Class I flammable liquids and Class II combustible liquids.

Corrosive chemicals - Any solid, liquid or gaseous chemicals that burn, irritate or destructively attack organic tissues, most commonly the skin.

Material Safety Data Sheet (MSDS) - Written or printed material prepared by the manufacturer of a hazardous chemical that contains information about the hazards of the chemical and the appropriate work practices required for use.

NFPA-approved - Approved by the National Fire Protection Association.

Oxidizing chemicals - Any solid, liquid or gaseous chemicals that may cause or enhance the combustion of other materials or readily react to oxidize combustible materials, generally by yielding oxygen or some other oxidizing gas.

Pyrophoric chemicals - Any liquid or solid chemicals that will ignite spontaneously in air below 130°F (54.4°C).

Reactive chemicals - Any solid, liquid or gaseous chemicals that react violently with water, or are normally unstable and readily undergo violent changes without detonating, or form potentially explosive mixtures with water, or generate toxic gases when mixed with water or corrosive chemicals, or are capable of detonation or an explosive reaction.

Toxic chemicals - Any solid, liquid or gaseous chemicals that can cause damage to living tissue, impairment of the central nervous system, severe illness or in extreme cases, death when ingested, inhaled or absorbed by the skin.

General Storage Requirements For All Chemicals

12. Label all chemical containers appropriately. If transferring chemicals out of their original container to another container or if the original container label is illegible, follow the chemical labeling guidelines as detailed within this Manual - Hazard Communication, Section 5.8.
13. Be knowledgeable of the procedures contained in EH&S's Chemical Spill Response Program to prepare yourself and others in the event that any chemical container leaks or is spilled.
14. Follow all precautions regarding the storage of incompatible chemicals. Consult the label and Material Safety Data Sheet (MSDS) for each chemical to ensure that you are familiar with the chemical and how it should be handled, stored and disposed. **Separate all chemicals into compatible groups and store alphabetically within stored groups.**
15. Provide a definite storage place for each chemical and return the chemical to that same location after each use.

16. Avoid storing chemicals in laboratory fume hoods or on bench tops, except for those chemicals intended to be used by the end of the day.
17. Store volatile toxic chemicals and odorous chemicals in a ventilated cabinet, if possible. The cabinet's associated electrical components must be explosion-proof if flammable materials are being ventilated. If located in a laboratory, locate the cabinet near the fume hood. Store other chemicals inside a closable cabinet or on a shelf that has a lip to prevent containers from sliding off in the event of a fire or other serious accident.
18. Do not expose stored chemicals to heat, direct sunlight or freezing conditions.
19. Store all containers of liquids on compatible plastic trays that are capable of holding the contents of the container if it leaks, or at least 10% of the total volume stored within the tray. Store liquids on lower shelves, if possible.
20. Seal all chemical containers well to minimize the escape of flammable, corrosive, irritating or toxic vapors or gases.
21. Ventilation is required for chemicals that may release dangerous or damaging quantities of vapors or gases, which may be flammable, corrosive, irritating or toxic.
22. For every chemical storage area, there should be evacuation and emergency procedures to be followed and fire extinguishers available in the case of personal exposure or a leak, spill or fire within the room.

Storage Requirements For Flammable And Combustible Chemicals

6. The storage area should be separated and protected so that a fire or spill in the storage area is not likely to spread beyond the storage area.
7. If containers of flammable and combustible liquids are larger than five (5) gallons in size, special provisions are necessary to prevent liquid from flowing out of the storage area in the event of a spill or leak. Contact EH&S at 543-7262 for further details.
8. When possible, store quantities of flammable liquids greater than one (1) gallon in NFPA-approved safety cans. Store all flammable liquids and solids in NFPA-approved storage cabinets. EH&S will provide these cabinets to you at no cost.
9. Do not store flammable chemicals in any refrigerator unless it has been designed for that purpose. Ordinary refrigerators contain spark sources that can ignite flammable vapors. If refrigerated storage is needed inside of a flammable storage room, an explosion-proof refrigerator must be used. Use chemical storage refrigerators only for storing chemicals, never food or drink. Label these refrigerators with the following signage:

NO FOOD OR DRINK TO BE STORED IN THIS REFRIGERATOR

10. Maximum Container Sizes for Flammable and Combustible Liquids

The following container sizes, **in liters**, are the maximum allowable unless otherwise specified:

Flammable Liquids Combustible Liquids

Quantity for Storage, Liters

Container	Class IA	Class IB	Class IC	Class II	Class IIIA
Glass	0.5	1	4	4	4
Metal or approved Plastic	4	20	20	20	20
Safety Cans	7.5	0	20	20	20

NOTE: Glass containers as large as one (1) gallon can be used, if needed, and if the required purity would be adversely affected by storage in a metal or approved plastic container, or if the liquid would cause excessive corrosion or degradation of a metal or approved plastic container.

6. Storage Limits for Flammable and Combustible Liquids

The following limits apply to all Class B Occupancies with sprinkler systems and is the maximum allowable. Contact EH&S for clarification if you have questions.

Liquid Class Flash Point (\square F) Amount Allowable (per 100 sq. ft.)

Class I Flammable Below 100° 4 gallons

Class II Combustible 100° - 139° 4 gallons

Class IIIA Combustible 140° - 200° 12 gallons

Class IIIB Combustible Above 200° Unlimited

7. Safety Equipment for Storage of Flammable Liquids

Safety Cans: Safety cans are containers that have built-in safety features for protecting flammable liquids from exposure to a fire situation. In a fire situation, a safety can is exposed to extremely high temperatures. This heat is transmitted to the contents, which in turn boil and produce a large vapor pressure. Every safety can is fitted with a spring-loaded cap that vents these vapors safely without bursting the can. The other safety feature of a safety can is the flame arrestor that consists of a cylindrical wire screen. Vapors emitted from a safety can will ignite when exposed to the flames of a fire. Since flames usually flash back to the source of liquid, the flame arrestor serves as a heat dissipater. The temperature in the space above the liquids in a safety can is lowered below the ignition temperature and ignition of the contents is eliminated.

Flammable Liquid Storage Cabinets: Flammable liquid storage cabinets are designed to maintain the temperature at the top of the cabinet interior below 325°F when subjected to a 10-minute fire test. Cabinets built to withstand the temperature rating during the 10-minute fire test are acceptable by OSHA standards if: (a) the maximum capacity of Class I and II liquids is not more than 60 gallons (or more than 120 gallons for Class II liquids); and (b) the cabinet is labeled with conspicuous lettering, such as Flammable-Keep Fire Away. All storage cabinets must have self-closing doors that will close the latch automatically when released. These doors must not be blocked open.

Special Refrigerators: Special refrigerators that can safely store flammable liquids have a spark-free interior such that all wiring and thermostat controls have been removed from the interior. Two types of these refrigerators are commercially available: a "flammable liquid storage" model and an "explosion-proof" model. A "flammable liquid storage" model is normally used in a non-explosive area where no flammable vapors are present. Such a refrigerator is normally powered through a standard three-wire cord plugged into an electrical outlet. An "explosion-proof" refrigerator is required when the area in which the refrigerator will be located has the potential for ignition of flammable vapors. An explosion-proof refrigerator is supplied with a "pigtail" cord that must be wired directly to a power source using metal conduit as specified by local electrical codes. Choosing the appropriate refrigerator will depend on the area in which it will be located.

8. Flammable and Combustible Liquid Storage Rooms

- a. Large quantities of liquids that need to be stored in specially designed storage rooms include those with flash point temperatures at or below 200°F (93.4°C) and include all liquids identified as flammable liquids, ignitable liquids or combustible liquids in Class II or IIIA.
- b. An inside storage room that does not exceed 150 sq. ft. in floor area is permitted to contain up to two (2) gallons per sq. ft. of floor area within the room, if the room is separated from the building by construction having at least one (1) hour fire resistance, and all openings between the room and the building are protected by assemblies having a one (1) hour fire-resistance rating. If it is desirable to increase the allowable storage capacity of such a room, the capacity can be increased to five (5) gallons per sq. ft. by providing the room with an automatic fire extinguishing system.
- c. An inside storage room needs to be ventilated to prevent possible accumulation of flammable concentrations of vapors from container leaks and spills. Recommended ventilation is from floor level with a capacity of one (1) cubic foot per minute of exhaust for each square foot of floor area in the room, with a minimum exhaust of 150 cubic foot per minute.
- d. If there is dispensing in the room, there should be provisions for ventilating the dispensing operation close to the points at which vapors are being emitted.

- e. If storage room containers of flammable and combustible liquids are larger than five (5) gallons in size, it is necessary to provide barriers to prevent spills in the room from migrating outside the room. If these containers hold Class I or Class II liquids, curbs or ramps are needed as barriers.
- f. Wiring and electrical fixtures located inside storage rooms must be suitable for the hazards. Explosion-proof (National Electric Code Class I, Division 2) electrical equipment is required for prevention of explosions if large quantities of flammable liquids (Class I) are being stored or dispensed. If only combustible liquids are being stored or dispensed, general use wire is acceptable.
- g. If an inside storage room has an exterior wall, it is classified by the NFPA flammable and combustible liquids code as a "cut-off room" for which there are two additional requirements: (a) Exterior walls are required to provide ready accessibility for fire fighting; and (b) if Class IA or Class IB liquids are dispensed or if Class IA liquids are stored in containers larger than one (1) gallon, the exterior wall or roof is required by the NFPA to be designed to provide explosion venting.
- h. There is no need for explosion venting in a small room used only for storage or in a room used for dispensing if adequate ventilation is provided.

Storage Requirements For Reactive Chemicals

1. Consider the storage requirements of each reactive chemical prior to purchasing.
2. Consult the label and MSDS in making decisions about storage of reactive chemicals.
3. Use and store only the quantities of material you will need for immediate use.
4. Cyanides and sulfides should be stored in a location separate from acids or protected from contact with acids.
5. All acids should be stored separately from all alkaline materials (bases).
6. Date all highly reactive materials as soon as received and make sure the label states:

DANGER! HIGHLY REACTIVE MATERIAL

7. Do not open a container of highly reactive material that is past its expiration date. Call EH&S at 543-7262 for assistance.
8. Dispose of highly reactive material through EH&S prior to the expiration date.
9. Segregate the following materials:
 - e) Oxidizing agents from reducing agents and combustibles
 - f) Powerful reducing agents from readily reducible substrates
 - g) Pyrophoric compounds from flammables
 - h) Perchloric acid from reducing agents and combustibles

15. Store reactive liquids in trays constructed of compatible materials, which are large enough to contain the contents of the bottles. Store perchloric acid bottles in glass or ceramic trays.
16. Store materials that react vigorously with water away from any possible contact with water. If chemicals are to be stored that are reactive if exposed to the air or water, they can safely be stored in sprinkler red areas where sprinkler discharge would serve to prevent rupture of the outer container.
17. Temperature control or refrigeration must be provided, as needed, for chemicals that deteriorate or react if their temperatures exceed safe limits recommended by the manufacturer or person synthesizing the chemical. Store thermally unstable materials in a refrigerator with the following safety features: all spark-producing controls are on the outside, a magnetic locked door, an alarm to warn when the temperature is too high.
18. Assign responsibility for the storage areas utilized for highly reactive materials to one (1) primary person and a backup person. Review this responsibility at least twice yearly.
19. Some highly reactive shock/heat sensitive materials are:

Ammonium perchlorate Dibenzoyl peroxide

Ammonium permanganate Diisopropyl peroxydicarbonate

Anhydrous perchloric acid Dinitrobenzene (ortho)

Butyl hydroperoxide Ethyl methyl ketone peroxide

Butyl perbenzoate Ethyl nitrate

t-Butyl peroxyacetate Hydroxylamine

t-Butyl peroxyvalate Peroxyacetic acid

1-Chloro-2, 4-dinitrobenzene Picric acid (<10% water content)

Cumene hydroperoxide Trinitrobenzene

Diacetyl peroxide Trinitrotoluene

Storage Requirements For Oxidizers

Oxidizing agents such as chlorates, perchlorates, peroxides, nitric acid, nitrates, nitrites and permanganates represent a significant hazard because of their propensity under certain conditions to undergo vigorous reactions when they come into contact with easily oxidized material such as metal powders and organic materials like wood, paper and other combustible material. Mineral acids such as perchloric acid, sulfuric acid and nitric acid, as well as other oxidizers, should be stored separate from flammables and

combustibles, by separate rooms, cabinets or break resistant containers. If large bottles must be stored in proximity of combustible materials, acid resistant trays must be used to prevent the oxidation of wood or corrosion of metal shelves.

1. Class I Oxidizer

Class I oxidizers will cause an increase of the burning rate of combustible material with which it comes in contact. Some examples are:

Hydrogen peroxide (8-28%) Magnesium perchlorate

Nitric acid (70% or less) Silver nitrate

Perchloric acid solutions (less than 60% wt/wt)

2. Class II Oxidizer

Class II oxidizers will cause an increase of the burning rate or may cause spontaneous ignition of combustible material with which it comes in contact.

Some examples are:

Calcium hypochlorite (50% or less wt/wt) Chromic acid

Hydrogen peroxide (28-52% wt/wt) Sodium peroxide

Contact EH&S if quantities are stored in excess of 1,000 lbs.

3. Class III Oxidizers

Class III oxidizers will cause a severe increase in the burning rate of combustible material with which they come in contact, or will undergo vigorous self-sustained decomposition when catalyzed or exposed to heat. Regulated quantities are permitted to be stored only on the ground floor of a building with no basement.

Some examples are:

Ammonium dichromate Perchloric acid solutions (60-73%)

Hydrogen peroxide (52-91% wt/wt) Sodium chlorate

Contact EH&S if quantities are stored in excess of 200 lbs.

4. Class IV Oxidizer

Class IV oxidizers can undergo an explosive reaction when catalyzed or exposed to heat, shock, or friction. Regulated quantities are permitted to be stored only in

detached storage. Storage areas for Class IV oxidizers must be provided with a means to vent fumes in any type of emergency. Some examples are:

Ammonium perchlorate Perchloric acid solutions

Ammonium permanganate (greater than 72.5%)

Hydrogen peroxide (greater than 91% wt/wt) Potassium super oxide

Contact EH&S if quantities are stored in excess of 10 lbs.

Storage Requirements For Toxic Chemicals

i. Store chemicals known to be highly toxic, including carcinogens, in ventilated storage in unbreakable, chemically resistant secondary containers.

Keep quantities on hand at an absolute minimum.

Label storage areas with appropriate warning signs, such as:

CAUTION! REPRODUCTIVE TOXIN STORAGE

-or-

CAUTION! CANCER-SUSPECT AGENT STORAGE

and limit access to these areas.

4. Storage areas for pesticides and other toxic chemicals should be secured when the storage areas are not supervised by a responsible person so that unauthorized personnel are kept out.

Storage Requirements For Peroxidizable Chemicals

1. Some chemicals can form significant quantities of unstable peroxides after prolonged exposure to air and light. Certain peroxides may detonate with extreme violence when they become concentrated by evaporation or distillation, when combined with other compounds to yield a detonable mixture or when simply disturbed by unusual heat, shock or friction.

The following is a representative list of those compounds, which form peroxides:

PEROXIDE HAZARD IN STORAGE. These compounds form peroxides that may explode even without being concentrated

- Isopropyl ether Divinyl ether Potassium metal

- Potassium amide Sodium amide (sodamide) Vinylidene chloride

2. *PEROXIDE HAZARD ON CONCENTRATION*. These compounds may form peroxides as a result of distillation or most likely evaporation.

Dioxane Ethyl ether

Tetrahydrofuran Acetal

Cumene Cyclohexane

Dicyclopentadiene Diacetylene

Furan Ethylene glycol dimethyl ether

Methylcyclopentane Methyl acetylene

Tetrahydronaphthalene Vinyl ethers

3. *HAZARDS DUE TO PEROXIDE INITIATION OF POLYMERIZATION*. When stored as a liquid, the peroxide forming potential increases and certain of these monomers, especially butadiene, chloroprene and tetrafluoroethylene, should be considered as a peroxide hazard in storage.

Butadiene Chlorobutadiene (Chloroprene) Vinyl pyridine

Chlorotrifluoroethylene Styrene

Tetrafluoroethylene Vinyl acetate

Vinyl acetylene Vinyl chloride

Storage and handling procedures:

Each person responsible for a laboratory must develop and maintain an inventory of the peroxidizable materials in the laboratory. The inventory should be reviewed every three (3) months, at which time samples from List I, three (3) months or older, and List II and List III samples twelve (12) months or older would either be tested for peroxides or disposed of through EH&S. Quantities of peroxidizable compounds should be purchased according to short-term needs to ensure that peroxide buildup, which may accompany long-term storage, is minimized. Purchase in container sizes corresponding to use requirements to minimize exposure to air from multiple openings of the container.

4. Use the following labeling formats for all peroxide-forming liquids:

List I Peroxidizable Compound

Date received Date opened _____

Dispose of or test within 3 months after opening!

Disposal Date _____

Contact EH&S at 543-7262 for disposal.

List II/III Peroxidizable Compound

Date received Date opened _____

Discard or test within 12 months after opening!

Disposal Date _____

Contact EH&S at 543-7262 for disposal.

All peroxidizable compounds should be stored away from heat and light. Sunlight is an especially good promoter of peroxidation. Protection from physical damage and ignition sources during storage is also essential. Particular care should be given to ensure tight closure on storage containers. Loose or leaky closures may permit evaporation of storage material, leaving a hazardous concentration of peroxides in the container. Most common container materials, such as steel, stainless steel, copper, nickel, aluminum, baked phenolic linings and ceramics, are suitable for containers; however, they must be clean and free of metal oxides because iron or copper oxides may actually promote peroxide formation.

The use of oxidation inhibitors is especially important in the safe handling of peroxidizable materials. Hydroquinone, alkyl phenols, aromatic amines or similar materials are recommended by the manufacturers as being effective in preventing peroxide formation during storage. Compounds that are suspected of having very high peroxide levels because of visual observation of unusual viscosity or crystal formation or because of age should be considered extremely dangerous. The precautions taken for disposal of these materials should be the same as for any material that can be detonated by friction or shock. **IT IS OF THE UTMOST IMPORTANCE THAT THE CONTAINER NOT BE OPENED.** The act of opening the container **COULD DETONATE PEROXIDE CRYSTALS** under the container cap or other closure. Peroxidization in a chemical process may not only be a serious hazard because of the explosion potential, but also may affect lower yield and produce unwanted impurities.

Chemical Incompatibility Chart

Chem. Group #	Do Not Store with Chemicals in Group #'s
1. Inorganic Acids	2-8, 10, 11, 13, 14, 16-19, 21-23
2. Organic Acids	1, 3, 4, 7, 14, 16-19, 22
3. Caustics	1, 2, 5, 7, 8, 13-18, 20, 22, 23
4. Amines and alkanolamines	1, 2, 5, 7, 8, 13-18, 23
5. Halogenated compounds	1, 3, 4, 11, 14, 17
6. Alcohols, glycols, glycol ethers	1, 7, 14, 16, 20, 23
7. Aldehydes	1-4, 6, 8, 15-17, 19, 20, 23
8. Ketones	1, 3, 4, 7, 19, 20
9. Saturated hydrocarbons	20
10. Aromatic hydrocarbons	1, 20
11. Olefins	1, 5, 20
12. Petroleum oils	20
13. Esters	1, 3, 4, 19, 20
14. Monomers, polymerizable esters	1-6, 15, 16, 19-21, 23
15. Phenols	3, 4, 7, 14, 16, 19, 20
16. Alkylene oxides	1-4, 6, 7, 14, 15, 17-19, 23
17. Cyanohydrins	1-5, 7, 16, 19, 23
18. Nitriles	1-4, 16, 23
19. Ammonia	1-2, 7, 8, 13-17, 20, 23
20. Halogens	3, 6-15, 19, 21, 22
21. Ethers	1, 14, 20

- | | |
|--------------------------|--------------------------|
| 22. Elemental phosphorus | 1-3, 20 |
| 23. Acid anhydrides | 1, 3, 4, 6, 7, 14, 16-19 |

Chemical Compatibility Chart

Related and Compatible Storage Groups

ORGANIC FAMILY

Acids, anhydrides, peracids

Alcohols, glycols, amines, amides, imines, imides

Hydrocarbons, esters, aldehydes

Ethers, ketones, ketenes, halogenated hydrocarbons, ethylene oxide

Epoxy compounds, isocyanates

Peroxides, hydroperoxides, azides

Sulfides, polysulfides, sulfoxides, nitrites

Phenols, cresols

INORGANIC FAMILY

Metals, hydrides

Halides, sulfates, sulfites, thiosulfates, phosphates, halogens

Amides, nitrates (except ammonium nitrates, azides)

Hydroxides, oxides, silicates, carbonates, carbon

Sulfides, selenides, phosphides, carbides, nitrides

Chlorates, perchlorates, perchloric acid, chlorites, hypochlorites, peroxides, hydrogen peroxide

Arsenates, cyanides, cyanates

Borates, chromates, manganates, permanganates

Nitric acid, other inorganic acids

Sulfur, phosphorus, arsenic, phosphorus pentoxide

4.2 Hazardous Materials Transportation Program

Please note that this program has a glossary. The glossary contains the definitions for various terms used in the program. These terms are highlighted in bold print the first time they appear in the body of the program.

Policy

No employee of the Civil and Environmental Engineering Department shall offer or accept international, interstate, or intrastate transportation of a **hazardous material** except in accordance with criteria set forth in this policy and procedure.

Hazardous Material Classifications and Divisions

Under the Hazardous Materials Transportation Program, there are 11 **hazard classes** (nine numbered and two unnumbered) - classes 1 through 9, plus the classes **Combustible Liquids** and Other Regulated Materials (ORM). Note: Class number does not represent degree of hazard. Many of these classes are subdivided into **divisions**, which have numeric decimal values (See Appendix A).

Packaging

Each hazardous material is assigned to one of three packing groups (PG), based on tests for dropping, leakage, etc. Packing groups I, II and III indicate the degree of danger presented by the material is either great, medium or minor, respectively. If more than one packing group is indicated for an entry, the packing group for the hazardous material is determined using the criteria for assignment of packing groups specified for each class in 49 Code of Federal Regulations (CFR) 173 Subpart D. Class 2 and Class 7 materials and ORM-D materials, do not have packing groups. All packing groups are specified in column 5 of the 172.101 Hazardous Materials Table. Contact Environmental Health and Safety Department at 543-7262 for copies of the table.

Marking/Labeling

General Marking

All markings on the outside of a hazardous material package must be durable, easy to read, in English and unobstructed by anything else on the package.

Marking for Non-Bulk Packaging

The outside of each non-bulk package and any inside containers of hazardous materials must be marked with the following information:

1. Proper shipping name;
2. Identification number (preceded by "UN" or "NA", as appropriate); and

3. Name and address of the consignee or the consignor (the consignee is the person to whom the package is sent. The consignor is the person who sends the package except when the package is transported by highway only and will not be transferred from one motor **carrier** to another; or part of a carload lot, truckload lot or freight container load, and the entire contents of the rail car, truck or freight container are shipped from one consignor to on consignee.

Identification numbers are not required on packages, which contain only limited quantities or ORM-D materials.

When a non-bulk package contains inner containers of hazardous liquid materials, the inner containers must be packed with the caps/lids upright. In addition, it must be legibly marked with package orientation markings on two opposite vertical sides of the package with the arrows pointing in the correct upright direction. Arrows for purposes other than indicating proper package orientation may not be displayed on a package containing a liquid hazardous material.

For materials poisonous by inhalation, the package shall be marked "Inhalation Hazard" in association with the required labels or placards. Each non-bulk plastic outer **packaging** used as a single or composite packaging for materials meeting the definition of 6.1 shall be permanently marked, by embossment or other durable means, with the word "POISON" in letters at least 6.3 millimeters (0.25 inch) in height. The marking shall be located within 150 millimeters (6 inches) of the closure of the packaging.

If the package contains the reportable quantity of a **hazardous substance**, the letters "RQ" must be marked in association with the proper shipping name. Reportable quantity means the quantity specified in column 3 of the appendix to 172.101 Hazardous Materials Table for any material identified in Column 1 of the appendix.

Marking for Bulk Packaging

Bulk packages are required to display the proper shipping name on two opposite sides. The "UN" or "NA" identification number shall be displayed on each side and each end if the packaging has a capacity of 3,785 liters (1,000 gallons), or on two opposing sides if the packaging has a capacity of less than 3,785 liters (1,000 gallons).

For bulk packaging containing materials poisonous by inhalation, the package shall be marked "Inhalation Hazard" on two opposing sides in association with the required labels or placards.

Labeling

Each package containing hazardous materials presented for transportation must be labeled with a hazard label(s) that corresponds to the hazard class of the material it contains. Hazard labels must be placed on the same side of the package as the proper shipping name and "UN" or "NA" identification number markings. These labels must be clearly visible and unobstructed by anything else on the package.

Hazard warning labels must meet strict Department of Transportation (DOT) guidelines regarding size, shape, color and content. Domestic labels will generally have words; however, labels used in international commerce may be wordless. The chart in Appendix C illustrates the proper label that each hazard class or division requires.

If more than one label is indicated on the Hazardous Materials Table, the first one listed is the primary label as determined by the Department of Transportation and any others are subsidiary labels. Primary labels have a class or division number in their lower corner and subsidiary labels do not. The hazard warning labels are diamond-shaped and should measure at least 100 millimeters (3.9 inches) on each side.

Placarding Motor Vehicles

Table 1 below lists those hazard classes, which require placards for **motor vehicles** no matter what amount of material is being hauled. Table 2 includes hazard classes that require placards for motor vehicles carrying hazardous materials, but the amount of material being hauled will determine when placards are required. **Transport vehicles** containing less than 454 kg (1001 pounds) aggregate **gross weight** of any of the hazardous materials listed below in Table 2 are not required to be placarded.

Table 1: Hazardous Materials

Explosives 1.1
Explosives 1.2
Explosives 1.3
Poisonous Gas
Dangerous When Wet
Poison
Radioactive

Table 2: Hazardous Materials

Explosives 1.4
Explosives 1.5
Explosives 1.6
Flammable Gas
Non-Flammable Gas
Flammable
Combustible
Flammable Solid
Spontaneously Combustible
Oxidizer

Organic Peroxide
Poison
Keep Away From Food
Corrosives
Class 9

Placarding Exceptions

All transport vehicles shall be marked and placarded as specified within this section on each side and each end unless, in an emergency: the vehicle is escorted by a representative of a state or local government; the carrier has permission from the Department of Transportation; or movement of the transport vehicle is necessary to protect life or property. Placarding requirements do not apply to infectious substances, hazardous materials classed as ORM-D, hazardous materials authorized to be offered for transportation as limited quantities and identified as such on shipping papers, hazardous materials which are packaged as small quantities, and combustible liquids in non-bulk packaging.

Other considerations to the exceptions are as follows:

1. When more than one division placard is required for Class 1 materials on a transport vehicle, only the placard representing the lowest division number must be displayed;
2. A NON-FLAMMABLE GAS placard is not required on a transport vehicle which contains non-flammable gas if the transport vehicle also contains flammable gas or oxygen and it is placarded with FLAMMABLE GAS or OXYGEN placards as required;
3. OXIDIZER placards are not required for Division 5.1 materials on transport vehicles which also contain Division 1.1 or 1.2 materials and which are placarded with EXPLOSIVES 1.1 or 1.2 placards;
4. An OXIDIZER placard is not required for Division 5.1 materials on a transport vehicle which also contains Division 1.5 explosives and is placarded with EXPLOSIVES 1.5 placards;
5. The EXPLOSIVE 1.4 placard is not required for those Division 1.4 Compatibility Group S (1.4S) materials that are not required to be labeled 1.4S;
6. For domestic transportation of oxygen, compressed or oxygen, refrigerated liquid, the OXYGEN placard may be used in place of a NON-FLAMMABLE GAS placard;
7. Except for a material classed as a combustible liquid that also meets the definition of a Class 9 material, a COMBUSTIBLE placard is not required for a material classed as a combustible liquid when transported in a **non-bulk packaging**. For a material in a non-bulk packaging classed as a combustible liquid that also meets the definition of a Class 9 material, the Class 9 placard may be substituted for the COMBUSTIBLE placard;
8. For domestic transportation, a Class 9 placard is not required. A bulk packaging containing a Class 9 material must be marked on each side and each end with the

- appropriate identification number displayed on an orange panel; or a white-square-on-point display configuration; and
9. For domestic transportation of Division 6.1, Packing Group (PG) III materials, a POISON placard may be used in place of a KEEP AWAY FROM FOOD placard.

Prohibited Placarding

Other signs or devices which by color, design, shape or content could be confused with required placards shall not be displayed or affixed on any motor vehicle transporting hazardous materials.

Subsidiary Hazards

A transport vehicle containing two or more categories of materials, requiring different placards specified in Table 2, may be placarded DANGEROUS in place of the separate placarding specified for each of the materials listed in Table 2.

Transport vehicles containing poisonous materials subject to the "Poison-Inhalation Hazard" shipping description or materials which are subject to dangerous when wet subsidiary hazard must be placarded with a POISON or POISON GAS or DANGEROUS WHEN WET placard respectively in addition to any other placard required for that material. Duplication of the POISON or POISON GAS placard is not required.

Visibility and Display of Placards

All placards must be attached to each end and side of the vehicle so that any words or hazard class numbers are horizontal. A minimum of three inches must separate the placard from any other markings or advertising that appears on the vehicle.

It is the responsibility of the shipper to offer the required placards to the carrier when the carrier loads the hazardous materials for transport.

Loading and Unloading

Any tank, barrel, drum, cylinder, or other packaging, not permanently attached to a motor vehicle, which contains any Class 3 (flammable liquid), Class 2 (gases), Class 8 (corrosives), Division 6.1 (poisonous), or Class 7 (radioactive) material must be loaded in such a manner as to secure against movement within the vehicle during transportation.

When hazardous materials are loaded into or unloaded from any motor vehicle, the handbrake must be securely set and all other reasonable precautions will be taken to keep the vehicle from moving during such loading or unloading procedures.

Smoking in or within 25 feet of any motor vehicle while loading or unloading any hazardous material is prohibited. All fire sources shall be kept away from vehicles hauling any hazardous materials.

The Hazardous Materials Regulations contain Segregation Tables (49 CFR 177.848) that indicate which hazardous materials may not be loaded, transported, or stored together. Materials, which are in packages that require labels, in a compartment within a

multi-compartment cargo tank or in a portable tank, are subject to the Segregation Tables. In addition, cyanides or cyanide mixtures may not be loaded or stored with acids.

Cylinders

Containers with valves or other similar fittings shall be loaded so that there is minimum likelihood of any damage to them during transportation. Cylinders containing Class 2 (gases) materials shall be loaded onto a flat floor or platform of a motor vehicle. In order to prevent the overturning of cylinders, all cylinders must be securely lashed in an upright position; loaded into racks securely attached to the motor vehicle; packed in boxes or crates of such dimensions as to prevent their overturning; or loaded in a horizontal position. Cylinders for hydrogen, or **cryogenic liquid** may only be transported on a motor vehicle which has an open body equipped with a suitable rack or support having means to hold the cylinder upright when subjected to acceleration in any horizontal direction and any motor vehicle carrying such material may not enter a tunnel.

Shipping Papers

All hazardous materials transported in commerce are required to be accompanied by shipping papers. Shippers may use bills of lading, manifests or way bills as long as these documents contain the required information. The shipping paper requirements do not apply to materials, other than **hazardous wastes** or hazardous substances, identified by the letter "A" or "W" in column 1 of the 172.101 - Hazardous Materials Table unless they are intended for transportation by air or water, and materials classed as ORM-D unless they are intended for transportation by air.

The shipping papers must be legible and printed or typed in English. No unauthorized codes or abbreviations may be used. A shipping paper may consist of more than one page, if each page is consecutively numbered and the first page bears a notation specifying the total number of pages included in the shipping paper (for example, "Page 1 of 4 pages").

Five items must appear on shipping papers containing hazardous materials:

1. A basic description consisting of four elements in the following sequence:
 - Proper shipping name;
 - Hazard class or division;
 - UN or NA identification number; and
 - Packing group number;
2. Total quantity except for empty packaging, cylinders for Class 2 (**compressed gases**) materials, and bulk packaging, the total quantity (by net or gross mass, capacity, or as otherwise appropriate), including the unit of measurement, of the hazardous material covered by the description (e.g., "800 lbs" or "208 L") must appear on the shipping paper. For cylinders of Class 2 (compressed gases) materials and bulk packaging, some indication of total quantity must be shown (e.g., "10 cylinders" or "1 cargo tank");

3. **Emergency Number:** A 24-hour emergency response telephone number is located on the Material Safety Data Sheet.
4. **Certification Statement:** The shipper certifies that the materials listed on the shipping papers have been properly classified, described, packaged, marked and labeled, and are in proper condition for transport according to the regulations established by DOT; and
5. **Signature:** The signature of the shipper or his agent signifies that the shipment is in compliance with all relevant regulations.

All shipping papers shall be located so that they are readily available to, and recognizable by, authorities in the event of accident or inspection. When the driver is at the vehicle's controls, shipping papers shall be within his/her immediate reach or readily visible to a person entering the driver's compartment or in a holder which is mounted to the inside of the door on the driver's side of the vehicle. When the driver is not at the vehicle's controls, the shipping paper shall be in a holder which is mounted to the inside of the door on the driver's side of the vehicle or on the driver's seat in the vehicle.

General Entries

When a description of a hazardous material is required to be included on a shipping paper, that description must conform to the following requirements:

1. When a hazardous material and a material not subject to the requirements of this section are described on the same shipping paper, the hazardous material description entries must be entered first;
2. The hazardous material description entries must be entered in a color that clearly contrasts with any description on the shipping paper of a material not subject to the requirements of this section; and
3. Except: A description on a reproduction of a shipping paper may be highlighted, rather than printed, in contrasting color, or must be identified by the entry of an "X" placed before the proper shipping name in a column captioned "HM".

The basic description must be shown in sequence with no additional information interspersed. For example: "Gasoline, 3, UN 1203, PG II" (Shipping Name, Hazard Class, Identification Number, Packing Group).

Exceptions include the following:

1. The total quantity of the material covered by one description must appear before or after the description required above. The type of packaging and destination marks may be entered in any appropriate manner before or after the basic description. Abbreviations may be used to express units of measurement and types of packaging; and
2. Technical and chemical group names may be entered in parentheses between the proper shipping name and hazard class and following the basic description. An appropriate modifier, such as "contains" or "containing," may be used. For example: "Flammable liquids, n.o.s. (contains Xylene and Benzene), 3, UN 1993,

II." (If the hazardous substance does not appear in the Table and is not a forbidden material, then an appropriate generic or "n.o.s." shipping name shall be selected corresponding to the hazard class and packing group, if any, of the material as determined by 49 CFR 173.2 and 173.2a. For example, a hazardous substance which is listed in the appendix but not in the Table and which meets the definition of a flammable liquid might be described as "Flammable liquids, n.o.s." or other appropriate shipping name corresponding to the flammable liquid hazard class.

Emergency Response Information

All hazardous material shipments (except those that do not require shipping papers) must have emergency response information on or accompanying the shipping paper. All emergency response information must be legible and in English. The information on or accompanying the shipping paper must be in the form of the Emergency Response Guidebook, a material safety data sheet, or any other form that provides all the following information:

1. The basic description and technical name of the hazardous material;
2. Immediate hazards to health;
3. Risks of fire or explosion;
4. Immediate precautions to be taken in the event of an accident or incident;
5. Immediate methods for handling fires;
6. Initial methods for handling spills or leaks in the absence of fire; and
7. Preliminary first aid measures.

Hazardous Waste Shipments

A carrier shall not accept a shipment of hazardous waste unless it is accompanied by a properly prepared uniform hazardous waste manifest. Transportation of hazardous waste shall only be conducted by a contractor as provided by Environmental Health and Safety Department. Disposal of all hazardous waste shall be in conjunction with Section 5.12, Hazardous Materials Management Program.

Training and Information

General Employee Training

Environmental Health and Safety Department shall provide a training program for employees who during the course of employment directly affect hazardous materials transportation through one or more of the following activities:

- Loads, unloads, or handles hazardous materials;
- Tests, reconditions, repairs, modifies, marks, or otherwise represents containers, drums, or packaging as qualified for use in the transportation of hazardous materials;
- Prepares hazardous materials for transportation; or
- Operates a vehicle used to transport hazardous materials.

The training will be conducted within 90 days of employment for those employees whose job functions involve any of the aforementioned hazardous material tasks and once every

two years thereafter. Exception: Additional training shall be provided within 90 days of any job change involving the use of hazardous materials.

An employee may perform job functions prior to the completion of training provided the employee performs those functions under the supervision of a properly trained and knowledgeable employee.

A comprehensive training program shall include the following:

- General training to provide awareness and familiarization of the requirements of the Hazardous Materials Transportation Program and to enable the employee to recognize and identify hazardous materials consistent with the hazard communication standard;
- Function-specific training applicable to the functions the employee performs;
- Safety training pertaining to the following:
 - Emergency response information;
 - Measures to protect the employee from the hazards associated with hazardous materials to which they may be exposed in the workplace, including specific measures the employer has implemented to protect employees from exposure; and
 - Methods and procedures for avoiding accidents, such as the proper procedures for handling packages containing hazardous materials; or
 - Any additional department specific training (e.g., Pre-trip safety inspection or the use of vehicle controls and equipment, including the operation of emergency equipment).

Training Records

Training records shall be maintained by Environmental Health and Safety Department and include the following:

- The employee's name;
- The most recent training date;
- A description, copy, or the location of the training materials used to meet the aforementioned training requirements;
- The name and address of the person providing the training;
- Certification that the employee has been trained and tested as required; and
- Results of the learning measurement exercise.

Those employees not demonstrating adequate knowledge, as shown by the learning measurement exercise, will be re-trained until adequate knowledge is shown. Training records will be maintained for the duration of employment and for 90 days thereafter.

Glossary

Bulk packaging: A packaging, other than a vessel or a barge, including a transport vehicle or freight container, in which hazardous materials are loaded with no intermediate form of containment and which has:

- A maximum capacity greater than 450 liters as a receptacle for a liquid;
- A maximum net mass greater than 400 kilograms and a maximum capacity greater than 450 liters as a receptacle for a solid; or
- A water capacity greater than 454 kilograms.

Carrier: A person engaged in the transportation of passengers or property by land or water, as a common, contract, private carrier, or civil aircraft.

Compressed Gas: Any material which is a gas at normal temperature and pressure, and which is contained under pressure as a dissolved gas or liquefied by compression or refrigeration.

Compressed Gas in Solution: A non-liquefied compressed gas, which is dissolved in a solvent.

Combustible Liquid: Any liquid, which has a flash point above 60.5 degrees Celsius (141 degrees Fahrenheit) and below 93 degrees Celsius (200 degrees Fahrenheit).

Compatibility Group Letter: A designated alphabetical letter used to categorize different types of explosive substances and articles for purposes of storage and segregation.

Cryogenic Liquid: A refrigerated liquefied gas having a boiling point colder than -90 degrees Celsius (-130 degrees Fahrenheit) at 101.3 kilopascal (kPa) or 14.7 psia.

Detonate: To set off in a burst of activity.

Division: A subdivision of a hazard class.

Elevated Temperature: A material which, when offered for transportation or transported in a bulk packaging is: in a liquid phase and at a temperature at or above 100 degrees Celsius (212 degrees Fahrenheit) or is in a liquid phase with a flash point at or above 37.8 degrees Celsius (100 degrees Fahrenheit) that is intentionally heated and offered for transportation or transported at or above its flash point; or is in a solid phase and at a temperature at or above 240 degrees Celsius (464 degrees Fahrenheit).

Flammable Range: The difference between the minimum and maximum volume percentages of the material in air that forms a flammable mixture.

Flash Point: The minimum temperature at which a liquid gives off vapor within a test vessel in sufficient concentration to form an ignitable mixture with air near the surface of the liquid.

Gross Weight or Gross Mass: The weight of a packaging plus the weight of its contents.

Hazard Class: The category of hazard assigned to a hazardous material; a material may meet the defining criteria for more than one hazard class but is assigned to only one hazard class.

Hazardous Material: A substance or material, which is capable of posing an unreasonable risk to health, safety, and property when transported in commerce; materials designated by the Department of Transportation as hazardous.

Hazardous Substance: A material including its mixtures and solutions that is listed in the 172.101 - Hazardous Materials Table or is in a quantity, in one package, which equals or exceeds the reportable quantity (RQ) listed in the Hazardous Materials Table.

Hazardous Waste: Any material that is subject to the Hazardous Waste Manifest Requirements of the U.S. Environmental Protection Agency as specified in 40 CFR part 262.

LC50: The concentration of a material in air that on the basis of laboratory tests (inhalation route of entry) is expected to kill 50% of a group of test animal when administered as a single exposure in a specific time period.

Liquefied Compressed Gas: A gas that in a packaging under the charged pressure, is partially liquid at a temperature of 20 degrees Celsius (68 degrees Fahrenheit).

Limited Quantity: The maximum amount of a hazardous material for which there is a specific labeling or packaging exception.

Motor Vehicle: Includes a vehicle, machine, tractor, trailer, or semitrailer, or any combination thereof, propelled or drawn by mechanical power and used upon the highways in the transportation of passengers or property. It does not include a vehicle, locomotive, or car operated exclusively on a rail or rails, or a trolley bus operated by electric power derived from a fixed overhead wire, furnishing local passenger transportation similar to street-railway service.

Non-bulk Packaging: A packaging, which has:

- A maximum capacity less than 450 liters as a receptacle for a liquid;
- A maximum net mass less than 400 kilograms and a maximum capacity less than 450 liters as a receptacle for a solid; or
- A water capacity greater than 454 kilograms.

Non-liquefied Compressed Gas: A gas, other than in solution, which in a packaging under the charged pressure is entirely gaseous at a temperature of 20 degrees Celsius (68 degrees Fahrenheit).

psi: Pounds per square inch.

psia: Pounds per square inch absolute.

Packaging: A container and any other components or materials necessary for the container to perform its containment function in conformance with the minimum packing requirements.

Primary Hazard: The hazard class of a material as assigned in the "172.101 - Hazardous Material Table".

Pyrophoric Material: A liquid or solid that, even in small quantities and without an external ignition source, can ignite within five minutes after coming in contact with air.

Readily Combustible Solids: Materials that are solids and may cause fire through friction, such as matches, or any metal powders that can be ignited and react over the whole length of a sample in ten minutes or less.

Receptacle: A containment vessel for receiving and holding materials, including any means of closing.

Self-heating Material: A material that when in contact with air and without an energy supply, is liable to self-heat.

Self-reactive Materials: Materials that are liable to undergo, at normal or elevated temperatures, a strongly exothermal decomposition caused by excessively high transport temperatures or by contamination.

Subsidiary Hazard: A hazard other than the primary hazard.

Transport Vehicle: A cargo-carrying vehicle such as an automobile, van, tractor, truck, semitrailer, tank car or rail car used for the transportation of cargo by any mode. Each cargo-carrying body (trailer, rail car, etc.) is a separate transport vehicle.

UN: United Nations.

4.3 Hazardous Waste Disposal

Individuals handling hazardous waste must

- Attend hazardous waste training.
- Follow the established hazard waste handling procedures.
- Ensure the waste materials are properly managed in the lab.
- Complete and mail pick-up request forms.

Containers holding hazardous wastes must be

- Filled to no more than 95% capacity to provide sufficient head space for changes in ambient temperatures.
- Securely sealed with an appropriate cap.
- Free of spilled waste materials on exterior.
- Properly tagged to identify contents by chemical name and percent concentration.
- Stored in a secondary container, e.g., cabinet or tub.
- Placed in a secure area, i.e., supervised lab (when no one is present, the area **must be locked**).

Additional Procedures

- All hazardous waste materials must be picked up by EH&S (5-2848).
- All full containers of hazardous waste must be submitted for pickup on a chemical waste pickup form for immediate removal from the lab or work area.
- To prevent spillage, breakage, or accidents and to coincide with quarterly vendor waste shipments, containers should be sized appropriately so that they may be removed within 90 days.
- To conform to regulatory requirements, however, all containers regardless of fullness must be submitted for pickup on chemical waste pickup forms and removed within 9 months.
- Liquid or solid waste may not be disposed of in the trash or poured down the drain unless they are properly screened as no hazardous materials using the “Hazardous Waste Guidelines.”
- Incompatible chemical wastes must be segregated in storage and in secondary containment.
- Waste containing carcinogens (e.g., syringes and needles, nutrient media, etc.) must be collected by EH&S.
- Chemically contaminated glassware and broken glassware must be placed in a lined “Fisher” glass box before disposal. Tightly seal the bag by tying or taping and then tape the box lid in place to avoid discharge of materials should the box be inverted; also, securely tape the bottom of large glass boxes to prevent similar incidents.

Special Waste

- Water reactive, pyrophoric, outdated organic peroxides, or other unstable materials must be handled on a case-by-case basis; tag and identify on a chemical waste pickup form.
- Picric acid and their derivatives require special handling arrangements; complete tagging and chem. form requirements.
- Compressed gas cylinders must be returned to the vendor; if vendor is unknown or cylinder is unacceptable to vendor, contact EH&S.
- Empty containers as defined in the Hazardous Waste Guidelines may be placed in the trash, provided labels are defaced; empty containers of extremely hazardous materials (LD50 \leq 50 mg/kg) must be submitted to EH&S for disposal (see Hazardous Waste Guidelines).

Rejection Criteria

Your waste may be rejected for pick-up for any of the following reasons.

Please note that this list is not exhaustive:

- Waste container not identified on pickup form.
- Container not tagged or tag not secure.
- Information on tag incorrect or not properly completed.
- Description on tag not consistent with pickup form.
- Exterior of container contaminated.
- Item number on tag missing or not consistent with pickup form.
- Container type inconsistent with pickup form or incorrectly specified.
- Waste containers are not accessible or cannot be safely moved due to physical storage conditions, chemical contamination in the surrounding environment, etc.

For further information call:

206-616-0587

Waste Minimization

Waste Minimization is any type of reduction in the quantity of hazardous wastes achieved through a conscientious application of innovative or alternative procedures. Simple adjustments to a process producing wastes (e.g. a teaching lab experiment, a vehicle cleaning operation, etc.) may be the only requirement to achieve some results. However, looking at the broader picture in the University environment, it is often difficult to recognize waste reductions due to the complex and changing growth patterns within the campus community. Reductions are often offset by increased staff and student growth and/or building construction.

Waste minimization often results in cost minimization. However, it is not uncommon to devise techniques to minimize costs without a corresponding reduction in waste quantities. For example, proper segregation of wastes will reduce disposal fees but only

because these quantities are reassigned to more appropriate waste streams for cost effective disposal/treatment off site. While this is not technically waste minimization, it is still a beneficial process.

Waste Minimization Suggestions

- Substitute less hazardous chemicals or ingredients for ones you are using now.
- Order only the chemicals needed for the short term. You will spend more to dispose of larger amounts of chemicals than you will save by purchasing large orders to get quantity discounts.
- If you're dealing with common household chemicals, call the County Hotline for the latest updates on recommended and available substitutes.
- Test your ideas on the smallest scale practical to minimize disposal costs.
- Keep your wastes segregated by compatibility and type; avoid cross contamination as much as possible.

Start your waste minimization thought process by following the proper campus hazardous waste procedures.

- Review your inventory periodically to remove unwanted or unusable chemical stocks.
- Ensure proper identification is on all chemical containers.
- Attach a properly completed yellow hazardous waste tag to each chemical waste container.
- Complete your waste inventory for EH&S submittal with a Chemical Waste Pickup form.

Call EH&S at 543-7262 if you have any specific questions or need help with your project.

4.4 Chemical and Physical Hazards Monitoring

Policy

Civil and Environmental Engineering Department shall minimize exposure to hazardous chemicals and substances in accordance with all relevant standards and recommended exposure limits.

Authority and Responsibility

Environmental Health and Safety Department is responsible for:

1. Implementing and revising this program in accordance with newly promulgated standards by the Occupational Safety and Health Administration (OSHA) or when circumstances such as exposure incidents or a component of this program fails;
2. Working with the appropriate departments to ensure implementation of these measures; and

3. The Industrial Hygienists are responsible for developing corrective actions and recommending exposure control measures.

Note: Any process where an exposure is determined to be immediately dangerous to the health and safety of an employee or other individual(s) in the affected area shall be stopped by the Environmental Health and Safety Department under the authority of this policy and the statement of authority issued by the University Safety Committee.

Chemicals Monitored

The Environmental Health and Safety Department shall measure an employee's exposure to any substance regulated by a standard, which requires monitoring. For those hazardous chemicals and substances where no relevant standard exists or a recommended limit has been established, the exposure shall be evaluated and limited to the lowest reasonably achievable limit.

Exposure Determinations

Initial monitoring

Initial exposure monitoring shall be conducted for employees and areas in which it is determined that exposures may be in excess of established limits or upon notification by an employee that a potential overexposure exists.

Exposure determinations shall be measured according to the type of exposure the employee(s) or area(s) are subjected. OSHA has established **Permissible Exposure Limits (PELs)** in which it is acceptable to be exposed to certain chemicals based on certain time periods. These limits indicate a level of exposure at which there will be no irreversible health effects associated with exposure to that chemical. PELs may be expressed as **Time-Weighted Average limits (TWA)**, **Short-Term Exposure Limits (STEL)** or **Ceiling limits (C)**.

1. *Time Weighted Average (TWA)*
The allowable chemical concentration for a normal 8-hour workday and 40-hour work week to which nearly all workers may be repeatedly exposed, day after day, over an employee's lifetime, without adverse health effects.
2. *Short-term Exposure Limit (STEL)*
The maximum concentration for a continuous exposure period of 15 minutes with a maximum of four such periods per day, with at least 60 minutes between exposure periods, and provided that the daily TWA is not exceeded.
3. *Ceiling Limit (C)*
The chemical concentration not to be exceeded at any time.
4. *Immediately Dangerous to Life and Health (IDLH)*
The maximum concentration from which one could escape within 30 minutes without any escape-impairing symptoms or irreversible health effects. (Note: Carcinogenic effects were not considered in setting these values.)

NOTE: OSHA considers "Workers" as healthy individuals. The young, old, ill, and pregnant may be susceptible and have lower tolerances and need to take additional precautions.

For chemicals with no permissible exposure limits or where there is not an OSHA specific standard, the American Conference of Governmental Industrial Hygienists (ACGIH) recommended threshold limit values (TLVs) or National Institute for Occupational Safety and Health (NIOSH) recommended exposure limits (RELs) shall be used.

Periodic monitoring

If the employee's initial exposure determination has exceeded the action level or permissible exposure level, monitoring requirements of the measured contaminant shall be implemented in accordance with the appropriate standard.

Termination of monitoring

Monitoring shall be terminated by Environmental Health and Safety Department in accordance with the relevant standard or in the absence of a standard when the lowest reasonably achievable exposure level has been obtained.

Employee Notification

Employees shall be notified of the results in writing either individually or by posting within fifteen working days after the results of monitoring have been received by Environmental Health and Safety Department. The department director or supervisor shall also receive a copy of the monitoring report.

The monitoring report shall contain the following information:

- Introduction;
- Task analysis;
- Toxicity data;
- Sampling methodology;
- Results;
- Conclusion;
- Recommendations;
- Copy of laboratory analysis results;
- Diagrams/maps; and
- Other relevant information.

Record keeping

Employee monitoring results shall be maintained by Environmental Health and Safety Department for the duration of employment and for a period of 30 years from the date of termination. Copies of monitoring results may be requested by the employee or designee at anytime while employed by University of Chicago by contacting Environmental Health and Safety Department. If the employee is no longer employed by the University, this request shall be in writing.

Monitoring Protocol

All monitoring techniques and practices performed shall follow the appropriate federal, state and local requirements. Monitoring shall be performed with accuracy at the 95% confidence level and within the margins of error required by the standard for the substance being monitored. A 25% margin of error shall be allowed for those substances, which are not regulated by a specific standard.

Corrective Actions

Employees and/or areas which are measured and found to be in excess of established exposure limits shall be evaluated to determine what corrective actions shall be implemented. To achieve compliance and ensure the safety and health of employees, administrative and engineering controls shall be implemented whenever feasible. When such controls are not feasible to achieve compliance, protective equipment or other protective measures shall be used to keep the exposures of the affected employee(s) within the established exposure limits.

Medical Consultation

Where exposure monitoring reveals an exposure level routinely above the action level or permissible exposure level for an OSHA regulated substance with exposure monitoring requirements, medical surveillance shall be established for the affected employee(s) as prescribed by the particular standard.

For additional information, refer to the CEE Department Safety Manual, Chemical Hygiene Plan, Section 5.9.

Water Testing

Environmental Health and Safety Department shall, upon request and as deemed necessary, test potable drinking water for the following constituents:

- Lead;
- PH;
- Turbidity; and
- Copper.

To request an evaluation of potable water in your area, contact Environmental Health and Safety Department at 543-7262.

Noise Sampling

To request an evaluation of the noise levels in your area, contact Environmental Health and Safety Department at 543-7262.

Indoor Air Quality

Upon suspicion of an indoor air quality issue, begin documenting the times, days, and symptoms when problems became evident and immediately contact Environmental Health and Safety Department at 543-7262.

4.5 Hazard Reporting and Investigation

Policy

Any Civil and Environmental Engineering employee who discovers a known or suspected hazardous condition shall immediately report the condition to his/her immediate supervisor and Environmental Health and Safety Department to seek resolution of the condition.

Purpose

The purpose of reporting a known or suspected hazardous condition is to identify and, if warranted, resolve the condition(s) to prevent minor/serious injury, loss of life or property.

Authority and Responsibility

Environmental Health and Safety Department is responsible for:

1. Investigating any alleged hazard(s);
2. Immediately resolving or developing corrective action plans, if necessary;
3. Ensuring implementation of corrective action plans through follow-up inspections;
4. Reporting all hazard evaluation requests, corrective action plans and current status to the University Safety Committee; and
5. Conducting training when deemed necessary.

Employees are responsible for:

1. Reporting any known or suspected hazardous condition(s);
2. Participating in the investigation;
3. Adhering to the corrective action plan; and
4. Participating in appropriate training as deemed necessary.

The *Safety Committee* is responsible for:

1. Reviewing hazard evaluation data for trends; and
2. Reviewing corrective action plans; and

Reporting Criteria

Life Threatening

Immediately report the condition to your supervisor and contact Environmental Health and Safety Department at 543-7262 or the University Police at 9-911.

A representative from Environmental Health and Safety Department will complete a copy of "Appendix A - Hazard Evaluation Request Form" during the investigation.

Non-Life Threatening

Inform your supervisor and complete Section 1 of Appendix A - Hazard Evaluation Request Form, which identifies your contact information, and a description of the alleged hazardous condition. Forward the entire form to:

Environmental Health and Safety Department
201 Hall Health Center, WA 354400

FAX: 543-3351

Once an investigation has been completed, either through the correction of the hazard or a notation that no hazard was detected, Environmental Health and Safety Department shall return a complete copy of the form to the requester.

4.6 Incident Report and Investigation

Policy

All work-related injuries, illnesses or incidents involving University employees, students or visitors shall be reported in accordance with this policy.

Notification

All University employees and students shall inform their immediate supervisor that a work related injury or illness was sustained.

Supervisors shall immediately notify Environmental Health and Safety Department of any incidents involving death or hospitalization.

Procedure

Emergency Medical Attention

1. For incidents occurring *on campus*, contact the University Police at 9-911 to arrange for on-scene medical assistance.
2. For incidents occurring *off campus*, dial 911 to arrange for medical assistance.

General Medical Attention

1. During normal business hours (Monday through Friday 8:00 a.m. to 5:00 p.m.), obtain medical attention from the UW Employee Health Center located in Hall Health, room G07-A.
2. After normal business hours (Monday through Friday after 5:00 p.m., weekends or holidays), obtain medical attention from the the UW Medical Center Emergency Room located at 1959 NE Pacific Street.
3. Always use the "buddy" system when obtaining general medical attention. The "buddy" system means having someone escort the injured individual to receive medical treatment.

Documentation

The supervisor in conjunction with the injured employee shall complete an OARS report (Online Accident Reporting System). <http://www.ehs.washington.edu/ohsoars/>

Investigation

As soon as feasible, the injured employee's supervisor shall conduct an investigation of the incident in conjunction with submitting the OARS report. Environmental Health and Safety Department shall review all submitted OARS reports and may also conduct investigations independent of the department as deemed necessary or as requested.

All corrective actions identified on the form shall be the responsibility of the supervisor and associated department. Environmental Health and Safety Department may be contacted for assistance in developing or implementing corrective action plans.

Proactive

All "unsafe" conditions in the workplace shall be reported to employee supervisors who in turn should contact Environmental Health and Safety Department to ensure "unsafe" conditions are corrected prior to an accident or incident.

Visitors

Report all accidents/incidents involving visitors or other persons who are not University employees to the University Police at 9-911 and Risk Management at 206-543-3773.

4.7 Personal Protective Equipment

Policy

Personal protective equipment including those for eyes, face, head, and extremities, protective clothing, respiratory devices, protective shields and barriers shall be provided, utilized and maintained in a sanitary and reliable condition whenever deemed necessary by reason of hazards, processes or environment.

Scope

This policy applies to all employees who by nature of their job function have the potential to be exposed or come into contact with chemical, physical, radiological or biological hazards which by this exposure can cause illness, injury or impairment in the function of any part of the body.

Authority and Responsibility

Immediate Supervisors are responsible for:

3. Ensuring personal protective equipment is available and providing personal protective equipment as required or upon request to all employees; and
4. Ensuring personal protective equipment is being used by each affected employee during all job tasks, which require such protection.

Environmental Health and Safety and *Departmental Administration* are responsible for:

5. Assessing the workplace to determine if hazards are present, or are likely to be present, which necessitate the use of personal protective equipment;
6. Communicating selection decisions to each affected employee;
7. Selecting personal protective equipment that properly fits each affected employee; and
8. Documenting aforementioned hazard assessment components utilizing Appendix A - Personal Protective Equipment Assessment.

Employees are responsible for:

3. Wearing personal protective equipment upon the direction of their immediate supervisor; and
4. Participating in training.

Considerations

Personal protective equipment devices alone shall not be relied on to provide protection against hazards, but shall be used in conjunction with guards, engineering controls, administration controls and sound manufacturing practices.

When selecting personal protective equipment, utilize the following considerations as a basic directive.

- Application: What part of the body is being protected?
- Chemical Resistance: Will material maintain its structural integrity and protective qualities?
- Strength: Is the material resistant to punctures, tears, and abrasions?
- Flexibility: Do gloves provide the necessary dexterity?
- Thermal Limits: Does clothing maintain its mobility and protective capacity in temperature extremes?
- Cleanable: Can material be easily cleaned and reused?
- Longevity: Will clothing resist aging?

Contact Environmental Health and Safety at 543-7262 for personal protective equipment product recommendations.

Hand Protection

Hand protection shall be worn when hands are exposed to hazards such as those from skin absorption of harmful substances, severe cuts or lacerations, severe abrasions, punctures, chemical burns, thermal burns and harmful temperature extremes.

The type of hand protection used shall be based on the performance characteristics of the hand protection relative to the task(s) to be performed, conditions present, duration of use, and the hazards and potential hazards identified.

With respect to selection of gloves for protection against chemical hazards:

5. The toxic properties of the chemical(s) must be determined; in particular, the ability of the chemical to cause local effects on the skin and/or to pass through the skin and cause systemic effects;
6. Generally, any "chemical resistant" glove can be used for dry powders;
7. For mixtures and formulated products (unless specific test data are available), a glove shall be selected on the basis of the chemical component with the shortest breakthrough time, since it is possible for solvents to carry active ingredients through polymeric materials; and
8. Employees shall be able to remove the gloves in such a manner as to prevent skin contamination.

Head Protection

Head protection shall be worn in areas where there is a potential for injury to the head from impact, flying or falling objects (e.g., working below other workers who are using tools and materials which could fall through grates), or electrical shock and burns.

Helmets for protection against impact and penetration of falling objects shall comply with the "American National Standard for Personal Protection - Protective Headwear for Industrial Workers Requirements" (ANSI) Z89.1. Helmets for protection against electrical shock and burns shall comply with ANSI Z89.2-1971.

Eye/Face Protection

Suitable eye protection or face protection shall be worn when there is the potential for exposure to the eyes or face from flying particles, molten metal, liquid chemicals, acid or caustic liquids, chemical gases or vapors or potentially injurious light radiation. Side protection is required when there is a hazard potential from flying objects. Detachable side protectors (e.g., clip-on or slide-on shields) meeting the pertinent requirements are acceptable.

Eye protection shall be durable, comfortable and easy to clean. Persons whose vision requires the use of corrective lenses and whom by nature of their job duties require eye protection shall wear goggles or a full-face shield that can be worn over the prescription lenses.

There are four general classes of eye and face protection: safety glasses, face shields, goggles and welding helmets. The type of protection required shall be determined by the type and degree of the hazard and shall comply with ANSI Z87.1-1989 "American National Standard Practice for Occupational and Educational Eye and Face Protection".

Safety glasses shall be worn at all times in the following locations:

- Academic and research laboratories;
- Facilities Services Shops (e.g., welding, carpentry, automotive);

- All areas where airborne materials are present; and
- Clinics where invasive patient related tasks are conducted.

Foot Protection

Foot protection shall be worn when there is the potential for injury to the feet from falling or rolling objects, objects piercing the sole of the foot, electrical hazards, hot surfaces and slippery surfaces.

Foot protection shall comply with ANSI Z-1991 "American National Standard for Personal Protection - Protective Footwear".

Respirators

Use of respirators shall be done in accordance with the Respiratory Protection Program, section 4.16.

Body Protection

Full body protection shall be worn when there is a potential for contamination or exposure to other parts of the body (e.g., legs, arms, back, chest) from heat, splashes from hot metals and liquids, impacts, cuts, chemicals and radiation.

Body protection includes the following:

- Lab coats;
- Boot covers;
- Aprons;
- Bouffant caps;
- Tyvek suits; and
- Coveralls.

Electrical Protective Devices

Rubber insulating equipment shall be used/worn to protect employees from shocks/burns while working on "live" electrical systems.

Rubber insulating equipment shall comply with the following American Society for Testing and Materials (ASTM) standards:

- Specification for Rubber Insulating Gloves (D120-87E1);
- Specification for Rubber Insulating Matting (ASTM D178-93 or D178-88);
- Specification for Rubber Insulating Blankets (ASTM D1048-93 or D1048-88a);
- Specification for Rubber Insulating Covers (ASTM D1049-93 or D1049-88);
- Specification for Rubber Insulating Line Hose (ASTM D1050-90); and
- Specification for Rubber Insulating Sleeves (ASTM D1051-87).

All electrical protective equipment shall be subjected to periodic electrical tests conducted in accordance with appropriate voltages identified by ASTM standards to

reliably indicate whether the insulating equipment can withstand the voltage involved. Insulating equipment failing to pass inspections or electrical tests shall NOT be used by employees.

Rubber insulating equipment test intervals shall occur as follows:

- Rubber insulating line hoses shall be tested upon indication that the insulating valve is suspect;
- Rubber insulating covers shall be tested upon indication that the insulating valve is suspect;
- Rubber insulating blankets shall be tested before first issue and every twelve months thereafter;
- Rubber insulating gloves shall be tested before first issue and every six months thereafter; and
- Rubber insulating sleeves shall be tested before first issue and every twelve months thereafter.

Note: If the insulating equipment has been electrically tested but not issued for service, it shall not be placed into service unless it has been electrically tested within the previous twelve months.

All departments using rubber-insulating equipment shall make the appropriate arrangements for testing of such equipment.

Maintenance Schedules

Personal protective equipment shall be inspected, cleaned and maintained at regular intervals so that the personal protective equipment can be discarded, changed and/or decontaminated as deemed necessary. At a minimum, all personal protective equipment shall be discarded when it has become contaminated, worn, torn or has other integrity problems.

Personal protective equipment provides the requisite protection. It is important to ensure that contaminated personal protective equipment which cannot be decontaminated is disposed in a manner that protects employees from exposure to hazards.

Note: Inspect personal protective equipment before each use for tears, punctures, holes, cuts, cracks, embedded foreign objects and texture changes (e.g., swelling, softening, hardening, becoming sticky or inelastic).

Training

Initial Training

Initial training shall be provided by Facilities Services - Safety and Environmental Affairs or the appropriate department for each employee who is required to use personal protective equipment. This training shall utilize the "Personal Protective Equipment" training booklet generated by Facilities Services - Safety and Environmental Affairs,

which shall be updated to ensure consistency with changes in protective equipment and work processes. Each employee shall be trained in at least the following:

- When personal protective equipment is necessary;
- What personal protective equipment is necessary;
- How to properly don, doff, adjust, and wear personal protective equipment;
- The limitations of the personal protective equipment; and
- The proper care, maintenance, useful life and disposal of the personal protective equipment.

Each affected employee shall demonstrate an understanding of the aforementioned training and the ability to use personal protective equipment properly before being allowed to perform work requiring the use of personal protective equipment.

Retraining

When there is reason to believe that any affected employee who has already been trained does not have the understanding and skill as required above, Facilities Services - Safety and Environmental Affairs or the affected department shall retrain each such employee. Circumstances where retraining is required include, but are not limited to, situations where:

- Changes in the workplace render previous training obsolete;
- Changes in the types of personal protective equipment to be used render previous training obsolete; or
- Inadequacies in an affected employee's knowledge or use of assigned personal protective equipment indicate that the employee has not retained the requisite understanding or skill.

Record keeping

Environmental Health and Safety shall verify that each affected employee has received and understood the required training through a written certification containing the name of each employee trained, the date(s) of training and the subject of the certification.

4.8 Hazard Communication

Please note that this program has a glossary. The glossary contains the definitions for various terms used in the program. These terms are highlighted in bold print the first time they appear in the body of the program.

Policy

All **employees** have both a need and right to know the hazards and identities of the **chemicals** they are exposed to when working as identified in the Hazard Communication Program, which provides safe work places for employees.

Scope

The Hazard Communication Program establishes requirements for informing University employees who work with or are exposed to **hazardous chemicals** of the **physical and health hazards** posed by those materials. This applies to any chemical that is known to be present in the **workplace** in such a manner that employees may be exposed under normal conditions of use or in a **foreseeable emergency**.

Exception

This applies to laboratories only as follows:

1. Employers shall ensure that labels on incoming **containers** of hazardous chemicals are not removed or defaced;
2. Employers shall maintain all **Material Safety Data Sheets (MSDS)** for incoming containers of hazardous chemicals and ensure that they are readily accessible to employees;
3. Employers shall ensure that employees are provided information and training on the associated hazards of chemicals in their workplace; and
4. Laboratory employers that ship hazardous chemicals are considered to be either a chemical manufacturer or a distributor under this rule, and thus must ensure that any containers leaving the laboratory are labeled in accordance with the labeling requirements of this document and that a material safety data sheet is provided to distributors and other employers.

Refer to the CEE Safety Manual, Chemical Hygiene Plan, Section 5.9 for specific requirements affecting laboratory employees.

For additional exceptions to this policy, please refer to Appendix A.

Authority and Responsibility

Environmental Health and Safety Department has the primary responsibility and authority for the implementation and enforcement of the Hazard Communication Program and is responsible for:

1. Reviewing and revising the Hazard Communication Program annually to assure compliance;
2. Providing general information and training relating to Hazard Communication for affected University employees;
3. Maintaining and updating the MSDS Program;
4. Developing and implementing a universal hazardous chemical labeling system;
5. Establishing emergency procedures to properly handle hazardous material releases (refer to the University's Emergency Response Plan for Hazardous Materials, Section 1.7); and
6. Identification of appropriate personal protective equipment (PPE).

Department Supervisors are responsible for:

1. Notifying all employees of the purpose and intent of the Hazard Communication Program;
2. Assuring that affected employees are trained in General Hazard Communication;
3. Providing department specific information and training relating to Hazard Communication for affected University employees; and
4. Providing personal protective equipment.

Affected *Employees* are responsible for:

1. Complying with the Hazard Communication Program procedures;
2. Participating in the University's General Hazard Communication training session and Department specific training sessions;
3. Understanding how to read chemical labels and Material Safety Data Sheets;
4. Understanding and taking necessary precautions when handling hazardous chemicals; and
5. Using personal protective equipment.

Information and Training

Employees shall receive information and training on hazardous chemical in their work area at the time of their initial assignment, and whenever a new physical or health hazard the employees have not previously been trained about is introduced into their work area. Information and training may be designed to cover categories of hazards (i.e., flammability, carcinogenicity) or specific chemicals. Chemical-specific information shall always be available through labels and material safety data sheets. Environmental Health and Safety Department shall provide all General Hazard Communication Training.

This general training program shall provide an introduction to the following:

- The requirements of the standard;
- Any operations in their work area where hazardous chemicals are present;
- The location and availability of the written Hazard Communication Program;

- The details of the Hazard Communication program including an explanation of the labeling system and the material safety data sheet and how employees can obtain and use the appropriate hazard information;
- Methods and observations that may be used to detect the presence or release of a hazardous chemical in the work area;
- The physical and health hazards of the chemicals in the work area; and
- The measures employees can take to protect themselves from these hazards, including work practice controls, emergency procedures and personal protective equipment.

Department specific training shall be conducted upon employment, and whenever a new hazard (i.e., new class of chemical hazards, a change in assignment or a new process which may be hazardous) is introduced into an employee's **work area**. Department specific Hazard Communication Training shall include information on:

- a. Specific chemical hazard classes found in the work area;
- b. Location of the University's Hazard Communication Program within the department;
- c. Specific location and availability of the department's Material Safety Data Sheets;
- d. Available personal protective equipment (see Section 5.7 for additional information) and appropriate emergency procedures for chemicals found within the work area as outlined by the Material Safety Data Sheets; and
- e. Location and availability of appropriate chemical labels.

Material Safety Data Sheets

Material Safety Data Sheets are the primary data source intended to outline the special precautions and controls necessary for handling specific hazardous chemicals. Material Safety Data Sheets are typically provided by the chemical manufacturer or chemical supplier and usually divided into several different sections, approximately 8 to 10 sections. The different sections of an MSDS may vary slightly from manufacturer to manufacturer (i.e., section titles and section order), but each MSDS shall contain the following information:

- Chemical identification;
- Physical and chemical characteristics;
- Physical hazards;
- Health hazards;
- Primary routes of entry;
- Occupation Safety and Health Administrations (OSHA's) **permissible exposure limit (PEL)**;
- Carcinogenicity;
- Generally applicable precautions for safe handling and use;
- Generally applicable control measures;
- Emergency and first aid procedures;
- Date of preparation;

- Name, address and telephone number of the chemical manufacturer; and
- Disposal procedures.

Obtaining MSDSs

Material Safety Data Sheets are readily available upon request 24 hours a day and shall be accessible by one of the following methods:

- Accessing the University on-line account with CCINFO (refer to Appendix B);
- Contacting the chemical manufacturer; or
- Contacting Environmental Health and Safety Department at 543-7262 (information provided within 24 hours of the request).

Labeling

To ensure that appropriate information concerning the hazards of a chemical are accessible to employees, all containers of hazardous chemicals shall be labeled. Labels shall be legible, in English (additional languages may be included as necessary), and prominently displayed on the container. Chemical manufacturers, importers, and distributors shall ensure that every container of hazardous chemicals entering the workplace is appropriately labeled with the identity of the hazardous chemical(s) (common and/or **chemical name**), appropriate hazard warnings; and the name and address of the chemical manufacturer, importer or other responsible party.

If a chemical label in the workplace becomes damaged, illegible, or is inadvertently removed from a container, it shall be replaced immediately by the supervisor or designee.

Replacement labels shall include, at a minimum, the identity of the hazardous chemical(s) (common and/or chemical name), appropriate hazard warnings or alternatively, words, pictures, symbols or combination thereof, which provide at least the general information regarding the hazards of the chemicals.

Chemicals which are transferred from the original container into a secondary container shall be identified by a label on the secondary container. *Exception:* A secondary container is not required to be labeled if the material will be completely used during that employee's work shift; however, Environmental Health and Safety Department strongly recommends that all secondary containers be labeled despite this exception.

To comply with labeling requirements, the University has adopted the National Fire Protection Association (NFPA) labeling system.

Call (617) 770 – 3000 for information related to labels.

The following colors are used to represent the hazards on the NFPA label:

- a. Red represents the fire hazard;
- b. Blue represents the health hazard;

- c. Yellow represents the reactivity hazard; and
- d. White represents the specific hazard.

The University is in the process of phasing out use of the NFPA labeling system, and is adopting the Globally Harmonized System (GHS) for chemical labeling and hazard communication.

Glossary

Chemical: Any element, chemical compound or mixture of elements obtained by a chemical process or used for producing a chemical effect.

Chemical Name: The scientific designation of a chemical in accordance with the nomenclature system developed by the International Union of Pure and Applied Chemistry (IUPAC) or the Chemical Abstracts Service (CAS) rules of nomenclature, or a name which will clearly identify the chemical for the purpose of conducting a hazard evaluation.

Container: Any bag, barrel, bottle, box, can, cylinder, drum, reaction vessel, storage tank, or the like that contains a hazardous chemical.

Employee: A worker who may be exposed to hazardous chemicals under normal operating conditions or in foreseeable emergencies. Workers such as office workers who encounter hazardous chemicals only in non-routine, isolated instances are not included.

Foreseeable Emergency: Any potential occurrence such as, but not limited to, equipment failure, rupture of containers, or failure of control equipment that could result in an uncontrolled release of a hazardous chemical into the workplace.

Hazardous Chemical: Any chemical, which is a physical, or health hazard.

Health Hazard: A chemical for which there is statistically significant evidence based on at least one study conducted in accordance with established scientific principles that acute or chronic health effects may occur in exposed employees. The term "health hazard" includes chemicals which are carcinogens, toxic or highly toxic agents, reproductive toxins, irritants, corrosives, sensitizers, hepatotoxins (liver damage), nephrotoxins (kidney damage), neurotoxins (nervous system damage), agents which act on the hematopoietic system (decreases hemoglobin function), and agents which damage the lungs, skin, eyes, or mucous membranes.

Material Safety Data Sheet (MSDS): Written or printed material concerning a hazardous chemical that is prepared in accordance with 29 CFR 1910.1200 (g).

Permissible Exposure Limit (PEL): An exposure limit established and enforced by the Occupational Safety and Health Administration (OSHA) which may be expressed as a

time-weighted average (TWA) limit, short term exposure limit (STEL), or ceiling exposure limit.

Physical Hazard: A chemical for which there is scientifically valid evidence that it is a combustible liquid, compressed gas, explosive, flammable, organic peroxide, oxidizer, pyrophoric, unstable (reactive), or water-reactive.

Work Area: A room or defined space in a workplace where hazardous chemicals are produced or used and where employees are present.

4.9 Chemical Hygiene

Please note that this program has a [glossary](#). The glossary contains the definitions for various terms used in the program. These terms are highlighted in bold print the first time they appear in the body of the program.

Policy

All laboratories engaged in the **laboratory use** of hazardous chemicals or other facility which operates on a **laboratory scale** shall adhere to the requirements stated in the **Chemical Hygiene Plan** and all related programs in the Safety Manual.

Exceptions

The "Occupational exposure to hazardous chemicals in laboratories" 29 CFR 1910.1450 does not apply to the following:

- Use of hazardous chemicals which do not meet the definition of laboratory use; and
- Laboratory use of hazardous chemical, which provide no potential for employee exposure. Examples of such conditions might include:
 - Procedures using chemically-impregnated test media such as Dip-and-Read tests where a reagent strip is dipped into the specimen to be tested and the results are interpreted by comparing the color reaction to a color chart supplied by the manufacturer of the test strip; and
 - Commercially prepared kits such as those used in performing pregnancy tests in which all of the reagents needed to conduct the test are contained in the kit.

Authority and Responsibility

The University's **Chemical Hygiene Officer** shall be responsible for:

1. Conducting annual and periodic Laboratory Reviews;
2. Developing and implementing a chemical inventory and monitoring program;
3. Identifying and monitoring corrective action plans;
4. Reviewing laboratory designs;
5. Assessing of **personal protective equipment**;

6. Developing and conducting Laboratory Safety training;
7. Managing the University's **Material Safety Data Sheet (MSDS)** Program;
8. Complying with environmental regulations regarding management of hazardous waste generated by laboratories;
9. Providing guidance and acting as a resource to departmental safety committees and personnel;
10. Ensuring compliance with all components of the Chemical Hygiene Plan;
11. Complying with the requirements of the University's Chemical Hygiene Plan and all relevant sections of this manual;
12. Ensuring that the laboratory personnel follow the requirements set forth in the Chemical Hygiene Plan;
13. Providing a safe and healthy work environment for all laboratory personnel;
14. Complying with all other applicable programs affecting the health and safety of laboratory personnel; and
15. Assisting in the development of **laboratory** specific standard operating procedures.

Laboratory personnel shall be responsible for:

1. Developing laboratory specific standard operating procedures;
2. Conducting all laboratory work in accordance with the standard operating procedures;
3. Developing good personal chemical hygiene habits; and
4. Notifying the **laboratory director** and Environmental Health and Safety Department of any incidents involving material releases, unsafe conditions and other adverse health, safety and environmental conditions.

Laboratory technicians/supervisor are responsible for:

1. The overall responsibility for chemical hygiene in the laboratory;
2. Ensuring that workers know and follow the chemical hygiene rules, that protective equipment is available and in working order and that appropriate training has been provided;
3. Providing regular chemical hygiene and housekeeping inspections including routine inspections of emergency equipment;
4. Knowing the current legal requirements concerning regulated substances;
5. Determining the required levels of protective apparel and equipment; and
6. Ensuring that facilities and training for use of any material being ordered are adequate.

Reference Location

Environmental Health and Safety Department shall maintain an extensive reference library that is available for the use by interested individuals.

Chemical Hygiene Plans

Each laboratory supervisor/technician shall establish laboratory specific standard operating procedures in accordance with this program. Procedures shall be maintained and updated by the laboratory supervisor as necessary and be available for review upon request by representative of Environmental Health and Safety Department and/or a regulatory agencies. The procedures shall contain at a minimum the following sections:

1. List of personnel working within the laboratory;
2. Emergencies:
 - Listing of important phone numbers in the event of an emergency;
 - Emergency procedures for chemical and/or biological spills;
 - Procedures for personal injury; and
 - Procedures for security violations;
3. Access restrictions into the laboratory;
4. Standard Operating Procedures:
 - Use of personal protective equipment;
 - Work practices;
 - Personal hygiene practices;
 - Special procedures and precautions;
 - Methods for deviation from standard operating procedures;
 - Development of new procedure requirements/review;
 - Medical consultation and surveillance and names of personnel affected;
 - Control measures (e.g., storage, housekeeping, inventories, labeling, use of containment devices, respirators, ventilation)
 - Housekeeping procedures and requirements;
 - Chemical inventory updating procedures and submission dates to Environmental Health and Safety Department;
 - Segregation procedures for storage of **hazardous chemicals** and hazardous waste within the laboratory;
 - Refrigeration storage procedures for chemicals and biological;
 - Use of fume hoods and biological safety cabinets;
 - Visitor procedures;
 - **Employee** training;
 - List of dates and names of those personnel who have gone through laboratory safety training; and
 - Laboratory policy concerning frequency and mandatory requirement of training signed by the laboratory supervisor.
5. Special procedures for dealing with flammable, corrosive, **reactive**, toxic and carcinogenic chemicals and common symptoms of overexposure; and
6. Emergency Equipment:
 - Testing and use of eyewash/shower stations;
 - Evaluation of fire extinguishers and use; and
 - Fire drill frequency.

Standard operating procedures may be applicable to more than one laboratory or may encompass an entire department only if the standard operating procedures and methods to control exposures are identical within each laboratory.

Each laboratory's standard operating procedures shall be reviewed at least annually by Environmental Health and Safety Department during Annual Laboratory Safety Inspections. Laboratories shall also retain a copy of the University's Chemical Hygiene Plan in each laboratory for immediate use by employees. Each laboratory shall receive updates to the Chemical Hygiene Plan as they become available.

Each lab shall develop and adhere to the following minimum standard operating procedures.

Personal Protective Equipment (PPE)

Use of personal protective equipment shall be evaluated for all existing and proposed laboratory work in accordance with the Personal Protective Equipment policy, Sections 4.10 or 5.7. Those employees who are exposed to hazards shall use personal protective equipment and participate in training on the proper use, limitations, maintenance and storage of such equipment.

At a minimum, the following personal protective equipment shall be worn by all **laboratory employees** engaged in the handling and use of hazardous chemicals:

1. Eye protection;
2. Laboratory coats/aprons; and
3. Shoes with full uppers (no open-toed shoes or sandals).

These are minimum requirements for personal protective equipment. Additional personal protective equipment shall be utilized as warranted by a specific hazard. Contact Environmental Health and Safety Department prior to conducting such work for assistance in the identification of additional personal protective equipment.

Respirators

Use of respirators shall be done in accordance with the Respiratory Protection Program, Section 4.16.

Fume Hoods

Fume hood use and maintenance shall be in accordance with the Chemical Fume Hoods policy, Section 5.13 of the Department's Safety Manual.

Biological Safety

The biological safety section of this program is Section 6. Additional information can also be obtained from Environmental Health and Safety Department.

Biological Safety Cabinets

Biological Safety Cabinets shall be used and maintained in accordance with the Biological Safety Cabinets policy, Sections 6.5 and 6.6 of this Safety Manual.

Chemical Segregation

Segregation of laboratory chemicals shall be done in accordance with the following segregation scheme or an equally effective system developed by the laboratory supervisor or department.

Class 1	Flammable or combustible and not highly toxic; flammable or combustible and toxic; peroxidizable; provided in all cases the chemical is compatible with water
Class 2	Identical to class 1 except that all in this class are not compatible with water
Class 3	Oxidizing agents and nonflammable/combustible, not highly toxic; oxidizing agents and nonflammable/combustible that are toxic; each compatible with water
Class 4	Identical to class 3 except none compatible with water
Class 5	Air sensitive and not highly toxic; air sensitive and toxic
Class 6	Require refrigeration and not highly toxic; require such storage and toxic
Class 7	Compressed gas cylinders and other gas containers, divided into four subclasses: oxidizing agents, reducing agents, corrosives and highly toxic substances; each subdivided into two subclasses, empty and full
Class 8	Unstable chemicals (e.g., explosive, short shelf life)

The segregation schematic in no means is a foolproof system for chemical segregation; however, it is far superior over the alphabetical and inorganic/organic systems.

Laboratory Hygiene

All laboratories shall establish procedures, which provide for and ensure proper laboratory hygiene. These practices shall include the following:

1. Food or drink shall **NOT** be stored or consumed within laboratories;
2. Smoking is prohibited;
3. Applying cosmetics is prohibited;
4. Eye protection shall be worn at all times in laboratories;
5. Laboratory coats/aprons shall be used during chemical manipulations;
6. Contact lens shall be prohibited unless vent-less goggles are used;
7. Laboratory clothing shall cover the legs and not be loose or flowing;
8. Mouth pipetting is prohibited;
9. Open-toed shoes (e.g., sandals) are prohibited;
10. Hand washing before taking breaks and at the end of each day; and
11. Secure hair back and off the shoulders.

Material Safety Data Sheets (MSDS)

Environmental Health and Safety Department maintains over 150,000 MSDSs on file which are updated quarterly. MSDSs can also be obtained by any of the methods listed in the Hazard Communication Program, Section 5.8 of this Safety Manual.

Transportation of Chemicals

For additional information regarding the shipment of hazardous materials off-site, refer to the Hazardous Materials Transportation program, Section 5.2 of this Safety Manual.

Housekeeping

Housekeeping shall be performed continuously. The laboratory work area shall be kept neat and orderly including the following general practices:

1. All waste shall be properly labeled and segregated;
2. All working surfaces shall be cleaned on a regular schedule;
3. Chemicals shall not be stored on floors, in aisles, stairwells or hallways; and
4. Access to emergency equipment shall remain clear at all times.

Glassware

Glassware that is broken, cracked or chipped shall not be used. Pipettes shall not protrude from bottles, flasks or beakers. When stoppers are stuck on gas tubing, do **not** attempt to force removal but instead cut them off. Glassware shall be decontaminated after exposure to potentially harmful substances such as infectious agents or chemical agents. Dispose of broken glass in a labeled puncture-proof container.

Working Alone

Avoid working alone in a laboratory if the procedures being conducted are hazardous.

Refrigerators/Cold Rooms

Use of refrigerators and cold rooms shall be done in accordance with the requirements stated below:

1. Storage of flammable liquids is permitted only in flammable material or explosion safe/proof refrigerators;
2. Each refrigerator shall be labeled stating whether it is or is not suitable for storing flammable liquids; and
3. Cold rooms shall be maintained in an orderly manner and shall not be used to store chemicals.

Labels and Signs

All containers of hazardous chemicals shall be provided with **labels** in accordance with the labeling procedure detailed in the Hazard Communication Program, Section 5.8 and additional requirements stated in this program.

Signage within laboratories shall be unobstructed at all times and written in English. Signage requirements shall be evaluated during annual inspections. Contact

Environmental Health and Safety Department for signage recommendations and requirements.

Identification Data Cards

Each laboratory is required to have a laboratory identification data card posted at each corridor entrance to the laboratory. The data card displays information concerning laboratory responsibility, hazards located within the laboratory and unattended operations in process. Each card shall be updated annually. A representative from Environmental Health and Safety Department will issue a form to update the identification card as part of the annual laboratory review program.

Waste Disposal

Refer to the Hazardous Materials Management program, section 5.12 of this Safety Manual.

Chemical Inventories

Refer to the Chemical Inventories program, section 5.11 of this Safety Manual.

General Emergency Procedures

For specific information pertaining to a chemical or infectious agent spill, refer to the Emergency Quick Reference, Section 1.2 for Chemical Spills and Section 1.5 for Biohazard Infectious Response.

Exposure Monitoring

For laboratory uses of OSHA regulated substances, the employer shall assure that laboratory employee's exposure to such substances do not exceed the permissible exposure limits specified in 29 CFR part 1910 subpart Z.

For specific information pertaining to chemical exposure monitoring, refer to the Chemical and Physical Hazards Monitoring Program, Section 5.4.

Medical Surveillance

Medical examinations shall be conducted by a physician at the Primary Care Group or personal health care provider for any employee under the following circumstances:

1. Whenever an employee develops signs or symptoms associated with exposure to a hazardous chemical(s) used in the laboratory;
2. Where exposure monitoring reveals an exposure level routinely above the action level (or in the absence of an action, level the permissible exposure level) for an OSHA regulated substance for which there are exposure monitoring and medical surveillance requirements; or
3. Whenever an event takes place in the work area such as a spill, leak, explosion or other occurrence resulting in the likelihood of a hazardous exposure.

When reporting a known or suspected overexposure to a hazardous chemical, follow the procedure detailed in the Incident Reporting and Investigation Program, section 5.6 of this Safety Manual.

All medical examinations shall be performed by or under the direct supervision of a licensed physician at Primary Care Group.

Facilities Services - Safety and Environmental Affairs shall provide the following information to a physician:

1. The identity of the hazardous chemical(s) to which the employee may have been exposed;
2. A description of the conditions under which the exposure occurred including quantitative exposure data, if available; and
3. A description of the signs and symptoms of exposure that the employee is experiencing, if any.

Upon consultation and/or examination, the physician shall provide a written opinion including the following:

1. Any recommendations for further medical follow-up;
2. Results of medical examinations and any associated tests;
3. Any medical condition which may be revealed in the course of the examination which may place the employee at increased risk as a result of exposure to a hazardous chemical found in the workplace;
4. A statement that the employee has been informed by the physician of the results of the consultation or medical examination and any medical condition that may require further examination or treatment; and
5. The written opinion shall not reveal specific findings of diagnoses unrelated to occupational exposure.

Information and Training

The laboratory director shall ensure that the laboratory employees are aware of the hazards of chemicals present in their work area.

Training shall be conducted at the time of the laboratory employee's initial assignment to a work area where hazardous chemicals are present and prior to assignments involving new exposure situations. Training specific to laboratory protocols shall be provided by the laboratory director or designee on a regular, ongoing basis. Facilities Services - Safety and Environmental Affairs shall be responsible for providing initial training on general laboratory safety.

Glossary

Chemical Hygiene Officer: The designated, qualified employee who assists in the development, implementation and monitoring of compliance with the Chemical Hygiene Plan.

Chemical Hygiene Plan: A written program that includes specific work practices, standard operating procedures, equipment, engineering controls and policies to ensure that employees are protected from hazardous exposure levels to all potentially hazardous chemicals in use within their work areas.

Compressed Gas: Any material which is a gas at normal temperature and pressure, and which is contained under pressure as a dissolved gas or liquefied by compression or refrigeration.

Employee: An individual employed in a laboratory workplace who may be exposed to hazardous chemicals in the course of his or her assignments.

Laboratory Employee: Individuals employed in a laboratory work place who may be exposed to chemical hazards in the course of an assignment.

Hazardous Chemical: Any chemical, which is a physical, or health hazard.

Health Hazard: A chemical for which there is statistically significant evidence based on at least one study conducted in accordance with established scientific principles that acute or chronic health effects may occur in exposed employees. The term "health hazard" includes chemicals which are carcinogens, toxic agents, reproductive toxins, irritants, corrosives, sensitizers, hepatotoxins (liver damage), nephrotoxins (kidney damage), neurotoxins (nervous system damage), agents which act on the hematopoietic system (decreases hemoglobin function), and agents which damage the lungs, skin, eyes, or mucous membranes.

Label: Any written or printed words, pictures, symbols or combination thereof displayed on or affixed to a hazardous chemical container which conveys the name of the hazardous material, appropriate hazard warning(s), and the name and address of the chemical manufacturer, importer or other responsible party.

Laboratory: A facility where the "laboratory use" (relatively small quantities of hazardous chemicals are used in a non-production basis) of hazardous chemicals occurs.

Laboratory Director: An individual who supervises or manages a laboratory.

Laboratory Scale: Work involving containers of substances used for reactions and transfers that are designed for easy and safe handling by one person. Work places that produce commercial quantities of materials are excluded from the definition of "Laboratory Scale".

Laboratory Use: Utilization of hazardous chemicals based on ALL of the following conditions:

- Chemical manipulations are carried out on a "laboratory scale";
- Multiple chemical procedures or chemicals are used;
- The procedures involved are not part of a production process, nor in any way simulate a production process; and
- "Protective Laboratory Practices and Equipment" are available, and in common use, to minimize the potential for employee exposure to hazardous chemicals.

Material Safety Data Sheet (MSDS): Written or printed material concerning a hazardous chemical, which is prepared in accordance with 29 CFR 1910.1200 (g) "Hazard Communication".

Permissible Exposure Limit (PEL): An exposure limit established and enforced by the Occupational Safety and Health Administration (OSHA) which may be expressed as a time-weighted average (TWA) limit, short term exposure limit (STEL) or ceiling exposure limit (C).

Personal Protective Equipment (PPE): Devices or clothing worn to help protect a worker from direct exposure to hazardous materials.

4.10 Chemical Inventories

Policy

A current chemical inventory shall be maintained for each location that stores hazardous materials at the University and off-site locations under the University's jurisdiction.

Authority and Responsibility

Environmental Health and Safety department is responsible for:

1. Reviewing all submitted inventories and determining compliance with applicable reporting regulations;
2. Identifying all materials that could pose a health, safety or environmental hazard in the event of an uncontrolled release;
3. Conducting surveys and audits as deemed necessary; and
4. Providing annual inventory summaries to locations that submitted previous inventories.

Departments, Immediate Supervisors and Principal Investigators are responsible for:

1. Submitting a chemical inventory for each location under their responsibility upon the request of Environmental Health and Safety department;
2. Providing complete and accurate information; and

3. Updating inventories whenever new chemicals are purchased or old chemicals are removed.

Submission Requirements

All locations that store chemicals or other hazardous materials are required to keep a current inventory. A hazardous material is defined as any material listed by the Federal or State Environmental Protection Agency or any material that exhibits one or a combination of the following characteristics: flammable, corrosive, toxic and/or reactive. The inventory shall list the following:

1. Location where materials are stored;
2. Date of most recent update;
3. Responsible department and principal investigator or immediate supervisor; and
4. Material name and quantity.

Chemical inventories shall be submitted to Environmental Health and Safety department upon request of the information. Environmental Health and Safety department shall return all previously submitted inventories to each reporting location following annual laboratory reviews.

Any additions, deletions or other changes shall be marked directly on the form(s) and the form shall be returned to Environmental Health and Safety department by the required submission date. If the inventory has not changed, please note this on the form. All data shall be tracked and updated upon receipt.

Instructions for Completion

For completion of all chemical inventories, adhere to the following:

1. Print or type all new entries on the bottom of the list;
2. Make a separate copy of the checklist for each room, laboratory or shop;
3. Do not include research materials that are not hazardous and in a quantity equal to or less than 500 grams or 500 milliliters.

4.11 Hazardous Materials Management

Policy

All hazardous waste shall be managed in accordance with federal, state and local regulations.

Waste Minimization

In an effort to reduce the amount of chemicals needing disposal, the following guidelines shall be followed:

1. Only purchase what is needed for a three to six month period;
2. If practical, use non-hazardous materials;

3. If the chemical is still useful, recycle the waste instead of disposing of it by finding an associate that could use the remainder of the chemical;
4. If the material can be safely neutralized at the point of use, then do so;
5. The contractor providing disposal services shall segregate chemical waste from non-hazardous waste.

Hazardous Material Disposal

The United States Environmental Protection Agency (USEPA) has developed a listing of chemicals considered to be hazardous. These chemicals include spent solvents, poisons and corrosives. If a chemical exhibits any one of the following characteristics, the chemical would be considered hazardous.

1. Ignitable
2. Corrosive
3. Reactive
4. Toxic

Disposal of these materials into sinks, drains, commodes or other sewage disposal channels is **STRICTLY PROHIBITED**.

Disposal Procedures

Waste shall be collected from the area in which the waste is located. If special access arrangements or instructions are needed, provide this information when making arrangements for a chemical pick-up.

Note: If the waste is accumulated by the generator at the point of generation, prior to removal by the disposal contractor, no more than 55 gallons of a hazardous chemical and only one-pound of an acutely hazardous chemical can be accumulated.

Hazardous Material Waste Form

The generator prior to a waste pick-up shall complete form UoW 1470 or 1471 and labels (forms and labels can get at www.ehs.washington.edu). A copy of this form shall be provided to the person(s) removing the waste for disposal. Waste will not be collected without the completion of the form. Each type of waste and associated quantity shall be listed as accurately as possible.

Labeling

All hazardous waste containers shall be properly labeled to indicate the type of material contained in the container. Containers of hazardous waste that are not labeled in accordance with this policy shall not be removed from the area until such label is affixed to the container. If the contents of the container are unknown, please indicate this on the label.

Packaging

All hazardous waste shall be packaged in accordance with the following instructions.

1. Use a leak-proof container that will safely contain the contents. Chemical flasks, plastic bags or culture dishes will not be accepted. Containers must be closable.
2. The container shall not be overfilled with liquid waste. Empty space of at least five percent of the container volume shall be left to allow for thermal expansion.
3. Be suspicious of any pressure build-up inside the container. If this is a concern when closing the container, do not secure the cap tightly and if appropriate, place the container inside a fume hood or other well ventilated area until the chemical is removed by the waste collector.
4. If a safety can(s) or re-usable container(s) is used, write your location on the can with a permanent marker to ensure the return of your safety can within one week.
5. Old cans of ether, picric acid and other peroxide forming compounds shall be left in place and not moved until the waste collector has evaluated the condition of the container.
6. If waste is accumulated over time, list the accumulation start date and disposal date on the container.

Scintillation Vials

These are de-regulated vials if they are below 0.05 microcuries per milliliter and shall be disposed of in accordance with this program. All other vials greater than 0.05 microcuries per milliliter shall be disposed of through the Environmental Health and Safety department (543-7262).

Mixed Waste

If mixed waste such as a radioactive compound combined with an infectious agent is being generated, Environmental Health and Safety department and/or the Radiation Safety Office (543-0463) shall be contacted to determine the proper disposal procedure.

Storage Areas

Hazardous waste shall be stored according to the Chemical Hygiene Plan, Section 5.9 of this Safety Manual.

4.12 Chemical Fume Hoods

Policy

Facilities Services - Safety and Environmental Affairs shall assist with certifying and maintaining all chemical and horizontal/vertical laminar flow hoods and provide assistance in purchasing and system design of new hoods. Refer to Section 6.5 for biological safety cabinet requirements and procedures.

Fume Hood Requirements

Velocity Requirements

A standardized face velocity for hoods has not been established, but a common recommendation has been in place for over 25 years. The following face velocities are used at the University of Chicago and are based on the type of materials used within the hood. Please contact UW EH&S fume hood service for guidance: 206-221-5549

Minimum Face Velocity Based on Material Used:

- Low Toxicity Levels 100 feet per minute (fpm);
- Average Level Toxins 100 fpm;
- Low level radioactive tracer materials with normal toxic hazards 100 fpm;
- Significant chemical toxicity levels and moderate radioactive materials 100 fpm; and
- Higher levels of toxicity and highly radioactive materials 100 fpm.

Hoods shall ventilate by a dedicated exhaust fan with ducts leading directly from the hood to the roof. Horizontal ducts shall be pitched down to prevent accumulations of vapors in low spots. Duct velocities shall be maintained high enough to minimize the trapping of vapors in the exhaust system. Terminal exhaust points shall be located at least 25 feet from any possible air intake (e.g., air intake grills, doors, operable windows) and positioned at a height that allows adequate dispersion of fumes.

General Information

A newly installed or modified hood exhausting vapors from a continuing process that is left unattended shall have an air flow switch connected to a visible and audible warning device.

Appropriate safeguards shall be provided for flammable and explosive agents vented through the hood (e.g., explosion-proof motors and control, scrubber units, biohazard filters).

NOTE: The use of perchloric acid is prohibited unless the hood has been designed for its specific use and manipulation.

Certification

All fume hoods shall be inspected and certified annually to determine a proper face velocity of 100 fpm. The airflow into and within the hood shall not be excessively turbulent (200 fpm). These hoods shall be checked by representatives from Facilities Services - Safety and Environmental Affairs on an annual basis during laboratory reviews. All hoods functioning properly shall have a certification label affixed to the sash height at which the hood was certified by UW EH&S.

Hood Usage

When using a fume hood, the following considerations shall apply:

9. Fume hoods shall not be used to store chemicals or other materials;
10. Avoid potential exposures by not putting any part of your body with the exception of hands and forearms into the hood;
11. During manipulation and operation within the hood, sashes shall be kept at or below the certification sticker height to ensure proper air flow and protection of the use;
12. Filters shall be maintained as recommended by the manufacturer;

13. If any hood is suspected of not operating properly, discontinue use of the hood and contact Facilities Services at 206-685-1411 to arrange for testing of the hood(s);
14. Do not use hoods, which have not been certified. To have a hood certified, contact Facilities Services;
15. If the hood is covered with materials to protect light sensitive substances, then an opening not less than that which can be considered safe for operation shall be maintained; and
16. Hoods equipped with automatic alarms shall be inspected by the user more frequently than once per year and the frequency of this testing should be based on hood usage.

Inspection Process

A two-step process shall be used when inspecting a hood to validate proper working condition.

Step 1. Inspection of Hood

A complete inspection both inside and outside the hood shall be performed by the inspector evaluating the following:

7. Use of proper materials designed for that hood;
8. Excessive storage of any materials inside hood;
9. Physical damage to the hood;
10. Items that should not be inside the hood;
11. The ability of the sash to open, close and stay in a stationary position; and
12. Proper function of the hood flow indicator and alarm, if present.

Step 2. Determination of the Hood's Face Velocity

The face velocity of the hood shall be determined by using a velocity meter or other approved device using the low setting or low probe setting. The fume hood must first be emptied to facilitate access.

When using a velocity meter to determine face velocity, the unit shall be placed at a nine-point schematic in order to determine the average flow rate of the hood.

This shall be done with the sash in its fullest raised position. (Refer to diagram 1.1 below.)

Diagram 1.1

1	2	3
4	5	6
7	8	9

If the hood fails to meet the required face velocity with the sash open to its fullest position, the sash shall be lowered and the hood re-tested. This process shall be performed until the hood meets the required feet per minute rating.

Note: The sash cannot be lowered to a point less than 12 inches from the base of the sash opening.

Once inspection is completed, a certification sticker indicating the date of inspection and face velocity in feet per minute shall be placed at the point the sash was adjusted to reach certification.

If a hood fails certification, a warning sign shall be placed at a prominent location on the sash of the hood.

This sign shall **ONLY** be removed by UW Environmental Health and Safety once the hood has passed certification requirements.

4.13 Gas Cylinder Safety

Background Information

This document contains basic guidelines and rules to help ensure the safe handling and storage of compressed gas cylinders. Compressed gases are used in a variety of CEE programs such as instructional and research laboratories, teaching laboratories, and welding. Compressed gases serve the university in many ways, but gases under high pressure also present a number of hazards.

Mishandled cylinders may rupture violently, release their hazardous contents or become dangerous projectiles. If a neck of a pressurized cylinder should be accidentally broken off, the energy released would be sufficient to propel the cylinder to over three-quarters of a mile in height. A standard 250 cubic foot cylinder pressurized to 2,500 PSIG can become a rocket attaining a speed of over 30 miles per hour in a fraction of a second after venting from the broken cylinder connection.

Basic Safety:

- If a cylinder is damaged, in poor condition, leaking, or the contents are unknown, contact your cylinder vendor. Have the vendor return the damaged cylinder to the manufacturer.
- Wear appropriate foot protection when engaged in moving or transporting cylinders.
 - Sturdy shoes are a minimum.
 - Steel toed shoes if required by your supervisor, instructor, or department.

- Proper personal protective clothing and equipment shall be worn.
- Always have an appropriate *Material Safety Data Sheet (MSDS)* available and be familiar with the health, flammability and reactivity hazards for the particular gas.

Cylinder Markings:

- Cylinders must be properly labeled, including the gas identity and appropriate hazards (e.g., health, flammability, reactivity).
- Cylinders have several stamped markings. The top mark is either a DOT or an ICC marking indicating pertinent regulations for that cylinder. The second mark is the serial number. Under the serial number is the symbol of the manufacturer, user, or purchaser. Of the remaining marks the numbers represent the date of manufacture, and retest date (month and year). A (+) sign indicates the cylinder may be 10% overcharged, and a star indicates a ten-year test interval.

Cylinder Storage:

- Cylinders should be stored in compatible groups
 - Flammables from oxidizers
 - Corrosives from flammables
 - Full cylinders from empties
 - All cylinders from corrosive vapors.
- Keep oxygen cylinders a minimum of twenty feet from flammable gas cylinders or combustible materials. If this cannot be done, separation by a non-combustible barrier at least 5 feet high having a fire rating of at least one-half hour is required.
- Secure empty and full cylinders to a fixed support by use of chains, or other substantial restraining devices.
- Store cylinders in an upright position.
- Keep valve protective caps in place when the cylinder is not in use.
- Mark empty cylinders EMPTY or MT.
- Keep valves closed on empty cylinders.
- Cylinders must be kept away from sources of heat.
- Cylinders must be kept away from electrical wiring where the cylinder could become part of the circuit.
- Store cylinders in well-ventilated areas designated and marked only for cylinders.

Moving Cylinders:

- Use a cylinder cart and secure cylinders with a chain.
- Don't use the protective valve caps for moving or lifting cylinders.
- Don't drop a cylinder, or permit them to strike each other violently or be handled roughly.

- Unless cylinders are secured on a special cart, regulators shall be removed, valves closed and protective valve caps in place before cylinders are moved.

Cylinder Use:

- Be sure all connections are tight. Use soapy water to locate leaks.
- Keep cylinders valves, regulators, couplings, hose and apparatus clean and free of oil and grease.
- Keep cylinders away from open flames and sources of heat.
- Safety devices and valves shall not be tampered with, nor repairs attempted.
- Use flashback arrestors and reverse-flow check valves to prevent flashback when using oxy-fuel systems.
- Regulators shall be removed when moving cylinders, when work is completed, and when cylinders are empty.
- Cylinders shall be used and stored in an upright position.
- The cylinder valve should always be opened slowly. Always stand away from the face and back of the gauge when opening the cylinder valve.
- When a special wrench is required to open a cylinder or manifold valve, the wrench shall be left in place on the valve stem when in use; this precaution is taken so the gas supply can be shut off quickly in case of an emergency; and that nothing shall be placed on top of a cylinder that may damage the safety device or interfere with the quick closing of the valve.
- Fire extinguishing equipment should be readily available when combustible materials can be exposed to welding or cutting operations using compressed cylinder gases.
- When preparing to withdraw gas from a high-pressure cylinder, close the regulator first. Open the main cylinder valve until it stops and adjust the gas flow rate using the regulator. For cylinders containing fuel gases, open the cylinder valve one-quarter turn, adjusting the regulator as above.
- When you are finished using a compressed gas system, turn off the main cylinder valve, bleed the regulator and lines, and close the regulator. Do not leave the regulator under pressure by closing down flow from the regulator without shutting off the main cylinder valve.
- Do not drain a cylinder completely. Air can be sucked back through the valve, contaminating the cylinder or creating an explosive mixture.
- If a cylinder containing a hazardous gas develops a leak, evacuate and restrict access to the area. Remove sources of ignition if the gas is flammable. On campus, call the Fire Department at **9-911**.

Things Not To Do:

- Never roll a cylinder to move it.
- Never carry a cylinder by the valve.
- Never leave an open cylinder unattended.
- Never leave a cylinder unsecured.
- Never force improper attachments on to the wrong cylinder.

- Never grease or oil the regulator, valve, or fittings of an oxygen cylinder.
- Never refill a cylinder.
- Never use a flame to locate gas leaks.
- Never attempt to mix gases in a cylinder.
- Never use teflon tape on a pressurized fitting of a cylinder.
- Never discard pressurized cylinders in the normal trash.

Poison Gases:

Poison gases represent a significant hazard. Special precautions not otherwise necessary become prudent when using poison gases:

- Common poison or highly toxic gases include:
 - Arsine (AsH₃)
 - Ethylene oxide (EtO)
 - Hydrogen cyanide (HCN)
 - Nitric oxide (NO)
 - Phosphine (PH₃)

Certain poison gases (e.g., Ethylene Oxide) can only be used if specific OSHA regulations and safe practices are followed.

- Certain poison gases (e.g., Ethylene Oxide) can only be used if specific OSHA regulations and safe practices are followed.
- Emergency procedures should be made clear to all involved, including personnel from adjacent labs and building managers.
- Poison gas use after normal working hours requires the approval of the Chemical Hygiene Officer for your department.
- Fume hoods and other ventilation need to be tested before use and checked frequently during the project involving poison gas.
- Notify Environmental Health, Safety and Risk Management before your first use of the poison gas.
- The University Police should also be informed about the locations and types of poison gas in use.
- Document these procedures in your lab's chemical hygiene plan. As with all chemicals, obtain and review the Material Safety Data Sheet (MSDS) for the poison gas. Maintain an extra copy of the MSDS in your department's chemical hygiene plan.

Disposal of poison gas cylinders can often cause problems. If the cylinder cannot be returned to the manufacturer, UWM can face large disposal costs (\$1,000 per cylinder, or more). Even cylinders that can be returned must be shipped on a vehicle, which cannot simultaneously carry any other hazardous materials or foodstuffs.

Authority and Reference:

- OSHA 29 CFR 1910.101 and .252 (General Requirements)
- OSHA 29 CFR 1910.102 (acetylene)
- OSHA 29 CFR 1910.103 (hydrogen)
- OSHA 29 CFR 1910.104 (oxygen)
- OSHA 29 CFR 1910.105 (nitrous oxide)
- DCOM 32.15 and 32.28
- Compressed Gas Association (safety publications)

4.14 Autoclave Safety

Autoclaves are such a familiar feature in many laboratories that it is easy to forget what hazards they can pose. The autoclave's job is to render its contents sterile, or free of any living organisms. If it fails to do so, serious health hazards can result. The hot, pressurized steam (270° Fahrenheit, 30 pounds per square inch gauge) that autoclaves generate to do this job makes them serious burn hazards as well. And, because conditions created inside steam autoclaves are so extreme, autoclaves can easily malfunction if they are not carefully maintained.

Before using any autoclave for the first time, read and thoroughly understand the owner's manual because many makes and models have unique characteristics. If you cannot locate the manual, contact the manufacturer and have a copy sent to you.

Modes of Operation

The autoclave uses different patterns of high heat, vacuum, and pressure to sterilize its load. The type of materials you sterilize will determine the type of sterilization "runs" you use. The general types of runs are "liquids" for any type of water-based solutions, "dry goods with vacuum," and "dry goods without vacuum." Autoclaves often have an additional "drying" cycle in which hot air is drawn through the chamber to dry materials before removal. Controls for different brands of autoclave vary, so you should follow manufacturers' instructions about loading, load sizes, and cycle types and settings carefully.

The "liquids" run is longer than the other two but uses lower temperatures to minimize evaporation of the liquids being sterilized. **Make sure seals on containers of liquids are loose so vapor expanding during heating will not cause an explosion. Never autoclave any flammable or volatile liquids because they could explode.**

The "dry goods with vacuum" run moves steam and heat into the deepest parts of large bags or bundles of materials and produces the best conditions for killing persistent organisms. During this type of run, the chamber alternates between cycles of vacuum and high pressure. Then the chamber is pressurized with steam for a long period, followed by

a short vacuum cycle. It is important that steam and pressure be able reach the entire load, so carefully loosen autoclave bag closures once they are in the autoclave.

The "dry goods without vacuum" run simply pressurizes the chamber with steam for the duration of the cycle, and then returns to normal. This process is used primarily for items that have been cleaned but need to be sterilized. Materials should be packed so that the heat and pressure can readily reach the whole load.

Ensuring Thorough Sterilization

It is imperative to know that the autoclave has thoroughly sterilized its contents. Most autoclave bags or tapes are imprinted with a dye that changes color when the correct temperature is reached. The problem with this type of check is that the dye is on the surface of the load, and a positive reading **does not ensure that the innermost parts of a large load are also sterile**. However, an easy way to check this is to wrap something with autoclave tape (a disposable plastic test tube or pipette tip are possibilities), and attach string to it as it's being put deep into the load. Tape the other end of the string to the outside of the bag so that you can easily pull the indicator out (Do NOT open up a load of potentially infected material to bury something inside). Recover the indicator after the run and confirm that it too has changed color.

Routine Maintenance

It is a good practice to use a biological indicator (e.g., A msc's Proof system, BBL's Kilit) monthly to confirm that the autoclave is working properly. If either the dye (see procedure above) or biological indicator fails, you must examine the autoclave to identify and correct the problem and also re-autoclave the load to ensure sterility.

The best way to ensure your autoclave is working properly is to have regular maintenance performed semi-annually. In addition, users should perform the daily and weekly maintenance procedures described in the owner's manual. Also make sure the drain strainer is clean before each run.

Autoclave Safety

Autoclaves generate extreme heat and high pressure. Users should understand and respect the hazards these can create. Autoclave doors and their gaskets must be firmly locked into place before running the autoclave to prevent a sudden release of high-pressure steam. Most, **but not all**, autoclaves have safety interlocks that prevent the autoclave from running if the door isn't closed properly. Know if yours has an interlock--you'll need to use extra caution if it doesn't.

Some older autoclaves have little or no heat shielding around the outside. Attach signs warning of "Hot Surfaces, Keep Away" or similar wording on or next to the autoclave to remind people of the hazard. Do not stack or store combustible materials next to an autoclave (cardboard, plastic, volatile or flammable liquids). Use heat-resistant gloves when removing materials after sterilization and avoid touching the inner chamber surfaces.

If you are burned, you can receive treatment at the University Health center. Burns to the face, third-degree burns, or burns over large areas of the body should be treated as emergencies. Call 9-911 from a campus phone or 911 from a pay phone to get help. You can treat minor burns yourself using standard first aid. Regardless of the degree of severity, report the burn to your supervisor or laboratory technician as an occupational injury.

If you have questions about autoclave operation or need help reaching a manufacturer, contact the Office of Environmental Health & Safety at 543-7262.

Section 5: Hazardous Materials Protocol

5.1 Chemical Storage

This program contains requirements for practices designed and implemented to protect University employees, students, visitors and the environment from the risks of hazardous chemicals that are stored on University property.

Scope

This program is applicable to all University students, faculty and staff that are required by the nature of their job to handle hazardous chemicals.

Definitions

Flammable chemicals - Solid, liquid or gaseous chemicals that readily catch fire and burn in the presence of oxygen.

CLASSIFICATION TERM FLASH POINT TEMPERATURE

Flammable Liquid Class I Below 100°F (37.8°C)

Flammable Liquid Class I A Below 73°F (22.8°C) and Boiling Point below 100°F (37.8°C)

Flammable Liquid Class I B Below 73°F (22.8°C) and Boiling Point at or above 100°F (37.8°C)

Flammable Liquid Class I C Below 100°F (37.8°C) and Boiling Point at or above 73°F (22.8°C)

Combustible chemicals - Solid, liquid or gaseous materials that burn in the presence of oxygen.

CLASSIFICATION TERM FLASH POINT TEMPERATURE

Combustible Liquid Class II Below 140°F (60°C) or at or above 100°F (37.8°C)

Combustible Liquid Class III At or above 140°F (60°C)

Combustible Liquid Class III A Below 200°F (93.4°C) or at or above 140°F (60°C)

Combustible Liquid Class III B At or above 200°F (93.4°C)

NOTE: Ignitable liquids, regulated as wastes by the Environmental Protection Agency (EPA) under the Resource Conservation and Recovery Act, include Class I flammable liquids and Class II combustible liquids.

Corrosive chemicals - Any solid, liquid or gaseous chemicals that burn, irritate or destructively attack organic tissues, most commonly the skin.

Material Safety Data Sheet (MSDS) - Written or printed material prepared by the manufacturer of a hazardous chemical that contains information about the hazards of the chemical and the appropriate work practices required for use.

NFPA-approved - Approved by the National Fire Protection Association.

Oxidizing chemicals - Any solid, liquid or gaseous chemicals that may cause or enhance the combustion of other materials or readily react to oxidize combustible materials, generally by yielding oxygen or some other oxidizing gas.

Pyrophoric chemicals - Any liquid or solid chemicals that will ignite spontaneously in air below 130°F (54.4°C).

Reactive chemicals - Any solid, liquid or gaseous chemicals that react violently with water, or are normally unstable and readily undergo violent changes without detonating, or form potentially explosive mixtures with water, or generate toxic gases when mixed with water or corrosive chemicals, or are capable of detonation or an explosive reaction.

Toxic chemicals - Any solid, liquid or gaseous chemicals that can cause damage to living tissue, impairment of the central nervous system, severe illness or in extreme cases, death when ingested, inhaled or absorbed by the skin.

General Storage Requirements For All Chemicals

1. Label all chemical containers appropriately. If transferring chemicals out of their original container to another container or if the original container label is illegible, follow the chemical labeling guidelines as detailed within this Manual - Hazard Communication, Section 5.8.
2. Be knowledgeable of the procedures contained in EH&S's Chemical Spill Response Program to prepare yourself and others in the event that any chemical container leaks or is spilled.
3. Follow all precautions regarding the storage of incompatible chemicals. Consult the label and Material Safety Data Sheet (MSDS) for each chemical to ensure that you are familiar with the chemical and how it should be handled, stored and disposed. **Separate all chemicals into compatible groups and store alphabetically within stored groups.**
4. Provide a definite storage place for each chemical and return the chemical to that same location after each use.

5. Avoid storing chemicals in laboratory fume hoods or on bench tops, except for those chemicals intended to be used by the end of the day.
6. Store volatile toxic chemicals and odorous chemicals in a ventilated cabinet, if possible. The cabinet's associated electrical components must be explosion-proof if flammable materials are being ventilated. If located in a laboratory, locate the cabinet near the fume hood. Store other chemicals inside a closable cabinet or on a shelf that has a lip to prevent containers from sliding off in the event of a fire or other serious accident.
7. Do not expose stored chemicals to heat, direct sunlight or freezing conditions.
8. Store all containers of liquids on compatible plastic trays that are capable of holding the contents of the container if it leaks, or at least 10% of the total volume stored within the tray. Store liquids on lower shelves, if possible.
9. Seal all chemical containers well to minimize the escape of flammable, corrosive, irritating or toxic vapors or gases.
10. Ventilation is required for chemicals that may release dangerous or damaging quantities of vapors or gases, which may be flammable, corrosive, irritating or toxic.
11. For every chemical storage area, there should be evacuation and emergency procedures to be followed and fire extinguishers available in the case of personal exposure or a leak, spill or fire within the room.

Storage Requirements For Flammable And Combustible Chemicals

1. The storage area should be separated and protected so that a fire or spill in the storage area is not likely to spread beyond the storage area.
2. If containers of flammable and combustible liquids are larger than five (5) gallons in size, special provisions are necessary to prevent liquid from flowing out of the storage area in the event of a spill or leak. Contact EH&S at 543-7262 for further details.
3. When possible, store quantities of flammable liquids greater than one (1) gallon in NFPA-approved safety cans. Store all flammable liquids and solids in NFPA-approved storage cabinets. EH&S will provide these cabinets to you at no cost.
4. Do not store flammable chemicals in any refrigerator unless it has been designed for that purpose. Ordinary refrigerators contain spark sources that can ignite flammable vapors. If refrigerated storage is needed inside of a flammable storage room, an explosion-proof refrigerator must be used. Use chemical storage refrigerators only for storing chemicals, never food or drink. Label these refrigerators with the following signage:

NO FOOD OR DRINK TO BE STORED IN THIS REFRIGERATOR

5. Maximum Container Sizes for Flammable and Combustible Liquids

The following container sizes, **in liters**, are the maximum allowable unless otherwise specified:

Flammable Liquids Combustible Liquids

Quantity for Storage, Liters

Container	Class IA	Class IB	Class IC	Class II	Class IIIA
Glass	0.5	1	4	4	4
Metal or approved Plastic	4	20	20	20	20
Safety Cans	7.5	0	20	20	20

NOTE: Glass containers as large as one (1) gallon can be used, if needed, and if the required purity would be adversely affected by storage in a metal or approved plastic container, or if the liquid would cause excessive corrosion or degradation of a metal or approved plastic container.

6. Storage Limits for Flammable and Combustible Liquids

The following limits apply to all Class B Occupancies with sprinkler systems and is the maximum allowable. Contact EH&S for clarification if you have questions.

Liquid Class Flash Point (\square F) Amount Allowable (per 100 sq. ft.)

Class I Flammable Below 100° 4 gallons

Class II Combustible 100° - 139° 4 gallons

Class IIIA Combustible 140° - 200° 12 gallons

Class IIIB Combustible Above 200° Unlimited

7. Safety Equipment for Storage of Flammable Liquids

Safety Cans: Safety cans are containers that have built-in safety features for protecting flammable liquids from exposure to a fire situation. In a fire situation, a safety can is exposed to extremely high temperatures. This heat is transmitted to the contents, which in turn boil and produce a large vapor pressure. Every safety can is fitted with a spring-loaded cap that vents these vapors safely without bursting the can. The other safety feature of a safety can is the flame arrestor that consists of a cylindrical wire screen. Vapors emitted from a safety can will ignite when exposed to the flames of a fire. Since flames usually flash back to the source of liquid, the flame arrestor serves as a heat dissipater. The temperature in the space above the liquids in a safety can is lowered below the ignition temperature and ignition of the contents is eliminated.

Flammable Liquid Storage Cabinets: Flammable liquid storage cabinets are designed to maintain the temperature at the top of the cabinet interior below 325°F when subjected to a 10-minute fire test. Cabinets built to withstand the temperature rating during the 10-minute fire test are acceptable by OSHA standards if: (a) the maximum capacity of Class I and II liquids is not more than 60 gallons (or more than 120 gallons for Class II liquids); and (b) the cabinet is labeled with conspicuous lettering, such as Flammable-Keep Fire Away. All storage cabinets must have self-closing doors that will close the latch automatically when released. These doors must not be blocked open.

Special Refrigerators: Special refrigerators that can safely store flammable liquids have a spark-free interior such that all wiring and thermostat controls have been removed from the interior. Two types of these refrigerators are commercially available: a "flammable liquid storage" model and an "explosion-proof" model. A "flammable liquid storage" model is normally used in a non-explosive area where no flammable vapors are present. Such a refrigerator is normally powered through a standard three-wire cord plugged into an electrical outlet. An "explosion-proof" refrigerator is required when the area in which the refrigerator will be located has the potential for ignition of flammable vapors. An explosion-proof refrigerator is supplied with a "pigtail" cord that must be wired directly to a power source using metal conduit as specified by local electrical codes. Choosing the appropriate refrigerator will depend on the area in which it will be located.

8. Flammable and Combustible Liquid Storage Rooms

- a. Large quantities of liquids that need to be stored in specially designed storage rooms include those with flash point temperatures at or below 200°F (93.4°C) and include all liquids identified as flammable liquids, ignitable liquids or combustible liquids in Class II or IIIA.
- b. An inside storage room that does not exceed 150 sq. ft. in floor area is permitted to contain up to two (2) gallons per sq. ft. of floor area within the room, if the room is separated from the building by construction having at least one (1) hour fire resistance, and all openings between the room and the building are protected by assemblies having a one (1) hour fire-resistance rating. If it is desirable to increase the allowable storage capacity of such a room, the capacity can be increased to five (5) gallons per sq. ft. by providing the room with an automatic fire extinguishing system.
- c. An inside storage room needs to be ventilated to prevent possible accumulation of flammable concentrations of vapors from container leaks and spills. Recommended ventilation is from floor level with a capacity of one (1) cubic foot per minute of exhaust for each square foot of floor area in the room, with a minimum exhaust of 150 cubic foot per minute.
- d. If there is dispensing in the room, there should be provisions for ventilating the dispensing operation close to the points at which vapors are being emitted.

- e. If storage room containers of flammable and combustible liquids are larger than five (5) gallons in size, it is necessary to provide barriers to prevent spills in the room from migrating outside the room. If these containers hold Class I or Class II liquids, curbs or ramps are needed as barriers.
- f. Wiring and electrical fixtures located inside storage rooms must be suitable for the hazards. Explosion-proof (National Electric Code Class I, Division 2) electrical equipment is required for prevention of explosions if large quantities of flammable liquids (Class I) are being stored or dispensed. If only combustible liquids are being stored or dispensed, general use wire is acceptable.
- g. If an inside storage room has an exterior wall, it is classified by the NFPA flammable and combustible liquids code as a "cut-off room" for which there are two additional requirements: (a) Exterior walls are required to provide ready accessibility for fire fighting; and (b) if Class IA or Class IB liquids are dispensed or if Class IA liquids are stored in containers larger than one (1) gallon, the exterior wall or roof is required by the NFPA to be designed to provide explosion venting.
- h. There is no need for explosion venting in a small room used only for storage or in a room used for dispensing if adequate ventilation is provided.

Storage Requirements For Reactive Chemicals

1. Consider the storage requirements of each reactive chemical prior to purchasing.
2. Consult the label and MSDS in making decisions about storage of reactive chemicals.
3. Use and store only the quantities of material you will need for immediate use.
4. Cyanides and sulfides should be stored in a location separate from acids or protected from contact with acids.
5. All acids should be stored separately from all alkaline materials (bases).
6. Date all highly reactive materials as soon as received and make sure the label states:

DANGER! HIGHLY REACTIVE MATERIAL

7. Do not open a container of highly reactive material that is past its expiration date. Call EH&S at 543-7262 for assistance.
8. Dispose of highly reactive material through EH&S prior to the expiration date.
9. Segregate the following materials:
 - a) Oxidizing agents from reducing agents and combustibles
 - b) Powerful reducing agents from readily reducible substrates
 - c) Pyrophoric compounds from flammables
 - d) Perchloric acid from reducing agents and combustibles

20. Store reactive liquids in trays constructed of compatible materials, which are large enough to contain the contents of the bottles. Store perchloric acid bottles in glass or ceramic trays.
21. Store materials that react vigorously with water away from any possible contact with water. If chemicals are to be stored that are reactive if exposed to the air or water, they can safely be stored in sprinkle red areas where sprinkler discharge would serve to prevent rupture of the outer container.
22. Temperature control or refrigeration must be provided, as needed, for chemicals that deteriorate or react if their temperatures exceed safe limits recommended by the manufacturer or person synthesizing the chemical. Store thermally unstable materials in a refrigerator with the following safety features: all spark-producing controls are on the outside, a magnetic locked door, an alarm to warn when the temperature is too high.
23. Assign responsibility for the storage areas utilized for highly reactive materials to one (1) primary person and a backup person. Review this responsibility at least twice yearly.
24. Some highly reactive shock/heat sensitive materials are:

Ammonium perchlorate Dibenzoyl peroxide

Ammonium permanganate Diisopropyl peroxydicarbonate

Anhydrous perchloric acid Dinitrobenzene (ortho)

Butyl hydroperoxide Ethyl methyl ketone peroxide

Butyl perbenzoate Ethyl nitrate

t-Butyl peroxyacetate Hydroxylamine

t-Butyl peroxyvalate Peroxyacetic acid

1-Chloro-2, 4-dinitrobenzene Picric acid (<10% water content)

Cumene hydroperoxide Trinitrobenzene

Diacetyl peroxide Trinitrotoluene

Storage Requirements For Oxidizers

Oxidizing agents such as chlorates, perchlorates, peroxides, nitric acid, nitrates, nitrites and permanganates represent a significant hazard because of their propensity under certain conditions to undergo vigorous reactions when they come into contact with easily oxidized material such as metal powders and organic materials like wood, paper and other combustible material. Mineral acids such as perchloric acid, sulfuric

acid and nitric acid, as well as other oxidizers, should be stored separate from flammables and combustibles, by separate rooms, cabinets or break resistant containers. If large bottles must be stored in proximity of combustible materials, acid resistant trays must be used to prevent the oxidation of wood or corrosion of metal shelves.

1. Class I Oxidizer

Class I oxidizers will cause an increase of the burning rate of combustible material with which it comes in contact. Some examples are:

Hydrogen peroxide (8-28%) Magnesium perchlorate

Nitric acid (70% or less) Silver nitrate

Perchloric acid solutions (less than 60% wt/wt)

2. Class II Oxidizer

Class II oxidizers will cause an increase of the burning rate or may cause spontaneous ignition of combustible material with which it comes in contact.

Some examples are:

Calcium hypochlorite (50% or less wt/wt) Chromic acid

Hydrogen peroxide (28-52% wt/wt) Sodium peroxide

Contact EH&S if quantities are stored in excess of 1,000 lbs.

3. Class III Oxidizers

Class III oxidizers will cause a severe increase in the burning rate of combustible material with which they come in contact, or will undergo vigorous self-sustained decomposition when catalyzed or exposed to heat. Regulated quantities are permitted to be stored only on the ground floor of a building with no basement. Some examples are:

Ammonium dichromate Perchloric acid solutions (60-73%)

Hydrogen peroxide (52-91% wt/wt) Sodium chlorate

Contact EH&S if quantities are stored in excess of 200 lbs.

4. Class IV Oxidizer

Class IV oxidizers can undergo an explosive reaction when catalyzed or exposed to heat, shock, or friction. Regulated quantities are permitted to be stored only in detached storage. Storage areas for Class IV oxidizers must be provided with a means to vent fumes in any type of emergency. Some examples are:

Ammonium perchlorate Perchloric acid solutions

Ammonium permanganate (greater than 72.5%)

Hydrogen peroxide (greater than 91% wt/wt) Potassium super oxide

Contact EH&S if quantities are stored in excess of 10 lbs.

Storage Requirements For Toxic Chemicals

i. Store chemicals known to be highly toxic, including carcinogens, in ventilated storage in unbreakable, chemically resistant secondary containers.

Keep quantities on hand at an absolute minimum.

Label storage areas with appropriate warning signs, such as:

CAUTION! REPRODUCTIVE TOXIN STORAGE

-or-

CAUTION! CANCER-SUSPECT AGENT STORAGE

and limit access to these areas.

5. Storage areas for pesticides and other toxic chemicals should be secured when the storage areas are not supervised by a responsible person so that unauthorized personnel are kept out.

Storage Requirements For Peroxidizable Chemicals

1. Some chemicals can form significant quantities of unstable peroxides after prolonged exposure to air and light. Certain peroxides may detonate with extreme violence when they become concentrated by evaporation or distillation, when combined with other compounds to yield a detonable mixture or when simply disturbed by unusual heat, shock or friction.

The following is a representative list of those compounds, which form peroxides:

PEROXIDE HAZARD IN STORAGE. These compounds form peroxides that may explode even without being concentrated

- Isopropyl ether Divinyl ether Potassium metal
- Potassium amide Sodium amide (sodamide) Vinylidene chloride

2. *PEROXIDE HAZARD ON CONCENTRATION*. These compounds may form peroxides as a result of distillation or most likely evaporation.

Dioxane Ethyl ether

Tetrahydrofuran Acetal

Cumene Cyclohexane

Dicyclopentadiene Diacetylene

Furan Ethylene glycol dimethyl ether

Methylcyclopentane Methyl acetylene

Tetrahydronaphthalene Vinyl ethers

3. *HAZARDS DUE TO PEROXIDE INITIATION OF POLYMERIZATION*. When stored as a liquid, the peroxide forming potential increases and certain of these monomers, especially butadiene, chloroprene and tetrafluoroethylene, should be considered as a peroxide hazard in storage.

Butadiene Chlorobutadiene (Chloroprene) Vinyl pyridine

Chlorotrifluoroethylene Styrene

Tetrafluoroethylene Vinyl acetate

Vinyl acetylene Vinyl chloride

Storage and handling procedures:

Each person responsible for a laboratory must develop and maintain an inventory of the peroxidizable materials in the laboratory. The inventory should be reviewed every three (3) months, at which time samples from List I, three (3) months or older, and List II and List III samples twelve (12) months or older would either be tested for peroxides or disposed of through EH&S. Quantities of peroxidizable compounds should be purchased according to short-term needs to ensure that peroxide buildup, which may accompany long-term storage, is minimized. Purchase in container sizes corresponding to use requirements to minimize exposure to air from multiple openings of the container.

4. Use the following labeling formats for all peroxide-forming liquids:

List I Peroxidizable Compound

Date received Date opened _____

Dispose of or test within 3 months after opening!

Disposal Date _____

Contact EH&S at 543-7262 for disposal.

List II/III Peroxidizable Compound

Date received Date opened _____

Discard or test within 12 months after opening!

Disposal Date _____

Contact EH&S at 543-7262 for disposal.

All peroxidizable compounds should be stored away from heat and light. Sunlight is an especially good promoter of peroxidation. Protection from physical damage and ignition sources during storage is also essential. Particular care should be given to ensure tight closure on storage containers. Loose or leaky closures may permit evaporation of storage material, leaving a hazardous concentration of peroxides in the container. Most common container materials, such as steel, stainless steel, copper, nickel, aluminum, baked phenolic linings and ceramics, are suitable for containers; however, they must be clean and free of metal oxides because iron or copper oxides may actually promote peroxide formation.

The use of oxidation inhibitors is especially important in the safe handling of peroxidizable materials. Hydroquinone, alkyl phenols, aromatic amines or similar materials are recommended by the manufacturers as being effective in preventing peroxide formation during storage. Compounds that are suspected of having very high peroxide levels because of visual observation of unusual viscosity or crystal formation or because of age should be considered extremely dangerous. The precautions taken for disposal of these materials should be the same as for any material that can be detonated by friction or shock. **IT IS OF THE UTMOST IMPORTANCE THAT THE CONTAINER NOT BE OPENED.** The act of opening the container **COULD DETONATE PEROXIDE CRYSTALS** under the container cap or other closure. Peroxidization in a chemical process may not only be a serious hazard because of the explosion potential, but also may affect lower yield and produce unwanted impurities.

Chemical Incompatibility Chart

Chem. Group #	Do Not Store with Chemicals in Group #'s
1. Inorganic Acids	2-8, 10, 11, 13, 14, 16-19, 21-23
2. Organic Acids	1, 3, 4, 7, 14, 16-19, 22
3. Caustics	1, 2, 5, 7, 8, 13-18, 20, 22, 23
4. Amines and alkanolamines	1, 2, 5, 7, 8, 13-18, 23
5. Halogenated compounds	1, 3, 4, 11, 14, 17
6. Alcohols, glycols, glycol ethers	1, 7, 14, 16, 20, 23
7. Aldehydes	1-4, 6, 8, 15-17, 19, 20, 23
8. Ketones	1, 3, 4, 7, 19, 20
9. Saturated hydrocarbons	20
10. Aromatic hydrocarbons	1, 20
11. Olefins	1, 5, 20
12. Petroleum oils	20
13. Esters	1, 3, 4, 19, 20
14. Monomers, polymerizable esters	1-6, 15, 16, 19-21, 23
15. Phenols	3, 4, 7, 14, 16, 19, 20
16. Alkylene oxides	1-4, 6, 7, 14, 15, 17-19, 23
17. Cyanohydrins	1-5, 7, 16, 19, 23
18. Nitriles	1-4, 16, 23
19. Ammonia	1-2, 7, 8, 13-17, 20, 23
20. Halogens	3, 6-15, 19, 21, 22
21. Ethers	1, 14, 20

- | | |
|--------------------------|--------------------------|
| 22. Elemental phosphorus | 1-3, 20 |
| 23. Acid anhydrides | 1, 3, 4, 6, 7, 14, 16-19 |

Chemical Compatibility Chart

Related and Compatible Storage Groups

ORGANIC FAMILY

Acids, anhydrides, peracids

Alcohols, glycols, amines, amides, imines, imides

Hydrocarbons, esters, aldehydes

Ethers, ketones, ketenes, halogenated hydrocarbons, ethylene oxide

Epoxy compounds, isocyanates

Peroxides, hydroperoxides, azides

Sulfides, polysulfides, sulfoxides, nitrites

Phenols, cresols

INORGANIC FAMILY

Metals, hydrides

Halides, sulfates, sulfites, thiosulfates, phosphates, halogens

Amides, nitrates (except ammonium nitrates, azides)

Hydroxides, oxides, silicates, carbonates, carbon

Sulfides, selenides, phosphides, carbides, nitrides

Chlorates, perchlorates, perchloric acid, chlorites, hypochlorites, peroxides, hydrogen peroxide

Arsenates, cyanides, cyanates

Borates, chromates, manganates, permanganates

Nitric acid, other inorganic acids

Sulfur, phosphorus, arsenic, phosphorus pentoxide

5.2 Hazardous Materials Transportation Program

Please note that this program has a glossary. The glossary contains the definitions for various terms used in the program. These terms are highlighted in bold print the first time they appear in the body of the program.

Policy

No employee of the Civil and Environmental Engineering Department shall offer or accept international, interstate, or intrastate transportation of a **hazardous material** except in accordance with criteria set forth in this policy and procedure.

Hazardous Material Classifications and Divisions

Under the Hazardous Materials Transportation Program, there are 11 **hazard classes** (nine numbered and two unnumbered) - classes 1 through 9, plus the classes **Combustible Liquids** and Other Regulated Materials (ORM). Note: Class number does not represent degree of hazard. Many of these classes are subdivided into **divisions**, which have numeric decimal values (See Appendix A).

Packaging

Each hazardous material is assigned to one of three packing groups (PG), based on tests for dropping, leakage, etc. Packing groups I, II and III indicate the degree of danger presented by the material is either great, medium or minor, respectively. If more than one packing group is indicated for an entry, the packing group for the hazardous material is determined using the criteria for assignment of packing groups specified for each class in 49 Code of Federal Regulations (CFR) 173 Subpart D. Class 2 and Class 7 materials and ORM-D materials, do not have packing groups. All packing groups are specified in column 5 of the 172.101 Hazardous Materials Table. Contact Environmental Health and Safety Department at 543-7262 for copies of the table.

Marking/Labeling

General Marking

All markings on the outside of a hazardous material package must be durable, easy to read, in English and unobstructed by anything else on the package.

Marking for Non-Bulk Packaging

The outside of each non-bulk package and any inside containers of hazardous materials must be marked with the following information:

1. Proper shipping name;
2. Identification number (preceded by "UN" or "NA", as appropriate); and

3. Name and address of the consignee or the consignor (the consignee is the person to whom the package is sent. The consignor is the person who sends the package except when the package is transported by highway only and will not be transferred from one motor **carrier** to another; or part of a carload lot, truckload lot or freight container load, and the entire contents of the rail car, truck or freight container are shipped from one consignor to on consignee.

Identification numbers are not required on packages, which contain only limited quantities or ORM-D materials.

When a non-bulk package contains inner containers of hazardous liquid materials, the inner containers must be packed with the caps/lids upright. In addition, it must be legibly marked with package orientation markings on two opposite vertical sides of the package with the arrows pointing in the correct upright direction. Arrows for purposes other than indicating proper package orientation may not be displayed on a package containing a liquid hazardous material.

For materials poisonous by inhalation, the package shall be marked "Inhalation Hazard" in association with the required labels or placards. Each non-bulk plastic outer **packaging** used as a single or composite packaging for materials meeting the definition of 6.1 shall be permanently marked, by embossment or other durable means, with the word "POISON" in letters at least 6.3 millimeters (0.25 inch) in height. The marking shall be located within 150 millimeters (6 inches) of the closure of the packaging.

If the package contains the reportable quantity of a **hazardous substance**, the letters "RQ" must be marked in association with the proper shipping name. Reportable quantity means the quantity specified in column 3 of the appendix to 172.101 Hazardous Materials Table for any material identified in Column 1 of the appendix.

Marking for Bulk Packaging

Bulk packages are required to display the proper shipping name on two opposite sides. The "UN" or "NA" identification number shall be displayed on each side and each end if the packaging has a capacity of 3,785 liters (1,000 gallons), or on two opposing sides if the packaging has a capacity of less than 3,785 liters (1,000 gallons).

For bulk packaging containing materials poisonous by inhalation, the package shall be marked "Inhalation Hazard" on two opposing sides in association with the required labels or placards.

Labeling

Each package containing hazardous materials presented for transportation must be labeled with a hazard label(s) that corresponds to the hazard class of the material it contains. Hazard labels must be placed on the same side of the package as the proper shipping name and "UN" or "NA" identification number markings. These labels must be clearly visible and unobstructed by anything else on the package.

Hazard warning labels must meet strict Department of Transportation (DOT) guidelines regarding size, shape, color and content. Domestic labels will generally have words; however, labels used in international commerce may be wordless. The chart in Appendix C illustrates the proper label that each hazard class or division requires.

If more than one label is indicated on the Hazardous Materials Table, the first one listed is the primary label as determined by the Department of Transportation and any others are subsidiary labels. Primary labels have a class or division number in their lower corner and subsidiary labels do not. The hazard warning labels are diamond-shaped and should measure at least 100 millimeters (3.9 inches) on each side.

Placarding Motor Vehicles

Table 1 below lists those hazard classes, which require placards for **motor vehicles** no matter what amount of material is being hauled. Table 2 includes hazard classes that require placards for motor vehicles carrying hazardous materials, but the amount of material being hauled will determine when placards are required. **Transport vehicles** containing less than 454 kg (1001 pounds) aggregate **gross weight** of any of the hazardous materials listed below in Table 2 are not required to be placarded.

<i>Table 1: Hazardous Materials</i>
Explosives 1.1 Explosives 1.2 Explosives 1.3 Poisonous Gas Dangerous When Wet Poison Radioactive
<i>Table 2: Hazardous Materials</i>
Explosives 1.4 Explosives 1.5 Explosives 1.6 Flammable Gas Non-Flammable Gas Flammable Combustible Flammable Solid Spontaneously Combustible

Oxidizer
Organic Peroxide
Poison
Keep Away From Food
Corrosives
Class 9

Placarding Exceptions

All transport vehicles shall be marked and placarded as specified within this section on each side and each end unless, in an emergency: the vehicle is escorted by a representative of a state or local government; the carrier has permission from the Department of Transportation; or movement of the transport vehicle is necessary to protect life or property. Placarding requirements do not apply to infectious substances, hazardous materials classed as ORM-D, hazardous materials authorized to be offered for transportation as limited quantities and identified as such on shipping papers, hazardous materials which are packaged as small quantities, and combustible liquids in non-bulk packaging.

Other considerations to the exceptions are as follows:

1. When more than one division placard is required for Class 1 materials on a transport vehicle, only the placard representing the lowest division number must be displayed;
2. A NON-FLAMMABLE GAS placard is not required on a transport vehicle which contains non-flammable gas if the transport vehicle also contains flammable gas or oxygen and it is placarded with FLAMMABLE GAS or OXYGEN placards as required;
3. OXIDIZER placards are not required for Division 5.1 materials on transport vehicles which also contain Division 1.1 or 1.2 materials and which are placarded with EXPLOSIVES 1.1 or 1.2 placards;
4. An OXIDIZER placard is not required for Division 5.1 materials on a transport vehicle which also contains Division 1.5 explosives and is placarded with EXPLOSIVES 1.5 placards;
5. The EXPLOSIVE 1.4 placard is not required for those Division 1.4 Compatibility Group S (1.4S) materials that are not required to be labeled 1.4S;
6. For domestic transportation of oxygen, compressed or oxygen, refrigerated liquid, the OXYGEN placard may be used in place of a NON-FLAMMABLE GAS placard;
7. Except for a material classed as a combustible liquid that also meets the definition of a Class 9 material, a COMBUSTIBLE placard is not required for a material classed as a combustible liquid when transported in a **non-bulk packaging**. For a material in a non-bulk packaging classed as a combustible liquid that also meets the definition of a Class 9 material, the Class 9 placard may be substituted for the COMBUSTIBLE placard;

8. For domestic transportation, a Class 9 placard is not required. A bulk packaging containing a Class 9 material must be marked on each side and each end with the appropriate identification number displayed on an orange panel; or a white-square-on-point display configuration; and
9. For domestic transportation of Division 6.1, Packing Group (PG) III materials, a POISON placard may be used in place of a KEEP AWAY FROM FOOD placard.

Prohibited Placarding

Other signs or devices which by color, design, shape or content could be confused with required placards shall not be displayed or affixed on any motor vehicle transporting hazardous materials.

Subsidiary Hazards

A transport vehicle containing two or more categories of materials, requiring different placards specified in Table 2, may be placarded DANGEROUS in place of the separate placarding specified for each of the materials listed in Table 2.

Transport vehicles containing poisonous materials subject to the "Poison-Inhalation Hazard" shipping description or materials which are subject to dangerous when wet subsidiary hazard must be placarded with a POISON or POISON GAS or DANGEROUS WHEN WET placard respectively in addition to any other placard required for that material. Duplication of the POISON or POISON GAS placard is not required.

Visibility and Display of Placards

All placards must be attached to each end and side of the vehicle so that any words or hazard class numbers are horizontal. A minimum of three inches must separate the placard from any other markings or advertising that appears on the vehicle.

It is the responsibility of the shipper to offer the required placards to the carrier when the carrier loads the hazardous materials for transport.

Loading and Unloading

Any tank, barrel, drum, cylinder, or other packaging, not permanently attached to a motor vehicle, which contains any Class 3 (flammable liquid), Class 2 (gases), Class 8 (corrosives), Division 6.1 (poisonous), or Class 7 (radioactive) material must be loaded in such a manner as to secure against movement within the vehicle during transportation.

When hazardous materials are loaded into or unloaded from any motor vehicle, the handbrake must be securely set and all other reasonable precautions will be taken to keep the vehicle from moving during such loading or unloading procedures.

Smoking in or within 25 feet of any motor vehicle while loading or unloading any hazardous material is prohibited. All fire sources shall be kept away from vehicles hauling any hazardous materials.

The Hazardous Materials Regulations contain Segregation Tables (49 CFR 177.848) that indicate which hazardous materials may not be loaded, transported, or stored together. Materials, which are in packages that require labels, in a compartment within a multi-compartment cargo tank or in a portable tank, are subject to the Segregation Tables. In addition, cyanides or cyanide mixtures may not be loaded or stored with acids.

Cylinders

Containers with valves or other similar fittings shall be loaded so that there is minimum likelihood of any damage to them during transportation. Cylinders containing Class 2 (gases) materials shall be loaded onto a flat floor or platform of a motor vehicle. In order to prevent the overturning of cylinders, all cylinders must be securely lashed in an upright position; loaded into racks securely attached to the motor vehicle; packed in boxes or crates of such dimensions as to prevent their overturning; or loaded in a horizontal position. Cylinders for hydrogen, or **cryogenic liquid** may only be transported on a motor vehicle which has an open body equipped with a suitable rack or support having means to hold the cylinder upright when subjected to acceleration in any horizontal direction and any motor vehicle carrying such material may not enter a tunnel.

Shipping Papers

All hazardous materials transported in commerce are required to be accompanied by shipping papers. Shippers may use bills of lading, manifests or way bills as long as these documents contain the required information. The shipping paper requirements do not apply to materials, other than **hazardous wastes** or hazardous substances, identified by the letter "A" or "W" in column 1 of the 172.101 - Hazardous Materials Table unless they are intended for transportation by air or water, and materials classed as ORM-D unless they are intended for transportation by air.

The shipping papers must be legible and printed or typed in English. No unauthorized codes or abbreviations may be used. A shipping paper may consist of more than one page, if each page is consecutively numbered and the first page bears a notation specifying the total number of pages included in the shipping paper (for example, "Page 1 of 4 pages").

Five items must appear on shipping papers containing hazardous materials:

1. A basic description consisting of four elements in the following sequence:
 - Proper shipping name;
 - Hazard class or division;
 - UN or NA identification number; and

- Packing group number;
2. Total quantity except for empty packaging, cylinders for Class 2 (**compressed gases**) materials, and bulk packaging, the total quantity (by net or gross mass, capacity, or as otherwise appropriate), including the unit of measurement, of the hazardous material covered by the description (e.g., "800 lbs" or "208 L") must appear on the shipping paper. For cylinders of Class 2 (compressed gases) materials and bulk packaging, some indication of total quantity must be shown (e.g., "10 cylinders" or "1 cargo tank");
 3. Emergency Number: A 24-hour emergency response telephone number is located on the Material Safety Data Sheet.
 4. Certification Statement: The shipper certifies that the materials listed on the shipping papers have been properly classified, described, packaged, marked and labeled, and are in proper condition for transport according to the regulations established by DOT; and
 5. Signature: The signature of the shipper or his agent signifies that the shipment is in compliance with all relevant regulations.

All shipping papers shall be located so that they are readily available to, and recognizable by, authorities in the event of accident or inspection. When the driver is at the vehicle's controls, shipping papers shall be within his/her immediate reach or readily visible to a person entering the driver's compartment or in a holder which is mounted to the inside of the door on the driver's side of the vehicle. When the driver is not at the vehicle's controls, the shipping paper shall be in a holder which is mounted to the inside of the door on the driver's side of the vehicle or on the driver's seat in the vehicle.

General Entries

When a description of a hazardous material is required to be included on a shipping paper, that description must conform to the following requirements:

1. When a hazardous material and a material not subject to the requirements of this section are described on the same shipping paper, the hazardous material description entries must be entered first;
2. The hazardous material description entries must be entered in a color that clearly contrasts with any description on the shipping paper of a material not subject to the requirements of this section; and
3. Except: A description on a reproduction of a shipping paper may be highlighted, rather than printed, in contrasting color, or must be identified by the entry of an "X" placed before the proper shipping name in a column captioned "HM".

The basic description must be shown in sequence with no additional information interspersed. For example: "Gasoline, 3, UN 1203, PG II" (Shipping Name, Hazard Class, Identification Number, Packing Group).

Exceptions include the following:

1. The total quantity of the material covered by one description must appear before or after the description required above. The type of packaging and destination marks may be entered in any appropriate manner before or after the basic description. Abbreviations may be used to express units of measurement and types of packaging; and
2. Technical and chemical group names may be entered in parentheses between the proper shipping name and hazard class and following the basic description. An appropriate modifier, such as "contains" or "containing," may be used. For example: "Flammable liquids, n.o.s. (contains Xylene and Benzene), 3, UN 1993, II." (If the hazardous substance does not appear in the Table and is not a forbidden material, then an appropriate generic or "n.o.s." shipping name shall be selected corresponding to the hazard class and packing group, if any, of the material as determined by 49 CFR 173.2 and 173.2a. For example, a hazardous substance which is listed in the appendix but not in the Table and which meets the definition of a flammable liquid might be described as "Flammable liquids, n.o.s." or other appropriate shipping name corresponding to the flammable liquid hazard class.

Emergency Response Information

All hazardous material shipments (except those that do not require shipping papers) must have emergency response information on or accompanying the shipping paper. All emergency response information must be legible and in English. The information on or accompanying the shipping paper must be in the form of the Emergency Response Guidebook, a material safety data sheet, or any other form that provides all the following information:

1. The basic description and technical name of the hazardous material;
2. Immediate hazards to health;
3. Risks of fire or explosion;
4. Immediate precautions to be taken in the event of an accident or incident;
5. Immediate methods for handling fires;
6. Initial methods for handling spills or leaks in the absence of fire; and
7. Preliminary first aid measures.

Hazardous Waste Shipments

A carrier shall not accept a shipment of hazardous waste unless it is accompanied by a properly prepared uniform hazardous waste manifest. Transportation of hazardous waste shall only be conducted by a contractor as provided by Environmental Health and Safety Department. Disposal of all hazardous waste shall be in conjunction with Section 5.12, Hazardous Materials Management Program.

Training and Information

General Employee Training

Environmental Health and Safety Department shall provide a training program for employees who during the course of employment directly affect hazardous materials transportation through one or more of the following activities:

- Loads, unloads, or handles hazardous materials;
- Tests, reconditions, repairs, modifies, marks, or otherwise represents containers, drums, or packaging as qualified for use in the transportation of hazardous materials;
- Prepares hazardous materials for transportation; or
- Operates a vehicle used to transport hazardous materials.

The training will be conducted within 90 days of employment for those employees whose job functions involve any of the aforementioned hazardous material tasks and once every two years thereafter. Exception: Additional training shall be provided within 90 days of any job change involving the use of hazardous materials.

An employee may perform job functions prior to the completion of training provided the employee performs those functions under the supervision of a properly trained and knowledgeable employee.

A comprehensive training program shall include the following:

- General training to provide awareness and familiarization of the requirements of the Hazardous Materials Transportation Program and to enable the employee to recognize and identify hazardous materials consistent with the hazard communication standard;
- Function-specific training applicable to the functions the employee performs;
- Safety training pertaining to the following:
 - Emergency response information;
 - Measures to protect the employee from the hazards associated with hazardous materials to which they may be exposed in the workplace, including specific measures the employer has implemented to protect employees from exposure; and
 - Methods and procedures for avoiding accidents, such as the proper procedures for handling packages containing hazardous materials; or
 - Any additional department specific training (e.g., Pre-trip safety inspection or the use of vehicle controls and equipment, including the operation of emergency equipment).

Training Records

Training records shall be maintained by Environmental Health and Safety Department and include the following:

- The employee's name;

- The most recent training date;
- A description, copy, or the location of the training materials used to meet the aforementioned training requirements;
- The name and address of the person providing the training;
- Certification that the employee has been trained and tested as required;
and
- Results of the learning measurement exercise.

Those employees not demonstrating adequate knowledge, as shown by the learning measurement exercise, will be re-trained until adequate knowledge is shown. Training records will be maintained for the duration of employment and for 90 days thereafter.

Glossary

Bulk packaging: A packaging, other than a vessel or a barge, including a transport vehicle or freight container, in which hazardous materials are loaded with no intermediate form of containment and which has:

- A maximum capacity greater than 450 liters as a receptacle for a liquid;
- A maximum net mass greater than 400 kilograms and a maximum capacity greater than 450 liters as a receptacle for a solid; or
- A water capacity greater than 454 kilograms.

Carrier: A person engaged in the transportation of passengers or property by land or water, as a common, contract, private carrier, or civil aircraft.

Compressed Gas: Any material which is a gas at normal temperature and pressure, and which is contained under pressure as a dissolved gas or liquefied by compression or refrigeration.

Compressed Gas in Solution: A non-liquefied compressed gas, which is dissolved in a solvent.

Combustible Liquid: Any liquid, which has a flash point above 60.5 degrees Celsius (141 degrees Fahrenheit) and below 93 degrees Celsius (200 degrees Fahrenheit).

Compatibility Group Letter: A designated alphabetical letter used to categorize different types of explosive substances and articles for purposes of storage and segregation.

Cryogenic Liquid: A refrigerated liquefied gas having a boiling point colder than -90 degrees Celsius (-130 degrees Fahrenheit) at 101.3 kilopascal (kPa) or 14.7 psia.

Detonate: To set off in a burst of activity.

Division: A subdivision of a hazard class.

Elevated Temperature: A material which, when offered for transportation or transported in a bulk packaging is: in a liquid phase and at a temperature at or above 100 degrees Celsius (212 degrees Fahrenheit) or is in a liquid phase with a flash point at or above 37.8 degrees Celsius (100 degrees Fahrenheit) that is intentionally heated and offered for transportation or transported at or above its flash point; or is in a solid phase and at a temperature at or above 240 degrees Celsius (464 degrees Fahrenheit).

Flammable Range: The difference between the minimum and maximum volume percentages of the material in air that forms a flammable mixture.

Flash Point: The minimum temperature at which a liquid gives off vapor within a test vessel in sufficient concentration to form an ignitable mixture with air near the surface of the liquid.

Gross Weight or Gross Mass: The weight of a packaging plus the weight of its contents.

Hazard Class: The category of hazard assigned to a hazardous material; a material may meet the defining criteria for more than one hazard class but is assigned to only one hazard class.

Hazardous Material: A substance or material, which is capable of posing an unreasonable risk to health, safety, and property when transported in commerce; materials designated by the Department of Transportation as hazardous.

Hazardous Substance: A material including its mixtures and solutions that is listed in the 172.101 - Hazardous Materials Table or is in a quantity, in one package, which equals or exceeds the reportable quantity (RQ) listed in the Hazardous Materials Table.

Hazardous Waste: Any material that is subject to the Hazardous Waste Manifest Requirements of the U.S. Environmental Protection Agency as specified in 40 CFR part 262.

LC50: The concentration of a material in air that on the basis of laboratory tests (inhalation route of entry) is expected to kill 50% of a group of test animal when administered as a single exposure in a specific time period.

Liquefied Compressed Gas: A gas that in a packaging under the charged pressure, is partially liquid at a temperature of 20 degrees Celsius (68 degrees Fahrenheit).

Limited Quantity: The maximum amount of a hazardous material for which there is a specific labeling or packaging exception.

Motor Vehicle: Includes a vehicle, machine, tractor, trailer, or semitrailer, or any combination thereof, propelled or drawn by mechanical power and used upon the highways in the transportation of passengers or property. It does not include a vehicle, locomotive, or car operated exclusively on a rail or rails, or a trolley bus operated by electric power derived from a fixed overhead wire, furnishing local passenger transportation similar to street-railway service.

Non-bulk Packaging: A packaging, which has:

- A maximum capacity less than 450 liters as a receptacle for a liquid;
- A maximum net mass less than 400 kilograms and a maximum capacity less than 450 liters as a receptacle for a solid; or

- A water capacity greater than 454 kilograms.

Non-liquefied Compressed Gas: A gas, other than in solution, which in a packaging under the charged pressure is entirely gaseous at a temperature of 20 degrees Celsius (68 degrees Fahrenheit).

psi: Pounds per square inch.

psia: Pounds per square inch absolute.

Packaging: A container and any other components or materials necessary for the container to perform its containment function in conformance with the minimum packing requirements.

Primary Hazard: The hazard class of a material as assigned in the "172.101 - Hazardous Material Table".

Pyrophoric Material: A liquid or solid that, even in small quantities and without an external ignition source, can ignite within five minutes after coming in contact with air.

Readily Combustible Solids: Materials that are solids and may cause fire through friction, such as matches, or any metal powders that can be ignited and react over the whole length of a sample in ten minutes or less.

Receptacle: A containment vessel for receiving and holding materials, including any means of closing.

Self-heating Material: A material that when in contact with air and without an energy supply, is liable to self-heat.

Self-reactive Materials: Materials that are liable to undergo, at normal or elevated temperatures, a strongly exothermal decomposition caused by excessively high transport temperatures or by contamination.

Subsidiary Hazard: A hazard other than the primary hazard.

Transport Vehicle: A cargo-carrying vehicle such as an automobile, van, tractor, truck, semitrailer, tank car or rail car used for the transportation of cargo by any mode. Each cargo-carrying body (trailer, rail car, etc.) is a separate transport vehicle.

UN: United Nations.

5.3 Hazardous Waste Disposal

Individuals handling hazardous waste must

- Attend hazardous waste training.
- Follow the established hazard waste handling procedures.
- Ensure the waste materials are properly managed in the lab.
- Complete and mail pick-up request forms.

Containers holding hazardous wastes must be

- Filled to no more than 95% capacity to provide sufficient head space for changes in ambient temperatures.
- Securely sealed with an appropriate cap.
- Free of spilled waste materials on exterior.
- Properly tagged to identify contents by chemical name and percent concentration.
- Stored in a secondary container, e.g., cabinet or tub.
- Placed in a secure area, i.e., supervised lab (when no one is present, the area **must be locked**).

Additional Procedures

- All hazardous waste materials must be picked up by EH&S (5-2848).
- All full containers of hazardous waste must be submitted for pickup on a chemical waste pickup form for immediate removal from the lab or work area.
- To prevent spillage, breakage, or accidents and to coincide with quarterly vendor waste shipments, containers should be sized appropriately so that they may be removed within 90 days.
- To conform to regulatory requirements, however, all containers regardless of fullness must be submitted for pickup on chemical waste pickup forms and removed within 9 months.
- Liquid or solid waste may not be disposed of in the trash or poured down the drain unless they are properly screened as no hazardous materials using the "Hazardous Waste Guidelines."
- Incompatible chemical wastes must be segregated in storage and in secondary containment.
- Waste containing carcinogens (e.g., syringes and needles, nutrient media, etc.) must be collected by EH&S.
- Chemically contaminated glassware and broken glassware must be placed in a lined "Fisher" glass box before disposal. Tightly seal the bag by tying or taping and then tape the box lid in place to avoid discharge of materials should the box be inverted; also, securely tape the bottom of large glass boxes to prevent similar incidents.

Special Waste

- Water reactive, pyrophoric, outdated organic peroxides, or other unstable materials must be handled on a case-by-case basis; tag and identify on a chemical waste pickup form.
- Picric acid and their derivatives require special handling arrangements; complete tagging and chem. form requirements.
- Compressed gas cylinders must be returned to the vendor; if vendor is unknown or cylinder is unacceptable to vendor, contact EH&S.
- Empty containers as defined in the Hazardous Waste Guidelines may be placed in the trash, provided labels are defaced; empty containers of extremely hazardous materials (LD50 \leq 50 mg/kg) must be submitted to EH&S for disposal (see Hazardous Waste Guidelines).

Rejection Criteria

Your waste may be rejected for pick-up for any of the following reasons.

Please note that this list is not exhaustive:

- Waste container not identified on pickup form.
- Container not tagged or tag not secure.
- Information on tag incorrect or not properly completed.
- Description on tag not consistent with pickup form.
- Exterior of container contaminated.
- Item number on tag missing or not consistent with pickup form.
- Container type inconsistent with pickup form or incorrectly specified.
- Waste containers are not accessible or cannot be safely moved due to physical storage conditions, chemical contamination in the surrounding environment, etc.

For further information call:

206-616-0587

Waste Minimization

Waste Minimization is any type of reduction in the quantity of hazardous wastes achieved through a conscientious application of innovative or alternative procedures. Simple adjustments to a process producing wastes (e.g. a teaching lab experiment, a vehicle cleaning operation, etc.) may be the only requirement to achieve some results. However, looking at the broader picture in the University environment, it is often difficult to recognize waste reductions due to the complex and changing growth patterns within the campus community. Reductions are often offset by increased staff and student growth and/or building construction.

Waste minimization often results in cost minimization. However, it is not uncommon to devise techniques to minimize costs without a corresponding reduction in waste quantities. For example, proper segregation of wastes will reduce disposal fees but only because these quantities are reassigned to more appropriate waste streams for cost effective disposal/treatment off site. While this is not technically waste minimization, it is still a beneficial process.

Waste Minimization Suggestions

- Substitute less hazardous chemicals or ingredients for ones you are using now.
- Order only the chemicals needed for the short term. You will spend more to dispose of larger amounts of chemicals than you will save by purchasing large orders to get quantity discounts.
- If you're dealing with common household chemicals, call the County Hotline for the latest updates on recommended and available substitutes.
- Test your ideas on the smallest scale practical to minimize disposal costs.
- Keep your wastes segregated by compatibility and type; avoid cross contamination as much as possible.

Start your waste minimization thought process by following the proper campus hazardous waste procedures.

- Review your inventory periodically to remove unwanted or unusable chemical stocks.
- Ensure proper identification is on all chemical containers.
- Attach a properly completed yellow hazardous waste tag to each chemical waste container.
- Complete your waste inventory for EH&S submittal with a Chemical Waste Pickup form.

Call EH&S at 543-7262 if you have any specific questions or need help with your project.

5.4 Chemical and Physical Hazards Monitoring

Policy

Civil and Environmental Engineering Department shall minimize exposure to hazardous chemicals and substances in accordance with all relevant standards and recommended exposure limits.

Authority and Responsibility

Environmental Health and Safety Department is responsible for:

1. Implementing and revising this program in accordance with newly promulgated standards by the Occupational Safety and Health Administration (OSHA) or when circumstances such as exposure incidents or a component of this program fails;
2. Working with the appropriate departments to ensure implementation of these measures; and
3. The Industrial Hygienists are responsible for developing corrective actions and recommending exposure control measures.

Note: Any process where an exposure is determined to be immediately dangerous to the health and safety of an employee or other individual(s) in the affected area shall be stopped by the Environmental Health and Safety Department under the authority of this policy and the statement of authority issued by the University Safety Committee.

Chemicals Monitored

The Environmental Health and Safety Department shall measure an employee's exposure to any substance regulated by a standard, which requires monitoring. For those hazardous chemicals and substances where no relevant standard exists or a recommended limit has been established, the exposure shall be evaluated and limited to the lowest reasonably achievable limit.

Exposure Determinations

Initial monitoring

Initial exposure monitoring shall be conducted for employees and areas in which it is determined that exposures may be in excess of established limits or upon notification by an employee that a potential overexposure exists.

Exposure determinations shall be measured according to the type of exposure the employee(s) or area(s) are subjected. OSHA has established **Permissible Exposure Limits (PELs)** in which it is acceptable to be exposed to certain chemicals based on certain time periods. These limits indicate a level of exposure at which there will be no irreversible health effects associated with exposure to that chemical. PELs may be expressed as **Time-Weighted Average** limits (TWA), **Short-Term Exposure Limits (STEL)** or **Ceiling** limits (C).

1. *Time Weighted Average (TWA)*
The allowable chemical concentration for a normal 8-hour workday and 40-hour work week to which nearly all workers may be repeatedly exposed, day after day, over an employee's lifetime, without adverse health effects.
2. *Short-term Exposure Limit (STEL)*
The maximum concentration for a continuous exposure period of 15 minutes with a maximum of four such periods per day, with at least 60 minutes between exposure periods, and provided that the daily TWA is not exceeded.

3. *Ceiling Limit (C)*
The chemical concentration not to be exceeded at any time.
4. *Immediately Dangerous to Life and Health (IDLH)*
The maximum concentration from which one could escape within 30 minutes without any escape-impairing symptoms or irreversible health effects. (Note: Carcinogenic effects were not considered in setting these values.)

NOTE: OSHA considers "Workers" as healthy individuals. The young, old, ill, and pregnant may be susceptible and have lower tolerances and need to take additional precautions.

For chemicals with no permissible exposure limits or where there is not an OSHA specific standard, the American Conference of Governmental Industrial Hygienists (ACGIH) recommended threshold limit values (TLVs) or National Institute for Occupational Safety and Health (NIOSH) recommended exposure limits (RELs) shall be used.

Periodic monitoring

If the employee's initial exposure determination has exceeded the action level or permissible exposure level, monitoring requirements of the measured contaminant shall be implemented in accordance with the appropriate standard.

Termination of monitoring

Monitoring shall be terminated by Environmental Health and Safety Department in accordance with the relevant standard or in the absence of a standard when the lowest reasonably achievable exposure level has been obtained.

Employee Notification

Employees shall be notified of the results in writing either individually or by posting within fifteen working days after the results of monitoring have been received by Environmental Health and Safety Department. The department director or supervisor shall also receive a copy of the monitoring report.

The monitoring report shall contain the following information:

- Introduction;
- Task analysis;
- Toxicity data;
- Sampling methodology;
- Results;
- Conclusion;
- Recommendations;
- Copy of laboratory analysis results;
- Diagrams/maps; and
- Other relevant information.

Record keeping

Employee monitoring results shall be maintained by Environmental Health and Safety Department for the duration of employment and for a period of 30 years from the date of termination. Copies of monitoring results may be requested by the employee or designee at anytime while employed by University of Chicago by contacting Environmental Health and Safety Department. If the employee is no longer employed by the University, this request shall be in writing.

Monitoring Protocol

All monitoring techniques and practices performed shall follow the appropriate federal, state and local requirements. Monitoring shall be performed with accuracy at the 95% confidence level and within the margins of error required by the standard for the substance being monitored. A 25% margin of error shall be allowed for those substances, which are not regulated by a specific standard.

Corrective Actions

Employees and/or areas which are measured and found to be in excess of established exposure limits shall be evaluated to determine what corrective actions shall be implemented. To achieve compliance and ensure the safety and health of employees, administrative and engineering controls shall be implemented whenever feasible. When such controls are not feasible to achieve compliance, protective equipment or other protective measures shall be used to keep the exposures of the affected employee(s) within the established exposure limits.

Medical Consultation

Where exposure monitoring reveals an exposure level routinely above the action level or permissible exposure level for an OSHA regulated substance with exposure monitoring requirements, medical surveillance shall be established for the affected employee(s) as prescribed by the particular standard.

For additional information, refer to the CEE Department Safety Manual, Chemical Hygiene Plan, Section 5.9.

Water Testing

Environmental Health and Safety Department shall, upon request and as deemed necessary, test potable drinking water for the following constituents:

- Lead;
- PH;
- Turbidity; and
- Copper.

To request an evaluation of potable water in your area, contact Environmental Health and Safety Department at 543-7262.

Noise Sampling

To request an evaluation of the noise levels in your area, contact Environmental Health and Safety Department at 543-7262.

Indoor Air Quality

Upon suspicion of an indoor air quality issue, begin documenting the times, days, and symptoms when problems became evident and immediately contact Environmental Health and Safety Department at 543-7262.

5.5 Hazard Reporting and Investigation

Policy

Any Civil and Environmental Engineering employee who discovers a known or suspected hazardous condition shall immediately report the condition to his/her immediate supervisor and Environmental Health and Safety Department to seek resolution of the condition.

Purpose

The purpose of reporting a known or suspected hazardous condition is to identify and, if warranted, resolve the condition(s) to prevent minor/serious injury, loss of life or property.

Authority and Responsibility

Environmental Health and Safety Department is responsible for:

1. Investigating any alleged hazard(s);
2. Immediately resolving or developing corrective action plans, if necessary;
3. Ensuring implementation of corrective action plans through follow-up inspections;
4. Reporting all hazard evaluation requests, corrective action plans and current status to the University Safety Committee; and
5. Conducting training when deemed necessary.

Employees are responsible for:

1. Reporting any known or suspected hazardous condition(s);
2. Participating in the investigation;
3. Adhering to the corrective action plan; and
4. Participating in appropriate training as deemed necessary.

The *Safety Committee* is responsible for:

1. Reviewing hazard evaluation data for trends; and
2. Reviewing corrective action plans; and

Reporting Criteria

Life Threatening

Immediately report the condition to your supervisor and contact Environmental Health and Safety Department at 543-7262 or the University Police at 9-911.

A representative from Environmental Health and Safety Department will complete a copy of "Appendix A - Hazard Evaluation Request Form" during the investigation.

Non-Life Threatening

Inform your supervisor and complete Section 1 of Appendix A - Hazard Evaluation Request Form, which identifies your contact information, and a description of the alleged hazardous condition. Forward the entire form to:

Environmental Health and Safety Department
201 Hall Health Center, WA 354400

FAX: 543-3351

Once an investigation has been completed, either through the correction of the hazard or a notation that no hazard was detected, Environmental Health and Safety Department shall return a complete copy of the form to the requester.

5.6 Incident Report and Investigation

Policy

All work-related injuries, illnesses or incidents involving University employees, students or visitors shall be reported in accordance with this policy.

Notification

All University employees and students shall inform their immediate supervisor that a work related injury or illness was sustained.

Supervisors shall immediately notify Environmental Health and Safety Department of any incidents involving death or hospitalization.

Procedure

Emergency Medical Attention

1. For incidents occurring *on campus*, contact the University Police at 9-911 to arrange for on-scene medical assistance.
2. For incidents occurring *off campus*, dial 911 to arrange for medical assistance.

General Medical Attention

1. During normal business hours (Monday through Friday 8:00 a.m. to 5:00 p.m.), obtain medical attention from the UW Employee Health Center located in Hall Health, room G07-A.
2. After normal business hours (Monday through Friday after 5:00 p.m., weekends or holidays), obtain medical attention from the the UW Medical Center Emergency Room located at 1959 NE Pacific Street.
3. Always use the "buddy" system when obtaining general medical attention. The "buddy" system means having someone escort the injured individual to receive medical treatment.

Documentation

The supervisor in conjunction with the injured employee shall complete an OARS report (Online Accident Reporting System). <http://www.ehs.washington.edu/ohsoars/>

Investigation

As soon as feasible, the injured employee's supervisor shall conduct an investigation of the incident in conjunction with submitting the OARS report. Environmental Health and Safety Department shall review all submitted OARS reports and may also conduct investigations independent of the department as deemed necessary or as requested.

All corrective actions identified on the form shall be the responsibility of the supervisor and associated department. Environmental Health and Safety Department may be contacted for assistance in developing or implementing corrective action plans.

Proactive

All "unsafe" conditions in the workplace shall be reported to employee supervisors who in turn should contact Environmental Health and Safety Department to ensure "unsafe" conditions are corrected prior to an accident or incident.

Visitors

Report all accidents/incidents involving visitors or other persons who are not University employees to the University Police at 9-911 and Risk Management at 206-543-3773.

5.7 Personal Protective Equipment

Policy

Personal protective equipment including those for eyes, face, head, and extremities, protective clothing, respiratory devices, protective shields and barriers shall be provided, utilized and maintained in a sanitary and reliable condition whenever deemed necessary by reason of hazards, processes or environment.

Scope

This policy applies to all employees who by nature of their job function have the potential to be exposed or come into contact with chemical, physical, radiological or biological hazards which by this exposure can cause illness, injury or impairment in the function of any part of the body.

Authority and Responsibility

Immediate Supervisors are responsible for:

1. Ensuring personal protective equipment is available and providing personal protective equipment as required or upon request to all employees; and
2. Ensuring personal protective equipment is being used by each affected employee during all job tasks, which require such protection.

Environmental Health and Safety and *Departmental Administration* are responsible for:

1. Assessing the workplace to determine if hazards are present, or are likely to be present, which necessitate the use of personal protective equipment;
2. Communicating selection decisions to each affected employee;
3. Selecting personal protective equipment that properly fits each affected employee; and
4. Documenting aforementioned hazard assessment components utilizing Appendix A - Personal Protective Equipment Assessment.

Employees are responsible for:

1. Wearing personal protective equipment upon the direction of their immediate supervisor; and
2. Participating in training.

Considerations

Personal protective equipment devices alone shall not be relied on to provide protection against hazards, but shall be used in conjunction with guards, engineering controls, administration controls and sound manufacturing practices.

When selecting personal protective equipment, utilize the following considerations as a basic directive.

- Application: What part of the body is being protected?
- Chemical Resistance: Will material maintain its structural integrity and protective qualities?
- Strength: Is the material resistant to punctures, tears, and abrasions?
- Flexibility: Do gloves provide the necessary dexterity?
- Thermal Limits: Does clothing maintain its mobility and protective capacity in temperature extremes?

- Cleanable: Can material be easily cleaned and reused?
- Longevity: Will clothing resist aging?

Contact Environmental Health and Safety at 543-7262 for personal protective equipment product recommendations.

Hand Protection

Hand protection shall be worn when hands are exposed to hazards such as those from skin absorption of harmful substances, severe cuts or lacerations, severe abrasions, punctures, chemical burns, thermal burns and harmful temperature extremes.

The type of hand protection used shall be based on the performance characteristics of the hand protection relative to the task(s) to be performed, conditions present, duration of use, and the hazards and potential hazards identified.

With respect to selection of gloves for protection against chemical hazards:

1. The toxic properties of the chemical(s) must be determined; in particular, the ability of the chemical to cause local effects on the skin and/or to pass through the skin and cause systemic effects;
2. Generally, any "chemical resistant" glove can be used for dry powders;
3. For mixtures and formulated products (unless specific test data are available), a glove shall be selected on the basis of the chemical component with the shortest breakthrough time, since it is possible for solvents to carry active ingredients through polymeric materials; and
4. Employees shall be able to remove the gloves in such a manner as to prevent skin contamination.

Head Protection

Head protection shall be worn in areas where there is a potential for injury to the head from impact, flying or falling objects (e.g., working below other workers who are using tools and materials which could fall through grates), or electrical shock and burns.

Helmets for protection against impact and penetration of falling objects shall comply with the "American National Standard for Personal Protection - Protective Headwear for Industrial Workers Requirements" (ANSI) Z89.1. Helmets for protection against electrical shock and burns shall comply with ANSI Z89.2-1971.

Eye/Face Protection

Suitable eye protection or face protection shall be worn when there is the potential for exposure to the eyes or face from flying particles, molten metal, liquid chemicals, acid or caustic liquids, chemical gases or vapors or potentially injurious light radiation. Side protection is required when there is a hazard potential from flying objects. Detachable side protectors (e.g., clip-on or slide-on shields) meeting the pertinent requirements are acceptable.

Eye protection shall be durable, comfortable and easy to clean. Persons whose vision requires the use of corrective lenses and whom by nature of their job duties require eye protection shall wear goggles or a full-face shield that can be worn over the prescription lenses.

There are four general classes of eye and face protection: safety glasses, face shields, goggles and welding helmets. The type of protection required shall be determined by the type and degree of the hazard and shall comply with ANSI Z87.1-1989 "American National Standard Practice for Occupational and Educational Eye and Face Protection".

Safety glasses shall be worn at all times in the following locations:

- Academic and research laboratories;
- Facilities Services Shops (e.g., welding, carpentry, automotive);
- All areas where airborne materials are present; and
- Clinics where invasive patient related tasks are conducted.

Foot Protection

Foot protection shall be worn when there is the potential for injury to the feet from falling or rolling objects, objects piercing the sole of the foot, electrical hazards, hot surfaces and slippery surfaces.

Foot protection shall comply with ANSI Z-1991 "American National Standard for Personal Protection - Protective Footwear".

Respirators

Use of respirators shall be done in accordance with the Respiratory Protection Program, section 4.16.

Body Protection

Full body protection shall be worn when there is a potential for contamination or exposure to other parts of the body (e.g., legs, arms, back, chest) from heat, splashes from hot metals and liquids, impacts, cuts, chemicals and radiation.

Body protection includes the following:

- Lab coats;
- Boot covers;
- Aprons;
- Bouffant caps;
- Tyvek suits; and
- Coveralls.

Electrical Protective Devices

Rubber insulating equipment shall be used/worn to protect employees from shocks/burns while working on "live" electrical systems.

Rubber insulating equipment shall comply with the following American Society for Testing and Materials (ASTM) standards:

- Specification for Rubber Insulating Gloves (D120-87E1);
- Specification for Rubber Insulating Matting (ASTM D178-93 or D178-88);
- Specification for Rubber Insulating Blankets (ASTM D1048-93 or D1048-88a);
- Specification for Rubber Insulating Covers (ASTM D1049-93 or D1049-88);
- Specification for Rubber Insulating Line Hose (ASTM D1050-90); and
- Specification for Rubber Insulating Sleeves (ASTM D1051-87).

All electrical protective equipment shall be subjected to periodic electrical tests conducted in accordance with appropriate voltages identified by ASTM standards to reliably indicate whether the insulating equipment can withstand the voltage involved. Insulating equipment failing to pass inspections or electrical tests shall NOT be used by employees.

Rubber insulating equipment test intervals shall occur as follows:

- Rubber insulating line hoses shall be tested upon indication that the insulating valve is suspect;
- Rubber insulating covers shall be tested upon indication that the insulating valve is suspect;
- Rubber insulating blankets shall be tested before first issue and every twelve months thereafter;
- Rubber insulating gloves shall be tested before first issue and every six months thereafter; and
- Rubber insulating sleeves shall be tested before first issue and every twelve months thereafter.

Note: If the insulating equipment has been electrically tested but not issued for service, it shall not be placed into service unless it has been electrically tested within the previous twelve months.

All departments using rubber-insulating equipment shall make the appropriate arrangements for testing of such equipment.

Maintenance Schedules

Personal protective equipment shall be inspected, cleaned and maintained at regular intervals so that the personal protective equipment can be discarded, changed and/or decontaminated as deemed necessary. At a minimum, all personal protective equipment shall be discarded when it has become contaminated, worn, torn or has other integrity problems.

Personal protective equipment provides the requisite protection. It is important to ensure that contaminated personal protective equipment which cannot be decontaminated is disposed in a manner that protects employees from exposure to hazards.

Note: Inspect personal protective equipment before each use for tears, punctures, holes, cuts, cracks, embedded foreign objects and texture changes (e.g., swelling, softening, hardening, becoming sticky or inelastic).

Training

Initial Training

Initial training shall be provided by Facilities Services - Safety and Environmental Affairs or the appropriate department for each employee who is required to use personal protective equipment. This training shall utilize the "Personal Protective Equipment" training booklet generated by Facilities Services - Safety and Environmental Affairs, which shall be updated to ensure consistency with changes in protective equipment and work processes. Each employee shall be trained in at least the following:

- When personal protective equipment is necessary;
- What personal protective equipment is necessary;
- How to properly don, doff, adjust, and wear personal protective equipment;
- The limitations of the personal protective equipment; and
- The proper care, maintenance, useful life and disposal of the personal protective equipment.

Each affected employee shall demonstrate an understanding of the aforementioned training and the ability to use personal protective equipment properly before being allowed to perform work requiring the use of personal protective equipment.

Retraining

When there is reason to believe that any affected employee who has already been trained does not have the understanding and skill as required above, Facilities Services - Safety and Environmental Affairs or the affected department shall retrain each such employee. Circumstances where retraining is required include, but are not limited to, situations where:

- Changes in the workplace render previous training obsolete;
- Changes in the types of personal protective equipment to be used render previous training obsolete; or
- Inadequacies in an affected employee's knowledge or use of assigned personal protective equipment indicate that the employee has not retained the requisite understanding or skill.

Record keeping

Environmental Health and Safety shall verify that each affected employee has received and understood the required training through a written certification containing the name of each employee trained, the date(s) of training and the subject of the certification.

5.8 Hazard Communication

Please note that this program has a glossary. The glossary contains the definitions for various terms used in the program. These terms are highlighted in bold print the first time they appear in the body of the program.

Policy

All **employees** have both a need and right to know the hazards and identities of the **chemicals** they are exposed to when working as identified in the Hazard Communication Program, which provides safe work places for employees.

Scope

The Hazard Communication Program establishes requirements for informing University employees who work with or are exposed to **hazardous chemicals** of the **physical and health hazards** posed by those materials. This applies to any chemical that is known to be present in the **workplace** in such a manner that employees may be exposed under normal conditions of use or in a **foreseeable emergency**.

Exception

This applies to laboratories only as follows:

1. Employers shall ensure that labels on incoming **containers** of hazardous chemicals are not removed or defaced;
2. Employers shall maintain all **Material Safety Data Sheets (MSDS)** for incoming containers of hazardous chemicals and ensure that they are readily accessible to employees;
3. Employers shall ensure that employees are provided information and training on the associated hazards of chemicals in their workplace; and
4. Laboratory employers that ship hazardous chemicals are considered to be either a chemical manufacturer or a distributor under this rule, and thus must ensure that any containers leaving the laboratory are labeled in accordance with the labeling requirements of this document and that a material safety data sheet is provided to distributors and other employers.

Refer to the CEE Safety Manual, Chemical Hygiene Plan, Section 5.9 for specific requirements affecting laboratory employees.

For additional exceptions to this policy, please refer to Appendix A.

Authority and Responsibility

Environmental Health and Safety Department has the primary responsibility and authority for the implementation and enforcement of the Hazard Communication Program and is responsible for:

1. Reviewing and revising the Hazard Communication Program annually to assure compliance;
2. Providing general information and training relating to Hazard Communication for affected University employees;
3. Maintaining and updating the MSDS Program;
4. Developing and implementing a universal hazardous chemical labeling system;
5. Establishing emergency procedures to properly handle hazardous material releases (refer to the University's Emergency Response Plan for Hazardous Materials, Section 1.7); and
6. Identification of appropriate personal protective equipment (PPE).

Department Supervisors are responsible for:

1. Notifying all employees of the purpose and intent of the Hazard Communication Program;
2. Assuring that affected employees are trained in General Hazard Communication;
3. Providing department specific information and training relating to Hazard Communication for affected University employees; and
4. Providing personal protective equipment.

Affected *Employees* are responsible for:

1. Complying with the Hazard Communication Program procedures;
2. Participating in the University's General Hazard Communication training session and Department specific training sessions;
3. Understanding how to read chemical labels and Material Safety Data Sheets;
4. Understanding and taking necessary precautions when handling hazardous chemicals; and
5. Using personal protective equipment.

Information and Training

Employees shall receive information and training on hazardous chemical in their work area at the time of their initial assignment, and whenever a new physical or health hazard the employees have not previously been trained about is introduced into their work area. Information and training may be designed to cover categories of hazards (i.e., flammability, carcinogenicity) or specific chemicals. Chemical-specific information shall always be available through labels and material safety data sheets. Environmental Health and Safety Department shall provide all General Hazard Communication Training.

This general training program shall provide an introduction to the following:

- The requirements of the standard;

- Any operations in their work area where hazardous chemicals are present;
- The location and availability of the written Hazard Communication Program;
- The details of the Hazard Communication program including an explanation of the labeling system and the material safety data sheet and how employees can obtain and use the appropriate hazard information;
- Methods and observations that may be used to detect the presence or release of a hazardous chemical in the work area;
- The physical and health hazards of the chemicals in the work area; and
- The measures employees can take to protect themselves from these hazards, including work practice controls, emergency procedures and personal protective equipment.

Department specific training shall be conducted upon employment, and whenever a new hazard (i.e., new class of chemical hazards, a change in assignment or a new process which may be hazardous) is introduced into an employee's **work area**. Department specific Hazard Communication Training shall include information on:

- a. Specific chemical hazard classes found in the work area;
- b. Location of the University's Hazard Communication Program within the department;
- c. Specific location and availability of the department's Material Safety Data Sheets;
- d. Available personal protective equipment (see Section 5.7 for additional information) and appropriate emergency procedures for chemicals found within the work area as outlined by the Material Safety Data Sheets; and
- e. Location and availability of appropriate chemical labels.

Material Safety Data Sheets

Material Safety Data Sheets are the primary data source intended to outline the special precautions and controls necessary for handling specific hazardous chemicals. Material Safety Data Sheets are typically provided by the chemical manufacturer or chemical supplier and usually divided into several different sections, approximately 8 to 10 sections. The different sections of an MSDS may vary slightly from manufacturer to manufacturer (i.e., section titles and section order), but each MSDS shall contain the following information:

- Chemical identification;
- Physical and chemical characteristics;
- Physical hazards;
- Health hazards;
- Primary routes of entry;
- Occupation Safety and Health Administrations (OSHA's) **permissible exposure limit (PEL)**;

- Carcinogenicity;
- Generally applicable precautions for safe handling and use;
- Generally applicable control measures;
- Emergency and first aid procedures;
- Date of preparation;
- Name, address and telephone number of the chemical manufacturer; and
- Disposal procedures.

Obtaining MSDSs

Material Safety Data Sheets are readily available upon request 24 hours a day and shall be accessible by one of the following methods:

- Accessing the University on-line account with CCINFO (refer to Appendix B);
- Contacting the chemical manufacturer; or
- Contacting Environmental Health and Safety Department at 543-7262 (information provided within 24 hours of the request).

Labeling

To ensure that appropriate information concerning the hazards of a chemical are accessible to employees, all containers of hazardous chemicals shall be labeled. Labels shall be legible, in English (additional languages may be included as necessary), and prominently displayed on the container. Chemical manufacturers, importers, and distributors shall ensure that every container of hazardous chemicals entering the workplace is appropriately labeled with the identity of the hazardous chemical(s) (common and/or **chemical name**), appropriate hazard warnings; and the name and address of the chemical manufacturer, importer or other responsible party.

If a chemical label in the workplace becomes damaged, illegible, or is inadvertently removed from a container, it shall be replaced immediately by the supervisor or designee.

Replacement labels shall include, at a minimum, the identity of the hazardous chemical(s) (common and/or chemical name), appropriate hazard warnings or alternatively, words, pictures, symbols or combination thereof, which provide at least the general information regarding the hazards of the chemicals.

Chemicals which are transferred from the original container into a secondary container shall be identified by a label on the secondary container. *Exception:* A secondary container is not required to be labeled if the material will be completely used during that employee's work shift; however, Environmental Health and Safety Department strongly recommends that all secondary containers be labeled despite this exception.

To comply with labeling requirements, the University has adopted the National Fire Protection Association (NFPA) labeling system.

Call (617) 770 – 3000 for information related to labels.

The following colors are used to represent the hazards on the NFPA label:

- a. Red represents the fire hazard;
- b. Blue represents the health hazard;
- c. Yellow represents the reactivity hazard; and
- d. White represents the specific hazard.

The University is in the process of phasing out use of the NFPA labeling system, and is adopting the Globally Harmonized System (GHS) for chemical labeling and hazard communication.

Glossary

Chemical: Any element, chemical compound or mixture of elements obtained by a chemical process or used for producing a chemical effect.

Chemical Name: The scientific designation of a chemical in accordance with the nomenclature system developed by the International Union of Pure and Applied Chemistry (IUPAC) or the Chemical Abstracts Service (CAS) rules of nomenclature, or a name which will clearly identify the chemical for the purpose of conducting a hazard evaluation.

Container: Any bag, barrel, bottle, box, can, cylinder, drum, reaction vessel, storage tank, or the like that contains a hazardous chemical.

Employee: A worker who may be exposed to hazardous chemicals under normal operating conditions or in foreseeable emergencies. Workers such as office workers who encounter hazardous chemicals only in non-routine, isolated instances are not included.

Foreseeable Emergency: Any potential occurrence such as, but not limited to, equipment failure, rupture of containers, or failure of control equipment that could result in an uncontrolled release of a hazardous chemical into the workplace.

Hazardous Chemical: Any chemical, which is a physical, or health hazard.

Health Hazard: A chemical for which there is statistically significant evidence based on at least one study conducted in accordance with established scientific principles that acute or chronic health effects may occur in exposed employees. The term "health hazard" includes chemicals which are carcinogens, toxic or highly toxic agents, reproductive toxins, irritants, corrosives, sensitizers, hepatotoxins (liver damage), nephrotoxins (kidney damage), neurotoxins (nervous system damage), agents which act on the hematopoietic system (decreases hemoglobin function), and agents which damage the lungs, skin, eyes, or mucous membranes.

Material Safety Data Sheet (MSDS): Written or printed material concerning a hazardous chemical that is prepared in accordance with 29 CFR 1910.1200 (g).

Permissible Exposure Limit (PEL): An exposure limit established and enforced by the Occupational Safety and Health Administration (OSHA) which may be expressed as a time-weighted average (TWA) limit, short term exposure limit (STEL), or ceiling exposure limit.

Physical Hazard: A chemical for which there is scientifically valid evidence that it is a combustible liquid, compressed gas, explosive, flammable, organic peroxide, oxidizer, pyrophoric, unstable (reactive), or water-reactive.

Work Area: A room or defined space in a workplace where hazardous chemicals are produced or used and where employees are present.

5.9 Chemical Hygiene

Please note that this program has a [glossary](#). The glossary contains the definitions for various terms used in the program. These terms are highlighted in bold print the first time they appear in the body of the program.

Policy

All laboratories engaged in the **laboratory use** of hazardous chemicals or other facility which operates on a **laboratory scale** shall adhere to the requirements stated in the **Chemical Hygiene Plan** and all related programs in the Safety Manual.

Exceptions

The "Occupational exposure to hazardous chemicals in laboratories" 29 CFR 1910.1450 does not apply to the following:

- Use of hazardous chemicals which do not meet the definition of laboratory use; and
- Laboratory use of hazardous chemical, which provide no potential for employee exposure. Examples of such conditions might include:
 - Procedures using chemically-impregnated test media such as Dip-and-Read tests where a reagent strip is dipped into the specimen to be tested and the results are interpreted by comparing the color reaction to a color chart supplied by the manufacturer of the test strip; and
 - Commercially prepared kits such as those used in performing pregnancy tests in which all of the reagents needed to conduct the test are contained in the kit.

Authority and Responsibility

The University's **Chemical Hygiene Officer** shall be responsible for:

1. Conducting annual and periodic Laboratory Reviews;
2. Developing and implementing a chemical inventory and monitoring program;
3. Identifying and monitoring corrective action plans;
4. Reviewing laboratory designs;
5. Assessing of **personal protective equipment**;
6. Developing and conducting Laboratory Safety training;
7. Managing the University's **Material Safety Data Sheet (MSDS)** Program;
8. Complying with environmental regulations regarding management of hazardous waste generated by laboratories;
9. Providing guidance and acting as a resource to departmental safety committees and personnel;
10. Ensuring compliance with all components of the Chemical Hygiene Plan;
11. Complying with the requirements of the University's Chemical Hygiene Plan and all relevant sections of this manual;
12. Ensuring that the laboratory personnel follow the requirements set forth in the Chemical Hygiene Plan;
13. Providing a safe and healthy work environment for all laboratory personnel;
14. Complying with all other applicable programs affecting the health and safety of laboratory personnel; and
15. Assisting in the development of **laboratory** specific standard operating procedures.

Laboratory personnel shall be responsible for:

1. Developing laboratory specific standard operating procedures;
2. Conducting all laboratory work in accordance with the standard operating procedures;
3. Developing good personal chemical hygiene habits; and
4. Notifying the **laboratory director** and Environmental Health and Safety Department of any incidents involving material releases, unsafe conditions and other adverse health, safety and environmental conditions.

Laboratory technicians/supervisor are responsible for:

1. The overall responsibility for chemical hygiene in the laboratory;
2. Ensuring that workers know and follow the chemical hygiene rules, that protective equipment is available and in working order and that appropriate training has been provided;
3. Providing regular chemical hygiene and housekeeping inspections including routine inspections of emergency equipment;
4. Knowing the current legal requirements concerning regulated substances;
5. Determining the required levels of protective apparel and equipment; and
6. Ensuring that facilities and training for use of any material being ordered are adequate.

Reference Location

Environmental Health and Safety Department shall maintain an extensive reference library that is available for the use by interested individuals.

Chemical Hygiene Plans

Each laboratory supervisor/technician shall establish laboratory specific standard operating procedures in accordance with this program. Procedures shall be maintained and updated by the laboratory supervisor as necessary and be available for review upon request by representative of Environmental Health and Safety Department and/or a regulatory agencies. The procedures shall contain at a minimum the following sections:

1. List of personnel working within the laboratory;
2. Emergencies:
 - Listing of important phone numbers in the event of an emergency;
 - Emergency procedures for chemical and/or biological spills;
 - Procedures for personal injury; and
 - Procedures for security violations;
3. Access restrictions into the laboratory;
4. Standard Operating Procedures:
 - Use of personal protective equipment;
 - Work practices;
 - Personal hygiene practices;
 - Special procedures and precautions;
 - Methods for deviation from standard operating procedures;
 - Development of new procedure requirements/review;
 - Medical consultation and surveillance and names of personnel affected;
 - Control measures (e.g., storage, housekeeping, inventories, labeling, use of containment devices, respirators, ventilation)
 - Housekeeping procedures and requirements;
 - Chemical inventory updating procedures and submission dates to Environmental Health and Safety Department;
 - Segregation procedures for storage of **hazardous chemicals** and hazardous waste within the laboratory;
 - Refrigeration storage procedures for chemicals and biological;
 - Use of fume hoods and biological safety cabinets;
 - Visitor procedures;
 - **Employee** training;
 - List of dates and names of those personnel who have gone through laboratory safety training; and
 - Laboratory policy concerning frequency and mandatory requirement of training signed by the laboratory supervisor.

5. Special procedures for dealing with flammable, corrosive, **reactive**, toxic and carcinogenic chemicals and common symptoms of overexposure; and
6. Emergency Equipment:
 - Testing and use of eyewash/shower stations;
 - Evaluation of fire extinguishers and use; and
 - Fire drill frequency.

Standard operating procedures may be applicable to more than one laboratory or may encompass an entire department only if the standard operating procedures and methods to control exposures are identical within each laboratory.

Each laboratory's standard operating procedures shall be reviewed at least annually by Environmental Health and Safety Department during Annual Laboratory Safety Inspections. Laboratories shall also retain a copy of the University's Chemical Hygiene Plan in each laboratory for immediate use by employees. Each laboratory shall receive updates to the Chemical Hygiene Plan as they become available.

Each lab shall develop and adhere to the following minimum standard operating procedures.

Personal Protective Equipment (PPE)

Use of personal protective equipment shall be evaluated for all existing and proposed laboratory work in accordance with the Personal Protective Equipment policy, Sections 4.10 or 5.7. Those employees who are exposed to hazards shall use personal protective equipment and participate in training on the proper use, limitations, maintenance and storage of such equipment.

At a minimum, the following personal protective equipment shall be worn by all **laboratory employees** engaged in the handling and use of hazardous chemicals:

1. Eye protection;
2. Laboratory coats/aprons; and
3. Shoes with full uppers (no open-toed shoes or sandals).

These are minimum requirements for personal protective equipment. Additional personal protective equipment shall be utilized as warranted by a specific hazard. Contact Environmental Health and Safety Department prior to conducting such work for assistance in the identification of additional personal protective equipment.

Respirators

Use of respirators shall be done in accordance with the Respiratory Protection Program, Section 4.16.

Fume Hoods

Fume hood use and maintenance shall be in accordance with the Chemical Fume Hoods policy, Section 5.13 of the Department's Safety Manual.

Biological Safety

The biological safety section of this program is Section 6. Additional information can also be obtained from Environmental Health and Safety Department.

Biological Safety Cabinets

Biological Safety Cabinets shall be used and maintained in accordance with the Biological Safety Cabinets policy, Sections 6.5 and 6.6 of this Safety Manual.

Chemical Segregation

Segregation of laboratory chemicals shall be done in accordance with the following segregation scheme or an equally effective system developed by the laboratory supervisor or department.

Class 1	Flammable or combustible and not highly toxic; flammable or combustible and toxic; peroxidizable; provided in all cases the chemical is compatible with water
Class 2	Identical to class 1 except that all in this class are not compatible with water
Class 3	Oxidizing agents and nonflammable/combustible, not highly toxic; oxidizing agents and nonflammable/combustible that are toxic; each compatible with water
Class 4	Identical to class 3 except none compatible with water
Class 5	Air sensitive and not highly toxic; air sensitive and toxic
Class 6	Require refrigeration and not highly toxic; require such storage and toxic
Class 7	Compressed gas cylinders and other gas containers, divided into four subclasses: oxidizing agents, reducing agents, corrosives and highly toxic substances; each subdivided into two subclasses, empty and full
Class 8	Unstable chemicals (e.g., explosive, short shelf life)

The segregation schematic in no means is a foolproof system for chemical segregation; however, it is far superior over the alphabetical and inorganic/organic systems.

Laboratory Hygiene

All laboratories shall establish procedures, which provide for and ensure proper laboratory hygiene. These practices shall include the following:

1. Food or drink shall **NOT** be stored or consumed within laboratories;
2. Smoking is prohibited;
3. Applying cosmetics is prohibited;
4. Eye protection shall be worn at all times in laboratories;

5. Laboratory coats/aprons shall be used during chemical manipulations;
6. Contact lens shall be prohibited unless vent-less goggles are used;
7. Laboratory clothing shall cover the legs and not be loose or flowing;
8. Mouth pipetting is prohibited;
9. Open-toed shoes (e.g., sandals) are prohibited;
10. Hand washing before taking breaks and at the end of each day; and
11. Secure hair back and off the shoulders.

Material Safety Data Sheets (MSDS)

Environmental Health and Safety Department maintains over 150,000 MSDSs on file which are updated quarterly. MSDSs can also be obtained by any of the methods listed in the Hazard Communication Program, Section 5.8 of this Safety Manual.

Transportation of Chemicals

For additional information regarding the shipment of hazardous materials off-site, refer to the Hazardous Materials Transportation program, Section 5.2 of this Safety Manual.

Housekeeping

Housekeeping shall be performed continuously. The laboratory work area shall be kept neat and orderly including the following general practices:

1. All waste shall be properly labeled and segregated;
2. All working surfaces shall be cleaned on a regular schedule;
3. Chemicals shall not be stored on floors, in aisles, stairwells or hallways; and
4. Access to emergency equipment shall remain clear at all times.

Glassware

Glassware that is broken, cracked or chipped shall not be used. Pipettes shall not protrude from bottles, flasks or beakers. When stoppers are stuck on gas tubing, do **not** attempt to force removal but instead cut them off. Glassware shall be decontaminated after exposure to potentially harmful substances such as infectious agents or chemical agents. Dispose of broken glass in a labeled puncture-proof container.

Working Alone

Avoid working alone in a laboratory if the procedures being conducted are hazardous.

Refrigerators/Cold Rooms

Use of refrigerators and cold rooms shall be done in accordance with the requirements stated below:

1. Storage of flammable liquids is permitted only in flammable material or explosion safe/proof refrigerators;

2. Each refrigerator shall be labeled stating whether it is or is not suitable for storing flammable liquids; and
3. Cold rooms shall be maintained in an orderly manner and shall not be used to store chemicals.

Labels and Signs

All containers of hazardous chemicals shall be provided with **labels** in accordance with the labeling procedure detailed in the Hazard Communication Program, Section 5.8 and additional requirements stated in this program.

Signage within laboratories shall be unobstructed at all times and written in English. Signage requirements shall be evaluated during annual inspections. Contact Environmental Health and Safety Department for signage recommendations and requirements.

Identification Data Cards

Each laboratory is required to have a laboratory identification data card posted at each corridor entrance to the laboratory. The data card displays information concerning laboratory responsibility, hazards located within the laboratory and unattended operations in process. Each card shall be updated annually. A representative from Environmental Health and Safety Department will issue a form to update the identification card as part of the annual laboratory review program.

Waste Disposal

Refer to the Hazardous Materials Management program, section 5.12 of this Safety Manual.

Chemical Inventories

Refer to the Chemical Inventories program, section 5.11 of this Safety Manual.

General Emergency Procedures

For specific information pertaining to a chemical or infectious agent spill, refer to the Emergency Quick Reference, Section 1.2 for Chemical Spills and Section 1.5 for Biohazard Infectious Response.

Exposure Monitoring

For laboratory uses of OSHA regulated substances, the employer shall assure that laboratory employee's exposure to such substances do not exceed the permissible exposure limits specified in 29 CFR part 1910 subpart Z.

For specific information pertaining to chemical exposure monitoring, refer to the Chemical and Physical Hazards Monitoring Program, Section 5.4.

Medical Surveillance

Medical examinations shall be conducted by a physician at the Primary Care Group or personal health care provider for any employee under the following circumstances:

1. Whenever an employee develops signs or symptoms associated with exposure to a hazardous chemical(s) used in the laboratory;
2. Where exposure monitoring reveals an exposure level routinely above the action level (or in the absence of an action, level the permissible exposure level) for an OSHA regulated substance for which there are exposure monitoring and medical surveillance requirements; or
3. Whenever an event takes place in the work area such as a spill, leak, explosion or other occurrence resulting in the likelihood of a hazardous exposure.

When reporting a known or suspected overexposure to a hazardous chemical, follow the procedure detailed in the Incident Reporting and Investigation Program, section 5.6 of this Safety Manual.

All medical examinations shall be performed by or under the direct supervision of a licensed physician at Primary Care Group.

Facilities Services - Safety and Environmental Affairs shall provide the following information to a physician:

1. The identity of the hazardous chemical(s) to which the employee may have been exposed;
2. A description of the conditions under which the exposure occurred including quantitative exposure data, if available; and
3. A description of the signs and symptoms of exposure that the employee is experiencing, if any.

Upon consultation and/or examination, the physician shall provide a written opinion including the following:

1. Any recommendations for further medical follow-up;
2. Results of medical examinations and any associated tests;
3. Any medical condition which may be revealed in the course of the examination which may place the employee at increased risk as a result of exposure to a hazardous chemical found in the workplace;
4. A statement that the employee has been informed by the physician of the results of the consultation or medical examination and any medical condition that may require further examination or treatment; and
5. The written opinion shall not reveal specific findings of diagnoses unrelated to occupational exposure.

Information and Training

The laboratory director shall ensure that the laboratory employees are aware of the hazards of chemicals present in their work area.

Training shall be conducted at the time of the laboratory employee's initial assignment to a work area where hazardous chemicals are present and prior to assignments involving new exposure situations. Training specific to laboratory protocols shall be provided by the laboratory director or designee on a regular, ongoing basis. Facilities Services - Safety and Environmental Affairs shall be responsible for providing initial training on general laboratory safety.

Glossary

Chemical Hygiene Officer: The designated, qualified employee who assists in the development, implementation and monitoring of compliance with the Chemical Hygiene Plan.

Chemical Hygiene Plan: A written program that includes specific work practices, standard operating procedures, equipment, engineering controls and policies to ensure that employees are protected from hazardous exposure levels to all potentially hazardous chemicals in use within their work areas.

Compressed Gas: Any material which is a gas at normal temperature and pressure, and which is contained under pressure as a dissolved gas or liquefied by compression or refrigeration.

Employee: An individual employed in a laboratory workplace who may be exposed to hazardous chemicals in the course of his or her assignments.

Laboratory Employee: Individuals employed in a laboratory work place who may be exposed to chemical hazards in the course of an assignment.

Hazardous Chemical: Any chemical, which is a physical, or health hazard.

Health Hazard: A chemical for which there is statistically significant evidence based on at least one study conducted in accordance with established scientific principles that acute or chronic health effects may occur in exposed employees. The term "health hazard" includes chemicals which are carcinogens, toxic agents, reproductive toxins, irritants, corrosives, sensitizers, hepatotoxins (liver damage), nephrotoxins (kidney damage), neurotoxins (nervous system damage), agents which act on the hematopoietic system (decreases hemoglobin function), and agents which damage the lungs, skin, eyes, or mucous membranes.

Label: Any written or printed words, pictures, symbols or combination thereof displayed on or affixed to a hazardous chemical container which conveys the name of

the hazardous material, appropriate hazard warning(s), and the name and address of the chemical manufacturer, importer or other responsible party.

Laboratory: A facility where the "laboratory use" (relatively small quantities of hazardous chemicals are used in a non-production basis) of hazardous chemicals occurs.

Laboratory Director: An individual who supervises or manages a laboratory.

Laboratory Scale: Work involving containers of substances used for reactions and transfers that are designed for easy and safe handling by one person. Work places that produce commercial quantities of materials are excluded from the definition of "Laboratory Scale".

Laboratory Use: Utilization of hazardous chemicals based on ALL of the following conditions:

- Chemical manipulations are carried out on a "laboratory scale";
- Multiple chemical procedures or chemicals are used;
- The procedures involved are not part of a production process, nor in any way simulate a production process; and
- "Protective Laboratory Practices and Equipment" are available, and in common use, to minimize the potential for employee exposure to hazardous chemicals.

Material Safety Data Sheet (MSDS): Written or printed material concerning a hazardous chemical, which is prepared in accordance with 29 CFR 1910.1200 (g) "Hazard Communication".

Permissible Exposure Limit (PEL): An exposure limit established and enforced by the Occupational Safety and Health Administration (OSHA) which may be expressed as a time-weighted average (TWA) limit, short term exposure limit (STEL) or ceiling exposure limit (C).

Personal Protective Equipment (PPE): Devices or clothing worn to help protect a worker from direct exposure to hazardous materials.

5.10 Chemical Inventories

Policy

A current chemical inventory shall be maintained for each location that stores hazardous materials at the University and off-site locations under the University's jurisdiction.

Authority and Responsibility

Environmental Health and Safety department is responsible for:

1. Reviewing all submitted inventories and determining compliance with applicable reporting regulations;
2. Identifying all materials that could pose a health, safety or environmental hazard in the event of an uncontrolled release;
3. Conducting surveys and audits as deemed necessary; and
4. Providing annual inventory summaries to locations that submitted previous inventories.

Departments, Immediate Supervisors and Principal Investigators are responsible for:

1. Submitting a chemical inventory for each location under their responsibility upon the request of Environmental Health and Safety department;
2. Providing complete and accurate information; and
3. Updating inventories whenever new chemicals are purchased or old chemicals are removed.

Submission Requirements

All locations that store chemicals or other hazardous materials are required to keep a current inventory. A hazardous material is defined as any material listed by the Federal or State Environmental Protection Agency or any material that exhibits one or a combination of the following characteristics: flammable, corrosive, toxic and/or reactive. The inventory shall list the following:

1. Location where materials are stored;
2. Date of most recent update;
3. Responsible department and principal investigator or immediate supervisor; and
4. Material name and quantity.

Chemical inventories shall be submitted to Environmental Health and Safety department upon request of the information. Environmental Health and Safety department shall return all previously submitted inventories to each reporting location following annual laboratory reviews.

Any additions, deletions or other changes shall be marked directly on the form(s) and the form shall be returned to Environmental Health and Safety department by the required submission date. If the inventory has not changed, please note this on the form. All data shall be tracked and updated upon receipt.

Instructions for Completion

For completion of all chemical inventories, adhere to the following:

1. Print or type all new entries on the bottom of the list;

2. Make a separate copy of the checklist for each room, laboratory or shop;
3. Do not include research materials that are not hazardous and in a quantity equal to or less than 500 grams or 500 milliliters.

5.11 Hazardous Materials Management

Policy

All hazardous waste shall be managed in accordance with federal, state and local regulations.

Waste Minimization

In an effort to reduce the amount of chemicals needing disposal, the following guidelines shall be followed:

1. Only purchase what is needed for a three to six month period;
2. If practical, use non-hazardous materials;
3. If the chemical is still useful, recycle the waste instead of disposing of it by finding an associate that could use the remainder of the chemical;
4. If the material can be safely neutralized at the point of use, then do so;
5. The contractor providing disposal services shall segregate chemical waste from non-hazardous waste.

Hazardous Material Disposal

The United States Environmental Protection Agency (USEPA) has developed a listing of chemicals considered to be hazardous. These chemicals include spent solvents, poisons and corrosives. If a chemical exhibits any one of the following characteristics, the chemical would be considered hazardous.

1. Ignitable
2. Corrosive
3. Reactive
4. Toxic

Disposal of these materials into sinks, drains, commodes or other sewage disposal channels is **STRICTLY PROHIBITED**.

Disposal Procedures

Waste shall be collected from the area in which the waste is located. If special access arrangements or instructions are needed, provide this information when making arrangements for a chemical pick-up.

Note: If the waste is accumulated by the generator at the point of generation, prior to removal by the disposal contractor, no more than 55 gallons of a hazardous chemical and only one-pound of an acutely hazardous chemical can be accumulated.

Hazardous Material Waste Form

The generator prior to a waste pick-up shall complete form UoW 1470 or 1471 and labels (forms and labels can get at www.ehs.washington.edu). A copy of this form shall be provided to the person(s) removing the waste for disposal. Waste will not be collected without the completion of the form. Each type of waste and associated quantity shall be listed as accurately as possible.

Labeling

All hazardous waste containers shall be properly labeled to indicate the type of material contained in the container. Containers of hazardous waste that are not labeled in accordance with this policy shall not be removed from the area until such label is affixed to the container. If the contents of the container are unknown, please indicate this on the label.

Packaging

All hazardous waste shall be packaged in accordance with the following instructions.

1. Use a leak-proof container that will safely contain the contents. Chemical flasks, plastic bags or culture dishes will not be accepted. Containers must be closable.
2. The container shall not be overfilled with liquid waste. Empty space of at least five percent of the container volume shall be left to allow for thermal expansion.
3. Be suspicious of any pressure build-up inside the container. If this is a concern when closing the container, do not secure the cap tightly and if appropriate, place the container inside a fume hood or other well ventilated area until the chemical is removed by the waste collector.
4. If a safety can(s) or re-usable container(s) is used, write your location on the can with a permanent marker to ensure the return of your safety can within one week.
5. Old cans of ether, picric acid and other peroxide forming compounds shall be left in place and not moved until the waste collector has evaluated the condition of the container.
6. If waste is accumulated over time, list the accumulation start date and disposal date on the container.

Scintillation Vials

These are de-regulated vials if they are below 0.05 microcuries per milliliter and shall be disposed of in accordance with this program. All other vials greater than 0.05 microcuries per milliliter shall be disposed of through the Environmental Health and Safety department (543-7262).

Mixed Waste

If mixed waste such as a radioactive compound combined with an infectious agent is being generated, Environmental Health and Safety department and/or the Radiation

Safety Office (543-0463) shall be contacted to determine the proper disposal procedure.

Storage Areas

Hazardous waste shall be stored according to the Chemical Hygiene Plan, Section 5.9 of this Safety Manual.

5.12 Chemical Fume Hoods

Policy

Facilities Services - Safety and Environmental Affairs shall assist with certifying and maintaining all chemical and horizontal/vertical laminar flow hoods and provide assistance in purchasing and system design of new hoods. Refer to Section 6.5 for biological safety cabinet requirements and procedures.

Fume Hood Requirements

Velocity Requirements

A standardized face velocity for hoods has not been established, but a common recommendation has been in place for over 25 years. The following face velocities are used at the University of Chicago and are based on the type of materials used within the hood. Please contact UW EH&S fume hood service for guidance: 206-221-5549

Minimum Face Velocity Based on Material Used:

- Low Toxicity Levels 100 feet per minute (fpm);
- Average Level Toxins 100 fpm;
- Low level radioactive tracer materials with normal toxic hazards 100 fpm;
- Significant chemical toxicity levels and moderate radioactive materials 100 fpm; and
- Higher levels of toxicity and highly radioactive materials 100 fpm.

Hoods shall ventilate by a dedicated exhaust fan with ducts leading directly from the hood to the roof. Horizontal ducts shall be pitched down to prevent accumulations of vapors in low spots. Duct velocities shall be maintained high enough to minimize the trapping of vapors in the exhaust system. Terminal exhaust points shall be located at least 25 feet from any possible air intake (e.g., air intake grills, doors, operable windows) and positioned at a height that allows adequate dispersion of fumes.

General Information

A newly installed or modified hood exhausting vapors from a continuing process that is left unattended shall have an air flow switch connected to a visible and audible warning device.

Appropriate safeguards shall be provided for flammable and explosive agents vented through the hood (e.g., explosion-proof motors and control, scrubber units, biohazard filters).

NOTE: The use of perchloric acid is prohibited unless the hood has been designed for its specific use and manipulation.

Certification

All fume hoods shall be inspected and certified annually to determine a proper face velocity of 100 fpm. The airflow into and within the hood shall not be excessively turbulent (200 fpm). These hoods shall be checked by representatives from Facilities Services - Safety and Environmental Affairs on an annual basis during laboratory reviews. All hoods functioning properly shall have a certification label affixed to the sash height at which the hood was certified by UW EH&S.

Hood Usage

When using a fume hood, the following considerations shall apply:

1. Fume hoods shall not be used to store chemicals or other materials;
2. Avoid potential exposures by not putting any part of your body with the exception of hands and forearms into the hood;
3. During manipulation and operation within the hood, sashes shall be kept at or below the certification sticker height to ensure proper air flow and protection of the use;
4. Filters shall be maintained as recommended by the manufacturer;
5. If any hood is suspected of not operating properly, discontinue use of the hood and contact Facilities Services at 206-685-1411 to arrange for testing of the hood(s);
6. Do not use hoods, which have not been certified. To have a hood certified, contact Facilities Services;
7. If the hood is covered with materials to protect light sensitive substances, then an opening not less than that which can be considered safe for operation shall be maintained; and
8. Hoods equipped with automatic alarms shall be inspected by the user more frequently than once per year and the frequency of this testing should be based on hood usage.

Inspection Process

A two-step process shall be used when inspecting a hood to validate proper working condition.

Step 1. Inspection of Hood

A complete inspection both inside and outside the hood shall be performed by the inspector evaluating the following:

1. Use of proper materials designed for that hood;

2. Excessive storage of any materials inside hood;
3. Physical damage to the hood;
4. Items that should not be inside the hood;
5. The ability of the sash to open, close and stay in a stationary position; and
6. Proper function of the hood flow indicator and alarm, if present.

Step 2. Determination of the Hood's Face Velocity

The face velocity of the hood shall be determined by using a velocity meter or other approved device using the low setting or low probe setting. The fume hood must first be emptied to facilitate access.

When using a velocity meter to determine face velocity, the unit shall be placed at a nine-point schematic in order to determine the average flow rate of the hood.

This shall be done with the sash in its fullest raised position. (Refer to diagram 1.1 below.)

Diagram 1.1

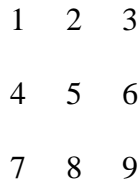

If the hood fails to meet the required face velocity with the sash open to its fullest position, the sash shall be lowered and the hood re-tested. This process shall be performed until the hood meets the required feet per minute rating.

Note: The sash cannot be lowered to a point less than 12 inches from the base of the sash opening.

Once inspection is completed, a certification sticker indicating the date of inspection and face velocity in feet per minute shall be placed at the point the sash was adjusted to reach certification.

If a hood fails certification, a warning sign shall be placed at a prominent location on the sash of the hood.

This sign shall **ONLY** be removed by UW Environmental Health and Safety once the hood has passed certification requirements.

5.13 Gas Cylinder Safety

Background Information

This document contains basic guidelines and rules to help ensure the safe handling and storage of compressed gas cylinders. Compressed gases are used in a variety of CEE programs such as instructional and research laboratories, teaching laboratories, and welding. Compressed gases serve the university in many ways, but gases under high pressure also present a number of hazards.

Mishandled cylinders may rupture violently, release their hazardous contents or become dangerous projectiles. If a neck of a pressurized cylinder should be accidentally broken off, the energy released would be sufficient to propel the cylinder to over three-quarters of a mile in height. A standard 250 cubic foot cylinder pressurized to 2,500 PSIG can become a rocket attaining a speed of over 30 miles per hour in a fraction of a second after venting from the broken cylinder connection.

Basic Safety:

- If a cylinder is damaged, in poor condition, leaking, or the contents are unknown, contact your cylinder vendor. Have the vendor return the damaged cylinder to the manufacturer.
- Wear appropriate foot protection when engaged in moving or transporting cylinders.
 - Sturdy shoes are a minimum.
 - Steel toed shoes if required by your supervisor, instructor, or department.
- Proper personal protective clothing and equipment shall be worn.
- Always have an appropriate *Material Safety Data Sheet (MSDS)* available and be familiar with the health, flammability and reactivity hazards for the particular gas.

Cylinder Markings:

- Cylinders must be properly labeled, including the gas identity and appropriate hazards (e.g., health, flammability, reactivity).
- Cylinders have several stamped markings. The top mark is either a DOT or an ICC marking indicating pertinent regulations for that cylinder. The second mark is the serial number. Under the serial number is the symbol of the manufacturer, user, or purchaser. Of the remaining marks the numbers represent the date of manufacture, and retest date (month and year). A (+) sign indicates the cylinder may be 10% overcharged, and a star indicates a ten-year test interval.

Cylinder Storage:

- Cylinders should be stored in compatible groups
 - Flammables from oxidizers

- Corrosives from flammables
 - Full cylinders from empties
 - All cylinders from corrosive vapors.
- Keep oxygen cylinders a minimum of twenty feet from flammable gas cylinders or combustible materials. If this cannot be done, separation by a non-combustible barrier at least 5 feet high having a fire rating of at least one-half hour is required.
- Secure empty and full cylinders to a fixed support by use of chains, or other substantial restraining devices.
- Store cylinders in an upright position.
- Keep valve protective caps in place when the cylinder is not in use.
- Mark empty cylinders EMPTY or MT.
- Keep valves closed on empty cylinders.
- Cylinders must be kept away from sources of heat.
- Cylinders must be kept away from electrical wiring where the cylinder could become part of the circuit.
- Store cylinders in well-ventilated areas designated and marked only for cylinders.

Moving Cylinders:

- Use a cylinder cart and secure cylinders with a chain.
- Don't use the protective valve caps for moving or lifting cylinders.
- Don't drop a cylinder, or permit them to strike each other violently or be handled roughly.
- Unless cylinders are secured on a special cart, regulators shall be removed, valves closed and protective valve caps in place before cylinders are moved.

Cylinder Use:

- Be sure all connections are tight. Use soapy water to locate leaks.
- Keep cylinders valves, regulators, couplings, hose and apparatus clean and free of oil and grease.
- Keep cylinders away from open flames and sources of heat.
- Safety devices and valves shall not be tampered with, nor repairs attempted.
- Use flashback arrestors and reverse-flow check valves to prevent flashback when using oxy-fuel systems.
- Regulators shall be removed when moving cylinders, when work is completed, and when cylinders are empty.
- Cylinders shall be used and stored in an upright position.
- The cylinder valve should always be opened slowly. Always stand away from the face and back of the gauge when opening the cylinder valve.
- When a special wrench is required to open a cylinder or manifold valve, the wrench shall be left in place on the valve stem when in use; this precaution is taken so the gas supply can be shut off quickly in case of an emergency; and

that nothing shall be placed on top of a cylinder that may damage the safety device or interfere with the quick closing of the valve.

- Fire extinguishing equipment should be readily available when combustible materials can be exposed to welding or cutting operations using compressed cylinder gases.
- When preparing to withdraw gas from a high-pressure cylinder, close the regulator first. Open the main cylinder valve until it stops and adjust the gas flow rate using the regulator. For cylinders containing fuel gases, open the cylinder valve one-quarter turn, adjusting the regulator as above.
- When you are finished using a compressed gas system, turn off the main cylinder valve, bleed the regulator and lines, and close the regulator. Do not leave the regulator under pressure by closing down flow from the regulator without shutting off the main cylinder valve.
- Do not drain a cylinder completely. Air can be sucked back through the valve, contaminating the cylinder or creating an explosive mixture.
- If a cylinder containing a hazardous gas develops a leak, evacuate and restrict access to the area. Remove sources of ignition if the gas is flammable. On campus, call the Fire Department at **9-911**.

Things Not To Do:

- Never roll a cylinder to move it.
- Never carry a cylinder by the valve.
- Never leave an open cylinder unattended.
- Never leave a cylinder unsecured.
- Never force improper attachments on to the wrong cylinder.
- Never grease or oil the regulator, valve, or fittings of an oxygen cylinder.
- Never refill a cylinder.
- Never use a flame to locate gas leaks.
- Never attempt to mix gases in a cylinder.
- Never use teflon tape on a pressurized fitting of a cylinder.
- Never discard pressurized cylinders in the normal trash.

Poison Gases:

Poison gases represent a significant hazard. Special precautions not otherwise necessary become prudent when using poison gases:

- Common poison or highly toxic gases include:
 - Arsine (AsH_3)
 - Ethylene oxide (EtO)
 - Hydrogen cyanide (HCN)
 - Nitric oxide (NO)
 - Phosphine (PH_3)

Certain poison gases (e.g., Ethylene Oxide) can only be used if specific OSHA regulations and safe practices are followed.

- Certain poison gases (e.g., Ethylene Oxide) can only be used if specific OSHA regulations and safe practices are followed.
- Emergency procedures should be made clear to all involved, including personnel from adjacent labs and building managers.
- Poison gas use after normal working hours requires the approval of the Chemical Hygiene Officer for your department.
- Fume hoods and other ventilation need to be tested before use and checked frequently during the project involving poison gas.
- Notify Environmental Health, Safety and Risk Management before your first use of the poison gas.
- The University Police should also be informed about the locations and types of poison gas in use.
- Document these procedures in your lab's chemical hygiene plan. As with all chemicals, obtain and review the Material Safety Data Sheet (MSDS) for the poison gas. Maintain an extra copy of the MSDS in your department's chemical hygiene plan.

Disposal of poison gas cylinders can often cause problems. If the cylinder cannot be returned to the manufacturer, UWM can face large disposal costs (\$1,000 per cylinder, or more). Even cylinders that can be returned must be shipped on a vehicle, which cannot simultaneously carry any other hazardous materials or foodstuffs.

Authority and Reference:

- OSHA 29 CFR 1910.101 and .252 (General Requirements)
- OSHA 29 CFR 1910.102 (acetylene)
- OSHA 29 CFR 1910.103 (hydrogen)
- OSHA 29 CFR 1910.104 (oxygen)
- OSHA 29 CFR 1910.105 (nitrous oxide)
- DCOM 32.15 and 32.28
- Compressed Gas Association (safety publications)

5.14 Autoclave Safety

Autoclaves are such a familiar feature in many laboratories that it is easy to forget what hazards they can pose. The autoclave's job is to render its contents sterile, or free of any living organisms. If it fails to do so, serious health hazards can result. The hot, pressurized steam (270° Fahrenheit, 30 pounds per square inch gauge) that

autoclaves generate to do this job makes them serious burn hazards as well. And, because conditions created inside steam autoclaves are so extreme, autoclaves can easily malfunction if they are not carefully maintained.

Before using any autoclave for the first time, read and thoroughly understand the owner's manual because many makes and models have unique characteristics. If you cannot locate the manual, contact the manufacturer and have a copy sent to you.

Modes of Operation

The autoclave uses different patterns of high heat, vacuum, and pressure to sterilize its load. The type of materials you sterilize will determine the type of sterilization "runs" you use. The general types of runs are "liquids" for any type of water-based solutions, "dry goods with vacuum," and "dry goods without vacuum." Autoclaves often have an additional "drying" cycle in which hot air is drawn through the chamber to dry materials before removal. Controls for different brands of autoclave vary, so you should follow manufacturers' instructions about loading, load sizes, and cycle types and settings carefully.

The "liquids" run is longer than the other two but uses lower temperatures to minimize evaporation of the liquids being sterilized. **Make sure seals on containers of liquids are loose so vapor expanding during heating will not cause an explosion. Never autoclave any flammable or volatile liquids because they could explode.**

The "dry goods with vacuum" run moves steam and heat into the deepest parts of large bags or bundles of materials and produces the best conditions for killing persistent organisms. During this type of run, the chamber alternates between cycles of vacuum and high pressure. Then the chamber is pressurized with steam for a long period, followed by a short vacuum cycle. It is important that steam and pressure be able reach the entire load, so carefully loosen autoclave bag closures once they are in the autoclave.

The "dry goods without vacuum" run simply pressurizes the chamber with steam for the duration of the cycle, and then returns to normal. This process is used primarily for items that have been cleaned but need to be sterilized. Materials should be packed so that the heat and pressure can readily reach the whole load.

Ensuring Thorough Sterilization

It is imperative to know that the autoclave has thoroughly sterilized its contents. Most autoclave bags or tapes are imprinted with a dye that changes color when the correct temperature is reached. The problem with this type of check is that the dye is on the surface of the load, and a positive reading **does not ensure that the innermost parts of a large load are also sterile.** However, an easy way to check this is to wrap something with autoclave tape (a disposable plastic test tube or pipette tip are

possibilities), and attach string to it as it's being put deep into the load. Tape the other end of the string to the outside of the bag so that you can easily pull the indicator out (Do NOT open up a load of potentially infected material to bury something inside). Recover the indicator after the run and confirm that it too has changed color.

Routine Maintenance

It is a good practice to use a biological indicator (e.g., A msc's Proof system, BBL's Kilit) monthly to confirm that the autoclave is working properly. If either the dye (see procedure above) or biological indicator fails, you must examine the autoclave to identify and correct the problem and also re-autoclave the load to ensure sterility.

The best way to ensure your autoclave is working properly is to have regular maintenance performed semi-annually. In addition, users should perform the daily and weekly maintenance procedures described in the owner's manual. Also make sure the drain strainer is clean before each run.

Autoclave Safety

Autoclaves generate extreme heat and high pressure. Users should understand and respect the hazards these can create. Autoclave doors and their gaskets must be firmly locked into place before running the autoclave to prevent a sudden release of high-pressure steam. Most, **but not all**, autoclaves have safety interlocks that prevent the autoclave from running if the door isn't closed properly. Know if yours has an interlock--you'll need to use extra caution if it doesn't.

Some older autoclaves have little or no heat shielding around the outside. Attach signs warning of "Hot Surfaces, Keep Away" or similar wording on or next to the autoclave to remind people of the hazard. Do not stack or store combustible materials next to an autoclave (cardboard, plastic, volatile or flammable liquids). Use heat-resistant gloves when removing materials after sterilization and avoid touching the inner chamber surfaces.

If you are burned, you can receive treatment at the University Health center. Burns to the face, third-degree burns, or burns over large areas of the body should be treated as emergencies. Call 9-911 from a campus phone or 911 from a pay phone to get help. You can treat minor burns yourself using standard first aid. Regardless of the degree of severity, report the burn to your supervisor or laboratory technician as an occupational injury.

If you have questions about autoclave operation or need help reaching a manufacturer, contact the Office of Environmental Health & Safety at 543-7262.

Section 6: Infectious and Biochemical Agents

6.1 Biohazardous Spill Response

Biohazardous Spill in a Biological Safety Cabinet

Chemical decontamination procedures should be initiated at once *while the Cabinet continues to operate* to prevent escape of contaminants from the Cabinet.

29. Spray or wipe walls, work surfaces, and equipment with a decontaminant that is effective against the agent in use. Generally a 1% solution of an iodophor decontaminant (Wescodyne or equivalent) is effective against most viruses, fungi, vegetative bacteria, and most non-encysted ameba. A decontaminant detergent has the advantage of detergent activity, which is important because extraneous organic substances frequently interfere with the reaction between microorganisms and the active agent of the decontaminant. The operator is to wear gloves and lab coat during this procedure.
30. Flood the top work surface tray, and, if a Class II Cabinet, the drain pans and catch basins below the work surface, with a decontaminant and allow standing 10 to 15 minutes.
31. Remove excess decontaminant from the tray by wiping with a sponge or cloth soaked in a decontaminant. For Class II Cabinets, drain the tray into the Cabinet base, lift out tray and removable exhaust grille work, and wipe off top and bottom (underside) surfaces with a sponge or cloth soaked in a decontaminant. Then replace in position and drain decontaminant from Cabinet base into appropriate container and autoclave according to standard procedures. Gloves, cloth, or sponge should be discarded in an autoclave pan and autoclaved.

Biohazardous Spill Outside a Biological Safety Cabinet

22. If you have spilled a risk group 1 agent or a small (unconcentrated) amount of a class 2 agent than remove any contaminated clothing, wash, regard and proceed to step 7.
23. If you are working with a risk group 3 agent, or have spilled more than 100ml of a risk group 2 agent, hold your breath, leave the room immediately, and close the door.
24. Warn others not to enter the contaminated area.
25. Remove and put contaminated garments into a container for autoclaving and thoroughly wash hands and face.
26. Wait 30 minutes before reentering area to allow dissipation of aerosols created by the spill.

27. Put on a long-sleeved gown, mask, and rubber gloves before reentering the room. (For high-risk agent, a jumpsuit with tight fitting wrists and use of a respirator should be considered.)
28. Pour a decontaminant solution (1% iodophor or 10% hypochlorite are recommended) around the spill and then place towels over the spill. Soak the towels with the decontaminant. To minimize aerosol production, avoid pouring the decontaminant solution directly onto the spill.
29. Let stand 20 minutes to allow an adequate contact time.
30. Using an autoclavable dustpan and squeegee, transfer all contaminated materials (paper towels, glass, liquid, gloves, etc.) into a deep autoclave pan. Cover the pan with aluminum foil or other suitable cover and autoclave according to standard directions.
31. The dustpan and squeegee should be placed in an autoclave bag and autoclaved according to standard directions. Contact of reusable items with non-autoclavable plastic bags should be avoided separation of the plastic after autoclaving can be very difficult.

Radioactive Biohazardous Spill Outside A Biological Safety Cabinet

In the event that a biohazardous spill also includes radioactive material, the cleanup procedure will have to be modified. The biological component of the spill will have to be inactivated prior to disposal of the radioactive waste. Call the Radiation Protection at extension 6626 for instruction and assistance.

Risk Group 1 Agents or small unconcentrated (<100ml) of Risk Group 2 Agents.

19. Warn others not to enter the contaminated area.
20. Remove protective clothing (lab coat, gloves, etc.) and isolate in a plastic bag or appropriate container.
21. Monitor yourself for radioactive contamination. If contaminated decontaminate yourself and resurvey.
22. Thoroughly wash your hands and face.
23. Monitor the removed protective clothing for radioactive contamination. If positive, isolate this waste and hold for disposal by the Radiation Protection Office.
24. Pour a decontaminant solution (1% iodophor or 10% hypochlorite are recommended) around the spill and then place towels over the spill. Soak the towels with the decontaminant. To minimize aerosolization, avoid pouring the decontaminant solution directly onto the spill.
25. Let stand 20 minutes to allow an adequate contact time.
26. Using an autoclavable dustpan and squeegee, transfer all contaminated materials (paper towels, glass, liquid, gloves, etc.) into a plastic bag. Place the bag in the appropriate Radiation waste container.
27. The dustpan and squeegee should be monitored for radioactive contamination. Decontaminate and resurvey as necessary.
28. Contact the Radiation Protection at extension 6626 to report the spill.

Risk Group 3 Agents or spills of Risk Group 2 Agents greater than 100 milliliters.

17. If you spill a Class 3 agent or have spilled more than 100ml of a class 2 agent, hold your breath, leave the room immediately, and close the door.
18. Warn others not to enter the contaminated area.
19. Remove protective clothing (lab coat, gloves, etc.) and isolate in a plastic bag or appropriate container.
20. Monitor yourself for radioactive contamination. If contaminated decontaminate yourself and re-survey.
21. Thoroughly wash your hands and face.
22. Monitor the removed protective clothing for radioactive contamination. If positive, isolate this waste and hold for disposal by Radiation Protection.
23. Prior to reentering the laboratory or spill area, wait 30 minutes to allow dissipation of aerosols created by the spill.
24. Before cleaning the spill area contact Radiation Safety Office at 543-0463, or email at radsaf@u.washington.edu, for assistance. If the spill occurs after hours or on weekends, activate the Emergency Response System by dialing 911

Chemical Biohazardous Spill Outside of a Biological Safety Cabinet

16. Determine prior to starting your research: which chemical decontaminant(s) is compatible with the chemical(s) that may become biologically contaminated and if the contaminated chemical(s) can be autoclaved. Contact the Industrial Hygienist at extension 6218 for assistance.
17. If you are working with a Risk Group 3 agent, or have spilled more than 100ml of a Risk Group 2 agent, hold your breath, leave the room immediately, and close the door.
18. If you have spilled a Risk Group 1 agent or a small amount of a Risk Group 2 agent then proceed to step 3.
19. Warn others not to enter the contaminated area.
20. Remove and put in container-contaminated garments for decontamination or autoclaving and thoroughly wash hands and face. If garments are chemically contaminated, autoclaving may not be advisable, consult with an industrial hygienist.
21. If you have had to evacuate the laboratory, wait 30 minutes to allow dissipation of aerosols created by the spill.
22. Consult your laboratory's Chemical Hygiene Plan for chemical spill procedures. If the chemical(s) in the spill present a greater hazard than the biological agent(s) proceed with chemical decontamination first.
23. Put on a long-sleeved gown, mask, and rubber gloves before reentering the room. For high-risk agent or hazardous chemical, a jumpsuit with tight fitting wrists and use of a respirator (consult with the Industrial Hygienist) should be considered.
24. Use a decontaminant that is compatible with the chemical(s) in the spill. Pour the decontaminant solution around the spill and then place towels over the

- spill. Soak the towels with the decontaminant. To minimize aerosol production, avoid pouring the decontaminant solution directly onto the spill.
25. Let stand 20 minutes to allow an adequate contact time.
 26. If the chemical(s) are compatible with autoclaving, use an autoclavable dust pan and squeegee to transfer all contaminated materials (paper towels, absorbent, glass, liquid, gloves, dust pan, squeegee, etc.) into an autoclavable pan. Cover the pan with aluminum foil or other suitable cover and autoclave according to standard directions. Depending upon the chemicals involved the now sterile material may have to be disposed of via Waste Management's chemical waste pickup service.
 27. If the chemical(s) are not autoclavable (or if you do not know), then transfer the decontaminated, contaminated materials into a screw cap container and call Waste Management at 543-7262 for chemical waste pickup
 28. Contact of reusable items with nonautoclavable plastic bags should be avoided separation of the plastic after autoclaving can be very difficult.

6.2 Classification of Biohazardous Agents

Class 1	Includes all agents, which have been assessed for risk and do not belong in higher classes.
Class 2	Agents of moderate potential hazard to personnel and the environment This class includes agents which may produce disease of varying degrees of severity from accidental inoculation or injection or other means of cutaneous penetration but which are contained by ordinary laboratory techniques (biosafety level 2 standards of practice and facility).
Class 3	Agents, which may cause serious or potentially lethal disease as a result from exposure by the inhalation route. Class 3 agents include those derived from outside the United States that require a federal permit for importation unless they are specified for higher classification. This class also includes pathogens, which require special conditions for containment (biosafety level 3 standards of practice and facility).
Class 4	Agents that require the most stringent conditions for their containment because they are extremely hazardous to laboratory personnel or may cause serious epidemic disease.
Class 5	Foreign animal pathogens that are excluded from the United States by law or whose entry is restricted by USDA administrative policy.

CLASS 1 AGENTS

(Class 1 includes all agents, which have been assessed for risk and do not belong in higher classes. Call EH&S at 543-7262 to verify any unknown agent status).

Bacillus cereus
Canine distemper virus (Snyder-Hill strain)
Influenza virus reference strains A/PR8/34, A/WS/33 or commonly used neurotropic variants
Newcastle virus strains licensed for vaccine use in US.
Lactobacillus acidophilus
Lactobacillus bulgaricus
Lactobacillus casei
Newcastle virus - strains licensed for vaccine use in US.
Parainfluenza virus 3, SF4 strain
Agents listed in Appendix C of "NIH Guidelines for Research Involving Recombinant DNA Molecules"
CLASS 2 AGENTS
2B Bacterial Agents
Acinetobacter baumannii (formerly A. calcoaceticus)
Actinobacillus (all species)
Actinomyces pyogenes (formerly Corynebacterium pyogenes)
Aeromonas hydrophila
Amycolata autotrophica
Arachnia propionica
Archanobacterium haemolyticum (formerly Corynebacterium haemolyticum)
Arizona hinshawii (all serotypes)
Bacillus anthracis
Bacillus subtilis
Bacteroides (all species)
Bartonella henselae
Bartonella quintana
Bartonella vinsonii
Bordetella (all species)
Borrelia recurrentis
Borrelia vincenti
Borrelia burgdorferi
Campylobacter coli
Campylobacter fetus ssp. Fetus
Campylobacter jejuni
Chlamydia pneumoniae
Chlamydia psittaci
Chlamydia trachomatis
Clostridium botulinum
Clostridium chauvoei
Clostridium difficile
Clostridium haemolyticum
Clostridium histolyticum
Clostridium novyi
Clostridium perfringens
Clostridium septicum
Clostridium sordellii

Clostridium tetani
Corynebacterium bovis
Corynebacterium diphtheriae
Corynebacterium equi
Corynebacterium ovis / pseudotuberculosis
Corynebacterium renale
Dermatophilus congolensis
Edwardsiella tarda
Enterobacter aerogenes
Erysipelothrix insidiosa
Erysipelothrix rhusiopathiae
Escherichia coli (all enteropathogenic, enterotoxigenic, enteroinvasive and strains bearing K-1 antigen, including E. coli O157:H7)
Francisella novicida
Fusobacterium necrophorum
Haemophilus ducreyi
Haemophilus gallinarum
Haemophilus haemolyticus
Haemophilus influenzae
Haemophilus parahaemolyticus
Haemophilus parainfluenzae
Helicobacter pylori
Klebsiella (all species except oxytoca which is in class 1)
Legionella (including L. pneumophila)
Leptospira interrogans (all serotypes)
Listeria (all species)
Mixa polymorpha
Moraxella (all species)
Mycobacteria (all species except those listed in Class 3)
Mycobacterium africanum
Mycobacterium asiaticum
Mycobacterium avium
Mycobacterium bovis BCG vaccine strain
Mycobacterium chelonae
Mycobacterium fortuitum
Mycobacterium kansasii
Mycobacterium leprae
Mycobacterium malmoeense
Mycobacterium marinum
Mycobacterium paratuberculosis
Mycobacterium scrofulaceum
Mycobacterium simiae
Mycobacterium szulgai
Mycobacterium ulcerans
Mycobacterium xenopi

Mycoplasma (all species except *Mycoplasma mycoides* and *Mycoplasma agalctiae* which are in Class 5)
Neisseria gonorrhoea
Neisseria meningitidis
Nocardia asteroides
Nocardia brasiliensis
Nocardia otitidiscaviarum
Nocardia transvalensis
Pasteurella (all species except those listed in class 3)
Plesiomonas shigelloides
Rhodococcus equi
Rochalimaea vinsonii
Salmonella (all species and all serotypes)
Serratia marcescens
Shigella (all species and all serotypes)
Sphaerophorus necrophorus
Staphylococcus aureus
Staphylococcus epidermidis
Streptobacillus moniliformis
Streptococcus agalactiae
Streptococcus pneumoniae
Streptococcus pyogenes
Treponema carateum
Treponema pallidum
Treponema pertenu
Vibrio cholerae (including biotype El Tor)
Vibrio parahemolyticus
Vibrio vulnificus
Yersinia enterocolitica
Yersinia pseudotuberculosis
2F Fungal Agents
Absidia (all species)
Actinomyces (including *Nocardia* species and *Actinomyces* species and *Arachnia propionica*)
Aspergillus (all species)
Blastomyces dermatitidis
Candida (all species)
Cladosporium bantianum
Cladosporium (xylohypha) trichoides
Cryptococcus neoformans
Dactylaria galopava (*Ochroconis gallopavum*)
Epidermophyton (all species)
Exophiala (Wangiella) dermatitidis
Fonsecaea pedrosoi
Geotrichum (al species)
Loboa lobi

Madurella mycetomi
Microsporium (all species)
Mucor (all species)
Penicillium marneffeii
Rhizopus (all species)
Sporothrix schenckii
Trichophyton (all species)
Trichosporon (all species)
2P Parasitic Agents
Acanthocheilonema (all species)
Acanthamoeba (all species)
Ancylostoma (all species)
Angiostrongylus (all species)
Ascaris (all species)
Babesia (all species)
Balantidium (all species)
Brugia (all species)
Caprillaria (all species)
Clonorchis (all species)
Coccidia (all species)
Cryptosporidium (all species)
Dicrocoelium (all species)
Dipetalonema (all species)
Diphyllobothrium (all species)
Dipylidium (all species)
Dracunculus (all species)
Echinococcus granulosus
Echinococcus multilocularis
Echinococcus vogeli
Entamoeba histolytica

□ 2P Parasitic Agents (cont'd)
Enterobius (all species)
Fasciola (all species)
Giardia (all species)
Heterophyes (all species)
Hymenolepis (all species)
Isospora (all species)
Leishmania (all species)
Linguatula (all species)
Loa (all species)
Macracanthrostrongylus (all species)
Microsporidia
Naegleria fowleri
Naegleria gruberi
Necator (all species)

Onchocerca (all species)
Opisthorchis (all species)
Paragonimus (all species)
Plasmodium (all species)
Pneumocystis carinii
Sarcocystis
Schistosoma (all species)
Strongyloides (all species)
Taenia solium
Toxascaris (all species)
Toxocara (including T. canis)
Toxoplasma (all species)
Trichinella spiralis
Trichomonas vaginalis
Trichostrongylus (all species)
Trichuris trichiura
Trypanosoma (all species)
Wuchereria (all species)
2V Viral Agents (* denotes oncogenic viruses)
Adv-Sv40, Ad2-SV40*
Adenoviruses (human - all types)*
Avian leukosis*
Avian Sarcoma virus
B-K virus
Bebaru virus
Bluetongue-indigenous
Bovine leukemia*
Bovine papilloma*
Buffalopox virus
Bunyamwera virus
Cache Valley virus
Calciviruses
California Encephalitis virus
Camelpox virus
CELO*
Chikungunya vaccine strain 131/25
Coronaviruses
Cowpox virus
Coxsackie A and B viruses
Cytomegalovirus
Dengue virus serotypes 1,2,3,&4
Dog Sarcoma *
Eastern Equine Encephalomyelitis virus
Echoviruses (all types)
Encephalomyocarditis virus (EMC)

Epstein-Barr virus (EBV)*
FeLV/FeSV*
Fifth disease agent
Flanders viruses
Bibbon leukemia virus*
Guinea pig herpes*
Hamster leukemia*
Hart Park virus
Hepatitis viruses A,B,C,D,&E (associated antigen material)
Herpes Simplex virus*
other Herpes viruses (except Herpes virus simiae - Monkey B virus which is Class 4)
Human papilloma viruses
Human parvovirus (B19)
Influenza viruses (all types except A/PR8/34 which is in Class 1)
Junin, vaccine strain candidate #1
Kunjin
Langat virus
Lucke (frog)*
Lymphocytic choriomeningitis virus (LCM) (viscerotropic strains)
Lymphogranuloma venereum agent
Marek's Disease virus*
Mason-Pfizer monkey virus*
Measles virus
Milker's Node virus
Molluscum contagiosum virus
Mopeia virus
Mouse mammary tumor*
Mumps virus
Murine leukemia*
Murine sarcoma*
Myxo-Paramyoviruses (all types except Canine distemper virus which is in class 1)
Newcastle disease virus
Norwalk virus
2V Viral Agents (cont)
O'nyong-nyong virus
Orf virus
Papovaviruses
Parainfluenza viruses (all types except Parainfluenza virus 3, SF4 strain which is in Class 1)
Paravaccina virus
CLASS 3 AGENTS
3B Bacterial Agents
Bartonella (all species)
Brucella (all species)
Burkholderia mallei (formerly Pseudomonas mallei) (determined on a case by case basis)

Burkholderia pseudomallei (formerly Pseudomonas pseudomallei) (determined on a case by case basis)
Coxiella burnetii
Francisella tularensis
Mycobacterium bovis (except BCG strain which is in class 2)
Mycobacterium tuberculosis
Pasteurella multocida type B ("buffalo" and other foreign virulent strains)
Rickettsia akari
Rickettsia australis
Rickettsia canada
Rickettsia conorii
Rickettsia montana
Rickettsia prowazekii
Rickettsia rickettsii
Rickettsia sennetsu
Rickettsia siberica
Rickettsia tsutsugamushi
Rickettsia typhi (R. mooseri)
Rochalima quintana (determined on a case by case basis)
Yersinia pestis
3F Fungal Agents
Coccidioides immitis
Histoplasma capsulatum
Histoplasma capsulatum var. duboisii
Histoplasma farciminosum
3V Viral Agents
Arboviruses (all strains except those in Class 2 and 4. Arboviruses indigenous to the United states are in Class 3, except those listed in Class 2. West Nile and Semliki Forest viruses may be classified up or down, depending on the conditions of use and geographic location of the laboratory.)
Creutzfeldt-Jakob disease agent (BSE agent, a prion)
Dengue virus, when used for transmission or animal inoculation experiments
Hantaviruses
HIV types 1&2, HTLV types 1&2, and SIV (all determined on a case by case basis)
Japanese encephalitis virus
Kuru disease agent
Lymphocytic choriomeningitis virus (LCM) (Neurotrophic strains)
Monkeypox virus, when used in vitro
Rabies street virus
Rift Valley fever virus
St. Louis encephalitis virus
Venezuelan equine encephalomyelitis virus (except strain TC-83 which is in class 2)
Vesicular stomatitis virus (VSV) (classification depends on strain and experimental design)
Vole rickettsia
Yellow fever virus (wild, when used in vitro)

Paracoccidioides brasiliensis (determined on a case by case basis)
Bovine infectious petechial fever
Brucella melitensis
Camel pox virus
Cochliomyia hominivorax (screw worm)
Ephemeral fever virus
Fowl plague virus
Goat pox virus
Histoplasma (Zymonema) farciminosum
Hog cholera virus
Louping ill virus
Lumpy skin disease virus
Mycoplasma agalactiae (contagious agalactia of sheep)
Mycoplasma mycoides (contagious bovine pleuropneumonia)
Nairobi sheep disease virus
Newcastle disease virus (Asiatic strains)
Peste des petits ruminants (pest of small ruminants)
Pseudomonas ruinatium (heart water)
Rift valley fever virus
Rinderpest virus
Sheep pox virus
Swine vesicular disease virus
Teschen disease virus
Theileria parva (East Coast Fever)
Theileria Annulata
Theileria bovis
Theileria hirci
Theileria lawrencei
Trypanosoma vivax (Nagana)
Trypanosoma evansi
Vesicular exanthema virus
Wesselsbron disease virus
Zyionema
3P Parasitic Agents
None
CLASS 4 AGENTS
4B Bacterial Agents
None
4F Fungal Agents
None
4P Parasitic Agents
None
4V Viral Agents
Ebola fever virus
Guanarito

Hemorrhagic fever agents, including Crimean hemorrhagic fever, Congo, Junin, and Machupo viruses, and others as yet undefined
Herpesvirus simiae (Monkey B virus)
Lassa virus
Marburg virus
Monkeypox virus, when used for transmission or animal inoculation experiments
Tick-borne encephalitis virus complex, including Absettarov, Central European encephalitis viruses, Hanzalova, Hypr, Kumlinge, Kyasanur forest disease, Omsk hemorrhagic fever, and Russian spring-summer encephalitis
Venezuelan equine encephalitis virus, epidemic strains, when used for transmission or animal inoculation experiments
Yellow fever virus (wild, when used for transmission or animal inoculation experiments)
Yellow fever virus (wild, when used for transmission or animal inoculation experiments)

CLASS 5 AGENTS

Animal Disease Organisms and Vectors which are Forbidden Entry into the United States by Law
Foot and Mouth disease virus
Animal Disease Organisms and Vectors which are Forbidden Entry into the United States by USDA Policy
African horse sickness virus
African Swine fever virus
Akabane virus
Besnoitia besnoiti
Borna disease virus
Poliomyelitis viruses (wild and attenuated)
Polioviruses (all types, wild and attenuated)
Polyoma*
Poxviruses (all types except Alastrim, Smallpox, and Whitepox which are in Class 5, and Monkeypox which, depending on experiment, is in Class 3 or 4)
Pseudo-rabies virus
Rabbitpox virus
Rabies virus (all strains except Rabies "street" virus - fresh isolate which should be in Class 3)
Rat leukemia*
Rat mammary tumor*
Reoviruses (all types)
Respiratory syncytial virus
Rhinoviruses (all types)
Rift Valley Fever vaccine strain MP-12
Ross River virus
Rotaviruses
Rous sarcoma*
Rubella virus (Rubivirus)

Semliki Forest virus
Sendai virus
Shope fibroma*
Shope papilloma*
Simian viruses* (all types except Herpesvirus simiae - Monkey B virus, Class 4, and Marburg virus which is a Class 4 hemorrhagic fever virus)
Sindbis virus
Subsclerosing panencephalitis virus
SV 40 virus
Tacaribe complex
Tanapox complex
Tensaw virus
Transmissible Spongiform encephalopathies
Turlock virus
Vaccinia virus
Varicella virus
Venezuelan Equine Encephalomyelitis vaccine strain TC-83
Vesicular stomatitis virus (laboratory adapted strains including VSV-Indiana, San Juan, and Glasgow)
Western Equine Encephalomyelitis virus
Yaba*
Yabapox virus
Yellow fever virus, 17D vaccine strain
Studied in the United States Organisms which may not be except at Specified Facilities
Alastrim
Small pox
White pox

6.3 Laboratory Security and Emergency Response Guidance for Laboratories Working with Select Agents

Summary

In recent years, concern has increased regarding use of biologic materials as agents of terrorism, but these same agents are often necessary tools in clinical and research microbiology laboratories. Traditional biosafety guidelines for laboratories have emphasized use of optimal work practices, appropriate containment equipment, well-designed facilities, and administrative controls to minimize risk of worker injury and to ensure safeguards against laboratory contamination.

The guidelines discussed in this report were first published in 1999 (U.S. Department of Health and Human Services/CDC and National Institutes of Health. Biosafety in microbiological and biomedical laboratories [BMBL]. Richmond JY, McKinney RW, eds. 4th ed. Washington, DC: US Department of Health and Human Services, 1999 [Appendix F]). In that report, physical security concerns were addressed, and efforts

were focused on preventing unauthorized entry to laboratory areas and preventing unauthorized removal of dangerous biologic agents from the laboratory. Appendix F of BMBL is now being revised to include additional information regarding personnel, risk assessments, and inventory controls. The guidelines contained in this report are intended for laboratories working with select agents under biosafety-level 2, 3, or 4 conditions as described in Sections II and III of BMBL. These recommendations include conducting facility risk assessments and developing comprehensive security plans to minimize the probability of misuse of select agents.

Risk assessments should include systematic, site-specific reviews of 1) physical security; 2) security of data and electronic technology systems; 3) employee security; 4) access controls to laboratory and animal areas; 5) procedures for agent inventory and accountability; 6) shipping/transfer and receiving of select agents; 7) unintentional incident and injury policies; 8) emergency response plans; and 9) policies that address breaches in security. The security plan should be an integral part of daily operations. All employees should be well trained and equipped, and the plan should be reviewed annually, at least.

Introduction

Traditional laboratory biosafety guidelines have emphasized use of optimal work practices, appropriate containment equipment, well-designed facilities, and administrative controls to minimize risks of unintentional infection or injury for laboratory workers and to prevent contamination of the outside environment (1). Although clinical and research microbiology laboratories might contain dangerous biologic, chemical, and radioactive materials, to date, only a limited number of reports have been published of materials being used intentionally to injure laboratory workers or others (2--7). However, recently, concern has increased regarding possible use of biologic, chemical, and radioactive materials as terrorism agents (8,9). In the United States, recent terrorism incidents (10) have resulted in the substantial enhancement of existing regulations and creation of new regulations governing laboratory security to prevent such incidents.

The Public Health Security and Bioterrorism Preparedness and Response Act of 2002* (the Act) required institutions to notify the U.S. Department of Health and Human Services (DHHS) or the U.S. Department of Agriculture (USDA) of the possession of specific pathogens or toxins (i.e., select agents†), as defined by DHHS, or certain animal and plant pathogens or toxins (i.e., high-consequence pathogens), as defined by USDA. The Act provides for expanded regulatory oversight of these agents and a process for limiting access to them to persons who have a legitimate need to handle or use such agents. The Act also requires specified federal agencies to withhold from public disclosure, among other requirements, site-specific information regarding the identification of persons, the nature and location of agents present in a facility, and the local security mechanisms in use. In addition, the Uniting and Strengthening America by Providing Appropriate Tools Required To Intercept and Obstruct Terrorism (USA PATRIOT) Act of 2001§ prohibits restricted persons from

shipping, possessing, or receiving select agents. Violation of either of these statutes carries criminal penalties.

Appendix F of the 4th edition of the CDC/National Institutes of Health, *Biosafety in Microbiological and Biomedical Laboratories (BMBL)* was the first edition to address laboratory security concerns (1). However, that publication primarily addressed physical security concerns (e.g., preventing unauthorized entry to laboratory areas and preventing unauthorized removal of dangerous biologic agents from the laboratory). The guidelines presented here are provided to assist facility managers with meeting the regulatory mandate of 42 Code of Federal Regulation (CFR) 73 and, therefore, include information regarding personnel, risk assessments, and inventory controls. These guidelines are intended for laboratories where select agents are used under biosafety levels (BSL) 2, 3, or 4 as described in Sections II and III of BMBL. Appendix F of BMBL is being revised to include consideration of the following biosecurity policies and procedures:

8. Risk and threat assessment;
9. Facility security plans;
10. Physical security;
11. Data and electronic technology systems;
12. Security policies for personnel;
13. Policies regarding accessing the laboratory and animal areas;
14. Specimen accountability;
15. Receipt of agents into the laboratory;
16. Transfer or shipping of select agents from the laboratory;
17. Emergency response plans; and
18. Reporting of incidents, unintentional injuries, and security breaches.

6.4 Definitions

Biosafety: Development and implementation of administrative policies, work practices, facility design, and safety equipment to prevent transmission of biologic agents to workers, other persons, and the environment.

Biosecurity: Protection of high-consequence microbial agents and toxins, or critical relevant information, against theft or diversion by those who intend to pursue intentional misuse.

Biologic Terrorism: Use of biologic agents or toxins (e.g., pathogenic organisms that affect humans, animals, or plants) for terrorist purposes.

Responsible official: A facility official who has been designated the responsibility and authority to ensure that the requirements of Title 42, CFR, Part 73, are met.

Risk: A measure of the potential loss of a specific biologic agent of concern, on the basis of the probability of occurrence of an adversary event, effectiveness of protection, and consequence of loss.

Select agent: Specifically regulated pathogens and toxins as defined in Title 42, CFR, Part 73, including pathogens and toxins regulated by both DHHS and USDA (i.e., overlapping agents or toxins).

Threat: The capability of an adversary, coupled with intentions, to undertake malevolent actions.

Threat assessment: A judgment, based on available information, of the actual or potential threat of malevolent action.

Vulnerability: An exploitable capability, security weakness, or deficiency at a facility. Exploitable capabilities or weaknesses are those inherent in the design or layout of the biologic laboratory and its protection, or those existing because of the failure to meet or maintain prescribed security standards when evaluated against defined threats.

Vulnerability assessment: A systematic evaluation process in which qualitative and quantitative techniques are applied to arrive at an effectiveness level for a security system to protect biologic laboratories and operations from specifically defined acts that can oppose or harm a person's interest.

6.5 Risk Assessment

Recommendation: Conduct a risk assessment and threat analysis of the facility as a precursor to the security plan.

Background: In April 1998, the General Accounting Office issued a report regarding terrorism (11). A key finding of that report was that threat and risk assessments are widely recognized as valid decision-support tools for establishing and prioritizing security program requirements. A threat analysis, the first step in determining risk, identifies and evaluates each threat on the basis of different factors (e.g., the capability and intent to attack an asset, the likelihood of a successful attack, and the attack's probable lethality). Risk management is the deliberate process of understanding risk (i.e., the likelihood that a threat will harm an asset with certain severity of consequences) and deciding on and implementing actions to reduce that risk. Risk management principles are based on acknowledgment that 1) although risk usually cannot be eliminated, it can be reduced by enhancing protection from validated and credible threats; 2) although threats are possible, certain threats are more probable than others; and 3) all assets are not equally critical. Therefore, each facility should implement certain measures to enhance security regarding select agents. The following actions should assist decision-makers in implementing this recommendation:

14. Each facility should conduct a risk assessment and threat analysis of its assets and select agents. The threat should be defined against the vulnerabilities of the laboratory to determine the necessary components of a facility security plan and system (12,13).
15. The risk assessment should include a systematic approach in which threats are defined and vulnerabilities are examined; risks associated with those vulnerabilities are mitigated with a security systems approach (12,13).
16. Ensure the security plan includes collaboration between senior management, scientific staff, human resource officials, information technology (IT) staff, engineering officials, and security officials. This coordinated approach is critical to ensuring that security recommendations provide a reasonable and adequate assurance of laboratory security without unduly impacting the scientific work.

Facility Security Plans

Recommendation: Establish a facility security plan.

1. Each facility should develop a comprehensive security plan that complies with 42 CFR Part 73 and reviews the need for policies in
 - physical security;
 - data and IT system security;
 - security policies for personnel;
 - policies for accessing select agent areas;
 - specimen accountability;
 - receipt of select agents into the laboratory;
 - transfer or shipping of select agents from the laboratory;
 - emergency response plans; and
 - reporting of incidents, injuries, and breaches.
2. Develop security policies based on site-specific assessments. Security plans should include measures that address physical security of building and laboratory areas. Policies should also address concerns associated with access, use, storage, and transfer of sensitive data. If sensitive electronic data are present, IT specialists should assess the security of hardware and software products in addition to the security of local area networks.
3. Review safety, security, and IT policies and procedures at least annually for consistency and applicability. These procedures should also be reviewed after any incident or change in regulations. Necessary changes should be incorporated into the revised plans and communicated to all.
4. Laboratory supervisors should ensure that all laboratory workers and visitors understand security requirements and that all employees are trained and equipped to follow established procedures. The security plan should be an integral part of daily operations. New employees should receive training when they first begin work, and all employees should receive training at least annually thereafter. Training should be updated as policies and procedures change. All training should be documented by maintaining records of training schedules and employee attendance.

5. Security plans should receive periodic performance testing to determine their effectiveness. Test procedures can vary from a simple check of keys, locks, and alarms to a full-scale laboratory or facility exercise.

Security Policies for Personnel

Recommendation: Establish security-related policies for all personnel.

17. Honest, reliable, and conscientious workers represent the foundation of an effective security program. Facility administrators and laboratory directors should be familiar with all laboratory workers.
18. Establish a policy for screening employees who require access to select agent areas to include full- and part-time employees, contractors, emergency personnel, and visitors. Additional screening might be necessary for employees who require access to other types of sensitive or secure data and work areas. These screening procedures should be commensurate with the sensitivity of the data and work areas (e.g., federal security clearances for government employees and contractors).
19. Ensure that all workers approved for access to select agents (e.g., students, research scientists, and other short-term employees) wear visible identification badges that include, at a minimum, a photograph, the wearer's name, and an expiration date. Facility administrators should consider using easily recognizable marks on the identification badges to indicate access to sensitive or secure areas.

Access Control

Recommendation: Control access to areas where select agents are used or stored.

8. Consolidate laboratory work areas to the greatest extent possible to implement security measures more effectively. Separate select agent areas from the public areas of the buildings. Lock all select agent areas when unoccupied. Use keys or other security devices to permit entry into these areas.
9. Methods of secure access and monitoring controls can include key or electronic locking pass keys, combination key pad, use of lock-boxes to store materials in freezers or refrigerators, video surveillance cameras, or other control requirements. Protocols for periodically changing combination keypad access numbers should be developed.
10. Assess the need for graded levels of security protection on the basis of site-specific risk and threat analysis. This security can be accomplished through card access systems, biometrics, or other systems that provide restricted access.
11. Lock all freezers, refrigerators, cabinets, and other containers where select agents are stored when they are not in direct view of a laboratory worker.
12. Limit access to select agent areas to authorized personnel who have been cleared by the U.S. Department of Justice as indicated in 42 CFR Part 73. All others entering select agent areas must be escorted and monitored by authorized personnel.

13. Record all entries into these areas, including entries by visitors, maintenance workers, service workers, and others needing one-time or occasional entry.
14. Limit routine cleaning, maintenance, and repairs to hours when authorized employees are present and able to serve as escorts and monitors.
15. Establish procedures and training for admitting repair personnel or other contractors who require repetitive or emergency access to select agent areas.
16. Ensure visitors are issued identification badges, including name and expiration date, and escorted and monitored into and out of select agent areas. Such visits should be kept to a minimum.
17. Ensure procedures are in place for reporting and removing unauthorized persons. These procedures should be developed through collaboration among senior scientific, administrative, and security management personnel. These procedures should be included in security training and reviewed for compliance at least annually.

Select Agent Accountability

Recommendation: Establish a system of accountability for select agents.

20. Establish an accounting procedure to ensure adequate control of select agents and maintain up-to-date inventory of seed stocks, toxins, and agents in long-term storage. Records should include data regarding the agent's location, use, storage method, inventory, external transfers (sender/receiver, transfer date, and amount), internal transfer (sender/receiver, transfer date, amount), further distribution, and destruction (method, amount, date, and a point of contact).
21. Establish procedures that maintain accurate and up-to-date records of authorizations for entry into limited access areas (i.e., a current list of persons who possess door keys and those who have knowledge of keypad access numbers or the security system).

Receiving Select Agents

Recommendation: Develop procedures for bringing select agent specimens into the laboratory.

12. A centralized receiving area for select agents is recommended to maximize safety and minimize security hazards associated with damaged or unknown packages.
13. Facilities should establish procedures for inspecting all packages (i.e., by visual or noninvasive techniques) before they are brought into the laboratory area. Suspicious packages should be handled as prescribed by federal and state law enforcement agencies.
14. Biologic safety cabinet or other appropriate containment device should be used when opening packages containing specimens, bacterial or virus isolates, or toxins. Trained, authorized personnel should open packages.

Transfer or Shipping of Select Agents

Recommendation: Develop procedures for transferring or shipping select agents from the laboratory.

5. Package, label, and transport select agents in conformance with all applicable local, federal, and international transportation and shipping regulations, including U.S. Department of Transportation (DOT) regulations.¶ Materials that are transported by airline carrier should also comply with packaging and shipping regulations set by the International Air Transport Association (IATA). Personnel who package, handle, and ship these agents (including import and export) should be subject to all applicable training. The responsible facility official should be notified of all select agent transfers, internal or external.
6. Ensure required permits (e.g., granted by the U.S. Public Health Service, USDA, DOT, U.S. Department of Commerce, and IATA) are obtained before select agents are prepared for transport. Standard operating procedures should be in place for import and export activities.
7. Decontaminate contaminated or possibly contaminated materials before they leave the laboratory area.
8. Avoid hand-carrying select agents when transferring them to other external facilities. If select agents are to be hand-carried on common carriers, all applicable packaging, transport, and training regulations should be followed.
9. Develop and follow a protocol for intrafacility transfer of all select agents.

Emergency Response Plans

Recommendation: Implement an emergency response plan.

9. Limiting access to select agent laboratory and animal areas can make implementing an emergency response more difficult. This should be considered as emergency plans are developed.
10. Evaluate select agent laboratory and animal areas for safety and security concerns before an emergency plan is developed.
11. Develop and integrate laboratory emergency plans with facility wide plans. These plans should also include such adverse event assessments as bomb threats, severe weather (e.g., hurricanes or floods), earthquakes, power outages, and other natural or man-made disasters.
12. Include facility administrators, scientific directors, principal investigators, laboratory workers, maintenance and engineering support staff, facility safety officers, and facility security officials in emergency planning.
13. Include provisions for immediate notification of and response by laboratory and animal directors, laboratory workers, safety office personnel, or other knowledgeable persons when an emergency occurs.
14. Establish advance coordination with local police, fire, and other emergency responders to assist community emergency responders in planning for emergencies in select agent laboratory and animal areas. Discussion should

address security concerns associated with sharing of sensitive information regarding secure work areas.

15. Consider circumstances that might require the emergency relocation of select agents to another secure location.
16. Reevaluate and train employees and conduct exercises of the emergency response plan at least annually.

Incident Reporting

Recommendation: Establish a protocol for reporting adverse incidents.

- Ensure that laboratory directors, in cooperation with facility safety, security, and public relations officials, have policies and procedures in place for reporting and investigating unintentional injuries, incidents (e.g., unauthorized personnel in restricted areas, missing biologic agents or toxins, and unusual or threatening phone calls), or breaches in security measures.
- DHHS or USDA should be notified immediately if select agents are discovered to be missing, released outside the laboratory, involved in worker exposures or infections, or misused. Additionally, all incidents involving select agents (e.g., occupational exposure or breaches of primary containment) should be reported to local and state public health authorities.

Acknowledgments

CDC is grateful to the members of the Select Agent Interagency Workgroup, Biosecurity Subcommittee, and recognizes the contributions of Rachel E. Levinson, M.A., Chairman Biosecurity Subcommittee and Jonathan Y. Richmond, Ph.D., Assistant Chairman, Biosecurity Subcommittee.

References

US Department of Health and Human Services/CDC and National Institutes of Health. Biosafety in microbiological and biomedical laboratories. Richmond JY, McKinney RW, eds. 4th ed. Washington, DC: US Department of Health and Human Services, 1999.

Török TJ, Tauxe RV, Wise RP, et al. Large community outbreak of salmonellosis caused by intentional contamination of restaurant salad bars. *JAMA* 1997;278:389--95.

Kolavic SA, Kimura A, Simons SL, Slutsker L, Barth S, Haley CE. Outbreak of *Shigella dysenteriae* type 2 among laboratory workers due to intentional food contamination. *JAMA* 1997;278:396--8.

US Nuclear Regulatory Commission. Report to Congress on abnormal occurrences July--September 1995; dissemination of information. *Federal Register* 1996;61:7123--4.

US Nuclear Regulatory Commission. Incident investigation report: ingestion of phosphorus-32 at Massachusetts Institute of Technology, Cambridge, Massachusetts,

identified on August 19, 1995 [NUREG-1535]. Washington, DC: US Nuclear Regulatory Commission, 1995.

US Nuclear Regulatory Commission. Preliminary notification of event or unusual occurrence PNO-1-98-052. Subject: intentional ingestion of iodine-125 tainted food (Brown University), November 16, 1998. Washington, DC: US Nuclear Regulatory Commission, 1998.

US Nuclear Regulatory Commission. National Institutes of Health issuance of director's decision under 10 CFR Sec. 2.206. Federal Register 1997;62:50018--33.

Atlas RM. Biological weapons pose challenge for microbiology community. ASM News 1998;64:383--9.

Ruys T. Laboratory design principles. In: Handbook of facilities planning. Ruys T, ed. New York, NY: John Wiley & Sons, 1990;257--64.

CDC. Update: investigation of anthrax associated with intentional exposure and interim public health guidelines, October 2001. MMWR 2001;50:889--93.

US General Accounting Office. Combating terrorism: threat and risk assessments can help prioritize and target program investments. Washington, DC: US General Accounting Office, 1998. Publication no. GAO/NSIAD-98-74.

Johnson B. Understanding, assessing, and communicating topics related to risk in biomedical research facilities [Chapter 10]. In: Richmond JY, ed. Anthology of biosafety: IV. Issues in public health. Mundelein, IL: American Biological Safety Association, 2001;149--166.

Royes C, Johnson B. Security considerations for microbiological and biomedical facilities [Chapter 6]. In: Richmond JY, ed. Anthology of biosafety: V. BSL--4 laboratories. Mundelein, IL: American Biological Safety Association, 2002;131--148.

* Public Law 107--188, June 12, 2002.

† Throughout this report, the term select agent refers to specifically regulated pathogens and toxins as defined in Title 42, Code of Federal Regulations (CFR), Part 73, including pathogens and toxins regulated by both DHHS and USDA (i.e., overlapping agents and toxins). The reader should note that 42 CFR Part 73 has not been published yet, and is still under federal review with anticipated publication in December 2002.

§ Public Law 107--56, October 26, 2001.

¶ U.S. Department of Transportation, Research and Special Programs Administration, 49 CFR, Parts 171--180.

6.6 Registration of Experimentation Involving Biohazardous Agents

The purpose of this document is to ensure adequate review of occupational safety and health precautions, procedures, handling, storage, and waste disposal of biohazardous agents. As the Principal Investigator you should be fully aware of the specific or potential hazards associated with the agents used in your work area.

Prior to work with biological agents, UW EH&S will provide a Biological Use Authorization (BUA) to the PI. For more information, please contact UW Research & Occupational Safety at 206-221-7770.

6.7 Biological Safety Cabinets

Policy

All biological safety cabinets operated at the University of Washington shall be provided, used and maintained in accordance with this policy.

Types

Biological safety cabinets are intended to protect the user and environment from the hazards associated with the handling of infectious material and other biohazardous material. Some types also protect the materials being handled in them from contamination.

1. Class I Cabinets

A ventilated cabinet used for personnel and environmental protection, with an unrecirculated air flow away from the operator. Similar to a chemical fume hood, except a Class I cabinet has a high efficiency particulate air filter (HEPA) on its exhaust outlet and may or may not be connected to an exhaust duct system. Class I cabinets are suitable for work with agents that require Biosafety 1, 2 or 3 containment. The minimum face velocity requirements are an inward flow of 100 linear feet per minute (lfpm).

2. Class II Cabinets

A ventilated cabinet used for personnel, product and environmental protection. The cabinet has an open front with an inward airflow for personnel protection, HEPA filtered laminar airflow for product protection, HEPA filter exhaust air for environmental protection. Class II cabinets are suitable for use with agents that require Biosafety 1, 2 or 3 containment. When toxic chemicals or radionuclides are used, Class II cabinets designed and constructed for this purpose shall be used. Class II biological safety cabinets are divided into the following types: A, B1, B2 and B3.

3. Class II Type A:

- 100 lfpm inward airflow;
- HEPA filtered downward airflow from a common plenum;
- May exhaust HEPA filtered air back into the laboratory; and
- May have positive pressure contaminated ducts and plenums.

4. Class II Type B1:

- 100 lfpm inward and 50 lfpm downward airflow;
- HEPA filtered downward airflow;
- Exhausts most of the contaminated downward airflow through a dedicated duct exhausted to the outside atmosphere; and
- May have biologically contaminated ducts and plenums under negative pressure.

5. **Class II Type B2:**

- 100 lfpm inward and 80 lfpm downward airflow;
- HEPA filtered downward airflow;
- Exhausts all air to the outside atmosphere after HEPA filtration;
- Does not recirculate air within the cabinet or work area; and
- All contaminated ducts and plenums are under negative pressure.

6. **Class II Type B3:**

- 100 lfpm inward and 70 lfpm downward airflow;
- HEPA filtered downward airflow;
- Exhausts all air to the outside atmosphere after HEPA filtration;
- Biologically contaminated ducts and plenums are under negative pressure; and
- 70% of air is recirculated within the hood.

7. **Class III Cabinets:**

A totally enclosed, ventilated cabinet or gas-tight construction. Operations in the cabinet are conducted through attached rubber gloves. The cabinet is maintained under negative pressure and supply air is drawn in through HEPA filters and exhaust air is treated by double HEPA filtration. Class III cabinets are suitable for work with agents that require Biosafety Level 1, 2, 3 or 4 containment. All work proposing to use such a cabinet shall have the work reviewed by Environmental Health and Safety Department reached at 543-7262.

Certification

Certification of biological safety cabinets shall be the responsibility of the user. Certification shall occur annually, if a cabinet has been moved, if a cabinet is suspected of improper functioning or if a different class of research is initiated (e.g., non-infectious to infectious). Contact Environmental Health and Biosafety at 221-7770 for BSC certification.

Use Requirements

Biological safety cabinets shall be used in accordance with the following minimum requirements:

- Obtain approval from Environmental Health and Safety Department prior to using radioactive materials within the cabinet;
- Keep rear exhaust and front air intake grilles unobstructed so as not to hamper proper airflow into and within the cabinet;
- Do not store boxes or other materials on top of the cabinet;
- Turn off the ultraviolet (UV) light while working in the laboratory;
- Allow cabinet to run five minutes each day prior to use;
- Segregate sterile and contaminated items;
- Use horizontal pipette discard pans that contain an effective disinfectant solution inside the cabinet and not use vertical pipette canisters placed on the floor outside of the cabinet;
- Waste bags shall be placed in the rear of the cabinet and not taped onto the front of the cabinet;
- Place all equipment which may produce air turbulence (e.g., centrifuge) near the rear of the hood and stop all other work while this equipment is running:
- Use vacuum filters on the intake end of all vacuum systems;
- Minimize movement in and around the hood; and
- Use proper personal hygiene to prevent product and user contamination.

Spills

If a small spill occurs which is contained within the hood, immediately wipe down the working surface with 70% ethanol or similar solvent. Allow three minutes for saturation. If the spill occurs outside the hood, immediately evacuate the area and contact University Police at 9-911.

6.8 Class II Biohazard Cabinetry Selection and Use Guide

Basic Guidelines

- The biosafety cabinet should be located away from heavy traffic and room air currents that could disrupt the containment provided by the work access opening air barrier. Air turbulence is generated whenever personnel walk past the biosafety cabinet. Currents of air can disrupt the protective capability of the unit. This will be minimized by installing the unit in a low traffic area, such as the corner of the room furthest from the door.
- The biosafety cabinet should be located away from room ventilation air supply inlets that may blow across the front opening or onto the exhaust filter. Air supply currents can create turbulence, which can be avoided by installing the cabinet away from the air supply to the room.
- The biosafety cabinet should be located away from the laboratory door. If there is a window in the laboratory, it should be closed at all times. The biosafety cabinet performance is downgraded by outside air currents. All

attempts must be made to neutralize any interference from door or window drafts.

- Inlet. If this space is not feasible, then a minimum of a 3-inch clearance on each side and a 1.5-inch clearance in the rear of the cabinet must be kept. This clearance is needed for maintenance and electrical safety. The spatial gap will preclude the need to move the cabinet for the annual certification process. This spatial dimension is even more critical when the cabinet is seismically anchored to the wall or the floor.
- Biosafety cabinets must not be located diametrically opposite from each other. Laminar airflow will be greatly hindered by the concurrent operation of two biosafety cabinets, which are being operated across from each other (approximately five feet apart). The amount of ambient air available for each cabinet will be drastically reduced. The potential for air turbulence also increases when two biosafety cabinet operators are working at the same time in the immediate vicinity.
- Vented biosafety cabinets must not be turned off. Biosafety cabinets that are vented constitute part of the room exhaust. To shut off the cabinet will offset the air balance of the room.

MATERIAL SPECIFICATIONS

2. Interior work surfaces should be smooth 300 series stainless steel. Stainless steel is relatively easy to decontaminate and can withstand the adverse effects of chemical disinfectants and ultraviolet light.
3. Exposed interior surfaces should be smooth, abrasion and corrosion resistant, with non-toxic material, which resists crazing, cracking, and chipping. The characteristics described above facilitate decontamination and reduce the possibility of reservoirs of contamination seeping through the cabinet.
4. All nuts, bolts and screws should be stainless steel. The stainless steel nuts, bolts, and screws will withstand the rigors of chemical decontaminants and ultraviolet lights.
5. Fiberglass and other plastics are not authorized in cabinet construction. In the event of a fire, such materials generate large quantities of dense and potentially lethal smoke.
6. Windows should be optically clear and not adversely affected by accepted cleaning methods and decontaminating agents. Glazing materials should be laminated glass, tempered glass or an equivalent material. The glass window and glazing material must be smooth (to facilitate decontamination) and capable of being non-reactive to chemical disinfectants. Unsuitable glazing materials may result in absorption of infectious materials on the window surface, which would only be removed with great difficulty.
7. The biosafety cabinet window should be separately framed and gasketed. It should be mounted in a stainless steel frame which should have all corners welded to form a complete unit with no visible joints.

The glass should be sealed into the stainless steel frame with a flexible material such as a neoprene rubber channel. This tightly sealed window frame will preclude the penetration of potentially infectious material within the cabinet window. Such an occurrence is virtually impossible to decontaminate.

8. Any protective coatings should be resistant to disinfectants including the following:
9. 4% HCl
10. 4% NaOH
11. 1% quaternary ammonia compounds
12. 5% formaldehyde
13. 5000 ppm hypochlorite (1-10 dilution of household bleach or 5% hypochlorite ion)
14. 2% iodophor
15. 5% phenol
16. 70% ethyl alcohol
17. These common disinfectants are routinely used in biological experiments. The cabinet must be capable of withstanding the effects of chemical disinfectants.
18. HWeld surfaces should be smooth and uniform in appearance. Cracks, crevices, depressions, and bubbles resulting from welding should be eliminated in air passages. Uneven surfaces in air passages increase the possibility of eddies of air turbulence and uneven airflow. Uneven welded surfaces within the interior work areas are extremely difficult to decontaminate.
19. Gaskets and sealants should be made of materials which do not release halogens, are non-hardening, non-toxic, stable, odor free and are not affected by gases, cleaning compounds, and ultraviolet light. Due to the nature of the work conducted within the cabinet, such materials must be resistant to multiple decontaminations required during the life of the biosafety cabinet.
20. Hard solder (silver) should be formulated to be corrosion resistant. Such material must withstand the effects of hypochlorite, a common disinfectant.
21. All paints, finishes, and coatings must be uniform in application and capable of withstanding decontamination. All finishes shall resist the chemical action of bleach or a similar disinfectant. An unsuitable finish may actually absorb potentially infectious material or may cause corrosion of the cabinet after cleaning with harsh chemicals.

DESIGN AND CONSTRUCTION

- Interior work areas, exposed interior, and other interior surfaces subject to splash or spillage should be readily accessible and cleanable. Interior work areas, exposed interior, and other interior surfaces, including plenums, should be suitable for vapor or gas decontamination. All portions of the

biosafety cabinet must be accessible for decontamination procedures. Inaccessible areas within the biosafety cabinet may become reservoirs of contamination and hazardous to the certifier of the biosafety cabinet.

- All external corners and angles subjected to splash and spillage must be sealed as smooth as the surfaces being joined and formed without sharp edges that can cause injury. Uneven edges may cut the user and result in an occupational exposure to the biohazards used within the biosafety cabinet.
- All joints and seams must be sealed as smooth as the surfaces being joined. Smooth surfaces facilitate decontamination and minimize the accumulation of dirt or debris.
- All biosafety cabinets must be UL listed and NSF listed. The biosafety cabinet with a UL and NSF 49 listing assures the university that biosafety cabinet has been tested for function and safety (UL-electrical safety; NSF-biological safety).
- All biosafety cabinets should have an audible alarm to indicate when the sash is raised above the manufacturer's specified opening height. The biosafety cabinet function is compromised when the sash is raised over the recommended height since the air intake velocity at the face of the biosafety cabinet will fluctuate. This will also invalidate the NSF listing since the tested height concurs with the manufacturers specifications.
- All HEPA filters must conform to UL 586 or MIL-F-51068D for efficiency. HEPA filters shall be tested for leakage of less than 0.01 percent when certified. All filters must meet durability requirements as well as meet the DOP filter leak test criteria for recertification. The listed filter specifications are suitable for this requirement.
- HEPA filters are required for both supply and exhaust air systems. HEPA filters provide the personnel and product protection needed for biological work. Failure to have properly installed and constructed HEPA filters for both supply and exhaust will compromise the biosafety cabinet operation.
- HEPA filters should be mounted so that air does not bypass the filters. HEPA filters are the source of protection for the biosafety cabinet operator. All filter mountings must fit securely and the filter unit must pass the DOP filter leak test before the biosafety cabinet is certified.
- The minimum face velocity should be no less than 100 lfpm. Personnel and product protection can be assured only with a sufficient flow of air through the cabinet. At lower velocities, spores, plasmids and other small particulate matter can contaminate the biosafety cabinet. At higher velocities, tremendous air supply volumes are required to meet the increased lfpm. 100 lfpm provides the best balance. In addition to the 100-lfpm requirement, all rooms with externally vented biosafety cabinets (both hard connected and thimble connected) must be balanced with respect to the corridor.
- All biosafety cabinets must be installed in accordance with the manufacturer's requirements and NSF listing. The biosafety cabinet manufacturer has provided a product which when used and installed

properly will provide personnel and product protection. However, for example, if the biosafety cabinet needs to be externally vented and is installed as a recirculating unit, then it will be useless. Likewise, the National Sanitation Foundation has tested each biosafety cabinet at a specified standard. To install the biosafety cabinet and deviate from the listed NSF requirements will void the NSF listing.

- The laboratory room must accommodate the electrical current requirements of the biosafety cabinet. Most biosafety cabinets require a 20-amp outlet for installation. In addition, the UV light connection for the biosafety cabinet may also require additional electrical requirements. The user must verify that the facilities can accommodate the electrical burden imposed by the biosafety cabinet or else a power outage may result.
- The light intensity at the work surface should average between 80-150 foot candles. All lamps and ballasts should be accessible and not in contaminated areas. The biosafety cabinet must have adequate lighting, which does not blind, or hinder the vision of the biosafety cabinet user. The lighting apparatus must be installed in an area that can be decontaminated.
- A spillage trough should be provided below the work surface to retain spillage. The spillage trough will catch spilled liquids, which can potentially contaminate the biosafety cabinet interior. The trough must be easily cleanable and capable of withstanding chemical disinfectants.
- Utility connections such as gas or vacuum lines must be made with flexible connections. Flexible connections are less likely to result in the release of gas during an earthquake. Firm connections may be pulled right out of the wall and subsequently result in a gas leak.

EXHAUST REQUIREMENTS

A. Gang ducting of multiple Class II, B type cabinets into one vertical duct is not permitted. It is extremely difficult to balance the air in the rooms where hard ducted biosafety cabinets are installed. The system must be turned off if servicing or repairs are needed. The annual certification procedure is also more difficult because of the potential off gassing or backflow of Para formaldehyde into other biosafety cabinets on the system.

B. Ducts exhausting air from biosafety cabinets should be constructed entirely of stainless steel. A non stainless steel duct may corrode due to bleach vapors or other disinfectants applied within the biosafety cabinet. (Para formaldehyde, alcohol and phenolic-based disinfectants are also commonly used.)

C. A vented biosafety cabinet must remain on at all times. The biosafety cabinet has been installed as part of the room's exhaust. If it is shut off, the room pressure will be positive with respect to the corridor.

D. A Class II, type B biosafety cabinet exhaust stack should be located at least 50 feet away from the building air intake. The exhausted air from a Class II,

type B biosafety cabinet may contain both chemical hazards (antineoplastic and cytotoxic drugs and disinfectants) and biological hazards. To avoid having these hazardous materials drawn into the building air supply, the stack should be 7 feet high or 50 feet away from building air intakes.

E. All Class II, type A biosafety cabinets **MUST NOT** be vented unless the biosafety cabinet is a Class II, type A/B3 "convertible biosafety cabinet". The Class II, type A biosafety cabinet has a biologically contaminated positive pressure plenum with HEPA filtered laminar airflow and HEPA filtered exhaust air. It is designed to have exhaust air circulated through these filters back into the room. Venting this cabinet through an external duct will invalidate the manufacturer's specifications and NSF listing.

F. All Class II, type B1 biosafety cabinets must be vented outside the building in a dedicated exhaust which is not recirculated through the building. The Class II, type B1 biosafety cabinet has all biologically contaminated plenums and ducts under negative pressure. It is designed to have 30 percent of the filtered air recirculated back into room; 70 percent of the air will be externally exhausted through a duct. Failure to properly install this biosafety cabinet will invalidate the manufacturer's warranty and the NSF listing.

G. All Class II, type B2 biosafety cabinets must be vented outside the building in a total exhaust system. The Class II, type B2 biosafety cabinet has all biologically contaminated plenums and ducts under negative pressure. It is designed to have 100 percent of the filtered air externally exhausted through a duct in a total exhaust ventilation system. Failure to properly install this biosafety cabinet with a total exhaust system will invalidate the manufacturer's warranty and the NSF listing.

H All Class II, type B3 biosafety cabinets must be vented outside the building in a dedicated exhaust, which is not recirculated through the building. The Class II, type B3 biosafety cabinet has all biologically contaminated plenums and ducts under negative pressure. It is designed to have 70 percent of the filtered air recirculated back into room; 30 percent of the air will be externally exhausted through a duct. Failure to properly install this biosafety cabinet will invalidate the manufacturer's warranty and the NSF listing.

I. Class II Type B3 biosafety cabinets can be either thimbles connected or hard ducted. Both connections are valid. A thimble connection reduces the potential of backflow during an electrical outage by alleviating pressure through a space in the duct.

6.9 Biosafety Level Laboratory Design Criteria

BIOSAFETY LEVEL 1 LABORATORY DESIGN CRITERIA

- A. The laboratory is designed to be easily cleaned. The walls should be painted in such a manner to facilitate clean up in the event of a splash. The floors should be solid sheet vinyl or solid slab. Wood is not appropriate because wood absorbs liquid such as blood. Tiles are not appropriate because biological material can seep in between the tiles making decontamination virtually impossible.
- B. Bench tops should be impervious to water and resistant to acids, alkalis, organic solvents, and moderate heat. Wooden bench tops are not appropriate because an unfinished wood surface can absorb liquids. Fiberglass is inappropriate since it can degrade when strong disinfectants are applied.
- C. Laboratory furniture should be sturdy. Spaces between benches, cabinets, and equipment should be accessible for cleaning. Laboratory furniture should have smooth surfaces so as to resist the absorption of liquids and the harsh effects of decontaminants. Furniture must not be positioned in such a manner, which makes it difficult to clean spilled liquids or to conduct routine maintenance.
- D. Each laboratory should contain a sink for hand washing. It is extremely important that hands are washed prior to leaving the laboratory. For this reason, the sink should be located close to the egress.

BIOSAFETY LEVEL 2 LABORATORY DESIGN CRITERIA

- A. The laboratory is designed to be easily cleaned. The walls should be painted in such a manner to facilitate clean up in the event of a splash. The floors should be solid sheet vinyl or solid slab. Wood is not appropriate because wood absorbs liquid such as blood. Tiles are not appropriate because biological material can seep in between the tiles making decontamination virtually impossible.
- B. Bench tops should be impervious to water and resistant to acids, alkalis, organic solvents, and moderate heat. Wooden bench tops are not appropriate because an unfinished wood surface can absorb liquids. Fiberglass is inappropriate since it can degrade when strong disinfectants are applied.
- C. Laboratory furniture should be sturdy. Spaces between benches, cabinets, and equipment should be accessible for cleaning. Laboratory furniture should have smooth surfaces so as to resist the absorption of liquids and the harsh effects of decontaminants. Furniture must not be positioned in such a manner, which makes it difficult to clean spilled liquids or to conduct routine maintenance.
- D. Each laboratory should contain a sink for hand washing. It is extremely important that hands are washed prior to leaving the laboratory. For this reason, the sink should be located close to the egress.

E. All breaches of containment (holes in wall, cracked or broken ceiling tiles, etc..) must be repaired as soon as possible. The laboratory room has been designed to contain the biological material. Structural flaws compromise this premise. The air balance may also be adversely affected.

F. An eyewash facility must be readily available.

Ventilation requirements include the following:

A. The room should be negative to the corridor. Potentially harmful aerosols can escape from the containment of the laboratory room unless the room air pressure is negative with respect to the corridor.

B. The room should have mechanically generated supply and exhaust air. The air balance of the room cannot be adjusted unless there is mechanically generated supply air and exhaust.

C. The windows of the room should be closed at all times. Opening a window provides supply air that alters room air balance from negative to positive (to the corridor). The room must be kept under negative pressure.

D. A vented biological safety cabinet must remain on after work in the cabinet has been completed. The biosafety cabinet has been installed as part of the room exhaust. If it is turned off, then the air balance of the room will become positive with respect to the corridor.

E. A dedicated sterile tissue culture room should be balanced with respect to the corridor. A dedicated sterile tissue culture room which is separated from the main lab should be balanced or slightly positive to the adjoining laboratory room so that fungal spores, plasmids, and other small particulate matter and chemical fumes which can contaminate an experiment are not pulled into the room.

Biological safety cabinet and other containment considerations

A. The biological safety cabinet should be located away from the door. Air turbulence is generated whenever personnel walk in the vicinity of the cabinet. This will be minimized by installing the cabinet in a low traffic area.

B. The biological safety cabinet should be located away from the laboratory door. The effectiveness of the biological safety cabinet is degraded by outside air currents. All attempts must be made to neutralize any interference from door or window drafts.

C. Two biological safety cabinets should not be installed directly opposite from each other. Laminar airflow is greatly hindered by the concurrent operation of two biological safety cabinets, which are being operated across from each other (approximately five feet apart). The potential for air turbulence increases when

two cabinet operators are working at the same time in the same immediate vicinity.

E. All biological safety cabinets must be NSF listed, UL approved and installed in accordance with the manufacturers specifications.

F. All BL2 work performed concurrently with minute quantities of toxic chemicals or trace amounts of radionuclides must be done in a Class II, type B biological safety cabinet. A Class II, type A biological safety cabinet will have 100% of the exhaust recirculating within the room. HEPA filters will not provide protection from chemical vapors or volatile radionuclides. Therefore, the biological safety cabinet must be vented, as all three Class II, type B biological safety cabinets are.

G. BL2 work must not be performed in a fume hood. A fume hood is not HEPA filtered and is not sterile.

BIOSAFETY LEVEL 3 LABORATORY DESIGN CRITERIA

A. The laboratory is separated from areas that are open to unrestricted traffic flow within the building. Passage through two sets of self-closing doors is the basic requirement for entry into the laboratory from access corridors or other contiguous areas. A clothes change room (shower optional) may be included in the passageway.

B. The laboratory is designed to be easily cleaned. The walls should be painted in such a manner to facilitate clean up in the event of a splash. The floors should be solid sheet vinyl or solid slab. Wood is not appropriate because wood absorbs liquid such as blood. Tiles are not appropriate because biological material can seep in between the tiles making decontamination virtually impossible.

C. Bench tops should be impervious to water and resistant to acids, alkalis, organic solvents, and moderate heat. Wooden bench tops are not appropriate because an unfinished wood surface can absorb liquids. Fiberglass is inappropriate since it can degrade when strong disinfectants are applied.

D. Laboratory furniture should be sturdy. Spaces between benches, cabinets, and equipment should be accessible for cleaning. Laboratory furniture should have smooth surfaces so as to resist the absorption of liquids and the harsh effects of decontaminants. Furniture must not be positioned in such a manner, which makes it difficult to clean spilled liquids or to conduct routine maintenance.

E. Each laboratory should contain a sink for hand washing. The sink is foot, elbow, or automatically operated and is located near the laboratory exit door.

F. Windows in the laboratory are closed and sealed.

G. All breaches of containment (holes in wall, cracked or broken ceiling tiles, etc..) must be repaired as soon as possible. The laboratory room has been designed to contain the biological material. Structural flaws compromise this premise. The air balance may also be adversely affected.

H. An eyewash facility must be readily available.

I. Vacuum lines are protected with liquid disinfectant traps and HEPA filters, or their equivalent, which are routinely maintained and replaced as needed.

J. A method for decontaminating all laboratory wastes is available, preferably within the laboratory (i.e. autoclave).

Ventilation requirements include the following:

A. The room should be negative to the corridor. This creates directional airflow that draws air from "clean" areas into the laboratory toward "contaminated" areas. Potentially harmful aerosols can escape from the containment of the laboratory room unless the room air pressure is negative with respect to the corridor. Laboratory personnel must verify that the direction of the airflow (into the laboratory) is proper.

B. The High Efficiency Particulate Air (HEPA)-filtered exhaust air from Class II or Class III biological safety cabinets is discharged directly to the outside or through the building exhaust system. If the HEPA-filtered exhaust air from Class II or III biological safety cabinets is to be discharged to the outside through the building exhaust air system, it is connected to his system in a manner (e.g., thimble unit connection) that avoids any interference with the air balance of the cabinets or building exhaust system. Exhaust air from Class II biological safety cabinets may be recirculated within the laboratory if the cabinet is tested and certified at least every twelve months.

C. The exhaust air is not recirculated to any other area of the building, and is discharged to the outside with filtration and other treatment optional. The outside exhaust must be dispersed away from occupied areas and air intakes.

D. A vented biological safety cabinet must remain on after work in the cabinet has been completed. The biological safety cabinet has been installed as part of the room exhaust. If it is turned off, then the air balance of the room will become positive with respect to the corridor.

E. A dedicated sterile tissue culture room should be balanced with respect to the corridor. A dedicated sterile tissue culture room which is separated from the main lab should be balanced or slightly positive to the adjoining laboratory room so that fungal spores, plasmids, and other small particulate matter and chemical fumes which can contaminate an experiment are not pulled into the room.

Biological safety cabinet and other containment considerations

- A. The biological safety cabinet should be located away from the door. Air turbulence is generated whenever personnel walk in the vicinity of the cabinet. This will be minimized by installing the cabinet in a low traffic area.
- B. The biological safety cabinet should be located away from the laboratory door. The effectiveness of the biological safety cabinet is degraded by outside air currents. All attempts must be made to neutralize any interference from door or window drafts.
- C. Two biological safety cabinets should not be installed directly opposite from each other. Laminar airflow is greatly hindered by the concurrent operation of two biological safety cabinets, which are being operated across from each other (approximately five feet apart). The potential for air turbulence increases when two cabinet operators are working at the same time in the same immediate vicinity.
- E. All biological safety cabinets must be NSF listed, UL approved and installed in accordance with the manufacturers specifications.
- F. All BL3 work performed concurrently with minute quantities of toxic chemicals or trace amounts of radionuclides must be done in a Class II, type B biological safety cabinet. A Class II, type A biological safety cabinet will have 100% of the exhaust recirculating within the room. HEPA filters will not provide protection from chemical vapors or volatile radionuclides. Therefore, the biological safety cabinet must be vented, as all three Class II, type B biological safety cabinets are.
- G. BL3 work must not be performed in a fume hood. A fume hood is not HEPA filtered and is not sterile.

6.10 Chemical Disinfectants

The following disinfectants are commonly used:

- Quaternary Ammonium Compounds
- Ethyl Alcohol
- Phenolics
- Iodophors
- Chlorine Compounds
- Paraformaldehyde
- Formaldehyde
- Glutaraldehyde
- Ethylene Oxide

1. Quaternary Ammonium Compounds

Quaternary Ammonium Compounds are commonly used in floor cleaning solutions. Quaternary ammonium compounds are effective in inactivating most vegetative bacteria, fungi, and lipid containing viruses. Quaternary ammonium compounds are NOT effective when used to disinfect Mycobacterium tuberculosis (TB), bacterial spores, and many viruses such as HBV.

Recommended contact time: 10 minutes

Recommended Working Dilution: 0.1-2.0%

Recommended for: cleaning optical instruments and administrative areas in the vicinity of a laboratory.

2. Ethyl Alcohol

Ethanol is commonly used on equipment whose surfaces are susceptible for corrosion if other disinfectants are applied. Ethyl alcohol is effective in inactivating most vegetative bacteria, fungi, and lipid containing viruses. Ethanol is NOT effective when used to disinfect HBV, Mycobacterium tuberculosis (TB) and bacterial spores.

Recommended contact time: 10 minutes

Recommended Working Dilution: 70-85%

Recommended for: Stainless steel surfaces. CAUTION: Do not use 70% ethanol to clean a Class II, type A recirculating biosafety cabinet. The vapors from ethanol are flammable and the lower explosive limit (LEL) for ethanol is easily attained.

3. Phenolics

Phenolics are commonly used to decontaminate surfaces such as lab bench tops. Phenolics are effective in inactivating vegetative bacteria, fungi, TB, lipid-containing viruses and has some effect on HBV. However, Phenolics will not inactivate bacterial spores.

Recommended contact time: 10 minutes

Recommended Working Dilution: 1.0-5.0%

Recommended for an alternative to bleach as a broad-spectrum disinfectant for bench tops, floors, and metal surfaces. Phenolics will not corrode metal surfaces as readily as bleach.

4. Iodophors

Iodine containing compounds or Iodophors is commonly used to decontaminate metal surfaces or equipment. Iodophors are effective in inactivating vegetative bacteria,

fungi, TB and lipid containing viruses and have some effect on HBV. However, Iodophors will not inactivate bacterial spores.

Recommended contact time: 10 minutes

Recommended Working Dilution: 25-1600 ppm, 0.47%

Recommended for: biosafety cabinets, dental equipment, bench tops, floors and lab equipment in general.

5. Chlorine Compounds

Chlorine compounds such as bleach are commonly used in the lab because of the relative ease in accessibility and low cost. Chlorine (hypochlorite) compounds are effective in inactivating vegetative bacteria, fungi, lipid and non-lipid viruses, *Coxiella burnetii* and TB. Chlorine compounds have some effect in inactivating bacterial spores.

Recommended contact time: 10 minutes

Recommended Working Dilution: 500 ppm (1:10 dilution of household bleach, 5% hypochlorite ion)

Recommended for: floors, spills(inactivating liquid specimens), bench tops and contaminated clothing. Do not use bleach on electronic equipment, optical equipment or unpainted stainless steel.

6. Paraformaldehyde and Formaldehyde

Paraformaldehyde and formaldehyde are often used to decontaminate large equipment, such as biosafety cabinets. Paraformaldehyde/formaldehyde will inactivate vegetative bacteria, fungi, lipid and non-lipid viruses, HBV, TB, *Coxiella burnetii*, and bacterial spores. However, paraformaldehyde and formaldehyde are carcinogens and are very toxic to use without the accessibility of a vented fume hood and/or personal protective equipment. **DO NOT USE PARAFORMALDEHYDE OR FORMALDEHYDE IN THE LAB TO DECONTAMINATE EQUIPMENT.** The biosafety cabinet contractor will use paraformaldehyde to decontaminate your biosafety cabinet prior to changing the HEPA filters. Be sure to avoid the biosafety cabinet while this operation is in effect!

7. Glutaraldehyde

Glutaraldehyde is often used to disinfect hospital instruments. Glutaraldehyde will inactivate vegetative bacteria, fungi, lipid and non-lipid viruses, HBV, TB, *Coxiella burnetii*, and bacterial spores. However, Glutaraldehyde is very toxic to use without the accessibility of a vented fume hood and/or personal protective equipment. **DO NOT USE GLUTARALDEHYDE IN THE LAB TO DECONTAMINATE EQUIPMENT.**

8. Ethylene Oxide

Ethylene Oxide is often used to disinfect hospital instruments. Ethylene Oxide will inactivate vegetative bacteria, fungi, lipid and non-lipid viruses, HBV, TB, *Coxiella burnetii*, and bacterial spores. However, Ethylene oxide is a carcinogen and is very toxic to use without mechanically generated ventilation exhaust and personal protective equipment. **DO NOT USE ETHYLENE OXIDE IN THE LAB TO DECONTAMINATE EQUIPMENT.**

6.11 Infectious Agent Transport Procedures

UW laboratory personnel must properly package, transport, and handle any biological samples, which are used in their research. Labeling using the universal biohazard symbol is also required for any laboratory sample in order to prevent accidental exposure to unsuspecting personnel who may be exposed to the biological material (e.g., couriers, administrative staff, and janitors).

When selecting a sample container for specimens to be mailed, choose a product, which is shatterproof (such as polypropylene tubes) and durable enough to withstand the potential physical abuse that may occur during handling. When carrying samples within campus buildings, be sure to label the sample container in the event that it may be lost or accidentally misplaced. Never carry blood or other potentially infectious materials by holding the container in your hand. Use secondary container such as a shatterproof box that can contain a rack or holder of biological samples. The rationale for this is two-fold:

- If your sample breaks, then the box will contain any liquid until you can clean it up. Your sample will not leak on the floor.
- A box will allow you to discreetly move your samples through the building without drawing undue attention to what you're carrying. The only requirements are that the shatterproof box can be easily disinfected and has a biohazard sticker on it.

A. REGULATORY STANDARDS AND GUIDELINES

1. Department of Transportation (DOT)
2. International Air Transport Association (IATA)
3. The United States Postal Service (USPS)
4. The United States Public Health Service (PHS)

B. DEFINITIONS:

1. Diagnostic specimen-any human or animal material including, but not limited to, excreta, secreta, blood and its components, tissue, and tissue fluids being shipped for purposes of diagnosis.
2. Etiologic agent-a viable microorganism or its toxin that causes, or may cause, human disease.
3. Dangerous Goods (DG) - articles or substances that are capable of posing a significant risk to health, safety, property, or the environment when transported by surface or air.
4. Infectious substances -substances containing viable microorganisms including bacterium, virus, rickettsia, parasite, fungus, or recombinant, hybrid or mutant that is known or reasonably believed to cause disease in humans or animals.

C. PACKAGING REQUIREMENTS:

1. Etiologic material or clinical specimens shall be packaged in the primary container as follows:
 - a. The contents of the primary container shall not exceed 50 ml.
 - b. The specimen shall be placed in a securely closed, watertight primary container. Stoppers and screw-capped tubes will be secured with waterproof tape.
 - c. The exterior of the primary container shall be decontaminated prior to transportation. The universal biohazard symbol will be used to identify the specimen or infectious material and placed on the exterior of the primary container.
2. The secondary container shall be packaged as follows:
 - a. One (or more) primary container(s) may be placed within the secondary container (since vermiculite or other absorbent material will be placed within) as long as the total volume of specimen does not exceed 50 ml.
 - b. The absorbent material used within the secondary container shall be sufficient to absorb the contents of the primary container (s), if it should leak.
 - c. The secondary container shall be free of contamination and will be labeled in accordance with a Biohazard Symbol and the following wording "Etiologic Agents-Biomedical Material-In case of damage or leakage notify Environmental Health and Safety Department, University of Washington (206) 543-7262".

The outermost container shall be packaged as follows:

- a. The interior of the outermost container shall be filled with any of the following:
Vermiculite or similar absorbent

Coolant material such as ice or dry ice. If ice or dry ice is used, additional shock absorbent material shall be added and positioned in a manner that allows protection of the specimen should the ice or dry ice melt or sublimate.

Shockproof lining(plastic bubble lining, etc.)

- b. The exterior will be labeled with the universal Biohazard Symbol.
 - c. Prior to transport, the outermost container should be sealed or secured in a manner so as to make it leak proof should the container be placed on its side.
 - d. Prior to transport, the outermost shall be inspected for cracks, leaks, bulges, or other exterior damage.
4. After the specimen has been completely packaged, then the preparation area shall be decontaminated in the event that any leakage has occurred during packaging.

D. RECEIPT

1. Upon receipt of any packaged specimens, immediately check for leakage or damage.

2. If leaking:

Isolate package in either a Class II biological safety cabinet or in a leak-proof, sealed container. Add disinfectant and dispose of as medical waste. Take special precautions if broken glass must be handled.

- b. Call SHEA if BL3 agents are involved. Submerge contents in 10% bleach.

- c. Keep unauthorized personnel away from the package.

3. The package should be opened in the laboratory on an easily cleaned, water resistant surface in the event of leakage.

E. SUMMARY OF SHIPMENT OF DIAGNOSTIC AND INFECTIOUS SAMPLES

1. DOT requires anyone who packages infectious or toxic samples for shipment to be trained every 2 years.

2. The Public Health Service (PHS), the Postal Service (PS), the Department of Transportation (DOT), and the International Air Transport Association (IATA) have regulations on how to ship biological materials.

3. The goal of all regulations is to package biological materials so that they do not leak from the package during transportation.

4. IATA regulations are summarized below. Differences between IATA regulations and the other regulations are noted.
5. IATA regulates the transportation of Dangerous Goods by air.
6. The shipper is responsible for CLASSIFYING the material to be shipped, following the correct PACKING INSTRUCTION, LABELING and MARKING the package, and completing any required DOCUMENTATION.
7. The List of Dangerous Goods is a table in the IATA manual that provides all the information and references needed to correctly prepare a package for shipment.
8. IATA provides Packing Instructions for each classification. They are numbered and are:

Infectious substances	602
Diagnostic specimens	650
Dry ice	904
Toxic substances	there are various instructions
Biological products	650
Genetically modified microorganisms	913

9. Specific labels are required on the outer container for the different classes:

Toxic substances	Class 6 toxic label
Dry ice	Class 9 miscellaneous label
Genetically modified microorganisms	Class 9 miscellaneous label

10. Markings required on the outer container:

- a. The proper shipping name(s) of the contents supplemented with the technical name(s) when required;
- b. The corresponding UN number(s)-these is listed on page I8;
- c. The name and address of the shipper and consignee;
- d. For infectious substances, the name and phone number of a responsible person;
- e. For dry ice, the net weight of dry ice in the package.

11. Infectious substances are required to be shipped in containers, which have passed IATA performance tests. Packages, which have passed these tests, are marked with the UN Specification Markings. DOT, PHS, and PS require the packages to have passed DOT performance tests and no markings are required to be placed on the package to indicate it has passed these tests.

12. The Shipper's Declaration of Dangerous Goods is the documentation required for shipment by air of infectious substances, toxic substances, and genetically modified organisms. It is not required for air shipment of diagnostic specimens or biological products or shipment by ground.

13. Packages containing dangerous goods are inspected for signs of damage or leakage during transport. If a damaged or leaking package is found the CDC, DOT and the sender or receiver will be contacted.

14. DOT does investigate incidents and can issue warning letters or notices of probable violation. Civil and criminal penalties can be enforced for knowingly violating the regulations.

F. PACKAGING DIAGNOSTIC SPECIMENS AND BIOLOGICAL PRODUCTS

The following requirements must be followed when shipping diagnostic specimens and biological products where a low probability exists those infectious substances are present (diagnostic specimens being transported to undergo routine screening tests or for the purpose of initial diagnosis).

1. LEAK PROOF PRIMARY CONTAINER-- This refers to the test tube or flask the material is contained inside.

2. The MAX. QUANTITY ALLOWED per package:

Air shipment of diagnostic specimens: 500-ml/primary containers with 4L. max. per package

Air shipment of biological products; 50-ml/primary containers with a max. of 50 ml/package for products in fragile primary container (e.g., glass) and a max. of 100 ml/package for non-fragile primary container

The US Postal Service: 1000 ml/container for clinical specimens and biological products with a max. of 4L/package for domestic ground shipment.

3. WATER TIGHT SECONDARY CONTAINER-- This is a sealed plastic bag. The test tubes or flasks of specimens go inside a plastic bag that can be sealed.

4. AN ABSORBENT MATERIAL must be placed between the primary receptacle and the secondary packaging. The absorbing material must go inside the plastic bag and be capable of absorbing the entire contents of all liquid in the package.

5. PREVENT CONTACT BETWEEN PRIMARY CONTAINERS by wrapping each individual container. Placing tubes inside a specially designed Styrofoam container, wrapping in bubble wrap or wrapping in absorbing materials will separate primary containers.
6. AN ITEMIZED LIST of contents must be enclosed in the package between the plastic bag and the outer box.
7. SCREW CAPS must be reinforced with adhesive tape.
8. Packages must be at least 4 inches in the smallest overall dimension.
9. Special markings, labels are not required on the outer box except shipment by air requires the wording, "BIOLOGICAL PRODUCTS" or "DIAGNOSTIC SPECIMENS" (as applicable) "NOT RESTRICTED, PACKED IN COMPLIANCE WITH IATA PACKING INSTRUCTION 650".

The US Postal Service requires a shipping name be marked on the outer box such as, "CLINICAL SPECIMENS".

10. A Shipper's Declaration for Dangerous Goods is not required.
11. SLIDES of tissues for diagnosis can be shipped inside a padded envelope or a cardboard box. Place the slides inside a plastic slide box. Use a tissue such as a "chem. wipe" to keep slides from moving around inside the slide box. The cardboard box offers more protection against crushing and breakage of slides. Materials such as bubble wrap can be used as padding surrounding the slide box.
12. There are no requirements beyond the above for shipment of specimens in FORMALIN.

G. PACKAGING INFECTIOUS SUBSTANCES

1. WATER TIGHT PRIMARY RECEPTACLE -- This refers to the test tube or container the material is contained inside.

2. The MAX. QUANTITY ALLOWED per package:

Passenger aircraft or US Mail

Infectious substance, affecting humans 50 ml or 50 g

Infectious substance, affecting animals 50 ml or 50 g

Passenger aircraft only - not by US Airmail

Blood or blood products 4 L with 500 ml max. per primary container

Body parts, organs or whole bodies no limit

Cargo Aircraft only - not by US Airmail

Infectious substance, affecting humans 4 L or 4 Kg with 1000 ml max. per primary container

Infectious substance, affecting animals 4 L or 4 Kg with 1000 ml max. per primary container

3. **WATER TIGHT SECONDARY PACKAGING** -- This refers to a plastic or cardboard like container with a screw top lid or other watertight seal. The primary container goes inside this container.
4. **AN ABSORBENT MATERIAL** must be placed inside the watertight secondary container and it must surround the entire primary container. The absorbing material must be capable of absorbing the entire liquid contents of the primary container.
5. **PREVENT CONTACT OF THE PRIMARY CONTAINERS** by wrapping each individual container. Each tube can be wrapped in absorbent materials, bubble wrap or placed in a specially designed Styrofoam container.
6. **SHOCK ABSORBENT MATERIAL** must be placed between the secondary container and the outer shipping container when shipping volumes greater than 50 ml. The material must be of at least equal volume to the absorbent material surrounding the primary container and it must completely surround the secondary container.
7. **AN ITEMIZED LIST** of the contents must be enclosed in the package between the secondary container and the outer box.
8. **SCREW CAPS** must be reinforced with adhesive tape.
9. Outer packages shipped by air must bear the **UN SPECIFICATION MARKINGS**:

Exception: If shipping domestically by ground (including the US Postal Service), the outer package is not required to have **UN SPECIFICATION MARKINGS**.
10. Packages must be at least 4 inches in the smallest overall dimension.
11. Packages must be labeled with the **INFECTIOUS SUBSTANCE LABEL**. The "Handling Label for Cargo Aircraft Only" must be placed on packages shipped by air containing greater than 50 ml or 50 gm.

Exception: Domestic shipment by the US Postal Service or other ground shipment will accept the **INFECTIOUS SUBSTANCE LABEL** or the "Etiologic Agents/Biohazard Material" label.

12. Packages must be marked next to the infectious substance label with the **UN NUMBER** and the **PROPER SHIPPING NAME**. The **NAME OF THE**

ORGANISM(S) contained in the box must be written in parentheses following the proper shipping name.

Exception: Domestic shipment by ground does not require any markings on the outer package.

13. THE NAME AND TELEPHONE NUMBER of a person responsible for the shipment must be placed on the outside of the package.

14. A SHIPPER'S DECLARATION FOR DANGEROUS GOODS MUST BE COMPLETED for packages shipped via air. The US Postal Service may require a Compliance Certificate to be completed.

15. Packages shipped by the US Postal Service must be sent First-Class, Priority Mail, or Express Mail.

H. PACKAGING DRY ICE

1. Dry ice must be packaged in containers that allow the release of CO₂ gas.
2. Packages must be labeled with the MISCELLANEOUS LABEL.
3. Packages must be marked next to the miscellaneous label with the UN NUMBER and the PROPER SHIPPING NAME.
4. THE NET WEIGHT of dry ice must be marked on the outside of the package.
5. In general, THE MAX. QUANTITY ALLOWED per box is 5 lbs.
6. THE SHIPPER'S DECLARATION IS NOT COMPLETED UNLESS dry ice is used as a refrigerant for shipment of another dangerous good, which requires the completion of the Shipper's Declaration. Do not complete the Shipper's Declaration for shipping diagnostics or biological products on dry ice.

I. PACKAGING GENETICALLY MODIFIED MICROORGANISMS

1. PACKAGE AS INFECTIOUS SUBSTANCES EXCEPT the outer box is not required to bear the specification markings.
2. THE MAX. QUANTITY ALLOWED in a primary receptacle is 100 ml or 100 g. There is no max. quantity limit per package.
3. Packages must be labeled with the MISCELLANEOUS LABEL.
4. Packages must be marked with the UN NUMBER and THE PROPER SHIPPING NAME. THE NAME OF THE GENETICALLY MODIFIED MICRO-ORGANISM(S) contained in the box must be written in parentheses following the proper shipping name.

5. A SHIPPER'S DECLARATION FOR DANGEROUS GOODS MUST BE COMPLETED.

J. PACKAGING TOXINS

Contact Federal Express for instructions.

K. DOCUMENTATION

The Shipper's Declaration for Dangerous Goods is required for shipment by air of infectious substances, toxic substances, and genetically modified organisms. It is not required for shipment of diagnostic specimens or biological products. It is not required when you ship any classification by ground (US Postal Service).

The Shipper's Declaration for Dangerous Goods is a legal document that is signed by the shipper. It must contain no spelling errors, and be completed in one person's handwriting using the same pen or typed.

Instructions for Completion of Shipper's Declaration

Shipper

Enter the full name and address of the shipper. It is advisable to enter a name and telephone number in case of emergency.

Consignee

Enter the full name and address of the consignee. For Infectious Substances also enter the name and telephone number of a responsible person to contact in an emergency.

Air Waybill Number

Enter the Air Waybill number for the shipment. This information may be entered by the shipper, the agent, or the airline.

Number of Pages

Enter the page number and the total number of pages.

Aircraft Limitation

You must delete the box that does not apply by striking it out.

Airport Departure

Enter the full name of the airport or city of departure. This can be entered by the shipper, the agent, or the airline.

Airport of Destination

Enter the full name of the airport or city of destination. This can be entered by the shipper, the agent, or the airline.

Shipment Type

Delete the box that does not apply.

Proper Shipping Name

Enter the proper shipping name and technical name. This is the same name that is marked on the outside of the box. See table below.

Class or Division, UN or ID Number, Packing Group

Enter the class or division for the following list:

Shipping name	Class	UN Number	Packing Group
Infectious substance, affecting humans	6.2	UN2814	none, leave blank
Infectious substance, affecting animals	6.2	UN2900	none, leave blank
Toxins, extracted from living sources,	6.1	UN3172	varies
Genetically modified micro-organisms	9	UN3245	none, leave blank
Dry ice	9	UN1845	III

Subsidiary Risk

There are no subsidiary risks for any of these classes. Leave this column blank.

Quantity and Type of Packing

Enter the total quantity of the dangerous good and the type of material the outer box is made from.

Packing Instruction

Enter the packing instruction number from the list below:

Shipping name	Packing Instruction
Infectious substance, affecting humans	602

Infectious substance, affecting animals	602
Toxins, extracted from living sources	varies
Genetically modified micro-organisms	913
Dry ice	904

Authorization

Leave blank.

Additional Handling Information

Enter:

1. An emergency contact telephone number, which is, manned 24 hrs. a day. It can be the CDC number: (404) 633-5313.
2. The statement, "Prior arrangements as required by IATA Dangerous Goods Regulations 1.3.3.1 have been made."
3. The statement, Prepared according to ICAO/IATA.

Name/Title of Signatory

Enter the name and title of the person signing the Declaration.

Place and Date

Enter the place and date.

Signature

The declaration is signed by the shipper.

6.12 Procedures for Importing Etiologic Agents

The importation of etiologic agents is governed by the following federal regulation:

USPHS 42 CFR - Part 71 Foreign Quarantine, Part 71.54 Etiologic agents, hosts, and vectors.

- (a) A person may not import into the United States, nor distribute after importation, any etiologic agent or any arthropod or other animal host or vector of human disease, or any exotic living arthropod or other animal capable of being a host or vector of human disease unless accompanied by a permit issued by the Director.

(b) Any import coming within the provisions of this section will not be released from custody prior to receipt by the District Director of U.S. Customs Service of a permit issued by the Director (Centers for Disease Control and Prevention).

It is important to obtain a CDC permit PRIOR to requesting an etiologic specimen from a source outside the United States. The UW Biosafety Committee will request that the Principal Investigator indicate the source of any agents used in experiments during the application process. If the investigator intends to obtain the agent from outside the United States, a copy of the CDC permit will be requested by the UW Biosafety Committee as part of the application review. Appropriate CDC documentation is essential since UW may be audited at any time for compliance to etiologic shipping regulations.

If you are not certain if the agents which you intend to use require a CDC importation permit, please call Environmental Health and Biosafety office at 206- 221-7770 which will assist you in making the determination. The CDC's Department of Biosafety will try to approve your request within 10 working days.

NOTE: A permit request form can be requested through the CDC automated fax service.

Call (404) 332-4565, have your own fax number ready and request document number.

Import Permits for Etiologic Agents

CDC-Office of Health and Safety

Biosafety Branch

ITEMS REQUIRING PERMITS

Etiologic agents It is impractical to list all of the several hundred species of etiologic agents. In general, an import permit is needed for any infectious agent known to cause disease in man. This includes, but is not limited to, bacteria, viruses, rickettsia, parasites, yeasts, and molds. In some instances, agents that are suspected of causing human disease, also require a permit.

Biological materials Unsterilized specimens of human and animal tissue (including blood), body discharges, fluids, excretions or similar material, when known or suspected of being infected with disease transmissible to man require a permit under these provisions in order to be imported.

Animals Any animal known or suspected of being infected with any disease transmissible to man. Importation of turtles of less than 4 inches in shell length and all non-human primates requires an importation permit issued by the Division of Quarantine.

Insects Any living insect, or other living arthropod, known or suspected of being infected with any disease transmissible to man. Also, if alive, any fleas, flies, lice, mites, mosquitoes, or ticks, even if uninfected. This includes eggs, larvae, pupae, and nymphs as well as adult forms.

Snails Any snails capable of transmitting schistosomiasis. No mollusks are to be admitted without a permit from either Center for Disease Control or the Department of Agriculture. Any shipment of mollusks with a permit from either agency will be cleared immediately.

Bats All live bats. Bats may also require a permit from the U.S. Department of Interior, Fish and Wildlife Services.

IMPORTATION PERMITS

Many etiologic agents, infectious materials or vectors containing infectious agents are imported from foreign locations into the United States for domestic use and study. Packages containing etiologic agents originating in these foreign locations must have an importation permit issued by the United States Public Health Service. Importation permits are issued only to the importer, who must be located in the United States. The importation permit, with the proper packaging and labeling, will expedite clearance of the package of infectious materials through the United States Public Health Service Division of Quarantine and release by U.S. Customs.

The importer bears responsibility for assuring that the foreign shipping personnel pack and label the infectious materials according to USPHS regulations. Transfers of previously imported material within the U.S. also require a permit for the same reason.

Shipping labels containing the universal biohazard symbol, the address of the importer, the permit number, and the expiration date, are also issued to the importer with the permit. The importer must send the labels and one or more copies of the permit to the shipper. A label must be secured to each package, and a copy of the permit should also be attached to the package. The permit and labels inform the U.S. Customs Service and U.S. Division of Quarantine Personnel of the package contents.

LETTERS OF AUTHORIZATION

After a review of an "Application to Import an Etiological Agent" the issuing officer may issue a "Letter of Authorization" rather than an importation permit. The Letter of Authorization is issued for materials that are judged to be non-infectious, but which might be construed to be infectious by U.S. Customs inspection personnel.

Letters of Authorization may be issued for items such as formalin fixed tissues, sterile cell cultures, clinical materials such as human blood, serum, plasma, urine, cerebrospinal fluid, and other tissues or materials of human origin when there is no evidence or indication that such materials contain an infectious agent.

A copy of a Letter of Authorization should be attached to the package, and also should be furnished to the courier or importation broker. Letters of Authorization are in effect for two years, and do not require a shipping label to be issued by this office.

PACKAGING REQUIREMENTS

Infectious materials imported into this country must be packaged to withstand breakage and leakage of contents, and labeled, as specified in the following federal regulations:

USPHS 42 CFR Part 72 - Interstate Shipment of Etiologic Agents.

DOT 49 CFR PART 173 - Transportation of Etiologic Agents.

For international shipments, the International Air Transport Association (IATA)

Dangerous Goods Regulations should be consulted.

OTHER PERMITS

United States Department of Agriculture (USDA) Animal and Plant Health Inspection Service (APHIS) permits are required for infectious agents of livestock and biological materials containing animal, particularly livestock material.

Tissue (cell) culture techniques customarily use bovine material as a stimulant for cell growth. Tissue culture materials and suspensions of cell culture grown viruses or other etiologic agents containing growth stimulants of bovine or other livestock origin are, therefore, controlled by the USDA due to the potential risk of introduction of exotic animal diseases into the U.S. Further information may be obtained by calling the USDA/APHIS at (301) 436-7885.

United States Department of Interior (USDI) permits are required for certain live animals and all live bats. Call (600) 358-2104 for further information.

EXPORTS OF INFECTIOUS MATERIALS

The export of infectious material may require a license from the Department of Commerce.

6.13 Blood Borne Pathogens Exposure Control

Please note that this program has a glossary. The glossary contains the definitions for various terms used in the program. These terms are highlighted in bold print the first time they appear in the body of the program.

Policy

All University employees shall practice universal precautions to eliminate or minimize employee exposure to blood and other potentially infectious materials.

Employee Exposure Determination

A list of University employee job classifications, which have the potential for occupational exposure to blood or other potentially infectious materials, was reviewed. Each job classification was assigned an exposure level and various job tasks were rated as listed below. This exposure determination was made without regard to the use of personal protective equipment.

Exposure Level	Job Task Ratings
Level I - High Risk	0 - No Risk
Level II - Medium Risk	1 - Secondary Risk
Level III - Minimal Risk	2- Primary Risk

METHODS OF COMPLIANCE

Universal Precautions Controls

Universal precautions shall be observed in all situations where there is potential for contact with blood or other potentially infectious materials. Under circumstances where body fluids are difficult or impossible to differentiate (e.g., dark areas), all such fluids shall be considered potentially infectious.

Engineering Controls

Engineering controls are used to eliminate or minimize employee exposure by isolating or removing blood borne pathogens from the workplace. To ensure their effectiveness, all engineering controls shall be examined and maintained or replaced on a scheduled basis by each department.

Hand washing facilities shall be present and readily accessible to employees. When not feasible, an appropriate antiseptic hand cleanser in conjunction with clean cloth/paper towels or antiseptic towelettes shall be provided. When hand cleansers or towelettes are used, hands shall be washed with soap and running water as soon as feasible.

Engineering controls include, but are not limited to, the following:

Biological safety cabinets to protect workers from possible inhalation of aerosolized infectious agents (Refer to the Biological Safety Cabinet Policy, Section 6.5 for additional information);

Re-sheath able needles that encase the needle immediately after use to prevent needle stick injuries and exposures;

“Sharps” disposal containers located at the point of use to prevent injury or exposure during transportation of contaminated sharps; and

Secondary leak proof containers used during transportation to help prevent spills if the primary container breaks.

Work Practice Controls

- Work practice controls involve altering the manner in which the job is being performed. Correct work procedures include, but are not limited to, the following:
- Proper handling and disposal of needles and sharps, used bandages and gauze, linens, and all other emergency items that come in contact with blood or other potentially infectious materials;
- Recapping, removing, bending, shearing or breaking needles is prohibited (Note: If needle recapping is absolutely necessary such as with incremental doses of medication or the injection of radioactive materials, a one-handed method or mechanical device approved for this purpose shall be used.);
- Wearing gloves whenever handling tissues or body fluids;
- Regular hand washing is recommended even when personal protective equipment such as gloves are removed;
- Eating, drinking, smoking, applying cosmetics or lip balm, and handling contact lenses is prohibited in work areas where there is a reasonable likelihood of occupational exposure;
- Food and drink shall not be kept in refrigerators, freezers, shelves, cabinets or on countertops or bench tops where blood or other potentially infectious materials are present;
- All procedures involving blood or other potentially infectious materials shall be performed in such a manner as to minimize splashing, spraying, spattering, and generation of droplets of these substances;
- Wash hands and any other skin with soap and water or flush mucous membranes with water immediately or as soon as feasible following contact of such body areas with blood or other potentially infectious materials;
- Mouth pipetting/suctioning of blood or other potentially infectious materials is prohibited;

- Specimens of blood or other potentially infectious materials shall be placed in a container that prevents leakage during collection, handling, processing, storage, transport or shipping;
- If a specimen could puncture the primary container, the primary container shall be placed within a secondary container, which is puncture-resistant, labeled or color-coded;
- If outside contamination of the primary container occurs, the primary container shall be placed within a second container that prevents leakage during handling, processing, storage, transport, or shipping, and is labeled or color-coded; and
- Equipment that has been contaminated with blood or other potentially infectious materials shall be decontaminated before being serviced or shipped unless it can be shown that decontamination of the equipment is not feasible. Equipment, or portions thereof that are not decontaminated require that a warning label be affixed.

Housekeeping

The worksite shall be maintained in a clean and sanitary condition. A written schedule for cleaning and a method of decontamination, based on the location, type of surface, type of soil present and procedures being performed in each area shall be maintained by the lab technician Jack Herndon.

All equipment and working surfaces will be cleaned and decontaminated after contact with blood or other potentially infectious materials.

The process of decontamination shall be conducted as follows:

- After completion of procedures;
- When surfaces are overtly contaminated;
- After the spill of blood or other potentially infectious materials; and
- At the end of the work shift, if the surface may have become contaminated since the last cleaning.

The common disinfectant used is a sodium hypochlorite (common household bleach) and water solution consisting of one part of bleach to one hundred (1:100) parts of water.

Protective coverings such as plastic wrap or aluminum foil shall be removed and replaced at the end of the work shift if they may have become contaminated during the shift or whenever they become visibly contaminated.

Any bins, pails, cans, or other similar receptacles intended for re-use will be inspected and decontaminated before re-use.

Broken glassware shall be handled with the aid of a mechanical device (e.g., brush and dustpan, tongs, or forceps). The mechanical device shall be decontaminated if possible or discarded in accordance with the Disposal of Biohazardous Waste, section 6.12 of this Safety Manual.

Personal Protective Equipment (PPE)

Where occupational exposure remains after the institution of engineering and work practice controls, personal protective equipment shall also be used. Personal protective equipment shall be used in all occupational exposure situations where there is the potential for the employee to come in contact with potentially infectious materials.

Personal protective equipment will be considered "appropriate" only if it does not permit blood or other potentially infectious materials to pass through to or reach the employee's work clothes, street clothes, undergarments, skin, eyes, mouth or other mucous membranes under normal conditions of use and for the duration of time which the protective equipment will be used.

General rules on personal protective equipment are as follows:

- Employees must be trained how to use personal protective equipment properly;
- Personal protective equipment must be appropriate for the task;
- Personal protective clothing and equipment must be suitable meaning the level of protection must fit the expected exposure (e.g., gloves would be sufficient for a laboratory technician who is drawing blood while a pathologist conducting an autopsy would need considerably more protective clothing);
- The University shall provide, repair or replace personal protective equipment as needed to maintain its effectiveness at no cost to the employee;
- All personal protective equipment shall be available in the appropriate sizes and readily accessible at the worksite or issued to the employees; and
- If a garment(s) is penetrated by blood or other potentially infectious material, the garment must be removed and replaced immediately or as soon as feasible.

Gloves

Gloves shall be worn when it can be reasonably anticipated that the employee may have contact with blood, other potentially infectious materials, non-intact skin and when handling or touching contaminated items or surfaces.

Gloves shall be made of water impervious materials such as latex, nitrile or rubber. Hypoallergenic gloves, glove liners, powderless gloves, and other similar alternatives shall be readily accessible to employees who are allergic to gloves normally provided.

Cuts and open sores shall be bandaged before donning gloves since gloves can be punctured by sharps.

When using disposable gloves (single use), replace them as soon as practical or when they become visibly contaminated, torn, punctured, or when their ability to function as a barrier is compromised. Disposable gloves must not be washed or decontaminated for re-use.

Utility gloves may be decontaminated for re-use if the integrity of the glove is not compromised. They must be discarded if they are cracked, peeling, torn, punctured, or if they exhibit other signs of deterioration or when their ability to function as a barrier is compromised.

Eye Protection

When performing procedures that are likely to generate splashes, spray, spatter, or droplets of blood or other potentially infectious materials, protective eyewear such as goggles, glasses or face shields shall be worn to protect the eyes.

Face shields can be used to protect from splashes to the nose and mouth in addition to the eyes.

Gowns/Laboratory Coats

Gowns, aprons, lab coats, clinic jackets, or other protective body clothing shall be worn when performing procedures likely to generate splashes or splatters of blood or body fluids and in all occupational exposure situations. Gowns/laboratory coats are used to protect clothing from being contaminated by fluids and soaking through to the skin.

Mouthpieces/Resuscitation Bags

Respiratory devices and pocket mouthpieces are types of personal protective equipment designed to isolate contact from the victim's saliva during resuscitation.

Surgical Caps/Shoe Covers

Surgical caps or hoods and/or shoe covers or boots shall be worn in instances when gross contamination can reasonably be anticipated (i.e., autopsies, orthopedic surgery).

Proper Disposal of Personal Protective Equipment

Personal protective equipment shall be removed prior to leaving the work area. When personal protective equipment is removed, it shall be placed in an appropriate designated area or container for storage, washing, decontamination or disposal.

All soiled laundry and personal protective equipment shall be placed in labeled or color-coded leak-proof bags or containers without sorting or rinsing.

Cleaning, laundering, repair, replacement or disposal of personal protective equipment shall be provided at no cost to the employee.

Each department is responsible for securing contracted services for regular washing of laboratory coats and gowns if reusable coats and/or gowns are used.

Exceptions to Wearing Personal Protective Equipment

Personal protective equipment may be temporarily or briefly declined under rare and extraordinary circumstances where using personal protective equipment may prevent proper delivery of healthcare or public safety services or where personal protective equipment may pose an increased hazard to the safety of the employee.

Situations in which personal protective equipment was temporarily or briefly declined shall be investigated and documented to determine if changes can be instituted to prevent future occurrences.

Regulated Waste Management

All regulated waste shall be placed in closable, leak proof containers constructed to contain all contents during handling, storing, transporting or shipping and shall be labeled properly.

If outside contamination of the regulated waste container occurs, it shall be placed in a secondary container that is closable, constructed to contain all contents and prevent leakage of fluids during handling, storage, transport or shipping, labeled or color-coded and closed prior to removal to prevent spillage or protrusion of contents during handling, storage, transport or shipping.

Potentially infectious waste shall be processed in accordance with the Disposal of Biohazardous Waste, section 6.12.

Contaminated Sharps Disposal

Sharps shall be disposed of in designated containers immediately or as soon as possible after use. The containers shall be labeled or color-coded, leak and puncture proof, closable and easily accessible to the user. They shall be located as close as feasible to the immediate area where sharps are used or can be reasonably anticipated to be found (e.g., laundries) and in such an area as to prevent tampering by unauthorized individuals. A standard 42-inch mounting height as measured from the floor shall be followed.

Sharps containers shall be maintained upright throughout use and not allowed to over-fill. Sharps containers shall be disposed of after they become three-fourths full by making arrangements with a contracted service licensed for the pick-up and disposal of potentially infectious waste materials.

During replacement or removal from the work area, the sharps containers shall be closed to prevent the spillage or protrusion of contents during handling, storage, transport or shipping. The sharps containers shall be placed into a secondary container if leakage is possible. The second container shall be closable, constructed to contain all contents and prevent leakage during handling, storage, transport or shipping, red in color labeled with the biohazard symbol or the words "Infectious Waste".

Reusable containers shall not be opened, emptied, or cleaned manually or in any other manner, which would expose employees to the risk of percutaneous injury.

Hepatitis B Vaccination

Employees who have the potential for occupational exposure shall be provided, at no cost, the hepatitis B vaccine and vaccination series.

The hepatitis B vaccination shall be available to employees within ten working days of initial assignment and after they have received training on the following:

- Efficacy of the vaccine;
- Safety of the vaccine;
- Method of administration;
- Benefits associated with vaccination; and
- Acknowledgement of free vaccine and vaccination.

A hepatitis B prescreening program shall not be a prerequisite for receiving the vaccination.

An employee who initially declines the hepatitis B vaccination shall be allowed to receive the vaccination at a later date if the employee decides to seek the vaccination series. Employees who decline to accept the vaccination shall be required to sign a declination statement.

If a routine booster dose(s) of the hepatitis B vaccine is recommended by the U.S. Public Health Service at a future date, such booster dose(s) shall be made available.

Post Exposure Evaluation Follow-up

All exposure incidents with blood or other potentially infectious materials shall be reported in accordance with the Incident Reporting and Investigation, section 3.14 of this Safety Manual.

Immediately following an exposure incident, a confidential medical evaluation and follow-up shall be provided at no cost to the employee. This medical evaluation shall include at least the following elements:

- Documentation of the route(s) of exposure, and the circumstances under which the exposure incident occurred;
- Identification and documentation of the source individual, unless the employer can establish that identification is infeasible or prohibited by the state or local law;

The source individual's blood shall be tested as soon as feasible and after consent is obtained in order to determine hepatitis B virus (HBV) and human immunodeficiency virus (HIV) infectivity. If consent is not obtained, the employer shall establish that legally required consent cannot be obtained. When the source individual's consent is not required by law, the source individual's blood, if available, shall be tested and the results documented.

When the source individual is already known to be infected with HBV or HIV, testing for the source individuals' known HBV or HIV status need not be repeated.

Results of the source individual's testing shall be made available to the exposed employee, and the employee shall be informed of applicable laws and regulations concerning disclosure of the identify and infectious status of the source individual.

- Collection and testing of blood for HBV and HIV serological status;

The exposed employee's blood shall be collected as soon as feasible and tested after consent is obtained.

If the employee consents to baseline blood collection, but does not give consent at that time for HIV serologic testing, the sample shall be preserved for at least 90 days. If within 90 days of the exposure incident, the employee elects to have the baseline sample tested, such testing shall be done as soon as feasible.

- Post-exposure prophylaxis, when medically indicated, as recommended by the U.S. Public Health Service;
- Counseling; and

- Evaluation of reported illnesses.

Information Provided to the Healthcare Professional

Facilities Services - Safety and Environmental Affairs shall provide the healthcare professional responsible for the employee's hepatitis B vaccination (Primary Care Group) a copy of the regulation.

The employer shall ensure that the healthcare professional evaluating an employee after an exposure incident is provided the following information:

- A copy of the regulation;
- A description of the exposed employee's duties as they relate to the exposure incident;
- Documentation of the route(s) of exposure and circumstances under which exposure occurred;
- Results of the source individual's blood testing, if available; and
- All medical records relevant to the appropriate treatment of the employee including vaccination status.

Written Opinion

The employer shall obtain and provide to the exposed employee a copy of the healthcare professional's written opinion, within 15 days of the completion of the evaluation.

The healthcare professional's written opinion for Hepatitis B vaccination shall be limited to whether Hepatitis B vaccination is indicated for an employee, and if the employee has received such vaccination.

The healthcare professional's written opinion for the post-exposure evaluation and follow-up shall be limited to the following information:

- That the employee has been informed of the results of the evaluation; and
- That the employee has been told about any medical conditions resulting from exposure to blood or other potentially infectious materials which require further evaluation or treatment.

All other findings or diagnosis shall remain confidential and shall not be included in the written report. Medical records shall not be disclosed or reported without the employee's express written consent to any person within or outside the workplace except as required by law.

Labels and Signs

Warning labels including the biohazard symbol shall be affixed to containers of regulated waste, refrigerators, and freezers containing blood or other potentially infectious materials and other containers used to store, transport or ship blood or other potentially infectious materials.

These labels shall be fluorescent orange or orange-red or predominantly so with lettering or symbols in a contrasting color.

Containers or bags used for blood or other potentially infectious materials shall be red in color and labeled with the Biohazard Symbol or the words "Infectious Waste".

Labels shall be affixed as close as feasible to the container by string, wire, adhesive or other method that prevents their loss or unintentional removal.

Red bags or red containers may be substituted for labels.

The employer shall post signs at the entrance to work areas of HIV and HBV research laboratory and production facilities. The sign shall contain the name of the infectious agent, special entrance requirements and the name and telephone number of the responsible person.

TRAINING AND INFORMATION

Employee Training

All employees with the potential for occupational exposure to blood or other potentially infectious materials shall be trained during working hours prior to initial assignment to a task involving the potential for occupational exposure and annually thereafter. This training shall utilize the "Blood borne Pathogens" training booklet generated by Facilities Services - Safety and Environmental Affairs. This training booklet shall be revised to include provisions of the revised standard, as revisions to the standard are published. All presenters shall be knowledgeable in the subject material as it relates to the workplace and provide an opportunity for questions and answers during the training. Department specific training can be conducted utilizing Departmental Infection Control Procedures and/or laboratory protocols.

This comprehensive training program includes the following:

- A copy of the Bloodborne Pathogen regulation;
- Epidemiology and symptoms of bloodborne diseases;
- Modes of transmission of bloodborne pathogens;
- A copy of the written Exposure Control Plan and explanation of the program;

- Methods for recognizing tasks and other activities which may involve exposure to blood or other potentially infectious materials;
- Methods of utilizing existing engineering controls, work practices and personal protective equipment;
- Information on the types, proper use, location, removal, handling, decontamination and disposal of personal protective equipment, including basis for selection;
- Information on the hepatitis B vaccine including the efficacy of the vaccine, safety of the vaccine, method of administration, benefits associated with vaccination, and acknowledgement of the option to decline or accept the free vaccination series;
- Emergency procedures and notifications involving blood or other potentially infectious materials;
- Incident reporting documentation and follow-up procedures;
- Post-exposure and follow-up evaluation subsequent to an exposure incident; and
- Explanation of signs and labels and/or color-coding system required.

All employees attending training shall be required to demonstrate adequate knowledge retention as shown through a learning measurement exercise. Employees not demonstrating adequate knowledge retention shall be retrained and retake the exercise until adequate retention is demonstrated.

RECORD KEEPING

Medical Records

An accurate medical record shall be maintained by Primary Care Group on each employee with occupational exposure. This record shall include the following:

- Name and social security number;
- Hepatitis B vaccination status and dates;
- Copies and results of examinations, medical testing and follow-up procedures; and
- Copies of CEE Department qualification form: Medical Surveillance and Immunizations. The sample of this form is attached at end of this section.

All medical records shall be kept confidential and not disclosed or reported without the employee's express written consent to any person within or outside the workplace.

All records shall be maintained for the duration of employment and 30 years thereafter.

6.14 Disposal of Biohazardous Waste

All laboratories, which manipulate potentially hazardous biological agents and materials, and generate waste containing such agents are responsible for the separation, packaging and treatment of their laboratory waste prior to its removal and disposal. These procedures apply to waste contaminated with or containing biological agents only.

Questions should be directed to the Environmental Health and Biosafety Office, at (206) 221-7770.

1. Definition

Biological waste includes:

Liquids such as used cell culturing media, supernatant, blood or blood fractions (serum), etc., which contain viable biological agents;

Materials considered pathological, including any part of the human body, tissues and bodily fluids, but excluding fluids, extracted teeth, hair, nail clippings and the like that are not infectious;

Any part of an animal infected [or suspected to be infected] with a communicable disease;

Non-sharp, solid laboratory waste (empty plastic cell culture flasks and petri dishes, empty plastic tubes, gloves, wrappers, absorbent tissues, etc.) which may be, or is known to be, contaminated with viable biological agents;

All sharp and pointed items used in medical care, diagnosis, and research, including the manipulation and care of laboratory animals, which should be considered potentially infectious;

Laboratory glassware, which is known or suspected to be contaminated with hazardous biological agents.

2. Packaging and Treatment

Materials contaminated with hazardous biological agents must be collected in the appropriate containers and sterilized or disinfected before disposal. These specific requirements for biological waste must be followed:

a) Liquids containing Biohazardous Agents

Collect liquids in leak-proof containers such as flasks or bottles.

Liquid waste containers designed to withstand autoclaving temperatures must be used when steam sterilization is utilized. To allow pressure equalization, they should not be sealed.

b) Solids Containing Biohazardous Agents

Non-sharp, solid laboratory waste (empty plastic cell culture flasks and petri dishes, empty plastic tubes, gloves, wrappers, absorbent tissues, etc.) which may be, or is known to be, contaminated with viable biological agents should be collected in autoclavable bags. These plastic bags display the biohazard-warning symbol and are available from Stores in the Medical Sciences Building.

Note: Autoclavable bags should be used for solid, non-sharp, hazardous biological waste only and disposed of appropriately. They should not be used for the collection of other solid hazardous or nonhazardous waste that may require other treatment or disposal methods.

For laboratories generating large volumes of agar gel in disposable petri dishes and tubes requiring sterilization, such waste should be collected in a white plastic 20-litre pail in the laboratory. Autoclavable bags filled with plastic ware containing agar gel tend to leak fluids during and after the sterilization process. The pail will contain the liquids released by the agar gel. After autoclaving and cooling, the pail must be placed beside other waste awaiting removal by service workers.

c) Sterilization and Disinfection

Inactivate the biological agents by employing either chemical disinfection or steam sterilization procedures.

Although chemical disinfectants play a useful role in many situations where decontamination is required, when they are used to sterilize waste, the investigator must assure the U of T Biosafety Committee that the routines and methods achieve the desired objective.

Autoclaving (steam sterilization) is the preferred (and generally regarded as the most reliable) method of sterilizing biological waste. Depending on the volume of waste to be sterilized, it may be necessary to extend the duration of exposure to high temperature steam under pressure.

Steam sterilization is generally not recommended for laboratory waste contaminated with or containing a combination of viable biological agents and significant amounts of hazardous chemical or radioactive materials.

Containers of liquid waste must be placed into an autoclavable tray or pan of sufficient capacity to contain all liquid in the event of vessel failure or breakage inside the autoclave chamber. Use extreme caution when handling autoclaved liquids since they are hot and may boil over.

Autoclavable bags of solid waste should be closed but not sealed airtight to allow steam penetration before they are placed into the autoclave chamber. After autoclaving and cooling, these bags of autoclaved waste must be placed into a black plastic garbage bag.

Black plastic garbage bags are available from Stores (stock #2342 case of 100). Autoclavable bags containing sterilized waste must be placed into black garbage bags to conceal the biohazard-warning symbol that is no longer appropriate.

When full, close the black bag by gathering the opening and applying a twist tie, string, tape, or tying a knot.

3. Labeling

No specific labeling is required. Service workers will remove unlabelled black garbage bags.

Service workers have been instructed to not remove bags of waste displaying the biohazard-warning symbol and to not remove bags of solid waste containing glass or sharp objects.

4. Storage/Disposal

Following steam sterilization or chemical disinfection, innocuous liquids may be disposed of via the laboratory drainage system. Flush with sufficient clean water to purge the drain immediately after disposal of all liquids.

Hazardous chemicals and radioisotopes must not be disposed of in this manner!

Do not pour melted agar into sink or floor drains. Allow it to cool and solidify for disposal as a solid waste. Service workers will remove black garbage bags containing sterilized solid waste and pails containing treated agar gel.

5. Collection Schedule

Special Pick up and Disposal of Untreated Biological Laboratory Waste

Where on-site functioning autoclaves (steam sterilizers) are not available and the conventional use of chemical disinfectants for the inactivation of hazardous biological

agents in laboratory waste is not practicable or not efficacious, other waste handling and disposal methods must be considered.

Autoclave Safety

Autoclaves are such a familiar feature in many laboratories that it is easy to forget what hazards they can pose. The autoclave's job is to render its contents sterile, or free of any living organisms. If it fails to do so, serious health hazards can result. The hot, pressurized steam (270° Fahrenheit, 30 pounds per square inch gauge) that autoclaves generate to do this job makes them serious burn hazards as well. And, because conditions created inside steam autoclaves are so extreme, autoclaves can easily malfunction if they are not carefully maintained.

Before using any autoclave for the first time, read and thoroughly understand the owner's manual because many makes and models have unique characteristics. If you cannot locate the manual, contact the manufacturer and have a copy sent to you.

Modes of Operation

The autoclave uses different patterns of high heat, vacuum, and pressure to sterilize its load. The type of materials you sterilize will determine the type of sterilization "runs" you use. The general types of runs are "liquids" for any type of water-based solutions, "dry goods with vacuum," and "dry goods without vacuum." Autoclaves often have an additional "drying" cycle in which hot air is drawn through the chamber to dry materials before removal. Controls for different brands of autoclave vary, so you should follow manufacturers' instructions about loading, load sizes, and cycle types and settings carefully.

The "liquids" run is longer than the other two but uses lower temperatures to minimize evaporation of the liquids being sterilized. Make sure seals on containers of liquids are loose so vapor expanding during heating will not cause an explosion. Never autoclave any flammable or volatile liquids because they could explode.

The "dry goods with vacuum" run moves steam and heat into the deepest parts of large bags or bundles of materials and produces the best conditions for killing persistent organisms. During this type of run, the chamber alternates between cycles of vacuum and high pressure. Then the chamber is pressurized with steam for a long period, followed by a short vacuum cycle. It is important that steam and pressure be able reach the entire load, so carefully loosen autoclave bag closures once they are in the autoclave.

The "dry goods without vacuum" run simply pressurizes the chamber with steam for the duration of the cycle, and then returns to normal. This process is used primarily for items that have been cleaned but need to be sterilized. Materials should be packed so that the heat and pressure can readily reach the whole load.

Ensuring Thorough Sterilization

It is imperative to know that the autoclave has thoroughly sterilized its contents. Most autoclave bags or tapes are imprinted with a dye that changes color when the correct temperature is reached. The problem with this type of check is that the dye is on the surface of the load, and a positive reading does not ensure that the innermost parts of a large load are also sterile. However, an easy way to check this is to wrap something with autoclave tape (a disposable plastic test tube or pipette tip are possibilities), and attach string to it as it's being put deep into the load. Tape the other end of the string to the outside of the bag so that you can easily pull the indicator out (Do NOT open up a load of potentially infected material to bury something inside). Recover the indicator after the run and confirm that it too has changed color.

Routine Maintenance

It is a good practice to use a biological indicator (e.g., A msc's Proof system, BBL's Kilt) monthly to confirm that the autoclave is working properly. If either the dye (see procedure above) or biological indicator fails, you must examine the autoclave to identify and correct the problem and also re-autoclave the load to ensure sterility.

The best way to ensure your autoclave is working properly is to have regular maintenance performed semi-annually. In addition, users should perform the daily and weekly maintenance procedures described in the owner's manual. Also make sure the drain strainer is clean before each run.

Autoclave Safety

Autoclaves generate extreme heat and high pressure. Users should understand and respect the hazards these can create. Autoclave doors and their gaskets must be firmly locked into place before running the autoclave to prevent a sudden release of high-pressure steam. Most, but not all, autoclaves have safety interlocks that prevent the autoclave from running if the door isn't closed properly. Know if yours has an interlock--you'll need to use extra caution if it doesn't.

Some older autoclaves have little or no heat shielding around the outside. Attach signs warning of "Hot Surfaces, Keep Away" or similar wording on or next to the autoclave to remind people of the hazard. Do not stack or store combustible materials next to an autoclave (cardboard, plastic, volatile or flammable liquids). Use heat-resistant gloves when removing materials after sterilization and avoid touching the inner chamber surfaces.

If you are burned, you can receive treatment at the University Health center. Burns to the face, third-degree burns, or burns over large areas of the body should be treated as emergencies. Call 9-911 from a campus phone or 911 from a pay phone to get help. You can treat minor burns yourself using standard first aid. Regardless of the degree of severity, report the burn to your supervisor or laboratory technician as an occupational injury.

If you have questions about autoclave operation or need help reaching a manufacturer, contact the Office of Environmental Health & Safety at 543-7262.

Chemical Fume Hoods

Policy

Environmental Health and Safety Department shall assist with certifying and maintaining all chemical and horizontal/vertical laminar flow hoods and provide assistance in purchasing and system design of new hoods. Refer to Section 6.5 for biological safety cabinet requirements and procedures.

Fume Hood Requirements

Velocity Requirements

A standardized face velocity for hoods has not been established, but a common recommendation has been in place for over 25 years. The recommended face velocities used at the University of Chicago are listed based on the type of materials used within the hood.

Minimum Face Velocity Based on Material Used:

- Low Toxicity Levels 100 feet per minute (fpm);
- Average Level Toxins 100 fpm;
- Low level radioactive tracer materials with normal toxic hazards 100 fpm;
- Significant chemical toxicity levels and moderate radioactive materials 100 fpm; and
- Higher levels of toxicity and highly radioactive materials 100 fpm.

Hoods shall ventilate by a dedicated exhaust fan with ducts leading directly from the hood to the roof. Horizontal ducts shall be pitched down to prevent accumulations of vapors in low spots. Duct velocities shall be maintained high enough to minimize the trapping of vapors in the exhaust system. Terminal exhaust points shall be located at least 25 feet from any possible air intake (e.g., air intake grills, doors, operable windows) and positioned at a height that allows adequate dispersion of fumes.

General Information

A newly installed or modified hood exhausting vapors from a continuing process that is left unattended shall have an air flow switch connected to a visible and audible warning device.

Appropriate safeguards shall be provided for flammable and explosive agents vented through the hood (e.g., explosion-proof motors and control, scrubber units, biohazard filters).

NOTE: The use of perchloric acid is prohibited unless the hood has been designed for its specific use and manipulation.

Certification

All fume hoods shall be inspected and certified annually to determine a proper face velocity of 100 fpm. The airflow into and within the hood shall not be excessively turbulent (200 fpm). These hoods shall be checked by representatives from Facilities Services - Safety and Environmental Affairs on an annual basis during laboratory reviews. All hoods functioning properly shall have a certification label affixed to the sash height at which the hood was certified.

Hood Usage

When using a fume hood, the following considerations shall apply:

- Fume hoods shall not be used to store chemicals or other materials;
- Avoid potential exposures by not putting any part of your body with the exception of hands and forearms into the hood;
- During manipulation and operation within the hood, sashes shall be kept at or below the certification sticker height to ensure proper air flow and protection of the use;
- Filters shall be maintained as recommended by the manufacturer;
- If any hood is suspected of not operating properly, discontinue use of the hood and contact Facilities Services at 206-685-1411 to arrange for testing of the hood(s);
- Do not use hoods, which have not been certified. To have a hood certified, contact Facilities Services - Safety and Environmental Affairs;
- If the hood is covered with materials to protect light sensitive substances, then an opening not less than that which can be considered safe for operation shall be maintained; and
- Hoods equipped with automatic alarms shall be inspected by the user more frequently than once per year and the frequency of this testing should be based on hood usage.

Inspection Process

A two-step process shall be used when inspecting a hood to validate proper working condition.

Step 1. Inspection of Hood

A complete inspection both inside and outside the hood shall be performed by the inspector evaluating the following:

- Use of proper materials designed for that hood;
- Excessive storage of any materials inside hood;
- Physical damage to the hood;
- Items that should not be inside the hood;
- The ability of the sash to open, close and stay in a stationary position; and
- Proper function of the hood flow indicator and alarm, if present.

Step 2. Determination of the Hood's Face Velocity

The face velocity of the hood shall be determined by using a velocity meter or other approved device using the low setting or low probe setting. The fume hood must first be emptied to facilitate access.

When using a velocity meter to determine face velocity, the unit shall be placed at a nine-point schematic in order to determine the average flow rate of the hood.

This shall be done with the sash in its fullest raised position. (Refer to diagram 1.1 below.)

Diagram 1.1

1 2 3
4 5 6
7 8 9

If the hood fails to meet the required face velocity with the sash open to its fullest position, the sash shall be lowered and the hood re-tested. This process shall be performed until the hood meets the required feet per minute rating.

Note: The sash cannot be lowered to a point less than 12 inches from the base of the sash opening.

Once inspection is completed, a certification sticker indicating the date of inspection and face velocity in feet per minute shall be placed at the point the sash was adjusted to reach certification.

If a hood fails certification, a warning sign shall be placed at a prominent location on the sash of the hood.

This sign shall ONLY be removed by Environmental Health and Safety once the hood has passed certification requirements. Please contact UW EH&S fume hood service at 206-221-5549.

Centrifuge Safety

REMEMBER, CENTRIFUGES ARE IMPORTANT PIECES OF EQUIPMENT. WHEN USED PROPERLY, THEY CAN PERFORM WELL AND FOR A LONG TIME. WHEN ABUSED, THEY BECOME DEFECTIVE VERY QUICKLY AND CAN BE VERY REAL HAZARDS!!!

Some Basic Concepts and Rules:

- Balance all samples as closely as possible.
- Rotors are rated for certain maximum speeds: KNOW THEM!
- Always put on the lid and secure it.
- Never open a centrifuge until the rotor has stopped.
- Clean all spills immediately.
- With infectious/biologically hazardous material: WAIT 10 MINUTES AFTER THE ROTOR HAS STOPPED before it is opened. Allow aerosols to settle, and then wipe the rotor and centrifuge interior thoroughly.
- Look at rotors for corrosion and fatigue.
- Close lid when not in use especially if the centrifuge is refrigerated!!
- Sign the logbooks every time you use the centrifuge. Make notes on the centrifuge condition.
- Check the adapters use them when needed, and use the correct ones.
- Check the seals on the lids report ones that are cracked or missing.
- Each operator should be trained on proper operating procedures.
- Keep a logbook detailing operation records for centrifuge and rotors.
- Do not exceed safe rotor speed.
- Place a biohazard label on the centrifuge if used for infectious agents.
- Always use sealed safety cups or sealed rotors with O-rings.

- Check tubes and bottles for cracks and deformities before each use.
- Examine O-ring and replace if worn, cracked or missing.
- Never overfill primary containers (don't exceed $\frac{3}{4}$ full).
- Wipe exterior of tubes or bottles with disinfectant prior to loading.
- Wipe the exterior of safety carriers or rotors with disinfectant before removing from the cabinet.
- Stop the centrifuge immediately if an unusual condition (noise or vibration) begins.
- Decontaminate safety carriers or rotors and centrifuge interior after each use.
- Wash hands after removing gloves.
- General Rotor Rules:
- Always start with a clean, dry rotor.
- After your samples are removed, immediately wash the rotor:
NOTE: Do NOT use harsh chemicals to wash rotors. NO NOT USE WIRE BRUSHES
- Rinse with di-water and dry.
- Store rotors in the same place each time.
- Inspect the rotors when you are finished. Report any problems to a faculty member or to EHS immediately.

Centrifuge Spill

If you notice that there has been a leak outside the safety cup or sealed rotor when opening centrifuge:

First:

- Hold breath;
- Close the centrifuge lid;
- Turn centrifuge off; and
- Immediately leave the lab.

Then:

- Notify others to evacuate the lab;
- Post biohazard spill sign.

Notify lab supervisor:

- DO NOT re-enter lab until PI and the Office of Environmental Health and Safety has given clearance (at least 30 minutes);
- Follow centrifuge spill instructions detailed in the Bio-hazard Spill Response – in this Safety Manual, section 6.1.

Decontaminate:

- Remove PPE (turn exposed areas inward);
- Place disposable PPE in biological waste (autoclave reusable PPE);
- Wash any exposed areas with antiseptic soap and water; and
- Wash hands thoroughly.

For Centrifuge Explosions:

Leave room immediately, and notify PI and the Office of Environmental Health and Safety.

Section 7: Radioactivity Protocol

7.1 Radiation Safety Training and Reference

INTRODUCTION

Radiation Safety Manual

This manual is a companion to the Radiation Safety Manual (RSM). The RSM describes the radiation protection program at UW and supercedes all procedures, protocols, and authority given herein. The policies and procedures contained in the RSM have been approved by the Radiation Safety Committee (RSC), and submitted to the Washington Department of Health Services as part of our Radioactive Materials License.

Radiation Safety Office

The Radiation Safety staff is available for consultation and to answer questions on the safe use of radioactive materials and radiation producing machines. Radiation Safety also will keep Principal Investigators informed of changes in government regulations or Institute policies. Please contact UW Radiation Safety 206-543-0463, or at radsaf@uw.edu.

RADIATION FUNDAMENTALS

For the purposes of this manual, we can use a simplistic model of an atom. The atom can be thought of as a system containing a positively charged nucleus and negatively charged electrons, which are in orbit around the nucleus.

The nucleus is the central core of the atom and is composed of two types of particles, protons, which are positively charged, and neutrons that have a neutral charge. Each of these particles has a mass of approximately one atomic mass unit (amu). (1 amu = $1.66\text{E}-24$ g)

Electrons surround the nucleus in orbital of various energies. (In simple terms, the farther an electron is from the nucleus, the less energy is required to free it from the atom.) Electrons are very light compared to protons and neutrons. Each electron has a mass of approximately $5.5\text{E}-4$ amu.

A nuclide is an atom described by its atomic number (Z) and its mass number (A). The Z number is equal to the charge (number of protons) in the nucleus, which is a characteristic of the element. The A number is equal to the total number of protons and neutrons in the nucleus. Nuclides with the same number of protons but with different numbers of neutrons are called isotopes. For example, deuterium ($2,1\text{H}$) and tritium ($3,1\text{H}$) are isotopes of hydrogen with mass numbers two and three, respectively. There are on the order of 200 stable nuclides and over 1100 unstable

(radioactive) nuclides. Radioactive nuclides can generally be described as those, which have an excess or deficiency of neutrons in the nucleus.

Radioactive Decay

Radioactive nuclides (also called radionuclides) can regain stability by nuclear transformation (radioactive decay) emitting radiation in the process. The radiation emitted can be particulate or electromagnetic or both. The various types of radiation and examples of decay are shown below.

ALPHA (α)

Alpha particles have a mass and charge equal to those of helium nuclei (2 protons + 2 neutrons). Alpha particles are emitted during the decay of some very heavy nuclides ($Z > 83$).

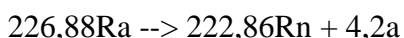

BETA (B^- , B^+)

Beta particles are emitted from the nucleus and have a mass equal to that of electrons. Betas can have either a negative charge or a positive charge. Negatively charged betas are equivalent to electrons and are emitted during the decay of neutron rich nuclides.

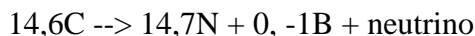

Positively charged betas (positrons) are emitted during the decay of proton rich nuclides.

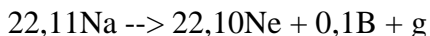

GAMMA (g)

Gammas (also called gamma rays) are electromagnetic radiation (photons). Gammas are emitted during energy level transitions in the nucleus. They may also be emitted during other modes of decay.

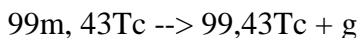

ELECTRON CAPTURE

In certain neutron deficient nuclides, the nucleus will capture an orbital electron resulting in conversion of a proton into a neutron. This type of decay also involves gamma emission as well as x-ray emission as other electrons fall into the orbital vacated by the captured electrons.

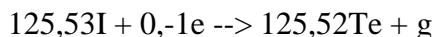

FISSION

Fission is the splitting of an atomic nucleus into two smaller nuclei and usually two or three neutrons. This process also releases a large amount of energy in the form of gammas and kinetic energy of the fission fragments and neutrons.



NEUTRONS (n)

For a few radionuclides, a neutron can be emitted during the decay process.

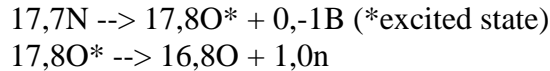

X-RAYS

X-rays are photons emitted during energy level transitions of orbital electrons.

Bremsstrahlung x-rays (braking radiation) are emitted as energetic electrons (betas) are decelerated when passing close to a nucleus. Bremsstrahlung must be considered when using large activities of high-energy beta emitters such as P-32 and S-90.

Characteristics of Radioactive Decay

In addition to the type of radiation emitted, the decay of a radionuclide can be described by the following characteristics.

HALF-LIFE

The half-life of a radionuclide is the time required for one-half of a collection of atoms of that nuclide to decay. Decay is a random process that follows an exponential curve. The number of radioactive nuclei remaining after time (t) is given by:

$$N(t) = N(0) \times \exp(-0.693t/T) \quad \text{Where:}$$
$$N(0) = \text{original number of atoms} \quad N(t) = \text{number remaining at time } t$$
$$t = \text{decay time} \quad T = \text{half-life}$$

ENERGY

The basic unit used to describe the energy of a radiation particle or photon is the electron volt (eV). An electron volt is equal to the amount of energy gained by an electron passing through a potential difference of one volt. The energy of the radiation emitted is a characteristic of the radionuclide. For example, the energy of the alpha emitted by Cm-238 will always be 6.52 MeV, and the gamma emitted by Ba-135m will always be 268 keV. Many radionuclides have more than one decay route. That is, there may be different possible energies that the radiation may have, but they are discreet possibilities. However, when a beta particle is emitted, the energy is divided between the beta and a neutrino. (A neutrino is a particle with no charge and infinitesimally small mass.) Consequently, a beta particle may be emitted with an energy varying in a continuous spectrum from zero to a maximum energy (Emax), which is characteristic of the radionuclide. The average energy is generally around forty percent of the maximum.

INTERACTION OF RADIATION WITH MATTER

Energy Absorption

The transfer of energy from the emitted particle or photon to an absorbing medium has several mechanisms. These mechanisms result in ionization and excitation of atoms or molecules in the absorber. The transferred energy is eventually dissipated as heat.

Ionization is the removal of an orbital electron from an atom or molecule, creating a positively charged ion. In order to cause ionization, the radiation must transfer enough energy to the electron to overcome the binding force on the electron. The ejection of an electron from a molecule can cause dissociation of the molecule.

Excitation is the addition of energy to an orbital electron, thereby transferring the atom or molecule from the ground state to an excited state.

Alpha Particles

Interactions between the electric field of an alpha and orbital electrons in the absorber cause ionization and excitation events. Because of their double charge and low velocity (due to their large mass), alpha particles lose their energy over a relatively short range. One alpha will cause tens of thousands of ionizations per centimeter in air. The range in air of the most energetic alpha particles commonly encountered is about 10 centimeters (4 inches). In denser materials, the range is much less. Alpha particles are easily stopped by a sheet of paper or the protective (dead) layers of skin.

Beta Particles

Normally, a beta particle loses its energy in a large number of ionization and excitation events. Due to the smaller mass, higher velocity and single charge of the beta particle, the range of a beta is considerably greater than that of an alpha of comparable energy. Since its mass is equal to that of an electron, a large deflection can occur with each interaction, resulting in many path changes in an absorbing medium.

If a beta particle passes close to a nucleus, it decreases in velocity due to interaction with the positive charge of the nucleus, emitting x-rays (Bremsstrahlung). The energy of the Bremsstrahlung x-rays has a continuous spectrum up to a maximum equal to the maximum kinetic energy of the betas. The production of Bremsstrahlung increases with the atomic number of the absorber and the energy of the beta. Therefore, low Z materials are used as beta shields.

A positron will lose its kinetic energy through ionizations and excitations in a similar fashion to a negative beta particle. However, the positron will then combine with an electron. The two particles are annihilated, producing two 511 keV photons called annihilation radiation

Photons

Gammas and x-rays differ only in their origin. Both are electromagnetic radiations, and differ only from radio waves and visible light in having much shorter wavelengths. They have zero rest mass and travel with the speed of light. They are basically distortions in the electromagnetic field of space, and interact electrically with atoms even though they have no net electrical charge. While alphas and betas have a finite maximum range and can therefore be completely stopped with a sufficient thickness of absorber, photons interact in a probabilistic manner. This means that an individual photon has no definite maximum range. However, the total fraction of photons passing through an absorber decreases exponentially with the thickness of the absorber. There are three mechanisms by which gammas and x-rays lose energy.

The photoelectric effect is one in which the photon imparts all its energy to an orbital electron. The photon simply vanishes, and the absorbing atom becomes ionized as an electron (photoelectron) is ejected. This effect has the highest probability with low energy photons (< 50 keV) and high Z absorbers.

Compton scattering provides a means for partial absorption of photon energy by interaction with a 'free' (loosely bound) electron. The electron is ejected, and the photon continues on to lose more energy in other interactions. In this mechanism of interaction, the photons in a beam are scattered, so that radiation may appear around corners and in front of shields.

Pair production occurs only when the photon energy exceeds 1.02 MeV. In pair production the photon simply disappears in the electric field of a nucleus, and in its place two electrons, a negatron and a positron, are produced from the energy of the photon. The positron will eventually encounter a free electron in the absorbing medium. The two particles annihilate each other and their mass is converted into energy. Two photons are produced each of 0.511 MeV. The ultimate fate of these two photons is energy loss by Compton scattering or the photoelectric effect.

Secondary Ionizations

The electrons from ionizations and pair production will themselves go on to cause more ionization and excitation events in the same way as described for betas.

ACTIVITY, EXPOSURE, AND DOSE

Definitions

ACTIVITY

Activity is the rate of decay (disintegrations/time) of a given amount of radioactive material.

DOSE

Dose is a measure of energy deposited by radiation in a material, or of the relative biological damage produced by that amount of energy given the nature of the radiation.

EXPOSURE

Exposure is a measure of the ionizations produced in air by x-ray or gamma radiation. The term exposure (with its 'normal' definition) is sometimes used to mean dose. (e.g. 'He received a radiation exposure to his hand.')

Units

ACTIVITY

1 Curie (Ci) = 3.7×10^{10} disintegrations per sec (dps). The Becquerel (Bq) is also coming into use as the International System of Units (SI) {XE "International System of Units (SI)"} measure of disintegration rate. 1 Bq = 1 dps, 3.7×10^{10} Bq = 1 Ci, and 1 mCi = 37 MBq.

EXPOSURE

The unit of radiation exposure in air is the roentgen (R). It is defined as that quantity of gamma or x-radiation causing ionization in air equal to 2.58×10^{-4} coulombs per kilogram. Exposure applies only to absorption of gammas and x-rays in air.

DOSE

The rad is a unit of absorbed dose. One rad is equal to an absorbed dose of 100 ergs/gram. (1 erg = 6.24×10^{-11} eV) The SI unit of absorbed dose is the Gray (Gy). 1 Gy = 1 joule/kilogram = 100 rad. An exposure of 1 R results in an absorbed dose of 0.87 rad.

A quality factor (Q) is used to compare the biological damage producing potential of various types of radiation, given equal absorbed doses. The effectiveness of radiation in producing damage is related to the energy loss of the radiation per unit path length. The term used to express this is linear energy transfer (LET). Generally, the greater the LET in tissue, the more effective the radiation is in producing damage. The quality factors for radiations frequently encountered are:

<u>Radiation</u>	<u>Q</u>
Gammas and x-rays	1
Beta particles & electrons	1
Alpha particles & fission fragments	20
Neutrons	10

The rem is a unit of dose equivalent. The dose equivalent in rem is equal to the absorbed dose in rad multiplied by the quality factor. Dose equivalent determinations for internally deposited radioactive materials also take into account other factors such as the non-uniform distribution of some radionuclides (e.g. I-125 in the thyroid). The SI unit for dose equivalent is the Sievert (Sv). 1 Sv = 100 rem.

Calculation of Activities

The half-life of a radionuclide is the time required for one-half of a collection of atoms of that nuclide to decay. This is the same as saying it is the time required for the activity of the sample to be reduced to one-half the original activity. This can be written as:

$$A(t) = A(0) \times \exp(-0.693t/T)$$

$A(0) = \text{original activity}$
 $t = \text{decay time}$

Where:

$$A(t) = \text{activity at time } t$$

$$T = \text{half-life}$$

EXAMPLE

P-32 has a half-life of 14.3 days. On January 10, the activity of a P-32 sample was 10 uCi. What will the activity be on February 6? February 6 is 27 days after January 10, so

$$A(\text{Feb } 6) = A(\text{Jan } 10) \times \exp[-0.693(27/14.3)] = 2.7 \text{ uCi}$$

A quick estimate could also have been made by noting that 27 days is about two half-lives. So the new activity would be about one-half of one-half (i.e. one-fourth) of the original activity.

Calculation of Exposure Rates

Gamma exposure constants (G) for some radionuclides are shown below. G is the exposure rate in R/hr at 1 cm from a 1-mCi point source.

Nuclide	G
Chromium-51	0.16
Cobalt-57	0.9
Cobalt-60	13.2
Gold-198	2.3
Iodine-125	1.5
Nickel-63	3.1
Radium-226	8.25
Tantalum-182	6.8
Zinc-65	2.7

An empirical rule, which may also be used, is

$$6 \times Ci \times n \times E = R/\text{hr @ 1 foot}, \quad \text{Where}$$

$Ci = \text{source strength in curies.}$
 $E = \text{energy of the emitted photons in MeV.}$
 $n = \text{fraction of decays resulting in photons with an energy of } E.$

It should be noted that this formula and the gamma constants are for exposure rates from gammas and x-rays only. Any dose calculations would also have to include the contribution from any particulate radiation that may be emitted.

Inverse Square Law

Exposure rate varies inversely with the square of the distance from a point source of radiation. This is often referred to as the inverse square law.

$$ER2 = ER1 \times (D1/D2)^2 \quad \text{Where}$$

$ER2 = \text{exposure rate at distance 2}$
 $ER1 = \text{exposure rate at distance 1}$
 $D1 = \text{distance 1}$
 $D2 = \text{distance 2}$

For example, from the table above, the G for Co-60 is 13.2. Therefore, the exposure rate at 1 cm from a 1-mCi source would be 13.2 R/hr. At 30 cm from the same source, the exposure rate would be

$$(13.2 \text{ R/hr})(1/30)^2 = 0.0147 \text{ R/hr} = 14.7 \text{ mR/hr.}$$

Beta Dose Rates

For a beta emitter point source, the dose rate can be calculated using the empirical equation

$$300 \times Ci = \text{rad/hr @ 1 foot,} \quad \text{Where}$$

$Ci = \text{source strength in curies.}$

This calculation neglects any shielding provided by the air, which can be significant. For example, the maximum range in air for a beta from S-35 is less than one foot, so the dose rate at one foot is zero for any size S-35 source.

Skin Dose

For energies above 0.6 MeV, the dose rate to the skin from a uniform deposition of 1 $\mu\text{Ci/cm}^2$ of a beta emitter on the skin is about 9 rem/hr.

BIOLOGICAL EFFECTS OF IONIZING RADIATION

Radiation Hazards

The hazards associated with the absorption of radiation in mammalian systems and tissue is related to both the type of radiation and the nature of the absorbing tissue or organ system.

ALPHA

Alpha particles will be stopped by the dead layers of skin, so they are not an external hazard. However, many alpha emitters or their daughters also emit gammas that are penetrating and therefore may present an external hazard. Internally, alphas can be very damaging due to their high linear energy transfer (LET). That is, they deposit all of their energy in a very small area. Based on their chemical properties, alpha emitters can be concentrated in specific tissues or organs.

BETA

Externally, beta particles can deliver a dose to the skin or the tissues of the eye. Many beta emitters also emit gammas. A large activity of a high-energy beta emitter can

create a significant exposure from Bremsstrahlung x-rays produced in shielding material. Internally, betas can be more damaging, especially when concentrated in specific tissues or organs.

PHOTONS

Externally, the hazard from low energy (< 30 keV) gammas and x-rays is primarily to the skin or the tissues of the eye. Higher energies are more penetrating and therefore a whole body hazard. Internally, gamma emitters can affect not only the tissues or organs in which they are deposited, but also surrounding tissues.

Mechanisms of Damage

As discussed earlier, radiation causes atoms and molecules to become ionized or excited. These ionizations and excitations can result in:

- Production of free radicals.
- Breakage of chemical bonds.
- Production of new chemical bonds and cross-linkage between macromolecules.
- Damage to molecules, which regulate vital cell processes (e.g. DNA, RNA, proteins).

Tissue Sensitivity

In general, the radiation sensitivity of a tissue varies directly with the rate of proliferation of its cells and inversely with the degree of differentiation.

Effects of Acute High Radiation Dose

A whole body radiation dose of greater than 25 to 50 rem received in a short time results in the clinical 'acute radiation syndrome.' This syndrome, which is dose related, can result in disruption of the functions of the bone marrow system (>25 rem), the gastro-intestinal system (>500 rem), and the central nervous system (>2000 rem). An acute dose over 300 rem can be lethal.

Effects of Low Radiation Dose

There is no disease uniquely associated with low radiation doses.

Immediate effects are not seen below doses of 25 rem. Latent effects may appear years after a dose is received. The effect of greatest concern is the development of some form of cancer.

The National Academy of Sciences Committee on Biological Effects of Ionizing Radiation (BEIR) issued a report in 1990 entitled *Health Effects of Exposure to Low Levels of Ionizing Radiation*, also known as *BEIR V*. The following is an excerpt from the Executive Summary of the report:

On the basis of the available evidence, the population-weighted average lifetime risk of death from cancer following an acute dose equivalent to all body organs of 0.1 Sv (0.1 Gy of low-LET radiation) is estimated to be

0.8%, although the lifetime risk varies considerably with age at the time of exposure. For low LET radiation, accumulation of the same dose over weeks or months, however, is expected to reduce the lifetime risk appreciably, possibly by a factor of 2 or more. The Committee's estimated risks for males and females are similar. The risk from exposure during childhood is estimated to be about twice as large as the risk for adults, but such estimates of lifetime risk are still highly uncertain due to the limited follow-up of this age group.

.....

The Committee examined in some detail the sources of uncertainty in its risk estimates and concluded that uncertainties due to chance sampling variation in the available epidemiological data are large and more important than potential biases such as those due to differences between various exposed ethnic groups. Due to sampling variation alone, the 90% confidence limits for the Committee's preferred risk models, of increased cancer mortality due to an acute whole body dose of 0.1 Sv to 100,000 males of all ages range from about 500 to 1200 (mean 760); for 100,000 females of all ages, from about 600 to 1200 (mean 810). This increase in lifetime risk is about 4% of the current baseline risk of death due to cancer in the United States. The Committee also estimated lifetime risks with a number of other plausible linear models, which were consistent with the mortality data. The estimated lifetime risks projected by these models were within the range of uncertainty given above. The committee recognizes that its risk estimates become more uncertain when applied to very low doses. Departures from a linear model at low doses, however, could either increase or decrease the risk per unit dose.

UW's whole body dose limit for planned exposures is 500 mrem/year (5 mSv/yr). If a UW worker were to receive the maximum allowable planned dose each year for twenty years, the total dose received would be 10 rem (0.1 Sv). According to the BEIR V report, the worker's chance of death from cancer would increase by approximately 0.4%. This is fairly small compared to the normal chance of death from cancer in the U. S. of about 20%.

RADIATION DOSIMETRY PROGRAM

External Dosimetry

UW currently uses film badge dosimeters and thermo luminescent dosimeters (TLDs) supplied and processed by an independent outside company.

FILM BADGE

The film badge is used to measure whole body dose and shallow dose. It consists of a film packet and a holder. The film is similar to ordinary photographic film but will be exposed by radiation. (It will also be exposed by light, so if the packet is opened or damaged, the reading will be invalid.) The holder has several filters, which help in determining the type and energy of radiation. The badge will detect gamma and x-

rays, high-energy beta particles, and in certain special cases, neutrons. It does not register radiation from low energy beta emitters such as H-3, C-14, and S-35, since their betas will not penetrate the paper covering on the film packet.

The badge is usually worn at the collar or chest level to measure the radiation dose received by the trunk of the body. When not in use, the badge should be left in a safe place on campus away from any radiation sources. (Use the film badge rack if one is provided.) Be sure the badge is available for the film packet exchange which is done monthly.

TLD RING

The TLD ring is used to measure dose to the hand. They are issued to individuals who may use millicurie amounts of a gamma or high-energy beta emitter. The TLD is a small crystal that absorbs the energy from radiation. When heated, it releases the stored energy in the form of visible light. The crystal is mounted in a ring, which should be worn on the hand, which is expected to receive the larger dose. Wear the ring inside your glove with the label facing towards your palm.

PRECAUTIONS

The radiation doses recorded by your dosimeters become part of your occupational radiation dose record. Make sure that this record is valid and accurate by observing the following precautions:

- Always wear your badge when using radioactive materials or radiation producing machines. Wear your ring when using gamma or high-energy beta emitters.
- Keep your dosimeters away from radiation sources when not in use. Do not deliberately expose a dosimeter to radiation or wear your badge when receiving medical or dental x-rays.
- Do not tamper with the film packet or remove it from the holder.
- Never wear someone else's dosimeter or let someone else wear yours.
- Avoid subjecting the badge to high temperatures or getting it wet.

Notify the Safety Office if your badge or ring has been damaged or lost, or if you have reason to believe that you or your dosimeter has received an accidental high dose.

STATE NOTIFICATION

The dosimeter vendor and UW are required by law to report to the Washington Department of Health Services (DHS) any personnel dosimeter, which shows a dose higher than the occupational dose limits. It is a violation of the Washington Radiation Control Regulations and the conditions of our Radioactive Material License to deliberately expose a personnel dosimeter to a radiation source (except when being used as intended). The dose recorded by the dosimeter will become part of the dose record of the individual to whom it was issued unless it can be proven to DHS that the individual did not actually receive the dose.

Internal Dosimetry

UW's license requires that persons authorized to use unsealed radionuclides be included in a bioassay program. On a bi-monthly basis, you may be sent a "Bioassay Information Form" which asks your radionuclide use. Whether or not you receive the form depends on the material you are authorized to use. You must complete and sign the information request, even if you have not used radioactive material during the period in question.

Whether or not a bioassay (usually urinalysis or thyroid assay) is requested by the Safety Office depends on your response. Urine specimen aliquots are counted in the Safety Office liquid scintillation counter and then disposed of. Thyroid assays are done using a calibrated gamma detector in the Safety Office lab.

7.2 RADIOACTIVE MATERIAL HANDLING AND LABORATORY SAFETY

Reduction of Dose to Personnel

The following are ways in which radiation doses can be reduced.

TIME

Carefully plan your activities in order to minimize the time spent handling or in the vicinity of radiation sources.

DISTANCE

Increasing the distance from a radiation source by the use of handling devices will reduce the dose received, since exposure rate decreases as $1/r^2$, where r is the distance from a point source. For example:

At 10 cm, a 5 mCi I-125 source has an exposure rate of 75 mR/hr. Moving to 30cm would reduce the exposure rate to

$$(75 \text{ mR/hr})(10/30)^2 = 8.3 \text{ mR/hr}$$

Note: The $1/r^2$ formula (also known as the inverse square law) does not take into account shielding provided by air. This can be significant for particulate radiation. Even the most energetic alpha particles commonly encountered have a range in air of about 4 inches. A beta from the decay of S-35 has a maximum range in air of about 12 inches.

SHIELDING

As gammas and x-rays pass through an absorber their decrease in number (by the processes discussed in chapter 3) is governed by the energy of the radiation, the density of the absorber medium, and the thickness of the absorber. This can be expressed approximately as

$$I = I_0 \exp(-ux)$$

Where

I_0 is the intensity of the initial radiation,

I is the radiation intensity after it has passed through the absorber,

u is a factor called the linear absorption coefficient (The value of u depends on

x is the thickness of the absorber.

the energy of

TVL & HVL

The thicknesses of an absorber needed to reduce the radiation intensity by a factor of two and by a factor of ten are called the half-value layer (HVL) and the tenth-value layer (TVL), respectively. Approximate lead TVL's, HVL's, and linear attenuation coefficients for some radionuclides are listed below.

Nuclide	Gamma Energy (MeV)	HVL (MM)	TVL(mm)	μ (cm ⁻¹)
I-125	0.035	0.05	0.16	150
Am-241	0.060	0.14	0.45	51
Co-57	0.122	2.0	6.7	3.4
Cs-137	0.662	6.5	21	1.1
Na-22	1.28	9.6	32	0.72
Co-60	1.17 & 1.33	12	40	0.58

Example: At 30 cm, a 10 mCi Co-60 source produces an exposure rate of about 150 mR/hr. How much lead shielding is needed to reduce the rate to 4 mR/hr?

40 mm (one TVL) will reduce the rate to 15 mR/hr. Adding 12 mm (one HVL) will make it 7.5 mR/hr. One more HVL will put the rate at about 4 mR/hr. So the total lead shielding needed is 40 + 12 + 12 = 64 mm.

Shielding Concerns

When designing shielding there are several points to be kept in mind.

- Persons outside the shadow cast by the shield are not necessarily protected.
- A wall or partition may not be a safe shield for people on the other side.
- Radiation can be "scattered" around corners.

BREMSSTRAHLUNG

The absorption of high energy beta radiation (e.g. P-32 and Sr-90) in high Z materials such as lead and tungsten may result in the production of electromagnetic radiation (bremsstrahlung) which is more penetrating than the beta radiation that produced it. Low Z materials such as plastics and glass minimize the production of bremsstrahlung.

Handling Precautions

Here are some of the radiological characteristics of and special precautions associated with some radionuclides commonly used on campus. In addition to the specific

precautions for each nuclide, the following general precautions should always be followed when applicable to your work.

- Whenever practical, designate specific areas for radioactive material handling and use. Clearly label the area and all containers. Minimize and confine contamination by using absorbent paper and spill trays. Handle potentially volatile materials in certified fume hoods.
- Do not smoke, eat, or drink in rooms where radioactive materials are used. Do not store food or drink in refrigerators, freezers, or cold rooms used for radioactive material storage.
- Use an appropriate instrument to detect radioactive contamination. Regularly monitor the work area. Always monitor yourself, the work area, and equipment for contamination when your experiment or operation is completed. Decontaminate when necessary.
- Use appropriate shielding when handling millicurie or greater amounts of gamma emitters or high-energy beta emitters.
- Wear the dosimeters issued to you while using radioactive materials.
- Wash your hands before leaving the lab, using a telephone, or handling food.

P-32 Information

Radioactive half-life	14.3 days
Decay mechanism	Beta emission
Energy	$E_{max} = 1.709 \text{ MeV}$
Contamination monitoring	Thin window Geiger-Mueller detector
Shielding	1 cm lucite
Dosimetry	Film badge, TLD ring, urinalysis

- The dose rate on contact on the side of a 1 mCi delivery vial will be on the order of 1000 mrem/hr. If possible, avoid direct hand contact with vials and sources. When working with 100 uCi or more of P-32, work should be done behind a 1 cm lucite shield.
- One microcurie of P-32 in direct contact with 1 cm² of bare skin gives a dose rate to the skin of about 8 rem/hr. Always protect your skin when handling unsealed materials. Wear gloves, lab coats, and shoes.
- A thin window G-M survey meter should always be available. A survey should be made immediately after use and any 'hot spots' should be decontaminated.
- Film badges must be worn for all P-32 work. TLD rings should be worn for all P-32 work, and are required when handling 1 millicurie or more.
- Handle and store your radioactive waste carefully. The one-gallon polyethylene bottles for liquid waste should be placed in a secondary

container (e.g. a bucket or tray) to contain spills or leaks. When more than a millicurie is involved, place 1 cm lucite in front of the container for shielding. The metal barrels for dry waste provide sufficient shielding but be sure to keep the lid on.

S-35 Information

Radioactive half-life	87.4 days
Decay mechanism	Beta emission
Energy	$E_{max} = 0.167 \text{ MeV}$
Contamination monitoring	Thin window Geiger-Mueller detector, liquid scintillation counter for wipe surveys
Dosimetry	Urinalysis

- Radiolysis of S-35 labeled amino acids may lead to the release of S-35 labeled volatile impurities. Delivery vials should therefore be opened in a fume hood.
- The addition of stabilizers (buffers) will reduce, but not eliminate, the evolution of S-35 volatiles from tissue culture media. Incubators should be checked for contamination after using S-35 methionine or other volatile compounds.
- S-35 may be difficult to distinguish from C-14. If both nuclides are being used in the same laboratory, establish controls to ensure they are kept separate. If 'unknown' contamination is found, treat it as C-14.

I-125 Information

Radioactive half-life	59.6 days
Decay mechanism	Electron capture (gamma and x-ray emission)
Energy	27-35 keV
Contamination monitoring	Thin crystal NaI detector, liquid scintillation counter for wipe surveys
Shielding	Thin lead
Dosimetry	Film badge, TLD ring, thyroid scan

- The dose rate at 1 cm from a 1 mCi point source is about 1.5 rem/hr The dose rate is inversely related to the square of the distance from the source. Thus while a small amount of I-125 held for a short time can result in a

significant dose to the hands, a relatively short separation distance reduces the dose rate to an acceptable level.

- The volatility of iodine requires special handling techniques to minimize radiation doses. Solutions containing iodide ions (such as NaI) should not be made acidic or be frozen. Both lead to formation of volatile elemental iodine. Once bound to a protein, the volatility of the radioiodine is tremendously reduced.
- Always work in a fume hood with a minimum face velocity of at least 125 linear feet per minute when working with NaI. The sash should be below the breathing zone.
- Use shoulder length veterinary gloves with short vinyl gloves on top to minimize skin absorption.
- Avoid opening the septum on delivery vials. It is preferable to remove radioiodine using a hypodermic needle and syringe.

A radiation survey instrument should be available in the immediate area. A low energy scintillation detector is preferable to a G-M detector. You should do a wipe survey in your work areas after each use.

- Film badges must be worn for all radioiodine work, and finger rings are required when handling 1 mCi or more of I-125.
- Use lead to shield quantities of 1 mCi or more. 1 mm of lead will essentially absorb all of the radiation emitted from I-125.
- Call the Safety Office, x6727, to schedule a thyroid assay after using 1mCi or more of NaI, or in cases of suspected accidental contamination.
- Until waste is picked up by Radiation Safety, it should be kept in the waste containers supplied by Radiation Safety and stored in a fume hood.

H-3 (Tritium) Information

Radioactive half-life	12.4 years
Decay mechanism	Beta emission
Energy	$E_{max} = 18.6 \text{ keV}$
Contamination monitoring	Liquid scintillation counter for wipe surveys
Dosimetry	Urinalysis

Because the beta emitted has a very low energy, tritium can not be detected with the usual survey meters found in the lab. Therefore, special care is needed to keep the work area from becoming contaminated. Tritium can be detected by doing a wipe survey and counting the wipes in a liquid scintillation counter.

Many tritiated compounds readily penetrate gloves and skin. Wearing two pairs of gloves and changing the outer pair every fifteen or twenty minutes will reduce the chances of cross contamination and absorption through the skin.

C-14 Information

Radioactive half-life	5730 years
Decay mechanism	Beta emission
Energy	$E_{\max} = 0.156 \text{ MeV}$
Contamination monitoring	Thin window Geiger-Mueller detector, liquid scintillation counter for wipe surveys
Dosimetry	Urinalysis

- Some C-14 labeled compounds can penetrate gloves and skin. Wearing two pairs of gloves and changing the outer pair every fifteen or twenty minutes will reduce the chances of absorption through the skin.
- C-14 may be difficult to distinguish from S-35. If both nuclides are being used in the same laboratory, establish controls to ensure they are kept separate. If 'unknown' contamination is found, treat it as C-14.

RADIATION SURVEY METERS

Introduction

There are several types of portable radiation survey instruments in use on campus. Various types have different qualities and can therefore have very different detection capabilities.

As a user of radioactive materials or radiation producing machines, you are expected to be able to use the survey meters in your laboratory. During your initial training, you will learn how to operate the instruments in your lab. You should know their capabilities and limitations and be able to interpret the meter readings.

GEIGER-MUELLER DETECTOR

The Geiger-Mueller (G-M) counter is the most common radiation detection instrument on campus. In this type of meter, an ionization in the detector results in a large output pulse that causes meter and audio responses. Because of the inherent characteristics of the detector, all initial ionizing events produce the same size output pulse. Therefore, the meter does not differentiate among types or energies of radiation.

Most G-M detectors have a thin mica film 'window' at one end. This window is very fragile. Always use the thin end window for detecting pure beta emitters and low energy photons (e.g. P-32, S-35, C-14, Fe-55, I-125, and x-rays less than 40 keV). The aluminum side wall should be used only for the detection of penetrating x-rays and gamma radiation.

Very low energy beta emitters such as H-3 and Ni-63 are not detectable since their betas do not have enough energy to penetrate the window. They are best detected by using liquid scintillation counting techniques. C-14 and S-35 emit betas energetic enough to pass through the thin window. However, covering the window with plastic wrap or paraffin film will stop most or all of their betas from entering the detector.

The efficiency of a meter for a specific source of radiation is given by the ratio of the meter count rate to the actual disintegration rate of the source (cpm/dpm). Some examples of approximate G-M efficiencies through the end window at 1 inch from a point source are given below:

H-3	not detectable
C-14, S-35	0.2% - 0.8% *
P-32	3% - 8%
I-125	0.01% - 0.03%

* Not detectable if the detector window is covered with paraffin film, plastic wrap, or other material.

Example: Your G-M counter reads 5000 cpm at one inch from a small spot of P-32 contamination on the bench. What is the total activity of the contamination?

actual disintegration rate = $(5000 \text{ cpm}) / (0.05 \text{ cpm/dpm}) = 100,000 \text{ dpm} = 1700 \text{ dps} = 1700 \text{ Bq} = 45 \text{ nCi}$

Because of the randomness of radioactive decay, the meter reading at low count rates often fluctuates widely. For this reason, the audio speaker is sometimes a better indicator of small amounts of radioactivity than the meter reading. At higher count rates, the speaker response is often faster than the meter reading. It is better, therefore, to have the speaker on when using a G-M counter.

Very high radiation fields may temporarily overload the detector circuit resulting in a partial or complete loss of meter or audio response. If this happens, remove the meter and yourself from the area and push the reset button or turn the meter off then back on. The meter should resume normal operation. Always turn on a survey meter before entering an area that might have high radiation fields.

SCINTILLATION DETECTOR

Scintillation detectors which incorporate a sodium iodide crystal are used in some laboratories for the detection of low energy gamma emitters such as I-125. Some survey meters allow the use of either a G-M detector or a scintillation detector. The efficiency of a low energy scintillation probe for the detection of I-125 is about 5% at one inch -- over a hundred times better than a G-M probe.

ION CHAMBER

Ionization chambers are suitable for measuring radiation exposure rate or cumulative radiation exposure at high radiation intensities. They are not especially useful at low radiation intensities or for detecting small quantities of radioactive material.

CALIBRATION

Most survey meters have scales that read in milliRoentgen per hour (mR/hr) and/or counts per minute (cpm) or counts per second (cps). After detector efficiency is taken into consideration, the cpm or cps scales give an indication of the quantity of radioactivity. The mR/hr scales give an indication of the radiation exposure rate. There is an important difference in these measurements. Exposure rate measurements are only valid for electromagnetic radiation.

Radiation Safety calibrates all of the portable radiation survey instruments on campus. We use two general types of calibration procedures -- one for meters that are used for detection and measurement of particulate radiation, and another for meters used for detection and measurement of penetrating electromagnetic radiation. The two procedures are explained briefly below so that you will know what to expect.

Survey meters used in biology and chemistry research labs are calibrated for the detection and measurement of particulate radiation. These meters are calibrated using a pulse generator so that the cpm or cps scales read correctly (i.e. one pulse in = one meter count). If the meter reads only in cpm or cps, we may place an additional calibration tag on the instrument giving the mR/hr equivalent of the count rate reading for penetrating electromagnetic radiation. If the meter also reads in mR/hr, those readings may not be accurate for the measurement of electromagnetic radiation. We will indicate a correction factor.

Survey meters that are used for radiation exposure measurements are calibrated with a comparable radiation source. The mR/hr scale will read correctly when the detector is exposed to electromagnetic radiation greater than 100 keV.

7.3 RADIOACTIVE WASTE DISPOSAL

Waste Minimization

Since all radioactive waste must be stored on campus until it decays or until it can be shipped to an authorized LLRW disposal facility, it is important that the amount of waste generated be kept to a minimum. Radiation Safety has a limited area to store radioactive waste. Some ways to minimize waste are listed below.

- Design experiments to use as little radioactive material as possible.
- Use proper handling techniques. This will reduce the chance of contamination.
- When practical, use techniques, which do not involve radioactive materials. There are many new techniques and products available that can be used in place of radioactive materials.
- Monitor for contamination and dispose of as little as possible. If there is a spot of contamination on a piece of absorbent paper, cut out that spot and dispose of it rather than the whole piece. Don't automatically place your

gloves in the radioactive waste. Monitor them. If there is no detectable contamination, throw them in the regular trash.

- Liquid radioactive waste includes the radioactive material and the first rinse of its experimental container. After the first rinse, the container can be washed in the sink.

Segregation by Half-Life

All radioactive waste must be segregated according to radionuclide half-life. The three categories for segregation are:

- Half-life less than 15 days (P-32)
- Half-life between 15 and 90 days (S-35, Cr-51, I-125)
- Half-life greater than 90 days (H-3, C-14, Ca-45)

Waste containers are marked with the category of waste they are intended for. It is very important that waste is placed in the proper container.

If waste contains two different radionuclides, place it in the container appropriate for the longer half-life.

Disposal by Tags

Radiation Safety will provide a tag (copy attached) for each liquid and solid radioactive waste container. The top portion of the tag must be filled out completely with the following information:

- Principal Investigator
- Radionuclide disposed
- Date, estimated activity, and user for each significant disposal.

Prohibited Items

All radioactive labels, markings, and tape must be defaced or removed before being put in a waste container.

Solid waste cannot be picked up by Radiation Safety if it contains any of the following:

- Hazardous material (e.g. lead, toxins)
- Biohazard bags or other hazardous material markings
- Radioactive markings
- Sharps (e.g. needles, razor blades)

Liquid radioactive waste must be readily soluble or dispersible in water. It must not contain any hazardous materials such as solvents or scintillation fluid.

LEAD PIGS/SHIELDING

Lead shipping containers and other lead shielding should not be disposed of as ordinary trash or placed in solid radioactive waste containers. Lead, which is boxed and identified, will be picked up by Radiation Safety when requested.

GELS

If a gel is very solid at room temperature, it may be disposed of as solid waste. If it is soft or semi-solid at room temperature, use a solubilizer to liquefy it and dispose of it as liquid waste.

DISPOSAL PROCEDURES

Disposal procedures are described in section 7.7, in this manual.

7.4 RADIATION SAFETY FOR X-RAY UNITS

Nature of Analytical X-Rays

Analytical x-ray machines produce intense beams of ionizing radiation that are used for diffraction and fluorescence studies. The most intense part of a beam is that corresponding to the K emission of the target material and is called characteristic radiation. In addition to the characteristic radiation, a continuous radiation spectrum of low intensity is produced ranging from a very low energy to the maximum kV-peak setting. This is referred to as 'bremsstrahlung' or white radiation. Undesirable wavelengths may be filtered out using a monochromator.

X-ray diffraction wavelengths (w) are selected so as to roughly correspond to the inter-atomic distances within the sample, and to minimize fluorescence. Wavelengths commonly used are 1.54 Å (Cu targets), 0.71 Å (Mo targets), 0.56 Å (Ag targets), and 2.3 Å (Cr targets). The relationship between wavelength and x-ray photon energy is determined by the equation

$$E = hc/w \quad \text{where}$$

$E = \text{energy in ergs (1eV} = 1.6E-12 \text{ erg)}$
 $h = \text{Planck's constant} = 6.614E-27 \text{ erg-sec}$
 $c = \text{velocity of light} = 3E10 \text{ cm/sec}$
 $w = \text{wavelength in cm (1\AA} = 1E-8 \text{ cm)}$

X-rays emitted from an open, uncollimated port form a cone of about 30 degrees. The x-ray flux can produce a radiation field at one meter on the order of 10,000 R/hr. A collimator reduces the beam size to about 1 millimeter diameter.

X-Ray Hazards and Biological Effects

X-rays produced by diffraction machines are readily absorbed in the first few millimeters of tissue, and therefore do not contribute any dose to the internal organs of the body. However, the lens of the eye can receive a dose from x-rays of this

energy. Overexposure of lens tissue can lead to the development of lens opacities and cataracts.

Absorbed doses of a few hundred rad may produce a reddening of the skin (erythema), which is transitory in nature. Higher doses -- 10,000 rad and greater -- may produce significant cellular damage resulting in pigment changes and chronic radiation dermatitis. Exposure to erythema doses may not result in immediate skin reddening. The latent period may be from several hours to several days.

(Note: X-rays used for medical diagnosis are about one order of magnitude shorter in wavelength. Diagnostic rays are designed for tissue penetration and are carefully filtered to avoid x-ray damage to the skin caused by the longer, more readily absorbed wavelengths).

Sources of Ionizing Radiation

The primary beam is not the only source of ionizing radiation. Any high voltage discharge is a potential source of x-rays. Faulty high-voltage vacuum-tube rectifiers may emit x-rays of twice the voltage applied to the x-ray tube. Other sources of ionizing radiation are:

- Secondary emissions and scattering from the sample, shielding material, and fluorescent screens.
- Leakage of primary or scattered x-rays through gaps and cracks in shielding.
- Penetration of the primary beam through or scattering from faulty shutters, beam traps, or collimator couplings.

Safety Precautions and Notes

The shielding, safety equipment and safety procedures prescribed for x-ray diffraction equipment are applicable only for up to 75 kV-peak x-rays. Additional or greater precautions are necessary for machines operating at higher voltages.

The PI has the basic responsibility for providing a safe working environment by ensuring that equipment is operationally safe and that users understand safety and operating procedures.

The equipment operator is responsible for his own safety and the safety of others when using an analytical x-ray machine.

Prior to removing shielding or working in the sample area, the operator must check both the warning lights and the current (mA) meter on the console. Never trust a warning light unless it is on! Always use a survey meter to check that the shutters are actually closed if current is still being supplied to the tube. It is possible for a shutter to be stuck partially open even when the indicator shows that it is shut. The best way to avoid an accidental exposure is to turn the machine off before working in the sample area.

Never put any part of the body in the primary beam. Exposure of any part of the body to the collimated beam for even a fraction of a second may result in damage to the exposed tissue.

A person not knowledgeable about x-ray equipment should not attempt to make repairs or remedy malfunctions. If you suspect a machine is malfunctioning, turn it off or unplug it. Place a note on the control panel and inform the PI or his designated representative.

Repairs to the high voltage section must not be made unless the primary leads are disconnected from the high voltage transformer and a signed and dated notice is posted near the x-ray ON switch. Turning off a circuit breaker is not sufficient.

Bare feet are not permitted in the laboratory or around electrical equipment. Even slightly moist skin is an excellent electrical conductor and contact with faulty, ungrounded equipment may result in severe injury or death.

Do not attempt to align x-ray cameras without first consulting an experienced person. Alignment procedures require special training and knowledge.

Special care is required when one power supply is connected to more than one x-ray tube.

EYE PROTECTION

The use of safety glasses or prescription lenses is encouraged when working with analytical x-rays. While glasses cannot be depended upon to provide complete protection to the eyes, they can reduce x-ray exposure. Glass provides about 10 times the protection of plastic. Neither, however, will adequately protect the eye from direct exposure to the primary beam.

FLUORESCENT SCREENS

It is unsafe to inspect an x-ray beam with a fluorescent screen without special precautionary measures. Notify the Safety Office before performing a procedure using a fluorescent screen.

TUBE STATUS INDICATORS

There must be a visual indication located on or near the tube head to indicate when x-rays are being produced. This is usually an assembly consisting of two red bulbs, wired in parallel and labeled X-RAYS ON. If one of the lights is burned out, the operator should either replace it before leaving the room, or leave a note on the light assembly indicating that the bulb is burned out. An unlit warning bulb does not necessarily mean that x-rays are not being produced. Always check the control panel.

SAFETY DEVICES

Interlock switches are used to prevent inadvertent access to the beam. They should not be bypassed. Interlocks should be checked periodically to insure that they are functioning properly.

Interlocks and other safety devices and warning systems are not foolproof or fail-safe. A safety device should be used as a back up to minimize the risk of radiation exposure -- never as a substitute for proper procedures and good judgment.

7.5 ACCELERATOR SAFETY

Accelerator facility designs, operating procedures, and safety protocols (including requirements for installed safety devices) are reviewed and approved by the Radiation Safety Committee. They must also satisfy the requirements of the Washington Radiation Control Regulations.

In research environments such as the Sloan, Kellogg, and Steele accelerator facilities, a major responsibility for safety is placed on the users. Whenever you are in one of the accelerator facilities, you must be aware of and follow the safety protocols of that facility.

Before you start an operation or enter the accelerator or target rooms, be sure to have planned what you are going to do, and understand the safety precautions you will need to take. In particular:

- Know the location of the installed x-ray/gamma and neutron detectors and how to interpret their associated radiation meters adjacent to the control console.
- Portable Geiger-Mueller, ion chamber, and fast neutron detectors are available. Know their capabilities and limitations and how to interpret their readings. If a detector is not working or if you have doubts about its accuracy, report it to a responsible person so that it can be repaired or calibrated as soon as possible.
- Before you enter the accelerator or target room, always check the console to see if terminal voltage is being generated and if the meters from the installed detectors indicate the presence of radiation.
- If you need to enter the accelerator or target room when there is voltage on the accelerator high voltage terminal:
 - notify the operator.
 - wear your film badge.
 - take an operating survey meter with you appropriate for the type and level of radiation you could encounter.
- During accelerator conditioning, hazardous radiation fields may exist near the high voltage terminal. You should avoid being in the vicinity of the tank at any time during the conditioning period.
- In addition to radiation hazards, accelerators generally involve high voltage power supplies and various kinds of moving machinery that may constitute serious hazards for electrical shock or injury.

- Safety devices and installed radiation detectors must be maintained in an operating condition. Inoperative equipment affecting safety must be reported to the Principal Investigator immediately.

The National Council on Radiation Protection and Measurements (NCRP) publishes a series of reports dealing with various aspects of the use of radioactive materials and radiation producing machines, and the design of facilities in which they are used. Their recommendations, while not law, are used by federal and state agencies as the criteria for regulatory licensing and inspections. NCRP Report No. 51 *Radiation Protection Design Guidelines for 0.1 - 100 MeV Particle Accelerator Facilities* is available for review in the Safety Office. An excerpt from this report providing information concerning the types of accelerator radiations that may be encountered under different operating and experimental conditions will be provided to accelerator users.

APPENDICES

7.6 DOSE CONCEPTS

Introduction

This discussion is provided as an additional source of information to those who desire a more in-depth understanding of radiation dose concepts.

Changes to the federal radiation protection regulations took effect in January 1994. These changes were based on reports and recommendations by the International Commission on Radiological Protection (ICRP), the National Council on Radiation Protection and Measurements (NCRP), and other organizations involved with radiation protection.

Total Dose Concept

Previously, the radiation doses received from external radiation sources and internally deposited radioactive materials were treated separately. Limits on internal uptake of radioactive materials were based on the dose to a "critical organ" and could not be compared to the 'whole body' dose received from an external source.

The external dose number was and still is related to the risk of stochastic effects (primarily cancer). For a stochastic effect, the higher the dose received, the greater the chance of developing the effect. The new regulations have a mechanism for determining the increased risk of stochastic effects from an intake of radioactive material. The dose calculated is based on a variety of factors such as the biological half-life of the material, the distribution of the material in the body, and the type and energy of the radiation. The result is that both the external dose and the internal dose

are related to the risk of stochastic effects and thus can be added to obtain a total dose.

Organ Dose

For a few radionuclides, the limits on intake are based on nonstochastic effects rather than stochastic effects. For a nonstochastic effect, the higher the dose received, the more severe the effect. However, unlike stochastic effects, there is a threshold dose, i.e. a certain dose, below which the effect will not occur. Limits on the internal intake of radioactive materials are set to keep organ doses well below the thresholds. Even in these cases, however, the additional risk of stochastic effects must also be determined.

The dose limit for external exposure of the lens of the eye is also based on prevention of a nonstochastic effect (lens opacities).

Definitions

ABSORBED DOSE

The energy imparted by ionizing radiation per unit mass of irradiated material.

DOSE EQUIVALENT

The product of the absorbed dose in tissue, quality factor, and all other necessary modifying factors at the location of interest.

DEEP-DOSE EQUIVALENTS (DDE)

The dose equivalent at a tissue depth of 1 cm. (Applies to external whole-body exposure.)

SHALLOW-DOSE EQUIVALENT

The dose equivalent at a tissue depth of 0.007 cm. (Applies to external exposure of the skin or an extremity.)

EYE DOSE EQUIVALENT

The dose equivalent at a tissue depth of 0.3 cm. (Applies to the external exposure of the lens of the eye.)

COMMITTED DOSE EQUIVALENT (CDE)

The dose equivalent to organs or tissues of reference that will be received from an intake of radioactive material by an individual during the fifty-year period following the intake.

WEIGHTING FACTORS

For an organ or tissue, the proportion of the risk of stochastic effects when the whole body is irradiated uniformly.

COMMITTED EFFECTIVE DOSE EQUIVALENT (CEDE)

The sum of the products of the weighting factors applicable to each of the body organs or tissues that are irradiated and the CDE to these organs or tissues.

TOTAL EFFECTIVE DOSE EQUIVALENT (TEDE)

The sum of the deep-dose equivalent (for external exposures) and the committed effective dose equivalent (for internal exposures). $TEDE = DDE + CEDE$

TOTAL ORGAN DOSE EQUIVALENT (TODE)

The sum of the DDE and the CDE to an organ or tissue.

ANNUAL LIMIT ON INTAKE (ALI)

The derived limit for the amount of radioactive material taken into the body of an adult worker by inhalation or ingestion in a year. ALI is the smaller value of

intake of a gi

Example Dose Calculations

Fortunately, the NRC has already determined the ALIs for all of the radionuclides and listed them in a table. This makes calculating CEDEs and CDEs fairly simple. Table 2 shows the ALIs for several of the radionuclides used at UW.

EXAMPLE 1

P-32 in most chemical forms has an ALI for ingestion of 600 uCi. This is listed as a stochastic ALI, which means that ingesting 600 uCi of P-32 would result in a CEDE of 5 rem.

If a worker accidentally ingests 10 uCi of P-32, the CEDE would be $(10 \text{ uCi})(5 \text{ rem}/600 \text{ uCi}) = 0.083 \text{ rem} = 83 \text{ mrem}$.

EXAMPLE 2

I-125 has a nonstochastic ALI for inhalation of 60 uCi. This means that inhaling 60 uCi of I-125 would result in a CDE to the thyroid of 50 rem. The stochastic ALI for inhalation of I-125 is 200 uCi.

If a worker accidentally inhales 3 uCi of I-125, the CDE to the thyroid would be $(3 \text{ uCi})(50 \text{ rem}/60 \text{ uCi}) = 2.5 \text{ rem}$. The CEDE would be $(3 \text{ uCi})(5 \text{ rem}/200 \text{ uCi}) = 0.075 \text{ rem}$.

Suppose this worker also received an external dose from working with a high energy gamma emitter. Evaluation of his film badge showed a DDE of 50 mrem. The TEDE would then be $50 \text{ mrem} + 75 \text{ mrem} = 125 \text{ mrem}$.

Embryo/Fetus Dose

The dose limit to the embryo/fetus of a declared pregnant woman is 0.5 rem. Efforts must also be made to avoid a dose substantially higher than 0.06 rem in one month. A declared pregnant woman means a woman who has voluntarily informed the Safety Office, in writing, of her pregnancy and the estimated date of conception.

The dose to an embryo/fetus is the sum of the deep-dose equivalent to the declared pregnant woman and the dose from internally deposited radionuclides in the embryo/fetus and in the woman.

Dose Reporting

Each worker who is monitored must be advised annually of his or her dose.

Dose Limits

A summary of dose limits set by the revised regulations is shown in Table 1. The UW Radiation Safety Committee has established the general policy that planned radiation doses shall not exceed ten percent of the limits for adult radiation workers.

The dose limit for an individual member of the public is 0.1 rem/year TEDE.

Table 1
Revised Occupational Dose Limits

Dose Category	Adult Occupational Dose Limit
Total Effective Dose Equivalent (TEDE)	5 rem/year*
Total Organ Dose Equivalent (TODE)	50 rem/year to any individual organ or tissue except the lens of the eye*
Eye Dose Equivalent	15 rem/year*
Shallow Dose Equivalent	50 rem/year*
Embryo/Fetus Dose	0.5 rem for the entire gestation period

*Occupational dose limit for minors is 10% of the adult limit

Table 2
Annual Limit on Intake (ALI) for Radionuclides Commonly Used at UW

Radionuclide	Form	ALI for ingestion (uCi)	ALI for inhalation (uCi)
H-3	gas		8E8
H-3	other	8E4	8E4
C-14	most compounds	2E3	2E3
P-32	most compounds	6E2	9E2
P-33	most compounds	6E3	8E3

S-35	most compounds	8E3 stochastic 1E4 nonstochastic	2E4 stochastic
Ca-45	all compounds	2E3	8E2
Cr-51	most compounds	4E4	5E4
I-125	all compounds	4E1 nonstochastic 1E2 stochastic	6E1 nonstochastic 2E2 stochastic

7.7 RADIATION RULES OF THUMB

Alpha Particles

An alpha energy of at least 7.5 MeV is required to penetrate the protective layer of the skin (0.07mm).

Beta Particles

A beta energy of at least 70 keV is required to penetrate the protective layer of the skin (0.07mm).

The average energy of a beta-spectrum is approximately one-third the maximum energy.

The range of beta particles in air is about 12 ft per MeV. (e.g. The maximum range of P-32 betas is $1.71 \text{ MeV} \times 12 \text{ ft/MeV} = 20 \text{ ft}$).

The skin dose rate from a uniform thin deposition of 1 uCi/cm^2 is about 9 rem/hr for energies above 0.6 MeV.

For a beta emitter point source, the dose rate in rem/hr at one foot is approximately $300 \times \text{Ci}$ where Ci is the source strength in curies. This calculation neglects any shielding provided by the air, which can be significant. For example, the maximum range in air for a beta from S-35 is less than one foot, so the dose rate at one foot is zero for any size S-35 source.

Gammas and X-Rays

For a point source gamma emitter with energies between 0.07 and 2 MeV, the exposure rate in R/hr at 1 foot is approximately $6 \times C \times E \times n$, where C is the activity in curies; E is the energy in MeV; and n is the number of gammas per disintegration.

Gammas and x-rays up to 2 MeV will be attenuated by at least a factor of 10 by 2 inches of lead.

SI UNITS AND CONVERSION FACTORS

SI Units for Radioactive Materials

Prepared by
U.S. Council for Energy Awareness
Committee on Radionuclides and Radiopharmaceuticals
Suite 400
1776 I Street, N.W.
Washington, D.C. 20006-3708
202/293-0770

SI (Système International) units are now being used in many countries as the primary measurement system, including measurement of radioactivity, and the system is coming into use in the United States. Many journals (including those published by the American Medical Association) now require the use of SI units, and U.S. regulatory agencies are beginning to use SI units as well as conventional units in regulations. It is the policy of the United States Government that regulations should not impede the transition to SI units.

The U.S. Trade Act of 1988 includes a provision establishing federal policy to designate the metric system as the preferred measurement system for U.S. trade and commerce. It also requires all federal agencies to adopt the metric system for business-related activities by 1992, except where it proves impractical.

USCEA's Committee on Radionuclides and Radiopharmaceuticals is seeking to familiarize users of radioactive materials with SI units and to facilitate their use in the United States. The SI unit for radioactivity is the becquerel (Bq), and is defined as one nuclear transformation per second. It is a small unit when compared to the curie (Ci), and it is convenient to use multiples of the unit (see listing later in this brochure). It does have the convenience however of relating directly to count rate once corrections have been made for counting efficiency.

Most suppliers of radioactive materials including the National Institute of Standards Technology (NIST-formerly NBS) have been using dual units (curies and becquerels) in catalogs, product literature and labelling for some time and plan to do so for the foreseeable future. The European Economic Community (EEC) has stated that it will accept only SI units for radioactivity after 1999, and it is anticipated that all suppliers of radioactive products will be using only SI units at that time. In Canada, Atomic Energy Control Board documents produced since 1985 have been in SI units only, and conversion of regulations is in progress.

Other SI radiation measurement units are as follows:

Exposure and Exposure Rate

The roentgen (R) is the traditional unit of measurement for exposure, the charge produced in air by gamma or x-rays. The SI unit of exposure is coulombs per kilogram (C/kg) of air.

$$1 \text{ C/kg} = 3876 \text{ R}$$

$$1 \text{ R} = 2.58\text{E-}4 \text{ C/kg}$$

No special name has been given to this SI unit (C/kg) and since there is no convenient conversion to other SI units, it is seldom used. Instead, the observed dose rate in air, that is the air kerma rate, is typically being used as the SI measurement to replace exposure rate. An example of the use of air kerma rate is to define the radiation output from a sealed radioactive source in SI units. The SI units usually used to express air kerma rate are grays/second. In traditional units, exposure rate from a sealed source has typically been expressed in roentgens/hour at a distance of 1 meter from the source.

Charge as defined in exposure (charge produced in air by gamma and X-radiation) does not include ionization produced by bremsstrahlung arising from absorption of electrons (beta particles). Apart from this difference, which is significant only with high energy beta particles, exposure is the ionization equivalent of air kerma. For a further discussion of air kerma see ICRU (International Commission on Radiation Units and Measurements) Report 33, 1980.

Absorbed Dose

This is the amount of energy imparted to matter, and the rad has been the unit of measurement. The SI unit for absorbed dose is the gray (Gy).

$$1 \text{ Gray (Gy)} = 100 \text{ rad}$$

$$1 \text{ rad} = 0.01 \text{ Gy}$$

One roentgen of X-radiation in the energy range of 0.1-3 MeV produces 0.96 rad in tissue.

Dose Equivalent

The dose equivalent is the absorbed dose multiplied by modifying factors such as a quality factor (accounts for the biological effect of different types of radiation) and the dose distribution factor. The rem is the unit of measurement that has been used, and the SI unit is the sievert (Sv).

$$1 \text{ Sv} = 100 \text{ rem}$$

$$1 \text{ rem} = 0.01 \text{ Sv}$$

We are giving advance notice of the change to SI Units to allow users time to become familiar with the new units. Do not hesitate to contact your supplier of radioactive

materials or USCEA should you have any questions concerning SI units or the implementation of the change.

CONVERSION TABLE FOR RADIOACTIVITY

Curie Units	Becquerel Units
uCi	kBq
mCi	MBq
Ci	GBq
0.1	3.7
0.25	9.25
0.5	18.5
0.75	27.75
1	37
2	74
3	111
5	185
7	259
10	370
20	740
25	925

Curie Units	Becquerel Units
uCi	MBq
mCi	GBq
Ci	TBq
50	1.85
60	2.22
100	3.7
200	7.4
250	9.25
500	18.5
800	29.6
1000	37

To convert from one unit to another, read across from one column to the other ensuring the units are in the same line of the column headings. For example:

From the first table:
 $0.1 \text{ mCi} = 3.7 \text{ MBq}$
 $0.1 \text{ Ci} = 3.7 \text{ GBq}$

From the second table:
 $50 \text{ mCi} = 1.85 \text{ GBq}$
 $3.7 \text{ MBq} = 100 \text{ uCi}$

SI Units

1 becquerel (Bq) = 1 disintegration/second

1 becquerel = 2.7027E-11 curie or about 27 picocuries (pCi)

To convert becquerels to curies, divide the becquerel figure by 37E9 (alternatively multiply the becquerel figure by 2.7027E-11)

1 curie (Ci) = 3.7E10 disintegrations/second or 37 gigabecquerels (GBq)

To convert curies to becquerels, multiply the curie figure by 37E9

Curie units that are frequently used:

1 Curie (Ci) = 1000 mCi

1 millicurie (mCi) = 1000 uCi

1 microcurie (uCi) = 1000 nCi

1 nanocurie (nCi) = 1000 pCi (picocuries)

Becquerel units that are frequently used:

1 kilobecquerel (kBq) = 1000 Becquerels (Bq)

1 megabecquerel (MBq) = 1000 kBq

1 gigabecquerel (GBq) = 1000 MBq

1 terabecquerel (TBq) = 1000 GBq

1 Ci = 37 GBq

1 mCi = 37 MBq

1 uCi = 37 kBq

1 nCi = 37 Bq

11/14/91

7.8 GLOSSARY OF TERMS

ABSORBED DOSE:

The energy imparted by ionizing radiation per unit mass of irradiated material.

ABSORPTION:

The process by which radiation imparts some or all of its energy to any material through which it passes.

ACTIVITY:

The rate of decay (disintegrations/time) of a given amount of radioactive material.

ALARA:

An acronym for As Low As Reasonably Achievable. The principal that radiation doses should be kept as low as reasonably achievable taking into account economic and social factors.

ALPHA PARTICLE (a):

A strongly ionizing particle emitted from the nucleus during radioactive decay which is equivalent to a helium nucleus (2 protons and 2 neutrons).

ANNIHILATION RADIATION:

The two 511 keV photons produced when a positron combines with an electron resulting in the annihilation of the two particles.

ANNUAL LIMIT ON INTAKE (ALI):

The derived limit for the amount of radioactive material taken into the body of an adult worker by inhalation or ingestion in a year. ALI is the smaller value of intake of a given radionuclide in a year by the reference man that would result in a CEDE of 5 rem or a CDE of 50 rem to any individual organ or tissue.

ATOMIC MASS UNIT (amu):

One-twelfth the mass of a neutral atom of C-12. (1 amu = 1.66E-24 g)

ATOMIC NUMBER (Z):

The number of protons in the nucleus of an atom.

ATTENUATION:

Process by which a beam of radiation is reduced in intensity when passing through material -- a combination of absorption and scattering processes.

AUTORADIOGRAPH:

Record of radiation from radioactive material in an object, made by placing the object in close proximity to a photographic emulsion.

BACKGROUND RADIATION:

Ionizing radiation arising from sources other than the one directly under consideration. Background radiation due to cosmic rays and the natural radioactivity of materials in the earth and building materials is always present.

BECQUEREL (Bq):

The SI unit of activity equal to one disintegration per second. (1 Bq = 2.7E-11 Ci).

BETA PARTICLE (B):

A charged particle emitted from the nucleus of an atom, having a mass equal to that of the electron, and a single positive or negative charge.

BIOLOGICAL HALF-LIFE:

The time required for the body to eliminate by biological processes one-half of the amount of a substance which has entered it.

BREMSSTRAHLUNG:

X-rays produced by the deceleration of charged particles passing through matter.

CARRIER FREE:

An adjective applied to one or more radionuclides of an element in minute quantity, essentially undiluted with stable isotope carrier.

COMMITTED DOSE EQUIVALENT (CDE):

The dose equivalent to organs or tissues of reference that will be received from an intake of radioactive material by an individual during the fifty-year period following the intake.

COMMITTED EFFECTIVE DOSE EQUIVALENT (CEDE):

The sum of the products of the weighting factors applicable to each of the body organs or tissues that are irradiated and the CDE to these organs or tissues.

COMPTON SCATTERING:

The elastic scattering of a photon by an essentially free electron.

CONTAMINATION:

The deposition of radioactive material in any place where it is not desired, particularly in any place where its presence may be harmful.

COUNT:

The external indication of a device designed to enumerate ionizing events.

CURIE (Ci):

The unit of activity equal to 3.7×10^{10} disintegrations per second.

DEEP-DOSE EQUIVALENT (DDE):

The dose equivalent at a tissue depth of 1 cm from external radiation.

DOSE:

A general term denoting the quantity of radiation or energy absorbed in a specified mass.

DOSE EQUIVALENT:

The product of the absorbed dose in tissue, quality factor, and all other necessary modifying factors at the location of interest.

EFFECTIVE HALF-LIFE:

Time required for a radioactive nuclide in the body to be diminished fifty percent as a result of the combined action of radioactive decay and biological elimination.

EFFICIENCY:

The ratio of the count rate given by a radiation detection instrument and the actual disintegration rate of the material being counted.

ELECTRON CAPTURE:

A mode of radioactive decay involving the capture of an orbital electron by its nucleus resulting in conversion of a proton to a neutron.

ELECTRON VOLT (eV):

A unit of energy equal to the amount of energy gained by an electron passing through a potential difference of 1 volt.

ERYTHEMA:

An abnormal reddening of the skin due to distention of the capillaries with blood.

EXPOSURE:

A measure of the ionizations produced in air by x-ray or gamma radiation. Sometimes used to mean dose.

EYE DOSE EQUIVALENT:

The dose equivalent at a tissue depth of 0.3 cm from external radiation at the eye.

FILM BADGE:

A packet of photographic film in a holder used for the approximate measurement of radiation dose.

GAMMA:

Electromagnetic radiation (photon) of nuclear origin.

GEIGER-MUELLER (G-M) COUNTER:

A radiation detection and measurement instrument.

GRAY (Gy):

The SI unit of absorbed dose equal to 1 Joule/kilogram.

HALF VALUE LAYER:

The thickness of any specified material necessary to reduce the intensity of an x-ray or gamma ray beam to one-half its original value.

HEALTH PHYSICS:

The science concerned with the recognition, evaluation, and control of health hazards from ionizing radiation.

ION:

Atomic particle, atom, or chemical radical bearing an electrical charge, either negative or positive.

IONIZATION:

The process by which a neutral atom or molecule acquires either a positive or a negative charge.

IONIZATION CHAMBER:

A radiation detection and measurement instrument.

IONIZING RADIATION:

Any electromagnetic or particulate radiation capable of producing ions, directly or indirectly, by interaction with matter.

ISOTOPES:

Nuclides having the same number of protons in the nuclei, and hence having the same atomic number, but differing in the number of neutrons, and therefore in mass number. Almost identical chemical properties exist among isotopes of a particular element.

LABELLED COMPOUND:

A compound consisting, in part, of radioactive nuclides for the purpose of following the compound or its fragments through physical, chemical, or biological processes.

LINEAR ENERGY TRANSFER (LET):

Average amount of energy lost per unit track length by the individual particles or photons in radiation passing through an absorbing medium.

MASS NUMBER (A):

The number of protons and neutrons in the nucleus of an atom.

NUCLIDE:

An atom characterized by its mass number, atomic number, and energy state of its nucleus.

POSITRON:

A particle having a mass equal to that of an electron and a charge equal to that of an electron, but positive.

QUALITY FACTOR (Q):

The LET-dependant modifying factor that is used to derive dose equivalent from absorbed dose.

RAD:

The unit of absorbed dose equal to 100 erg/gram (or 0.01 Joule/kilogram).

RADIATION:

Energy propagated through space or a material medium.

RADIOACTIVE DECAY:

Disintegration of the nucleus of an unstable nuclide by the spontaneous emission of charged particles, neutrons, and/or photons.

RADIOACTIVE HALF-LIFE:

The time required for a radioactive substance to lose fifty percent of its activity by decay.

RADIOACTIVITY:

The property of certain nuclides of spontaneously disintegrating and emitting radiation.

RADIONUCLIDE:

An unstable (radioactive) nuclide.

RADIOTOXICITY:

The potential of a radioactive material to cause damage to living tissue by radiation after introduction into the body.

REM:

The unit of dose equivalent equal to the absorbed dose in rad multiplied by any necessary modifying factors.

ROENTGEN (R):

The unit of radiation exposure in air equal to 2.58×10^{-4} coulombs/kilogram.

SCINTILLATION COUNTER:

A radiation detection and measurement instrument in which light flashes produced in a scintillator by ionizing radiation are converted into electrical pulses by a photomultiplier tube.

SHALLOW-DOSE EQUIVALENT:

The dose equivalent at a tissue depth of 0.007 cm from external exposure of the skin or an extremity.

SIEVERT (Sv):

The SI unit of dose equivalent equal to 1 Joule/kilogram.

SPECIFIC ACTIVITY:

Total activity of a given radionuclide per unit mass or volume.

SYSTEME INTERNATIONALE (SI):

A system of units adopted by the 11th General Conference on Weights and Measurements in 1960 and used in most countries of the world.

THERMOLUMINESCENT DOSIMETER (TLD):

A dosimeter made of a crystalline material which is capable of both storing energy from absorption of ionizing radiation and releasing this energy in the form of visible light when heated. The amount of light released can be used as a measure of absorbed dose.

TOTAL EFFECTIVE DOSE EQUIVALENT (TEDE):

The sum of the deep-dose equivalent (for external exposures) and the committed effective dose equivalent (for internal exposures). $TEDE = DDE + CEDE$

TOTAL ORGAN DOSE EQUIVALENT (TODE):

The sum of the DDE and the CDE to an organ or tissue.

WEIGHTING FACTOR:

The proportion of the risk of stochastic effects for an organ or tissue when the whole body is irradiated uniformly.

X-RAY:

Electromagnetic radiation (photon) of non-nuclear origin having a wavelength shorter than that of visible light.

REFERENCES

Basic Radiation Biology. D. J. Pizzarello and R. L. Witcofski; Lea & Febiger, 1967.

Basic Radiation Protection Criteria. National Council on Radiation Protection and Measurements (NCRP) Report No. 39; NCRP, 1971.

The Dictionary of Health Physics & Nuclear Sciences Terms. R. J. Borders; RSA Publications, 1991.

The Effects on Populations of Exposure to Low Levels of Ionizing Radiation: 1980. Committee on the Biological Effects of Ionizing Radiations (BEIR); National Academy Press, 1980.

Health Effects of Exposure to Low Levels of Ionizing Radiation. Committee on the Biological Effects of Ionizing Radiations (BEIR); National Academy Press, 1990.

The Health Physics and Radiological Health Handbook, Revised Edition. B. Shleien; Scinta, 1992.

The Health Physics and Radiological Health Handbook. B. Shleien; Nucleon Lectern Associates, 1984.

Influence of Dose and its Distribution in Time on Dose-Response Relationships for Low-LET Radiations. NCRP Report No. 64; NCRP, 1980.

Introduction to Health Physics. H. Cember; Pergamon Press, 1969.

The Physics of Radiology. H. E. Johns, and J. R. Cunningham; Thomas, 1978.

Radiation Biophysics. H. Andrews; Prentice-Hall, 1961.

Radiation Protection Design Guidelines for 0.1 - 100 MeV Particle Accelerator Facilities. NCRP Report No. 51; NCRP, 1977.

Radiation Protection Training Manual. A. Zea; University of Southern Washington.

UW Safety Office / safety@UW.edu

7.9 Emergency Procedures for Radioisotope Users

Injuries Involving Radioactive Contamination

Personnel who use radioactive material are highly trained and are aware of the hazards associated with radiation. It should be clear that no procedures involving radioactive material, including decontamination, should interfere with life saving measures or critical medical treatment. Only after the victim has received medical attention should radioactive contamination control be the priority. In most cases medical and radiation concerns can be addressed concurrently. In the worst case, decontamination delayed until after medical treatment may be more complicated but is an acceptable trade-off for providing prompt medical attention.

1. Life saving actions shall be taken immediately.
2. Provide information concerning the spill or exposure to radioactive material to the medical team attending the victim.
3. Wear disposable gloves while attempting to determine the extent of the injury. Assess the medical condition of the victim and obtain medical treatment as necessary.
4. If radioactive contamination is involved, notify the medical facility receiving the patient and provide appropriate radiation expertise.

Reporting and Notifications

Notify the Radiation Safety Office (RSO) (206-543-0463) as soon as possible of any abnormal or questionable situation involving ionizing radiation, e.g., spills, injection or ingestion of radioisotopes into a person, contaminated wounds, contaminated person or personal effects, unauthorized release of radioactivity into the air or sewage system or to normally non-contaminated areas, and known or suspected overexposure of personnel to ionizing radiation in accordance with applicable regulations.

MAJOR SPILL:

A spill of greater than 100 Ci of any radionuclide, or involving the floor or contaminated personnel.

1. Immediately notify all persons in the area that you have just had a spill of radioactive material.
2. Prevent the spread of contamination if possible without exposing yourself, i.e.,
 - a. Use absorbent material for liquid spills
 - b. Close doors and windows and shut off air conditioning systems to prevent dispersion of dusts, fumes, or gases
 - c. Limit movement of personnel who may be contaminated or place bench paper on floor to create path away from spill without the risk of spreading contamination to other areas of the floor
3. Immediately survey all individuals who have been in the vicinity of spill location. Especially important is to survey soles of shoes worn by these individuals to assure that the spill has been contained. Also survey hands, lab coats, and other clothing.
4. Decontaminate personnel immediately if individuals are contaminated by following procedures for personnel decontamination outlined below.
5. Notify all persons not involved in the spill to vacate the room. Be sure to survey all individuals as they leave the room. Especially important is to survey soles of shoes worn by these individuals to assure that the spill has been contained within the room and is not spread outside the room. Also survey hands, lab coats, and other clothing.
6. Report the incident to the Radiation Safety Officer at 206-543-6328. If after hours or on a weekend contact the Radiation Safety Officer through UW Police Dispatcher by dialing 911 from campus phone or 206-685-8973 from off campus. This applies 24 hours a day, 7 days a week.
7. Shield the source if possible. This should be done only if it can be done without further spread of contamination or a significant increase in radiation exposure.
8. Prevent unauthorized entry by closing the door to the room and placing a "Caution: Contaminated Area" sign or warning tape across the entrance. If possible, an individual who is not contaminated should be stationed outside the door to prevent unauthorized entry .
9. Clean up the spill utilizing appropriate protective apparel (disposable gloves, eye protection, shoe covers, lab coat and respirator if necessary) and absorbent pads. Follow clean-up procedures outlined in Chapter VII, Spills and Decontamination. Note: The RSO must be notified of any person contaminated that requires decontamination efforts beyond the washing of hands. Many times a person who appears to be contaminated may simply have contamination

on their clothing. Protective clothing (laboratory coat, disposable gloves, closed toe shoes) is required when using unsealed radioactive materials.

PERSONNEL DECONTAMINATION:

Promptly decontaminate personnel by taking the steps listed below, using appropriate containers to collect contaminated wastes generated during the decontamination process.

1. Remove contaminated clothing and place in a plastic bag.
 2. Flush contaminated skin with lukewarm water.
 3. Wash contaminated skin with a mild soap.
 - a. Use of a small sponge or soft brush (e.g., complexion brush) may be helpful.
 - b. Avoid irritating the skin.
 - c. Repeat steps 2 and 3 as necessary.
 4. Monitor for contamination after each series of washing and rinsing to determine the effectiveness of the decontamination efforts.
 5. If fingernails or fingertips are contaminated, clip nails as short as possible, and repeat 2,3, & 4.
 6. If contamination persists, induce perspiration by covering the area with plastic (e.g. place a latex or vinyl glove over a contaminated hand, and tape opening at wrist). Then wash the affected area again to remove any contamination that was released by the perspiration.
 7. Terminate decontamination efforts when:
 - a. All radioactive contamination has been removed; or
 - b. The surveys following each of several successive decontamination steps indicate that contamination levels are no longer decreasing;
or
 - c. Erythema (reddening of the skin) has occurred.
- Notify the Radiation Office immediately at 543-0463. If after hours or on a weekend contact Police by dialing 9-911 from campus phone or 911 from off campus. This applies 24 hours a day, 7 days a week.
 - Document incident and submit copy to RSO

RELEASES OR LOSSES OF RADIOACTIVE MATERIAL:

In the event that radioactive materials are released to the environment or discovered missing, immediately notify the Radiation Safety Office at 543-6328. If after hours or

on a weekend, contact the Police Department by dialing 9-911 from campus or 911 from off campus. This applies 24 hours a day, 7 days a week.

SPILL RESPONSE KIT

One of the best preparations for a spill or contamination incident is to have a spill kit. *A spill kit is a portable container that is centrally located and can be transported to the scene of a spill.* It is important to locate the spill kit in an area where it can be accessed even during an emergency.

Spill kits need to be inventoried from time to time to ensure that they contain all necessary items and that the material is not out-dated or non-functional. Spill kits should not be used as a source of regular laboratory supplies. The use of the spill kit should be incorporated into regular drills or exercises.

The kit itself is normally in one or more suitcase-size containers. Other possibilities include using a large nylon blanket with sized pockets sewn over the area. The blanket may be rolled up and stored or even placed on a wall, available for use in an emergency. Plastic tamper seals can be placed on the spill kit with the date of the last inventory. The following identifies minimum inventory, which should be included in the spill kit. Additional items should be added as deemed necessary for individual laboratories.

Spill Response Kit Contents:

It is the responsibility of each permit holder to maintain essential decontamination supplies in his/her laboratory. The following supplies are recommended:

- absorbent pads (disposable)
- absorbent towels (disposable)
- mild soap (e.g. Joy or hand soap, suitable for skin decontamination)
- small soft brush (suitable for skin decontamination, e.g. complexion brush)
- small sponge (suitable for skin decontamination)
- gloves (disposable latex or vinyl, heavy duty Latex type gloves for heavy duty decontamination)
- shoe covers (disposable)
- heavy duty plastic bags for collecting used absorbent materials, etc.
- scouring pad
- decontaminating solutions (e.g. Radiac-Wash, Rad-Con, Count Off, etc.)
- disposable mop
- broom and dust pan
- tape ("Caution: Radioactive Materials" or "Caution: Contaminated Area")

- signs ("Caution: Contaminated Area")
- nail clippers (for removing contaminated fingernails)

7.10 Supplies and Equipment

The following supplies and equipment are recommended for laboratories where radioisotopes are used:

1. Fume hood with minimum flow rate of 100 linear feet per minute (lfm) (if volatile radioactive solutions are used).
2. Shielding, transparent, acrylic beta shields, acrylic boxes or lead bricks, when necessary.
3. Laboratory coats, disposable gloves, and protective eyeglasses.
4. Remote pipetting devices and aerosol resistant tips. Preferably, at least one set of pipetteors dedicated for radioisotope usage only.
5. Absorbent paper with impervious plastic backing for work areas.
6. Appropriate personnel monitoring badges and finger rings.
7. Appropriate signs and labels for doors, centrifuges, incubators, freezers, refrigerators, hoods, glassware, and other containers holding radioactive substances.
8. Lockable waste containers.
9. Plastic bags (i.e., not "Biohazard") are for radioactive waste disposal.
10. Lockable isotope storage boxes which can be properly secured to refrigerator or freezer.
11. Laboratory record book for maintaining inventories and surveys.
12. Copy of the UW Radiation Safety Manual.
13. Appropriate, calibrated survey meters and materials for conducting wipe tests.
14. Supplies for keeping the area clean and free of contamination.
15. Posted current NRC Form 3.
16. Clearly labeled spill kit in each room where radioisotopes are used.

7.11 Physical Security of Radioactive Materials

THE RULE: ALL RADIOACTIVE MATERIALS AT CDC MUST BE SECURED OR UNDER CONSTANT SURVEILLANCE AT ALL TIMES.

All shipments of radioactive materials received at Civil and Environmental Engineering Department must be secured or be under constant surveillance at all times. Shipments of radioactive materials, which have not been delivered, must be secured at the receiving site by personnel trained by EH&S until delivery can be made. Delivery personnel are prohibited from delivering a package with radioactive materials unless there is an Authorized person (Authorized User, Alternate Authorized User, or Radiation Worker) at the location who will accept it, sign for its receipt, and secure the radioactive materials. Shipments of radioactive materials must not be left unsecured in corridors. If it is necessary to deliver the package to an office, the authorized person receiving the shipment must immediately secure the package in a laboratory or storage room designated for work with radioactive materials. If the delivery person cannot find an authorized person to receive the shipment, the package must be returned to the receiving areas where it will be secured in a locked cabinet until delivery can be completed. Radioactive materials are not to be left unsecured at any time.

Any radioactive material in use in a laboratory must be attended at ALL TIMES, or secured by locking the laboratory when not attended. **Radioactive materials may not be left unsecured even momentarily.** Radioactive materials in storage, i.e. not being used, must be secured when the room in which it is stored is unoccupied. The required security may be accomplished by locking the room while unoccupied, or alternatively, by locking the radioactive materials within refrigerators, freezers, cabinets, or lock boxes. Wherever possible, lock boxes are recommended for storage of radioactive materials. Only authorized persons may have access to radioactive materials. Radioactive materials that are stored or used in areas common to both authorized and unauthorized personnel must be secured at all times from unauthorized personnel. **It is strongly recommended that all laboratories containing radioactive materials be locked when unoccupied during daytime hours and at night.**

Corridors (hallways, elevator lobbies, and utility chases, etc.) are not secured areas. Therefore, the use and storage of radioactive materials in these areas are prohibited.

All radioactive wastes are considered as radioactive materials. Radioactive wastes, including dry waste, liquid waste, medical pathological waste, and mixed waste, must

be secured at all times. Radioactive waste may be placed in lockable containers, which may be obtained from the Radiation Safety Office.

Unescorted unauthorized personnel may not enter into a laboratory if an authorized person is not present. Any persons admitted into the laboratory must be accompanied at all times by an authorized person who works in the area. Persons performing work in the area, such as engineering or maintenance personnel, contractors (i.e. janitorial staff, telephone, or computer support personnel) or commercial service representatives must also be accompanied by an authorized person at all times. Persons unknown to the occupants of an area where radioactive materials are used or stored should not be permitted into the area without proper identification and a legitimate reason for entry.

7.12 Personnel Monitoring

Dosimeters -- Personal monitoring devices (dosimeters) are required for workers who may receive 10 percent of the maximum dose of external radiation permissible under NRC's regulations (Table 1). To apply for a monitoring device, laboratorians must complete UW form 7, Request for Radiation Monitoring Badge, and return it to the Radiation Safety Office. The RSO will request the dosimetry records of new radiation workers from other institutions where they used radioactive materials. Old and new dosimetry records will be added to obtain cumulative records.

Table 1

Annual Maximum Permissible Dose Equivalent in mrem	
Whole body	5,000
Lens of the eye	15,000
Skin	50,000
Extremities (Hand, forearms, feet, ankles)	50,000
TLD's will be used for monitoring gamma and high-energy, beta-emitting radioisotopes, such as ³² P, ⁵¹ Cr, and ¹²⁵ I. The OHS may use radiation dosimeters to monitor levels of radiation in laboratories or other areas.	

An accurate record of an employee's radiation exposure history must be maintained by OHS. Employees must provide information regarding any prior occupational radiation exposure on UW form 7, Request for Radiation Monitoring Badge. If a worker is occupationally exposed to radiation elsewhere in addition to being exposed at CEE, the Authorized User should report this to the EH&S so that an accurate record of the worker's total radiation exposure can be maintained.

Employees must wear dosimeters recommended by the Radiation Safety Office while working in any restricted area (see Glossary). While not being worn, dosimeters should be stored away from all radiation sources in a desk drawer or in some other location where they will not be exposed to excessive heat, sunlight, or moisture (for example, never left in a car). They are not to be worn off UW premises. Individuals who do not work directly with radioisotopes or in a laboratory where radioisotopes are used may be issued dosimeters. **NOTE: Individuals who wear radiation badges should review their radiation dosimetry records to ascertain their radiation exposures in the radiation laboratory.**

Any dosimeter contaminated or exposed to heat, moisture, or medical x-rays should be returned to the Radiation Safety Office for replacement. After any accident or if an overexposure is suspected, the dosimeters should be returned immediately to the Radiation Safety Office to be read. Dosimeters should be worn on a shirt, coat pocket, lapel, or in some other position between the waist and the shoulders that will be representative of any radiation exposure. If, during a radiological process, a hand might receive a dose, a ring dosimeter should be worn on a finger of the hand under the glove. When both whole-body and hand doses can occur, two dosimeters will be issued, one for the whole body and one for a hand.

Authorized Users are responsible for distributing and collecting dosimeters for laboratory personnel under their authorization. Ring and whole-body dosimeters will be exchanged quarterly through the Radiation Safety Office. The Radiation Safety

Office will keep a record of any dose received and will send each worker a copy of his or her exposure record upon request.

Maximum Permissible Doses -- Federal limits for radiation doses are provided in Table 1; however, all doses must be maintained ALARA.

The maximum permissible dose for persons under 18 years of age is 10 percent of the doses shown in Table 1. At UW, employees under 18 years of age are not allowed to use radioactive materials. Exposure to pregnant women must be controlled so that the fetus will not receive more than 500 mrem during the entire gestation period. The Radiation Safety Office must be informed of any pregnant employees who may be exposed to radiation. The EH&S through RSO shall take any action deemed necessary to protect these employees without affecting their employment status.

Internal exposures must be prevented. Work procedures and equipment must be designed to prevent the release of any radioactive substance into room air. Processes that involve volatile or gaseous material or that generate particulates must be confined to an approved fume hood operating with a face velocity of at least 100 lfm or to an approved glove box. Airflow rates on all hoods should be monitored and calibrated at least annually. Uncalibrated hoods should be timely reported to the EH&S.

7.13 Laboratory Surveys

Active radiation laboratories where radioactive materials are used will be surveyed by Authorized Users or their designee at least once a month by using wipes or a suitable survey meter. A survey using an instrument such as a GM counter is acceptable as long as it is sensitive enough to detect the nuclides used. For low-energy beta emitters such as ^3H , ^{14}C , ^{35}S , or ^{33}P , contamination surveys should be conducted using wipes, which are counted using a LSC. For ^{125}I , a survey instrument equipped with a low-energy sodium iodide crystal is to be used or wipes may be counted on a gamma counter. Review the "Laboratory Surveillance Frequency" chart to determine how often you need to survey your laboratory and "Radiation Safety Due Dates Chart" for dates that Radioisotope Survey Reports are due to EH&S.

The results of laboratory surveys will be recorded on Radiation Survey Report.

A diagram of the laboratory should be made, showing benches, desks, sinks, and hoods; each area tested should be numbered. The wipes or counts from survey instruments should be numbered according to this diagram so that any area that becomes contaminated can be readily identified. Areas tested should be representative of where contamination might be expected (e.g., hoods, sinks, and counter tops), as well as some areas where contamination would not be expected.

In addition to routine surveys, laboratories or other potentially contaminated areas must be surveyed:

1. **After any spill, leak, fire, or other disturbance in a laboratory.**
2. **When work with radioactive materials is terminated.**
3. **Before and after laboratory construction modifications.**
4. **Before maintenance or removal of any equipment that may have come in contact with radioactive material or that contains radioactive material.**

Laboratories with sealed sources will be surveyed at least biannually. The following sealed sources will be surveyed by the laboratorians, with EH&S assistance, for leakage and external contamination at least once every 6 months. The sources will also be surveyed before and after they are moved within a laboratory or to another laboratory, after being dropped or otherwise damaged, and before and after maintenance:

1. Gamma cell 220 irradiator.
2. Gas Chromatographs containing a radioactive foil.
3. Any other equipment containing a permanent radioactive source, except Liquid Scintillation Counters.

NOTE: Maintenance, repair, cleaning, replacement, and disposal of GC foils contained in detector cells shall be performed "only" by the device manufacturer. Transfer of GC units or foils off site or on site must be coordinated through the Radiation Safety Section.

<i>Laboratory Surveillance Frequency</i>		
Survey Category	Activity Range	Survey Frequency
Very Low	<0.01 mCi	Once a month
Low	0.01 mCi to 1 mCi	Every 2 weeks (Or more frequently at the discretion of the Authorized User)
Medium	>1 mCi to 10 mCi	After each operation
High	> 10 mCi	After each operation
Modifying Factors		*Factors
Simple storage		X 0.01
Very simple wet operations (e.g., dilutions of stock solutions, RIA's done with kits)		X 0.1
Normal chemical operations (e.g., in vitro viral, bacterial, or cell labeling and simple analysis, such as by gel electrophoresis or		X 1

counting in gamma - or beta counters)	
Complex wet operations (e.g., radio labeling of nucleic acids, proteins, etc.: in vitro viral, bacterial, or cell labeling and complex analysis, such as zonal centrifugation or extractions)	X 10
Simple dry operations (e.g., manipulation of powders) and work with volatile radioactive compounds (e.g., I-125)	X 10
Exposure of nonoccupational persons	X 10

*The objective is to determine how often to survey the laboratory. To do this, multiply the number of millicurie of isotope actually used by the appropriate modifying factor to determine the applicable activity range for purposes of surveillance frequency.

EXAMPLE 1: A protein is to be labeled with 1.5 mCi I-125. The modifying factor of 10 multiplied by 1.5 mCi equals 15 mCi or the activity range > 10 mCi. The factor 10 comes from the procedure being classified as a complex wet operation or being classified as work with volatile radioactive compounds. Thus, the laboratory should be surveyed immediately after the labeling procedure.

ALSO NOTE: The laboratorian performing the procedure with I-125 must have a thyroid scan after the operation if the conditions so indicated (see Table 3).

EXAMPLE 2: An in vivo labeled virus preparation containing 500-uCi H-3 uridine to be purified by large-scale separation in a zonal or continuous flow rotor with a rotating seal assembly. This is classified as a complex wet operation. Multiply the number of millicurie actually used (0.5) by the modifying factor 10 gives an activity range of 5 mCi. This value falls within the 1 mCi to 10-mCi range requiring a survey be performed after each operation with the radioisotope.

Any instrument used for surveys must be calibrated for the specific radioisotope in question at least annually. Calibration curves and records of calibration will be available for all instruments used by radiation workers and EH&S. When necessary, the EH&S will supply survey instruments to Authorized Users for monitoring radiological procedures.

Action levels for decontamination are shown in Table 4.

Table 4

Actions Levels for Decontamination Beta and Gamma Emitters	
Smear Results	Action
100 dpm/100cm ²	No action required by RSO. Left to discretion of Authorized User.
100-350 dpm/100 cm ²	Area or surfaces should be cleaned as soon as possible by the Authorized User or laboratory personnel. Shoe covers and step-off pads shall be used if contamination is on floor.
350-2,000 dpm/100 cm ²	Contamination should be cleaned immediately under supervision of EH&S. Shoe covers and step-off pads are required for entry into area. Only essential personnel will have access.
2,000 dpm/100 cm ²	Airflow should be shut off. Entry of personnel into area should be prevented until a representative of EH&S arrives. Cleanup should begin immediately by Authorized user under supervision of RSO. Shoe covers and step-off pads are required.
Cm ² = square centimeters (100 cm ² = 4"x 4")	

Cleanup must be undertaken by Authorized Users or laboratory personnel, not by custodial workers.

Every four [4] months, the EH&S will perform surveys of laboratories that use radioactive materials as a quality control measure. The Authorized User designee is responsible for making laboratories or other areas accessible for surveys by the EH&S.

7.14 Classification of Radioactive Wastes

Radioactive waste is any waste that contains or is contaminated with radioactive material. This includes liquids, solids, animals, used scintillation counting liquids (LSC) etc. Consult with EH&S in the early planning stages of experiments to develop waste minimization strategies and discuss waste disposal procedures.

Radioactive waste must never be placed in any non-radioactive waste container. The RSO is the only office that can approve any disposal of radioactive via the sink. No general (non-radioactive) waste may be disposed of in radioactive waste containers. Radioactive waste must never be placed in the corridor or any public areas.

All radioactive waste must be labeled with the appropriate label (Radioactive Waste Label) stating the radioisotope name, activity, date of disposal, and the Radiation

Worker's full name and telephone number. All individual plastic containers, scintillation vials, bags and bottles of radioactive waste must be tagged with this label. Any information regarding other chemicals included in the radioactive waste must also be included on the form (e.g., strong acid). A Radioactive Waste Disposal Log should be used to compile a list of the radioisotopes disposed of in the waste cans. All of this information is necessary to correctly classify the waste for disposal (radiological, chemical, mixed, etc.).

All radioactive waste containers must be locked and secured. Consult with EH&S to obtain appropriate lockable waste and waste storage containers.

Radioactive waste pickup must be scheduled by calling EH&S or sending an e-mail requesting the service. The following information is needed to schedule a pickup:

1. Name of Radiation Worker and phone number.
2. Location of waste (building and room number).
3. Type of waste (liquid, solid, carcasses, LSC vials, etc.).
4. Radionuclide(s) in waste.
5. Any special handling instructions.

The EH&S will assist Authorized Users in obtaining an appropriate radioactive waste container for each isotope used in the laboratory. Each waste container will be used for disposal of **ONE** radioisotope **ONLY**, except for dual labeled radioisotope experiments. Disposal procedures for these containers will be based on the longest half-life. The radioactive waste cans should be stored in an area within the laboratory where they will not be knocked over, used for other waste, or accidentally mistaken as cans for non-radioactive waste. Authorized Users and Radiation Workers are responsible for securing waste until the EH&S removes it.

Multi-hazard Waste --This is waste that contains any combination of radioactive, biohazardous, and chemically-hazardous materials known as mixed waste. **Avoid creating such materials, if possible!** Disposal of multi-hazard-waste is extremely costly and difficult.

Solid Waste -- This includes test tubes, beakers, absorbent paper, gloves, pipettes, and other dry items contaminated with radioactive material but not containing liquid radioactive waste. This material must be placed in plastic bags, sealed with tape. Hypodermic needles, capillary pipettes, and other sharp objects must be placed in puncture-proof containers before being put into the large waste cans. These puncture proof containers can be obtained from UW EH&S Department.

Containers bearing a radioactive label, but no longer containing radioactive material must be disposed of as ordinary waste only after the radioactive label is defaced or removed and after being decontaminated.

Before any radioactive material contaminated with a microbiological organism (virus, fungus, or bacteria) is disposed of, it must be chemically treated in a manner that destroys all living organisms (e.g., with fresh 10 percent bleach solution). Autoclaving or Gamma cell irradiation should be used only when necessary. Care should be taken to protect autoclaves from any radioactive contamination, particularly, tritium, and radioiodines.

Before animal experiments with radioisotopes can begin, animal protocols must be approved by the Animal Use Committee and EH&S must be consulted so that proper arrangements can be made for disposal of radiologically contaminated or infectious carcasses. Animals that contain less than 0.05 microcurie of ³H or ¹⁴C per gram can be disposed of as biological waste. At concentrations higher than this or for other radioisotopes, the animal or tissues must be disposed of as radioactive waste.

Organic Liquid Waste -- Scintillation vials that contain less than 0.05 microcurie of ³H or ¹⁴C per gram of scintillation medium should be disposed of as chemical waste and not as radioactive waste. All scintillation vials containing radioactivity above these levels must be labeled as radioactive waste. Scintillation fluid and radioactive waste must be left in the original vials for disposal. These vials should be placed upright in shipping trays rather than in the large waste cans or plastic bags. Organic solvents that are insoluble, flammable, or toxic must be collected in inert, airtight plastic bottles and must never be disposed of in the sink. The RSO shall oversee the disposal of any aqueous liquid waste that will be picked up from radiation laboratories by Radiation Safety Staff or their representative.

Aqueous Liquid Waste -- No liquid radioactive waste shall be disposed of by the sewage system unless (1) the liquid is readily soluble or dispersible in water, and (2) the material is diluted to the concentrations shown in Table 5 or flushed simultaneously with measured amounts of water sufficient to achieve those concentrations (e.g., wash water from glassware that has been used for processing radioactive materials could be disposed of through the sewer).

Table 5*

Monthly Average Concentration for Releases to Sewer		
Isotope	Concentrations (microcuries/ml)	dpm/ml
³ H	1 x 10 ⁻²	22200
¹⁴ C	3 x 10 ⁻⁴	666
³² P	9 x 10 ⁻⁵	200
³⁵ S	1 x 10 ³	2200
⁵¹ Cr	5 x 10 ⁻³	11100
⁵⁷ Co	6 x 10 ⁻⁴	1332

^{125}I	2×10^{-5}	44
^{131}I	1×10^{-5}	22
*10 CFR 20, Appendix B, Table 3		

Only one sink in each laboratory may be used for disposing of liquid radioactive waste, and it must be appropriately labeled. Disposal of liquid radioactive wastes by sink must be approved by the RSO. After each disposal, the sink shall be flushed with a large amount of water. Authorized Users or Radiation Workers shall keep a record of quantities and isotopes disposed of in this manner and include such disposals on their inventory reports. Chemicals normally treated as hazardous waste cannot be disposed of in this manner. The sink must always be a point of survey when performing decontamination lab surveys.

Liquid radioactive waste must be stored in appropriate containers. RIA kits containing ^{125}I should be treated as radioactive waste and will be disposed of by the EH&S.

Section 8: Field Research Safety

8.1 Before You Leave

One of the most important phases of your fieldwork experience is planning and preparation before you leave. Here are some suggestions for a safe trip:

- Prepare a written plan of your trip, and leave this with a responsible party. Include the following:
 1. Your itinerary: Locations, arrival and departure dates, names, addresses and phone numbers of all fieldwork participants.
 2. Contact person: Name and phone number of a person to contact in case of emergency.
 3. Activities: General nature of activities being conducted.
 4. Local Contacts: Names of people at or near your fieldwork site who can reach you if necessary, as well as your check-in/check-out arrangements. Fieldworkers should check in with their group office regularly, and should advise the group office of any changes in schedule or points of contact. If possible, fieldworkers should also inform someone in their work locale (for example, local search and rescue personnel, police, sheriff, or motel employee) each day about the daily fieldwork location and the approximate time of return. After each day of work, the fieldworkers should notify the contact when they return. The local contact should provide with the telephone numbers of people to call (group office, University contact, etc.) if the workers do not return or report in within a predetermined interval of the scheduled return time.

- Learn about potentially hazardous plants, animals, terrain, and weather conditions in the areas where will be the fieldwork site. In addition to this booklet and the Office of Environmental Health and Safety (EH&S), your supervisor/sponsor, other fieldworkers, local residents, and authorities, such as state and national park services personnel, may be able to provide you with helpful information.

- Take a CPR/First Aid class. Contact EH&S to enroll.

- Assemble safety provisions and check everything before you leave; safety provisions may include:
 1. First Aid Kit and first aid manual. These should be taken on any trip.
 2. Medications you regularly take.

3. Allergy treatments (if you have allergies)

- Sunscreen and hat
- Water purification tablets or filter devices
- Personal protective equipment for fieldwork activities (safety glasses/goggles, gloves, hard hat, sturdy work boots, etc.). EH&S can recommend protective equipment depending on your activities.
- Vehicle emergency kit
- Flashlight
- Flares
- Two-way radio (if you will be working alone in an isolated or dangerous area)
- Ask your health insurance provider about how your coverage applies to medical treatment in the fieldwork locale, should that become necessary.

8.2 Medical Care and First Aid

Emergency Medical Care

The following guidelines apply to all off-campus operations including field stations, academic field trips, excursions, etc. that involve employees and students:

1. A first aid kit must be maintained at all times during the operation or exercise (see information below).
2. At least one employee who is trained in first aid must be present during operations.
3. At permanent University field stations, written arrangements must be made in advance with local facilities for emergency medical treatment. These must be reviewed by the Occupational Health Program. If you are working from a field station you should find out what the arrangements are for emergency care.
4. Civil and Environmental Engineering department has our own procedures for obtaining insurance coverage for emergency medical treatment. Field workers should know what these are before they leave.

If a University employee suffers a job-related injury or illness, their supervisor must be notified within 24 hours and must fill out an “Incident/Accident/Quality Improvement Report”, UoW form 1428.

First Aid Kits

First aid kits are required for all off-campus operations, department purchases and maintain first aid kits. Contact EH&S if special equipment or medication is needed. Kits and refills may be ordered from UW Store or from safety supply companies. EH&S can supply a list of vendors.

Concerned Parties

The following parties share concern for field safety:

1. Each individual in the field;
2. The person in the field responsible for leading a field team of two or more;
3. The person who has responsibility for supervising the academic study of an individual whose work in the field is a necessary part of such study;
4. The department (or equivalent institutional entity) that is the academic home of the research; and
5. The University.

Pests

A number of pests may be encountered in fieldwork. Follow these general guidelines to prevent close encounters of the painful kind:

- Keep garbage in rodent-proof containers and stored away from your campsite or work area. Food crumbs and debris may attract insects and animals.
- Thoroughly shake all clothing and bedding before use.
- Do not camp or sleep near obvious animal nests or burrows.
- Carefully look for pests before placing your hands, feet or body in areas where pests live or hide (e.g., wood piles, crevices, etc.).
- Avoid contact with sick or dead animals.
- Wear clothing made of tightly woven materials, and tuck pants into boots.
- Wear insect repellent.
- Minimize the amount of time you use lights after dark in your camp or work site, as they may attract pests and animals.
- Use netting to keep pests away from food and people.

- Carry a first aid manual and kit with you on any excursion so you can treat bites or stings. If the pest is poisonous or if the bite does not appear to heal properly seek medical attention immediately.
- Be aware of the appearance and habitat of pests likely to be found, such as those described in the following pages.

Black Widow Brown Recluse

Spiders — Black widow or brown recluse spiders may be found in shady protected rock piles, under logs or bark, in outdoor privies and in old buildings. Both spiders can inflict painful bites, which can cause local reaction, sweating, nausea, muscle cramps, fever and chills.

Scorpions — Scorpions normally hide during the day and emerge at night. They might be attracted to your camp or worksite to feed on other bugs drawn by light or food crumbs. Commonly found in lumber piles, firewood piled in dark corners and under the bark of old tree stumps, scorpions can inflict a painful (wasp-like) sting. In some species the bite can be deadly.

Bees, Wasps, etc. — Bees, wasps, hornets and yellow jackets may be attracted to scented materials or food (hornets and yellow jackets are especially attracted to meat). All can inflict stings that are seriously or fatally allergic to some people. This is the most frequent cause of serious medical problems among fieldworkers, after trauma (i.e., falls, vehicular accidents). If you know you are allergic, contact EH&S Department to discuss whether it is advisable to take medicine with you.

Conenose Bug — Conenose bugs (*Triatoma spp.*) may be found in areas animals inhabit, such as their nests. They breed in the dens of wood rats.

Conenose bugs thrive on blood, have a painful bite, and can cause a serious allergic reaction in some people. Rock climbers and those exploring rock shelters that harbor animal nests may be particularly prone to encounters with conenose bugs.

Fleas, Ticks—Fleas and ticks commonly inhabit animals and their nests and trails. Both are bloodsuckers, and their bites can spread diseases such as bubonic plague (flea) and Lyme Disease or Rocky Mountain Spotted Fever (tick). When outdoors, wear clothing of tightly woven materials, tuck pants into boots and stay on the widest part of paths and trails. When you select a campsite or work site, you can check for these insects by dragging a piece of cloth or a garment over grass and shrubs, and examining it for fleas and ticks. Bear in mind that both pests can detect you coming a long way off while fleas can jump onto you from a distance, ticks must wait until they are in direct contact with you to attach themselves.

Centipedes —Centipedes may be found under boards, in cracks and crevices, and moist locations, where they hide during the day and emerge at night to eat small insects. The

centipede's bite is more painful than serious.

Snakes—Several species of poisonous snakes are found in California. They generally stay under shady brush, particularly in hot areas. Snakes often bury their bodies, leaving the head above ground, positioning themselves along animal trails to prey on rodents. To avoid snakes, walk in open areas, wear heavy boots, and as you walk, use a stick to disturb the brush in front of you. If you are bitten, perform appropriate first aid and seek medical help immediately.

8.3 Other Environmental Hazards

In addition to pests, other fieldwork exposures can be hazardous. These include:

Poison Oak—This very common California “shrub” is characterized by a triple leaf pattern with prominent veins and shiny surfaces. The leaves are green in spring, yellow-green to pink or red in summer, red or russet brown in fall, and lose their leaves in winter. All parts of the plant contain a potent allergen that can cause a reaction anywhere from several hours to two weeks after exposure. The allergen is spread by:

- Contact with the plant itself
- Touching other objects which have touched a plant (tools, for example)
- Inhaling smoke from burning poison oak
- Touching other areas of the body after touching the plant

To prevent exposure, learn to recognize and avoid the plant and wear clothing such as long pants and long-sleeved shirts. If you come in contact with poison oak, wash clothes and skin with soap and water as soon as possible. Extremely sensitive people can be treated before exposure by “desensitization.” Contact OUP for information.

Impure Water—A variety of potentially harmful organisms and pathogens can live in “natural” water sources such as streams, lakes, and rivers. Drinking impure water can cause more than just gastrointestinal problems. Waterborne toxins can also cause hepatitis, giardia, and certain viral diseases. If you are not going to be near a municipal or treated water source, carry your own water. Never drink straight from a “natural” source. If you must use these sources, treat the water first by using water purification tablets, boiling it for three minutes, or using a special purification filter (available from sporting goods stores).

Exposure to the Elements -- Sunburn is a common and easily preventable hazard. Chronic exposure to the sun can increase one’s risk of skin cancer. People differ in their susceptibility to sun due to their skin pigmentation (redheads and blondes are more susceptible to skin cancer than are brunettes). Certain drugs, such as sulfonamides, oral antibiotics, certain diuretics, most tetracyclines, barbiturates, and biothionol (an ingredient in soaps and many first aid creams) can also increase susceptibility to the sun. To prevent sunburn, cover exposed skin and liberally apply sunblock creams.

These creams come with skin protection factor (SPF) ratings from 5-50. Generally SPF 15 is adequate; there is little added protection from higher ratings. Wearing a long-sleeved shirt and hat will also provide protection from the sun.

Heat exhaustion, which can even affect individuals in excellent physical condition, is caused by prolonged physical exertion in a hot environment (such as strenuous hiking in the desert during the summer).

Heat exhaustion symptoms include fatigue, excessive thirst, heavy sweating, and cool and clammy skin, and are similar to shock symptoms. If these symptoms are present, cool the victim, treat for shock, and give water or electrolyte replacement slowly but steadily if the victim can drink. If heat exhaustion is not treated, the victim can suffer *heat stroke*. Heat stroke is far more serious than heat exhaustion. The blood vessels in the skin can become so dilated that the blood supply to the brain and other vital organs is reduced to inadequate levels, causing the individual to become exhausted and faint; the skin becomes bright red and very warm to touch. This is a potentially fatal condition that requires immediate attention. Cool the victim at once, in any way possible, replenishes fluids as with heat exhaustion, and seek medical attention immediately. Failure to gradually acclimate to heat, or even minor degrees of dehydration or salt deficiency make an individual more susceptible to heat exhaustion. To prevent heat exhaustion, drink plenty of liquids (electrolyte replacers such as Gatorade® are excellent), and take frequent rest breaks. Salt tablets are *not* recommended for preventing dehydration.

Excessive cold -- On any trip, even a one-day excursion, where sudden changes in weather can occur, adequate clothing must be worn or carried. Prolonged exposure to excessive cold can lead to hypothermia, a lowering of the body temperature. Symptoms include shivering, numbness, slurred speech and excessive fatigue. Long pants, a long-sleeved shirt or sweater, a windbreaker or down jacket, and a cap are the minimal essentials. In cold or icy weather, it is best to wear clothing made of material that will wick moisture away from the body (e.g., wool or polypropylene instead of cotton). Wear several layers of clothing to allow adjustment to differing levels of physical activity. Avoid getting damp from perspiration.

8.4 Requirements for Reasonable Care

The following are areas in which those involved must exercise reasonable care to secure safety in field research:

1. Assurance of a satisfactory state of health and of immunization of the participants for purposes of travel to and participation in field research at the particular location;
2. Availability of first-aid supplies and expertise, as appropriate;
3. Availability of appropriate personal clothing, personal equipment and field equipment to support the research;

4. Arrangements for appropriate transportation to, at and returning from the location of the field research;
5. Availability of appropriate food and accommodation on site and during travel to and from the site;
6. Provision of information about requirements of foreign governments and other jurisdictions concerning travel to and research at the site;
7. Provision of information prior to departure to the study area on the character (to the extent known) of distinctive local risks and dangers;
8. Provision of information prior to departure about insurance needs, availability and limitations;
9. Arrangements for continuous responsible leadership of all field teams;
10. Definition prior to departure, and on a continuing basis on the site, of the tasks and responsibilities assigned to each participant;
11. Recognition of the right and responsibility of an individual to exercise personal judgment in acting to avoid harm in situations of apparent danger;
12. Availability of procedures for contacting the University to obtain assistance in a crisis situation.

8.5 Responsibilities and Procedures

1. The responsibility of the individual field researcher or research team member is to acknowledge the risks of the particular field project and to understand the Requirements for Reasonable Care, and to confirm these matters in writing to the departmental chair or equivalent.
2. The academic supervisor is responsible for the following:
 - Approving the composition of the field team including any dependents of team members, unless a dependent of the academic supervisor is to be included in the team in which case the composition of the team shall be approved by the departmental chair or other academic administrator to whom the supervisor reports;
 - Establishing a clear chain of responsible leadership that is understood by all participants, in place at all times and placed on record in writing with the departmental chair or equivalent;
 - Alerting each individual field researcher or research team member to the Requirements for Reasonable Care and of the risks of the particular field project;
 - Obtaining the written confirmation required in section 4.1, above.
3. The departmental responsibility is to disseminate University policy on field research safety and to require its diligent application.
4. The responsibility of the central administration on a continuing basis is to inform concerned parties about this policy and the procedures by which it will be implemented.

Resources

ON CAMPUS

Field Research and Consultation Group, Environmental Health
(206) 543-9711

Occupational Health and Safety Office
(206) 543- 6991

OFF CAMPUS

Contact with the two offices of UW, or Washington Department of Health Services

Infectious Disease and Reproductive Health Assessment
(360) 236-3412

Immunization
(360) 236-3595

Phone numbers county health departments can be found in local yellow page directories.

8.6 Safe Boating Policy

Equipment Requirements - PFD

The Coast Guard sets minimum safety standards for recreational boats and associated safety equipment. To meet these standards some of the equipment must be Coast Guard approved. "Coast Guard Approved Equipment" meets Coast Guard specifications and regulations relating to performance, construction or materials.

Personal Flotation Devices

All recreational boats must carry one wearable PFD (Type I, II, III or V PFD) for each person aboard. A Type V PFD provides performance of either a Type I, II, or III PFD (as marked on its label) and must be used according to the label requirements. Any boat 16ft and longer (except canoes and kayaks) must also carry one throwable PFD (Type IV PFD).

PFDs must be

- Coast Guard approved,
- In good and serviceable condition, and
- The appropriate size for the intended user.

Accessibility

- Wearable PFDs must be readily accessible.

- You must be able to put them on in a reasonable amount of time in an emergency (vessel sinking, on fire, etc.).
- They should not be stowed in plastic bags, in locked or closed compartments or have other gear stowed on top of them.
- The best PFD is the one you will wear.
- Though not required, a PFD should be worn at all times when the vessel is underway. A wearable PFD may save your life, but only if you wear it.
- Throwable devices must be immediately available for use.

Inflatable PFDs

- Inflatable PFDs may be more comfortable to wear.
- The best PFD is the one you will wear.
- Inflatable PFDs require the user to pay careful attention to the condition of the device.
- Inflatable PFDs must have a full cylinder and all status indicators on the inflator must be green, or the device is NOT serviceable, and does NOT satisfy the requirement to carry PFDs.
- Coast Guard Approved Inflatable PFDs are authorized only on recreational boats by a person at least 16 years of age.

Child PFD requirements

Some states require that children wear PFDs

- Applies to children of specific ages
- Applies to certain sizes of boats
- Applies to specific boating operations

Check with your state boating safety officials.

Child PFD approvals are based on the child's weight. Check the "User Weight" on the label, or the approval statement that will read something like "Approved for use on recreational boats and uninspected commercial vessels not carrying passengers for hire, by persons weighing ___ lbs". They can be marked "less than 30", "30 to 50", "less than 50", or "50 to 90".

PFD requirements for certain boating activities under state laws

The Coast Guard recommends and many states require wearing PFDs:

- For water skiing and other towed activities (use a PFD marked for water skiing).
- While operating personal watercraft (PWC) (use a PFD marked for water skiing or PWC use).
- During white water boating activities.
- While sail boarding (under Federal law, sailboards are not "boats").

Check with your state boating safety officials.

Federal law does not require PFDs on racing shells, rowing sculls and racing kayaks. State laws vary. Check with your state boating safety officials.

If you are boating in an area under the jurisdiction of the Army Corps of Engineers, or a federal, state, or local park authority, other rules may apply.

Remember, PFDs will keep you from sinking, but not necessarily from drowning

- Select a properly sized PFD to insure a safe and proper fit.
- Test your PFD by wearing it in shallow water or guarded swimming pool to see how it will float you.

Coast Guard Auxiliary U.S. Power Squadrons Vessel Safety Check (VSC) Requirements for PFDs

- All boats must be equipped with a wearable PFD for each person on board.
- Boats 16 feet and over are required to have a minimum of two PFDs on board, one wearable PFD (Type I, II, III, or V) and one throwable (Type IV). In addition, a wearable PFD is required for each person on board.

PFD Flotation

There are three basic kinds of PFD flotation in the five *types* of PFDs with the following characteristics:

Inherently Buoyant (primarily Foam)

- The *most* reliable
- Adult, Youth, Child, and Infant sizes
- For swimmers & non-swimmers
- Wearable & throwable styles
- Some designed for water sports

Minimum Buoyancy		
Wearable Size	Type	Inherent Buoyancy (Foam)
Adult	I	22 lb.
	II & III	15.5 lb.
	V	15.5 to 22 lb.
Youth	II & III	11 lb.
	V	11 to 15.5 lb.

Child and Infant	II	7 lb.
------------------	----	-------

Throwable:

Cushion	IV	20 lb.
Ring Buoy		16.5 & 32 lb.

Inflatable

- The most compact
- Sizes only for adults
- Only recommended for swimmers
- Wearable styles only
- Some with the best in-water performance

Minimum Buoyancy

Wearable Size	Type	Inherent Buoyancy
Adult	I & II	34 lb.
	III	22.5 lb.
	V	22.5 to 34 lb.

Hybrid (Foam & Inflation)

- Reliable
- Adult, Youth, and Child sizes
- For swimmers & non-swimmers
- Wearable styles only
- Some designed for water sports

Hybrid (Foam & Inflation)

Wearable Size	Type	Inherent Buoyancy	Inflated Total Buoyancy
Adult	II & III	10 lb.	22 lb.
	V	7.5 lb.	22 lb.
Youth	II & III	9 lb.	15 lb.
	V	7.5 lb.	15 lb.
Child	II	7 lb.	12 lb.

Types of PFDs

A TYPE I PFD, or OFF-SHORE LIFE JACKET provides the most buoyancy. It is effective for all waters, especially open, rough or remote waters where rescue may be delayed. It is designed to turn most unconscious wearers in the water to a face-up position.

A TYPE II PFD, or NEAR-SHORE BUOYANCY VEST is intended for calm, inland water or where there is a good chance of quick rescue. Inherent buoyant PFDs of this type will turn *some* unconscious wearers to a face-up position in the water, but the turning is not as pronounced as a Type I. This type of inflatable turns as well as a Type I foam PFD.

A TYPE III PFD, or FLOTATION AID is good for conscious users in calm, inland water, or where there is a good chance of quick rescue. It is designed so wearers can place themselves in a face-up position in the water. The wearer may have to tilt their head back to avoid turning facedown in the water. The Type III foam vest has the same minimum buoyancy as a Type II PFD. It comes in many styles, colors, and sizes and is generally the most comfortable type for continuous wear. Float coats, fishing vests, and vests designed with features suitable for various sports activities are examples of this type PFD. This type inflatable turns as well as a Type II foam PFD.

A TYPE IV PFD, or THROWABLE DEVICE is intended for calm, inland water with heavy boat traffic, where help is always present. It is designed to be thrown to a person in the water and grasped and held by the user until rescued -- It is *not* designed to be worn. Type IV devices include buoyant cushions, ring buoys, and horseshoe buoys. There are no inflatable Type IV devices.

A TYPE V PFD, or SPECIAL USE DEVICE is intended for specific activities and may be carried instead of another PFD only if used according to the approval condition(s) on its label. A Type V PFD provides performance of either a Type I, II, or III PFD (as marked on its label). If the label says the PFD is "approved only when worn" the PFD must be worn, except for persons in enclosed spaces and used in accordance with the approval label, to meet carriage requirements. Some Type V devices provide significant hypothermia protection. Varieties include deck suits, work vests, and board sailing vests.

8.7 Vehicle Safety Handbook and Policy

I. Introduction

The Civil and Environmental Engineering Department of University of Washington Motor Vehicle Safety Handbook and Policy is based on a loss prevention model which establishes the safety of drivers and passengers as a fundamental priority in the operation of UW Motor Vehicles. For policy purposes, the term "UW Motor Vehicle" includes all motor vehicles owned, leased, or rented by the university.

Experience tells us that motor vehicle accidents are preventable. Working to prevent and reduce the number of motor vehicle accidents helps to lower the incidence of personal injuries, lowers the aggregate cost of property damage, and works to reduce insurance costs while serving as an important part of the larger effort to foster a safe educational environment at the CEE department.

The safety and well being of the CEE's students, faculty, and staff are important goals for all elements of the department's programs. While it is the responsibility of all community members to participate in safe practices, it is particularly important that every student or member of CEE department's faculty and staff who accepts the responsibility to operate a UW Motor Vehicle should consider safety a fundamental part of the obligations, which obtain in that capacity.

Please read this CEE Motor Vehicle Safety Handbook carefully and take very seriously the responsibility you accept by becoming a driver of a UW Motor Vehicle.

This Handbook and Policy addresses not only the rules governing the operation of UW Motor Vehicles (part II) but, also, the circumstances under which CEE students may be approved to drive UW Motor Vehicles in support of academic, co-curricular, and formally organized extracurricular activities of the school (part III).

II. Rules Governing the Operation of University of Washington Motor Vehicles

A. Compliance with Traffic Laws

Operators of UW Motor Vehicles will comply with all motor vehicle regulations, laws, and ordinances at all times.

B. Alcohol and Drugs

The use of alcohol and/or drugs by the driver or passengers of UW Motor Vehicles is strictly prohibited, either while in possession of the vehicle or within 8 hours prior to such possession. Violation of this provision will be grounds for immediate termination of driving privileges under this policy.

C. Safety Belts

In compliance with state law, all drivers are required to use safety belts while operating a motor vehicle for the school. Similarly, all passengers, regardless of placement in the vehicle, must wear safety belts while the vehicle is in motion. It is the driver's responsibility to insure 100% compliance with this aspect of policy.

D. Authorized Passengers

Only those individuals affiliated with the CEE department, i.e., faculty, staff, students, or invited guests, are to be transported in UW Motor Vehicles. Personal use is strictly prohibited. It is the driver's responsibility to enforce this policy.

E. Accidents Involving University Vehicles

All collisions/accidents must be reported to the University Police within 24 hours. If an injury is involved, call the University Police immediately at (206) 543-9331. Collect calls will be accepted.

In addition, when a collision/accident involves personal injury, death, or damage to the property of any one owner to the apparent extent of \$700 or more, it must be reported to the city police, county sheriff, or Washington State Patrol within 24 hours.

In case of a collision/accident:

1. Stop immediately.
2. Take required precautions to prevent further collisions/accidents at the scene.
3. If an injury is involved, call 911 or the University Police immediately, (206) 543-9331. Collect calls will be accepted.
4. Two different forms are located in the glove compartment of each University vehicle. The forms should be filled out as follows:
 - **State of Washington Vehicle Accident Report, form SF-137 (1/79)** UW policy requires this form be used to report ALL collisions/accidents and/or damage to a University vehicle. Send the completed form to the University Police, box 355200.
 - **State of Washington Motor Vehicle Collision Report, form 3000-345-161 (2/97)** State law requires this form be filled out IN ADDITION TO the "State of Washington Vehicle Accident Report" IF the damage exceeds \$700 or there is a personal injury or death associated with the accident. Send the completed collision report to the agencies listed at the top of the form.
5. Notify the Rental Office of the collision/accident. Bring the vehicle to the Motor Pool Maintenance Shop for inspection, estimate of damage, and repair.

F. Driver Responsibility in UW Motor Vehicles

The ultimate responsibility for the safety and well being of all passengers belongs to the driver of the UW Motor Vehicle. No policy or procedural statements can eliminate that responsibility. All laws must be obeyed and good safety practices followed on an ongoing basis.

The areas listed below further define the driver's responsibilities.

1. Equipment

Any equipment discrepancies, failures, or vehicle damage should be reported to motorpool office, and for rented/leased vehicles, to the company owning the vehicle. Inspect the vehicle before using so that pre-existing problems are noted at the outset and, if possible, corrected before vehicle use. Vehicles thought to be unsafe should not be taken out on the road under any circumstances.

2. Luggage

All luggage and equipment shall be stored in a secure fashion so that it does not interfere with the safe operation of the vehicle or endanger the safety of the passengers.

3. Uncooperative Passengers

Passengers who do not, by their actions while being transported in a UW Motor Vehicle, support the safe driving goals of this policy should be reported by the driver to the departmental supervisor who approved the use of the UW Motor Vehicle for CEE department business.

4. Distractions

The driver's attention should always be on the safe operation of the vehicle. Distractions such as eating or drinking should be refrained from while the vehicle is in motion. Smoking is prohibited in most of the UW vehicles.

G. Unauthorized Use of UW Motor Vehicles

Only authorized and qualified drivers may drive UW Motor Vehicles. Drivers for whom vehicles have been signed out or rented are not authorized to delegate driving responsibilities to other drivers except in an emergency and, then, only where the delegated driver is a qualified driver for UW Motor Vehicles. Improper delegation of driving responsibility may lead to a suspension of driving privileges for the individual in question.

In the case of long term rentals of vehicles (typically in the intercollegiate athletics program) a faculty or staff member will be the driver of record and responsible for assuring that those who drive the vehicle are properly authorized to do so under this policy.

III. Approvals Required for CEE Students to Drive UW Motor Vehicles

Broadly speaking, CEE students will be authorized to drive UW Motor Vehicles only when absolutely necessary for the direct support of the department's academic, co-curricular, and formally organized extracurricular programs and when faculty or staff personnel are not available to serve in the capacity of driver.

Approval for CEE students to drive UW Motor Vehicles must be granted in writing by a designated member of the CEE faculty or staff. Authorization may be granted only on a date-specific basis; that is, no blanket authorizations may be granted covering extended or open-ended periods of time.

For more information, please visit
WWW.washington.edu/admin/motorpool/

8.8 Defensive Driving Techniques

Operators will periodically receive directives from the Motor Pool regarding defensive driving techniques. Handouts and information on defensive driving are available at the Motor Pool Rental Office.

A defensive driver is one who:

- Is careful to commit no driving errors.
- Makes allowances for the lack of skill and improper attitude of other drivers.
- Does not become involved in an accident or a close call because of weather, road conditions, traffic, or the actions of pedestrians and other drivers.
- Is continually alert for accident-producing situations far enough in advance to take defensive action.
- Concedes the right of way to prevent an accident.

Bicycles & Pedestrians

Responsible drivers....

- Allow room for bicyclists on the road, as they do for other cars and should take particular notice of crosswalks, trail crossings, and bike lanes.
- Look for cyclists when exiting a car parked on the street.
- Use caution when turning right at intersections.
- Yield to bicycles in a right-hand bike lane before turning.
- Not pass cyclists who change lane positions due to safety considerations or route.
- Watch for pedestrians at intersections.

Check out the U-Pass Program for more tips on driving with bicycles and safely maneuvering near pedestrians.

Seasonal Driving Recommendations

Before you start....

- Check the weather forecast and postpone your trip if necessary.
 - The Motor Pool does not charge for vehicle cancellations.
- Make sure your car is well maintained:
 - Wipers in good condition.
 - Fluid levels full.
 - Tires properly inflated and worn tires replaced.
- Do not drive when you are tired.

Summer Driving

According to the National Safety Council, more motor vehicle injuries and fatalities occur during summer than any other season. Leading causes include:

- High speeds
- Impaired or careless driving
- Not using safety belts

In 1998 an estimated 42,500 people died and 2.3 million were injured in motor vehicle crashes. Fatal crashes reached their highest level in August with 4,140 deaths.

The National Safety Council offers the following tips to keep summer trips safe and fun. This information is also available from the Motor Pool Rental Office.

1. Drive at the speed limit. Speeding is a factor in about a third of all vehicle crash fatalities.
2. Prepare your vehicle for the road. Clean headlights, taillights, signal lights, and windows once a week, if not more.
3. If your vehicle breaks down on the highway, pull off the road as far as possible. Warn approaching traffic at once by setting flares or reflecting triangles near your vehicle and 100 feet behind it. Stay off the roadway and get passengers away from the vehicle.
4. **DON'T DRINK AND DRIVE.** Almost half of all fatal vehicle crashes involve alcohol. Open alcohol containers are illegal and not permitted in University vehicles.
5. For longer trips, allow enough travel time for frequent breaks for rest, snacks, and exercise. Drowsiness can reduce reaction time almost as much as drinking. If you're too tired to drive, stop and rest. Danger signs of fatigue include eye strain, blurred vision, head drooping, yawning, swaying out of the lane, or an urge to close your eyes.
6. Drive defensively. Be alert. If you notice that a car is straddling the center lines, weaving, making wide turns, stopping abruptly or responding slowly to traffic signals, the driver may be impaired. Avoid an impaired driver ahead by slowing down to increase the following distance. If the impaired driver is behind, turn right at the nearest corner. Notify the police after seeing a motorist who is driving suspiciously.
7. Follow the rules of the road. Don't contest the "right of way" or try to race another car while trying to merge onto another lane. Be respectful of other motorists.

Winter Driving

The Motor Pool provides some equipment to assist in winter driving. This equipment includes tire chains and ice scrapers. The Motor Pool installs "all-season" tires on its vehicles for additional safety.

In addition to equipment provided by the Motor Pool, the following operating recommendations should be followed:

- Reduce winter driving stress by leaving earlier and giving yourself more time.
- Reduce risk of skidding by looking ahead and slowing even more for turns and stops.
- Allow 3-5 times the normal braking distance to come to a full stop on snow or ice.
- A.B.S. brakes reduce tire skid when braking, but on ice, snow, gravel, soft surfaces, etc., braking distances can be longer than with conventional brakes.

- Listen to weather forecasts on radio and TV.

Rain Hazards

- Stay out of puddles. They can hide potholes and flood your brakes.
 - If your brakes get flooded, dry them by driving with the brake pedal down until they start working again.
- If spray from an oncoming vehicle blinds you, grip the wheel firmly, stay off the brake, and be ready to break when the view clears.

Slippery Roads (*wet or icy*)

- Stay below posted speed limits.
- To avoid hydroplaning on wet roads, try to drive in the tracks of the car in front of you.
- Avoid braking heavily.
- Watch for icy patches on bridges and in the shade.
- If you skid, take your foot off the gas and turn in the direction you want the car to go. Do not use the brake.

Poor Visibility

- Reduce your speed so you can stop in whatever distance you can see ahead.
 - Use your flashers if you are going slowly.
 - Pull over if it's dangerous to drive.
- Remember to use your wipers.
- Use low beams when visibility is a problem, both day and night.
- Wear sunglasses when there is glare from snow.

If snow or ice builds up on your windshield, stop and clean it off.

8.9 15-Passenger Vans safety

UW Fleet Services no longer offers 8, 12, or 15 passenger vans.

NHTSA Consumer Advisory

On April 9, 2001 the National Highway Traffic Safety Administration (NHTSA) issued a cautionary warning to users of 15-passenger vans due to the increased rollover risk under certain conditions. This cautionary advisory was reissued April 15, 2002.

Click on the following link to view this advisory

<http://www.nhtsa.gov/nhtsa/announce/press/PressDisplay.cfm?year=2001&filename=ca-010409.html>

The advisory highlights the following findings:

- The risk of rollover increases dramatically as the number of van occupants increases to over ten passengers.
- 15-passenger vans (with ten or more passengers) had a rollover rate three times the rate of vans that were loaded with less than ten passengers.
- Loading vans causes the center of gravity to shift, thus increasing the potential for loss of control in panic maneuvers.

This advisory is in response to these new findings as well as several highly publicized rollover accidents involving 15-passenger vans loaded with college students.

2001 Focus Group

In response to this consumer advisory, Motor Pool Operations conducted a focus group of 15-passenger van operators from different cross sections of the University community. The agenda for this meeting included the following topics:

- 15-passenger van rollover risk
- NHTSA advisory and report
- Federal Motor Carrier Safety Administration (FMCSA) press release
- What's next for Motor Pool Operations?
 - What are other schools doing?
 - Brainstorming
- What can we do?
 - Fleet composition
 - Training
 - Cost impact to programs
 - Others

The following recommendations and directives were a direct result of this meeting:

- Motor Pool Operations will continue to make 15-passenger vans available to rent.
- Motor Pool Operations will develop material to assist clients in compensating for 15-passenger van characteristics and highlight safety considerations.

Current Policies

At this time, 8-, 12-, and 15-passenger vans are no longer available from UW Fleet Services.

DRIVE SAFELY!

Van Characteristics

Although a van handles differently than an automobile, operators can learn to compensate for its characteristics and operate it smoothly and safely. Here are some tips to keep in mind when driving a van.

Making Turns-When turning a corner, make a wider swing with a van than one would with a car. Consequently, on a right turn it is necessary to watch the right outside mirrors for small vehicles, motorcycles, bicycles, and pedestrians. Make turns

more slowly than with a car. If a turn is made too quickly, the van will lean and passengers may become uncomfortable.

Whenever possible, do not make "U" turns. Due to the van's wider turning radius, a "U" turn may require at least one backward movement. *Avoid backward movements whenever possible.*

Following Distance-A Loaded van is more difficult to stop than an automobile traveling at the same speed. Therefore, operators should use a *three-second* following rule for vans as opposed to a *two-second* following rule for cars.

Height of the Van-The height of the van has advantages and disadvantages for the driver. On the positive side, it provides a better view of the road ahead. On the negative side, many garages are not high enough to accommodate the van. Operators must also watch out for overhead obstructions such as tree limbs

Motor Pool vans are approximately 7½ feet tall.

Vans can block the view of following passenger cars. Drivers may attempt to pass at an unsafe time or place and thus threaten to cause a collision. Watch both outside mirrors for these maneuvers.

Blind Spots-Vans have blind spots on each side. Adjust the mirrors to reduce these as much as possible.

The greatest blind spot is to the rear of the van when backing up.

70% of van accidents involve backing into a stationary object.

The best defense is to back up only when necessary and avoid backing into traffic. If backing is inevitable, get out and check the area behind the van before doing so. Turn on the four-way flashers and back slowly. Have passenger(s) assist when available but be sure they understand what is expected to them.

There is also a blind spot in front of the van, which may prevent operators from seeing children and others of short stature walking in front of the van. To avoid striking a pedestrian, stop back from a crosswalk. Watch out for any van passenger walking across the front of the van as they board or leave.

8.10 Confined Space Program

Please note that this program has a glossary. The glossary contains the definitions for various terms used in the program. These terms are highlighted in bold print the first time they appear in the body of the program.

Policy

All **confined spaces** located at the University of Seattle shall be identified, investigated, and access shall be denied until the location has been cleared for **entry** in accordance with this policy.

Authority and Responsibility

Environmental Health and Safety Department is responsible for the following:

11. Investigating all known and suspected confined spaces;
12. Completing a confined space profile (Appendix A) for all confined spaces;
13. Designating confined spaces as **permit-required confined spaces** or **non-permit confined spaces**;
14. Implementing the measures necessary to prevent unauthorized entry into a permit-required confined space by posting warning signs or other equally effective means;
15. Determining if a permit-required confined space can be reclassified as a non-permit confined space;
16. Developing, implementing and annually reviewing the corporate policy for permit-required confined spaces;
17. Initially reviewing and approving all departmental policies for specific permit-required confined spaces prior to implementation;
18. Providing **entry supervisors** for all confined space entry procedures;
19. Providing a means of training employees involved with permit-required confined space entry; and
20. Coordinating with the department supervisor and contractor's entry supervisor to ensure proper procedures are followed prior to entry, during entry operations, and after entry into permit-required confined space(s).

Departments with authority over a permit-required confined space(s) are responsible for the following:

5. Developing and implementing departmental policies specific to each identified confined space;
6. Providing **authorized entrants** and **attendants** to perform assigned tasks in permit-required confined spaces;
7. Ensuring that affected employees participate in training programs as prescribed by this policy; and
8. Providing necessary equipment to control permit-required confined space atmospheres at levels that will permit occupancy.

The *contractor* shall be responsible for the following:

4. Utilizing any available information from the University of Washington regarding the permit-required confined space hazards and entry operations prior to entry;
5. Informing the University of Seattle of the permit-required confined space program to be followed by the contractor during the aforementioned initial meeting; and
6. If the contractor does not have an entry supervisor, a representative from Environmental Health and Safety Department shall assume the role of entry supervisor.

Employees are responsible for complying with University and departmental policies for permit-required confined spaces.

Profiling Confined Spaces

Notification

To report a known or suspected confined space, Environmental Health and Safety Department shall be contacted at 543-7262.

Response

To ensure that confined spaces are properly evaluated and designated as permit-required confined spaces or non-permit confined spaces, Environmental Health and Safety Department shall conduct a visual inspection of the area to determine if:

- The area is large enough and so configured that an employee can enter and perform assigned work;
- The area has limited or restricted means for entry or exit;
- The area is not designed for continuous employee occupancy;
- The space contains a material that has the potential for engulfing an entrant;
- The space has an internal configuration such that an entrant could be trapped or asphyxiated by inwardly converging walls or by a floor which slopes downward and tapers to a smaller cross-section; and
- The space contains any other recognized serious safety or health hazard which includes, but is not limited to:
 - Airborne dust;
 - Grinding/Mulching;
 - Agitators;
 - Other moving parts;
 - Steam;
 - Electrical hazards;
 - Falling/Tripping hazards;
 - Rodents/Snakes/Spiders; or
 - Wind/Weather;
- Atmospheric monitoring to determine if the space contains or has the potential to contain a **hazardous atmosphere** according to the following procedure (Note: All atmospheric levels shall not exceed established permissible exposure limits and in the absence of permissible exposure limits, exposure levels shall fall

- below published guidelines as available in literature and reference materials such as material safety data sheets, threshold limit values, etc.);
- Environmental Health and Safety Department shall conduct initial monitoring of all confined spaces using a calibrated direct-reading device that measures oxygen, combustible gases and vapors, and toxic gases and vapors respectively;
 - Monitoring in vertical confined spaces shall be done every two feet within the confined space beginning at the top of the confined space and gradually moving down using a sampling pump and attached polycarbonate wand which pulls air from the confined space into the monitoring device;
 - Monitoring in horizontal confined spaces shall be done every two feet within the confined space beginning at the entrance of the confined space and gradually moving along the ceiling towards the opposite end and then gradually moving along the floor and back to the entrance using a sampling pump and attached polycarbonate wand which pulls air from the confined space into the monitoring device;
 - If an initial entry of the permit space is necessary to obtain the required monitoring and inspection data, the entry shall be performed under the "General Requirements for Permit-Required Confined Spaces" section of this document (including the completion of a Confined Space **Entry Permit** (Appendix B) and the presence of an attendant);
 - All initial monitoring results shall be documented on the confined space profile; and
 - All confined space profiles shall be maintained by Environmental Health and Safety Department.

Upon completion of the aforementioned evaluation, Environmental Health and Safety Department shall designate each confined space as a permit-required confined space or non-permit required confined space and thus document the status of each space on the confined space profile.

Note: Activities such as chemical processes can result in a change in the atmosphere of a confined space. If these activities are to be performed within a confined space designated as a non-permit confined space, Environmental Health and Safety Department shall be contacted at 543-7262, Monday-Friday 8:00 a.m. - 4:30 p.m. or contact the "On-Call" Safety Officer by calling the University Police (before/after working hours, weekends, or holidays) for a re-evaluation of the space. Refer to the "Reclassifying Confined Spaces" section of this document.

Posting Hazard Warning Signs

If a permit-required confined space is located on University of Seattle property, Environmental Health and Safety Department shall inform employees of the existence of such a space by posting a warning sign, which reads:

DANGER
Permit-Required Confined Space
DO NOT ENTER

When posting of warning signs is not feasible (e.g., sewers, pits), as determined by Environmental Health and Safety Department, permit-required confined spaces shall be identified by other equally effective means (e.g., training).

Permit-Required Confined Spaces Requirements

General

Entry into a permit-required confined space is prohibited at any time until the appropriate visual evaluation and atmospheric monitoring of the space is performed by Environmental Health and Safety Office.

Notification

Environmental Health and Safety Department shall be contacted at 543-7262 at least the day prior to the anticipated entry into a permit-required confined space so that the appropriate visual evaluation and atmospheric monitoring of the space can be performed.

EXCEPTION: Environmental Health and Safety Department shall be notified immediately during an **emergency** situation involving the anticipated entry into a permit-required confined space to perform the appropriate evaluations of the space.

Response

9. The **entry supervisor** from Environmental Health and Safety Department shall perform a visual inspection of the permit-required confined space and document the general purpose of entry and nature of hazards within the permit-required confined space on the entry permit.
10. Environmental Health and Safety Department shall conduct pre-entry monitoring to determine if the space contains or has the potential to contain a hazardous atmosphere according to the following procedure (Note: All atmospheric levels shall not exceed established permissible exposure limits and in the absence of permissible exposure limits, exposure levels shall fall below published guidelines as available in literature and reference materials such as material safety data sheets, threshold limit values, etc.):
 - Environmental Health and Safety Department shall conduct pre-entry monitoring in all permit-required confined spaces using a calibrated direct-reading device that measures oxygen, combustible gases and vapors, and toxic gases and vapors respectively;
 - Monitoring in vertical confined spaces shall be done every two feet within the confined space beginning at the top of the confined space and gradually moving down using a sampling pump and an attached polycarbonate wand which pulls air from the confined space into the monitoring device;
 - Monitoring in horizontal confined spaces shall be done every two feet within the confined space beginning at the entrance of the confined space and gradually moving along the ceiling towards the opposite end and then gradually moving along the floor and back to the entrance using a

sampling pump and an attached polycarbonate wand which pulls air from the confined space into the monitoring device;

- If an initial entry of the permit space is necessary to obtain the required monitoring and inspection data, the entry shall be performed under the "Permit-Required Confined Spaces Requirements" section of this document (including the completion of a Confined Space Entry Permit and the presence of an attendant); and
11. All pre-entry monitoring results shall be documented on the confined space permit.
 12. If the permit-required confined space is determined by Environmental Health and Safety Department as safe for entry, then a permit will be issued. If a permit is denied, a representative of Environmental Health and Safety Department will identify the measures to be taken in order for a permit to be awarded and entry into the permit-required confined space shall be prohibited until Environmental Health and Safety Department deems the space safe for entry and issues a permit. In some cases, Environmental Health and Safety Department may utilize alternate entry procedures (Appendix C).
 13. If an entry permit is awarded, Environmental Health and Safety Department shall complete and post the entry permit at the entry portal of the permit-required confined space.
 14. Only the assigned tasks or activities identified on the permit shall be conducted within the permit-required space and the duration of the permit may not exceed the time required to complete those assigned tasks or activities. If the assigned work goes beyond the planned time period or work tasks/activities other than those identified on the permit become necessary, the entrant shall leave the space and inform the supervisor of the expiration of the permit or of the newly proposed work tasks or activities. The department supervisor shall contact Environmental Health and Safety Department immediately for a re-evaluation of the space in regard to the proposed work task or activity.
 15. The entry supervisor shall supervise the entry team's implementation of the means, procedures, and practices necessary for safe entry operations which include, but are not limited to, the following:
 - Isolating the permit space by **blanking** or blinding; misaligning or removing sections of lines, pipes, or ducts; using a **double block and bleed** system; using lockout or tagout procedures; or blocking or disconnecting all mechanical linkages;
 - Purging, **inerting**, flushing, or ventilating the permit-required confined space as necessary to eliminate or control atmospheric hazards; and
 - Providing pedestrian, vehicle, or other barriers (i.e., barricades or tape) to protect entrants from external hazards whenever a permit-required space is entered.
 16. If necessary as determined by pre-entry evaluation of a permit-required space, employees will be appropriately equipped with the following:
 - Mechanical ventilation;
 - Safe means of communications;
 - Personal Protective Equipment;

- Lighting;
- Barriers;
- Equipment (e.g., ladder) for safe entry/exit by entrants; and
- External **retrieval systems**.

Retrieval equipment shall be provided by Environmental Health and Safety Department unless it is determined that the equipment would increase the overall risk of injury upon entry or would not contribute to the possible rescue of an entrant (e.g., internal configurations of the permit-required space). The Entry Supervisor for a permit-required confined space shall ensure the following retrieval systems or methods are in place before entry:

3. A chest or full body harness, with a retrieval line attached to the center of the entrant's back, near shoulder level or above the head; and
4. The other end of the retrieval line shall be attached to a mechanical device or fixed point outside the permit space. *Note:* A mechanical device must be available to retrieve personnel from a vertical permit- required confined space, which is five feet or more in depth.

Reclassifying Confined Spaces

Non-Permit Confined Space

Environmental Health and Safety Department shall be contacted at 543-7262 for a re-evaluation of the space and, if necessary, reclassification.

All signage on permit-required confined spaces, which are reclassified to non-permit confined spaces, shall be removed.

If Environmental Health and Safety Department reclassifies a space, this shall be documented on the Confined Space Profile under the "Status" section and the date of reclassification shall be identified.

Conditions that may cause the reclassification of confined space or a permit-required confined space are as follows:

3. Conditions employees should be aware of include a change in work activities which could result in a change in the atmosphere (e.g., chemical usage), contents of the space begin to re-enter or any other hazards; and
4. If while employees are working within a permit-required confined space and the conditions change, employees should exit the space immediately and contact Environmental Health and Safety Department Office for a re-evaluation of the space.

Termination of Work

Individual departments shall contact the entry supervisor to terminate entry and cancel the permit when the work covered by the entry permit has been completed

and/or a condition that is not allowed under the entry permit arises in or near the space.

Contractors

If an outside contractor is hired to perform work within a permit-required confined space at the University of Seattle, the department supervisor shall contact Environmental Health and Safety Department 72 hours prior to beginning the work.

The entry supervisor from Environmental Health and Safety Department and the department supervisor shall coordinate entry operations with the entry supervisor of the outside contractor when employees from the University and the Contractor will be working together in or near permit-required confined space(s).

The entry supervisor from Environmental Health and Safety Department and the department supervisor shall be responsible for the following:

6. Informing the contractor that the area in question is a permit-required confined space;
7. Reviewing the permit-required confined space program followed by the contractor;
8. Informing the contractor of the hazards identified within the space and any past experience with the space;
9. Informing the contractor of any precautions or procedures that have been implemented for the protection of employees in the permit-required confined space where contractor personnel will be working; and
10. Debriefing the contractor at the end of the work to identify hazards discovered or created in the permit-required confined space during operations.

Rescue and Emergency Services

The Seattle Fire Department shall perform permit-required confined space rescue in accordance with 29 CFR 1910.146 (k) (1).

If in the course of his/her duties outside a permit-required confined space an attendant becomes aware that an entrant needs assistance in escaping from the space, the attendant shall summon rescue and other emergency services and begin non-entry rescue procedures by pulling up the retrieval line attached to the entrant. Attendants shall never enter the space to attempt a rescue and shall always remain outside the permit-required confined space during entry operations until relieved by another attendant.

The entry supervisor shall inform the Seattle Fire Department of the hazards they may confront when called upon to perform a permit-required confined space rescue.

Training

Requirements

Environmental Health and Safety Department shall be responsible for providing appropriate training. This training is provided to each employee serving as authorized entrant, attendant, and entry supervisor during any type of confined space operation. The purpose of this training is to equip the individual with an understanding, knowledge and the skills necessary for the safe entry into a permit-required confined space.

Curriculum

All employees serving as authorized entrants, attendants, or entry supervisors shall be trained to understand the following:

13. What is a confined space, non-permit confined space and permit-required confined space;
14. When a permit-required confined space may be re-classified and procedures for declassification;
15. How to obtain and/or cancel a permit in order to enter a permit- required confined space;
16. The hazards that may be faced during entry including information on the mode of exposure, signs or symptoms, and consequences of exposure;
17. Equipment and methodologies used to determine if safe entry into a permit-required confined space is possible;
18. How to recognize warning signs or symptoms of exposure to a dangerous situation;
19. The importance of communication between the entrant and attendant including methods used to continuously maintain an accurate count of authorized entrants within the permit-required confined space, the methods of communication to determine entrant status and when to alert the attendant;
20. How to properly use personal protective equipment and any other applicable equipment including: ventilating equipment, communication equipment, lighting equipment, barriers and shields, ingress/egress equipment, rescue and emergency equipment used for non-entry and any other equipment necessary for safe entry into and rescue from permit spaces;
21. How and when to evacuate a permit-required confined space. All entrants should exit from a permit required confined space as quickly as possible whenever:
 - An order to evacuate is given by the attendant or the entry supervisor;
 - The entrant recognizes any warning signs or symptoms of exposure to a dangerous situation; and
 - The entrant detects a **prohibited condition**;
22. Methods used to monitor the activities inside and outside the space to determine if it is safe for entrants to remain in the space;
23. Methods used to summon rescue and other emergency services; and
24. Methods used to handle unauthorized persons who approach or attempt to enter a permit-required confined space. These methods include the following:

- Warn the unauthorized persons that they must stay away from the permit space;
- Advise the unauthorized persons that they must exit immediately if they have entered the permit space; and
- Inform the authorized entrants and the entry supervisor that unauthorized persons have entered the permit space by contacting Environmental Health and Safety Department at 543-7262 or contact the "On-Call" Safety Officer through the University Police, after work hours, weekends and holidays.

Frequency

Training shall be provided as follows:

5. Before an employee is assigned to a duty involving entry into a permit- required confined space;
6. Before there is a change in assigned duties (e.g., attendant becomes an entrant);
7. Whenever there is a change in confined space operations that presents a hazard that an employee has not been previously trained on; or
8. Whenever there are deviations from the entry procedures or inadequacies in the employee's knowledge or use of entry procedures as identified by the Environmental Health and Safety Department during entry procedures.

Record keeping

Training programs shall establish employee proficiency in the duties required of authorized entrants, attendants, and entry supervisors. Training programs and records shall be maintained by Environmental Health and Safety Department for three years subsequent to the initial training period and will include the following:

6. Dates of the training sessions;
7. Contents or summary of the training sessions;
8. Names and qualifications of persons conducting the training;
9. Names and job titles of all persons attending the training sessions; and
10. Results of the learning measurement exercise.

Glossary

Agitator: A device or apparatus for stirring or shaking.

Attendant: An individual stationed outside one or more permit-required confined spaces who monitors the authorized entrants and performs assigned attendant duties.

Authorized Entrant: An employee who is authorized by the employer to enter a permit-required confined space.

Confined Space: A space that:

- Is large enough and so configured that an employee can bodily enter and perform assigned work;
- Has limited or restricted means for entry or exit (e.g., tanks, vessels, silos, storage bins, hoppers, vaults, and pits); and
- Is not designed for continuous employee occupancy.

Blanking (Blinding): The absolute closure of a pipe, line, or duct by the fastening of a solid plate that completely covers the bore and is capable of withstanding the maximum pressure of the contents within the pipe, line, or duct with no leakage beyond the plate.

Emergency: Any occurrence or event internal or external to the permit-required confined space that could endanger entrants.

Entry: The action by which a person passes through an opening into a permit-required confined space. Entry is considered to have occurred as soon as any part of the entrant's body breaks the plane of an opening into the space.

Entry Permit (Permit): The written or printed document that is provided by the employer to allow and control entry into a permit-required confined space.

Entry Supervisor: A representative from Facilities Services - Safety and Environmental Affairs who shall be responsible for the following: determining if acceptable entry conditions are present at a permit-required confined space where entry is planned; authorizing entry; overseeing entry operations; and terminating entry as required.

Grinding: To wear down, polish, or sharpen by friction.

Hazardous Atmosphere: An atmosphere that may expose employees to the risk of death, incapacitation, impairment or acute illness from one or more of the following causes:

- Flammable gas, vapor, or mist in excess of ten percent of its lower flammable limit;
- Airborne combustible dust at a concentration that meets or exceeds its lower flammable limit (dust obscures vision at a distance of five feet or less);
- Atmospheric oxygen concentration below 19.5 percent or above 23.5 percent;
- Atmospheric concentration of any substance for which a dose or a permissible exposure limit is published and which could result in employee exposure in excess of its dose or permissible exposure limit; and/or
- Any other atmospheric condition that is immediately dangerous to life or health.

Inerting: The displacement of the atmosphere in a permit-required confined space by a non-combustible gas (e.g., nitrogen) to such an extent that the resulting atmosphere is non-combustible.

Non-Permit Confined Space: A confined space that does not contain or, with respect to atmospheric hazards, have the potential to contain any hazard capable of causing death or serious physical harm.

Permit-Required Confined Space (Permit Space): A confined space that has one or more of the following characteristics:

- Contains or has a potential to contain a hazardous atmosphere (e.g., dependent upon work activities - cleaning with solvents, using degreasers);
- Contains a material that has the potential for engulfing an entrant;
- Has an internal configuration such that an entrant could be trapped or asphyxiated by inwardly converging walls or by a floor which slopes downward and tapers to a smaller cross-section; or
- Contains any other recognized serious safety or health hazard (i.e., excessive noise levels, moving parts, electrical hazards, fall/trip hazards).

Prohibited Condition: Any condition in a permit-required confined space that is not allowed by the permit during the period when entry is authorized.

Retrieval System: The equipment used for non-entry rescue of persons from permit-required confined spaces.

Section 9: Fire Safety

9.1 Fire Protection and Prevention

Fire Safety at the University is regulated by the Seattle Fire Code and WISHA. Many policies and programs have been initiated to help assure compliance with these codes and to protect and promote the public safety of faculty, staff, students, visitors, and emergency personnel. UW EH&S answer questions with respect to fire safety codes, hazardous material storage and use, hazardous material inventories, exiting, evacuation planning, fire safety related laboratory layout, fire detection and suppression, and various other subjects. Please contact them at 206-543-0465.

1. The UW fire protection program requires that all buildings and facilities be examined for fire safety precautions with special attention given to occupancy loads, extinguishing units, detection systems, type and condition of equipment in use, storage practices, use of flammable materials, and emergency procedures.
2. All flammable liquids must be stored and handled in a safe manner as specified in the UW Laboratory Safety Guide, which outlines the amount of flammables permitted in specific areas, use of safety cans, and storage and handling procedures. All laboratories, stockrooms, and bulk storage facilities must be constructed and maintained in conformance with the campus standards and criteria for such facilities, which include consideration of providing proper ventilation, electrical equipment, floor drainage, curbing, and fire resistant walls. Any facilities where flammable liquids are to be introduced for the first time must be approved by the EH&S office prior to occupancy.

Flammables used in nonlaboratory situations must be handled in accordance with safe practices and applicable standards.

3. Domestic refrigerators and freezers for use in a laboratory environment must be the "lab-safe" desparked type, according to specifications provided by the EH&S office. Food service equipment is exempt from desparking requirements.
4. Events, such as concerts or theatrical productions, parades, house decorations, or other functions planning to utilize paper, crepe paper, butcher paper, similar combustible materials, tents, electrical apparatus, open fires, or special pyro effects must submit plans to the EH&S office for approval prior to the event. Offices planning holiday decorations using branches, trees, paper and combustible materials, and extension cords or lights are to contact the EH&S office for fire safety advice. Open flame candles are prohibited.

For all special events, including concerts, lectures, etc., where possible overcrowding may occur, the sponsor of the event must discuss crowd control precautions with Campus Calendar and must also receive approval from the EH&S office prior to the event. If an overcrowding problem occurs during an event, the EH&S office or University Police can request the sponsor of the event to "shut down" the event if it is felt the situation endangers the life and safety of those present.

5. All occupants in a building must immediately evacuate that building whenever the fire alarm is sounded. Each department must have a plan for evacuation that includes attention to critical or hazardous equipment, open flames, or other situations that necessitate prompt action just prior to evacuation.

Emergency procedure charts are posted on each floor of each building showing the location of emergency equipment and approved exits as indicated on the charts.

a. Office and Classroom Evacuation

Remain calm.

Close doors, but DO NOT lock.

Leave building by nearest exit.

Use stairways--NOT ELEVATORS.

Stay at least 300 feet away from building.

Do not return to building until notified to do so by the police.

b. Laboratory Evacuation

Remain calm--DO NOT rush the following procedures:

Close lab as usually done after class or at day's end.

If experiments are in progress, turn any heat or flames OFF and discontinue any other hazardous operations.

Close all lab hoods.

Close all doors, but DO NOT lock.

Leave building by nearest exit.

Use stairways--NOT ELEVATORS.

Stay at least 300 feet away from building.

Do not return to building until notified to do so by the police.

6. Fire alarm systems shall be tested in accordance with instructions given by the State Fire Marshal. Fire drills shall be conducted in University-operated elementary schools, preschools, and day-care centers with a frequency of once a month during the school year; and records shall be kept of the date and hour of each drill and the person in charge of the drill. In all other buildings and facilities fire drills will be held at the discretion of the EH&S office, in cooperation with departments. Facilities Management must be notified in advance of the drill, and whenever practical, prior notice will be given to building occupants.

Successful evacuation of campus buildings is dependent upon a clearly marked and unobstructed exit system. University policy for providing adequate exiting is set forth by the Chancellor's letter of January 20, 1991: "Lockers, cabinets, and other furnishings or equipment are not permitted in campus corridors".

7. In order to maintain proper access from every portion of a building, all corridors must be maintained free, clear, and unobstructed. Placing bicycles, file cabinets, refrigerators, desks, etc., in any corridor is PROHIBITED. Due to possible obstruction in an emergency, bicycles are not to be stored in classrooms, laboratories, and other public areas, but should be secured in a bicycle rack designed for parking bicycles. Motor vehicles, motorcycles, and other portable, combustible fuel-driven motors are strictly prohibited from entering or being stored inside any building (except the campus garage and specified maintenance buildings).

8. Fire detection and protection systems must remain on and operating at ALL times. Only the EH&S office can give specific permission to temporarily disconnect a fire detection or protection device. If for any reason a fire system must be shut off, becomes ineffective, or breaks down, the EH&S office must be notified IMMEDIATELY. This includes turning off any system by UW maintenance personnel for the purpose of tests or repairs. Any time a fire protection system is affected, the EH&S office must be notified.

9. Cutting and Welding

a. Permit Required

A cutting and welding permit ("hotwork permit" -- attached at end of this section) must be obtained from shop supervisor prior to the start of any cutting or welding operations on CEE properties. A job site or area inspection will be made prior to issuance of the permit, and specific fire safety requirements must be met before work will be permitted to begin. The permit will be issued to one person responsible for the work to be accomplished. Shop areas that have a permanent setup as a welding area will be issued a permit on an annual basis. Renewal requests will require a fire safety inspection prior to issuance. However, periodic spot checks will be made to assure that fire safety requirements are being followed. If shop-welding areas fail to comply with fire safety regulations, their permits will be revoked, and cutting and welding will be prohibited in those areas.

This permit requirement applies to ALL cutting and welding work on CEE properties. Exceptions will be made for contractors when an entire structure is erected.

The permit must be conspicuously displayed at the job site, preferably attached to, or near, the welding equipment.

b. Rules for Welding and Cutting

1) All employees involved in cutting and welding operations should be carefully trained, properly supervised, and authorized to perform each job. Department personnel must have cutting and welding listed in their job descriptions in order to be eligible to do the actual cutting and welding.

2) A 5-lb. ABC or CO2 fire extinguisher must be located at the job site, within easy reach of the fire watch.

3) The area where the cutting and welding is taking place must be free of combustible material; or, if it is impractical to move away the combustibles, they must be covered with asbestos tarpaulins or metal shields. ALL FLAMMABLE LIQUIDS must be removed from where cutting involves wall or floors, and combustibles must be protected on BOTH sides of the wall or floor.

4) Welding and cutting are not allowed in confined spaces.

9.2 Welding, Cutting and Brazing

Please note that this program has a glossary. The glossary contains the definitions for various terms used in the program. These terms are highlighted in bold print the first time they appear in the body of the program.

Policy

No **employee** of the CEE Department, contractor hired by CEE or subcontractor hired by the contractor shall perform any **welding, cutting or brazing** unless a Hot Work Permit is obtained.

Authority and Responsibility

Environmental Health and Safety Department is responsible for:

4. Reviewing the Welding, Cutting and Brazing policy to assure compliance; and
5. Assisting in training of affected employees.

Supervisors are responsible for:

4. Notifying all employees to the purpose and intent of the Welding, Cutting and Brazing policy;
5. Making periodic inspections of areas where the welding, cutting and brazing procedures are being used; and
6. Assuring that all employees are trained in the procedures.

Employees are responsible for complying with these procedures.

Contractors and sub-contractors are responsible for complying with these procedures.

**** THIS POLICY DOES NOT PERTAIN TO SOLDERING OPERATIONS ****

Procedure

Prior to starting a project that requires **hot work**, the supervisor for the welder or in certain cases the welder himself/herself shall obtain a Hot Work Permit from Seattle Fire Department By contact fire safety office of EH&S at 543-0465.

The supervisor shall maintain copies of the permit on site.

Prohibitions

Welding, cutting or brazing shall not be permitted in the following areas until the conditions prohibiting "Hot Work" have been modified:

6. In the presence of explosive atmospheres, or in situations where explosive atmospheres may develop inside contaminated or improperly prepared tanks or equipment which previously contained flammable liquids;
7. In areas with an accumulation of combustible dust;
8. In areas near the storage of large quantities of exposed, readily ignitable materials such as combustibles;
9. On a container such as a barrel, drum or tank that contained materials that will emit toxic fumes when heated; and
10. In a confined space, until the space has been inspected and determined to be safe. Refer to the Confined Space Program policy, Section 4.12 of this Safety Manual.

Protective Equipment

The welder shall be equipped with the following protective devices and/or apparel as indicated on the permit or as listed below:

2. Portable and or mechanical ventilation capable of keeping the levels of fumes, dust and gases below the thresholds established in the Occupational Safety and Health Administration Permissible Exposure Limits found in Section 5.9, the Chemical Hygiene Plan, within this manual. If portable or mechanical ventilation

- is not available and fume, dust and gas generation is high, respirators shall be used;
3. Gloves, apron and/or jacket that are made of a material that is an insulator from heat and electricity;
 4. Welders helmets equipped with proper filter plate and cover lenses;
 5. Fire blanket;
 6. Respiratory protection;
 7. Screens to protect persons not properly protected from the visual effects of viewing arc welding or cutting and during gas or oxygen cutting or welding; and
 8. Lifelines and harnesses for work in confined spaces (refer to the Confined Space Program, Section 4.12 of this Safety Manual).

Storage of Equipment

Equipment and supplies shall be stored in a manner that will prevent the creation of hazardous conditions.

Education/Training

Employees shall be trained on all aspects of this policy.

Respirators

No employee shall be issued or required to use a respirator until that employee has satisfied the criteria set forth in the Respiratory Protection Program, Section 4.16.

Injuries/Exposures

If during the performance of assigned duties the welder becomes injured or suspects an occupational exposure occurred, then such situations shall be reported in accordance with the Incident Reporting and Investigation Program, Section 3.14.

Glossary

Brazing: A process in which one would solder with a nonferrous alloy that melts at a lower temperature than that of the metals being joined.

Cutting: A process used in dividing metal into individual pieces.

Employee: Any person hired by the University of Chicago regardless of the person's job description (e.g., faculty, plant personnel, principle investigators, contractors and subcontractors hired by the contractors) that may be required to or have the need to perform welding, cutting and brazing.

Hot Work: Any welding, cutting or brazing that requires the use of electric or gas cutting equipment.

Welding: A process used to unite by heating and allowing the metals to flow together without previous heating.

9.3 Electricity

Fires A large percentage of fires are of an electrical origin, caused by one or more of the following:

- (i) **Sparks** A spark arises from a sudden discharge through the air between two conductors, or from one conductor to earth. The current produced is usually small so that serious fires are unlikely unless explosive gases or vapors are present, or highly flammable material is in contact with the conductor.
- (ii) **Arcs** An arc is a much larger and brighter discharge where the current flow may be hundreds of amps. It usually arises when a circuit is broken or when a conductor melts or fractures leaving a gap across which current continues to flow. When an arc is established, the air in the vicinity becomes ionized and forms a conductor, which may allow current to flow to a nearby metal framework. Any combustible material in the vicinity could therefore lead to a fire.
- (iii) **Short circuits** A short circuit is formed when the current finds a path from the outward conductor wire to the return wire other than through the equipment to which it is connected. The current flow may be large because of the low resistance of the leads, and arcing often occurs at the contact between the conductors. Insulation may therefore be burned and set fire to adjacent flammable material. Batteries have a low internal resistance and can give rise to very large currents under short circuit conditions, causing a large arc from which molten metal may be splashed.
- (iv) **Overloading and old wiring** Wiring must not be overloaded, otherwise it will overheat and the insulation will be damaged. This can lead to a short circuit at some point in the length of the conductor, or more likely at connection points. The insulation of wiring which has been in use for a number of years tends to become brittle and, where alterations and additions are required, the cable must always be checked by a competent electrician and replaced completely if there are indications of failure of the insulation. Installations should be protected against overloading and short circuits by fuses or circuit breakers.

9.4 Fire Resistive Rating for Furniture, Scenery and Decorations

Policy

All furniture (either purchased or **reupholstered**), **decorations** and **scenery** used or intended for use in University of Washington buildings shall maintain a **fire resistive rating** in accordance with this policy.

New Furniture Purchases

All new furniture purchased for occupancies classified as school or classroom buildings shall have and maintain a fire resistive rating as is set forth by the "Test Standards" section in this policy.

Exemptions

All seating furniture, other than juvenile furniture and furniture used for and in facilities designed for the care or treatment of humans, which meet any of the following criteria are exempt from compliance:

1. Cushions and pads intended solely for outdoor use;
2. Any furniture that is smooth surfaced and contains no more than one-half inch of filling material, if furniture does not have horizontal surface meeting vertical surface; and
3. Furniture manufactured solely for recreational use or physical fitness purposes, such as weightlifting benches, gymnasium mats or pads, side horses and similar articles.

Reupholstered Furniture

All seating furniture used in a public occupancy may be reupholstered without having to meet the performance standards as described in the "New Furniture" section of this policy, provided that replacement filling material is fire retardant and that all filling material is completely encased in material designed to slow the spread of fire, increase escape time, prevent rapid combustion, insulate internal materials and restrict generated gases, as described in the Illinois State Fire Marshall "Furniture Fire Safety Regulations Part 300".

Scenery and Decorations

All scenery and decorative materials used as stage materials, paraphernalia, scenery, decoration, drapes, curtains or similar materials used for decorative effect or stage settings shall maintain a fire resistive rating as set forth by the "Test Standards" section of this policy. However, when scenery or decorations will not support combustion or carry a flame when subjected to a temperature of twelve hundred degrees Fahrenheit for a period of not less than ten minutes the scenery or decoration is exempt from the test standard described in this policy.

Candles or Open Flame Devices

All candles or **open flame devices** used for illumination or decorative purposes shall be kept in suitable non-combustible holders. These devices shall be placed in such a manner so that they will not ignite any combustible material or constitute a dangerous hazard or condition.

Wall Coverings

In all areas of public assemblies, businesses, churches, schools and theaters outside of the stage area, not more than five percent of the wall area shall be covered by scenery and decorations. No one article of scenery or decoration shall cover more than three percent of said wall area. Before any scenery or decoration is used it shall be treated

with a flame retardant solution and continuously maintained in such a condition to pass a flame retardant test as described in the "Test Standard" section of this policy.

In all occupancies, no scenery or decorations shall be hung or applied as to conceal a means of an emergency exit or exit way, nor to reduce the width of an emergency exit or exit way. No scenery or decoration shall be placed on a wall in such a manner as to give the appearance of an emergency exit where one does not exist.

Test Standards

Any material used as scenery and decorations which will either support combustion or carry a flame when subjected to a temperature of twelve hundred degrees Fahrenheit for a period of not less than ten minutes shall conform to the large and small scale tests in the **National Fire Protection Association** Standard 701 "Standard Methods of Fire Tests for Flame Resistant Textiles and Films", 1973 edition. The material shall also be certified by a recognized testing agency, such as Underwriter's Laboratories.

Labeling Requirements

The furniture manufacturer shall attach the required labeling, as set forth by the applicable standards. The label shall identify the product manufacturer, the fire-resistive rating and the applicable standards. The label shall remain on all furniture and shall not be removed for any reason.

Glossary

California Technical Bulletin 116 (1980): A standard adopted by the State of Illinois Fire Marshall and developed by the State of California, Department of Consumer Affairs, Bureau of Home Furnishings and Thermal Insulation, the "Requirements, Test Procedures and Apparatus for Testing the Flame Retardance of Upholstered Furniture".

California Technical Bulletin 117 (1980): A standard adopted by the State of Illinois Fire Marshall and developed by the State of California, Department of Consumer Affairs, Bureau of Home Furnishings and Thermal Insulation, the "Requirements, Test Procedures and Apparatus for Testing the Flame Retardance of Resilient Filling Materials Used in of Upholstered Furniture".

California Technical Bulletin 133 (1991): A standard adopted by the State of Illinois Fire Marshall and developed by the State of California, Department of Consumer Affairs, Bureau of Home Furnishings and Thermal Insulation, the "Flammability Test Procedures for Seating Furniture for Use in Public Occupancies".

Decorations: Any material used for decoration such as stage materials, curtains, drapes, or similar materials or items used for decorative purposes.

Fire Resistive Ratings: A minimum rating established by the National Fire Protection Association is which material must meet to prevent and retard combustion.

National Fire Protection Association: An organization promoting fire science and improving the methods of fire protection and prevention, electrical safety and other related safety issues. Many of the performance criteria promulgated by the NFPA may be adopted by federal and local agencies.

Open Flame Devices: Any device, which supports a flame such as personal lighters.

Questionable Conditions: A concern that exists which the item or items being reviewed do not appear to meet the required criteria set by the applicable standard.

Reupholstered: To replace filling materials or materials encasing or covering filling materials on an article of seating furniture.

Scenery: Any painted scenes, hangings or accessories used on a theater stage.

9.5 Fire Detection Systems

Please note that this program has a glossary. The glossary contains the definitions for various terms used in the program. These terms are highlighted in bold print the first time they appear in the body of the program.

Policy

All **fire detection systems** shall be inspected, maintained and tested in accordance with this policy.

Authority and Responsibility

Department are responsible for:

1. Scheduling and coordinating the required inspection, maintenance and testing with a Physical Plant or private contractor who is trained in the operations and function of the system;
2. Restoring the fire detection system to its normal operating condition after maintenance, testing or alarm activation;
3. Notifying Environmental Health and Safety Department and Physical Plant of any unscheduled impairment; and
4. Maintaining the required documentation.

Fire Detection System Components

This policy shall cover all components of fire detection systems including, but not limited to:

1. Fire alarm panel;

2. Fire alarm **annunciator panel**;
3. Detection devices, such as heat and smoke detectors; and
4. Manual pull stations.

Monthly Inspection and Testing

All fire detection systems shall be inspected and tested monthly. A private contractor or facility's engineer knowledgeable in the operations and functions of the alarm system shall conduct the inspection and test.

The monthly inspection and testing of fire detection systems shall be in accordance with Chapter 72 "*National Fire Alarm Code*" of the **National Fire Protection Association (NFPA)**.

Annual Testing

All fire detection systems are tested annually by the Seattle Fire Department (206 386 1450). SFD is also responsible for enforcing fire code at UW facilities.

Documentation

All monthly and annual testing reports of fire detection systems shall be maintained by the responsible department.

Restoration and Impairment

All fire detection systems and their components shall be restored to normal operating condition promptly after any maintenance, testing or alarm activation has occurred.

Fire Watch

If the fire detection system cannot be restored, a fire watch shall be implemented. The individual performing the fire watch shall be trained in the following:

1. Portable fire extinguisher procedures;
2. Procedures for reporting an emergency;
3. Evacuation procedure; and
4. Hazard recognition.

The fire watch shall consist of the following during the impairment:

1. Periodic inspection of the areas and rooms within the affected building(s) to ensure hazards do not exist;
2. Ensuring adequate fire protection equipment is available and in working condition; and
3. Limiting hazardous work practices such as welding, cutting, brazing or the usage of open flame.

Glossary

Annunciator Panel: A visual device indicating a certain area or room within the building in which a detection device is activated.

Approved Testing Laboratory: A laboratory or testing facility engaged in the listing or approval of heat detectors such as Underwriters Laboratories.

Fire Detection Systems: A component of the fire alarm system such as smoke and heat detectors or sprinkler heads.

National Fire Protection Association (NFPA): An organization promoting fire science and improving the methods of fire protection and prevention, electrical safety, and other related safety issues. Many of the performance criteria promulgated by the NFPA may be adopted by federal or local agencies.

9.6 Portable Fire Extinguishers

Please note that this program has a glossary. The glossary contains the definitions for various terms used in the program. These terms are highlighted in bold print the first time they appear in the body of the program.

Policy

All **portable fire extinguishers** shall be distributed, maintained, inspected and tested in accordance with this policy.

Authority and Responsibility

The *Environmental Health and Safety Department* is responsible for:

1. Annual maintenance and **hydrostatic testing** of portable fire extinguishers;
2. Replacing inoperable portable fire extinguishers upon discovery;
3. Upon being notified, replacing portable fire extinguishers with appropriate types when **fire loads** and/or occupancies change, and;
4. Surveying the building or area for extinguisher selection and distribution during fire and safety audits; and
5. Notifying the responsible University department in the event an extinguisher is inoperable, missing or the type of unit is inadequate.

Selection of Portable Fire Extinguishers

Classes of Fire

Class A: Class A fires involve ordinary combustible such as paper, cloth, wood, rubber and some plastics. Extinguishers for extinguishing Class A fires include pressurized water and the ABC (multi-purpose) dry chemical extinguishers.

Class B: Class B fires involve flammable liquids such as gasoline, thinners, oil-based paints and greases. Extinguishers selected for extinguishing Class B fires include

carbon dioxide, ABC (multi-purpose) dry chemical types and halogenated agent types.

Class C: Class C fires involve energized electrical equipment such as computers, copy machines, television sets and video equipment. Extinguishers selected for extinguishing Class C fires include the B/C (Co₂), Halon 1211 or the ABC (multi-purpose) fire extinguisher.

Class D: Class D fires involve combustible metals such as magnesium, titanium, zinc and potassium. Since there is no one type of extinguishing agent to combat all combustible metal fires, the type of extinguishing agent shall depend on the specific type of combustible metal within the workplace.

Fire Loading

When selecting a portable fire extinguisher, one must consider not only the class of fire anticipated but also the fire loading. The following is a description of the three degrees of fire loading within the occupancy. The *Light (Low) Fire Load* occupancy is a location where the total amount of Class A combustible materials including furniture, window treatments and its contents is of minor quantity. Small amounts of Class B flammable liquids such as duplicating and cleaning solvents are included provided that they are kept in closed containers and stored properly.

The *Ordinary (Moderate) Fire Load* occupancy is a location in which Class A combustibles, Class B flammable liquids and Class C energized electrical equipment are in greater amounts than expected under a low hazard. These locations include dining areas, storage areas and parking garages and assembly halls.

The *Extra (High) Fire Load* occupancy is a location where the total amount of Class A combustibles, Class B flammable liquids and Class C energized electrical equipment present is over and above those classified as moderate hazard. The occupancies and areas include laboratories, cooking areas, trade shops and warehouses.

Types of Portable Fire Extinguishers

The extinguishers describe below have some adverse aspects that should be considered when choosing an extinguisher. The carbon dioxide extinguisher will subject the involved fire materials to freezing temperatures, which in turn could damage instruments. The multi-purpose dry chemical extinguisher when discharged will release a powder throughout the area that could lead to extensive clean-up procedures. The Halon 1211 is recommended for extinguishing fires involving sensitive electrical equipment due to its ability to reduce clean-up procedures and equipment damage, but may not be effective on deep seated fires such as in stock piles or trash can fires.

Pressurized Water Extinguishers

The pressurized water extinguisher is the most popular type of extinguisher used for extinguishing Class A fires.

Carbon Dioxide Extinguishers

The carbon dioxide fire extinguisher is primarily used in areas where the potential for Class B and Class C fire loads exist.

Halogenated Agents

The Halon 1211 fire extinguisher has a similar agent to the carbon dioxide. The Halon 1211 extinguisher is used in areas where Class B and Class C fire loads exist.

Multi-Purpose Dry Chemical

The dry chemical fire extinguisher is used in areas where Class A, Class B or Class C hazards are encountered.

Extinguishing Agents for Combustible Metals

There is no single extinguishing agent or powder that will control or suppress all combustible metal fires. The type of extinguishing agent in a particular area is based on the type of combustible metals being used.

Obsolete Portable Fire Extinguishers

There are several types of portable fire extinguishers that are considered obsolete, therefore ineffective and dangerous. These extinguishers include:

1. Any extinguisher having a shell construction of copper or brass joined by soft solder and/or rivets;
2. Inverting-type extinguishers such as those listed:
 - a. Soda Acid;
 - b. Foam;
 - c. Water-Cartridge; and/or
 - d. Loaded stream cartridge.

All extinguishers that are considered obsolete shall be removed from the workplace and replaced with an appropriate extinguisher immediately.

The replacement of fire extinguishers can be accomplished by contacting Environmental Health and Safety Department.

Labeling of Portable Fire Extinguishers

All fire extinguishers shall have a label affixed to the front of the extinguisher showing operating instructions and the extinguisher rating.

A **pictogram** or **letter-shaped symbol** can be used for identifying the extinguisher's rating.

Distribution of Portable Fire Extinguishers

The following gives the travel distances a person should not exceed in order to obtain a fire extinguisher.

Class A Fire Hazards

Portable fire extinguishers rated for Class A fires shall be distributed so the travel distance does not exceed 75 feet from any point.

Class B Fire Hazards

Portable fire extinguishers rated for Class B fires shall be distributed in accordance with Table 1.

Table 1

<i>Type of Hazard</i>	<i>Basic Minimum Extinguisher Rating</i>	<i>Maximum Travel Distance to Extinguishers</i>
Light (Low)	5-B	30 feet
	10-B	50 feet
Ordinary (Moderate)	10-B	30 feet
	20-B	50 feet
Extra (High)	40-B	30 feet
	80-B	50 feet

Class C Fire Hazards

Portable fire extinguishers rated for Class C fires shall be distributed so the travel distance does not exceed 50 feet.

Class D Fire Hazards

Portable fire extinguishers shall be distributed in areas where combustible metal powders, flakes or shavings are generated. Extinguishers shall be distributed so the travel distance does not exceed 75 feet.

Mounting of Portable Fire Extinguishers

All portable fire extinguishers shall be installed on brackets or mounted in wall cabinets. Extinguishers having a gross weight not exceeding 40 pounds shall be installed so that the top of the extinguisher is not more than five feet from the floor. Extinguishers having a gross weight exceeding 40 pounds shall be installed so the top of the extinguisher is not more than three and one half feet above the floor. The bottom of the extinguisher in either case shall not be less than four inches above the floor.

Where the extinguisher is likely to be obscured, a sign shall be installed marking the location of the fire extinguisher. The sign shall be visible from a distance of at least 50 feet if the extinguisher cannot be relocated.

Annual Maintenance of Portable Fire Extinguisher

All portable fire extinguishers shall have an annual maintenance check completed by Environmental Health and Safety Department. All maintenance and hydrostatic testing performed by the service shall be in accordance with Chapter 10 "Portable Fire Extinguishers" of the National Fire Protection Association.

The scheduling of maintenance inspections is the responsibility of the Environmental Health and Safety Department.

Glossary

Fire Load: The quantity and type of material within an area or building that would enhance or support a fire.

Hydrostatic Testing: A test conducted on the cylinder or shell of a portable fire extinguisher to ensure it can withstand internal pressures it is subjected to.

Letter-Shaped Symbol: A labeling system used for identifying the rating of an extinguisher. A letter rating of the extinguisher is placed in the center of a defined shaped.

Occupancy: A designation which classifies the building or area within the building (e.g., business, hazardous use, school, multiple dwelling).

Pictogram: A label using diagrams to indicate the fire rating of a portable fire extinguisher.

Portable Fire Extinguishers: Extinguishing units that can be brought to the fire.

9.7 Fixed Fire Suppression Systems

Please note that this program has a glossary. The glossary contains the definitions for various terms used in the program. These terms are highlighted in bold print the first time they appear in the body of the program.

Policy

All fixed fire suppression systems shall be inspected, maintained and tested in accordance with this policy and procedure.

Authority and Responsibility

CEE department is responsible for:

1. Restoring any fixed fire protection to its normal operating condition after any maintenance, testing or usage;

2. Notifying Environmental Health and Safety Department during any scheduled or unscheduled impairment; and
3. Maintaining the required documentation.

The *supervisor or designee* from the department shutting down any fixed **fire protection equipment** shall be responsible for:

1. Notifying all **employees** of the purpose and intent of the shutdown;
2. Assuring all employees are trained in the procedures;
3. Notifying Environmental Health and Safety Department prior to the shutdown.

Contractors and sub-contractors are responsible for complying with these procedures.

Environmental Health and Safety Department shall be responsible for:

1. Fix any questionable conditions that are discovered during the Annual Fire/Safety Review;
2. Responding to shutdown requests in a timely manner;
3. Reviewing the policy and procedure to assure compliance;
4. Notifying the proper authorities of a need to take a fixed system out of service;
5. Making periodic tours of the areas during the shutdown of a fixed system;
6. Placing a copy of a shutdown permit in the **lock box** whenever one is issued; and
7. Maintaining the proper documentation.

Fixed Fire Protection Systems

This policy shall include all types and components of a fixed fire protection system including, but not limited to:

1. Sprinkler systems;
2. Standpipe and fire hose systems;
3. Fire pumps;
4. Fixed dry chemical extinguishing systems;
5. Fixed wet chemical extinguishing systems;
6. Fixed halogenated extinguishing systems; and
7. Fixed carbon dioxide extinguishing systems.

Inspection of Sprinkler Systems

All **sprinkler systems** shall have a weekly, monthly and annual inspection performed. The following provides a description of what the inspection involves and the type of personnel required to conduct these inspections.

Weekly Inspection

All gauges on dry pipe sprinkler systems shall be inspected weekly to ensure that normal air and water pressures are being maintained. The weekly inspection shall be

performed by a person knowledgeable in the operation and function of a sprinkler system.

Monthly Inspection

All sprinkler systems shall have a monthly inspection performed by a person knowledgeable in the operation and function of a sprinkler system. The monthly inspection shall consist of the following:

1. Ensuring all gauges on a wet pipe sprinkler system are in good condition and maintaining normal pressure; and
2. Ensuring all **alarm devices** are free from damage and that all electrical connections are secure.

Annual Inspection/Re-Inspection

All sprinkler systems shall have an annual inspection performed by a representative from Environmental Health and Safety Department. This inspection shall be in conjunction with the Fire/Safety Review Program.

The annual inspection of a sprinkler system shall consist of the following:

1. Visually inspecting all sprinkler system pipe hangers for damage or poor condition;
2. Visually inspecting all sprinkler piping to determine if it is in good condition and free from mechanical damage, leakage and corrosion; and
3. Visually inspecting all sprinkler heads within the building to ensure they are free from obstruction, corrosion, paint, **foreign materials** and any physical damage.

All concerns discovered shall be noted on the Fire/Safety Review Report. The Environmental Health and Safety Department representative shall forward a copy of the report to the responsible department as described under the "Authority and Responsibility" section in this policy.

Upon being notified of a concern, the responsible department shall initiate an evaluation of the concern and, if necessary, take steps to resolve the concern.

Testing of Sprinkler Systems

The following provides a description of the required testing for sprinkler systems. All required testing should be arranged by the responsible department.

Acceptance Testing/Upgrades

All sprinkler systems installed in new construction or upgrading of a system shall have an acceptance test completed prior to being placed into service.

Quarterly Testing

All sprinkler system alarm devices such as water flow alarms and pressure switches shall be tested every three months. The testing shall be performed by a person knowledgeable in the operation and function of sprinkler systems.

Criteria for quarterly testing shall be in accordance with Chapter 25 "*Inspection, Testing and Maintenance of Water- Based Fire Protection Systems*" of the National Fire Protection Association code and standards.

Annual Testing

A main drain test shall be performed on sprinkler systems annually to determine if the system is free from obstruction. This test shall be performed by a person knowledgeable in the operation and function of a sprinkler system.

Criteria for main drain testing shall be in accordance with Chapter 25 "*Inspection, Testing and Maintenance of Water-Based Fire Protection Systems*" of the National Fire Protection Association code and standards.

Five-Year Test

Sprinkler system gauges shall be replaced or tested every five years.

The testing, calibration and replacement of sprinkler system gauges shall be performed by a person qualified in the calibration and certification of sprinkler system gauges.

Twenty-Year Test

Where fast response sprinkler heads have been in service for twenty years, they shall be replaced or representative samples shall be sent to a recognized testing laboratory.

A representative sample of sprinkler heads shall consist of two per floor or individual riser, in any case not less than four, or one percent of the number of sprinkler heads per system, whichever is greater.

Where the representative sample of the sprinkler heads fail to meet the test requirements, all sprinkler heads the sample represents shall be replaced by the facilities engineer or contractor.

Test procedures shall be repeated every ten years thereafter.

Fifty-Year Test

Where sprinklers heads have been in service for fifty years, they shall be replaced or representative samples shall be sent to a recognized testing laboratory for operational testing.

If the sprinkler head is going to test instead of replaced, testing shall be performed using the same sampling methodology as indicated in the previous section.

Sprinkler System Obstruction Investigation

An obstruction investigation shall be conducted by the facility's engineer to ensure that sprinkler system piping remains clear of all obstructive foreign matter. An obstruction investigation shall be conducted on sprinkler systems if one of the following conditions exist:

1. Defective intake screens on a **fire pump** taking suction from open bodies of water;
2. Discharge of obstructive material during routine water tests;
3. Foreign materials in fire pumps, dry valves or in check valves;
4. Heavy discoloration of water during drain tests or plugging of inspector's test connections;
5. Plugging of sprinklers;
6. Plugged piping in sprinkler systems dismantled during building renovation projects;
7. Failure to flush yard piping or surrounding public mains following new installation or repairs;
8. A record of broken public mains in the vicinity;
9. Abnormally frequent false-tripping of dry pipe valve(s);
10. A system is returned to service after an extended period of downtime (greater than one year); and
11. There is reason to believe that the sprinkler system contains sodium silicate or its derivatives.

Sprinkler System Flushing Procedure

If an obstruction investigation indicates the presence of sufficient material to obstruct sprinklers, conduct a complete flushing program every five years. The work shall be performed by a person having knowledge in the operation and function of a sprinkler system.

Criteria for sprinkler system flushing shall be in accordance with Chapter 25 " *Inspection, Testing and Maintenance of Water-Based Fire Protection Systems*" of the National Fire Protection Association code and standards.

Classifications of Standpipes Systems

There are three classifications of **standpipe systems**. These classifications are based on whether the fire department or the building occupants are expected to use the standpipe hose. The following describes the three classifications of standpipe systems.

Class I: A Class I standpipe system provides a two and one-half inch hose connection to supply water for use by the fire department and those trained in handling heavy water streams.

Class II: A Class II standpipe system provides a one and one-half inch fire hose connection to supply water for use primarily by the building occupants or by the fire department during initial response.

Class III: A Class III standpipe system provides a one and one-half inch **hose station** to supply water for use by building occupants and a two and one-half inch hose connection to supply a larger volume of water for use by the fire department.

Fire Hose and Fire Nozzles

All Class II and III standpipe and hose systems installed after January 1981 shall be equipped with lined hose. Unlined hose can remain in use on systems installed prior to 1981, but replaced with lined hose when existing hose becomes unserviceable.

All fire hose used on standpipe and hose systems shall be protected from dirt or other physical agents. The protection shall consist of placing the fire hose in a cabinet or by providing a protective cover over the hose.

When the **control valve** for the standpipe system is located within a stairwell, the maximum length of hose shall not exceed 100 feet. If the control valve is located in areas other than the stairwell, the length of hose shall not exceed 75 feet.

All fire hose on Class II and Class III standpipe systems shall be equipped with a shut-off type nozzle.

Testing

All fire hose shall be tested in accordance with Chapter 1962 "*Care, Use, and Service Testing of Fire Hose including Connections and Nozzles*" of the National Fire Protection Association code and standards.

Replacement

If the fire hose or nozzle is found to be inoperable, the responsible department as described under the "Authority and Responsibility" section in this policy shall be responsible for the replacement of the hose or nozzle.

Any fire hose found damaged or considered to be unserviceable should be replaced without delay. The following conditions warrant fire hose replacement:

1. Dry rotted linen or hemp fire hose;
2. Cross threaded couplings;
3. Punctured hose; and
4. Deterioration of the fire hose to the extent that it cannot carry water at the required pressure and flow rates.

Inspection and Testing of Standpipe and Hose Systems

Acceptance Test

All standpipe and hose systems shall have an acceptance test completed prior to being placed into service. All acceptance testing shall be in accordance with Chapter 14 "*Installation of Standpipe and Hose Systems*" of the National Fire Protection Association code and standards.

Annual Inspection

All standpipe and hose systems shall be inspected annually by a representative of Environmental Health and Safety Department during the Fire/Safety Review. The inspection shall consist of checking the standpipe system to assure they are free of:

1. Damage;
2. Corrosion;
3. Foreign material; and
4. Tampering.

The inspection shall also ensure that all main control valves supplying water to the standpipe and hose system are locked in the open position with a chain and sturdy lock.

Acceptance Testing

All fire pumps shall have an acceptance test completed prior to placing the pump into service. The test shall be arranged by the project coordinator in conjunction with the contractor.

Testing and Inspection of Fire Pumps

The criteria for acceptance testing shall be in accordance with Chapter 20 "*Installation of Centrifugal Fire Pumps*" of the National Fire Protection Association code and standards.

Weekly Inspection and Testing

All fire pumps shall have a weekly inspection and the system shall be tested. The inspection and test can be conducted by a facility's engineer or private contractor.

The weekly inspection shall consist of:

1. Ensuring that adequate heat is within the room or area in which the fire pump is located during the cold weather months;
2. Ensuring that the pump suction and discharge valves are fully open;
3. Ensuring that pump gauges read normal operating pressures;
4. Ensuring that the fuel tank is at least two-thirds full on diesel driven pumps;
5. Checking for leaks around piping;
6. Ensuring that the **controller** selector switch is in the "on" position and illuminated; and
7. Ensuring that water supply valves to the fire pump are secured in the open position with a sturdy chain and padlock.

The weekly testing of fire pumps shall consist of the following:

1. Automatically start the fire pump or booster pump in the same manner in which it would start in a fire situation;
2. If the drive unit for the fire pump is an internal combustion engine, run the engine for at least 20 minutes. The engine shall be run at its rated speed;
3. If the drive unit for the fire pump is electric motor driven, the pump shall be run for at least five minutes;
4. If the fire pump is equipped with relief valves ensure they are operating properly; and
5. Ensure that packing for the fire pump are not being overheated.

Annual Inspection and Testing

All fire pumps shall have an annual inspection and test of the system performed by a private contractor knowledgeable in the operations and functions of a fire pump. This inspection and test shall be scheduled by the responsible department as noted under the "Authority and Responsibility" section within this policy.

The annual inspection and testing of fire pumps shall be in accordance with Chapter 25 "*Inspection, Testing and Maintenance of Water-Based Fire Protection Systems*" of the National Fire Protection Association code and standards.

Monthly Review of Chemical Extinguishing Systems

A monthly inspection shall be performed on all fixed chemical-extinguishing systems by a facility's engineer or private contractor with knowledge of the system.

The monthly inspection shall consist of:

1. Ensuring that tamper indicators and seals are in place;
2. Ensuring the pressure gauge shows pressure in the operable range;
3. Ensuring that there are no physical signs of damage;
4. Ensuring nozzle blow-off caps are intact and undamaged on wet chemical extinguishing systems;
5. Ensuring all hose assemblies are connected on carbon dioxide extinguishing systems;
6. Ensuring all **detection devices** are in place and free from foreign matter;
7. Ensuring that manual actuators are unobstructed; and
8. Ensuring the system has a current service tag.

Upon completion of the monthly review, the person performing the review shall place his or her initials and the date the review was performed on the service tag.

If a questionable condition is discovered that would prohibit proper operation of the device, the person performing the review shall immediately contact the responsible department as described under the section "Authority and Responsibility" in this

policy. The responsible department shall contact a trained private contractor to perform the proper maintenance on the system.

Semi-Annual Maintenance

The semi-annual maintenance of a chemical extinguishing system shall be performed by a private contractor trained in the knowledge and operation of the system.

Criteria for semi-annual maintenance of **fixed extinguishing systems** shall be in accordance with the following Chapters of the National Fire Protection Associations code and standards:

- * Chapter 17 " *Dry Chemical Extinguishing Systems*";
- * Chapter 17 " *Wet Chemical Extinguishing Systems*";
- * Chapter 12 " *Carbon Dioxide Extinguishing Systems*";; and
- * Chapter 12A " *Halogenated Agent Extinguishing Systems*".

A copy of the semi-annual maintenance criteria can be obtained by contacting Environmental Health and Safety Department at 543-7262.

Procedures for Taking a Fixed System Out of Service

Before Shutdown

Shutting down fire protection equipment shall be planned. All equipment such as excavating, pipe plugs, repair parts and personnel shall be ready prior to taking the system out of service. The supervisor or his/her designee shall notify Environmental Health and Safety Department of the shutdown. The supervisor shall inform the above departments of the reason for the shutdown and the duration of time the equipment will be out of service.

The supervisor of the employee or his/her designee assigned to shutdown the fire protection system shall obtain a shutdown permit from Environmental Health and Safety Department.

A representative from Environmental Health and Safety Department shall tour the area or building prior to shutting down the fire protection system. The purpose of the tour is to ensure that proper precautions are taken and **hazardous processes** are restricted. If necessary, the Safety Officer shall coordinate with the supervisor to arrange for temporary protection such as charged hose lines, the setting up of temporary sprinkler protection and/or extra extinguishers.

If the project involves any type of cutting, welding or brazing, the supervisor or his/her designee shall obtain a Hot Work Permit. Refer to the Welding, Cutting and Brazing policy, Section 9.2 of this Safety Manual.

If the sprinkler system, standpipe or hose system is restorable, either in whole or as a part, the supervisor shall assign an employee to restore the system promptly in the event of a fire.

Notification

To obtain a fire system shutdown permit, contact a representative from Environmental Health and Safety Department at 543-7262 at least 24 hours prior to the start of the project.

Posting of Permit

When all precautions are taken, the Environmental Health and Safety Department representative shall issue a shutdown permit. The permit consists of three parts and shall be distributed as follows:

1. Part 1 shall be filed with Environmental Health and Safety Department;
2. Part 2 shall be kept by the department administrator;
3. Part 3 shall be placed directly on the fire protection equipment that is impaired.

When the shutdown of a system involves water supply to the building, Environmental Health and Safety Department shall notify the City of Seattle Fire Department as to the reason for **impairment** and the approximate amount of time the water supply will be shut off.

During the Shutdown

During the shutdown of the fire protection equipment, the supervisor of the employee performing the work and the Environmental Health and Safety Department representative shall maintain the following restrictions:

1. Limit the practice of hazardous processes (e.g., usage of open flame, mixing and transferring of chemicals);
2. Restrict smoking within the building; and
3. Restrict cutting, welding or brazing within the building.

Restoring the System

Upon completion of the work, the supervisor of the employee performing the work or his/her designee shall be responsible for:

1. Ensuring that all fire protection is placed back into automatic service;
2. If sprinkler protection was impaired, conducting a two-inch drain test at the sprinkler riser;
3. Ensuring that sprinkler control valves are locked in the open position;
4. Resetting the fire alarm system in normal operating condition;
5. Notifying Environmental Health and Safety Department and Risk Management Department that the system has been restored;
6. Removing the shutdown permit from the equipment and completing the remaining information; and
7. Forwarding the shutdown permit to Environmental Health and Safety Department.

If the shutdown involved water supply to the building, Environmental Health and Safety Department shall notify the City of Seattle Fire Department that the project has been completed and the fire protection has been restored.

Emergency Shutdown

When a system is taken out of service unexpectedly, such as sprinkler pipes breaking or otherwise physically damaged, stabilize the situation and initiate the "*Before the Shutdown*" precautions outlined in the previous section.

Documentation

All testing reports shall be maintained by the responsible department.

Glossary

Alarm Device: A device used to alert occupants and emergency response personnel in the event the sprinkler system activates.

Controller: A component of the fire pump system used to supply energy to the drive unit.

Control Valve: A valve used to control the water supply of a water-based fire protection system.

Detection Device: A device or assembly which operates upon either an increase of temperature, the sensing of an abnormal amount of smoke or combustion products, which in turn activates the fire alarm system.

Employee: Any person hired by the University regardless of the person's job description (e.g., faculty, plant personnel, principle investigators, contractors and sub-contractors hired by contractors) that may be required to or have the need to restrict any fire protection equipment.

Fire Protection Equipment: Any type of equipment used in the extinguishment or suppression of a fire. This equipment includes sprinkler systems, standpipes and hose systems, fire pumps and all fixed extinguishing units.

Fire Pump: A pump that supplies water flow and pressure to a sprinkler system or standpipe system.

Fixed Extinguishing System: A fire protection system designed and approved for use on specific fire hazards they are expected to control and extinguish.

Foreign Material: An object or other material, which may obstruct in the flow of water in a sprinkler or standpipe system.

Hazardous Process: Any type of work that involves an increase to the risk of fire.

Hose Station: A combination of a hose rack, a nozzle, a hose and a hose connection.

Impairment: To diminish or restrict fire protection within a building.

Lock Box: A locked container often used to store building plans or related data. Keys to open these containers are assigned only to select individuals such as the City of Seattle Fire Department and Environmental Health and Safety Department.

Sprinkler System: An integrated system of piping and sprinklers installed in an area or building to suppress or extinguish a fire when activated.

Standpipe System: An arrangement of piping, valves, hose connections and allied equipment installed in a building or structure with the hose connections located in such a manner that water can be discharged in streams or spray patterns through attached hose and nozzles.

9.8 Fire Safety Procedure

Policy

To ensure the safety of staff, faculty and students, the following fire safety procedure has been developed and shall be implemented in fire emergencies.

Fire Response Plan

- **Rescue** people from the immediate area of smoke and/or fire. Make building occupants aware that there is a fire alarm activation and/or actual fire within the building.
- **Activate** the closest fire alarm pull station and contact the University Police at 9-911 when calling from a University telephone or 911 when calling from a non-University telephone. When contacting the University Police, provide your name, location of emergency, telephone number from which you are calling, and the type of emergency you are reporting. If your building is not equipped with a fire alarm system, contact the University Police as prescribed under this section.
- **Contain** the smoke and/or fire by closing all doors to rooms and corridors.
- **Extinguish** the fire using the appropriate fire extinguisher for the type of fire being fought. Refer to Portable Fire Extinguishers, Section 9.6 of this Safety Manual.
- **Relocate** to a safe area outside and away from the building.

Fire Response Procedures

University Police

The University Police dispatcher who receives the fire alarm activation and/or fire call shall determine the exact location of the fire and shall instruct the caller to pull the closest fire alarm pull station if not already activated. At this time, the dispatcher shall notify the Seattle Fire Department Dispatch Center to report the fire.

During all fire alarm activations and/or fire calls, the University Police Officers shall respond directly to the affected area and assist in the first response as necessary. Their primary responsibility shall be to ensure that entry into the affected area(s) is unobstructed for the Seattle Fire Department vehicles and ensure communications are maintained and provided to the Seattle Fire Department with the location of the fire.

Responding University Police Officers shall also ensure that site security is maintained until relieved of the responsibility.

Environmental Health and Safety Department

Once informed of a confirmed fire incident, the "On-Call" Safety Officer shall respond immediately to the incident location. Once on the scene, the "On-Call" Safety Officer shall assume overall authority and is responsible for ensuring that the appropriate fire responses have been implemented. Upon arrival of the Seattle Fire

Department, this authority shall be relinquished to the Commanding Fire Officer. The "On-Call" Safety Officer shall continually assess the fire scene to ensure appropriate measures are taken to avoid danger and risk to personnel in the area.

The "On-Call" Safety Officer shall communicate directly and immediately to the Director of Safety and Parking Services and contact Risk Management in the event of a confirmed fire incident.

The "On-Call" Safety Officer shall conduct and document an evaluation of the fire response. This evaluation shall subsequently be forwarded to all parties who responded to the incident. In addition, the "On-Call" Safety Officer shall be responsible for checking the condition of the fire extinguishers, fire hoses and other fire protection/detection equipment as appropriate after the fire incident location has been secured.

Physical Plant

The appropriate engineering group supervisor shall report directly to the location of the confirmed fire incident. The appropriate engineering group supervisor shall be contact, and dispatch a building engineer to the incident. The building engineer shall monitor all utility systems in the area along with assisting with the fire response as directed by the on-scene commander.

The Physical Plant personnel shall check the condition of the fire extinguishing equipment in the area including portable fire extinguishers, fire hoses and other fire protection/detection equipment as appropriate and replace or repair such items when necessary. The Physical Plant personnel shall also be responsible for ensuring that the fire alarm system is reset at the direction of the individual in command of the fire scene.

Fire Wardens

FIRE WARDEN RESPONSIBILITIES

Fire Wardens are designated for each floor. Fire Wardens will be made knowledgeable about the building and will receive training on the evacuation procedure. In the absence of available Fire Wardens, Security and Public Safety officers will carry out these duties.

The Fire Warden:

1. Will ascertain the location of the fire.
2. Notify the Fire Department. Call 911.
3. Will sound the building alarm (located at each fire exit).
4. Direct all persons to evacuate the floor via the stairway(s) furthest away from the emergency. Elevators are **NOT** to be used.
5. Encourage persons to leave quietly and in an orderly manner.

6. Insure that all disabled persons are assisted in reaching the nearest smoke free stairway.
7. Search all rooms, including restrooms, to insure that all persons are aware of the evacuation. Be especially watchful of persons who may have visual or hearing impairments.
8. Communicate with the Fire Command Station via warden phone and inform of floor conditions.
9. Inform the Fire Command Station of the location of any disabled persons on fire stair landings.
10. If evacuated to the street, keep the front entrance clear to expedite Fire Department response. Prohibit re-entry of the area until allowed by proper authority.

Glossary

Fire Suppression Equipment: All equipment used to extinguish a fire (e.g., sprinkler systems, standpipe and hose systems, portable fire extinguishers)..

Means of Egress: A continuous and unobstructed way of exit travel from any point in a building or structure to a public way.

Operating Condition: The condition maintained for fire suppression equipment to ensure proper operation during the event of a fire.

Plan and Run a Fire Drill

A Step By Step Guideline

1. Create or use an Approved Fire Plan. If one does not exist for the building contact Fire Safety office of EH&S Department at 543-0465 for a sample package. The Plan includes all participants' duties and responsibilities and location of staging areas.
2. Verify that the existing list of Certified Fire Wardens and Assistant Wardens is current. Each Tenant should designate new Fire Wardens or Assistants if necessary. Maintain records of those designated.
3. Make sure all the Fire Wardens and Assistants have received training, are familiar with their duties, which tenants may need assistance, and the location of emergency exits. Further, Fire Wardens and Assistants must communicate the appropriate information to designated personnel during the drill.
4. Conduct a pre-drill meeting with Fire Wardens and Assistant. Review the equipment and tell them what to expect. Verbally walk through a drill. If possible, provide a treat for the tenants after the drill preview, as a method to encourage participation. Provide and review fire drill critique forms with Fire Wardens and Assistants.

5. Should be familiar with their duties and proper use of the equipment. They should also participate in a pre-drill meeting to walk through the drill. This review should include when and what building equipment will be used to test building safety features.
6. Avoid dates that may present conflicts, (i.e., a major tenant has an important meeting, the day before or after a holiday, critical days for tenants.)
7. Provide tenants at least two-weeks written notice of the chosen date. Include instructions and the approximate commencement time and length of fire drill procedures. Present the drill in a positive format. Try to make it fun.
8. On larger buildings consider conducting segmented fire drills, possibly five to 10 floors per day.
9. Notify the local Fire Department to invite their participation. Plan what role the Fire Department will fill. Consider what you will do if the Fire Department cannot attend at the last minute.
10. If any tenants refuse to participate, advise the Fire Marshal if they are on-site.
11. Collect completed fire drill critique forms from Fire Wardens and Assistants, see attached example. Respond to all comments. Share overall evaluation results with Fire Wardens and Assistants. Include what improvements or suggested changes were enacted.
12. Designate an appropriate number of Observers. They will move from floor to floor throughout the drill. Their function is to report what they see, refer to attached example form. Collect completed forms. Address any issues or problems noted.
13. Forward reviews and any other documentation to Environmental Health and Safety Department.

9.9 Fire Safety Review Program

Please note that this program has a glossary. The glossary contains the definitions for various terms used in the program. These terms are highlighted in bold print the first time they appear in the body of the program.

Policy

All buildings shall have an annual fire/safety review performed at the facility.

Exception: Single-family residences do not receive fire/safety reviews. Laboratories receive fire/safety reviews during **Laboratory** Safety Reviews as conducted under the Chemical Hygiene Plan. (Refer to the Chemical Hygiene Plan, Section 5.9)

Authority and Responsibility

Environmental Health and Safety Department is responsible for:

1. Developing a Fire/Safety Review Program;
2. Scheduling and conducting the review with department directors or **facility manager**;

3. Conducting **exit interviews** with department directors or facilities manager following the review;
4. Providing the **responsible department(s)** with a written report;
5. Scheduling and conducting a follow-up review of the building;
6. **Addressing** any **concerns** discovered during the fire/safety review that are the responsibility of Environmental Health and Safety Department; and
7. Reviewing the Fire/Safety Review Program to ensure that the program is in **compliance** with current codes and standards.

The *Building Coordinator* and/or the *Physical Plant* is responsible for:

1. Providing access to all areas and rooms within the building; and
2. Addressing any concerns discovered during the fire safety review that are their responsibility.

Review Guideline

Environmental Health and Safety Department shall send a copy of the Safety Review Guideline to the appropriate authority (e.g., department director, researcher, building coordinator). The guideline shall consist of fire safety codes, and standards and is designed to assist the responsible department in understanding and addressing concerns.

Scheduling

A representative from Environmental Health and Safety Department shall contact the appropriate authority of the building to schedule a fire/safety review. The review shall be conducted during the normal hours of operation unless previously arranged by both parties.

Performing the Inspection

Upon arrival at the area to be inspected, the representative from Environmental Health and Safety Department shall meet with the appropriate authority to inform them that they will be present within the building. The appropriate authority shall accompany the Environmental Health and Safety Department representative or provide keys necessary to gain access to all rooms within the building.

There are several areas the Environmental Health and Safety Department representative will focus attention on during the fire/safety review. These areas will include, but are not limited to:

1. The fire alarm system;
2. Fire extinguishers;
3. Fire suppression systems;
4. Emergency lighting;
5. Means of egress;
6. Electrical;
7. Housekeeping;

8. Hazardous materials;
9. Heating, ventilation and air-conditioning;
10. Fireplaces;
11. Exterior of the building; and
12. Smoking.

Procedures

Each identified concern shall be corrected in accordance with the corrective action dates listed in the Review Summary.

Each department shall ensure that corrective action plans have been implemented or are in process prior to the time frame listed on the Review Summary.

Exit Interview

Upon completion of the review, the representative from Environmental Health and Safety Department shall discuss with the appropriate authority the concerns that were discovered during the review. The corrective action for each concern shall also be discussed during this interview. During the interview, it may become evident that items requiring corrective action, with the exception of immediate concerns, cannot be addressed in the time frame allotted. In this case, the corrective action date shall be changed to indicate the agreed upon time frame.

It may also be necessary to discuss concerns requiring capital funds with the Building Coordinator and/or the Physical Plant.

Fire/Safety Review Report

The Environmental Health and Safety Department representative, who performed the review, shall be responsible for submitting a written report within ten calendar days upon completion of the review. The following information shall be contained within the report:

1. The date the review was conducted;
2. The name and address of the building where the review took place;
3. The name and telephone number of the department director or facility manager;
4. The name of the Environmental Health and Safety Department representative conducting the review;
5. The names of person(s) accompanying the Safety Officer during the review;
6. The ranking of the concerns discovered;
7. The location of the concern;
8. The type of concern discovered;
9. The corrective action for the concern discovered; and
10. The department responsible for addressing the concern.

Follow-up Review

A representative from Environmental Health and Safety Department shall schedule a follow-up review of the building with the appropriate authority. The purpose of this follow-up review shall be to ensure that the responsible departments are addressing the concerns discovered during the fire/safety review.

Upon completion, a written report, as described in the Fire/Safety Review Report section of this policy, shall be submitted within ten calendar days.

The follow-up review shall not only document the status of previously noted concerns but the report shall also note any newly discovered concerns.

Record keeping

Environmental Health and Safety Department shall maintain a copy of the fire/safety review report.

Glossary

Address: To deal with and/or to rectify.

Compliance: The act or process in fulfilling official requirements (codes, standards, etc.).

Concern: Does not meet the required codes, standards or regulations.

Exit Interview: A meeting held after the inspection with responsible departments to discuss the concerns discovered during the inspection.

Facility Manager: A person(s) responsible for a building and under the direction of the Department Director.

Laboratory: A facility where the "laboratory use" of hazardous chemicals occurs (relatively small quantities of hazardous chemicals are used in a non-production basis).

Ranking: A system used in sorting the concerns in order of severity.

Residential Properties: A property owned by the University used for single families (e.g., rental properties used for student and faculty living).

Responsible Department: A department that will be required to correct or address a concern discovered within their area or building.

Section 10: Laser Safety

10.1 Laser Safety Manual

UW EH&S maintains a Laser Safety Manual online at
<http://www.ehs.washington.edu/manuals/rsmanual/laserindex.shtm>.

Any and all guidance, procedures, guidelines, and requirements put forth by UW EH&S supercede the information contained herein.

10.2 Emergency procedures for laser equipment

EMERGENCIES OR INCIDENTS INVOLVING LASERS

In the event of an accident or unusual incident involving a laser:

1. TURN OFF THE LASER.
2. If there is a serious injury or fire, call 9-911 and request paramedics or the fire department.
3. Notify the Safety Office (206-543-0463). If after working hours, call 9-911.
4. Notify the laboratory supervisor or Principal Investigator.

10.3 Laser classification

LASER CLASSIFICATION

Lasers and laser systems are classified by potential hazard according to a system described in the American National Standards Institute (ANSI) standard Z136.1, and in 21 CFR part 1040. A laser's classification is based on several factors including its wavelength, power output, accessible emission level, and emission duration. The level of hazard associated with each class of lasers is listed below.

CLASS 1

Lasers in this class are incapable of causing eye damage. These lasers are exempt from labeling requirements.

CLASS 2

Lasers in this class emit visible light only. They are only capable of producing eye damage if the beam is stared at directly for longer than the normal human aversion response time to bright light (0.25 second). This means a person would naturally turn away from the beam before any damage is done.

CLASS 2a

This is a special category of class 2 lasers, which are not hazardous if viewed directly for up to 1000 seconds. Supermarket barcode scanners are in this class.

CLASS 3a

Lasers in this class are capable of causing eye damage from short-duration (< 0.25s) viewing of the direct beam.

CLASS 3b

Class 3b lasers are capable of causing eye damage from short-duration (< 0.25s) viewing of the direct or specularly- reflected beam. Diffuse reflections from these lasers are generally not hazardous, except for intentional staring at distances close to the diffuser.

CLASS 4

Lasers in this class are high powered and capable of causing severe eye damage with short-duration exposure to the direct, specularly reflected, or diffusely-reflected beam. They are also capable of producing severe skin damage. Flammable or combustible materials may ignite if exposed to the direct beam.

EMBEDDED LASERS

A laser system of one class may contain a laser of a higher class. For example, a class 3a system might contain a class 4 laser in an interlocked protective housing which incorporates design features to limit the accessible emission level to the class 3a level.

LASER CLASSIFICATION

Laser safety standards are guided by the laser classification system described in the ANSI standards (Z136.1). ANSI standards cover lasers operating in wavelengths

within the 180 nm and 1 mm range. Determination of laser class is based primarily upon the intensity of the emitted beam. This classification reflects the level of potential injury to the operator and personnel associated with its operation. Safety standards for lasers depend upon their classification, which is based on their optical emission. Classification of all lasers requires the following parameters:

- a. Wavelength(s) or wavelength range,
- b. Average power output and limited exposure duration (T_{max}) within an eight-hour working day (3×10^4 s.) inherent in the design or intended use of the laser (required for both continuous wave (cw) and repetitively pulsed (scanned) lasers), and
- c. For pulsed lasers, the total energy per pulse (or peak power), pulse duration, pulse repetition frequency (prf), and emergent beam radiant exposure.

In addition to these general parameters lasers are classified in accordance with the accessible emission limits (AEL). AEL is the maximum accessible level of laser radiation permitted within a particular class.

Class I. Exempt Lasers

Exempt lasers or laser systems are those, which cannot, under normal operating conditions, produce a hazard, even for the maximum possible exposure duration inherent in the design or intended use of the laser. Within this class fall all lasers that cannot emit accessible laser radiation levels in excess of .4 microwatts (μW .)

Class II. Low-Power Visible Lasers

Visible continuous wave lasers which can emit accessible radiant power exceeding the Class I accessible emission limit (AEL) for the maximum possible duration inherent in the design of the laser or laser system (0.4 microwatts for an emission duration greater than 3×10^4 seconds) but not exceeding 1 mW. Because of the human aversion response, low-power visible Class II lasers (bright radiant sources) do not normally present a potential hazard, unless viewed directly for extended periods of time.

Some visible repetitively pulsed and cw lasers or laser systems may be designated as Class IIa, if the laser is to be used in a manner where the output beam is not intended to be viewed in normal use. The accessible Emission Limit for Class IIa is based upon a maximum exposure time of one thousand (10^3) seconds.

Class III. Medium-Power Lasers.

Class IIIa. Lasers and laser systems having an accessible output power between 1 and 5 times the lowest appropriate Class III accessible emission limit, and which does not exceed the appropriate MPE as measured over the limiting aperture are designated Class IIIa. For visible lasers the lowest Class III AEL is 1.0 mW, hence the Class IIIa

output may range from 1.0 to 5.0 mW. Class IIIa lasers normally would not be a hazard if viewed directly. This includes intrabeam viewing of specular reflection.

Class IIIb. Laser or laser systems that can be a hazard if viewed directly. This includes intrabeam viewing of specular or diffuse reflections. Such lasers may cause a fire and present skin hazards. Any continuous wave (CW) laser above 5 mW visible output and less than or equal to 500 mW output power are designated Class IIIb lasers. They do not normally produce a hazard if viewed directly with an unaided eye for momentary periods of .25 seconds. They may present a hazard if viewed with collecting optics. All Class III lasers not meeting Class IIIa criteria are designated as Class IIIb lasers.

Class IV. High-Power Lasers

Lasers and laser systems which can emit: a) an average accessible radiant power of 0.5 W or greater for periods greater than 0.25 seconds or b) a radiant exposure of 10 J/cm², or that required to produce a hazardous diffuse reflection for periods less than 0.25 seconds. These lasers present a hazard not only from the viewing of the direct beam or specular reflections, but also from the diffuse reflections. Such lasers may also present a fire hazard.

10.4 Laser Associated Hazards

LASER HAZARDS

EYE

Different structures of the eye can be damaged from laser light depending on the wavelength. Retinal burns, resulting in partial or complete blindness is possible in the visible (400 - 700 nm) and near-infrared (700 - 1400 nm) regions. At these wavelengths, the eye will focus the beam or a specular reflection on a tiny spot on the retina. This focusing increases the irradiance of the beam by a factor of about 100,000.

Laser emissions in the ultraviolet (< 400 nm) and far-infrared (> 1400 nm) regions are primarily absorbed by and cause damage to the cornea. In the near-ultraviolet range (315 - 400 nm), some of the radiation reaches the lens of the eye.

SKIN

Skin damage can occur from exposure to infrared or ultraviolet light. For infrared exposure, the results can be thermal burns or excessively dry skin depending on the intensity of the radiation. In the 230 - 380 nm range of ultraviolet light, erythema (sunburn), skin cancer, or accelerated skin aging are possible. The most damaging region of ultraviolet is 280 - 315 nm, also known as UV-B.

ELECTRICAL

Many lasers contain high-voltage components, which can present a potentially lethal hazard. Proper lockout procedures should be followed when working on high-voltage components. (See the Lockout/Tagout Program, section 3.2).

FIRE

Many class 4 lasers are capable of igniting combustible materials. Care should be taken when choosing beam stops and shielding material.

HAZARDOUS MATERIALS

Laser laboratories contain many of the same hazards found in many chemical laboratories and therefore the same precautions should be taken (See the Chemical Hygiene, section 5.9). In addition, most laser dyes are considered to be hazardous materials and should be handled accordingly. Laser interactions with certain materials may produce toxic fumes, which must be properly vented.

ASSOCIATED HAZARDS

It must be recognized that potential hazards exist with the operation of lasers. It is also important to understand that with the appropriate control measures, these hazards can be eliminated or at least greatly reduced. The safe use of lasers calls for the identification of the potential hazards and for the evaluation of the degree of the potential effects upon the operators of a laser system. Several factors affect the existence of hazards associated with a laser or laser system.

Features of a laser device such as power output, beam diameter, pulse length, wavelength, beam path, beam divergence, and exposure duration, determine the capability of the laser for injuring personnel, that is, the potential of injury of a laser is determined by its classification and therefore the control measures are also determined by the laser classification. After August 1976, the classification of commercial lasers must be provided by the manufacturer in accordance with the Federal Laser Product Performance Standard (21 CFR § 1040). The classification of all lasers must be determined by the LSO. Additionally, the nominal hazard zone (NHZ) associated with the laser or laser system shall be determined. The NHZ relates to the space within which the level of direct reflected, or scattered radiation during normal operation exceeds the appropriate MPEs. It is determined from characteristics such as power or energy output, beam diameter, wavelength, beam divergence, etc. For in depth information you should contact your LSO (if available) and/or read Section 8 and tables 5,6, and 7 of the ANSI Z136.1. Potential hazards exist to all personnel working near a laser system. All individuals working in such areas must be warned of the existence and location of such devices. They must be informed of the meaning of the warning labels for all classes of lasers. In general the types of personnel in the surroundings of the laser determine the hazard evaluation. Access to the laser devices must be limited. Individuals incidentally transient through the laser area must be warned by visible means of the existence of the laser operation. Operators or users of lasers must have the proper basic knowledge of the laser system

they are operating, as well as the proper training required for the particular type of laser.

Particular attention must be given to the environment where the laser is used. This factor should be considered together with the class and application of the laser for determining the control measures to be applied (See table 3). Basic elements to be considered are:

- a. Number and class of lasers,
- b. Location,
- c. Presence (access) of uninformed, unprotected personnel,
- d. Permanence of beam paths,
- e. Presence of objects that may have specular surfaces or reflecting objects in or near the beam path, and
- f. Use of optical devices such as lenses, microscopes, etc.

Most accidents involving the use or operation of lasers are not due to the laser beam itself, but are due to the associated hazards. In the research laboratory there are hazards due to other equipment items and accessories; some of these hazards are described below. Eye and skin damage is the most prevalent human health hazard.

Industrial Hygiene Hazards

Potential hazards are always associated with laser systems and their accessories. Ancillary hazards can be produced by compressed gas cylinders, cryogenic and toxic materials, and carcinogenic agents, such as the dyes used for dye laser systems. MSDS information on these dyes must be made available by the manufacturer and supplied to EHS. Noise produced in some pulsed lasers, such as CO₂ type lasers, can cause tissue shredding.

Ionizing radiation may also be produced. Adequate ventilation shall be installed to avoid the accumulation of toxic or hazardous fumes and vapors produced as a result of the laser use.

Explosion Hazards

Laser targets may shatter during their operation and therefore they shall be enclosed to avoid injuries. Bulbs and high-pressure arc lamps, filament lamps, and laser welding equipment shall have explosion proof housings or protection to withstand the pressures resulting from lamp disintegration.

Potential explosion hazards due to gas mixing in catheters can occur with some surgical procedures.

Non-Laser optical radiation hazards

Ultraviolet radiation emitted from laser discharge tubes, pumping lamps and laser-welding plasmas shall be suitably shielded to reduce exposure to levels below TLV's.

Collateral radiation

Radiation other than laser radiation associated with the operation of a laser system, such as radio frequency (RF) radiation associated with some plasma tubes and x-ray emission associated with high voltage power supplies are potentially very dangerous and shall be kept below the necessary protection guides (29 CFR 1910.96).

Electrical Hazards

Most accidents in laser related activities are caused by deficiencies in the electrical systems. Some of these include uncovered and/or non-insulated terminals, absence of functioning lights (power ON-OFF), and defective outlet receptacles lacking proper grounding. A crowded workplace also may present a problem. A number of potentially energized components and grounded structures present a high potential for an accidental shock. The intended application of the laser equipment requires specific electrical installation and connection to the power supply. All equipment shall be installed in accordance with the National Electric Code and the Occupational Safety and Health Act.

BEAM RELATED HAZARDS

Improperly used laser devices are potentially dangerous, and effects can range from mild skin burns to irreversible injury to skin and the eye. The biological damage caused by lasers is produced through thermal and photochemical processes. The thermal process results from denaturation of tissue proteins due to temperature rise following absorption of laser energy.

Thermal damage is generally associated with lasers operating at exposure times greater than 10 microseconds and in the wavelength region from the near ultraviolet to the far infrared (0.315-103 μm). The thermal reaction in tissues to absorbed radiant energy is strongly dependent upon both duration and area of the exposure. Laser-induced skin lesions are not different from any localized thermal wound and should receive similar medical treatment.

Skin

The effects of laser radiation on the skin range from mild burns due to acute exposure to high levels of optical radiation, to aging, to potential carcinogenesis due to exposure to specific ultraviolet wavelengths. The large surface area of the skin makes it readily accessible to both acute and chronic exposures to various forms of optical radiation, which can produce varying degrees of skin damage. Some individuals are photosensitive, or may be taking prescription medication that induces photosensitivity. Particular attention must be given to the effect of these (prescribed) drugs such as some antibiotics and fungicides in relation to the individuals taking these drugs.

The Eye

The primary hazard associated with laser radiation is exposure to the eye. Ocular hazards represent a potential for injury to several different structures of the eye, depending upon which structure absorbs the most radiant energy per volume of tissue. This is more important in the visible and near infrared spectral regions (0.400 to 1.400 μm) because retinal effects are possible in this range. There are, however, other

serious potential hazards in other spectral regions. Photochemical processes are usually involved in the effects of ultraviolet radiation on the retina, since the retina is the structure of the eye that absorbs the light. It contains the neural receptors, which initiate the vision process. The fovea is the portion of the retina most sensitive to detail and which discriminates color. The location of energy absorption in the eye determines the gravity of a retinal injury. An injury to the fovea will severely reduce ability to resolve visual detail. Permanent blindness can result from a laser exposure lasting only a fraction of a second. Phototoxic and photosensitizing drugs or chemicals may greatly enhance the effects of lasers operating in the ultraviolet and/or visible wavelength regions.

The "Plume"

This is a term used to refer to the "cloud" of contaminants created when there is interaction between the beam and the target matter. ANSI 136.1 calls it Laser Generated Air Contaminants. These contaminants are produced with Class IIIb and Class IV lasers. They range from metallic fumes and dust, chemical fumes, organic solvents, polycyclic aromatic compounds, and Hydrogen Cyanide, to volatile mutagens and aerosols containing biological contaminants. This situation requires strict industrial hygiene solutions, and effective such as appropriate ventilation mechanisms and ultimately the necessary personal protective equipment for the laser operator and the individuals associated with the laser area. Tables 1 and 2 in this paper present a summary of the biological effects from laser radiation on the eye and skin.

10.5 Laser Hazards Prevention

GENERAL

This section describes administrative, procedural and engineering measures, which can reduce the chance of a laser-related incident. These measures should be considered when evaluating a class 3 or 4 laser facility. Although some items are appropriate for all facilities (e.g. posting proper warning signs), others may not be practical for some operations.

BEAM CONTROL

Enclose as much of the beam path as possible. If practical, the entire beam path should be enclosed. As a minimum, beam stops must be used to ensure no direct or specularly reflected laser light leaves the experiment area.

Laser beams should be limited to a horizontal plane that is well below or well above normal eye level. Securely fasten the laser and all optics on a level, firm, and stable surface.

REFLECTIONS

Remove unnecessary reflective items from the vicinity of the beam path. Do not wear reflective jewelry such as rings or watches while working near the beam path.

Be aware that lenses and other optical devices may reflect a portion of the beam from their front or rear surfaces.

Avoid placing the unprotected eye along or near the beam axis. The probability of a hazardous specular reflection is greatest in this area.

POWER LEVEL

Operate a laser at the minimum power necessary for any operation. Beam shutters and filters can be used to reduce the beam power. Use a lower power laser when possible during alignment procedures.

SIGNS AND LABELS

The entrance to a class 3b or 4 laser facilities must be posted with the appropriate warning sign. Each laser must be labeled as required by 21 CFR part 1040. These labels show the classification of the laser and identify the aperture(s) where the laser beam is emitted. Signs and labels may be obtained through the Safety Office.

WARNING DEVICES

Class 4 laser facilities where the beam is not fully enclosed should have a visible warning device (e.g. a flashing red light) at the outside of the entrance, which indicates when a laser is in operation.

CONTROL OF AREA

Except for fully enclosed and interlocked systems, an authorized user must be present or the room kept locked during laser operations.

INTERLOCKS

Many laser systems have interlocked protective housings, which prevent access to high-voltage components or laser radiation levels higher than those accessible through the aperture. These interlocks should not be bypassed without the specific authorization of the Principal Investigator. Additional control measures must be taken to prevent exposure to the higher radiation levels or high voltage while the interlock is bypassed.

PERSONAL PROTECTIVE EQUIPMENT

Eye protection designed for the specific wavelength of laser light should be available and worn when there is a chance that the beam or a hazardous reflection could reach the eye. Protective eyewear should be marked by the manufacturer with the wavelength range over which protection is afforded and the minimum optical density within that range. Eyewear should be examined prior to each use and discarded if there is damage, which could reduce its effectiveness.

Protective eyewear generally will not provide adequate protection against viewing the direct beam of a high- powered laser. Wearing protective eyewear should not be used as an excuse for performing an unsafe procedure.

HAZARDS PREVENTION

Laser safety standards classify lasers based upon their hazard potential, indexing optical emission to control measures commensurate with the relative hazard classification. Since the purpose of any laser safety program is to prevent the hazards inherent to the lasers; concepts such as MPE, AEL, and NHZ, are of vital importance for the operator to understand, and apply.

Maximum Permissible Exposure (MPE) is the level of laser radiation to which a person may be exposed without hazardous effects or adverse biological changes in the eye or skin. MPE is specific for each particular laser and can be found in the ANSI 136.1 standards, tables 5,6, and 7. MPE is a necessary parameter in determining three other important parameters and:

- a. Accessible Emission Level (AEL)
- b. Optical Density (OD) and,
- c. Nominal Hazard Zone (NHZ)

Accessible Emission Level (AEL) is one parameter used to determine the laser classification. $AEL = MPE \times \text{AREA OF LIMITING APERTURE}$

Optical Density (OD) (Absorbance) is used in the determination of the appropriate eye protection.

Where H_0 is the radiant exposure.

Nominal Hazard Zone (NHZ) describes the space within which the level of direct reflected or scattered radiation during normal operation exceeds the applicable MPE. Exposure levels beyond the boundary of the NHZ are below the appropriate MPE level. (ANSI. Z 136.1-1986)

Where a is the diameter of emergent laser beam measured in centimeters.

MPE, OD, and NHZ evaluation and calculation will be affected by several factors:

1. Aversion Response criteria to visible lasers (.25 s),
2. Near Infrared Criteria,
3. Diffuse viewing, 4. Daily Occupational Exposure Criteria.

Responsibilities (laser)

The success of a laser safety program requires cooperation. The Principal Investigator (Supervisor) and the laser operator are vital to the program. Communication and cooperation among the LSO, the Purchasing Office, the Supervisor and the Operators are crucial to the success of this program.

The Laser Safety Officer (LSO) has the following responsibilities:

- a. Coordinate and approve purchases and acquisition of laser devices or laser systems throughout the University.
- b. Obtain State registration forms (where applicable) for lasers, and register all lasers as required, used within the University. The LSO maintains all documentation for lasers, their operators and their regulatory compliance. Similarly, the LSO keeps records of accidents and reports them to the appropriate State office.
- c. Coordinate and assure compliance of all lasers with ANSI standards, all federal and state regulations.
- d. Carry out periodic safety inspections of laser areas and laser devices, to assure compliance with the safety practices and procedures outlined by a laser safety program, according to current standards and regulations.
- e. Recommend necessary changes in safety rules, regulations and procedures as laser technology develops.
- f. Provide basic training, educational material and proficiency tests (when required) for personnel working with lasers.
- g. Supervise the educational and enforcement aspects of this safety program.
- h. Authorize personnel to use lasers or laser systems, after a basic safety-training course.
- i. Coordinate compliance with University requirements for medical surveillance of laser users and maintain records of these examinations.
- j. Inspect and approve laser facilities before laser operation begins.
- k. Assist the Principal Investigator and/or the laboratory supervisor in the implementation of appropriate safety measures.
- l. Review and approve the SOP, which is provided by the supervisor or principal investigator.
- m. Maintain up-to-date inventory of all lasers at the University.

The responsibilities of other individuals such as, Principal Investigators, users, safety committee, etc. are not explained in this paper but are very obvious and it depends on the laser safety officer to make sure that this key individuals comply with the standards set by his or her safety program.

Medical surveillance

MEDICAL SURVEILLANCE PROGRAM

Prior to assignment to any laser activity, operator of any laser class IIIb and IV must have a medical examination, which should include:

- Review of Occupational history, past exposure to laser and welding.
- Review of the general past eye history (and family eye history)
- Review of current and past medications, which might cause photosensitization.
- Review of general health, with special emphasis upon diseases, which can give ocular or skin problems.
- Visual acuity tests.
- External ocular examination, including cornea and iris.
- Examination of the ocular fundus (including photograph, if necessary)

At termination of employment or permanent reassignment to non-laser related duties, the laser Operator must undergo an exit medical examination, which should include:

- External optical examination, including cornea and iris.
- Examination of ocular fundus (including photograph, if necessary)

An additional eye examination should be performed immediately after any incident or suspicion of accident in which exposure to the eye may have occurred. Results of all medical examinations must be filed with EH&S.

Section 11: Safety Inspections

11.1 Inspection by Authorities

Policy

Outside regulatory agencies and insurance representatives requesting to inspect University properties or program implementation to determine compliance with regulations pertaining to fire, workers compensation, safety, health and environmental issues shall be directed to UW Environmental Health and Safety.

A representative from Environmental Health and Safety shall accompany the representative from the outside agency on all inspections conducted and facilitate the necessary corrective action plan.

These inspecting agencies include, but are not limited to, the following:

- * Occupational Safety and Health Administration (OSHA);
- * City of Seattle - Fire Department;
- * Environmental Protection Agency (EPA);
- * Washington State Department of Ecology;
- * Washington State Fire Marshal;
- * Fire Insurance Representatives; and
- * Workers Compensation Consultant.

The appropriate administrative department shall be advised of the inspections and copied on all inspection related data. Agency requests for inspection related records or data should be cleared with Administration.

11.2 University of Washington EH&S Department

University of Washington strives to provide a safe and healthful environment for its faculty, staff, students, and guests. The University has a major responsibility to educate tomorrow's leaders and believes that pro-active environmental management is a fundamental component in educating our students. The University endeavors to be in compliance with laws and regulations protecting the environment, and the health and safety of the campus community. The University is committed to the protection of human health and the environment by integrating environmental stewardship into education, research, administration, and all activities of the University. It is the responsibility of every individual and unit at all levels of the University to achieve these objectives.

The Department of Environmental Health and Safety (EH&S) charge is the development, and implementation of programs that protect the environment, provide a safe and healthful work place and comply with all applicable laws and regulations.

1. Members of EH&S will serve as consultants to deans, directors, heads of both academic and administrative units, faculty, staff members, and students in matters of environmental health and safety.
2. EH&S will conduct safety audits and/or investigations as required, and will aid departmental safety committees in establishing intra-departmental safety programs, safety training and education.
3. EH&S will provide technical assistance in ascertaining potential health and safety hazards.
4. EH&S will provide code interpretations for current operations and for future facilities being planned as requested. EH&S will maintain necessary code reference materials, and will assist in the interpretation of the code.
5. EH&S will conduct campus inspections on the environmental health and safety aspects of the University's operation and facilities. All inspection reports will be submitted to the Office of the President. The Office of the President will submit the report to the appropriate department.
6. The Director of Environmental Health and Safety reports directly to the Vice President for Student Affairs and Campus Services.

Phone No. of EH&S 206-543-7262

Fax No. of EH&S 206-543-3351

11.3 CEE Department Administration

In all emergencies call 9-911. This should include all items related to life safety emergencies or personal injury.

During the evening hours or on weekends it is strongly recommended that you notify the Campus Police 9-911 regarding strangers who seem to be wandering around the building.

You are advised to protect your personal property by locking your laboratory or desk - do not leave wallets or pocketbooks unprotected.

Please report to the Building Coordinator (J. Sean Yeung) at 206-543-2547 any items of a safety or security nature (broken locks, burned out lights, floods, etc.). During non-business hours, building emergencies should be reported directly to the Facilities Emergency line at 206-685-1411. Please notify the Building Coordinator on the next business day to ensure proper follow-up. You should familiarize yourself with the location of safety equipment -- eyewash baths, showers, air packs, fire extinguishers, fire alarms, etc.

11.4 Laboratory Safety Review Program

Policy

All laboratories shall be reviewed as required by relevant safety, health and environmental regulations. Reviews shall be conducted by representatives of Environmental Health & Safety Department. For more information, please see: <http://www.ehs.washington.edu/psoinfofor/labstaff.shtm>

Frequency

All laboratories shall be reviewed at least annually. Safety concerns identified during the initial laboratory review shall be corrected and re-evaluated during a follow-up inspection within 90 days. All concerns shall be tracked until corrective actions have been completed.

Procedure

Laboratories shall be reviewed in accordance with the procedure set forth below.

1. Department administrative shall be contacted by Environmental Health & Safety Department at least two weeks prior to the proposed review date(s). During this meeting, concurrence on review dates and affected laboratories shall be discussed as well as other necessary information to ensure all laboratories and support spaces will be reviewed.
2. During laboratory reviews, a laboratory representative should be present to observe and provide additional information and clarification.
3. At the close of each laboratory review, an exit interview highlighting the issues, which were identified in the laboratory, shall take place.
4. Laboratory review results shall be provided within ten working days of completion of a particular building's review.
5. Summary results by building and/or department shall be distributed to the respective department administrative.

Each identified concern shall be corrected in accordance with the corrective action dates listed in the laboratory's Review Summary.

Department shall ensure that corrective action plans have been implemented or are in process prior to the time frame listed on the Review Summary.

11.5 LAB SAFETY CHECKLIST

General Safety



Notice Board(s) with Emergency Call list and hazard warning labels are posted at lab entrance(s)



UW Laboratory Safety Manual including SOPs and lab safety maps are kept in the lab



Lab personnel are trained in emergency procedures



A **Chemical Spill Kit** is available in each lab housing liquid chemicals



A **First Aid Kit** is readily accessible



Accidents and exposures are reported to the supervisor and properly documented



Fire Extinguisher is available



A Safety Shower is readily accessible to lab personnel



A plumbed Eyewash unit is readily accessible to lab personnel



Airfoils and slots on chemical fume hoods are unobstructed; side panels are in place



Vacuum pumps are equipped with a belt and pulley guard (if applicable)



Lab equipment is safely operated and maintained according to manufacturers directions

Personal Protective Equipment (PPE), Housekeeping, and Hygiene:



PPE e.g., gloves, safety glasses/goggles, lab coats, etc. is available (stored clean and in good repair) and worn for the activities being conducted



Cryogenics are handled with the appropriate PPE



Hearing protection is worn for high noise areas (e.g. sonicators, grinders)



Full coverage shoes with good sole grips are worn in the lab; no open-toed shoes (sandals) are allowed



Lab personnel are aware that contact lenses should not be worn in the labs



Respirator wearers are trained, fit tested, and registered with EH&S



Walkways and means of egress and safety equipment are clear of obstructions



Work surfaces and benches are free of clutter to reduce risk of spills and accidents



Storage of chemicals and equipment in chemical fume hoods is kept to a minimum



Spills are cleaned up promptly



Mechanical pipetting devices are used; pipetting by mouth is not allowed



Food and beverages are not permitted in the lab working area



Food and beverages are not stored in the lab refrigerators/freezers



Refrigerators are labeled as to content, e.g., "flammable storage" (must be fire or explosion proof); "non-flammable storage only;" "no food."











Contaminated PPE is removed before leaving the lab







Chemical Safety:













All outdated and unused chemicals are disposed of in a timely manner through EH&S

-  Proper storage procedures are followed for all chemicals including labeling, capping/sealing, and proper container type/condition
-  Liquid chemicals are stored below shoulder height
-  Liquid and dry chemicals are stored separately
-  Organic and inorganic chemicals are stored separately
-  Acids and bases are stored separately
-  Corrosives are stored away from metals, flammables, and oxidizers
-  Proper dating/storage/use/disposal procedures are followed for perchloric acid
-  Proper dating/storage/use/disposal procedures are followed for peroxide forming compounds





Lab waste disposal:

-  Lab personnel are trained in hazardous waste management: Please visit the EH&S Hazardous Materials Management page
-  All hazardous waste containers are properly labeled with yellow EH&S labels
-  Hazardous waste containers are properly sealed
-  A Hazardous Waste Satellite Accumulation Area is designated and the requirements are posted
-  Biological Waste is decontaminated and disposed of properly
-  Broken glass is separated from regular waste stream and labeled as such
-  Needles and syringes are disposed of in red sharps box and disposed of properly







Compressed gases:

-  Compressed gas cylinders are adequately secured
-  Gas cylinders are transported by hand truck, secured and capped
-  The Department Compressed Gas Rules are posted in a prominent location in the lab
-  Cylinders are stored by compatibility, e.g., Hydrogen away from oxygen
-  Special precautions are used for storing and handling toxic gases
-  Cylinders are stored away from heat sources
-  The regulator connection is leak tested after installation and before use
-  Cylinders are capped or have regulators attached at all times
-  All cylinders are labeled for content
-  Hydrostatic tests are current (cylinders have not been stored more than 5-10 years)





Electrical Safety:

-  Access to circuit breaker panel is unobstructed
-  Openings on breaker panel, receptacle boxes, etc. are sealed
-  Ground Fault Circuit Interrupters (GFCI) are used near sinks and wet areas
-  Electrical cords are checked periodically for fraying or damage
-  Extension cords are used only for temporary use with portable equipment





Fire Safety:

-  Fire Extinguisher is available
-  Large metal drums of flammable liquids are grounded and bonded together during transfer
-  A maximum of 10 gallons of flammable liquids are stored in a lab; the excess is stored in a safety cabinet or safety cans up to a maximum of 50 gallons total
-  Flammable liquids over 1 gallon are stored in safety cans
-  Sprinkler heads are not obstructed
-  Vents on flammable storage cabinets are sealed or vented to the outside with metal pipe

Drug Enforcement Agency (DEA) controlled substances:



-  DEA controlled substances are used with the proper permit
-  DEA record keeping is kept in order
-  DEA substances are stored in a secure location
-  Proper disposal method of DEA substances is used

Biological Materials: Is the following research registered with EH&S Biological Safety Office?

-  Recombinant DNA experimentation
-  Bio-Safety Level (BSL) of 2 or 3
-  State or federally regulated materials
-  Acute toxins (LD50 of ≤ 100 μ g/kg)
-  Cell lines: human primary; transformed w/viruses; tumorigenic in humans

Radiation Safety: Please visit the EH&S Radiation Control page

Record keeping:

-  Chemical Hygiene Plan records
-  Material Safety Data Sheets (MSDS's)



A complete chemical inventory



Bloodborne Pathogen Program/Exposure Control Plan



DEA records



Appropriate safety manuals e.g., UW Laboratory Safety Manual, UW Biological Safety Manual, UW Chemical Waste Management Guide, etc.

11.6 Biosafety Checklist

Biosafety Level 2	Yes	No	N/A	Comments
<i>A. Standard Microbiological Practices</i>				
1. Access limited at when experiments in progress (discretionary)				
2. Persons wash hands after work w/ cultures & removing gloves, before leaving lab				
3. Eating, drinking, storing food, etc. prohibited				
4.. Mouth pipetting prohibited; pipetteors used				
5. Sharps policies in place				
6. Splashes & aerosols are minimized				
7. Work surfaces disinfected 1x per day and after spills, disinfectants effective				
8. Regulated waste disposed properly.				
9. Insect & rodent control program in place.				
<i>B. Special Practices:</i>				
1. Lab access restricted when working with infectious agents.				
2. Policies so that persons advised of hazards & have required immunizations.				
3. Biohazard sign must be present:				

agent, BSL, PPE, exit require., name, phone.				
4. Lab personnel receive appropriate immunizations & tests for agents handled.				
5. Baseline serum collected, as appropriate.				
6. Biosafety manual adopted. Persons informed of special hazards.				
7. Director ensures personnel receive appropriate training & annual updates.				
8. Sharps precautions: needles, slides, pipettes, cap. tubes, scalpels:				
a. Sharps restricted to use when no alternative exists.				
b. Needles are integral to syringe and not recapped, bent, etc.				
c. Safe needle devices used where appropriate.				
d. Broken glassware handled by mechanical means.				
9. Specimen containers leak proof and covered during transport.				
10. Equipment & work surfaces disinfected regularly, after work w/ agents, after spills.				
11. Spills & accidents reported to lab director. Medical follow-up as appropriate.				
12. Animals not involved in work not permitted in lab.				
<i>C. Safety Equipment (Primary</i>				

Barriers)				
1. Biosafety cabinet (Class II) and other containment devices or PPE used when:				
a. Potential for aerosols or splashes exist.				
b. High concentrations or large volumes of agents are used.				
2. Face protection used for work outside BSC that may generate splashes.				
3. Lab coats worn and removed prior to leaving lab. Laundered by the institution.				
4. Gloves worn when working with agents. Alternatives to powered latex available.				
D. Laboratory Facilities (Secondary Barriers)				
1. Provide lockable doors for restricted agents.				
2. Locate new labs away from public areas.				
3. Labs have hand wash sink				
4. Easily cleaned. No carpets or rugs				
5. Bench tops impervious to water and resistant to chemicals				
6. Lab furniture is appropriate for loading and use. Spaces accessible for cleaning				
7. BSC's located away from doors, heavily traveled areas, etc, to maintain airflow.				

8. Eyewash readily available.				
9. Illumination is adequate, avoiding glares and reflections				
10. Negative airflow recommended. Windows have fly screens.				
11. Are autoclaving procedures verified? Yes No If yes, explain how?				
E. Training of Personnel				
Documented lab safety training?				
Documented Bloodborne pathogens/biosafety training?				

<i>BSL 2+</i>	Yes	No	N/A	Comments
1. BSL 3 Standard practices, Special practices, Safety Equip followed.				
2. Negative airflow into laboratory.				
3. Access is restricted when work is in progress.				
4. Exhaust air is discharged to outside.				

ADDITIONAL COMMENTS:

11.7 LABORATORY SAFETY CHECKLIST FOR EARTHQUAKES

ROOM # _____ CONTACT NAME:
_____ DEPARTMENT: _____

Exits readily apparent and unobstructed.

Y N N/A

Sprinkler system unobstructed by furniture or equipment.

Y N N/A

Office furniture near exits or used to divide workspaces secured to a wall

Y N N/A

Shelves more than four feet tall are secured to the wall and braced.

Y N N/A

Shelves have lips or other restraints to keep contents in.

Y N N/A

Heavy instruments or computers are stored low down and secured.

Y N N/A

Any light fixtures, hanging plants or framed pictures hang away from exits.

Y N N/A

Overhead equipment (e.g., projectors, screens, fans) attached to structural member.

Y N N/A

Chemicals stored separated by type and compatibility, and in secured cabinets.

Y N N/A

Flammable liquids and hazardous materials stored according to appropriate codes.

Y N N/A

Gas cylinders chained to wall with two chains, and capped when not in use.

Y N N/A

Wheeled carts only used for temporary transportation, not storage.

Y N N/A

Gas, oxygen, electricity, and other utility shutoffs marked and accessible.

Y N N/A

Files backed up or copies of data kept in another location.

Y N N/A

11.8 Office Safety Checklist

Building:	Inspector:
Room Number:	Date Inspected:
Department/Unit	Supervisor:

(Check if completed)

	Comments	Correction Date
Administrative		
<input type="checkbox"/> 1. Is the departmental Health and Safety Plan in a location known and accessible to all employees?		
<input type="checkbox"/> 2. Is there a Safety Corner/Bulletin Board established with the following displayed (in terminology and language understood by the employees)?		
- WISHA Posters (available from EH&S, 543-7262)		
- The Emergency Phone Number poster		
- Other health and safety material/information		
<input type="checkbox"/> 3. Are training records maintained and available for review by employees, EH&S, and outside agencies?		
<input type="checkbox"/> 4. Are departmental safety inspection reports and corrections maintained and available for review by employees, EH&S, and outside agencies?		
<input type="checkbox"/> 5. Are Material Safety Data Sheets (MSDSs) and an inventory sheet of all office products used in the workplace on file and accessible to employees?		
<input type="checkbox"/> 6. Does the departmental Emergency Operations Plan include a floor plan/map of the department, including emergency evacuation site, procedures, and routes? Are employees/students instructed in emergency procedures (i.e.,		

	Comments	Correction Date
location of exits, location and use of fire extinguishers)?		
General Safety Concerns		
<input type="checkbox"/> 1. Are the exits (doorways), exit aisles, or corridors free of obstacles and combustible storage?		
<input type="checkbox"/> 2. Are the fire doors closed securely at all times?		
<input type="checkbox"/> 3. Are light fixtures working and are diffuses installed?		
<input type="checkbox"/> 4. Have all loose rugs or mats been secured or removed?		
<input type="checkbox"/> 5. Have missing or loose ceiling tiles been repaired?		
Electrical Cords and Outlets		
<input type="checkbox"/> 1. Are extension cords, multiple outlet strips, or cube taps plugged directly into a wall outlet?		
<input type="checkbox"/> 2. Are extension cords at a minimum 14 gauge (heavy-duty) and servicing only one appliance or fixture?		
<input type="checkbox"/> 3. Are cords in good condition without splices, deterioration, taping, damage, or being sharply bent or pinched?		
<input type="checkbox"/> 4. Are employees instructed not to use extension cords in place of permanent wiring?		
- Are extension cords prevented from running through walls, ceilings, or doors?		
<input type="checkbox"/> 5. Are extension cords grounded when servicing a grounded appliance or fixture?		
<input type="checkbox"/> 6. Are cord guards provided across an aisle or other passageway?		
<input type="checkbox"/> 7. Does the multiple outlet strip have a circuit breaker?		
<input type="checkbox"/> 8. Are multiple outlet strip cords 6' or under?		

	Comments	Correction Date
<input type="checkbox"/> 9. Is clear access (36" clearance) provided to electrical panels?		
<input type="checkbox"/> 10. Are electrical cover plates provided on all electrical switches or outlets?		
Heaters and Fans		
<input type="checkbox"/> 1. Do all heaters have a working tipover switch?		
<input type="checkbox"/> 2. Are combustibles kept 24" from all sides and tops of heaters?		
<input type="checkbox"/> 3. Are fine finger guards provided on fans?		
<input type="checkbox"/> 4. Are all electric space heaters plugged directly into the wall?		
<input type="checkbox"/> 5. Are all fans below head level or secured?		
Seismic Bracing and Earthquake Preparedness		
<input type="checkbox"/> 1. Are furnishings more than four feet high braced? (This includes file cabinets, bookcases, desk hutches, etc.)		
<input type="checkbox"/> 2. Is all shelving secured?		
<input type="checkbox"/> 3. Are projection screens, maps, blackboards, etc., fastened with a closed hook system or bolted to walls?		
<input type="checkbox"/> 4. Is overhead storage of heavy items or plants prevented?		
<input type="checkbox"/> 5. Are hanging planters or other objects prohibited?		