

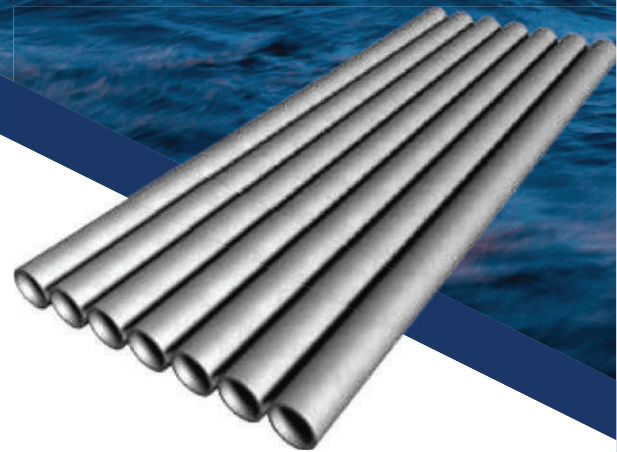

CI *corrotherm*[®]
INTERNATIONAL

heat & corrosion
RESISTANT MATERIALS



Introduction

Dedication to providing our clients with everything they need and more is the cornerstone of Corrotherm International. Managed by a team with more than 135 years' combined industry experience between us, we know and understand the pressures involved in the supply, specification, selection and use of heat and corrosion resistant materials. Not only do we have a wide range of high alloy materials to meet those requirements, we can deliver products off-the-shelf and keep back-up stock to support projects.

This ensures our clients get the fastest and most cost-efficient service. Our unique relationship with global manufacturers over 30 years means our portfolio is continually updated and puts us, and our customers, at the heart of any technological innovations. The unrivalled product portfolio is not our only strength. With a network of offices in the United Kingdom, Middle East, India, Asia Pacific and Europe, we have created a close long-term relationship with our clients.

At the outset we aim to facilitate a smooth delivery process from front-end engineering and design to delivery of complete package with project dossiers. It is this overview of the whole process that creates reassurance, and more importantly, offers peace of mind. And with a continual enhancement programme, the company strives to maintain a market-leading position through research, investment and innovation.



Jan Ward CBE
CEO

performance and reliability...

About the Company

Corrotherm International was established in 1992 by the current directors Jan Ward (CEO), Ian Newman (Managing Director), Peter Strand (Technical Director) and Barrie Jones (Commercial Director). The company was established to capitalise on a gap in the market for supplying multi-product, multi-metal packages in the Middle East region. A fully operational Middle East base was opened in the United Arab Emirates in 1998 and has since widened its presence in the Middle East by establishing offices in Abu Dhabi and Saudi Arabia. Over the past years the company has expanded its global market base and now has sales offices in India, Asia Pacific and Europe.

The company has since expanded to sustain a high level of product delivery and enhanced customer service by increasing the stock range in the UK and European facilities. Operating professionally and responsibly are key goals for us. We have an excellence rating with credit agencies and ensure continuous improvement in our team through membership of the Energy Industries Council, the Institute of Directors and Institute of Export. Quality is key to our product and the service conditions it is used for, consequently our management systems meet the requirements of ISO 9001:2015 and all stock fulfils the requirements of NACE standards where appropriate.

To demonstrate our keen commitment to both Health & Safety and environmental matters we have adopted an Integrated Management System meeting not only the requirements of ISO 9001:2015 but also ISO 14001:2015 and OHSAS 18001:2015. This helps to ensure that we minimise our impact on the environment and maintain a safe and productive working environment and this system has been fully audited by BM Trada Exova. Customer Care is our priority and we pride ourselves on being able to tackle complex issues quickly and effectively. Our extensive market and product knowledge allows us to provide beneficial and complete solutions for our customers. No client problem is too big or too small.

Product Forms Supplied

Tubulars

Seamless and welded pipes 1/2" NB to 100" NB
 Seamless and welded tubes 1/8" OD to 6" OD
 Cladded pipes 6" NB to 32" NB
 Co-extruded pipes 6" NB to 32"



Buttweld Fittings (Seamless & Welded)

45° and 90° Elbows
 Equal Tees and Reducing tees
 Concentric and Eccentric reducers
 Caps
 180° Bends
 Stub ends

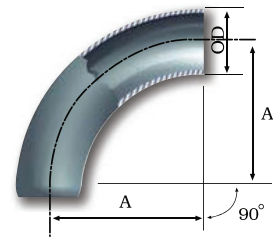

Forged & Threaded Fittings

Bushings
 Weldolets, Thredolets etc
 Nipples
 Caps
 45° and 90° Elbows
 Equal Tees and Reducing Tees
 Plugs, Hexagonal, Square or Round Head
 Unions

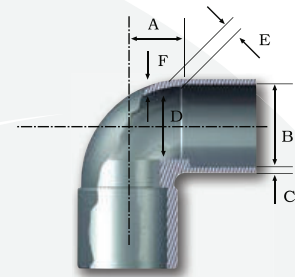

Flanges

Weld Neck
 Long Weld Neck
 Orifice
 Blind
 Slip On
 Spectacle
 Lap Joint
 Socket weld
 Threaded

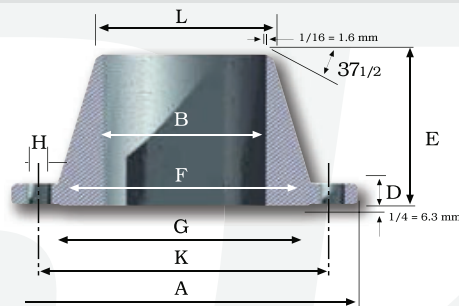

1/2" NB to 72" NB
 150 LB to 10,000 LB

Sheets Plates

Cold Formed, Descaled 0.5mm to 3mm
 Hot Formed, Descaled, Cut Pieces 4mm to 100mm Thick



Bars

Round bar 4mm to 300mm Dia
 Square bar 6mm to 76mm
 Hexagon 6mm A/F to 40mm A/F
 Flat 25 x 4mm to 76 x 25mm
 Customised size Per discussion

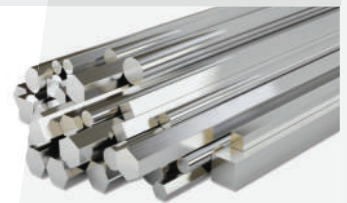

Welding Consumables

Welding Electrode
 Filler Wires

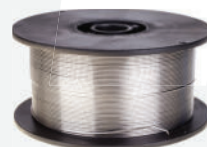

Valves

Ball Valves 150lb - 5000lb
 Gate Valves 1/2" - 12"
 Butterfly Valves
 Automated Valves



Stocks

In addition to specialty mill manufactured products, we have stock of standard items available. We hold extensive stocks of INCONEL® alloy 625, INCONEL® alloy 600, INCONEL® alloy C276, MONEL®400, NICKEL 200/201, INCOLOY® alloy 825, and INCOLOY® alloy 800HT, seamless pipe. This gives flexibility, reassurance and quick response, It also enables us to supply specialist items manufactured from start stock material to be delivered faster and more cost efficiently. Our warehouses also hold back-up stock for ongoing projects, to project specific specifications, which reduces the financial pressure on projects and lowers prices by eradicating the need to order minimum mill production quantities.

High alloy materials are designed to save money by providing a longer life and consequently lower maintenance costs in applications where there is a high level of corrosion or high temperature operating conditions.

High grade heat and corrosion resistant Nickel Alloys can extend the life of plant and equipment while improving production rate.

Meeting international and industry standards, our products fulfil the requirements of ASTM, ASME, NACE, and BS EN standards where appropriate.

Bespoke

With the ability to access a vast array of industry technology and products we are able to satisfy a wide range of customer requirements - many of which are bespoke. Our expertise provides us with the knowledge to assess individual needs to create the perfect solution.

On many occasions there is no standard solution and using the input and knowledge of the whole team we often come up with some unique and novel solutions.

Technical brochures, detailing individual alloys and their applications, are available.

Testing

We understand that every product may not come with the exact certification required. We offer an independent analysis and metals testing service, with state-of-the-art facilities that are among the best in the world. Test programs, management systems and equipment operate within a strictly controlled, audited and accredited environment, so that clients get the information they need.

Fast Track Delivery

Long lead times for high alloy materials can be prohibitive and costly, especially with breakdowns or major maintenance shutdowns. We can offer alternatives and efficiently locate the right products through matching our client requirements, to material availability and mill capabilities.

Making a Difference

We stand out from the crowd because we do more than just supply a range of high alloy materials. Our pre-sales and after-sales support means clients are looked after at every stage of the supply process, whether it be for a bespoke or off-the-shelf product. The wealth of knowledge offered by our highly-trained staff enables any issue, large or small, to be dealt with quickly and efficiently with the best outcome for the client always our end goal.

Supplier Network

Our unrivalled product portfolio of high alloy materials is created through the strong relationships we hold with a wide range of suppliers. All customer enquiries can be discussed creatively enough to identify the best solution.

The distribution agreements we hold bolsters this position and gives us the opportunity to give and receive feedback on new working practices and industry trends.

Bespoke Services

- Hydro test
- Corrosion test
- Hardness Test
- Positive Material Identification (PMI)
- Quick Deliveries
- Special Packing
- Documentation
- Project Support
- Package supplies

Special Products

- Pig tail tubing
- U-Tubing
- Finned tubes
- Tube Sheet

Markets and Applications

Heat and Corrosion Resistant materials are used in a wide range of industrial applications. The more common applications are listed below but clients can talk to our team about precise requirements.

Aerospace Engineering

Applications include - commercial jet engines, supersonic military aircraft, helicopters and space exploration programmes. Chosen for their strength at high temperatures, INCONEL[®], NIMONIC[®], INCOLOY[®] and UDIMET[®] alloys are used in civil and military engines from combustors, through power turbines to exhaust systems. NILO[®] alloys are ideally suited to tooling for the production of composites.

Automotive Engineering

New applications for the Incoloy, INCONEL[®] and NIMONIC[®] alloys have been being created by pollution control legislation worldwide. Other uses include systems valves, ignition equipment, sensors, electronic switch gear and safety devices.

The Chemical & Process Industries

The most long term tried and tested applications for nickel alloys where corrosion-resistance in process applications has become a standard industry demand. The uses range from vessels, piping and heat exchangers, to pumps and valves and are principally used in the wrought forms in pure Nickel and INCOLOY[®], INCONEL[®] and MONEL[®] and Hastelloy grades.

Thermal Processing and Heat Treatment

High-temperature strength and resistance to corrosion by furnace atmosphere makes INCOLOY[®], INCONEL[®] and NIMONIC[®] alloys particularly suited to furnace components such as radiant tubes, muffles, retorts, belts and hearths. These alloys are also ideal for the jigs.

and carriers that support the work through the heat-treatment processes. KOTHERM[®] and NIOOTHERM[®] alloy wires and INCOTHERM[®] alloy seamless tubing are used for thermocouples.

Electronics & Telecommunications

The physical properties of the pure nickel grades and nickel-iron alloys are ideal in a range of applications from precision components to glass/metal seals, magnetic shields and integrated circuits.

Marine Engineering

Resistance to seawater corrosion in marine and submarine applications makes MONEL[®] alloy 400 ideal for offshore platforms and in power and process plants using sea water as a coolant.

Oil & Gas Extraction Industries

INCONEL[®], INCOLOY[®] and MONEL[®] alloys are suited to a range of on-land and offshore applications from downhole tubulars and tools, to well-head hardware and processing equipment, to flare booms. Some are particularly useful for sour wells operating at high temperatures which create major operating problems.

Power Generation

The corrosion-resistance and high-temperature strength of INCONEL[®], INCOLOY[®], NIMONIC[®] and UDIMET[®] are essential in all areas from land-based gas turbines to feedwater and superheater tubing in coal and oil-fired utilities. Industry specific products are also employed in solar engineering and nuclear fission development programs.

Petrochemical Processing

The predictably reliable performance of high-temperature corrosion resistant INCOLOY[®] and Hastelloy INCONEL[®] makes them ideal for use in vessels, reactors, heat-exchangers, pyrolysis tubing, pigtails, headers and transfer piping.

Pollution Control & Waste Processing

The highest known performance from metallic materials working in aggressively corrosive environments is crucial in this area to help meet new standards for clean-up and conservation. Applications include stack linings, scrubbers, boiler tubing and heat exchangers.

Electrical Resistance Heating

Uses for alloys of RESISTOHEM[®] and BRIGHTRAY[®] alloys from industrial furnaces to household ranges, water heaters and toasters. These materials are particularly well suited to wire ribbon and strip heating elements. INCOLOY[®] and INCONEL[®] alloys are used in the form of seam-weld tubing for element sheathing. Some alloys are used for starter and traction resistors in locomotives and other heavy engineering applications.

Welding

Our Welding Products Company has the INCO-WELD[®], INCO-CORED[®] and NI-ROD[®] trademarks. It produces a variety of products including coated electrodes, filler metals and flux-cored filler wires, weldstrip and fluxes for joining nickel alloys, dissimilar metals, high-performance steels, and cast irons.

Material Grade

Nickel Alloys

Material	Trademark	UNS	Werkstat. nr.	Density	Bar/Billet	Forgings	Flanges	Tube		Pipe	Plate	Fittings	ASME Fittings
								smls/wld	smls/wld				
Alloy 200	Nickel 200	N02200	2.4066	8.89	B160	B564	B564	B163/B730	B161/B725	B162	B366	WPN	
Alloy 201	Nickel 201	N02201	2.4068	8.89	B160			B163/B730	B161/B725	B162	B366	WPNL	
Alloy 400	Monel 400	N04400	2.4350	8.83	B164	B564	B864	B163/B730	B165/B725	B127	B366	WPNC	
Alloy K-500	Monel K-500	N05500	2.4375	8.46	B865	B865	B865						
Alloy 600	Inconel 600	N06600	2.4816	8.47	B166	B564	B564	B163/B516	B167/B517	B168	B366	WPNCCL	
Alloy 601	Inconel 601	N06601	2.4851	8.20	B166			B163/B516	B167	B168			
Alloy 625	Inconel 625	N06625	2.4856	8.44	B446	B564	B564	B444/B704	B444/B705	B443	B366	WPNCMC	
Alloy 718	Inconel 718	N07718	2.4668	8.15	B537	B637	B637			B670			
Alloy 800H	Incoloy 800H	N08810	1.4876	8.00	B408	B564	B564	B163/B515	B407/B514	B409	B366	WPNIC10	
Alloy 800HT	Incoloy 800HT	N08811	1.4876	8.00	B408	B564	B564	B163/B704	B423/B705	B409	B366	WPNIC11	
Alloy 825	Incoloy 825	N08825	2.4858	8.18	B425	B564	B564	B163/B704	B423/B705	B424	B366	WPNICMC	
Alloy C-276	Hastelloy C-276	N10276	2.4819	8.87	B574	B564	B564	B622/B625	B622/B619	B575	B366	WPHC276	
Alloy C-22	Hastelloy C-22	N06022	2.4602	8.69	B574	B564	B564	B622/B625	B622/B619	B575	B366	WPHC22	
Alloy B-2	Hastelloy B-2	N10665	2.4617	9.22	B335	B564	B564	B622/B625	B622/B619	B333	B366	WPHB2	
Alloy B-3	Hastelloy B-3	N10675	2.4600	9.20	B335	B564	B564	B622/B625	B622/B619	B333	B366	WPHB3	
Alloy 59	Nicrofer 5923hMo	NO6059	2.4605	8.60	B574	B564	B564	B622/B625	B622/B619	B575	B366		
Alloy 20	Carpenter 20Cb3	N08020	2.4660	8.10	B473	B462	B462	B729/B464	B729/B464	B463	B366	WP20CB	
Alloy 904L		N08904	1.4539	8.05	A479	A182	A182	A269/A249	A269/A312	A240	A430	WP904L	

Titanium Alloy

Titanium Grade 2	R50400	3.7035	4.50	B348	B381	B381	B338	B861/B862	B625	B363	WPT2
Titanium Grade 5	R56400	3.7165	4.40	B348	B381	B381	B338	B861/B862	B625	B363	

Other Grades

- Duplex Stainless Steel (UNS S31803,S32205)
- Super Duplex Stainless Steel (UNS S32750, UNS S32760)
- 6 Moly Stainless Steel (UNS 31254,UNS N08925, UNS N08926)
- Refinery Grade Stainless (SS304H, SS309,SS310, SS317, SS321, SS347)
- Low Alloy Steel (P11, P22, P5, P9, P91)

Copper Nickel Alloys

- C70600, CuNi 90/10
- C71500, CuNi 70/30

Corrotherm End-User Approval



ISO Certifications

Meeting the requirements of the ISO standards...



012

ADNOC ICV CERTIFIED



(In process)

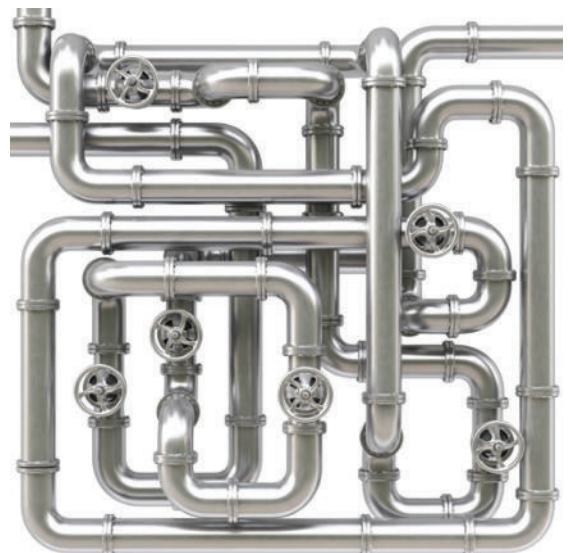



LOCAL PRESENCE – GLOBAL SUPPORT

Corrotherm, a Global Operation

With offices in three continents
Corrotherm offers an International service

“We understand you. Your local office speaks your language
and is open when you are open.”

Head Office

Corrotherm International Ltd
Unit 31, South Hampshire Industrial Park
Stephenson Road, Totton, Southampton
Hampshire SO40 3SA
United Kingdom

Tel: +44 (0) 23 8074 8100
Fax: +44 (0) 23 8074 8114
email: sales@corrotherm.co.uk



 /corrotherm-international-ltd

 /corrotherm

 /corrotherm

Dubai

Corrotherm International Middle East FZCO

Office 636, Bldg : 5E-B, DAFZA, Dubai
293710, United Arab Emirates

Tel: +971 (0) 4 701 7450
Fax: +971 (0) 4 701 7455
Email: sayeed.junied@corrotherm.co.uk
Website: www.corrotherm.co.uk

Abu Dhabi

Corrotherm International Middle East
Oilfield Equipments Trading LLC.

ADNOC ICV Certified Company
Office No. 912, 9th Floor ADNOC Tower,
Khalifa Street, Abu Dhabi,
PO Box: 37796, UAE

Tel: 971 (0) 2 418 9128
Fax: +971 (0) 2 508 9003
Email: sayeed.junied@corrotherm.co.uk
Website: www.corrotherm.co.uk

Saudi Arabia

Corrotherm Special Metals Trading Est.
Al Noor Building 1, 2nd floor
Al Khobar, Al Dammam Highway
(behind DHL building)
Saudi Arabia

Tel: 00 966 554933378
Email: sasale@corrotherm.co.uk
Website: www.corrotherm.co.uk