

VRV IV X

HEAT
RECOVERY
SYSTEMS





Adapting
VRV to
North America.

VRV IV X

Welcome to innovation.

Engineered and assembled in North America, Daikin's VRV IV X adapts VRV to North American HVAC market needs by expanding the applications in which VRV can be leveraged to solve traditional challenges. Packed with advanced technology, VRV IV X is the industry's first 3-phase variable refrigerant flow system with dual-fuel capability, after Daikin's launch of 1-phase VRV LIFE in 2018. The new series is equipped with features to optimize initial capital required on phased installations and provides ease of service and maintenance.



Features and Benefits

» Adapting VRV to North American market needs

- Industry's first 3-phase variable refrigerant flow system to integrate with communicating gas furnaces.
- Design flexibility to enlarge system from single to dual module or dual to triple module without change to installed main pipe sizes**.
- Engineered to optimize capital on phased and tenant fit out commercial buildings.
- Choice of gas furnace or heat pump heating for optimizing operational costs based on utility cost.
- Year round comfort and energy savings with Variable Refrigerant Temperature (VRT) technology.

» Technology that matters

- Engineered with Daikin's patented vapor injection compressor technology.
- Corrosion resistant up to 1000[†] hours Daikin Blue Fin coating as factory standard.
- Heat exchanger engineered with a bottom refrigerant circuit that allows installation without base pan heater.
- Refrigerant cooled inverter technology keeps PCB cool independent of ambient temperature.

» Engineered for maintenance

- New service window provides ease of access to the multi-functional display without removing the main electrical panel. The built-in multi-functional display is utilized for commissioning and maintenance and quickly converts to digital gauges to provide refrigerant pressure and temperatures.
- Multi-functional display eliminates the need to connect gauges during regular maintenance checks.
- Ease of commissioning with ability to program off site and upload using configurator tool.
- Field performable intermittent outdoor fan operation to help minimize snow accumulation on fan blades when the system is in thermal off.
- Seamless integration with T-series branch selector boxes, M, P, and T-series indoor units.
- Compatible with the full suite of Daikin VRV controls.
- Outstanding 10-Year Parts Warranty* as standard.



* Complete commercial warranty details available from your local distributor or manufacturer's representative or at www.daikincomfort.com or www.daikinac.com

[†] When tested in accordance to ASTM B117 methodology.

** Refer to engineering manuals for design rules and pipe sizes.

VRV IV X: ADAPTING VRV TO NORTH AMERICAN MARKET NEEDS



GAS FURNACE CONNECTIVITY

Expanding VRV into applications that were limited to gas-based heating, VRV IV X is the first 3-phase dual-fuel variable refrigerant flow system in North America that integrates with communicating gas furnaces.

VRV IV X offers outstanding design flexibility when connected to Daikin communicating 80%, 96%, and 97% AFUE gas furnaces and CXTQ coils. The new VRV IV X enables the use of VRV technology to provide utility cost based heating solutions. With the flexibility to switch between electric heat pump heating and gas heating, operational costs can be optimized to building owner's choice for a heating source.

- » Space-saving with ability to connect multiple gas furnaces to one outdoor unit with 14 selectable settings.
- » Customizable changeover temperatures to switch from heat pump to gas heat.
- » Ability to provide system-wide heating independent of outdoor ambient temperature.



PHASED INSTALLATION

VRV IV X delivers enhanced design flexibility thanks to its ability to expand with the building's phased construction.

- » Expand the system from a single to a dual module or from dual to triple module without changes to main pipe sizes that are already installed.
- » Help reduce initial capital and design complexity compared to systems that do not offer phased installation.
- » Optimize piping design, branch selector boxes, and indoor units per phase of installation.

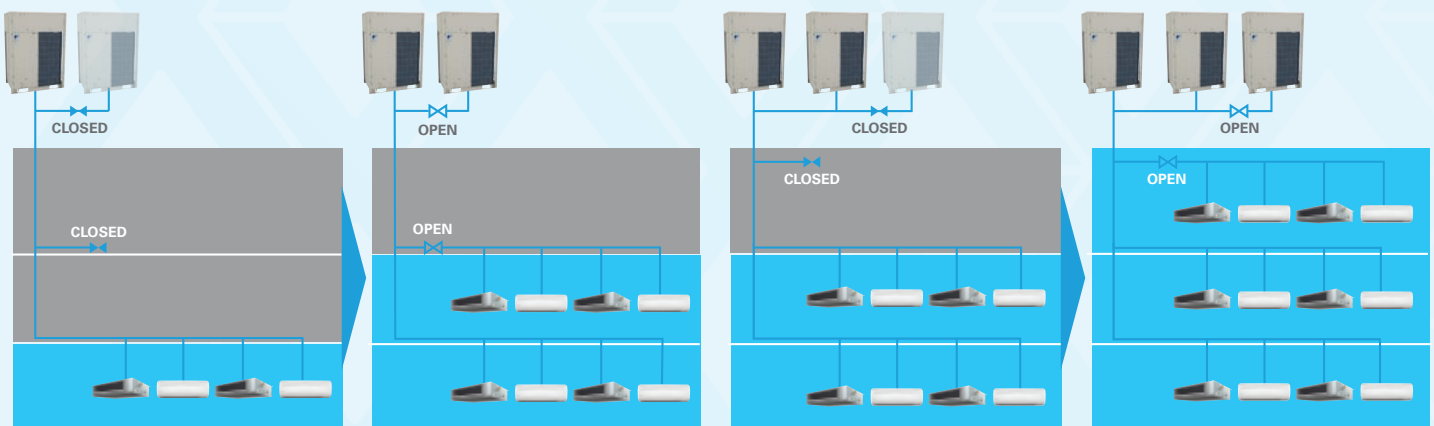

ADAPTIVE AND LEARNING VRT

The new VRV IV X system features a newly enhanced learning VRT technology. The new learning VRT technology, in addition to helping with annual energy efficiency and maintaining comfort, provides features that enable time-based learning to adjust cooling and heating capacities to provide a stable capacity to the indoor units. The feature must be activated through field setting changes.

Refrigerant cycle during cooling

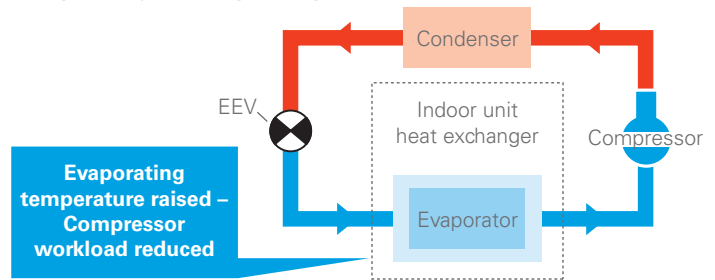

HOW IS ENERGY REDUCED?

A standard variable refrigerant flow system and previous Daikin VRV systems utilize a capacity based control logic where the system will adjust to meet the capacity requirements of the space. With VRT, Daikin has optimized focus not only on capacity but also on efficiency and comfort.

According to changes in the room's heat load and the ambient air temperature, the evaporating temperature (in cooling) and condensing temperature (in heating) are automatically adjusted to minimize the difference with the condensing temperature and the evaporation temperature, respectively.

This makes the compressors work less and also enables the system to always maintain the ideal compressor speed so that the Daikin VRV system can deliver the optimum efficiency.

Fine control to match user preference available through mode selection

Capacity priority

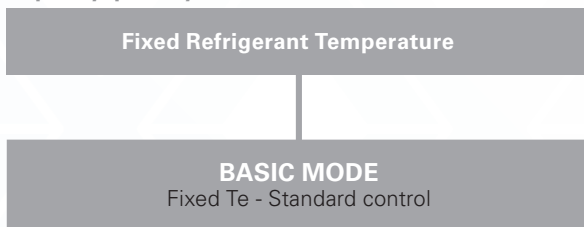

Energy saving priority

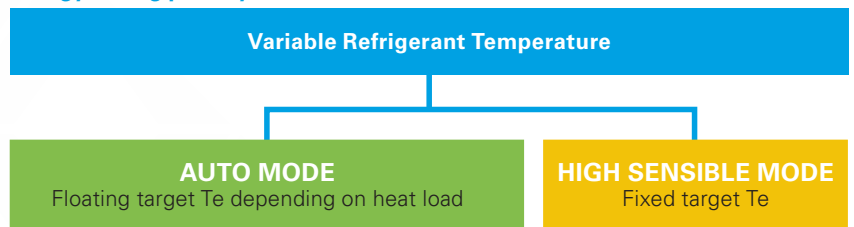

Selecting VRT enables operation to be optimised for either energy efficiency or rapid cooling.

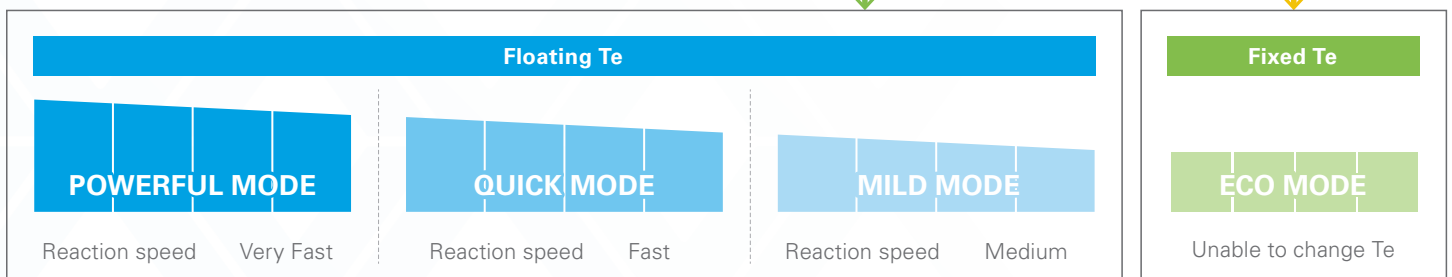

- » Can boost capacity above 100% if needed.
The refrigerant temperature can go lower in cooling than the set minimum.
- » Gives priority to very fast reaction speed.
The refrigerant temperature goes down fast to keep the room setpoint stable.

- » Gives priority to fast reaction speed.
The refrigerant temperature goes down fast to keep the room setpoint stable.

- » Gives priority to efficiency.
The refrigerant temperature goes down gradually giving priority to the efficiency of the system instead of the reaction speed.

1 DAIKIN K- TYPE VAPOR INJECTION SCROLL COMPRESSOR

- » Compressor technology with spiral design and injection valves for precise refrigerant control.
- » Strong and efficient motors for optimized compressor performance and part load efficiencies.

UP TO THREE TIMES MORE VAPOR INJECTION COMPARED TO OTHER VAPOR INJECTION COMPRESSORS

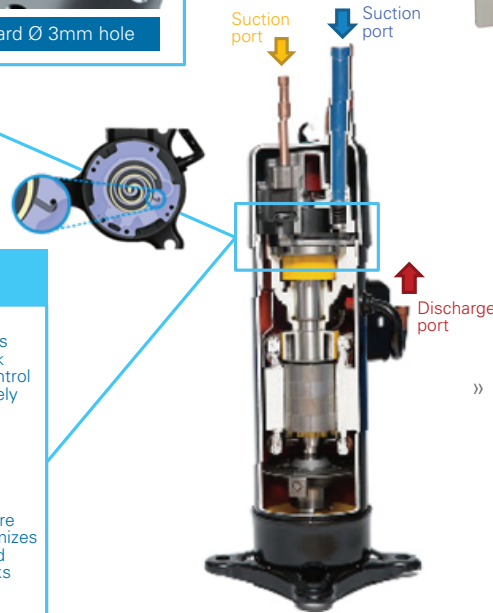
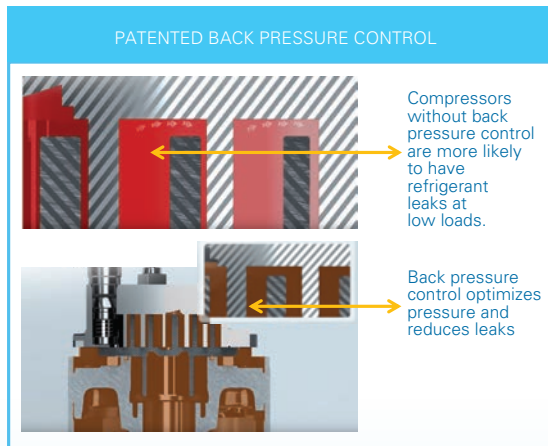

» New back pressure control mechanism optimizes the internal compressor pressure with the intermediate pressure adjusting port according to operating conditions. This stabilizes the orbiting scroll, reducing leaks and scroll friction during operation (compared to compressors without back pressure control).

2 Inverter Board Cooled by Refrigerant Circuit.

Minimum influence on electronics from ambient temperature. Section of the coil in the unit is permanently set as condenser for cooling of the inverter board.

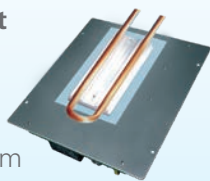

3 Special Coating applied on printed circuit board for protection against dust and water.



Service Window for access to multi-functional digital display for easy commissioning and troubleshooting applied on printed circuit board for protection against dust and water.



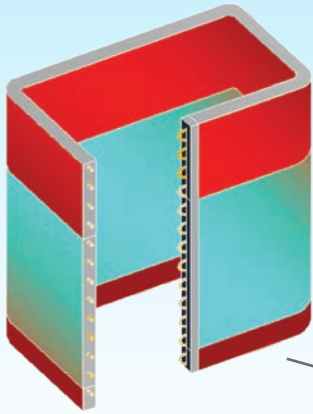

5 4-SIDED, 3-ROW HEAT EXCHANGER

» The heat exchanger features a vertically divided, optimized refrigerant circuit which delivers high efficiencies and capacities across the operation range. The innovative heat exchanger design provides additional benefits as mentioned below.

Example – Heat Recovery
Only: 60% heating,
40% cooling of
total load

Hot Gas Defrost Circuit. No base pan heater is required to avoid ice accumulation at the bottom of the coil.

7mm Coil – 3 Row. Improved heat exchanger efficiency over previous coil realizes highly integrated heat exchanger performance (increase row, resistance fin pitch) by reducing airflow resistance which changes cooling tube to Ø7mm.

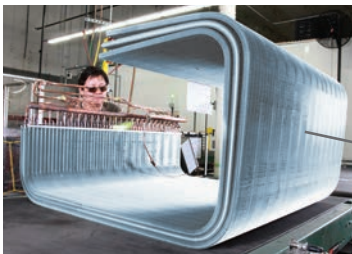

Corrosion Protected Coil. The *VRV IV X* comes as standard with a corrosion resistant coil coating — 1000 hr of salt spray testing according to ASTM B117.

Mechanically bonded
to aluminum waffle
louvered fins increases
surface area for more
efficient heat transfer

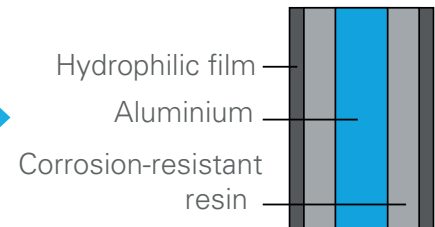
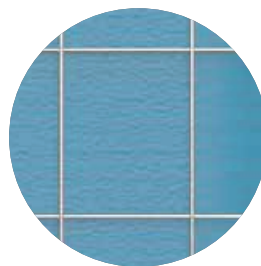

CONTINUOUS HEATING DURING DEFROST*

- » Reduces cold drafts.
- » No extra energy for reheating indoors, piping & zone (compared to variable refrigerant flow systems without continuous heating during defrost).

* Multi-modules only.

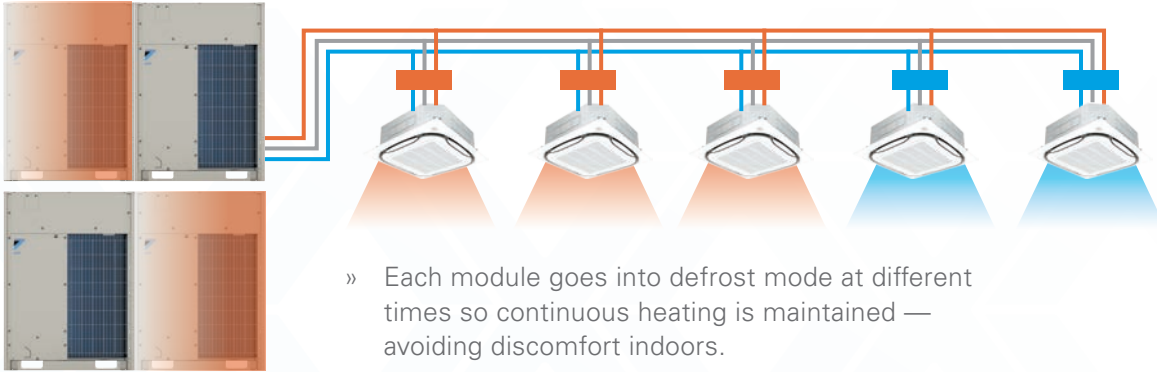
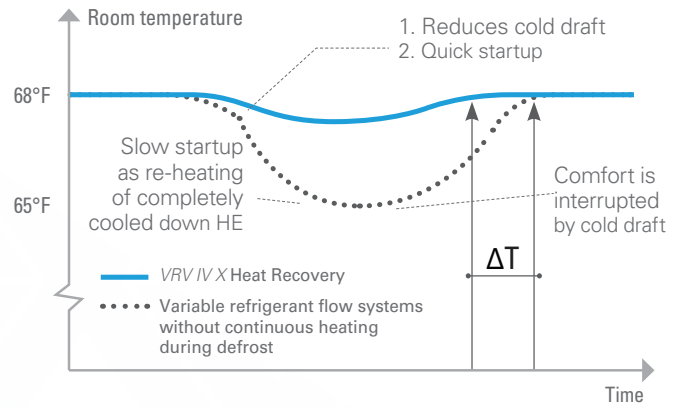

- » Each module goes into defrost mode at different times so continuous heating is maintained — avoiding discomfort indoors.

SIMPLE COMMISSIONING AND SERVICING

- » Configurator software designed to assist in the commissioning and maintenance of the system.
- » Multi-functional digital display on the unit for improved and faster configuration, commissioning, and troubleshooting compared to previous models.



IMPROVED MULTI-FUNCTIONAL DIGITAL DISPLAY

- » System state information such as EEV opening, compressor total operation time, refrigerant temperatures and pressures can be read through multi-functional digital display.
- » New service window provides quick access to multi-functional display and configuration buttons.

DISPLAY ITEM	UNIT
Operation Pressure (High/Low)	psi
Expansion Valve Opening	pulse
Thermistor Temperature (Suction, Discharge, Gas, Liquid, etc.)	F°
Compressor Total Operation Time	h/100

PIPING LIMITATIONS Liquid Line Max (ft)		VRV IV X	
		Heat Pump	Heat Recovery
A	Vertical Drop	164 (295) ¹	
B	Between IDU	100 (49) ³	
C	Vertical Rise	130 (295) ¹	130 (195) ¹
D	From 1st Joint	130 (295) ²	
E	Linear Length	540	
Total Network		3280	

¹ Field setting changes and upsizing are required above 164 ft. (vertical drop) and 130 ft. (vertical rise). Refer to Installation Manual for details.

² Upsizing is required for extension up to 295 ft. Refer to Installation Manual for details.

³ Limitations may apply above 49 ft.; refer to Installation Manual for details.

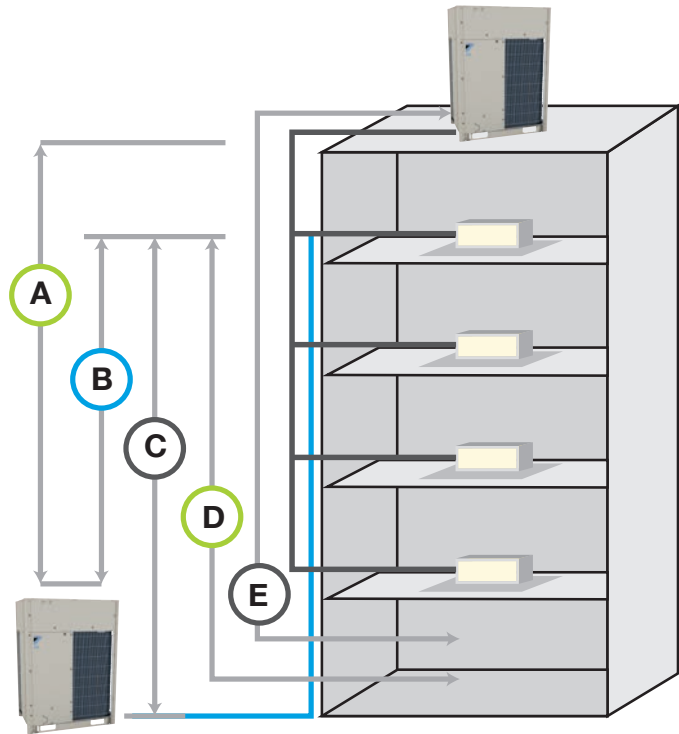

VRV IV X INSTALLATION SPACE

- » During installation, install the units using the most appropriate of the patterns shown in the figure for the location in question, taking into consideration human traffic and wind.
- » If the number of units installed is more than that shown in the pattern in the figure, install the units so that there is no air short circuiting.
- » Consider the space needed for the refrigerant piping when installing the units, as determined by local codes.
- » If the space requirements in the figure do not apply, contact your contractor or Daikin directly.
- » The installation space requirement shown in the figure is a reference for cooling. Refer to Installation Manual for further details.

For single unit installation

< Pattern 1 >

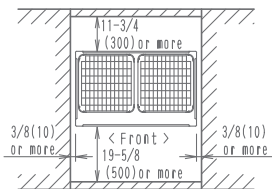

< Pattern 2 >

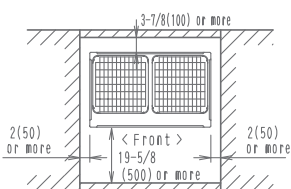

< Pattern 3 >

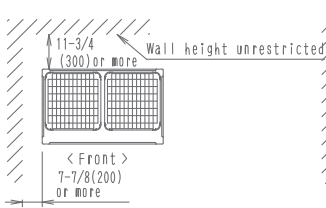

For installation in rows

< Pattern 1 >

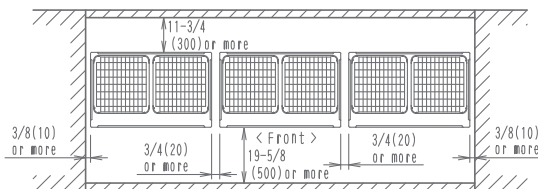

< Pattern 2 >

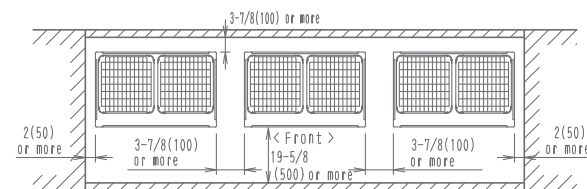

< Pattern 3 >

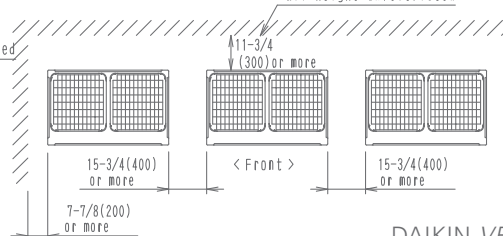

For centralized group layout

< Pattern 1 >

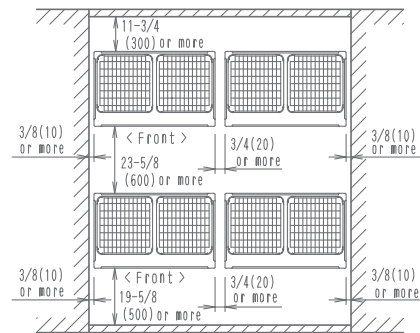

< Pattern 2 >

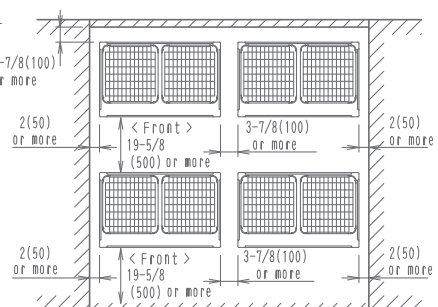

TECHNICAL DATA FOR VRV IV X - XATJA/XAYDA/XAYCA HEAT RECOVERY OUTDOOR UNITS											
		6 Ton	8 Ton	10 Ton	12 Ton	14 Ton	16 Ton	18 Ton	20 Ton		
Model	208-230V/3Ph/60Hz	REYQ72XATJA	REYQ96XATJA	REYQ120XATJA	REYQ144XATJA	REYQ168XATJA	REYQ192XATJA	REYQ216XATJA	REYQ240XATJA		
	460V/3Ph/60Hz	REYQ72XAYDA	REYQ96XAYDA	REYQ120XAYDA	REYQ144XAYDA	REYQ168XAYDA	REYQ192XAYDA	REYQ216XAYDA	REYQ240XAYDA		
	575V/3Ph/60Hz	REYQ72XAYCA	REYQ96XAYCA	REYQ120XAYCA	REYQ144XAYCA	REYQ168XAYCA	REYQ192XAYCA	REYQ216XAYCA	REYQ240XAYCA		
	Combination						2 x REYQ96XA	1 x REYQ96XA 1 x REYQ120XA	2 x REYQ120XA		
Performance	Rated Cooling Capacity	BTU/h	69,000	92,000	114,000	138,000	160,000	184,000	206,000	228,000	
	Rated Heating Capacity	BTU/h	77,000	103,000	129,000	154,000	180,000	206,000	232,000	256,000	
	Standard Operation Range Cooling	°F (°C) DB	23 to 122								
	Standard Operation Range Heating	°F (°C) WB	-13 to 60								
	Sound Pressure	dB(A)	65	65	65	66	66	68	68	68	
	Airflow	CFM	7283	7989	7989	9480	9480	7989 + 7989	7989 + 7989	7989 + 7989	
	Fan ESP, Standard/Max	in. W.G.	0.12 / 0.32								
Compressor	Compressors, all inverter	Qty	1				2				
	Revolutions per minute	RPM	3738	5142	6888	5214	6330	5214 + 5214	5994 + 5994	6702 + 6702	
	Capacity Control Range	%	15-100	13-100	11-100	14-100	12-100	6-100	6-100	5-100	
Refrigerant Piping, Layout	Maximum Vertical Pipe Length Above Unit	ft.	164 (295 With Field Setting)								
	Maximum Vertical Pipe Length Below Unit	ft.	130 (195 With Field Setting)								
	Maximum Vertical Pipe Length Between IDU	ft.	100								
	Maximum Actual Pipe Length	ft.	541								
	Maximum Equivalent Pipe Length	ft.	620								
	Maximum Total Pipe Length	ft.	3,280								
Refrigerant Piping, Connections	Liquid Pipe, Main Line	in.	3/8	3/8	1/2	1/2	5/8	5/8	5/8	5/8	
	Suction Gas Pipe, Main Line	in.	3/4	7/8	1-1/8	1-1/8	1-1/8	1-1/8	1-1/8	1-3/8	
	Discharge Gas Pipe, Main Line	in.	5/8	3/4	3/4	7/8	7/8	1-1/8	1-1/8	1-1/8	
Connection Ratio	Standard Connectable Indoor Unit Ratio	%	70 - 200 ¹	50 - 200 ¹							
	Maximum Number of Indoor Units	Qty	12	16	20	25	29	33	37	41	
Electrical	Maximum Overcurrent Protection, MOP (208-230V / 460V / 575V)	A	45 / 25 / 20	45 / 25 / 20	50 / 25 / 25	70 / 40 / 30	70 / 40 / 30	45 + 45 / 25 + 25 / 20 + 20	45 + 45 / 25 + 25 / 20 + 20	50 + 50 / 25 + 25 / 25 + 25	
	Minimum Circuit Amps, MCA (208-230V / 460V / 575V)	A	38.1 / 18.9 / 15.1	38.1 / 21.1 / 16.8	43.0 / 21.1 / 18.2	58.3 / 27.9 / 22.3	61.9 / 31.1 / 24.9	38.1 + 38.1 / 21.1 + 21.1 / 16.8 + 16.8	38.1 + 43.0 / 21.1 + 21.1 / 16.8 + 18.2	43.0 + 43.0 / 21.1 + 21.1 / 18.2 + 18.2	
	Compressor Rated Load Amps, (208-230V / 460V / 575V)	A	20.8 / 9.4 / 7.5	23.3 / 10.5 / 8.4	28.2 / 12.8 / 10.2	42.6 / 19.3 / 15.4	49.0 / 22.2 / 17.7	24.7 + 24.7 / 11.2 + 11.2 / 8.9 + 8.9	28.5 + 28.5 / 12.9 + 12.9 / 10.3 + 10.3	29.0 + 29.0 / 13.5 + 13.5 / 10.8 + 10.8	
Unit	Factory Refrigerant Charge	lbs.	25.8				25.8 + 25.8				
	Weight	lbs.	727	727	727	793	793	727 + 727	727 + 727	727 + 727	
	Dimensions (H x W x D)	in.	66-11/16 x 48-7/8 x 30-3/16				66-11/16 x 48-7/8 x 30-3/16 + 66-11/16 x 48-7/8 x 30-3/16				

¹Varies based on indoor model selected ² 35.5 ton for REYQ432XAYCA

OPERATION RANGE FOR ALL VRV IV X HEAT RECOVERY OUTDOOR UNITS	
Cooling °F DB	-4* – 122
Heating °F WB	-13 – 60

*Application rules apply

	22 Ton	24 Ton	26 Ton	28 Ton	30 Ton	32 Ton	34 Ton	36 Ton ²	38 Ton
	REYQ264XATJA	REYQ288XATJA	REYQ312XATJA	REYQ336XATJA	REYQ360XATJA	REYQ384XATJA	REYQ408XATJA	REYQ432XATJA	REYQ456XATJA
	REYQ264XAYDA	REYQ288XAYDA	REYQ312XAYDA	REYQ336XAYDA	REYQ360XAYDA	REYQ384XAYDA	REYQ408XAYDA	REYQ432XAYDA	REYQ456XAYDA
	REYQ264XAYCA	REYQ288XAYCA	REYQ312XAYCA	REYQ336XAYCA	REYQ360XAYCA	REYQ384XAYCA	REYQ408XAYCA	REYQ432XAYCA	-
	1 x REYQ120XA 1 x REYQ144XA	2 x REYQ144XA	1 x REYQ144A 1 x REYQ168XA	2 x REYQ168XA	3 x REYQ120XA	2 x REYQ120XA 1 x REYQ144XA	1 x REYQ120XA 2 x REYQ144XA	3 x REYQ144XA	2 x REYQ144XA 1 x REYQ168XA
	252,000	274,000	296,000	320,000	342,000	364,000	388,000	410,000	430,000
	282,000	294,000	320,000	338,000	376,000	386,000	394,000	405,000	414,000
	23 to 122								
	-13 to 60								
	69	69	69	69	70	71	71	71	71
	7989 + 9480	9480 + 9480	9480 + 9480	9480 + 9480	7989 + 7989 + 7989	7989 + 7989 + 9480	7989 + 9480 + 9480	9480 + 9480 + 9480	9480 + 9480 + 9480
	0.12 / 0.32								
	2				3				
	6504 + 5214	4794 + 4794	5286 + 5286	5664 + 5664	6606 + 6606 + 6606	6426 + 6426 + 5070	6162 + 4470 + 4470	4350 + 4350 + 4350	4470 + 4470 + 4470
	5-100	7-100	7-100	6-100	4-100	3-100	3-100	5-100	4-100
	164 (295 With Field Setting)								
	130 (195 With Field Setting)								
	100								
	541								
	620								
	3,280								
	3/4	3/4	3/4	3/4	3/4	3/4	3/4	3/4	3/4
	1-3/8	1-3/8	1-3/8	1-3/8	1-5/8	1-5/8	1-5/8	1-5/8	1-5/8
	1-1/8	1-1/8	1-1/8	1-1/8	1-3/8	1-3/8	1-3/8	1-3/8	1-3/8
	50 - 200'								
	45	49	54	58	64				
	50 + 70 / 25 + 40 /	70 + 70 / 40 + 40 / 30 + 30	70 + 70 / 40 + 40 / 30 + 30	70 + 70 / 40 + 40 / 30 + 30	50 + 50 + 50 / 25 + 25 + 25 / 25 + 25 + 25	50 + 50 + 70 / 25 + 25 + 40 / 25 + 25 + 30	50 + 70 + 70 / 25 + 40 + 40 / 25 + 30 + 30	70 + 70 + 70 / 40 + 40 + 40 / 30 + 30 + 30	70 + 70 + 70 / 40 + 40 + 40
	43.0+ 58.3 / 21.1 + 27.9 / 18.2 + 22.3	58.3+ 58.3 / 27.9 + 27.9 / 22.3 + 22.3	58.3+ 61.9 / 27.9 + 31.1 / 22.3 + 24.9	61.9+ 61.9 / 31.1 + 31.1 / 24.9 + 24.9	43.0+ 43.0 + 43.0 / 21.1 + 21.1 + 21.1 / 18.2 + 18.2 + 18.2	43.0+ 43.0 + 58.3 / 21.1 + 21.1 + 27.9 / 18.2 + 18.2 + 22.3	43.0 + 58.3 + 58.3 / 21.1 + 27.9 + 27.9 / 18.2 + 22.3 + 22.3	58.3 + 58.3 + 58.3 / 27.9 + 27.9 + 27.9 / 22.3 + 22.3 + 22.3	58.3 + 58.3 + 61.9 / 27.9 + 27.9 + 31.1
	32.9 + 42.1 / 14.9 + 19.0 / 11.9 + 15.2	43.5 + 43.5 / 19.7 + 19.7 / 15.7 + 15.7	46.5 + 46.5 / 21.0 + 21.0 / 16.8 + 16.8	50.1 + 50.1 / 22.7 + 22.7 / 18.1 + 18.1	32.7 + 32.7 + 32.7 / 14.8 + 14.8 + 14.8 / 11.8 + 11.8 + 11.8	33.8 + 33.8 + 43.7 / 15.3 + 15.3 + 19.8 / 12.2 + 12.2 + 15.8	35.7 + 45.1 + 45.1 / 16.2 + 20.4 + 20.4 / 12.9 + 16.3 + 16.3	45.1 + 45.1 + 45.1 / 20.4 + 20.4 + 20.4 / 16.3 + 16.3 + 16.3	47.0 + 47.0 + 47.0 / 21.3 + 21.3 + 21.3
	25.8 + 25.8				25.8 + 25.8 + 25.8				
	727 + 793	793 + 793	793 + 793	793 + 793	727 + 727 + 727	727 + 727 + 793	727 + 793 + 793	793 + 793 + 793	793 + 793 + 793
	66-11/16 x 48-7/8 x 30-3/16 + 66-11/16 x 48-7/8 x 30-3/16				66-11/16 x 48-7/8 x 30-3/16 + 66-11/16 x 48-7/8 x 30-3/16 + 66-11/16 x 48-7/8 x 30-3/16				

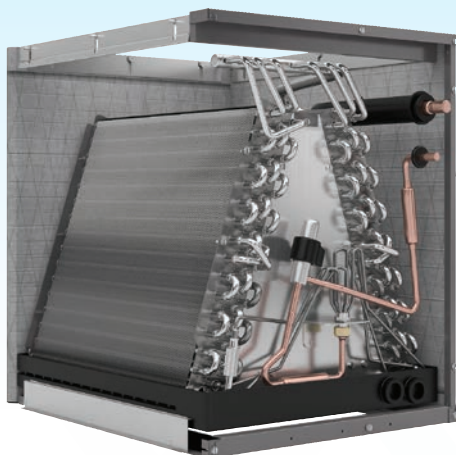

* Complete commercial warranty details available from your local Daikin manufacturer's representative or distributor or online at www.daikincomfort.com or www.daikinac.com.

CXTO ALL ALUMINUM COIL FEATURES

- » **Available in 2, 3, 4, and 5-Ton capacities.**
- » Engineered for VRV IV X outdoor units.
- » **Factory installed electronic expansion valve** with PID control loop for precision capacity control.
- » **Seamless integration** to full suite of Daikin controls using onboard control board
- » **Air cleaner and humidifier** integration capable¹.
- » **UV and rust resistant**, 5VA rated thermoplastic drain pan with integrated secondary drain.
- » **Foil-faced insulation covers** internal casing to reduce cabinet condensation.
- » **Split seam front** for easy installation and service access.
- » **Light weight** all aluminum evaporator coil.
- » **Ships factory standard up flow** with easy field conversion to downflow¹.
- » Backed by a **10-Year Parts Limited Warranty***.

¹ Rules apply, refer to installation manual for details.



80-97% AFUE COMMUNICATING GAS FURNACE

- » **Compatible with VRV IV X outdoor units** – Available from 60,000 Btu up to 120,000 Btu.
- » **Durable heat exchanger** – Unique tubular stainless-steel construction formed using wrinkle-bend technology results in an extremely durable heat exchanger. Paired with a stainless-steel secondary heat exchanger, this combination provides for reliability, durability and efficiency.
- » **Modulating gas valve** – Operates between 35% - 100% capacity, providing precise efficiency and the ultimate in comfort.
- » **Continuous air circulation** – Provides filtration and keeps air moving throughout your home to help maintain comfort.
- » **Self-diagnostic control board** – continuously monitors the system for consistent, reliable operation.
- » **Quiet, variable-speed induced draft blower** – provides precise control and enhanced energy-efficient performance as compared to single-speed blowers.



Major Accessories Lineup











DAIKIN VRV IV X — MAJOR ACCESSORIES LINEUP

VRV IV X Heat Recovery / VRV IV Heat Recovery / VRV AURORA Heat Recovery

OPTIONAL ACCESSORIES		REYQ72T REYQ96T	RELO72T RELO96T	REYQ120T REYQ144T REYQ168T	RELO120T	REYQ192T REYQ216T REYQ240T REYQ264T REYQ288T REYQ312T REYQ336T	RELO144T RELO192T RELO240T	REYQ360T REYQ384T REYQ408T REYQ432T REYQ456T
		REYQ72X REYQ96X		REYQ120X REYQ144X REYQ168X		REYQ192X REYQ216X REYQ240X REYQ264X REYQ288X REYQ312X REYQ336X		REYQ360X REYQ384X REYQ408X REYQ432X REYQ456X
Distributed piping	REFNET header	KHRP25M33H9 (max. 8 branch)		KHRP25M33H9 (max. 8 branch) KHRP25M72H9 (max. 8 branch)		KHRP25M33H9 (max. 8 branch) KHRP25M72H9 (max. 8 branch) KHRP25M73H9 (max. 8 branch)		
	REFNET joint	KHRP25A22T9 KHRP25A33T9		KHRP25A22T9 KHRP25A33T9 KHRP25M72TU9		KHRP25A22T9 KHRP25A33T9 KHRP25M72TU9 KHRP25M73TU9		
Outdoor unit multi connection piping kit		—		—		BHFP26P100U		BHFP26P151U

BRANCH SELECTOR BOXES

Providing flexibility and minimizing mechanical and electrical installation costs, Daikin's branch selector boxes that are used in Heat Recovery systems, are ideal for spaces that require individual heating and cooling control.

NUMBER OF BRANCHES / MAXIMUM TOTAL CAPACITY INDEX (KBTU/H)							
							
BSQ36TVJ 1/36	BSQ60TVJ 1/60	BSQ96TVJ 1/96	BS4Q54TVJ 4/144	BS6Q54TVJ 6/216	BS8Q54TVJ 8/290	BS10Q54TVJ 10/290	BS12Q54TVJ 12/290

REFNET

REFNET joints distribute correct flow of refrigerant in every branch of the piping network.

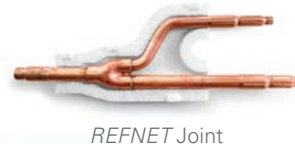





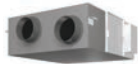



AIR TREATMENT SYSTEMS

Daikin's Outside Air Processing Unit can combine fresh air treatment and air conditioning, supplied from a single system. The compact Energy Recovery Ventilator is designed to improve indoor air quality while reducing the overall HVAC system power consumption. This is achieved by providing fresh outside air and recovering waste heat from exhaust air leaving the conditioned space.

		OUTSIDE AIR PROCESSING UNIT, FXMQ-MFVJU	ENERGY RECOVERY VENTILATOR, VAM-GVJU
			
VRV Refrigerant Piping		Connectible	Not Connectible
VRV Control Wiring		Connectible	
High Efficiency Filter (MERV 8 and MERV 13)		Option	Not Available
Ventilation System		Air supply	Air supply and Air exhaust
Power Supply	V/ph/Hz	208-230/1/60	
Airflow Rate	CFM	635, 988, 1236	300/300/170, 470/470/390, 600/600/500, 1200/1200/930

VRV CONTROLS

Optimized for VRV technology, Daikin controls provide highly scalable solutions for all applications and budgets. VRV controls offer solutions to meet your project controls needs from individual zone control with local controllers to centrally controlling the building with Centralized Controllers and/or interfacing with Building Management Systems (BMS) for comfort control in an easily managed and operated system.

PROJECT REQUIREMENTS	 Navigation Remote Controller	 DKN Cloud Wi-Fi Adaptor	 Simplified Remote Controller	 intelligent Touch Controller	 intelligent Touch Manager	 BACnet™ Interface	 LonWorks™ Interface	 Modbus™ Interface
Individual zone control	●	●	●					
Independent cool and heat setpoints	●	●		●	●			
Individual zone control with weekly programmable scheduling	●	●		●	●			
Basic central point on/off control of all air handling units				●	●	●	●	●
Advanced multi-zone control of small to medium size projects				●	●	●	●	●
Advanced multi-zone control of large commercial projects				●	●	●	●	
Advanced multi-zone control with scheduling logic and calendar				●	●			
Automatic cooling/heating changeover for heat pump systems				●	●			
Single input batch shutdown of all connected air handlers				●	●	●	●	●
Web browser control and monitoring via Intranet and Internet				●	●	●	●	●
E-mail notification of system alarms and equipment malfunctions				●	●	●	●	●
Multiple tenant power billing for shared condenser applications				●	●			
Temperature set-point range restrictions				●	●	●	●	●
Graphical user interface with floor plan layout					●	●	●	●
Start/stop control of ancillary building systems*				●	●	●	●	●
Daikin VRV integration with BACnet™ based automation systems					●	●		
Daikin VRV integration with LonWorks™ based automation systems							●	
Daikin VRV integration with Modbus™ based automation systems								●
Wi-Fi Option		●						
Remote Control and Monitoring through smartphone app		●						

* Requires one or more DEC102A51-US2 Digital Input/Output units or WAGO™ IO module (for use with iTM only).

● Native application or feature for this device. ● Dependent upon capabilities of the third party energy management system

POWERFUL SERVICE TOOL WITH INDOOR AND OUTDOOR UNIT OPERATION DATA POINTS

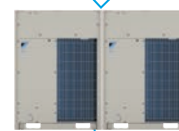
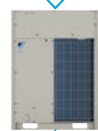
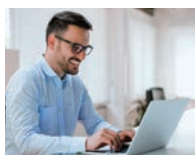

» When a problem occurs, the BMS integrators and Service Technicians can start troubleshooting immediately before going to the site.

» Indoor and outdoor operation data trending* by BMS can benefit the VRV service process.

*BMS programming needed

HAIL GUARD KIT FOR VRV IV X AND VRV AURORA

The optional hail guard kit for VRV IV X and VRV AURORA enable optimal airflow for efficient heat transfer while providing condenser coil protection from hail damage in severe climates. Each hail guard kit, that is field installed, consists of 4 panels (Right, Left, Front and Back).

NUMBER OF KITS REQUIRED FOR EACH OUTDOOR SYSTEM					
MODEL TYPE			NUMBER OF MODULES	VRV4HGS-K1	VRV4HGL-K1
VRV AURORA	208-230V / 460V / 575V	R_LQ72-120T	Single		1
		R_LQ144-240T	Dual		2
VRV IV X Heat Recovery	208-230V / 460V / 575V	REYQ72-168X	Single		1
		REYQ192-336X	Dual		2
		REYQ360-456X*	Triple		3
VRV IV X Heat Pump	208-230V / 460V	RXYQ72X	Single	1	
		RXYQ96-168X	Single		1
		RXYQ192X	Dual	1	1
		RXYQ216-336X	Dual		2
		RXYQ360-408X	Triple		3
		575V	RXYQ72-168XAYC	Single	
	RXYQ192-336XAYC	Dual		2	
	RXYQ360-384XAYC	Triple		3	

*Up to 432 on 575V



SNOW/WIND HOOD KITS

The optional Snow/Wind Hood Kits mount to VRV IV X and VRV AURORA series units over the heat exchanger coil to protect from snow build-up and wind in cold climates. The Hoods install easily to condensing units using existing screw taps with no modification required. Different kits can be ordered for different job requirements per table below.

NUMBER OF KITS REQUIRED FOR EACH OUTDOOR SYSTEM							
MODEL TYPE		NUMBER OF MODULES	VRV-SHS-FR	VRV-SHL-FR	VRV-SH-RL	VRV-SHS-T	VRV-SHL-T
VRV AURORA	208-230V / 460V / 575V	R_LQ72-120T	Single		1	1	1
		R_LQ144-240T	Dual		2	1	2
VRV IV X Heat Recovery	208-230V / 460V	REYQ72-168X	Single		1		1
		REYQ192-336X	Dual		2	1	2
		REYQ360-456X*	Triple		3	1	3
VRV IV X Heat Pump	208-230V / 460V	RXYQ72X	Single	1		1	
		RXYQ96-168X	Single		1	1	1
		RXYQ192X	Dual	1	1	1	1
		RXYQ216-336X	Dual		2	1	2
		RXYQ360-408X	Triple		3	1	3
		575V	RXYQ72-168XAYC	Single		1	1
	RXYQ192-336XAYC	Dual		2	1	2	
	RXYQ360-384XAYC	Triple		3	1	3	

*Up to 432 on 575V

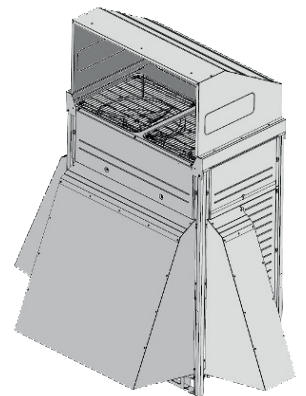

The tools have been designed to be simple to use, easily accessible and to address the various considerations and steps in the evolution of a residential or commercial project, aimed at helping the architect, consulting engineer, contractor, installation technician, and service company to enhance workflows and general project execution.

SUPPORT AND TOOLS OVERVIEW

CATEGORIES		TOOLS															
		WebXpress	Ventilation Xpress	Controls Configurator	Online Energy Calculator	IES-VE Daikin VRV plug-in	Performance curves for third-party energy simulation Programs	CAD drawings	Revit models	Reference Charge Calculator	Ventilation Rate Calculator	Daikin City (including Guide Specs, IOMS etc.)	Daikin eQuip application	Dr. Daikin	VRV Configurator	Service Checker	Online Spare Parts Bank
Selection		•	•	•													
Energy screening and simulation					•	•	•										
Design and verification								•	•	•	•						
Online and tablet reference (spec, data, submittal)												•					
Smartphone and mobile reference													•	•			
After sales and service															•	•	•

COMMERCIAL • RENOVATION • NEW CONSTRUCTION

About Daikin:

DAIKIN Daikin Industries, Ltd. (DIL) is a global Fortune 1000 company which celebrated its 95th anniversary in May 2019. The company is recognized as the leading HVAC (Heating, Ventilation, Air Conditioning) manufacturer in the world. DIL is primarily engaged in developing indoor comfort systems and refrigeration products for residential, commercial and industrial applications. Its consistent success is derived, in part, from a focus on innovative, energy-efficient and premium quality indoor climate and comfort management solutions.

Before purchasing an appliance in this document, read important information about its estimated annual energy consumption, yearly operating cost, or energy efficiency rating that is available from your retailer.

WARNINGS:

- » Always use a licensed installer or contractor to install this product. Do not try to install the product yourself. Improper installation can result in water or refrigerant leakage, electrical shock, fire or explosion.
- » Use only those parts and accessories supplied or specified by Daikin. Ask a licensed contractor to install those parts and accessories. Use of unauthorized parts and accessories or improper installation of parts and accessories can result in water or refrigerant leakage, electrical shock, fire or explosion.
- » Read the User's Manual carefully before using this product. The User's Manual provides important safety instructions and warnings. Be sure to follow these instructions and warnings.
- » For any inquiries, contact your local Daikin sales office.



Our continuing commitment to quality products may mean a change in specifications without notice.

© 2020 **DAIKIN NORTH AMERICA LLC** · Houston, Texas · USA · www.daikincomfort.com or www.daikinac.com

CB-VRVIX 7-20