

NEW



COMPACT EXCAVATOR | 48z-1/55z-1/57c-1

Operating weight: 10,564/11,860/12,087 lbs Net engine power: 44.8/48.3HP





55Z-1

100% steel
body work and
simplified H-frame
undercarriage.

48Z-1

Best-in-class 500
hour greasing
intervals.

A yellow JCB 57C-1 tracked excavator is shown from a rear three-quarter view, positioned on a paved rooftop terrace. The background features a dense urban skyline with various skyscrapers under a cloudy sky. The excavator's body is primarily yellow with black accents, and the model number '57 C-1' is visible on the side panel.

THE LATEST ADDITIONS TO OUR NEW GENERATION

NEW GENERATION CONTROL, EFFICIENCY, PERFORMANCE, STRENGTH.

Control, Industry leading digital screen technology lets you tailor and store settings to put you in total control. **Efficiency**, Designed to keep running costs low and prove to be a great business decision.

Performance, Designed to give you greater bucket and dipper tearout, greater dump height and greater lift capacity. **Strength**, Designed to be quite simply the strongest 5-ton machines on the market.

57C-1

Superb tear-out
and lift capacity.

NEW GENERATION STRENGTH.

TRACKED EXCAVATORS HAVE BEEN A PART OF THE JCB MANUFACTURING FAMILY FOR OVER 50 YEARS. WITH ALL THIS EXPERIENCE AND INSIGHT, OUR LATEST COMPACT EXCAVATORS HAVE BEEN DEVELOPED TO EXCEED OUR CUSTOMERS' STANDARDS. THEY ARE QUITE SIMPLY THE STRONGEST AND HIGHEST PERFORMING NEXT GENERATION MACHINES WE'VE EVER BUILT.



Our fully robot welded boom and arm are made of high tensile strength steel, with internal baffle plates in the boom, for long-life durability.

The toughest form.

- 1 With a finite element analysis-designed heavy-duty structure as well as simplified H-frame construction, the undercarriages of these compact excavators are both durable and confidence-inspiring.
- 2 Our clean four-plate arm design provides added structural strength and durability.
- 3 There are no longer any plastic external body panels on our new machines; instead they have 100% high strength pressed steel bodywork.

Dig end durability.

- 4 The optional heavy-duty swingbracket features durable re-bushable pivots to optimize service life on our new machines. It also provides a safe route for all excavator hoses.
- 5 The heavy-duty boom cylinder guard and optional arm and crowd ram guards give maximum excavator arm protection, even during the toughest jobs.



Quality componentry.

- 6** Fold back your cab door and you'll see that it fits snugly within the counterweight length. This keeps it out of harms way throughout the machine operation.
- 7** The hydraulic system boasts the latest industry technology "O-Ring Face Seal" (ORFS) hydraulic fittings, providing excellent sealing capabilities.
- 8** High quality 400mm rubber tracks with interlocking links will perform in even the most laborious applications. Specify our 400/550mm steel tracks and you'll find they're pre-drilled to make it easier to attach rubber pads. You can also opt for dedicated Road Liner Pads (Bridgestone GeoGrip™), which allow you to replace individual segments should you require.
- 9** We only use trusted premium manufacturers including JCB Diesel by Kohler engines, Nachi and Bosch-Rexroth hydraulic components and Bridgestone tracks.



NEW GENERATION CONTROL.

HIGH PRODUCTIVITY TO US MEANS HAVING A COMFORTABLE ENVIRONMENT. THAT'S WHY OUR NEW RANGE FOCUSES ON COMFORT AND EASE-OF-USE, MAKING OUR JCB A GREAT PLACE TO WORK.

Comfort and control.

1 These compact excavators have an even more spacious cab than before, with storage galore; a phone tray, storage net and a cup holder. The whole area is accessed easily and safely via a large door.

2 A radio, 12V phone charger, powerful heater with window de-mister and a high performing air conditioning system* with 8 vents completes the picture.

3 The innovative new rotary controller and the easy touch switches, have been thoughtfully designed for operational ease-of-use.

4 With ergonomic electro-hydraulic dozer control as standard, operators can achieve smooth and precise grading control.

5 You can alternate quickly between single and double-acting auxiliary flow thanks to a convenient switch in the cab.

*Air conditioning optional.

Our new deluxe fully adjustable suspension seating provides great operator comfort; our heated air suspension option, meanwhile, has independent adjustable positions for the ultimate in ergonomics.



Superior instrumentation.

6 The new machines now have the latest industry technology of digital screens available in the operating station. With a simple user interface, customizable home screen and specific diagnostic information, you are sure to find it a helping hand at work.

7 For increased safety, the JCB immobilizer eliminates the possibility of an unauthorized start. Having LiveLink* on the compact excavators will allow you to set a geofence and machine working restrictions.

A key benefit of the LiveLink and Immobilizer combination is the remote pin code management system, which allows you to remotely authorize or deny the usage of the machine. Up to 14 individual pin codes can be programmed into the system, offering the option to Customize operator preferences by embedding a separate auxiliary mode in each code.

8 You can easily adjust and program flow settings for specific attachments, with a built in memory to store your settings so that they can be easily retrieved between jobs.

Information such as service and machine diagnostics help the operator to keep on top of the status of the machine. Alerts and service interval countdowns will keep you up to date, and always one step ahead of the possibility of downtime.

9 Live readings of fuel consumption gives the operator an idea as to how the machine is performing at any stage of application.

* Refer to the standard and optional equipment table.



The switch panel and monitor are fitted with clearly identifiable, easy touch buttons.

NEW GENERATION PERFORMANCE.

THE LATEST COMPACT EXCAVATORS CONTINUE WITH THE NEW GENERATION LOOK AND FEEL. THIS MEANS THEY INCLUDE ALL OUR NEW INNOVATIVE DESIGN FEATURES, MAKING THEIR VERSATILITY AND PRODUCTIVITY, BEST IN CLASS.

Potent performance.

1 The new range has a JCB Diesel by Kohler common rail Tier 4 final compliant engine. This boasts DOC, turbocharger and intercooler. Power is increased to 48HP at just 2000rpm, and there's 221 lb-ft of torque.

2 Tracking performance is smooth and precise, ensuring high dozer capabilities and fast travel times. To increase productivity, our auto kickdown motors automatically adapt to changes in terrain increasing productivity and reducing operator fatigue.

Digging down.

3 These machines produce dipper tearout forces of up to 6519 lbf tearout; combined with fast cycle times, this enables unrivaled productivity. By perfectly matching our boom and arm, we've created optimal dig end geometry, helping you to work and load in confined areas with ease.

ZTS or CTS?

4 We offer zero turn and conventional tailswing configurations, but choosing the right one for you depends on your application. CTS gives greater stability, lifting capacity and a larger dig end; ZTS offers more manoeuvrability (especially in confined spaces) because there is no overhang for the ZTS.



Bucket rotation is a huge 181°, offering great spoil retention during truck loading. Choose an arm length to suit your application – from 5.4 ft– 7.3 ft, providing total versatility.

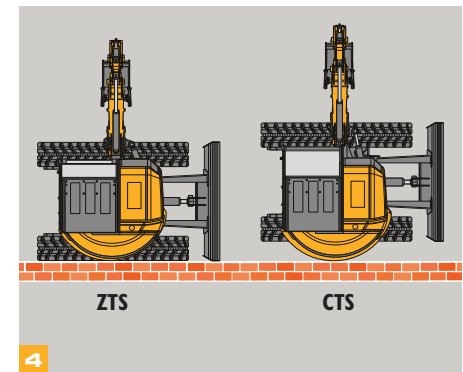

Hydraulic innovation.

4 A premium closed center hydraulic system provides improved flow sharing for smooth, precise and balanced operation during multi-functioning.

5 The programmable twin auxiliary lines provide high and optional low hydraulic flows to operate an array of attachments, increasing the machines versatility. Both auxiliary lines are electrically proportional controlled and fully adjustable for optimum attachment control.

6 The optional 4-way dozer can be angled right and left which, combined with the dozer float function makes levelling and backfilling work incredibly easy, even on inclines and uneven terrain.

Versatility attached.

7 You can now choose from a range of JCB's eco buckets, designed with fuel saving in mind. Our attachments provide ultimate performance, full JCB warranty compliance and optimum fit and operation.

8 Our factory-fitted hydraulic 'quick coupler' is an option to add to your machine, which is an increased benefit for changing attachments quicker.

A tilt rotate ready installation is optional, for increased productivity and versatility.

Our hydraulic 'quick coupler' is capable of picking up a range of bucket pin centers, making it compatible with your existing fleet of attachments from most excavator manufacturers in this weight class.



NEW GENERATION SAFETY.

OUR NEW COMPACT EXCAVATORS OFFER SAFETY AS FIRST PRIORITY, TO THE OWNER, OPERATOR, BYSTANDERS AND THE MACHINE ITSELF. WITH MAXIMUM SAFETY, DOWNTIME IS MINIMIZED THANKS TO OUR NEW DEVELOPMENTS.

Maximum protection.

1 The new compact excavators cabs are fully ROPS and TOPS compliant, for increased protection to the cab and operator, opt for the impact protection glass on the new machine.

2 JCB's safety lever lock fully isolates hydraulic functions to prevent unintended movement.

3 Our unique 2GO system ensures your compact excavator hydraulics can only be operated in a safe lockable position via two separate inputs.

As an optional safety feature, hydraulics can only be activated when the operator is seated and the seatbelt is worn.

4 Optional (territory dependent) boom, dozer and arm hose burst check valves (HBCVs) with an overload screen display makes operation safer.

5 Overload screen displays a bar chart from green to red to indicate if the overload point is close or has been passed. Once passed, the buzzer sounds and the bar flashes to warn the operator.



1



4

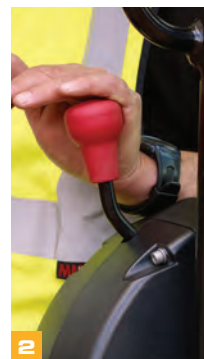

2



3



5

Safely does it.

- 6** Large track frame width and a low center of gravity helps to ensure that stability is maximized on the machines.
- 7** Standard boom and optional worklight guards offer greater protection for vulnerable components in hazardous applications.
- 8** Optional LED lights accommodate the 'follow me home' function. When selected, the lights will remain on for 3 minutes even when the machine is switched off, illuminating the area and allowing the operator to get off the work site safely.
- 9** These machines offer greater visibility than our outgoing models, thanks in part to a 70/30 front screen split; for easy, safe trench digging and manoeuvring.



6



7



8



9

NEW GENERATION SERVICE.

A JCB COMPACT EXCAVATOR IS DESIGNED TO BE AS PRODUCTIVE AS POSSIBLE. DOWNTIME IS MINIMIZED IN EVERY WAY, INCLUDING THE TIME IT TAKES TO CARRY OUT MAINTENANCE.

At your service.

- 1 Graphite impregnated bronze bushes allow best-in-class greasing intervals of 500 hours.
 - 2 An open frame undercarriage with sloping track legs makes cleaning easier.
 - 3 Dozer hoses are easy to replace because they terminate at the bulkhead.
 - 4 The wide-opening steel hood and external fuel indicator make it easy to fill the tank from ground level. Opt for a refuelling pump with auto stop function to reduce spillages and increase safety.
 - 5 Removing the cab floor is easy to do, and affords access to many key components like the main control valve spools.
 - 6 You can remove the floor mat easily for cleaning, while anti-slip cast tread plates provide safe access and bodywork protection.
- Boom swing and auxiliary controls are mounted on the joystick to increase floor space; the track pedals fold up to provide even more.
- 7 These machines feature color-coded hydraulic hoses for easy identification.

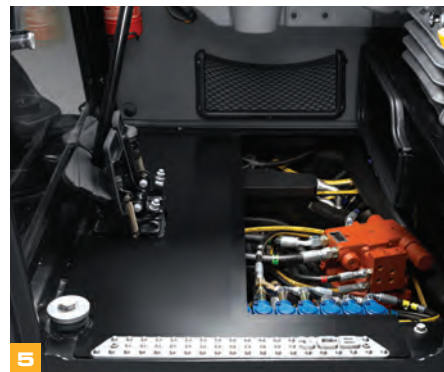

NEW GENERATION EFFICIENCY.

ULTIMATELY, COST OF OWNERSHIP IS PERHAPS YOUR PRIMARY CONCERN AS A BUSINESS. SO YOU'LL BE PLEASED TO KNOW THAT THE NEW JCB 48Z-I, 55Z-I AND 57C-I HAVE BEEN DESIGNED TO KEEP RUNNING COSTS AS LOW AS POSSIBLE.

Dynamic engine design.

1 Our below idle feature means that engine revs are reduced even further when the operators armrest is raised. Fuel economy and noise levels are both improved.

2 Activate 'One-Touch-Idle' by pressing the new rotary controller dial. Just another way of reducing engine revs quickly and conserving fuel.

Our programmable auto idle can be activated between 2 and 30 seconds after the controls have been inactive, to offer increased fuel efficiencies.

3 Control your engine speed with four different power bands to easily toggle through and set to optimum hydraulic flows. This includes light, eco, heavy and heavy plus, all of which can be tailored to suit your application.

4 The patented low pressure return line circuit further improves fuel efficiency, because the pump does not need to overcome as high a pressure before any work can be done.

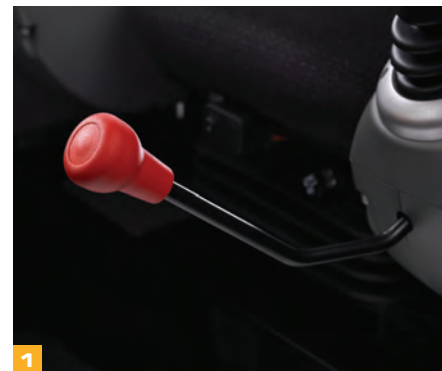
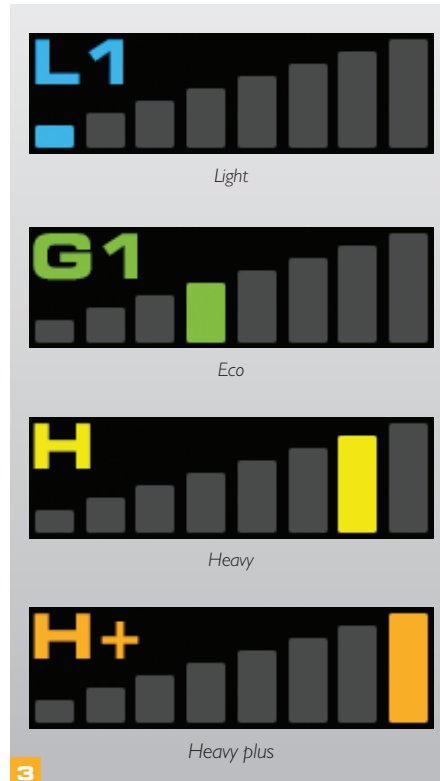

LIVELINK, WORK SMARTER.

LIVELINK IS AN INNOVATIVE SOFTWARE SYSTEM THAT LETS YOU MANAGE JCB MACHINES REMOTELY – ONLINE, BY EMAIL OR BY MOBILE PHONE. ACCESS EVERYTHING FROM MACHINE ALERTS TO FUEL REPORTS AND HISTORY INFORMATION, WITH ALL DATA STORED AT A SECURE CENTER.

Productivity and cost benefits

By providing information like idle time monitoring and machine fuel consumption, JCB LiveLink helps reduce your fuel usage, saving money and improving productivity. Machine location information can help improve efficiency and perhaps even reduce insurance costs.

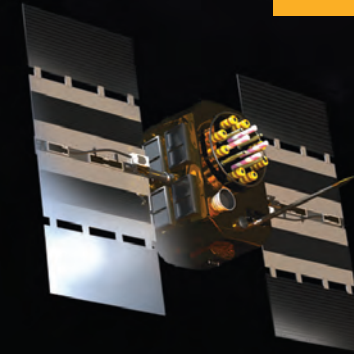

Maintenance benefits

Manage machine maintenance easily – accurate hours monitoring and service alerts improve maintenance planning, while real-time location data helps you manage your fleet. Critical machine alerts and maintenance history records are also available.



Security benefits

LiveLink's real-time geofencing alerts tell you when machines move out of predetermined zones, and real-time curfew alerts inform you of unauthorized usage. Further benefits include real-time location information, advanced ECU matching (pairs LiveLink with the immobilizer or ECU), and PIN code management (to remotely authorise usage – perfect for plant hire).



VALUE ADDED.

JCB'S WORLDWIDE CUSTOMER SUPPORT IS FIRST CLASS. WHATEVER YOU NEED AND WHEREVER YOU ARE, WE'LL BE AVAILABLE QUICKLY AND EFFICIENTLY TO HELP MAKE SURE YOUR MACHINERY IS PERFORMING TO ITS FULL POTENTIAL.



1

1 Our Technical Support Service provides instant access to factory expertise, day or night, while our Finance team is always on hand to provide fast, flexible, competitive quotes.

2 The global network of JCB Parts Centers is another model of efficiency; with 16 regional bases, we can deliver around 95% of all parts anywhere in the world within 24 hours. Our genuine JCB parts are designed to work in perfect harmony with your machine for optimum performance and productivity.



2

3 JCB Assetcare offers comprehensive extended warranties and service agreements, as well as service-only or repair and maintenance contracts. Irrespective of what you opt for, our maintenance teams around the world charge competitive labor rates, and offer non-obligation quotations as well as fast, efficient insurance repair work.



3

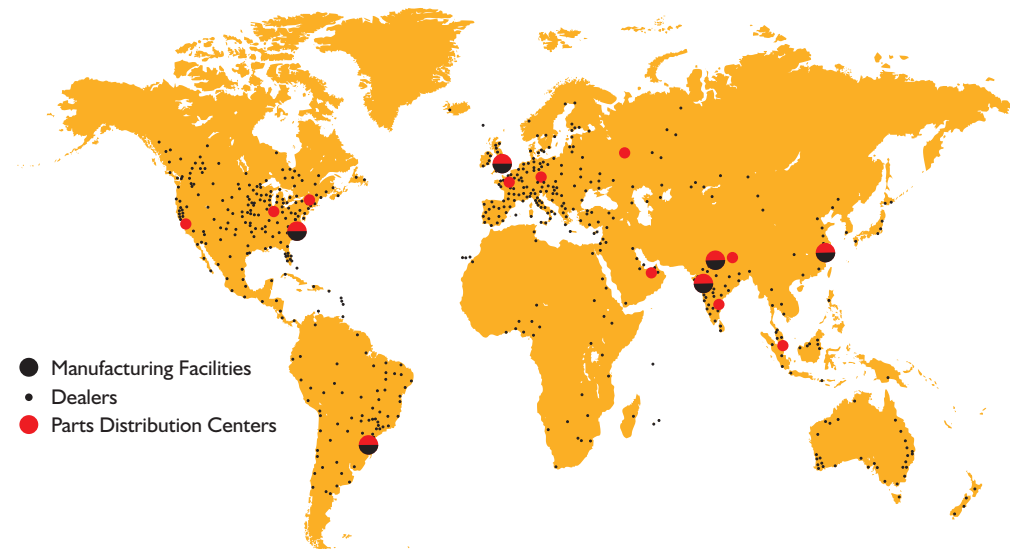

Note: JCB LIVELINK and JCB ASSETCARE may not be available in your region, so please check with your local dealer.

STATIC DIMENSIONS

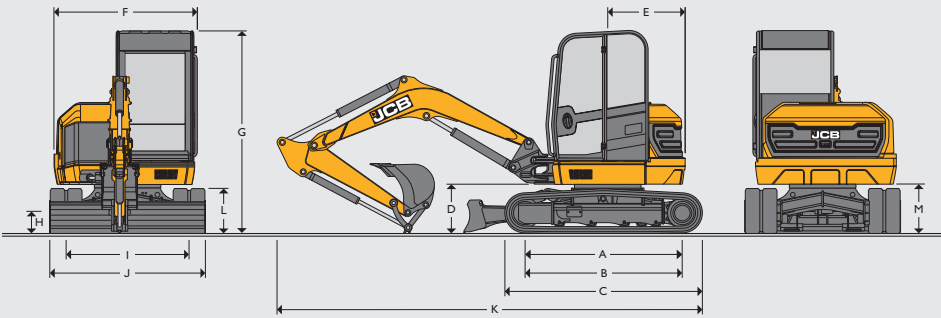

Machine model		48z-1	55z-1	57c-1
A	Sprocket idler centers	ft-in	6-6	
B	Track length on ground	ft-in	6-6	
C	Undercarriage overall length – rubber	ft-in	8-2	
	Undercarriage overall length – steel	ft-in	8-2	
D	Kingpost clearance	ft-in	2-0	
E	Tailswing radius	ft-in	3-2	3-3
				4-3
F	Overall width of superstructure	ft-in	5-11	6-0
G	Height over cab	ft-in		8-4
H	Ground clearance	ft-in		1-0
I	Track gauge	ft-in		5-1
J	Width over tracks	ft-in		6-4
K	Transport length with standard dipper	ft-in	17-6	18-1
				18-0
L	Track height	ft-in		1-10
M	Counterweight clearance	ft-in		2-0

ENGINE

		Standard
Machine model		48z-1, 55z-1, 57c-1
Model		Tier 4 Final KDI 1903
Fuel		Diesel
Cooling		Water cooled
Gross power ISO 14396	HP	48.3 (@ 2200rpm)
Net power	HP	44.8 (@ 2200rpm)
Gross torque ISO 14396	Nm	225 (@ 1500rpm)
Displacement	cc	1903
Gradeability	degrees	30
Starter motor	HP	2.9
Battery	volt / amps	12V / 75Ah
Alternator	amps (Air con)	100

UNDERCARRIAGE

Machine model		48z-1	55z-1	57c-1
No. of top rollers			1	
No. of bottom rollers			4	
Track width rubber (STD)	mm		400	
Track width steel	mm		400	
Ground bearing pressure (400mm tracks)	psi	4.2	4.9	5.1
Ground bearing pressure (550mm tracks)	psi	3.1	3.5	3.7
Track tensioning			Grease	
Travel speed – low	mph		1.8	
Travel speed – high	mph		2.8	
Tractive effort	lbf	8025	8565	8992

HYDRAULIC SYSTEM

Machine model		48z-1	55z-1	57c-1
Pump	cc		63	
Nominal output @ 2000rpm	gpm		33.2	
Excavator/track main relief pressure	psi	3480		3843
Slew main relief pressure	psi		3133	
Auxiliary hydraulic pressure (Low)	psi		3132	
Auxiliary hydraulic pressure (High)	psi		2755	
Auxiliary hydraulic flow (Low)	gpm		10.6	
Auxiliary hydraulic flow (High)	gpm		23.7	
Hydraulic pump			Piston	

WEIGHTS

Machine model		48z-1	55z-1	57c-1
Operating weight* (400mm rubber tracks)	lbs	10564	11830	12087
Shipping** weight (400mm rubber tracks)	lbs	10277	11543	11801
With FOGs guard – stage 1	lbs		+ 35	
Aircon (includes FOGs guard-stage 1)	lbs		+ 134	+ 145
With steel tracks (400mm)	lbs		+ 339	
With steel tracks (550mm)	lbs		+ 608	
With Geo grip tracks (400mm)	lbs		+ 388	
With 4 way dozer	lbs		+ 482	
Hydraulic quickhitch installation weight	lbs		+ 159	

* Operating weight to ISO 6016 including cab, rubber tracks, standard arm, 600mm bucket, full tanks and a 165lb operator.
 ** Shipping weight to ISO 6016 is mass of the base machine without an operator, with the fuel level at 10% of tank capacity.

SERVICE CAPACITIES

Machine model		48z-I	55z-I	57c-I
Fuel tank	gal		20	
Engine coolant	gal		Tier 4: 2.4	
Engine oil	gal		Tier 4: 2.1 max	
Hydraulic system	gal	26.4		29.5
Hydraulic tank	gal	14.5		16.4

OPERATOR ENVIRONMENT

Machine model		48z-I	55z-I	57c-I
Cab/canopy height	ft-in		8-4	
Cab/canopy height with FOGS guard LEVEL I	ft-in		8-4	
Cab/canopy length	ft-in	4-2		4-10
Cab/canopy width	ft-in		3-4	
Door aperture width	ft-in	1-9		1-11

STANDARD EQUIPMENT

Fully glazed ROPS & TOPS certified cab with programmable Intermittent wiper with wash/wipe, 3 speed heater/demister with 4 adjustable air vents, Color LCD display, Digital clock, Internal lockable toolbox, Cup holder, Coat hook, storage net, 12v accessory socket, Interior light, Full audio/visual warning systems, Auto idle throttle, Below idle system, one touch idle, 4 power bands(light, eco, heavy & heavy plus), ISO servo controls with electro-hydraulic dozer lever, Electro-proportional thumb controlled high flow single acting auxiliary, 10 selectable auxiliary flow rates, Joystick mounted hammer switch, Neutral start, Full control isolation, "2GO" hydraulic isolation, Midback suspension seat, removable floormat, Beacon ready kit, Two speed tracking, Auto-kickdown track motors, 400mm short pitch rubber tracks, Double element air cleaner, Heavy-duty alternator, Heavy-duty battery, Hydraulic slew braking with disc type park brake, ORFS hydraulics, Color coded hydraulic hoses, 500 hour dig end greasing intervals, Heavy-duty boom cylinder guard, Protected boom worklight, Quick release auxiliary couplers, 100% steel bodywork, dedicated tie down and lifting points, JCB LiveLink.

OPTIONAL EQUIPMENT

Air-conditioning with 8 adjustable air vents, Adjustable sunblind, FOPS guard stage I, 400mm or 550mm steel tracks, 400mm Geo GripRoad Liner tracks, Fan guards, Battery isolator (standard for EU), High back seat or deluxe heated high back air-suspension seat, Radio installation, Electro-proportional thumb controlled low flow auxiliary, Hose burst check valve lifting kit (dozer, boom & dipper), Bucket-to-grab change over valve, Mechanical quick coupler, Hydraulic quickhitch, Hydraulic quickhitch ready pipework, General purpose digging eco buckets, Ditch/grading eco buckets, Hydraulic hammers, Rotating/strobe beacon, Travel alarm, Toolkit, Greasegun & cartridge, Fire extinguisher, Exterior cab mounted mirrors, Interior mirror, Electric refuelling pump, JCB immobilizer (Unique key or keypad system), Dozer float, 4-way angled dozer blade, Dual pattern controls (ISO/SAE change-over), Thumb ready dipper, Special paint options, LED or Halogen worklights (either, with follow me home function), ROPS & TOPS certified canopy, Tilt rotate ready installation, Media socket, Radio ready kit, Worklight guards (cab), Arm/crowd Ram guards, Rearview camera, Rearview angled mirror, JCB impact protection front screen, Bushed kingpost, Electronic single-double acting change over valve, JCB LiveLink.

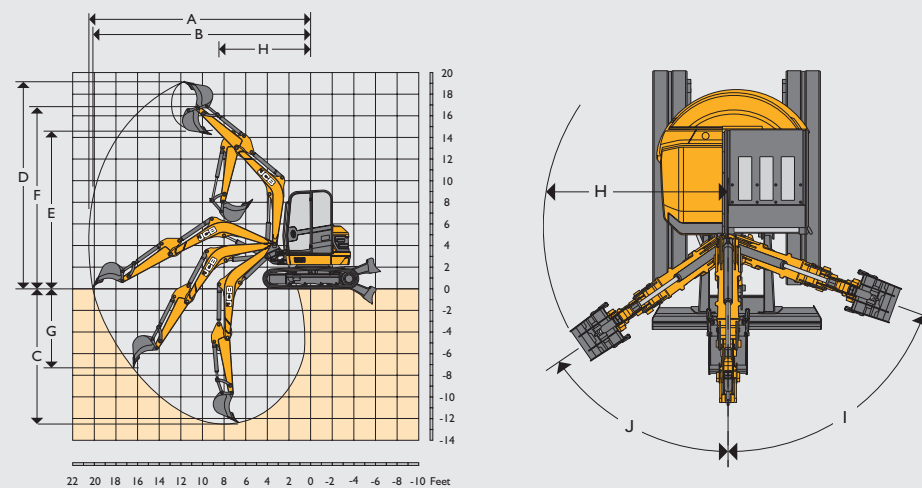













WORKING RANGE

		48z-I	55z-I	57c-I	
Arm length	ft-in	4-9	5-1	5-11	
Boom length	ft-in	8-10	9-4		
A	Maximum digging reach	ft-in	19-2	20-0	20-6
B	Maximum digging reach on ground	ft-in	18-8	19-8	20-1
C	Maximum digging depth – dozer up	ft-in	10-10	11-9	12-7
	Maximum digging depth – dozer down	ft-in	11-11	12-7	13-4
D	Maximum digging height	ft-in	17-8	18-6	19-2
E	Maximum dump height	ft-in	13-1	14-0	14-7
F	Maximum height to dipper nose pivot pin	ft-in	15-4	16-3	16-10
G	Maximum vertical wallcut depth	ft-in	6-5	6-8	7-4
H	Minimum front swing radius (no offset)	ft-in	8-6	8-7	8-6
	Minimum front swing radius (fully offset)	ft-in	6-11	7-1	7-0
I	Boom swing left	degrees		70	
J	Boom swing right	degrees		55	
	Bucket rotation	degrees		181	
	Arm rotation	degrees		121	
	Bucket tearout	lbf	8542	9442	
	Arm tearout	lbf	4945	6519	5845
	Slew speed	rpm		8.3	















DOZER

Machine model		48Z-I	55Z-I	57C-I
Dozer length	ft-in		3-8	
Maximum height above ground	ft-in		1-5	
Dig depth below ground	ft-in		1-6	
Approach angle	degrees		31	
Width	ft-in		6-5	
Height	ft-in		1-3	

LIFT CAPACITIES – 400MM RUBBER TRACKS, 2700MM BOOM, 1450MM ARM, NO BUCKET. 48Z-I

Load Point	6' 6"			9' 10"			13' 1"			16' 4"			Capacity at maximum reach			
																Distance
Height	Dozer Up	Dozer Down	Over Side	Dozer Up	Dozer Down	Over Side	Dozer Up	Dozer Down	Over Side	Dozer Up	Dozer Down	Over Side	Dozer Up	Dozer Down	Over Side	Distance
ft-in	lbs	lbs	lbs	lbs	lbs	lbs	lbs	lbs	lbs	lbs	lbs	lbs	lbs	lbs	lbs	ft-in
13-2													1856*	1856*	1336	12-9
11-6							1878	2114*	1283				1629	1728*	1105	14-1
9-10				2624*	2624*	2033	1867	2125*	1272				1435	1713*	966	15-1
8-2				2912	3179*	1925	1834	2240*	1243				1310	1647*	873	15-9
6-7				2778	3790*	1808	1790	2420*	1203				1226	1556*	809	16-3
4-11				2663	4297*	1709	1742	2628*	1157	1199	1982*	787	1182	1678*	776	16-6
3-3				2588	4597*	1640	1693	2822*	1113	1182	2224*	772	1160	1656*	756	16-7
1-7				2546	4685*	1603	1653	2970*	1078	1168	1947*	761	1166	1790*	758	16-5
0				2531	4594*	1590	1627	3040*	1052				1199	1909*	778	16-0
- 1-7	4354*	4354*	1415	2535	4332*	1594	1612	3009*	1038				1265	2033*	822	15-6
- 3-3	5496	5498*	1425	2560	3871*	1616	1614	2840*	1041				1385	2187*	899	14-8
- 4-11	5549	6408*	1444	2610	3086*	1660	1638	2403*	1065				1587	2224*	1034	13-5
- 6-7	5002*	5002*	1476										1980	2112*	1290	11-9
- 8-2													1662*	1662*	1662*	9-3

LIFT CAPACITIES – 400MM RUBBER TRACKS, 2866MM BOOM, 1570MM ARM, NO BUCKET. 55Z-I



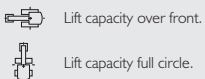











Load Point	6' 6"			9' 10"			13' 1"			16' 4"			Capacity at maximum reach			
																Distance
Height	Dozer Up	Dozer Down	Over Side	Dozer Up	Dozer Down	Over Side	Dozer Up	Dozer Down	Over Side	Dozer Up	Dozer Down	Over Side	Dozer Up	Dozer Down	Over Side	Distance
ft-in	lbs	lbs	lbs	lbs	lbs	lbs	lbs	lbs	lbs	lbs	lbs	lbs	lbs	lbs	lbs	ft-in
14' 9"													2425*	2425*	1799	12-3
13' 2"							2335	2989*	1627				2070	2152*	1356	13-9
11' 6"							2337	2915*	1629				1779	1995*	1228	15-2
9' 10"							2313	3016*	1607				1598	1916*	1096	16-1
8' 2"				3706	3871*	2518	2271	3232*	1570	1548	2822*	1058	1479	1894*	1008	16-7
6' 7"				3563	4720*	2392	2218	3521*	1521	1530	3031*	1043	1402	1942*	780	17-2
4' 11"				3408	5609*	2255	2158	3832*	1466	1508	3132*	1021	1358	2006*	913	17-4
3' 3"				3278	6310*	2141	2103	4114*	1415	1484	3208*	999	1334	1969*	893	17-5
1' 7"				3192	6684*	2066	2055	4321*	1371	1464	3254*	979	1340	2167*	895	17-3
0				3144	6759*	2022	2122	4416*	1340	1448	3228*	966	1371	2249*	913	17-0
- 1' 7"	5192*	5192*	3887	3122	6596*	2004	2000	4381*	1321	1444	2723*	961	1437	2509*	957	16-4
- 3' 3"	6720	7368*	3904	3122	6230*	2004	1993	4182*	1316				1545	2679*	1029	15-6
- 4' 11"	6766	9035*	3940	3139	5644*	2017	2004	3761*	1325				1728	2956*	1173	14-5
- 6' 7"	6843	7491*	3999	3177	4758*	2053	2048	2842*	1356				2041	2815*	1362	13-1
- 8' 2"	5146*	5146*	4096	3252	3305*	2116							2458*	2458*	1786	11-1



- Notes:**
1. Lifting capacities are based on ISO 10567, that is: 75% of minimum tipping load or 87% of hydraulic lift capacity, whichever is the less. Lifting capacities marked* are based on hydraulic capacity.
 2. Lift capacities assume that the machine is on firm level ground and equipped with an approved lifting point.
 3. A bucket must be fitted when lifting, the weight of this bucket must be deducted from the above lift capacities.
 4. Lift capacities may be limited by local regulations. Please refer to your dealer.

LIFT CAPACITIES – 400MM RUBBER TRACKS, 2866MM BOOM, 1820MM ARM, NO BUCKET.

57C-1

Load Point	6' 6"			9' 10"			13' 1"			16' 4"			Capacity at maximum reach			
																Distance
Height	Dozer Up	Dozer Down	Over Side	Dozer Up	Dozer Down	Over Side	Dozer Up	Dozer Down	Over Side	Dozer Up	Dozer Down	Over Side	Dozer Up	Dozer Down	Over Side	Distance
ft-in	lbs	lbs	lbs	lbs	lbs	lbs	lbs	lbs	lbs	lbs	lbs	lbs	lbs	lbs	lbs	ft-in
14' 9"							2033*	2033*	1984				1949*	1949*	1949*	13-1
13' 2"							2659*	2659*	2022				1821*	1821*	1649	14-7
11' 6"							2628*	2628*	2019				1706*	1706*	1444	15-9
9' 10"							2736*	2736*	1995	1876	2317*	1354	1660*	1660*	1312	16-7
8' 2"							2712	2943*	1958	1870	2762*	1347	1819	2692*	1310	17-3
6' 7"				4065*	4065*	2923	2627	3221*	1907	1850	2840*	1329	1576*	1576*	1157	17-8
4' 11"				4107	4896*	2848	2595	3527*	1852	1823	2943*	1305	1579	1695*	1124	17-10
3' 3"				3966	5631*	2723	2535	3823*	1797	1797	3045*	1281	1554	1658*	1105	17-11
1' 7"				3856	6129*	2626	2482	4057*	1748	1773	3120*	1257	1559	1709*	1105	17-10
0				3785	6356*	2564	2441	4200*	1709	1755	3137*	1239	1594	1845*	1127	17-6
- 1' 7"	5280*	5280*	5280	3748	6347*	2531	2412	4228*	1684	1744	3056*	1230	1660	2030*	1173	16-11
- 3' 3"	7039*	7039*	7039	3735	6124*	2520	2399	4116*	1671				1768	2176*	1248	16-3
- 4' 11"	7968	8516*	8516	3741	5692*	2526	2403	3823*	1673				1947	2498*	1373	15-3
- 6' 7"	8038	8135*	8135	3770	5004*	2551	2427	3225*	1698				2238	2725*	1574	13-11
- 8' 2"	6248*	6248*	6248	3827	3915*	2601							2538*	2538*	1947	12-1
- 9' 10"	3437*	3437*	3437*										1947*	1947*	1947*	9-6

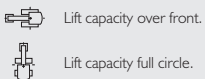

- Notes:**
1. Lifting capacities are based on ISO 10567, that is: 75% of minimum tipping load or 87% of hydraulic lift capacity, whichever is the less. Lifting capacities marked* are based on hydraulic capacity.
 2. Lift capacities assume that the machine is on firm level ground and equipped with an approved lifting point.
 3. A bucket must be fitted when lifting, the weight of this bucket must be deducted from the above lift capacities.
 4. Lift capacities may be limited by local regulations. Please refer to your dealer.



ONE COMPANY, OVER 300 MACHINES.

Compact Excavator 48Z-1/55Z-1/57C-1

Operating weight: 10,564/11,860/12,087 lbs Net engine power: 44.8/48.3HP

JCB North American – Headquarters

2000 Bamford Blvd., Savannah, Georgia, 31322 Tel: (912) 447-2000

Download the very latest information on this product range at www.jcb.com

JCB inc. All rights reserved. No part of this publication may be reproduced, stored in a retrieval system, or transmitted in any form or by any other means, electronic, mechanical, photocopying or otherwise, without prior permission from JCB inc. All references in this publication to operating weights, sizes, capacities and other performance measurements are provided for guidance only and may vary dependant upon the exact specification of machine. They should not therefore be relied upon in relation to suitability for a particular application. Guidance and advice should always be sought from your JCB Dealer. JCB reserves the right to change specifications without notice. Illustrations and specifications shown may include optional equipment and accessories. The JCB logo is a registered trademark of J C Bamford Excavators Ltd.

Your nearest JCB Dealer

