

Paul Cantrell

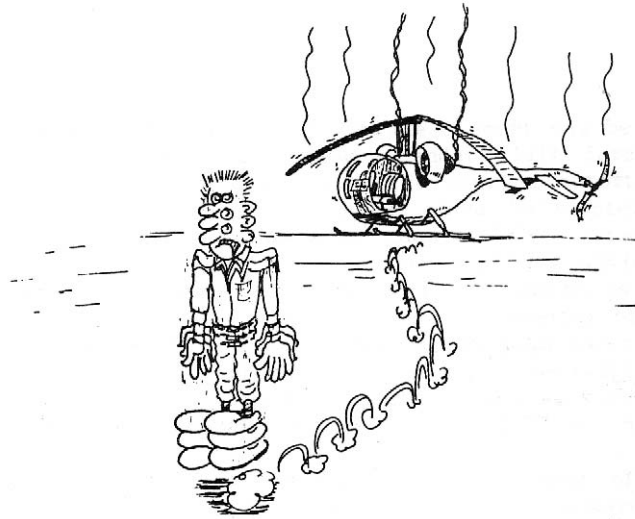

HELICOPTER **AERODYNAMICS**

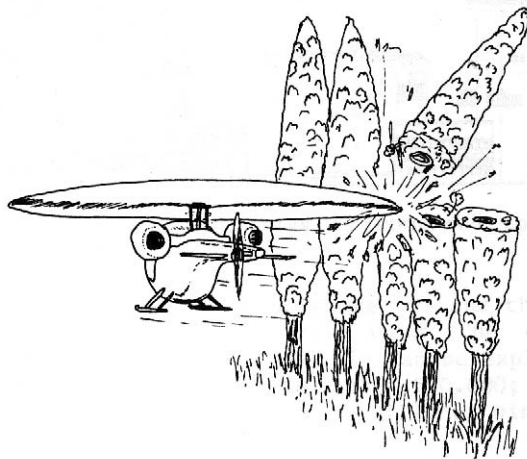

Concepts

• Airfoils	pg	3
• Rotary Wing Planforms	pg	5
• Relative Wind	pg	7
• Angle of Attack	pg	10
• Total Aerodynamic Force	pg	11
• Pressure Patterns	pg	13
• Drag	pg	16
• Centrifugal Force	pg	18
• Rotational Velocities	pg	21
• Hovering	pg	23
• Ground Effect	pg	25
• Torque	pg	29
• Translational Lift	pg	31
• Transverse Flow Effect	pg	33
• Dissymetry of Lift	pg	34
• Blade Flapping	pg	37
• Gyroscopic Precession	pg	41
• Retreating Blade Stall	pg	43
• Settling with Power	pg	47
• Autorotation	pg	50
• Future Development	pg	57

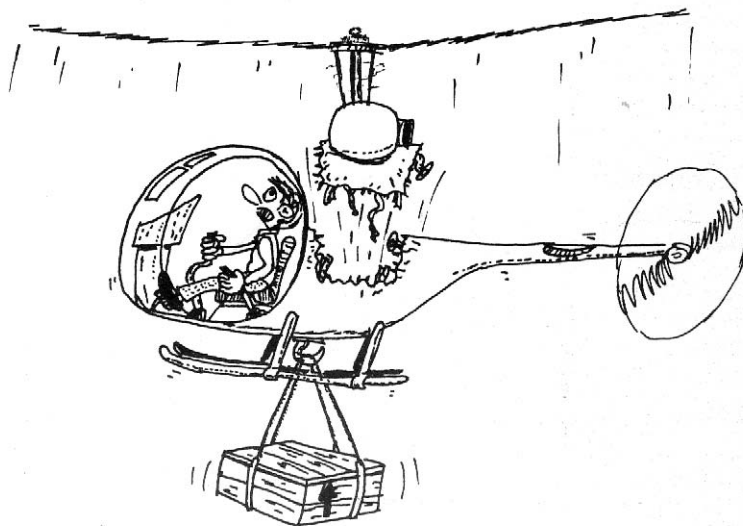

Airfoils

A helicopter flies for the same basic reason that any conventional aircraft flies, because aerodynamic forces necessary to keep it aloft are produced when air passes about the rotor blades. The rotor blade, or airfoil, is the structure that makes flight possible. Its shape produces lift when it passes through the air. Helicopter blades have airfoil sections designed for a specific set of flight characteristics. Usually the designer must compromise to obtain an airfoil section that has the best flight characteristics for the mission the aircraft will perform.

Airfoil sections are of two basic types, *symmetrical* and *nonsymmetrical*. Symmetrical airfoils have identical upper and lower surfaces. They are suited to rotary-wing applications because they have almost no center of pressure travel. Travel remains relatively constant under varying angles of attack, affording the best lift-drag ratios for the full range of velocities from rotor blade root to tip. However, the symmetrical airfoil produces less lift than a nonsymmetrical airfoil and also has relatively undesirable stall characteristics. The helicopter blade must adapt to a wide range of airspeeds and angles of attack during each revolution of the rotor. The symmetrical airfoil delivers acceptable performance under those alternating conditions. Other benefits are lower cost and ease of construction as compared to the nonsymmetrical airfoil.

Nonsymmetrical (cambered) airfoils may have a wide variety of upper and lower surface designs. They are currently used on some CH-47 and all OH-58 Army helicopters, and are increasingly being used on newly designed aircraft. Advantages of the nonsymmetrical airfoil are increased lift-drag ratios and more desirable stall characteristics. Nonsymmetrical airfoils were not used in earlier helicopters because the center of pressure location moved too much when angle of attack was changed. When center of pressure moves, a twisting force is exerted on the rotor blades. Rotor system components had to be designed that would withstand the twisting force. Recent design processes and new materials used to manufacture rotor systems have partially overcome the problems associated with use of nonsymmetrical airfoils.

Airfoil Sections

Rotary-wing airfoils operate under diverse conditions, because their speeds are a combination of blade rotation and forward movement of the helicopter. An intelligent discussion of the factors affecting the magnitude of rotor blade lift and drag requires a knowledge of blade section geometry. Blades are designed with specific geometry that adapts them to the varying conditions of flight. Cross-section shapes of most rotor blades are not the same throughout the span. Shapes are varied along the blade radius to take advantage of the particular airspeed range experienced at each point on the blade, and to help balance the load between the root and tip. The blade may be built with a twist, so an airfoil section near the root has a larger pitch angle than a section near the tip.

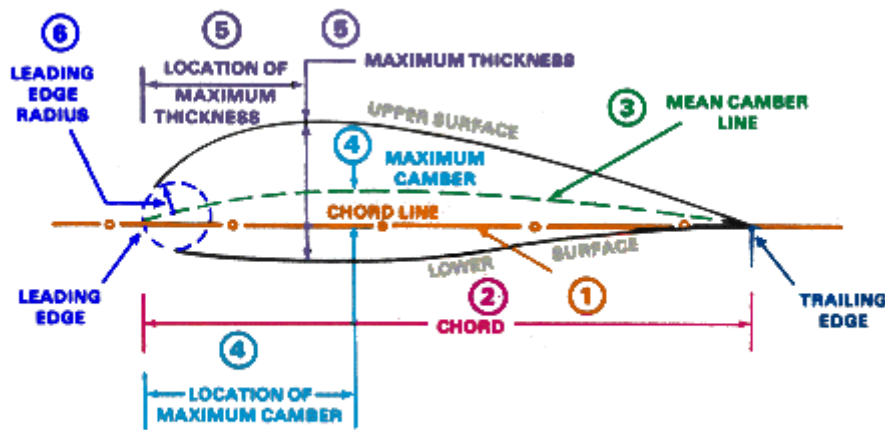

FIGURE 2-10. AIRFOIL TERMINOLOGY.

- The *chord line* is a straight line connecting the leading and trailing edges of the airfoil.
- The *chord* is the length of the chord line from leading edge to trailing edge and is the characteristic longitudinal dimension of the airfoil.
- The *mean camber line* is a line drawn halfway between the upper and lower surfaces. The chord line connects the ends of the mean camber line.
- The shape of the mean camber is important in determining the aerodynamic characteristics of an airfoil section. *Maximum camber* (displacement of the mean camber line from the chord line) and the location of maximum camber help to define the shape of the mean camber line. These quantities are expressed as fractions or percentages of the basic chord dimension.
- Thickness and thickness distribution of the profile are important properties of an airfoil section. The *maximum thickness* and its *location* help define the airfoil shape and are expressed as a percentage of the chord.
- The *leading edge radius* of the airfoil is the radius of curvature given the leading edge shape.

Rotary Wing Planform

Common terms used to describe the helicopter rotor system are shown here. Although there is some variation in systems between different aircraft, the terms shown are generally accepted by most manufacturers. The system shown here is fully articulated:

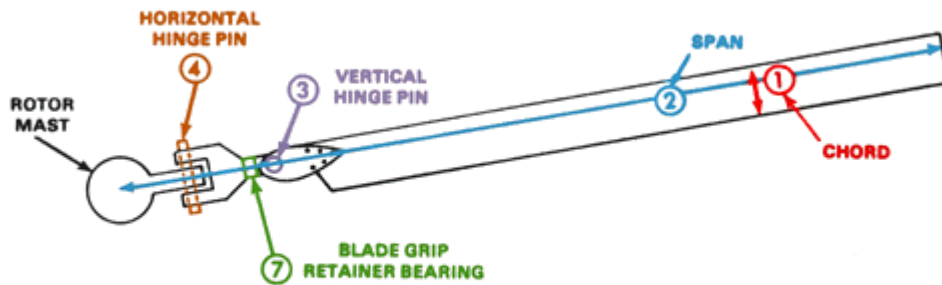

FIGURE 2-11. FULLY ARTICULATED ROTOR SYSTEM.

Semirigid types do not have a vertical or horizontal hinge pin. Instead, the rotor is allowed to teeter or flap by a trunnion bearing that connects the yoke to the mast:

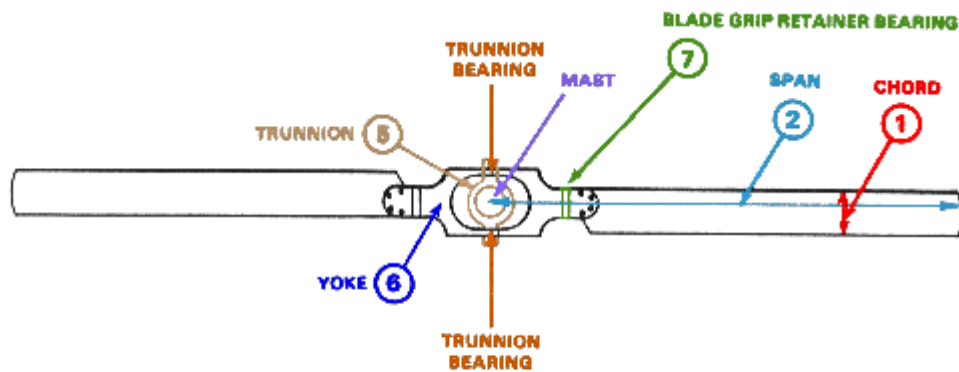

FIGURE 2-12. SEMIRIGID ROTOR SYSTEM.

- The *chord* is the longitudinal dimension of an airfoil section, measured from the leading edge to the trailing edge.
- The *span* is the length of the rotor blade from the point of rotation to the tip of the blade.
- The *vertical hinge pin* (drag hinge) is the axis which permits fore and aft blade movement independent of the other blades in the system.

- The *horizontal hinge pin* is the axis which permits up and down movement of the blade independent of the other blades in the system.
- The *trunnion* is splined to the mast and has two bearings through which it is secured to the yoke. The blades are mounted to the yoke and are free to teeter (flap) around the trunnion bearings.
- The *yoke* is the structural member to which the blades are attached and which fastens the rotor blades to the mast through the trunnion and trunnion bearings.
- The *blade grip retainer bearing* is the bearing which permits rotation of the blade about its spanwise axis so blade pitch can be changed (blade feathering)
- *Blade Twist* is a characteristic built into the rotor blade so angle of incidence is less near the tip than at the root. Blade twist helps distribute the lift evenly along the blade by an increased angle of incidence near the root where blade speed is slower. Outboard portions of the blade that travel faster normally have lower angles of incidence, so less lift is concentrated near the blade tip.



Relative Wind

A knowledge of relative wind is particularly essential for an understanding of aerodynamics of rotary-wing flight because relative wind may be composed of multiple components. Relative wind is defined as the airflow relative to an airfoil:

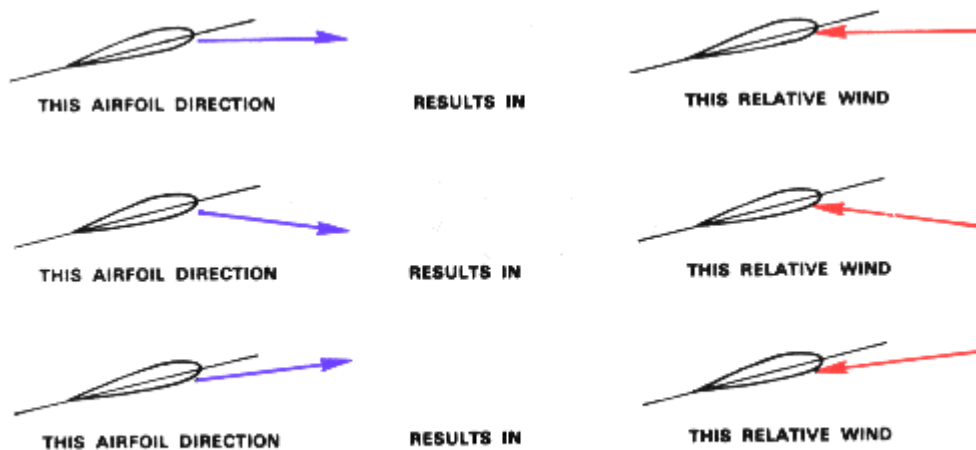

FIGURE 2-13. RELATIVE WIND.

Relative wind is created by movement of an airfoil through the air. As an example, consider a person sitting in an automobile on a no-wind day with a hand extended out the window. There is no airflow about the hand since the automobile is not moving. However, if the automobile is driven at 50 miles per hour, the air will flow under and over the hand at 50 miles per hour. A relative wind has been created by moving the hand through the air. Relative wind flows in the opposite direction that the hand is moving. The velocity of airflow around the hand in motion is the hand's airspeed.

When the helicopter is stationary on a no-wind day, *rotational relative wind* is produced by rotation of the rotor blades. Since the rotor is moving horizontally, the effect is to displace some of the air downward. The blades travel along the same path and pass a given point in rapid succession (a three-bladed system rotating at 320 revolutions per minute passes a given point in the tip-path plane 16 times per second).

This figure illustrates how still air is changed to a column of descending air by rotor blade action:

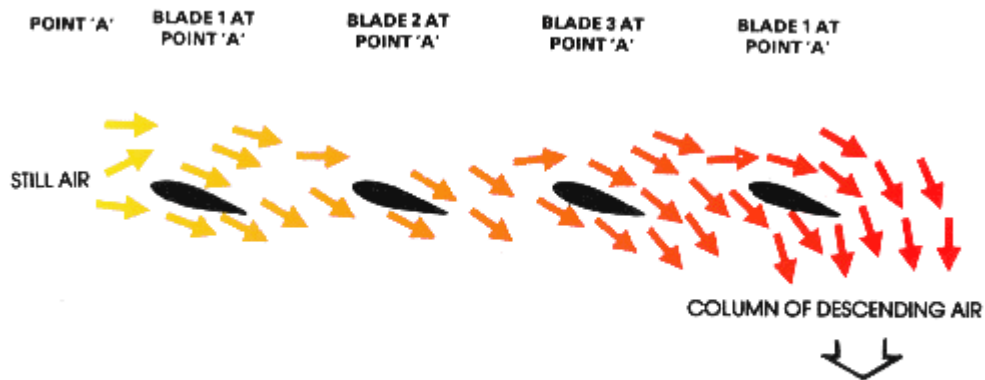

FIGURE 2-14. INDUCED FLOW (DOWNWASH).

This flow of air is called an *induced flow* (downwash). It is most predominant at a hover under still wind conditions. Because the rotor system circulates the airflow down through the rotor disk, the rotational relative wind is modified by the induced flow. Airflow from rotation, modified by induced flow, produces the *resultant relative wind*. In this illustration, angle of attack is reduced by induced flow, causing the airfoil to produce less lift:

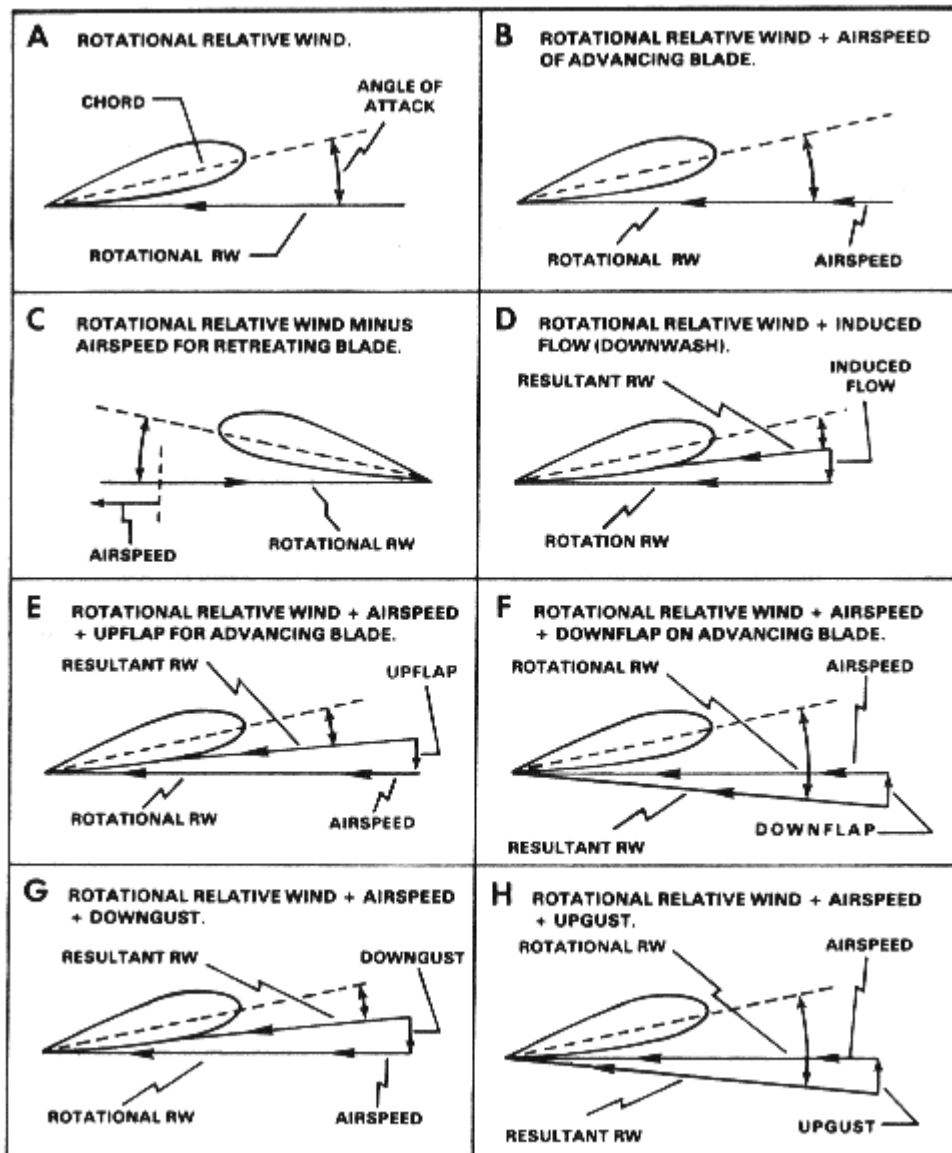

FIGURE 2-15. COMPONENTS OF RELATIVE WIND (RW).

When the helicopter has horizontal motion, the resultant relative wind discussed above is further changed by the helicopter airspeed. Airspeed component of relative wind results from the helicopter moving through the air. It is added to or subtracted from the rotational relative wind, depending on whether the blade is advancing or retreating in relation to the helicopter movement. Induced flow is also modified by introduction of airspeed relative wind. The pattern of air circulation through the disk changes when the aircraft has movement. Generally the downward velocity of induced flow is reduced. The helicopter moves continually into an undisturbed airmass, resulting in less time to develop a vertical airflow pattern. As a result, additional lift is produced from a given blade pitch setting.

Angle of Attack

Angle of attack is an *aerodynamic angle* and is illustrated here:

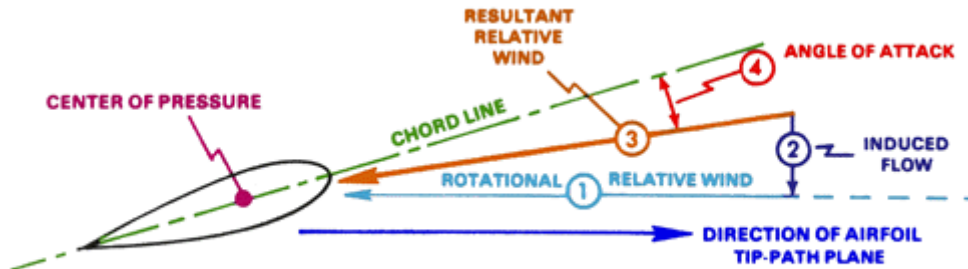

FIGURE 2-16. ANGLE OF ATTACK.

It is defined as the angle between the airfoil chord and its direction of motion relative to the air (resultant relative wind). Several factors may cause rotor blade angle of attack to change. Some are controlled by the pilot and some occur automatically due to the rotor system design. Pilots are able to adjust angle of attack by moving the cyclic and collective pitch controls. However, even when these controls are held stationary, the angle of attack constantly changes as the blade moves around the circumference of the rotor disk. Other factors affecting angle of attack, over which the pilot has little control, are blade flapping, blade flexing, and gusty wind or turbulent air conditions. Angle of attack is one of the primary factors that determines amount of lift and drag produced by an airfoil.

Angle of Incidence

Angle of attack should not be confused with angle of incidence (blade pitch angle). Angle of incidence is the angle between the blade chord line and the plane of rotation of the rotor system. It is a *mechanical angle* rather than an *aerodynamic angle*:



FIGURE 2-17. ANGLE OF INCIDENCE.

In the absence of induced flow and/or aircraft airspeed, angle of attack and angle of incidence are the same. Whenever relative wind is modified by induced flow or aircraft airspeed, then angle of attack is different than angle of incidence.

Total Aerodynamic Force

A total aerodynamic force is generated when a stream of air flows over and under an airfoil that is moving through the air. The point at which the air separates to flow about the airfoil is called the point of impact:

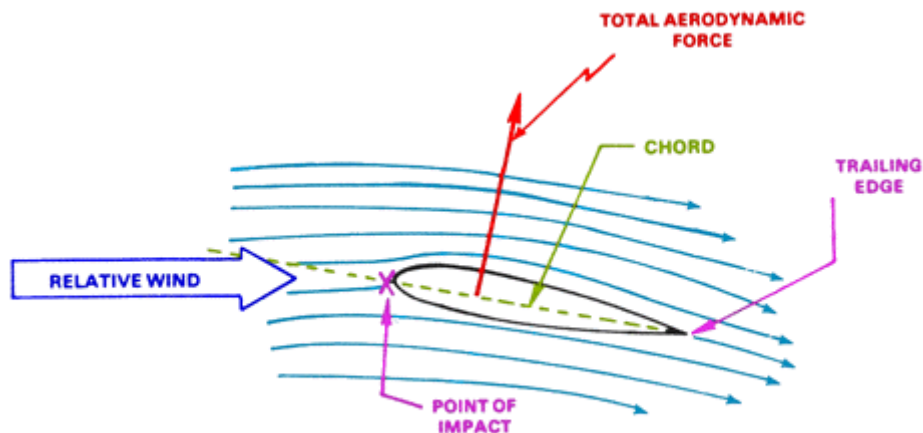

FIGURE 2-18. AIRFLOW AROUND AN AIRFOIL.

A high pressure area or stagnation point is formed at the point of impact. Normally the high pressure area is located at the lower portion of the leading edge, depending on angle of attack. This high pressure area contributes to the overall force produced by the blade.

This picture also shows airflow lines that illustrate how the air moves about the airfoil section. Notice that the air is deflected downward as it passes under the airfoil and leaves the trailing edge. Remember Newton's third law which states "every action has an equal and opposite reaction." Since the air is being deflected downward, an equal and opposite force must be acting upward on the airfoil. This force adds to the total aerodynamic force developed by the airfoil. At very low or zero angles of attack, the deflection force or impact pressure may exert a zero positive force, or even a downward or negative force.

Air passing over the top of the airfoil produces aerodynamic force in another way. The shape of the airfoil causes a low pressure area above the airfoil according to Bernoulli's Principle, and the decrease in pressure on top of the airfoil exerts an upward aerodynamic force. Pressure differential between the upper and lower surface of the airfoil is quite small - in the vicinity of 1 percent. Even a small pressure differential produces substantial force when applied to the large area of a rotor blade.

The total aerodynamic force, sometimes called the resultant force, may be divided into two components called lift and drag. *Lift* acts on the airfoil in a direction perpendicular to the relative wind. *Drag* is the resistance or force that opposes the motion of the airfoil through the air. It acts on the airfoil in a direction parallel to the relative wind:

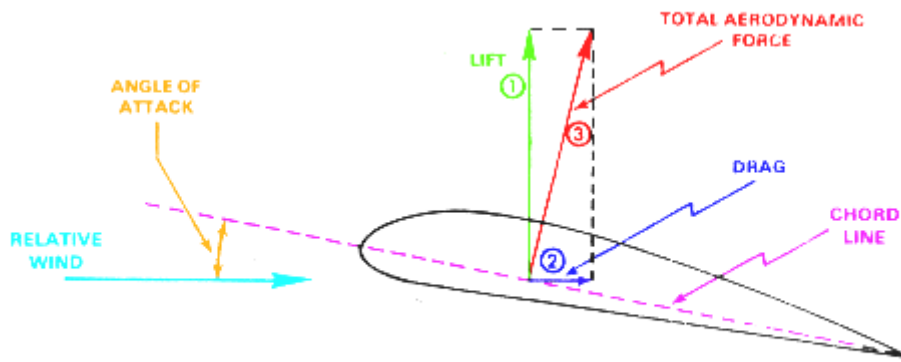

FIGURE 2-19. FORCES ACTING ON AN AIRFOIL.

Many factors contribute to the total lift produced by an airfoil. Increased speed causes increased lift because a larger pressure differential is produced between the upper and lower surfaces. Lift does not increase in direct proportion to speed, but varies as the square of the speed. Thus, a blade traveling at 500 knots has four times the lift of the same blade traveling at only 250 knots. Lift also varies with the area of the blade. A blade area of 100 square feet will produce twice as much lift as a blade area of only 50 square feet. Angle of attack also has an effect on the lift produced. Lift increases as the angle of attack increases up to the stalling angle of attack. Stall angle varies with different blades and is the point at which airflow no longer follows the camber of the blade smoothly. Air density is another factor that directly influences lift.

Two design factors, *airfoil shape* and *airfoil area* are primary elements that determine how much lift and drag a blade will produce. Any change in these design factors will affect the forces produced.

Normally an increase in lift will also produce an increase in drag. Therefore, the airfoil is designed to produce the most lift and the least drag within normal speed ranges.

Pressure Patterns

Distribution of pressure over an airfoil section may be a source of an aerodynamic twisting force as well as lift. A typical example is illustrated by the pressure distribution pattern developed by this cambered (nonsymmetrical) airfoil:

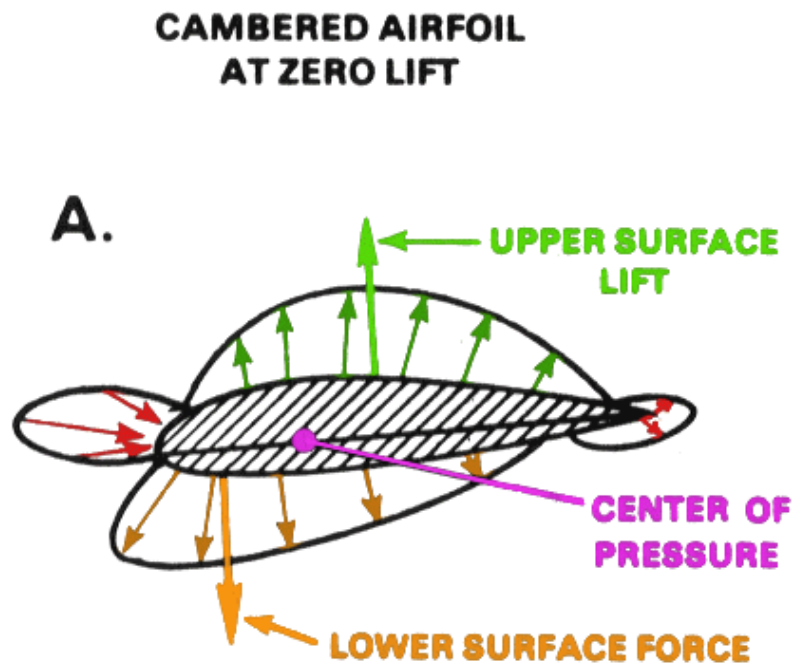

The upper surface has pressures distributed which produce the upper surface lift. The lower surface has pressures distributed which produce the lower surface force. Net lift produced by the airfoil is the difference between lift on the upper surface and the force on the lower surface. Net lift is effectively concentrated at a point on the chord called the *center of pressure*

When angle of attack is increased:

CAMBERED AIRFOIL AT POSITIVE LIFT

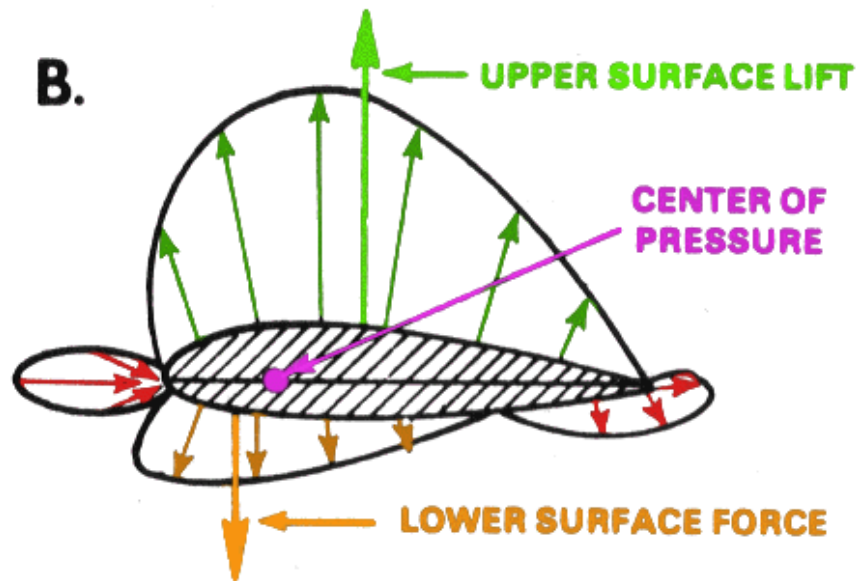

upper surface lift increases relative to the lower surface force. Since the two vectors are not located at the same point along the chord line, a twisting force is exerted about the center of pressure. Center of pressure also moves along the chord line when angle of attack changes, because the two vectors are separated. This characteristic of nonsymmetrical airfoils results in undesirable control forces that must be compensated for if the airfoil is used in rotary wing applications.

Pressure patterns for symmetrical airfoils are distributed differently than for nonsymmetrical airfoils:

SYMMETRICAL AIRFOIL AT ZERO LIFT

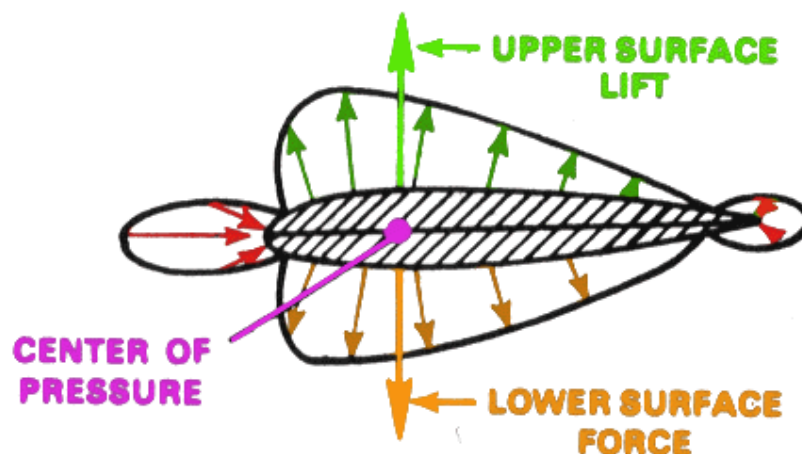

Upper surface lift and lower surface lift vectors are opposite each other instead of being separated along the chord line as in the cambered airfoil.

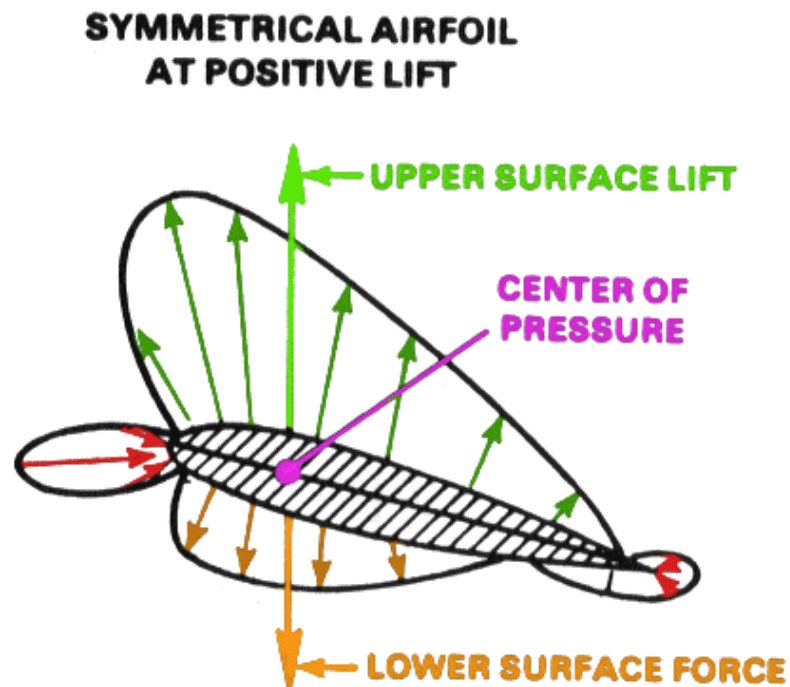

When the angle of attack is increased to develop positive lift, the vectors remain essentially opposite each other and the twisting force is not exerted. Center of pressure remains relatively constant even when angle of attack is changed. This is a desirable characteristic for a rotor blade, because it changes angle of attack constantly during each revolution.

Drag

Drag is the force that opposes the motion of an aircraft through the air. *Total drag* produced by an aircraft is the sum of the *profile drag*, *induced drag*, and *parasite drag*. Total drag is primarily a function of airspeed. The airspeed that produces the lowest total drag normally determines the aircraft best-rate-of-climb speed, minimum rate-of-descent speed for autorotation, and maximum endurance speed.

The following picture illustrates the different forms of drag versus airspeed:

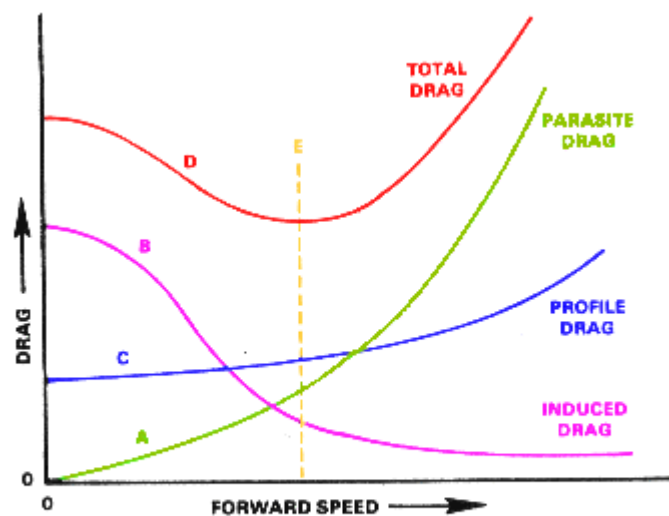

FIGURE 2-23. DRAG/AIRSPEED RELATIONSHIP.

- *Profile drag* is the drag incurred from frictional resistance of the blades passing through the air. It does not change significantly with angle of attack of the airfoil section, but increases moderately as airspeed increases.
- *Induced drag* is the drag incurred as a result of production of lift. Higher angles of attack which produce more lift also produce increased induced drag. In rotary-wing aircraft, induced drag decreases with increased aircraft airspeed. The induced drag is the portion of the *total aerodynamic force* which is oriented in the direction opposing the movement of the airfoil. Think of it as lift which is in the *wrong direction*.
- *Parasite drag* is the drag incurred from the nonlifting portions of the aircraft. It includes the form drag and skin friction associated with the fuselage, cockpit, engine cowlings, rotor hub, landing gear, and tail boom to mention a few. Parasite drag increases with airspeed.

Curve "A" shows that parasite drag is very low at slow airspeeds and increases with higher airspeeds. Parasite drag goes up at an increasing rate at airspeeds above the midrange.

Curve "B" shows how induced drag decreases as aircraft airspeed increases. At a hover, or at lower airspeeds, induced drag is highest. It decreases as airspeed increases and the helicopter moves into undisturbed air.

Curve "C" shows the profile drag curve. Profile drag remains relatively constant throughout the speed range with some increase at the higher airspeeds.

Curve "D" shows total drag and represents the sum of the other three curves. It identifies the airspeed range, line "E", at which total drag is lowest. That airspeed is the best airspeed for maximum endurance, best rate of climb, and minimum rate of descent in autorotation.

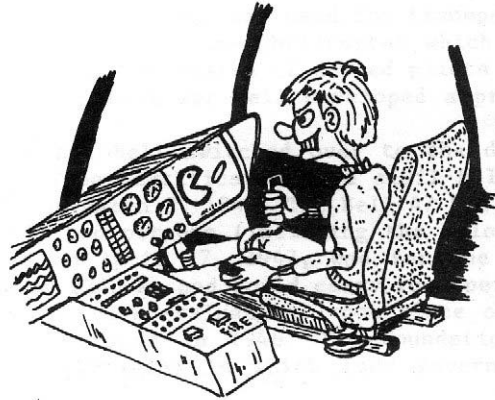

Centrifugal Force

Helicopter rotor systems depend primarily on rotation to produce relative wind which develops the aerodynamic force required for flight. Because of its rotation and weight, the rotor system is subject to forces and moments peculiar to all rotating masses. One of the forces produced is *centrifugal force*. It is defined as the force that tends to make rotating bodies move away from the center of rotation. Another force produced in the rotor system is *centripetal force*. It is the force that counteracts centrifugal force by keeping an object a certain radius from the axis of rotation.

The rotating blades of a helicopter produce very high centrifugal loads on the rotor head and blade attachment assemblies. As a matter of interest, centrifugal loads may be from 6 to 12 tons at the blade root of two to four passenger helicopters. Larger helicopters may develop up to 40 tons of centrifugal load on each blade root. In rotary-wing aircraft, centrifugal force is the dominant force affecting the rotor system. All other forces act to modify this force.

When the rotor blades are at rest, they droop due to their weight and span. In fully articulated systems, they rest against a static or droop stop which prevents the blade from descending so low it will strike the aircraft (or ground!). When the rotor system begins to turn, the blade starts to rise from the static position because of the centrifugal force. At operating speed, the blades extend straight out even though they are at flat pitch and are not producing lift.

As the helicopter develops lift during takeoff and flight, the blades rise above the "straight out" position and assume a *coned* position. Amount of coning depends on RPM, gross weight, and G-Forces experienced during flight. If RPM is held constant, coning increases as gross weight and G-force increase. If gross weight and G-forces are constant, decreasing RPM will cause increased coning. Excessive coning can occur if RPM gets too low, gross weight is too high, or if excessive G-forces are experienced. Excessive coning can cause undesirable stresses on the blade and a decrease of total lift because of a decrease in effective disk area:

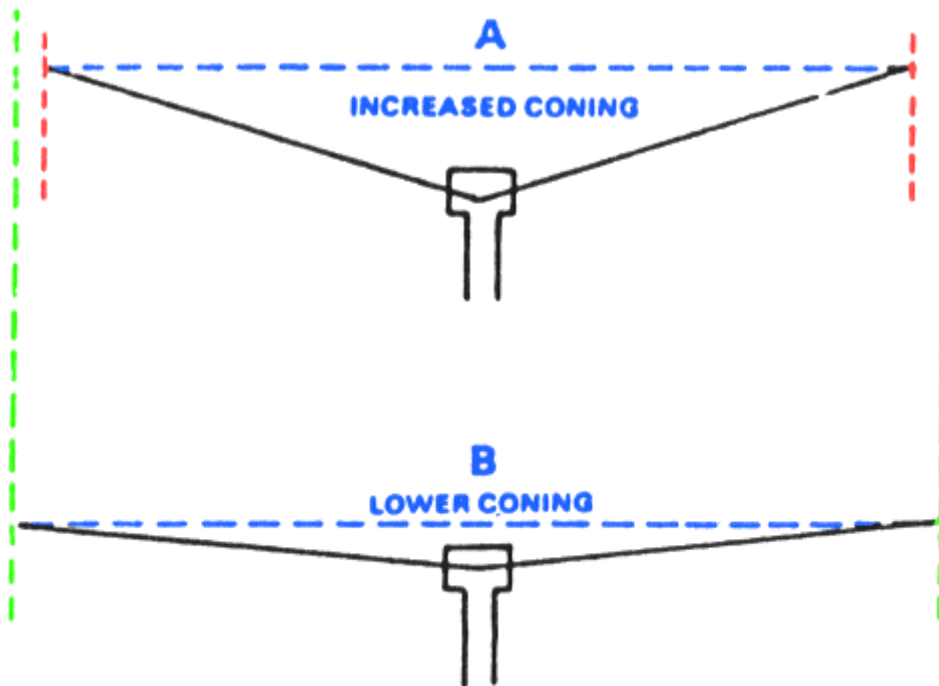

FIGURE 2-30. LOSS OF DISK AREA DUE TO CONING.

Notice that the effective diameter of the rotor disk with increased coning is less than the diameter of the other disk with less coning. A smaller disk diameter has less potential to produce lift.

Centrifugal force and lift effects on the blade can be illustrated best by a vector. First look at a rotor shaft and blade just rotating:



FIGURE 2 31. CENTRIFUGAL FORCE.

Now look at the same rotor shaft and blade when a vertical force is pushing up on the tip of the blade:



FIGURE 2-32. LIFT AND CENTRIFUGAL FORCE.

The vertical force is lift produced when the blades assume a positive angle of attack. The horizontal force is caused by the centrifugal force due to rotation. Since one end of the blade is attached to the rotor shaft, it is not free to move. The other end can move and will assume a position that is the resultant of the forces acting on it:

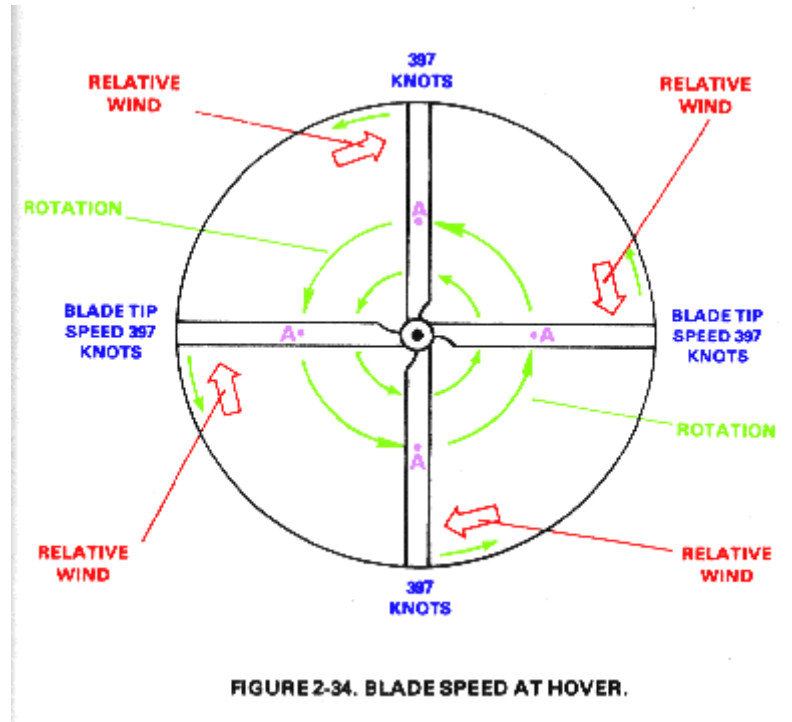

FIGURE 2-33. RESULTANT OF LIFT AND CENTRIFUGAL FORCES.

The blade position is coned and is a resultant of the two forces, lift and centrifugal force, acting on it.

Rotational Velocities

During hovering, airflow over the rotor blades is produced by rotation of the rotor system. Here is a picture showing a typical helicopter rotor system:



Blade speed near the main rotor shaft is much less because the distance traveled at the smaller radius is relatively small. At point "A", half way from the rotor shaft to the blade tip, the blade speed is only TBS knots which is one-half the tip speed. Speed at any point on the blades varies with the radius or distance from the center of the main rotor shaft. An extreme airspeed differential between the blade tip and root is the result. The lift differential between the blade root and tip is even larger because lift varies as the square of the speed. Therefore, when speed is doubled, lift is increased four times. This means that the lift at point "A" would be only one-fourth as much as lift at the blade tip (assuming the airfoil shape and angle of attack are the same at both points).

Because of the potential lift differential along the blade resulting primarily from speed variation, blades are designed with a twist. Blade twist provides a higher pitch angle at the root where speed is low and lower pitch angles nearer the tip where speed is higher. This design helps distribute the lift more evenly along the blade. It increases both the induced air velocity and the blade loading near the inboard section of the blade.

This picture compares the lift of a twisted and untwisted blade:

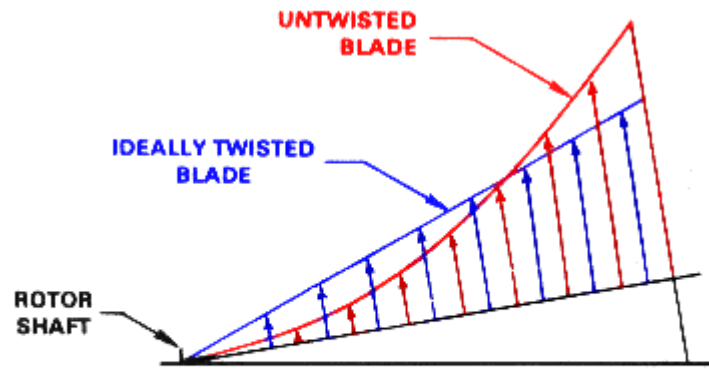

FIGURE 2-35. DISTRIBUTION OF LIFT ON TWISTED AND UNTWISTED BLADE.

Note that the twisted blade generates more lift near the root and less lift at the tip than the untwisted blade.

Hovering

Hovering is the term applied when a helicopter maintains a constant position at a selected point, usually a few feet above the ground (but not always, helicopters can hover high in the air, given sufficient power). For a helicopter to hover, the main rotor must supply lift equal to the total weight of the helicopter. With the blades rotating at high velocity, an increase of blade pitch (angle of attack) would induce the necessary lift for a hover. The forces of lift and weight reach a state of balance during a stationary hover.

Hovering is actually an element of vertical flight. Assuming a no-wind condition, the tip-path plane of the blades will remain horizontal. If the angle of attack of the blades is increased while their velocity remains constant, additional vertical thrust is obtained. Thus, by upsetting the vertical balance of forces, helicopters can climb or descend vertically.

Airflow during hovering

At a hover, the rotor tip vortex (air swirl at the tip of the rotor blades) reduces the effectiveness of the outer blade portions. Also, the vortices of the preceding blade severely affect the lift of the following blades. If the vortex made by one passing blade remains a vicious swirl for some number of seconds, then two blades operating at 350 RPM create 700 longlasting vortex patterns per minute. This continuous creation of new vortices and ingestion of existing vortices is a primary cause of high power requirements for hovering.

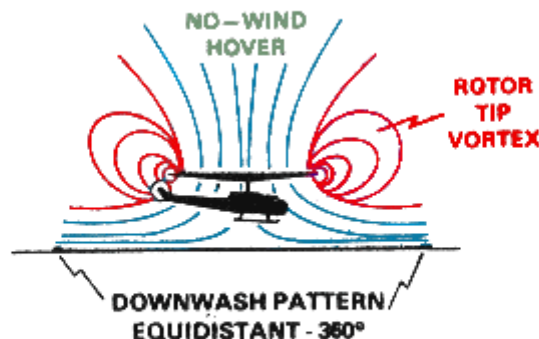

FIGURE 2-36. ROTOR TIP VORTEX AT A HOVER.

During hover, the rotor blades move large volumes of air in a downward direction. This pumping process uses lots of horsepower and accelerates the air to relatively high velocities. Air velocity under the helicopter may reach 60 to 100 knots, depending on the size of the rotor and the gross weight of the helicopter. The air flow pattern of a hovering helicopter is illustrated here:

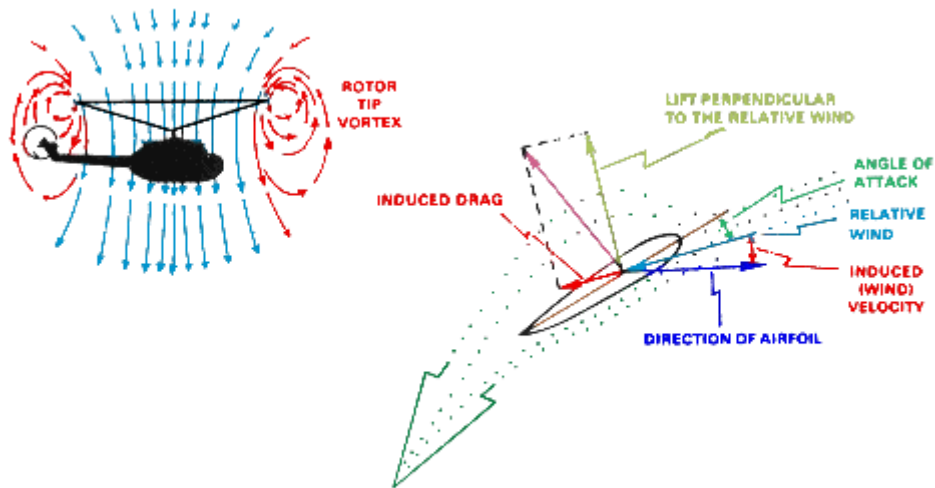

FIGURE 2-37. OUT-OF-GROUND-EFFECT HOVER.

Note how the downwash (induced flow) of air has introduced another element into the relative wind which alters the angle of attack of the airfoil. When there is no induced flow, the relative wind is opposite and parallel to the flightpath of the airfoil. In the hovering case, the downward airflow alters the relative wind and changes the angle of attack so less aerodynamic force is produced. This condition requires the pilot to increase collective pitch to produce enough aerodynamic force to sustain a hover. Although this does increase the lift, it also increases the induced drag, and so total power required is higher.

Ground effect

The high power requirement needed to hover out of ground effect is reduced when operating in ground effect. Ground effect is a condition of improved performance encountered when operating near (within 1/2 rotor diameter) of the ground. It is due to the interference of the surface with the airflow pattern of the rotor system, and it is more pronounced the nearer the ground is approached. Increased blade efficiency while operating in ground effect is due to two separate and distinct phenomena.

First and most important is the reduction of the velocity of the induced airflow. Since the ground interrupts the airflow under the helicopter, the entire flow is altered. This reduces downward velocity of the induced flow. The result is less induced drag and a more vertical lift vector. The lift needed to sustain a hover can be produced with a reduced angle of attack and less power because of the more vertical lift vector:

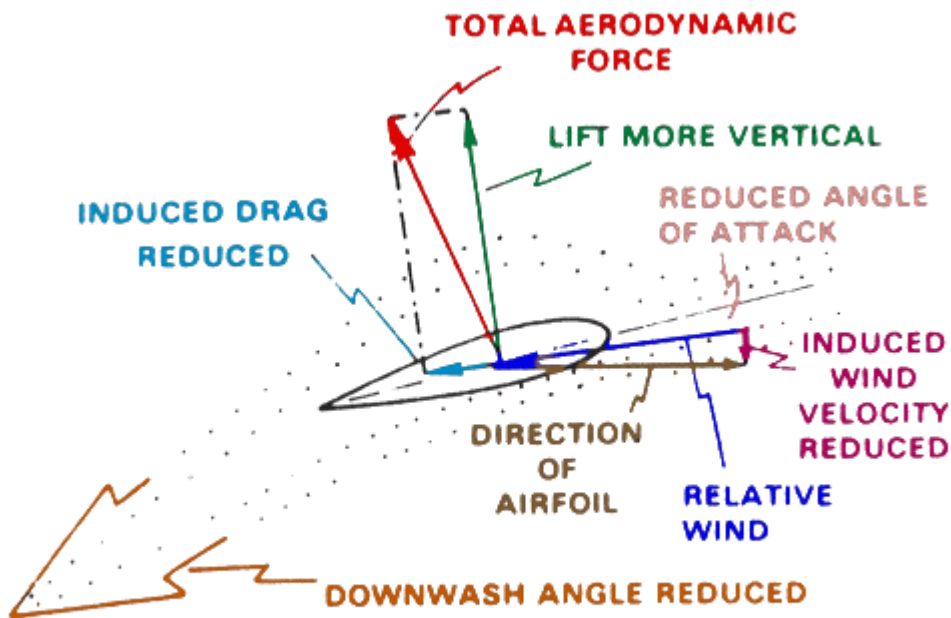
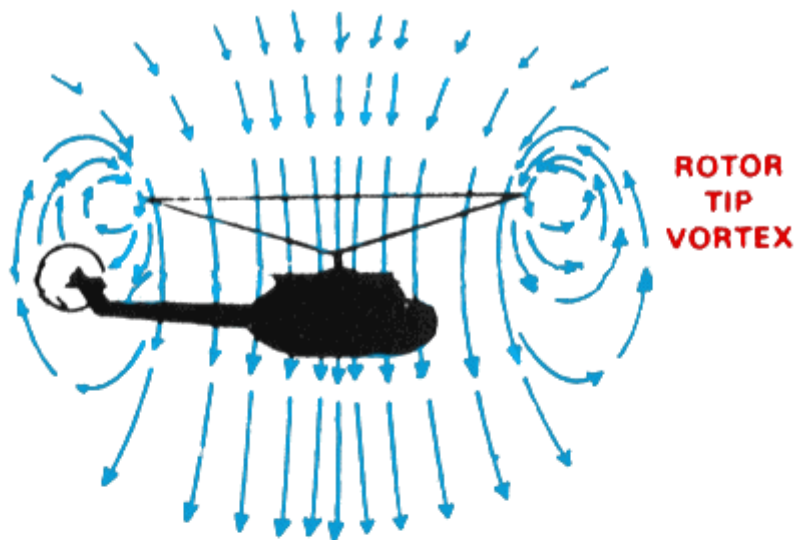

FIGURE 2-38. IN-GROUND-EFFECT HOVER.

The second phenomena is a reduction of the rotor *tip vortex*:



OUT-OF-GROUND-EFFECT HOVER.

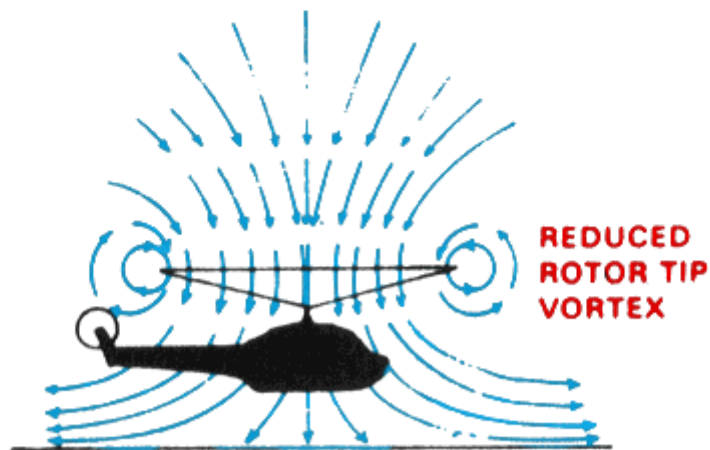

FIGURE 2-38. IN-GROUND-EFFECT HOVER.

When operating in ground effect, the downward and outward airflow pattern tends to restrict vortex generation. This makes the outboard portion of the rotor blade more efficient and reduces overall system turbulence caused by ingestion and recirculation of the vortex swirls.

Rotor efficiency is increased by ground effect up to a height of about one rotor diameter for most helicopters. This figure illustrates the percent increase in rotor thrust experienced at various rotor heights:

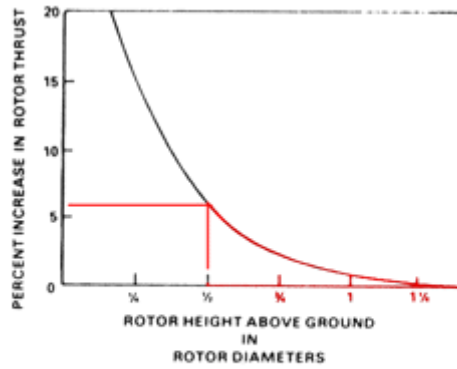

FIGURE 2-39. INCREASED LIFT CAPABILITY IN-GROUND-EFFECT.

At a rotor height of one-half rotor diameter, the thrust is increased about 7 percent. At rotor heights above one rotor diameter, the thrust increase is small and decreases to zero at a height of about 1 1/4 rotor diameters.

Maximum ground effect is accomplished when hovering over smooth paved surfaces. While hovering over tall grass, rough terrain, revetments, or water, ground effect may be seriously reduced. This phenomena is due to the partial breakdown and cancellation of ground effect and the return of large vortex patterns with increased downwash angles.

Two identical airfoils with equal blade pitch angles are compared in the following figure:

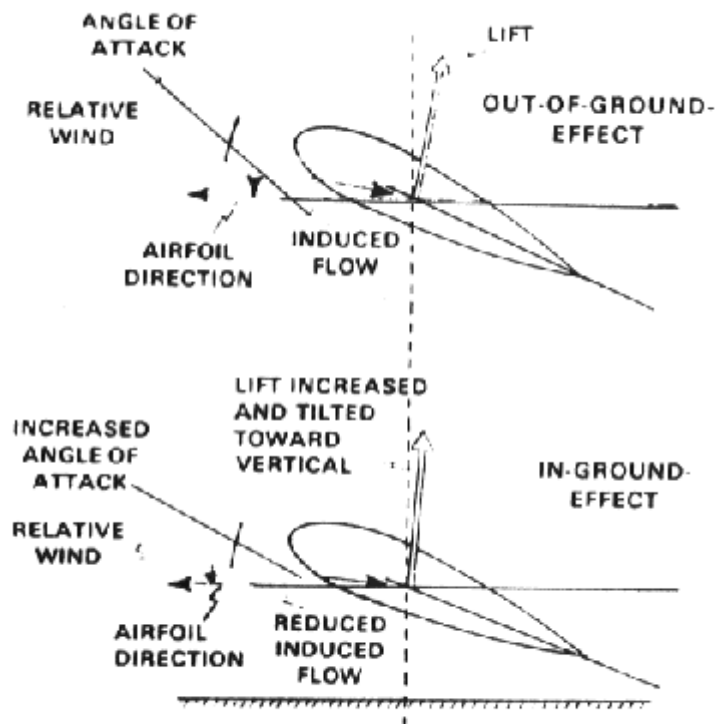
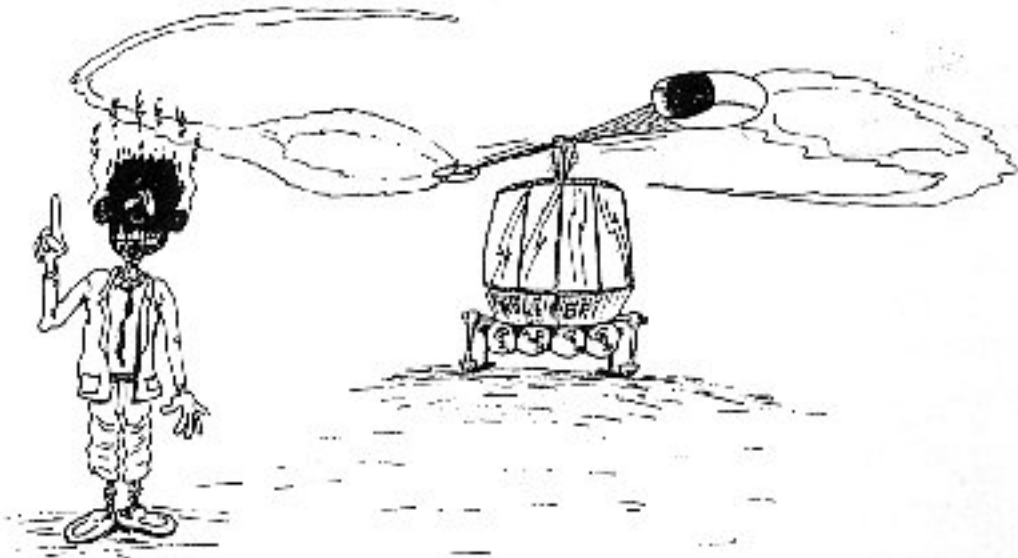

FIGURE 2-40. EFFECT OF GROUND PROXIMITY AT A CONSTANT PITCH ANGLE.

The top airfoil is out-of-ground-effect while the bottom airfoil is in-ground-effect. The airfoil that is in-ground-effect is more efficient because it operates at a larger angle of attack and produces a more vertical lift vector. Its increased efficiency results from a smaller downward induced wind velocity which increases angle of attack. The airfoil operating out-of-ground-effect is less efficient because of increased induced wind velocity which reduces angle of attack.

If a helicopter hovering out-of-ground-effect descends into a ground-effect hover, blade efficiency increases because of the more favorable induced flow. As efficiency of the rotor system increases, the pilot reduces blade pitch angle to remain in the ground-effect hover. Less power is required to maintain however in-ground-effect than for the out-of-ground-effect hover.



Torque

In accordance with Newton's law of action and reaction, the helicopter fuselage tends to rotate in the direction opposite to the rotor blades. This effect is called *torque*. Torque must be counteracted and or controlled before flight is possible. In tandem rotor and coaxial helicopter designs, the rotors turn in opposite directions to neutralize or eliminate torque effects. In tip-jet helicopters, power originates at the blade tip and equal and opposite reaction is against the air; there is no torque between the rotor and the fuselage. However, the torque problem is especially important in single main rotor helicopters with a fuselage mounted power source. The torque effect on the fuselage is a direct result of the work/resistance of the main rotor. Therefore torque is at the geometric center of the main rotor. Torque results from the rotor being driven by the engine power output. Any change in engine power output brings about a corresponding change in torque effect. Furthermore, power varies with the flight maneuver and results in a variable torque effect that must be continually corrected.

Antitorque Rotor

Compensation for torque in the single main rotor helicopter is accomplished by means of a variable pitch antitorque rotor (tail rotor) located on the end of a tail boom extension at the rear of the fuselage. Driven by the main rotor at a constant ratio, the tail rotor produces thrust in a horizontal plane opposite to torque reaction developed by the main rotor. Since torque effect varies during flight when power changes are made, it is necessary to vary the thrust of the tail rotor. Antitorque pedals enable the pilot to compensate for torque variance. A significant part of the engine power is required to drive the tail rotor, especially during operations when maximum power is used. From 5 to 30 percent of the available engine power may be needed to drive the tail rotor depending on helicopter size and design. Normally, larger helicopters use a higher percent of engine power to counteract torque than do smaller aircraft. A helicopter with 9,500 horsepower might require 1,200 horsepower to drive the tail rotor, while a 200 horsepower aircraft might require only 10 horsepower for torque correction.

Heading Control

In addition to counteracting torque, the tail rotor and its control linkage also permit control of the helicopter heading during flight. Application of more control than is necessary to counteract torque will cause the nose of the helicopter to swing in the direction of pedal movement. To maintain a constant heading at a hover or during takeoff or approach, the pilot must use antitorque pedals to apply just enough pitch on the tail rotor to neutralize torque and hold a slip if necessary. Heading control in forward trimmed flight is normally accomplished with cyclic control, using a coordinated bank and turn to the desired heading. Application of antitorque pedals will be required when power changes are made.

In an autorotation, some degree of right pedal is required to maintain correct trim. When torque is not present, mast thrust bearing friction tends to turn the fuselage in the same direction as main rotor rotation. To counteract this friction, the tail rotor thrust is applied in an opposite direction to counter the frictional forces.

Translating tendency

During hovering flight, the single rotor helicopter has a tendency to drift laterally to the right due to the lateral thrust being supplied by the tail rotor. The pilot may prevent right lateral drift of the helicopter by tilting the main rotor disk to the left. This lateral tilt results in a main rotor force to the left that compensates for the tail rotor thrust to the right.

Helicopter design usually includes one or more features which help the pilot compensate for translating tendency.

- Flight control rigging may be designed so the rotor disk is tilted slightly left when the cyclic control is centered.
- The collective pitch control system may be designed so that the rotor disk tilts slightly left as collective pitch is increased to hover the aircraft.
- The main transmission may be mounted so that the mast is tilted slightly to the left when the helicopter fuselage is laterally level.

Translational lift

The efficiency of the hovering rotor system is improved with each knot of incoming wind gained by horizontal movement or surface wind. As the incoming wind enters the rotor system, turbulence and vortices are left behind and the flow of air becomes more horizontal. All of these changes improve the efficiency of the rotor system and improve aircraft performance.

Improved rotor efficiency resulting from directional flight is called *translational lift*. The following picture shows an airflow pattern at airspeeds between 1-5 knots:

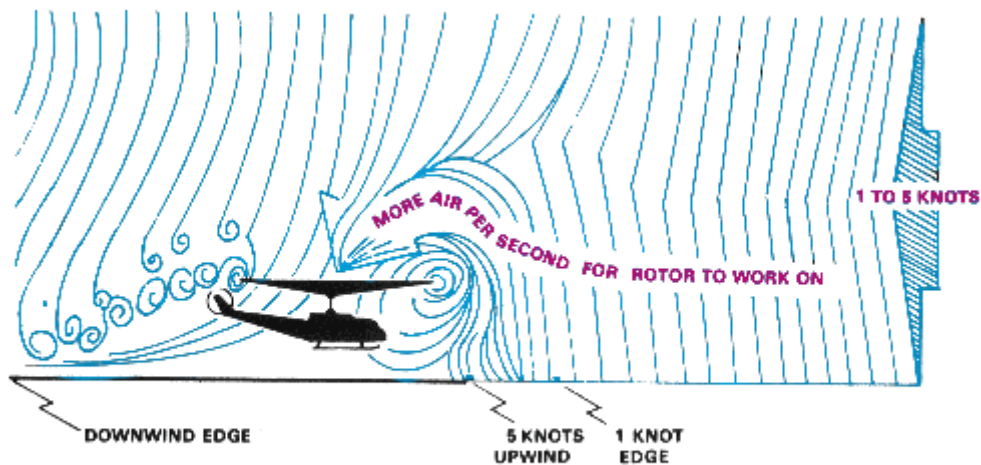

FIGURE 2-46. TRANSLATIONAL LIFT AT 1 to 5 KNOTS.

Note how the downwind vortex is beginning to dissipate and induced flow down through the rear of the rotor disk is more horizontal than at a hover.

This next picture shows the airflow pattern at a speed of 10-15 knots. Airflow is much more horizontal than at a hover. The leading edge of the downwash pattern is being overrun and is well back under the helicopter nose. At about 16 to 24 knots (depending upon the size, blade area, and RPM of the rotor system) the rotor completely outruns the recirculation of old vortices, and begins to work in relatively clean air:

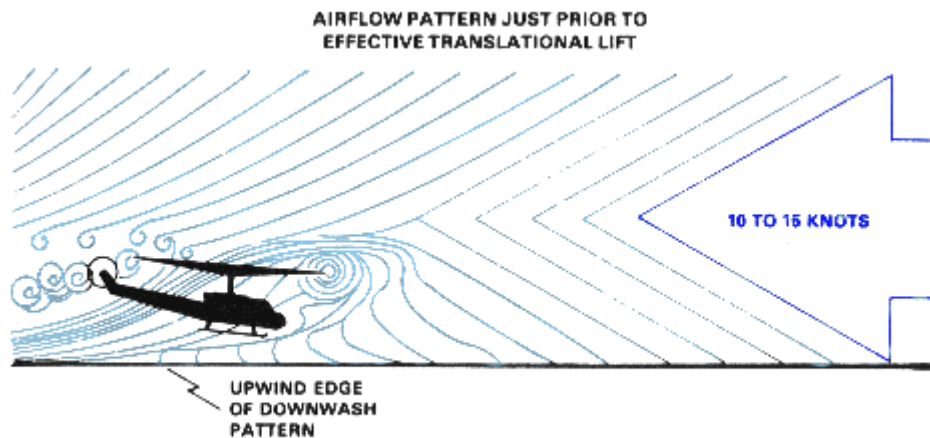
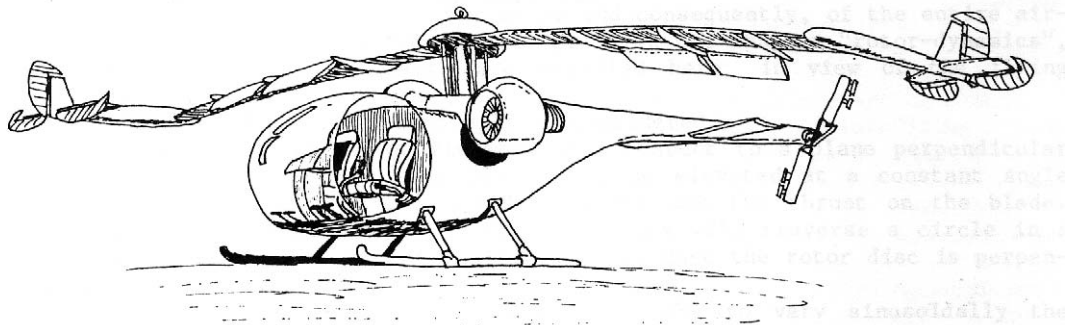

FIGURE 2-47. TRANSLATIONAL LIFT AT 10 TO 15 KNOTS.

The air passing through the rotor system is nearly horizontal, depending on helicopter forward air speed.

As the helicopter speed increases, translational lift becomes more effective and causes the nose to rise, or pitch up (sometimes called blowback). This tendency is caused by the combined effects of dissymmetry of lift and transverse flow. Pilots must correct for this tendency in order to maintain a constant rotor disk attitude that will move the helicopter through the speed range where blowback occurs. If the nose is permitted to pitch up while passing through this speed range, the aircraft may also tend to roll to the right.

When the single main rotor helicopter transitions from hover to forward flight, the tail rotor becomes more aerodynamically efficient. Efficiency increases because the tail rotor works in progressively less turbulent air as speed increases. As tail rotor efficiency improves, more thrust is produced. This causes the aircraft nose to yaw left if the main rotor turns counterclockwise. During a takeoff where power is constant, the pilot must apply right pedal as speed increases to correct for the left yaw tendency.



Transverse Flow Effect

In forward flight, air passing through the rear portion of the rotor disk has a greater downwash angle than air passing through the forward portion:

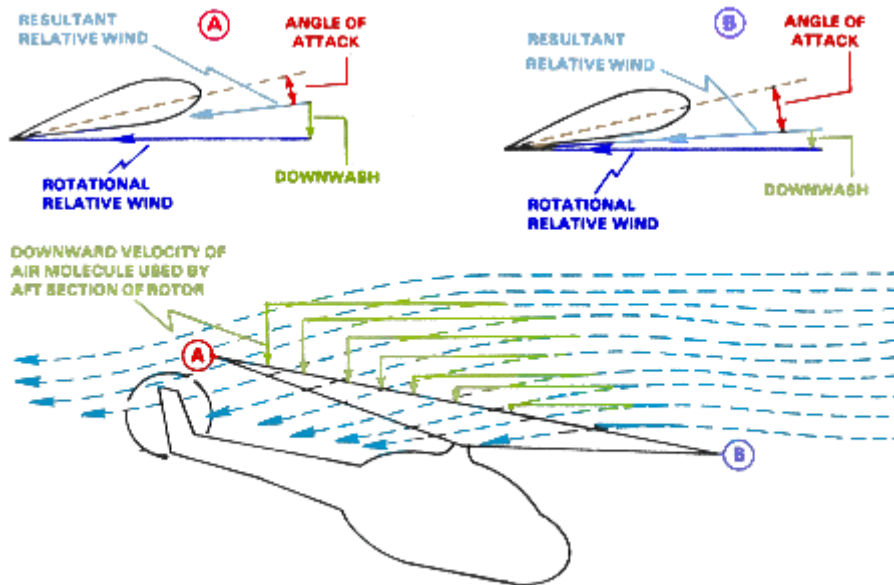

FIGURE 2-48. TRANSVERSE FLOW EFFECT.

The downward flow at the rear of the rotor disk causes a reduced angle of attack, resulting in less lift. Increased angle of attack and more lift is produced at the front portion of the disk because airflow is more horizontal. These differences between the fore and aft parts of the rotor disk are called transverse flow effect. They cause unequal drag in the fore and aft parts of the disk resulting in vibrations that are easily recognizable by the pilot. The vibrations are more noticeable for most helicopters between 10 and 20 knots.

Dissymmetry of Lift

Dissymmetry of lift is the difference in lift that exists between the advancing half of the rotor disk and the retreating half. It is caused by the fact that in directional flight the aircraft relative wind is added to the rotational relative wind on the advancing blade, and subtracted on the retreating blade. The blade passing the tail and advancing around the right side of the helicopter has an increasing airspeed which reaches maximum at the 3 o'clock position. As the blade continues, the airspeed reduces to essentially rotational airspeed over the nose of the helicopter. Leaving the nose, the blade airspeed progressively decreases and reaches minimum airspeed at the 9 o'clock position. The blade airspeed then increases progressively and again reaches rotational airspeed as it passes over the tail.

Note the shaded circle in the picture labeled "REVERSE FLOW":

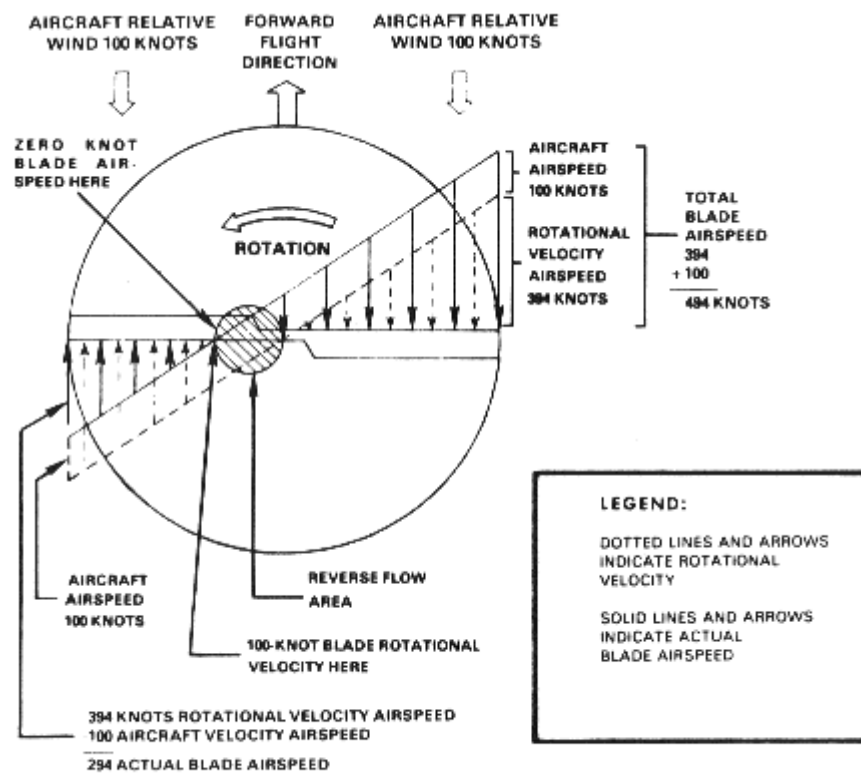

FIGURE 2-49. DISSYMMETRY OF LIFT.

Blade airspeed at the outboard edge of the shaded circle is 0 knots. Within the reverse flow area, the air actually moves over the blade backwards from trailing edge to leading edge. From the reverse flow area out to the blade tip, the blade airspeed progressively increases up to 294 knots.

At an aircraft airspeed of 100 knots, a 200 knot blade airspeed differential exists between the advancing and retreating blades. Since lift increases as the square of the airspeed, a potential lift variation exists between the advancing and retreating sides of the rotor disk. This lift differential must be compensated for, or the helicopter would not be controllable.

To compare the lift of the advancing half of the disk area to the lift of the retreating half, the lift equation can be used. In forward flight, two factors in the lift formula, density ratio and blade area, are the same for both the advancing and retreating blades. The airfoil shape is fixed for a given

blade. The only remaining variables are changes in blade angle of attack and blade airspeed. These two variables must compensate for each other during forward flight to overcome dissymmetry of lift.

Two factors, *rotor RPM* and *aircraft airspeed*, control blade airspeed during flight. Both factors are variable to some degree, but must remain within certain operating limits. Angle of attack remains as the one variable that may be used by the pilot to compensate for dissymmetry of lift. The pitch angle of the rotor blades can be varied throughout their range, from flat pitch to the stalling pitch angle, to change angle of attack and to compensate for lift differential.

The following picture shows the relationship between blade pitch angle and blade airspeed during forward flight:

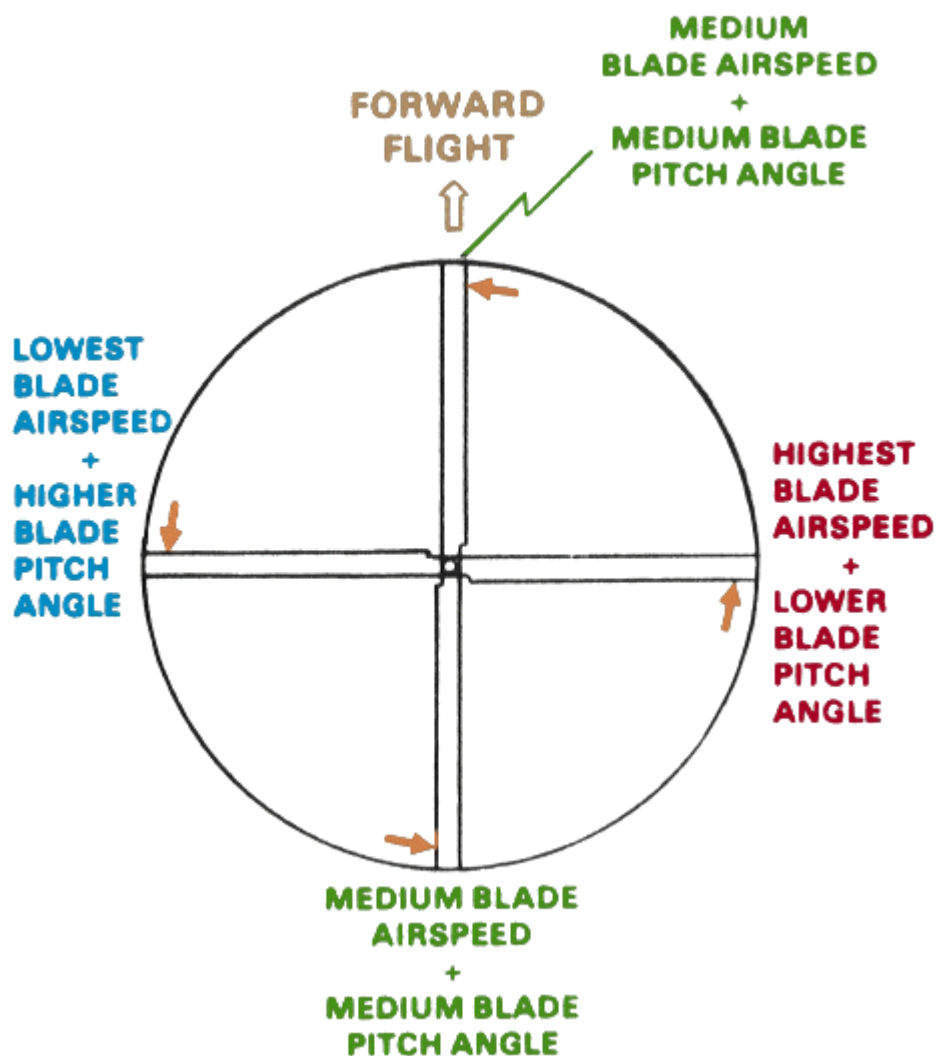

Note that blade pitch angle is lower on the advancing side of the disk to compensate for increased blade airspeed on that side. Blade pitch angle is increased on the retreating blade side to compensate for decreased blade airspeed on that side. These changes in blade pitch are introduced either through the blade feathering mechanism or blade flapping. When made with the blade feathering mechanism, the changes are called *cyclic feathering*. Pitch changes are made to individual blades independent of the others in the system and are controlled by the pilot's cyclic pitch control.

Tail Rotor Dissymmetry of Lift

The tail rotor experiences dissymmetry of lift during forward flight, because it also has advancing and retreating blades. Dissymmetry is corrected for by a flapping hinge action. Two basic types of flapping hinges, the *delta* and the *offset* hinge, are used on most contemporary helicopters. The delta hinge is not oriented parallel to the blade chord:

(a) Plain flapping hinge. (b) Delta-three hinge combines flapping and cyclic feathering.

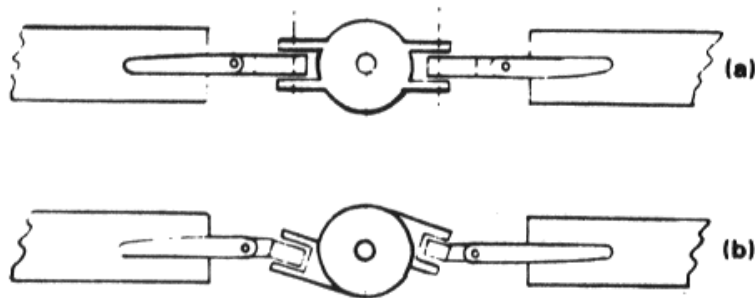

FIGURE 2-51. FLAPPING HINGES.

It is designed so that flapping automatically introduces cyclic feathering which corrects for dissymmetry of lift. The offset hinge is located outboard from the hub:

Flapping hinge offset from center produces moments without disk tilt.

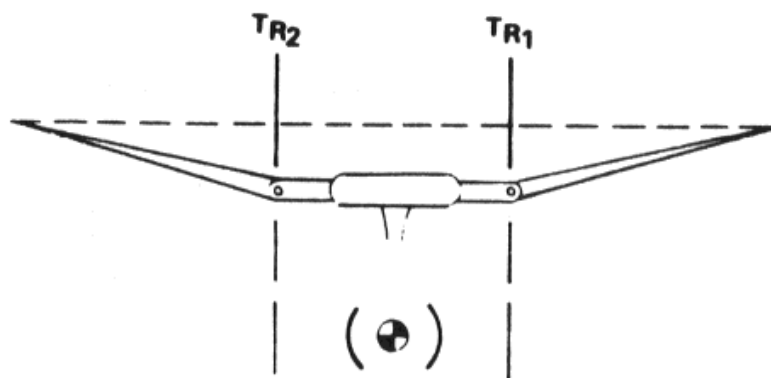

FIGURE 2-52. OFFSET FLAPPING HINGE.

The offset hinge uses centrifugal force to produce substantial forces that act on the hub. One important advantage of offset hinges is the presence of control regardless of lift condition, since centrifugal force is independent of lift.

Flapping

Flapping can be pretty hard to understand at first, although it really is a fairly simple concept. A couple things you need to understand is the relationship between angle of attack and relative wind. Relative wind is simply the direction the air seems to be coming at you because of your motion. When you stick your hand out of a moving car window, the wind hitting it seems to be coming from directly in front of you. The wind will always seem to be moving in the opposite direction of your motion. For instance, in the car example, the car is moving forward, and the wind seems to be moving backward.

Now lets change the example a little bit. Take a hardcover book in your hand, and drop it. Think about a little person glued to the bottom of the book. As the book falls, he will feel the wind seem to come directly up at him from the ground. Again, this is relative wind due to the motion of the book:

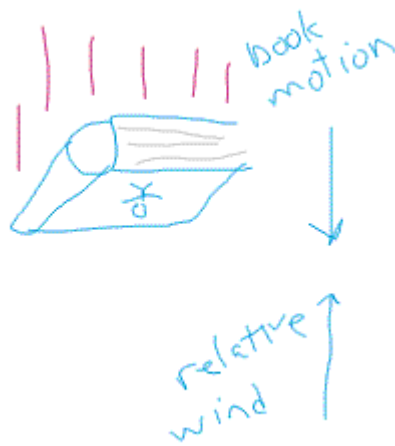

Instead of dropping the book, let's slide it along a table sideways. The table is there to prevent it from falling, so the only motion will be sideways motion. For this exercise, we let the little guy stand on top so he won't be squished:

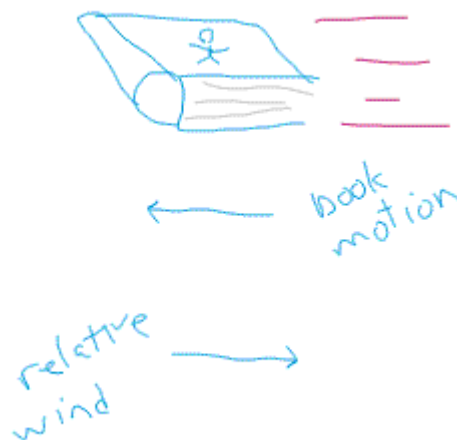

What if we remove the table, throw the book sideways, allowing it to also fall toward the ground. It will have two components of motion, one horizontal and one vertical, like this:

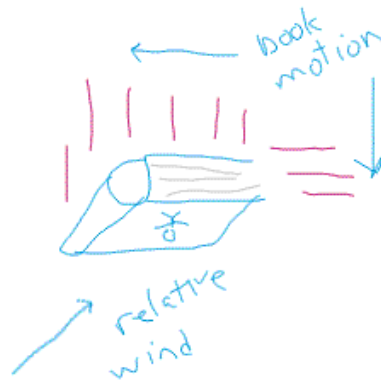

Note that the relative wind is the combination of the horizontal and vertical motions. To the poor little guy about to be squished again, it seems to be coming at him from an angle, somewhere between the vertical and horizontal. Now let's use a tiny bit of math. If we draw the blue arrows to represent the two components of motion, horizontal and vertical, and then we extend red lines down from the top arrowhead and to the left from the bottom arrowhead until they meet, we can then draw the green line back to the origin of the two vectors. The green line is a vector which will show us the direction the relative wind is coming at the little guy on the book:

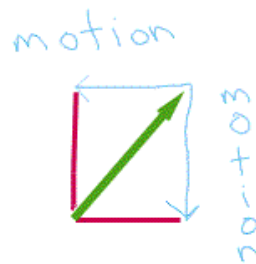

Notice that the two blue lines are about the same length, and that the angle ends up being about 45 degrees. That's not by chance. Let's take a look at what happens if we make the horizontal component of motion be twice as fast as the vertical component:

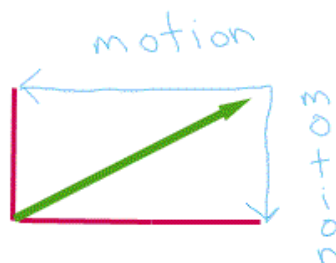

Notice how the angle has changed! Because the horizontal component is larger, the angle seems to be more horizontal than vertical. We can calculate the angle this way, as long as we know the horizontal component and vertical component of motion.

Okay, what's all this got to do with flapping? If it's not already obvious, the book represents the rotor blade. Let's see a picture of a rotor blade that is spinning, but not flapping:

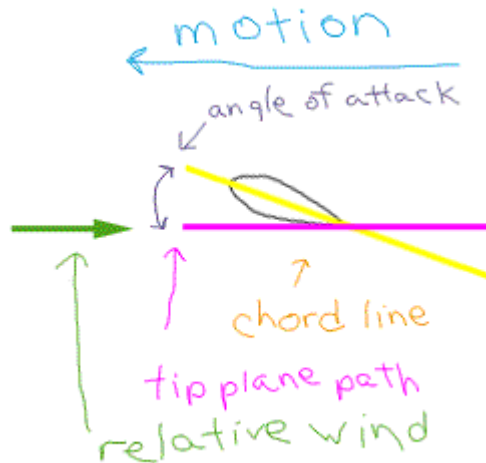

This is sort of a complex diagram, but let's take it part by part. The blue line shows the motion of the rotor blade, moving forward due to rotation. The green line shows the relative wind. Since there is only a horizontal component to motion right now, the green line is horizontal. The pink line labeled tip plane path shows the orientation of the rotor disk. It's just another line showing the horizontal motion of the rotor blade. The yellow line which is labeled chord line can just be thought of the direction the airfoil is facing (but not necessarily moving). In the case of this diagram, this would all be consistent with a helicopter at hover: the chord line is tilted because the pilot has raised the *collective* control, thereby tilting the blade up from the horizontal. Angle of attack is defined as the angle between the relative wind and the chord line. That is shown by the purple line.

In the next figure, we've added some vertical motion to the rotor blade:

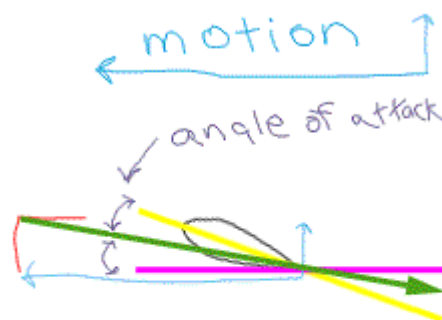

The way I've drawn this is on top to show the two components of motion of the rotor blade. Note that the blade is flapping *up*. I've copied the blue lines of motion down by the airfoil, and used the

red lines to show where we would extend the blue lines to. Then I drew the green relative wind line from this point back to the origin. There are a few interesting things to notice now.

First of all, remember that the relative wind is equal and opposite to the direction the object is going, so the green relative wind line also gives us an idea of the path of the blade. Clearly it is moving forward and **up**. The important thing to notice, however, is that the angle between the relative wind and the chord line is now cut about in half. In this case, the lift would also be cut in half. If this is not clear to you, lets see the same diagram, but rotated so that the relative wind is horizontal to us:

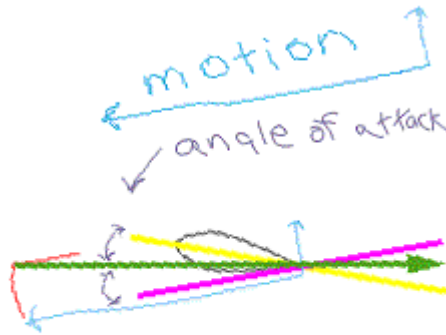

It should be clear that the angle of attack in this picture is much smaller than the diagram without flapping.

One final key to all this is, what makes the blade flap up? The answer is very simple: it's the excess lift. Remember that at a hover, the blade angle is where the forces of lift and centrifugal force balance out. If we increase the lift (because of the excess airspeed on the advancing blade) and the centrifugal force stays the same, the extra lift will cause the blade to flap up to a higher position until lift and centrifugal forces are once again in balance.

Gyroscopic precession

Gyroscopic precession is a phenomenon occurring in rotating bodies in which an applied force is manifested 90 degrees later in the direction of rotation from where the force was applied. Although precession is not a dominant force in rotary-wing aerodynamics, it must be reckoned with because turning rotor systems exhibit some of the characteristics of a gyro. This diagram shows how precession affects the rotor disk when force is applied at a given point:

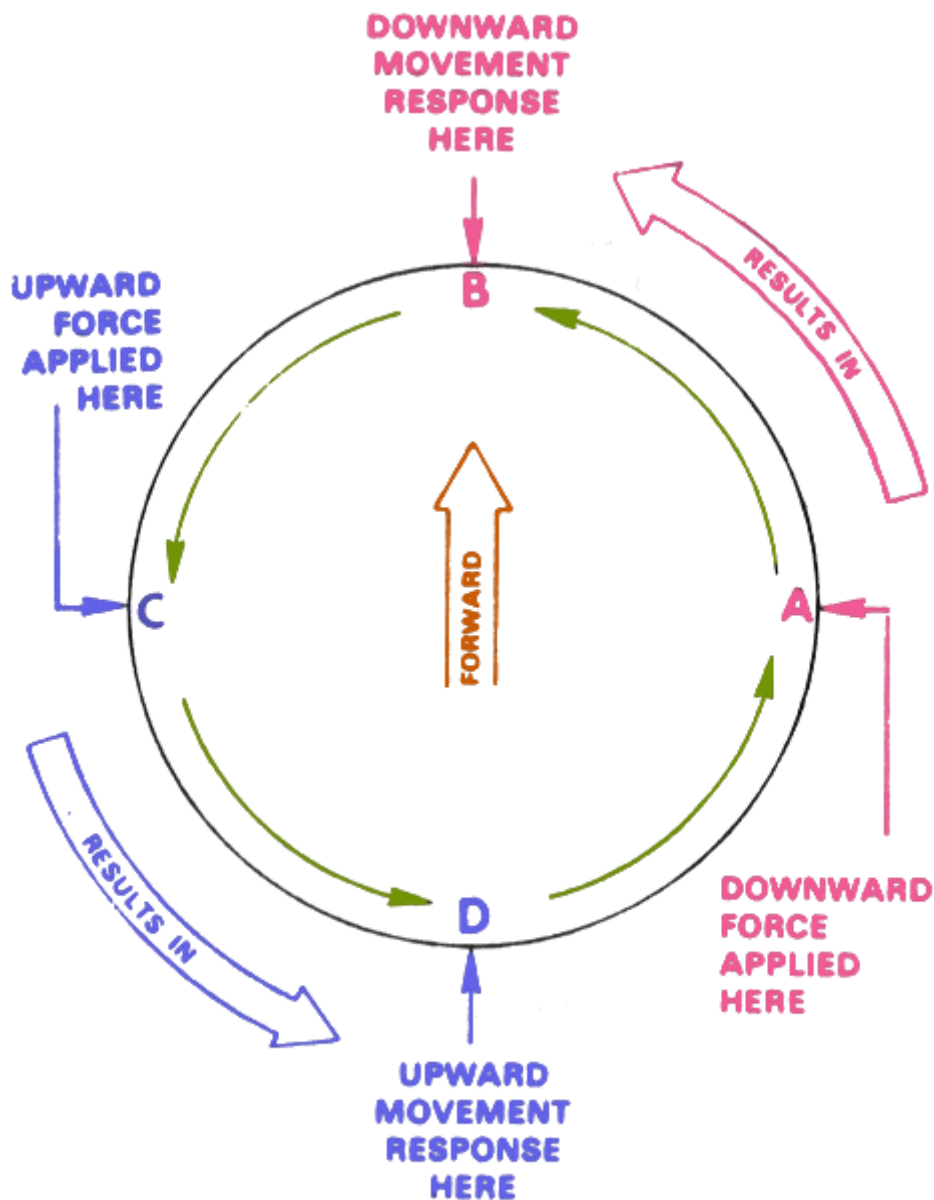

FIGURE 2-55. GYROSCOPIC PRECESSION.

A downward force applied to the disk at point A results in a downward change in disk attitude at point B. And upward force applied at Point C results in an upward change in disk attitude at point D.

Forces applied to a spinning rotor disk by control input or by wind gusts will react as follows:

"table at bottom of page 2-44"

This behavior explains some of the fundamental effects occurring during various helicopter maneuvers. For example, the helicopter behaves differently when rolling into a right turn than when rolling into a left turn. During roll into a left turn, the pilot will have to correct for a nose down tendency in order to maintain altitude. This correction is required because precession causes a nose down tendency and because the tilted disk produces less vertical lift to counteract gravity. Conversely, during a roll into a right turn, precession will cause a nose up tendency while the tilted disk will produce less vertical lift. Pilot input required to maintain altitude is significantly different during a right turn than during a left turn, because gyroscopic precession acts in opposite directions for each.



Retreating Blade Stall

A tendency for the retreating blade to stall in forward flight is inherent in all present day helicopters and is a major factor in limiting their forward speed. Just as the stall of an airplane wing limits the low speed possibilities of the airplane, the stall of a rotor blade limits the high speed potential of a helicopter. The airspeed of the retreating blade (the blade moving away from the direction of flight) slows down as forward speed increases. The retreating blade must, however, produce an amount of lift equal to that of the advancing blade. Therefore, as the airspeed of the retreating blade decreases with forward aircraft speed, the blade angle of attack must be increased to equalize lift throughout the rotor disk area. As this angle increase is continued, the blade will stall at some high forward speed.

As forward airspeed increases, the "no lift" areas move left of center, covering more of the retreating blade sectors:

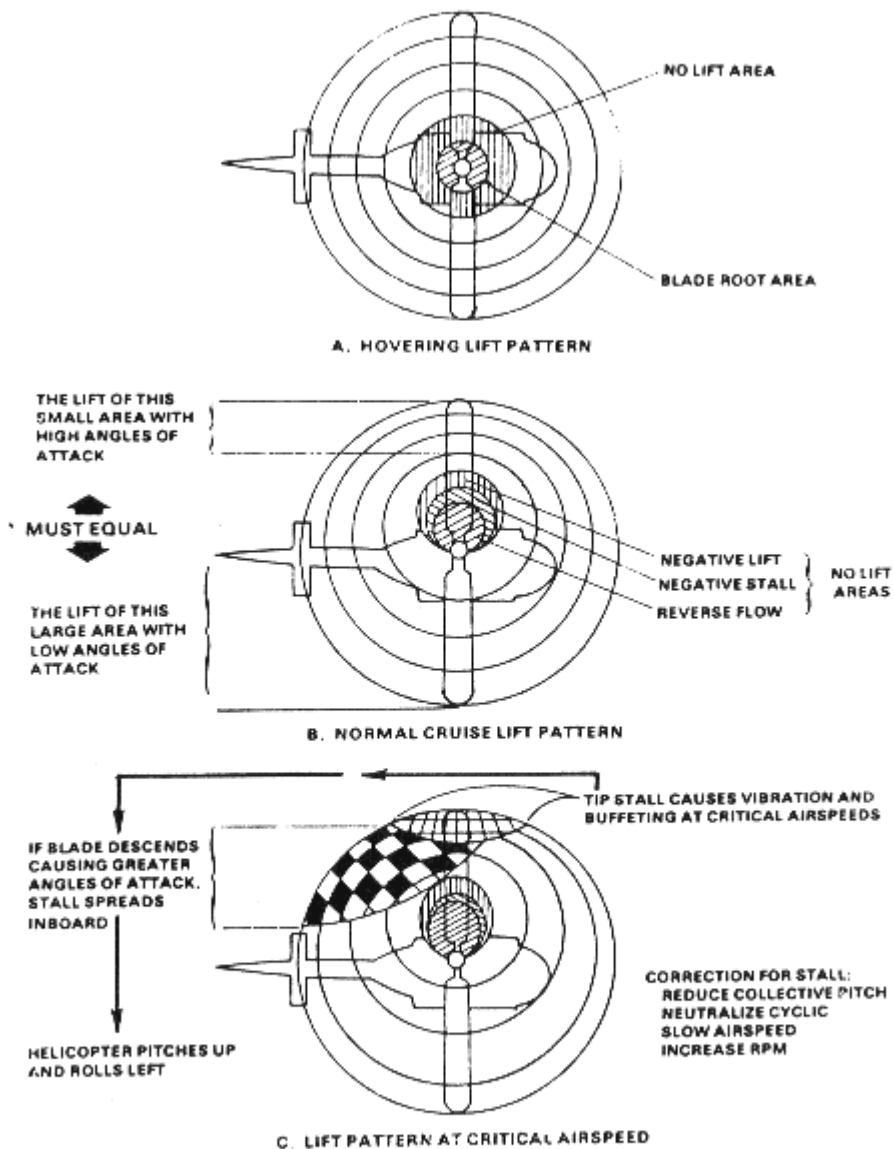

FIGURE 2-63. RETREATING BLADE STALL.

This requires more lift at the outer retreating blade portions to compensate for the loss of lift of the inboard retreating sections. In the area of reversed flow, the rotational velocity of this blade section is slower than the aircraft airspeed; therefore, the air flows from the trailing to leading edge of the airfoil. In the negative stall area, the rotational velocity of the airfoil is faster than the aircraft airspeed, therefore air flows from leading to trailing edge of the blade. However due to the relative arm and induced flow, blade flapping is not sufficient to produce a positive angle of attack. Blade flapping and rotational velocity in the negative lift area are sufficient to produce a positive angle of attack, but not to a degree that produces appreciable lift.

This figure shows a rotor disk that has reached a stall condition on the retreating side:

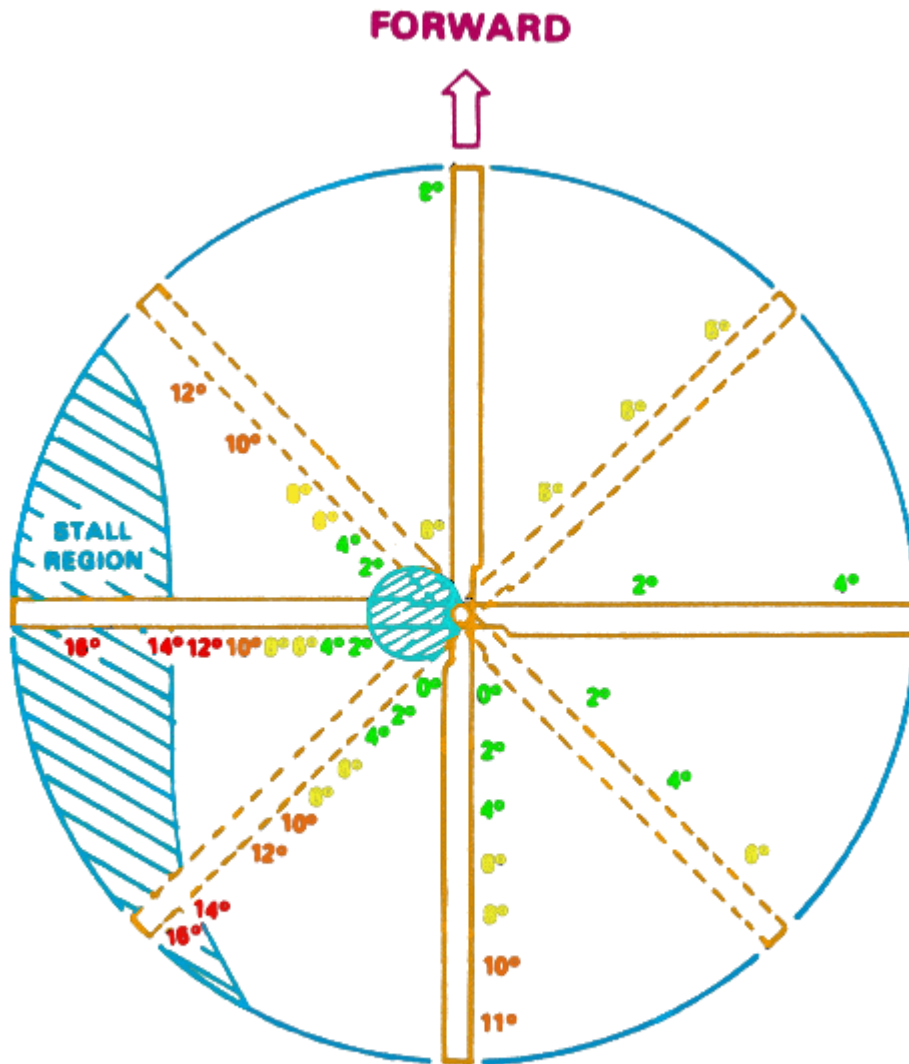

FIGURE 2-64. ANGLE OF ATTACK DISTRIBUTION DURING RETREATING BLADE STALL.

It is assumed that the stall angle of attack for this rotor system is 14 degrees. Distribution of angle of attack along the blade is shown at eight positions in the rotor disk. Although the blades are twisted and have less pitch at the tip than at the root, angle of attack is higher at the tip because of induced airflow.

Upon entry into blade stall, the first effect is generally a noticeable vibration of the helicopter. This is followed by a rolling tendency and a tendency for the nose to pitch up. The tendency to pitch up may be relatively insignificant for helicopters with semirigid rotor systems due to pendular action. If the cyclic stick is held forward and collective pitch is not reduced or is increased, this condition becomes aggravated; the vibration greatly increases, and control may be lost. By being familiar with the conditions which lead to blade stall, the pilot should realize when his is flying under such circumstances and should take corrective action.

The major warnings of approaching retreating blade stall conditions are:

- Abnormal vibration
- Pitchup of the nose
- Tendency for the helicopter to roll in the direction of the stalled side.

When operating at high forward airspeeds, the following conditions are most likely to produce blade stall:

- High blade loading (high gross weight)
- Low rotor RPM
- High density altitude
- Steep or abrupt turns
- Turbulent air

When flight conditions are such that blade stall is likely, extreme caution should be exercised when maneuvering. An abrupt maneuver such as a steep turn or pullup may result in dangerously severe blade stall. Aircraft control and structural limitations of the helicopter would be threatened.

Blade stall normally occurs when airspeed is high. To prevent blade stall, the pilot must fly slower than normal when:

- The density altitude is much higher than standard
- Carrying maximum weight loads
- Flying high drag configurations such as floats, external stores, weapons, speakers, floodlights, sling loads, etc.
- The air is turbulent

When the pilot suspects blade stall, he can possibly prevent it from occurring by sequentially:

- Reducing power (collective pitch)
- Reducing airspeed
- Reducing "G" loads during maneuvering
- Increasing RPM to upper allowable limit
- Checking pedal trim

In severe blade stall, the pilot loses control. The helicopter will pitch up violently and roll to the left. The only corrective action then is to accomplish procedures as indicated previously to shorten the duration of the stall and regain control.

Settling with Power

Settling with Power is a condition of powered flight where the helicopter settles into its own downwash. The condition may also be referred to as the *vortex ring state*.

Conditions conducive to settling with power are a vertical or nearly vertical descent of at least 300 feet per minute and low forward airspeed. The rotor system must also be using some of the available engine power (from 20 to 100 percent) with insufficient power available to retard the sink rate. These conditions occur during approaches with a tailwind or during formation approaches when some aircraft are flying in turbulence from other aircraft.

Under the conditions described above, the helicopter may descend at a high rate which exceeds the normal downward induced flow rate of the inner blade sections. As a result, the airflow of the inner blade sections is upward relative to the disk. This produces a *secondary* vortex ring in addition to the normal tip vortex system. The secondary vortex ring is generated about the point on the blade where airflow changes from up to down. The result is an unsteady turbulent flow over a large area of the disk which causes loss of rotor efficiency even though power is still supplied from the engine.

This figure shows the induced flow along the blade span during normal hovering flight:

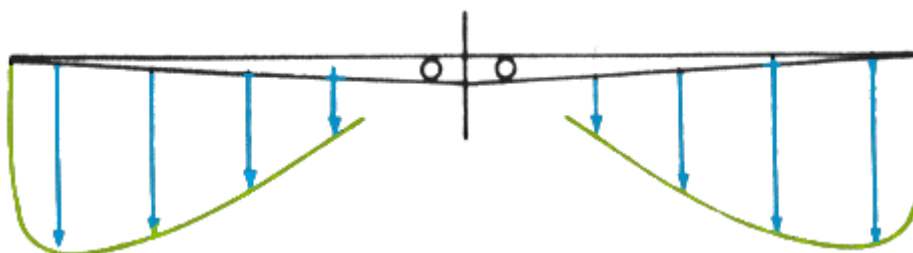

FIGURE 2-79. INDUCED FLOW VELOCITY DURING HOVERING FLIGHT.

Downward velocity is highest at the blade tip where blade airspeed is highest. As blade airspeed decreases nearer the disk center, downward velocity is less. This figure shows the induced airflow velocity pattern along the blade span during a descent conducive to settling with power:

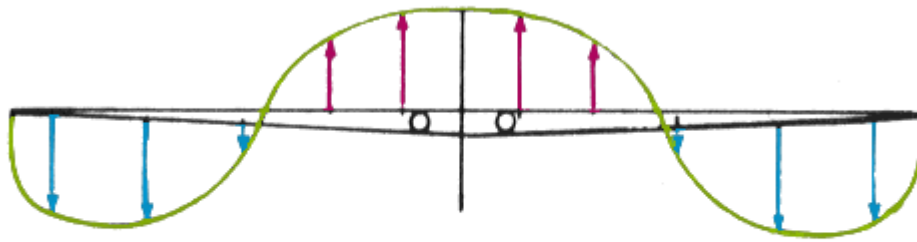

FIGURE 2-80. INDUCED FLOW VELOCITY DURING VORTEX RING STATE.

The descent is so rapid that induced flow at the inner portion of the blades is upward rather than downward. The upflow caused by the descent has overcome the downflow produced by blade rotation. If the helicopter descends under these conditions, with insufficient power to slow or stop the descent, it will enter the vortex ring state:

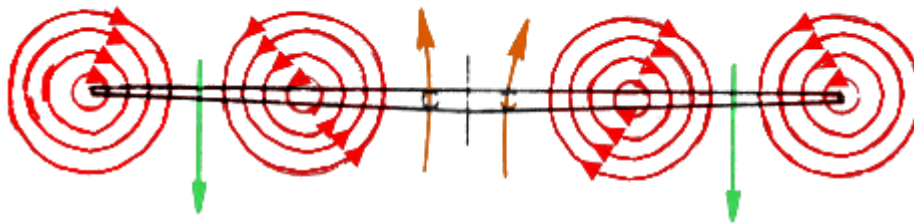

FIGURE 2-81. VORTEX RING STATE.

During the vortex ring state, roughness and loss of control is experienced because of the turbulent rotational flow on the blades and the unsteady shifting of the flow along the blade span.

This figure shows the relationship of horizontal speed versus vertical speed for a typical helicopter in a descent. Straight lines emanating from the upper left corner are lines of constant descent angle. Superimposed on this grid are flow state regions for the typical helicopter. From this illustration, several conclusions regarding the vortex ring state can be drawn:

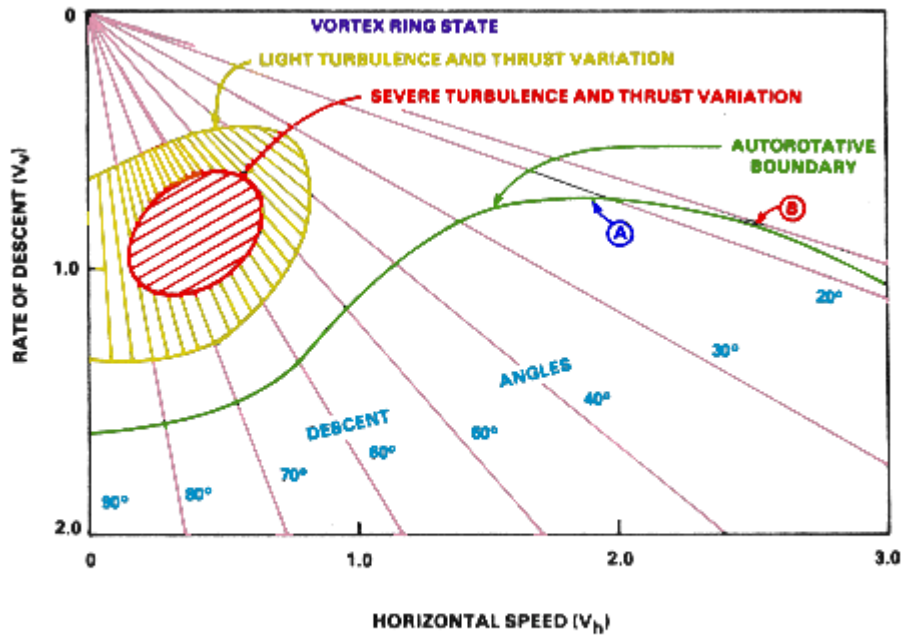

FIGURE 2-82. FLOW STATES IN DESCENDING FORWARD FLIGHT.

- The vortex ring state can be completely avoided by descending on flightpaths shallower than about 30 degrees (at any speed).
- For steeper approaches, vortex ring state can be avoided by using a speed either faster or slower than the area of severe turbulence and thrust variation.
- At very shallow angles of descent, the vortex ring wake is shed behind the helicopter.
- At steep angles, the vortex ring wake is below the helicopter at slow rates of descent and above the helicopter at high rates of descent.

Power settling is an unstable condition. If allowed to continue, the sink rate will reach sufficient proportions for the flow to be entirely up through the rotor system. If continued, the rate of descent will reach extremely high rates. Recovery may be initiated during the early stages of power settling by putting on a large amount of excess power. During the early stages of power settling, the large amount of excess power may be sufficient to overcome the upflow near the center of the rotor. If the sink rate reaches a higher rate, power will not be available to break this upflow, and thus alter the vortex ring state of flow.

Normal tendency is for pilots to recover from a descent by application of collective pitch and power. If insufficient power is available for recovery, this action may aggravate power settling resulting in more turbulence and a higher rate of descent. Recovery can be accomplished by lowering collective pitch and increasing forward speed. Both of these methods of recovery require altitude to be successful.

Aerodynamics of Autorotation

During powered flight, the rotor drag is overcome with engine power. When the engine fails, or is deliberately disengaged from the rotor system, some other force must be used to sustain rotor RPM so controlled flight can be continued to the ground. This force is generated by adjusting the collective pitch to allow a controlled descent. Airflow during helicopter descent provides the energy to overcome blade drag and turn the rotor. When the helicopter is descending in this manner, it is said to be in a state of *autorotation*. In effect the pilot gives up altitude at a controlled rate in return for energy to turn the rotor at an RPM which provides aircraft control. Stated another way, the helicopter has potential energy by virtue of its altitude. As altitude decreases, potential energy is converted to kinetic energy and stored in the turning rotor. The pilot uses this kinetic energy to cushion the touchdown when near the ground.

Most autorotations are performed with forward airspeed. For simplicity, the following aerodynamic explanation is based on a vertical autorotative descent (no forward airspeed) in still air. Under these conditions, the forces that cause the blades to turn are similar for all blades regardless of their position in the plane of rotation. Dissymmetry of lift resulting from helicopter airspeed is therefore not a factor, but will be discussed later.

During vertical autorotation, the rotor disk is divided into three regions:

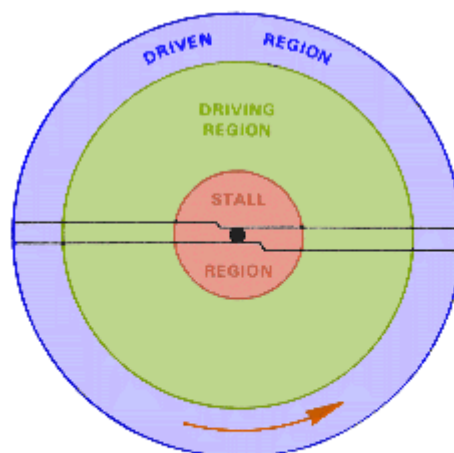

FIGURE 2-84. BLADE REGIONS IN VERTICAL AUTOROTATION DESCENT.

- The *driven region*, also called the *propeller region*, is nearest to the blade tips and normally consists of about 30 percent of the radius. The total aerodynamic force in this region is inclined slightly behind the rotating axis. This results in a drag force which tends to slow the rotation of the blade.
- The *driving region* or *autorotative region*, normally lies between about 25 to 70 percent of the blade radius. Total aerodynamic force in this region is inclined slightly forward of the axis of rotation. This inclination supplies thrust which tends to accelerate the rotation of the blade.
- The *stall region* includes the inboard 25 percent of the blade radius. It operates above the stall angle of attack and causes drag which tends to slow the rotation of the blade.

The following figure shows three blade sections that illustrate force vectors in the driven region "A", a region of equilibrium "B" and the driving region "C":

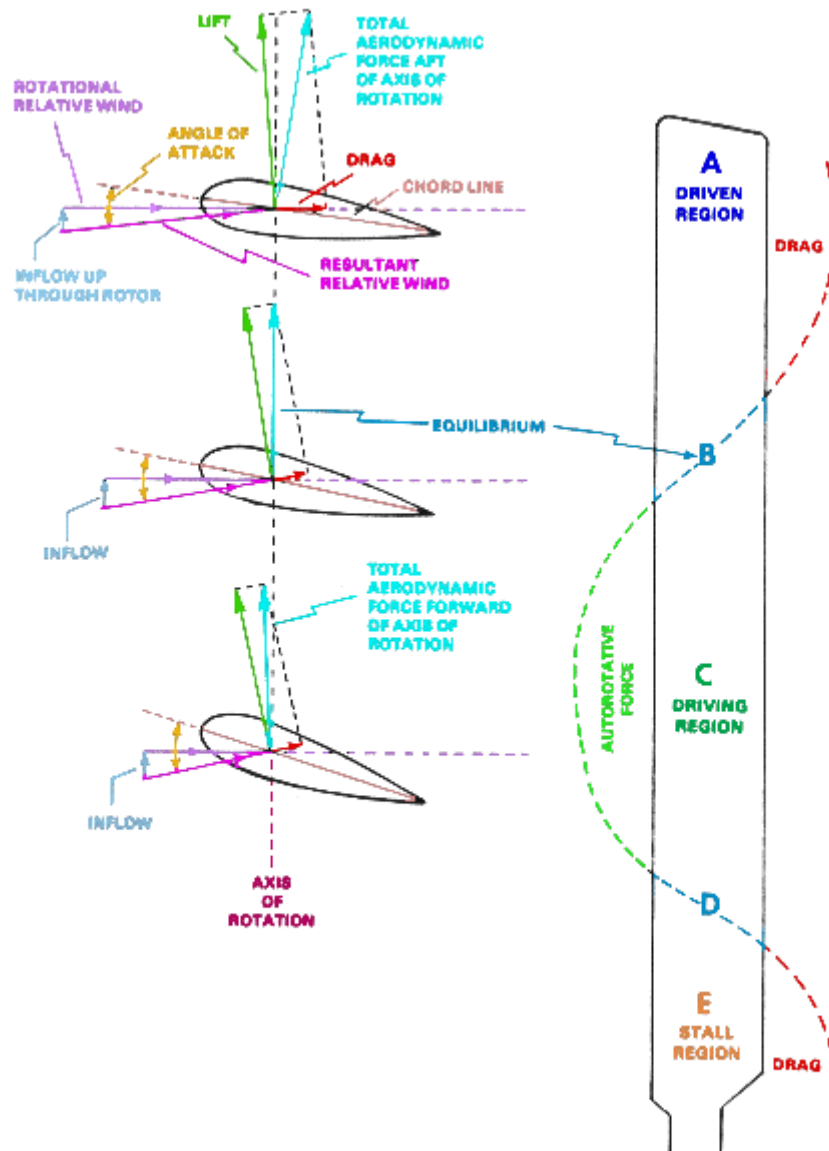

FIGURE 2-85. FORCE VECTORS IN VERTICAL AUTOROTATIVE DESCENT.

The force vectors are different in each region, because the rotational relative wind is slower near the blade root and increases continually toward the blade tip. When the inflow up through the rotor combines with rotational relative wind, it produces different combinations of aerodynamic force at every point along the blade.

In the driven region, the total aerodynamic force acts behind the axis of rotation, resulting in an overall dragging force. This area produces lift but it also opposes rotation and continually tends to decelerate the blade. The size of this region varies with blade pitch setting, rate of descent, and rotor RPM. When the pilot takes action to change autorotative RPM, blade pitch, or rate of descent, he is in effect changing the size of the driven region in relation to the other regions.

Between the driven region and the driving region is a point of equilibrium. At this point on the blade, total aerodynamic force is aligned with the axis of rotation. Lift and drag are produced, but the total effect produces neither acceleration nor deceleration of the rotor RPM. Point "D" is also an area of equilibrium in regard to thrust and drag.

Area "C" is the driving region of the blade and produces the forces needed to turn the blades during autorotation. Total aerodynamic force in the driving region is inclined forward of the axis of rotation and produces a continual acceleration force. Driving region size varies with blade pitch setting, rate of descent and rotor RPM. The pilot controls the size of this region in relation to the driven and stall regions in order to adjust autorotative RPM. For example, if the collective pitch stick is raised, the pitch angle will increase in all regions. This causes the point of equilibrium "B" to move toward the blade tip, decreasing the size of the driven region. The entire driving region also moves toward the blade tip. The stall region becomes larger and the total blade drag is increased, causing RPM decrease.

A constant rotor RPM is achieved by adjusting the collective pitch control so blade acceleration forces from the driving region are balanced with the deceleration forces from the driven and stall regions.

Aerodynamics of autorotation in forward flight

Autorotative force in forward flight is produced in exactly the same manner as when the helicopter is descending vertically in still air. However, because forward speed changes the inflow of air up through the rotor disk, the driving region and stall region move toward the retreating side of the disk where angle of attack is larger:



FIGURE 2-86. AUTOROTATIVE REGIONS IN FORWARD FLIGHT.

Because of lower angles of attack on the advancing side blade, more of that blade falls into the driven region. On the retreating side blade, more of the blade is in the stall region, and a small section near the root experiences a reversed flow. The size of the driven region on the retreating side is reduced.

Autorotations may be divided into three distinct phases; the *entry*, the *steady state descent*, and the *deceleration and touchdown*. Each of these phases is aerodynamically different than the others. The following discussion describes forces pertinent to each phase.

Entry into autorotation is performed following loss of engine power. Immediate indications of power loss are rotor RPM decay and an out-of-trim condition. Rate of RPM decay is most rapid when the helicopter is at high collective pitch settings. In most helicopters it takes only seconds for the RPM decay to reach a minimum safe range. Pilots must react quickly and initiate a reduction in collective pitch that will prevent excessive RPM decay. A cyclic flare will help prevent excessive decay if the failure occurs at high speed. This technique varies with the model helicopter. Pilots should consult and follow the appropriate aircraft Operator's Manual.

The following figure shows the airflow and force vectors for a blade in powered flight at high speed:

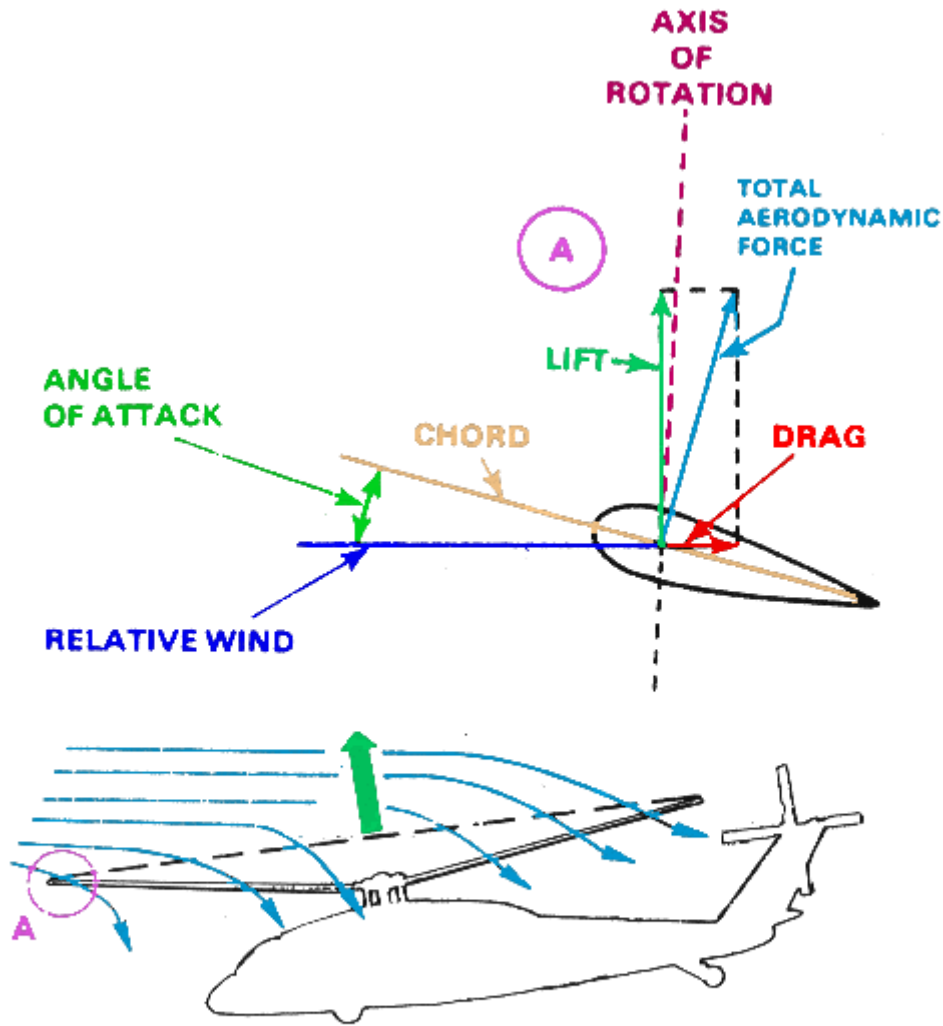

FIGURE 2-87. FORCE VECTORS IN LEVEL POWERED FLIGHT AT HIGH SPEED.

Note that the lift and drag vectors are large and the total aerodynamic force is inclined well to the rear of the axis of rotation. If the engine stops when the helicopter is in this condition, rotor RPM decay is rapid. To prevent RPM decay, the pilot must promptly lower the collective pitch control to reduce drag and incline the total aerodynamic force vector forward so it is near the axis of rotation.

The following figure shows the airflow and force vectors for a helicopter just after power loss:

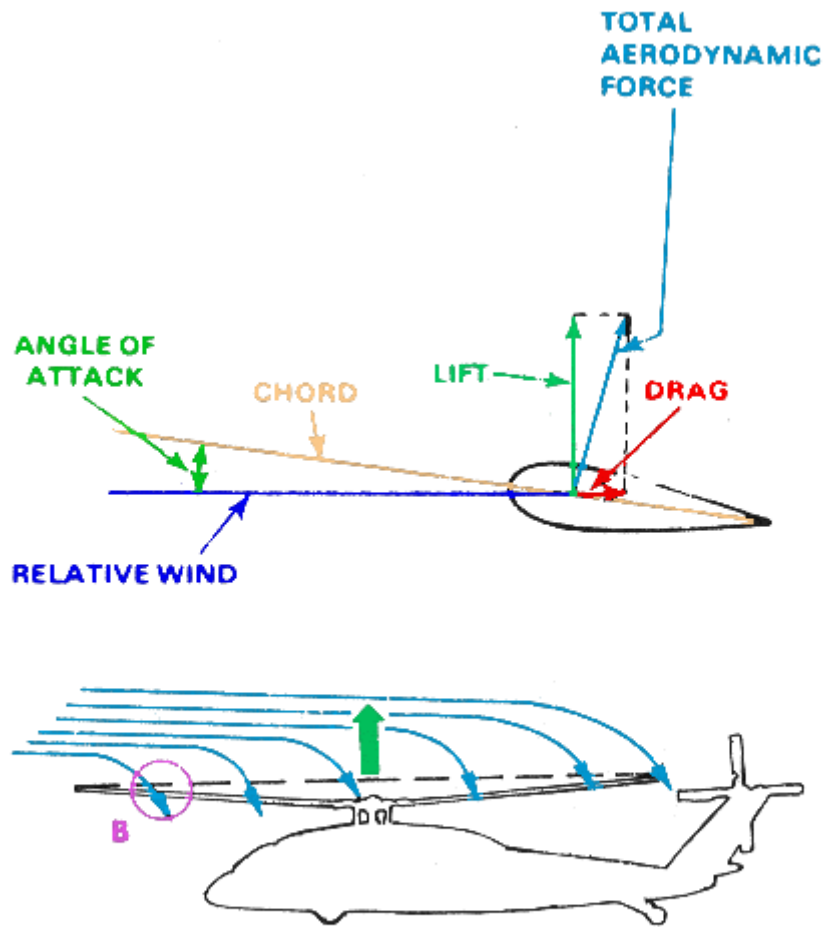

FIGURE 2-88. FORCE VECTORS AFTER POWER LOSS WITH REDUCED COLLECTIVE.

The collective pitch has been reduced, but the helicopter has not started to descend. Note that lift and drag are reduced and the total aerodynamic force vector is inclined further forward than it was in powered flight. As the helicopter begins to descend, the airflow changes. This causes the total aerodynamic force to incline further forward. It will reach an equilibrium that maintains a safe operating RPM. The pilot establishes a glide at the proper airspeed which is 50 to 75 knots, depending on the helicopter and its gross weight. Rotor RPM should be stabilized at autorotative RPM which is normally a few turns higher than normal operating RPM.

The following figure shows the helicopter in a *steady state descent*:

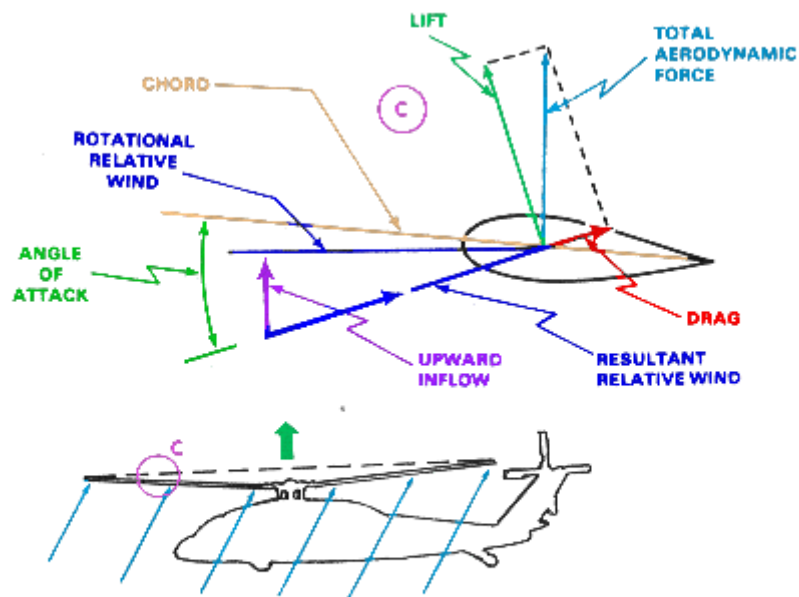

FIGURE 2-89. FORCE VECTORS IN AUTOROTATION STEADY STATE DESCENT.

Airflow is now upward through the rotor disk due the descent. Changed airflow creates a larger angle of attack although blade pitch angle is the same as it was in the previous picture, before the descent began. Total aerodynamic force is increased and inclined forward so equilibrium is established. Rate of descent and RPM are stabilized, and the helicopter is descending at a constant angle. Angle of descent is normally 17 degrees to 20 degrees, depending on airspeed, density altitude, wind, the particular helicopter design, and other variables.

The following figure illustrates the aerodynamics of autorotative *deceleration*:

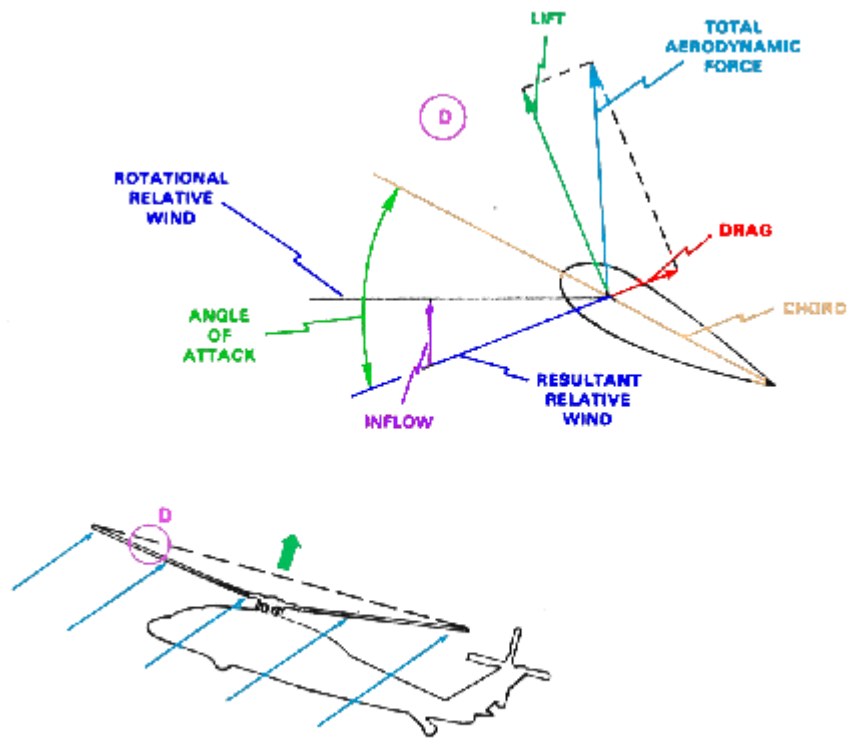

FIGURE 2-90. AUTOROTATIVE DECELERATION.

To successfully perform an autorotative landing, the pilot must reduce airspeed and rate of descent just before touchdown. Both of these actions can be partially accomplished by moving the cyclic control to the rear and changing the attitude of the rotor disk with relation to the relative wind. The attitude change inclines the total force of the rotor disk to the rear and slows forward speed. It also increases angle of attack on all blades by changing the inflow of air. As a result, total rotor lifting force is increased and rate of descent is reduced. RPM also increases when the total aerodynamic force vector is lengthened, thereby increasing blade kinetic energy available to cushion the touchdown. After forward speed is reduced to a safe landing speed, the helicopter is placed in a landing attitude as collective pitch is applied to cushion the touchdown.

Future Development

